

# **YAMAHA**

# **Digital Piano**

# **YDP-88II**

**Owner's Manual**

## **IMPORTANT**

### **Check Your Power Supply**

Make sure that your local AC mains voltage matches the voltage specified on the name plate on the bottom panel. In some areas a voltage selector may be provided on the rear panel of the main keyboard unit near the power cord. Make sure that the voltage selector is set for the voltage in your area. The voltage selector is set at 240V when the unit is initially shipped. To change the setting use a "minus" screwdriver to rotate the selector dial so that the correct voltage appears next to the pointer on the panel.

# PRECAUTIONS

## PLEASE READ CAREFULLY BEFORE PROCEEDING

\* Please keep these precautions in a safe place for future reference.



### WARNING

**Always follow the basic precautions listed below to avoid the possibility of serious injury or even death from electrical shock, short-circuiting, damages, fire or other hazards. These precautions include, but are not limited to, the following:**

- Do not open the instrument or attempt to disassemble the internal parts or modify them in any way. The instrument contains no user-serviceable parts. If it should appear to be malfunctioning, discontinue use immediately and have it inspected by qualified Yamaha service personnel.
- Do not expose the instrument to rain, use it near water or in damp or wet conditions, or place containers on it containing liquids which might spill into any openings.
- If the power cord or plug becomes frayed or damaged, or if there is a sudden loss of sound during use of the instrument, or if any unusual smells or smoke should appear to be caused by it, immediately turn off the power switch, disconnect the electric plug from the outlet, and have the instrument inspected by qualified Yamaha service personnel.
- Only use the voltage specified as correct for the instrument. The required voltage is printed on the name plate of the instrument.
- Before cleaning the instrument, always remove the electric plug from the outlet. Never insert or remove an electric plug with wet hands.
- Check the electric plug periodically and remove any dirt or dust which may have accumulated on it.



### CAUTION

**Always follow the basic precautions listed below to avoid the possibility of physical injury to you or others, or damage to the instrument or other property. These precautions include, but are not limited to, the following:**

- Do not place the power cord near heat sources such as heaters or radiators, and do not excessively bend or otherwise damage the cord, place heavy objects on it, or place it in a position where anyone could walk on, trip over, or roll anything over it.
- When removing the electric plug from an outlet, always hold the plug itself and not the cord. Pulling by the cord can damage it.
- Do not connect the instrument to an electrical outlet using a multiple-connector. Doing so can result in lower sound quality, or possibly cause overheating in the outlet.
- Remove the electric plug from the outlet when the instrument is not to be used for extended periods of time, or during electrical storms.
- Before connecting the instrument to other electronic components, turn off the power for all components. Before turning the power on or off for all components, set all volume levels to minimum.
- Do not expose the instrument to excessive dust or vibrations, or extreme cold or heat (such as in direct sunlight, near a heater, or in a car during the day) to prevent the possibility of panel disfiguration or damage to the internal components.
- Do not use the instrument near other electrical products such as televisions, radios, or speakers, since this might cause interference which can affect proper operation of the other products.
- Do not place the instrument in an unstable position where it might accidentally fall over.
- Before moving the instrument, remove all connected cables.
- When cleaning the instrument, use a soft, dry cloth. Do not use paint thinners, solvents, cleaning fluids, or chemical-impregnated wiping cloths. Also, do not place vinyl or plastic objects on the instrument, since this might discolor the panel or keyboard.
- Do not rest your weight on, or place heavy objects on the instrument, and do not use excessive force on the buttons, switches or connectors.
- Take care that the key cover does not pinch your fingers, and do not insert a finger or hand in the key cover gap.
- Never insert or drop paper or metallic or other objects between the slits of the key cover and the keyboard. If this happens, immediately turn off the power and remove the electric plug from the outlet and have the instrument inspected by qualified Yamaha service personnel.
- Do not place the instrument against a wall (allow at least 3 cm/one-inch from the wall), since this can cause inadequate air circulation, and possibly result in the instrument overheating.
- Read carefully the attached documentation explaining the assembly process. Failure to assemble the instrument in the proper sequence might result in damage to the instrument or even injury.
- Do not operate the instrument for a long period of time at a high or uncomfortable volume level, since this can cause permanent hearing loss. If you experience any hearing loss or ringing in the ears, consult a physician.

#### ■ USING THE BENCH (if included)

- Do not play carelessly with or stand on the bench. Using it as a tool or step-ladder or for any other purpose might result in accident or injury.
- Only one person should sit on the bench at a time, in order to prevent the possibility of accident or injury.
- If the bench screws become loose due to extensive long-term use, tighten them periodically using the included tool.

#### ■ SAVING USER DATA

- Save all data to an external device such as the Yamaha DOU-10 Disk Orchestra Unit, in order to help prevent the loss of important data due to a malfunction or user operating error.

Yamaha cannot be held responsible for damage caused by improper use or modifications to the instrument, or data that is lost or destroyed.

Always turn the power off when the instrument is not in use.

# Introduction

Thank you for choosing a Yamaha YDP-88II Digital Piano. Your YDP-88II is a fine musical instrument that employs advanced Yamaha music technology. With the proper care, your YDP-88II will give you many years of musical pleasure.

- Yamaha's AWM (Advanced Wave Memory) tone generator system offers rich, realistic voices.
- Touch-sensitive keys provides extensive expressive control and outstanding playability.
- Dual play mode allows 2 voices to be played simultaneously.
- Metronome feature with variable tempo facilitates practice.
- Record and play back anything you play on the keyboard (up to approximately 1,300 notes).
- MIDI compatibility and a range of MIDI functions make the YDP-88II useful in a range of advanced MIDI music systems.

In order to make the most of your YDP-88II's performance potential and features, we urge you to read this Owner's Manual thoroughly, and keep it in a safe place for later reference.

## Contents

<b>The Control Panel</b> .....	2	<b>■ Playback</b> .....	12
<b>Connections</b> .....	4	● Fast Forward Playback .....	12
<b>Selecting &amp; Playing Voices</b> .....	5	<b>MIDI Functions</b> .....	13
<b>Playing the Demonstration Tunes</b> .....	6	● A Brief Introduction to MIDI .....	13
<b>The Dual Mode</b> .....	7	● MIDI "Messages" Transmitted & Received by the YDP-88II .....	13
● Adjusting the Balance Between the Dual-mode Voices .....	7	● MIDI Transmit & Receive Channel Selection ..	14
● Shifting a Dual-Mode Voice Up One Octave ....	7	● MIDI Transmit Transpose .....	14
<b>The Pedals</b> .....	8	<b>■ Other MIDI Functions</b> .....	14
● Soft (Left) Pedal .....	8	● Local Control ON/OFF .....	15
● Sostenuto (Center) Pedal .....	8	● Program Change ON/OFF .....	15
● Damper (Right) Pedal .....	8	● Control Change ON/OFF .....	15
<b>Transposition</b> .....	8	● The Multi-Timbre Mode .....	16
<b>Pitch Control</b> .....	9	● The MIDI Split & Left Local OFF Mode .....	16
● Tuning Up .....	9	● Bulk Data Dump .....	16
● Tuning Down .....	9	<b>Troubleshooting</b> .....	17
● To Restore Standard Pitch .....	9	<b>Options &amp; Expander Modules</b> .....	17
<b>The Metronome &amp; Tempo Control</b> .....	10	<b>Keyboard Stand Assembly</b> .....	18
<b>■ The Metronome</b> .....	10	<b>MIDI Data Format</b> .....	24
● Metronome Volume .....	10	<b>MIDI Implementation Chart</b> .....	25
● Metronome Time Signature .....	10	<b>Specifications</b> .....	26
<b>■ Tempo Control</b> .....	10		
<b>Using the Recorder</b> .....	11		
<b>■ Recording</b> .....	11		
● Changing the Initial Settings .....	12		
● Erasing the recorded data .....	12		

The serial number of this product may be found on the bottom of the unit. You should note this serial number in the space provided below and retain this manual as a permanent record of your purchase to aid identification in the event of theft.

**Model No.**

\_\_\_\_\_

**Serial No.**

\_\_\_\_\_

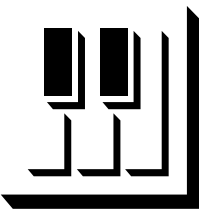

# The Control Panel

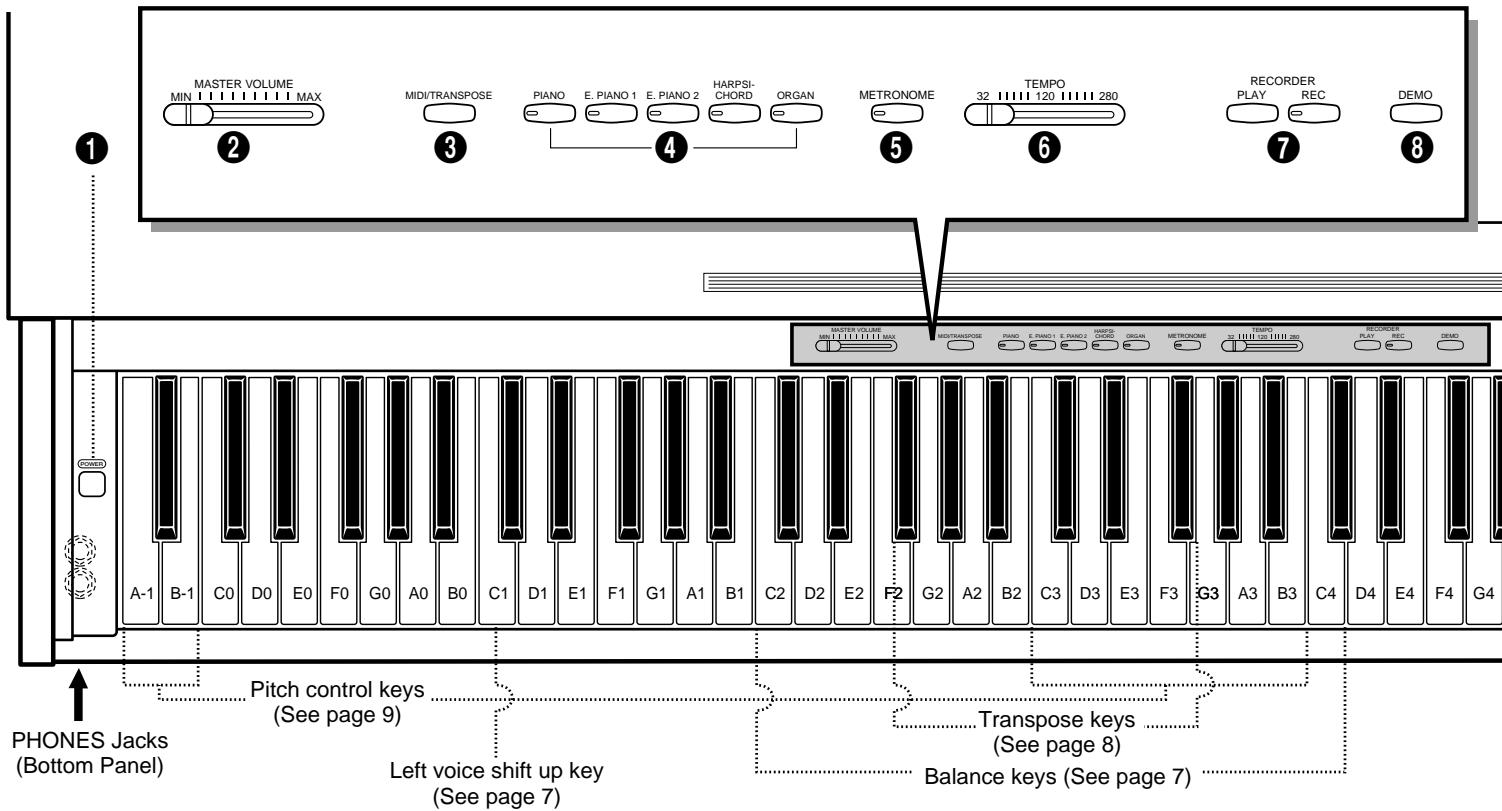

## 1 [POWER] Switch

Press the **[POWER]** switch once to turn the power ON, a second time to turn the power OFF. When the power is initially turned ON, the **[PIANO]** voice selector LED will light.

## 2 [MASTER VOLUME] Control

The **[MASTER VOLUME]** control adjusts the volume (level) of sound produced by the YDP-88II's internal stereo sound system. The **[MASTER VOLUME]** control also adjusts headphone volume when a pair of headphones is plugged into the PHONES jack (page 5).

## 3 [MIDI/TRANPOSE] Button

The **[MIDI/TRANPOSE]** button allows access to the YDP-88II's TRANSPOSE function (to shift the pitch of the entire keyboard up or down) and MIDI functions. For details refer to "TRANSPOSITION" on page 8, and "MIDI FUNCTIONS" on page 13, respectively.

## 4 Voice Selectors

The YDP-88II has five voice selectors. Simply press any of the voice selectors to select the corresponding voice. The voice selector LED will light to indicate which voice is currently selected.

The YDP-88II also has a DUAL mode in which two voices can be played simultaneously across the full range of the keyboard — see page 7 for details.



• The **PIANO** voice is automatically selected whenever the **[POWER]** switch is initially turned ON.

## 5 [METRONOME] Button

Turns the metronome sound on and off. The **[TEMPO]** control, below, is used to set the tempo of the metronome sound. More precise tempo settings can be achieved by using the **[METRONOME]** button and the YDP-88II keyboard as described on page 10.

## 6 [TEMPO] Control

This control adjusts the tempo of the YDP-88II metronome function as well as the playback tempo of the recorder function. The tempo range is from 32 to 280 quarter-note beats per minute.

## 7 RECORDER [PLAY] and [REC] Buttons

These buttons control the YDP-88II recorder, letting you record and play back just about anything you play on the keyboard — up to a maximum of about 1,300 notes. See page 11 for details.

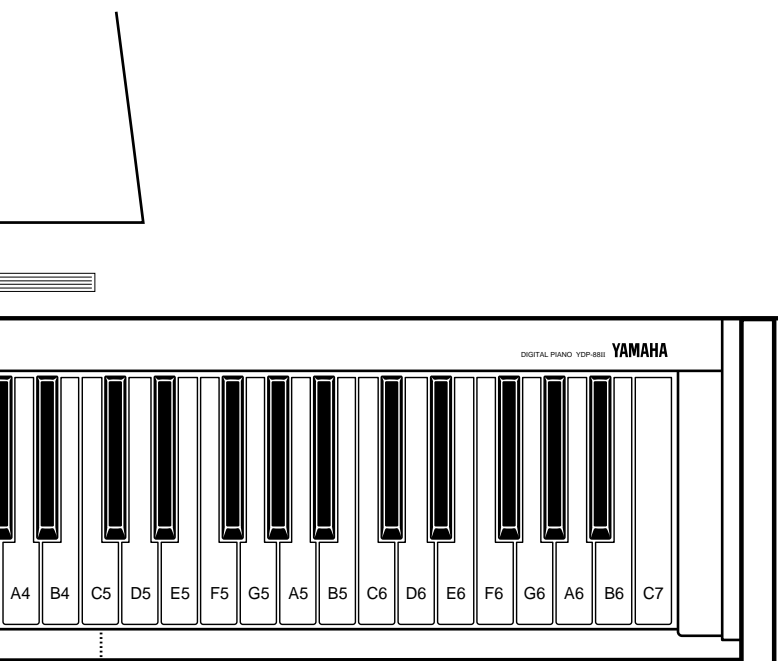

Right voice shift up key  
(See page 6)

## 8 [DEMO] Button

Activates the demo playback mode in which you can select playback of five pre-programmed demonstration sequences. See page 6 for details.

## 9 Pedals

The soft (left), sostenuto (center) and damper (right) pedals provide a range of expressive control capabilities similar to the pedal functions on an acoustic piano. See page 8 for details.

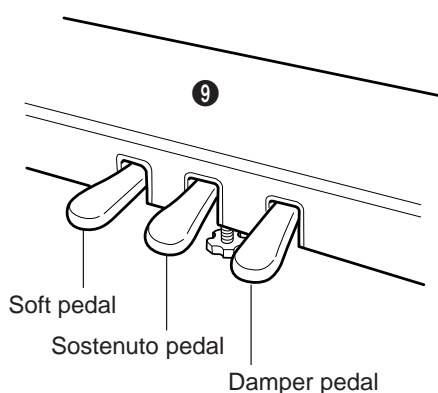

## ● Key Cover

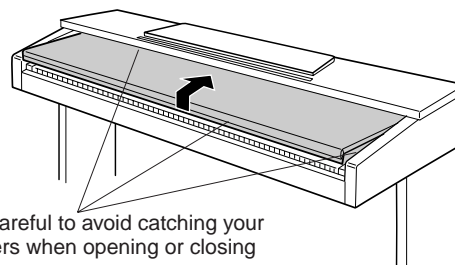

Be careful to avoid catching your fingers when opening or closing the cover.

## ■ To open the key cover:

- 1 Lift the cover slightly (not too much).
- 2 Slide the cover open.

## ■ To close the key cover:

- 1 Slide the cover toward you.
- 2 Gently lower the cover over the keys.

### ★ CAUTION

- Hold the cover with both hands when moving it, and do not release it until it is fully opened or closed. Be careful to avoid catching fingers (yours or others) between the cover and main unit.
- Do not place objects on top of the key cover. Small objects placed on the key cover may fall inside the main unit when the cover is opened and may not be able to be removed. This could cause electric shock, short circuit, fire or other serious damage to the instrument.

## ● The Music Stand

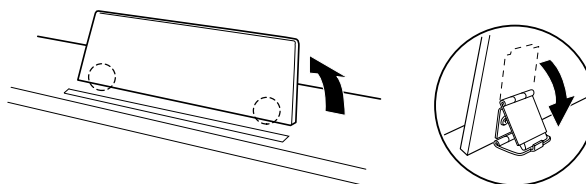

If you will be using sheet music with your YDP-88II, raise the music stand built into its top panel by lifting the rear edge of the music stand, then flip down the music stand braces and engage them with the corresponding recesses.

The music stand can be lowered after slightly lifting it and folding the two brackets which support it against the back of the stand.

### ★ CAUTION

- Do not try to use the music stand in a half-raised position. Also, when lowering the stand, make sure to press it until it is all the way down.

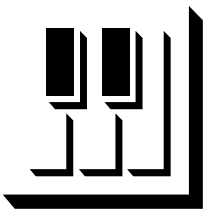

# Connections

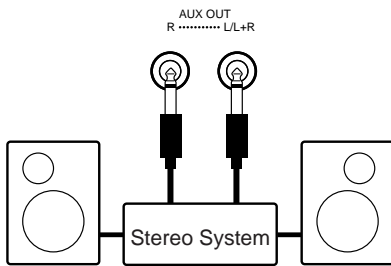
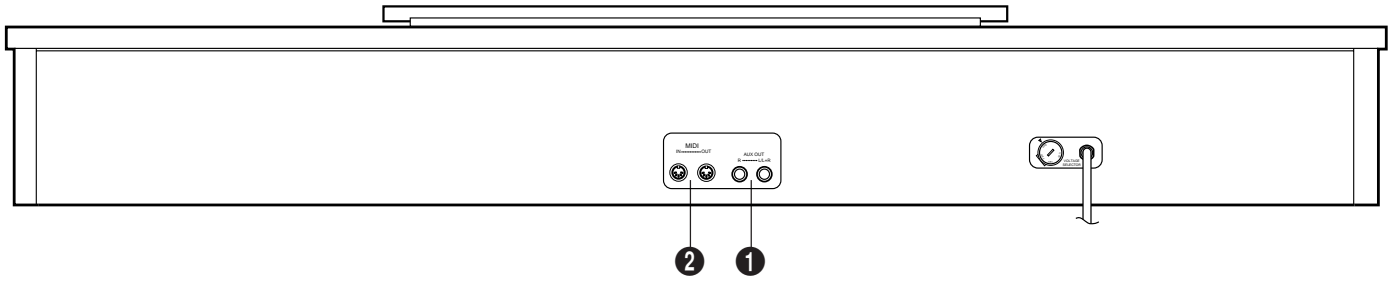

## 1 AUX OUT L/L+R and R Jacks

The AUX OUT L/L+R and R jacks deliver the output of the YDP-88II for connection to an instrument amplifier, mixing console, PA system, or recording equipment. If you will be connecting the YDP-88II to a monaural sound system, use only the L/L+R jack. When a plug is inserted into the L/L+R jack only, the left- and right-channel signals are combined and delivered via the L/L+R jack so you don't lose any of the YDP-88II's sound.

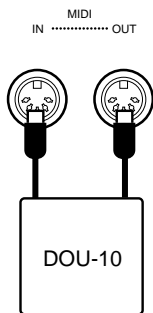

## 2 MIDI IN and OUT Connectors

The MIDI IN connector receives MIDI data from an external MIDI device (such as the DOU-10 Disk Orchestra Unit) which can be used to control the YDP-88II. The MIDI OUT connector transmits MIDI data generated by the YDP-88II (e.g. note and velocity data produced by playing the YDP-88II keyboard).

More details on MIDI are given in "MIDI FUNCTIONS" on page 13.

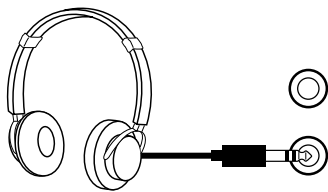

## ● PHONES Jacks (Bottom Panel)

Two pairs of standard pair of stereo headphones can be plugged in here for private practice or late-night playing. The internal speaker system is automatically shut off when a pair of headphones is plugged into either of the PHONES jacks.

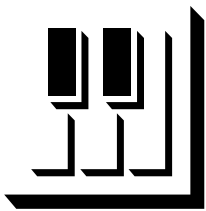

# Selecting & Playing Voices

## 1 Turn Power On .....

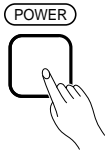

After making sure that the YDP-88II's AC cord is properly plugged into a convenient AC wall outlet, press the **[POWER]** switch located to the left of the keyboard to turn the power ON. In some areas a plug adaptor may be provided to match the pin configuration of the AC wall outlets in your area.

When the power is turned ON, the **[PIANO]** voice selector LED will light (the PIANO voice is automatically selected whenever the power is turned ON).

## 2 Set the Volume .....

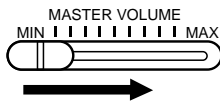

Initially set the **[MASTER VOLUME]** control about half way between the "MIN" and "MAX" settings. Then, when you start playing, re-adjust the **[MASTER VOLUME]** control for the most comfortable listening level.

## 3 Select a Voice .....

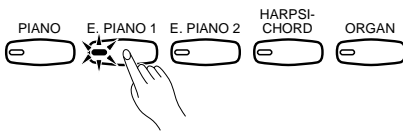

Select the desired voice by pressing one of the voice selectors.

## 4 Play .....

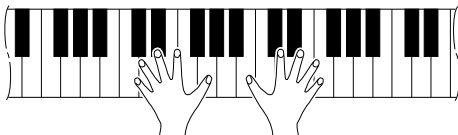

The YDP-88II offers keyboard touch response, so the volume and timbre of notes played can be controlled according to how "hard" you play the keys. The amount of variation available depends on the selected voice.

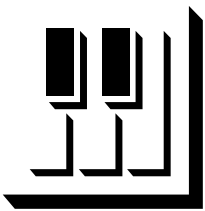

# Playing the Demonstration Tunes

The YDP-88II includes five demo tunes that effectively demonstrate its sound capabilities. Here's how you can select and play the demo tunes:

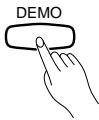

## 1 Engage the Demo Mode .....

Press the [DEMO] button to engage the demo mode — the voice selectors will flash in sequence.

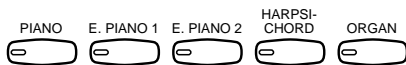

## 2 Select a Demo Tune .....

Press one of the flashing voice selectors to start playback of the corresponding demo tune — featuring the voice normally selected by that voice selector button. The demo tunes will play in sequence until stopped, starting with the selected tune. The voice selector indicator will flash during demo playback.

### ● The Demo Tunes

- [PIANO] button: ..... Piano Sonata A major K.V. 331 3rd movement  
"Turkischer Marsch" by W. A. Mozart
- [E. PIANO 1] button: ..... "Pavane pour une infante défunte" by M. J. Ravel
- [HARPSICHORD] button: ..... "The Harmonious Blacksmith" by G. F. Händel
- [ORGAN] button: ..... Wedding March from "A Midsummer Night Dream" by J. L. F. Mendelssohn

\* The demonstration pieces listed above are short excerpts from the original compositions. The other demo tune is original (© 1997 by YAMAHA CORPORATION).

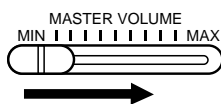

## 3 Set the Volume .....

Use the [MASTER VOLUME] control to adjust the volume.



• The [TEMPO] control does not affect demo playback.

## 4 Play a Different Demo .....

You can start playback of any other demo tune during playback by simply pressing the corresponding voice selector. Playback will stop and the playback-ready mode described in step 2, above, will be re-engaged if you press the voice selector of the demo that is currently playing.

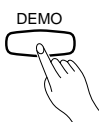

## 5 Stop the Demo .....

Press the [DEMO] button when you want to stop demo playback and return to the normal play mode.



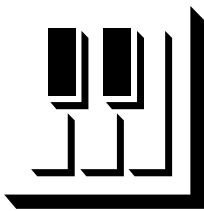

# The Dual Mode

The DUAL mode makes it possible to play two voices simultaneously across the entire range of the keyboard. To activate the DUAL mode simply press two voice selectors at the same time (or press one voice selector while holding another). The voice indicators of both selected voices will light when the DUAL mode is active. To return to the normal single-voice play mode, press any single voice selector.

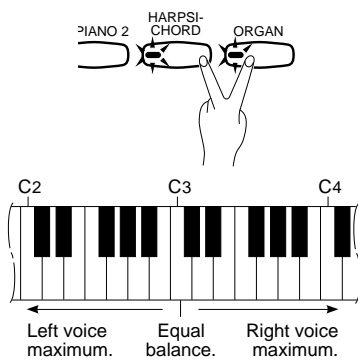

## Adjusting the Balance Between the Dual-mode Voices

The volume levels of the two voices combined in the DUAL mode are normally set automatically to produce a pleasing balance (see “Default Settings” below). The balance can be adjusted manually by using the **C2** through **C4** keys on the keyboard while pressing the two voice selectors corresponding to the voices to be combined in the DUAL mode.

The **C3** key produces equal (50:50) balance between the two voices, while keys to the left of **C3** increase the volume of the left voice in relation to the right voice, and keys to the right of **C3** increase the volume of the right voice in relation to the left voice. By “left” and “right” voice we refer to the relative positions of the voice selectors — i.e. in a HARPSICHORD/ORGAN combination HARPSICHORD is the left voice and ORGAN is the right voice.

### Default Settings

Voice Combinations	Balance keys
PIANO/ORGAN .....	E2
E. PIANO 1/ORGAN .....	F2
E. PIANO 2/ORGAN .....	E2
HARPSICHORD/ORGAN .....	G2

\* All other voice combinations are set to C3 (equal balance).

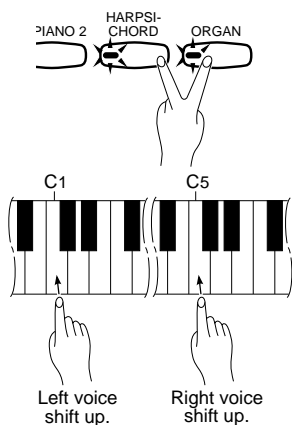

## Shifting a Dual-Mode Voice Up One Octave

Depending on which voices you combine using the DUAL mode, the combination may sound better if one of the voices is shifted up an octave. To shift the right voice, press the **C5** key while pressing the two voice selectors corresponding to the voices to be combined in the DUAL mode. Press **C5** again to shift the voice back to its normal range. Use the **C1** key in the same way to shift the left voice.

All voice combinations are set to the same octave by default.

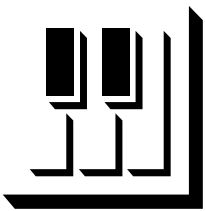

# The Pedals

The YDP-88II has three foot pedals that produce a range of expressive effects similar to those produced by the pedals on an acoustic piano.

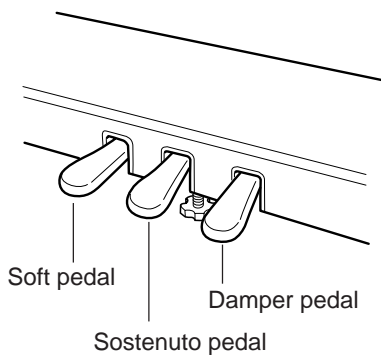

## Soft (Left) Pedal .....

The soft pedal reduces the volume and slightly changes the timbre of notes played while the pedal is pressed. The soft pedal will not affect notes which are already playing when it is pressed.

## Sostenuto (Center) Pedal .....

If you play a note or chord on the keyboard and press the sostenuto pedal while the note(s) are held, those notes will be sustained as long as the pedal is held (as if the damper pedal had been pressed) but all subsequently played notes will not be sustained. This makes it possible to sustain a chord, for example, while other notes are played “staccato.”

## Damper (Right) Pedal .....

The damper pedal functions in the same way as a damper pedal on an acoustic piano. When the damper pedal is pressed notes played have a long sustain. Releasing the pedal immediately stops (damps) any sustained notes.

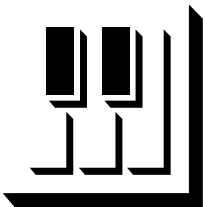

# Transposition

The YDP-88II's TRANSPOSE function makes it possible to shift the pitch of the entire keyboard up or down in semitone intervals up to a maximum of six semitones. “Transposing” the pitch of the YDP-88II keyboard facilitates playing in difficult key signatures, and you can easily match the pitch of the keyboard to the range of a singer or other instrumentalist.

The [MIDI/TRANSPOSE] button and keys **F#2** through **F#3** on the keyboard are used for transposition.

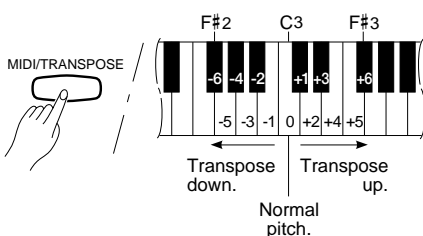

- 1** Press and hold the [MIDI/TRANSPOSE] button.
- 2** Press a key between **F#2** and **F#3** according to the desired amount of transposition.\*
- 3** Release the [MIDI/TRANSPOSE] button.

\* Pressing the **C3** key produces normal keyboard pitch. Pressing the key to the left of **C3** (**B2**) transposes the pitch of the keyboard down a semitone, the next key to the left (**Bb2**) transposes down a whole tone (two semitones), etc., down to the **F#2** key which transposes down 6 semitones. Upward transposition is accomplished in the same way using the keys to the right of **C3**, up to **F#3** which transposes up 6 semitones.



• Notes below and above the A-1 — C7 of the YDP-88II sound one octave higher and lower, respectively.

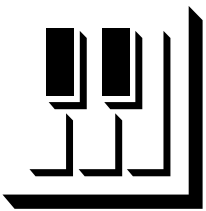

# Pitch Control

Pitch control makes it possible to tune the YDP-88II over a  $\pm 50$ -cent range (approximate) in approximately 1.6-cent intervals. A hundred “cents” equals one semitone, so the tuning range provided allows fine tuning of overall pitch over a range of approximately a semitone. Pitch control is useful for tuning the YDP-88II to match other instruments or recorded music.

## Tuning Up .....

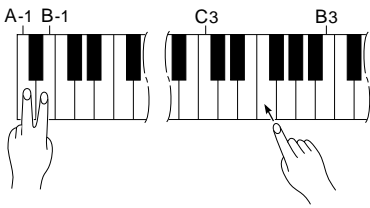

- 1** To tune up (raise pitch), hold the **A-1** and **B-1** keys simultaneously.
- 2** Press any key between **C3** and **B3**. Each time a key in this range is pressed the pitch is increased by approximately 1.6 cents, up to a maximum of 50 cents above standard pitch.
- 3** Release the **A-1** and **B-1** keys.

## Tuning Down .....

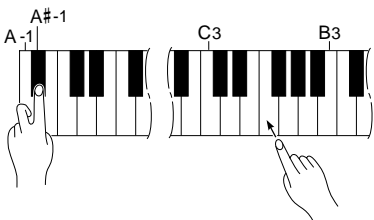

- 1** To tune down (lower pitch), hold the **A-1** and **A#-1** keys simultaneously.
- 2** Press any key between **C3** and **B3**. Each time a key in this range is pressed the pitch is decreased by approximately 1.6 cents, up to a maximum of 50 cents below standard pitch.
- 3** Release the **A-1** and **A#-1** keys.

## To Restore Standard Pitch\* .....

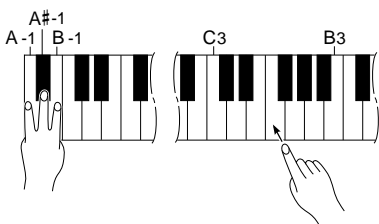

- 1** To restore standard pitch ( $A_3 = 440$  Hz), hold the **A-1**, **A#-1** and **B-1** keys simultaneously.
- 2** Press any key between **C3** and **B3**.
- 3** Release the **A-1**, **A#-1** and **B-1** keys.

\* Standard pitch ( $A_3 = 440$  Hz) is set when the **[POWER]** switch is initially turned ON.



• The **PITCH CONTROL** function has no effect when **LOCAL OFF** is active (see “**MIDI FUNCTIONS**,” page 13).

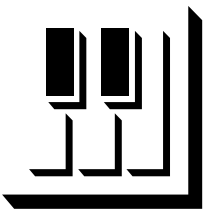

# The Metronome & Tempo Control

The YDP-88II built-in metronome is a convenient feature for practice, and it can also provide a solid rhythmic guide when recording using the Recorder feature, described below.

## The Metronome



The metronome sound is turned on and off via the [METRONOME] button. Press the [METRONOME] button so that its indicator lights to turn the metronome on, then again so the indicator goes out to turn the metronome off.

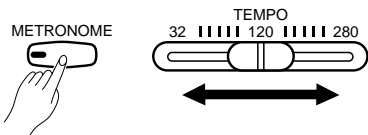

### Metronome Volume

The volume of the metronome sound can be independently adjusted by using the [TEMPO] control while holding the [METRONOME] button. Sliding the control to the right increases the metronome volume.

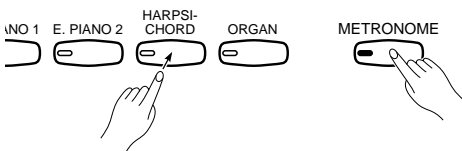

### Metronome Time Signature

The time signature of the metronome sound can be set by pressing the appropriate voice selector button while holding the [METRONOME] button, as follows:

[METRONOME] + [PIANO]	No accent (default)
[METRONOME] + [E. PIANO 1]	2 time
[METRONOME] + [E. PIANO 2]	3 time
[METRONOME] + [HARPSICHORD]	4 time
[METRONOME] + [ORGAN]	6 time

## Tempo Control

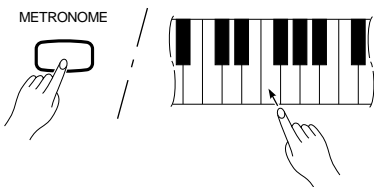
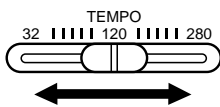

The tempo of the metronome and recorder playback can be controlled in two ways:

- Use the panel [TEMPO] control to set the required tempo from 32 to 280 quarter-note beats per minute.
- For more precise tempo settings press the appropriate key on the keyboard while holding the [METRONOME] button.

### Tempo/Key Chart

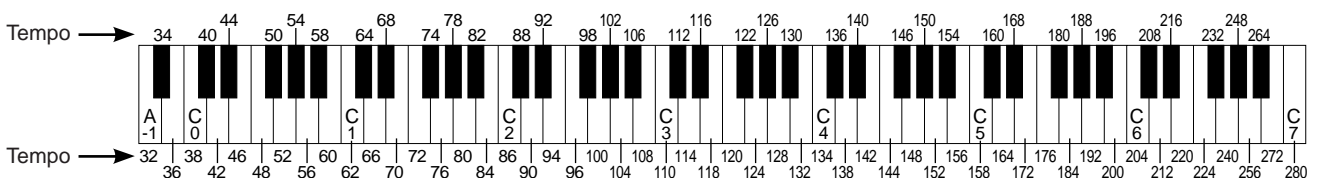

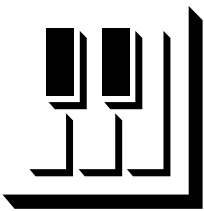

# Using the Recorder

The YDP-88II recorder lets you record what you play on the keyboard and then play it back. This is a useful adjunct to any keyboard study program, since it lets you hear exactly how you sound from the listener's perspective. It can also be just plain fun.

The recorder actually records the following data:

- Notes played
- Dual mode voices
- Damper pedal
- Sostenuto pedal (not recorded as an initial setting)
- Tempo (Initial setting only.)
- Voice selection
- Dual balance
- Soft pedal
- Dual mode octave shift

## Recording

### 1 Engage the Record Ready Mode .....

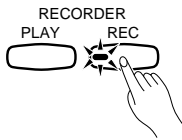

Press the **RECORDER [REC]** button to engage the record ready mode (recording does not actually start yet). The **[REC]** button indicator will light.

### 2 Make All Necessary Initial Settings .....

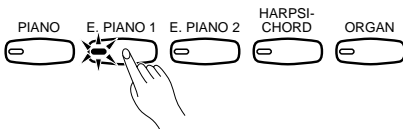

Before actually beginning to record, select the voice you want to record with (or voices if you will be using the dual mode). You might also want to set the volume and tempo controls.

### 3 Start Recording .....

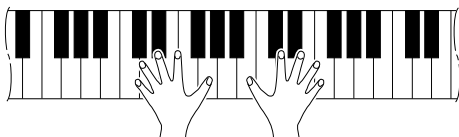

Recording will begin automatically as soon as you play a note on the keyboard or press the **[PLAY]** button.



- If the metronome was on when you started recording, you'll be able to keep time with the metronome while recording, but the metronome sound will not be recorded.
- You can record up to a maximum of about 1,300 notes, depending on pedal usage and other factors. The **[REC]** button indicator will begin to flash when recorder memory is almost full, and recording will stop automatically.

### 4 Stop Recording .....

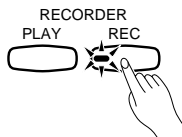

Press either the **RECORDER [REC]** or **[PLAY]** button to stop recording.

## Changing the Initial Settings.....

The initial voice (including dual mode) and tempo settings made in step 2 of the recording procedure are actually recorded by the YDP-88II. These initial settings can be changed after the recording is finished by pressing the **[REC]** button to engage the record ready mode, making the required changes, and then pressing the **[REC]** button again to exit from the record ready mode and register the changes. If you do this, be careful not to press the **[PLAY]** button or a key on the keyboard, either of which will start recording and erase all previous recorded data.

## Erasing the recorded data.....

The recorded data can be erased by first pressing the **[REC]** button to engage the record ready mode, and then pressing the **[PLAY]** button twice without recording any data.

## Playback

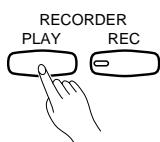

To play back what you've recorded, simply press the **RECORDER [PLAY]** button. Playback starts from the beginning of the recorded data, and will stop automatically at the end of the recorded data. You can also stop playback at any time by pressing the **[PLAY]** button.

### NOTE

- It is possible to play along on the keyboard during playback.
- The playback volume and tempo can be adjusted by using the **[MASTER VOLUME]** and **[TEMPO]** controls, respectively.
- If the metronome is being used during playback, the metronome will stop when playback is stopped.
- All recorder data will be erased when the YDP-88II power is turned off. It is possible to store recorded data to an external MIDI storage device such as the Yamaha DOU-10 Disk Orchestra Unit by using the Bulk Dump function described on page 16.
- The playback data is not transmitted via the MIDI OUT connector.

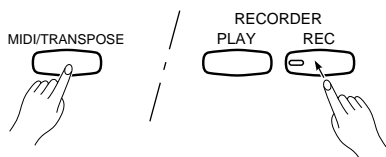

## Fast Forward Playback.....

When you want to locate a specific point in a recording you can quickly move forward through the recording while monitoring the sound by pressing the **[REC]** button while holding the **[MIDI/TRANPOSE]** button.

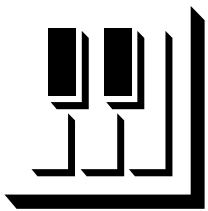

# MIDI Functions

## □ A Brief Introduction to MIDI.....

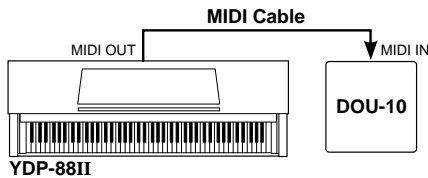

MIDI, the Musical Instrument Digital Interface, is a world-standard communication interface that allows MIDI-compatible musical instruments and equipment to share musical information and control one another. This makes it possible to create “systems” of MIDI instruments and equipment that offer far greater versatility and control than is available with isolated instruments. For example, most MIDI keyboards (including the YDP-88II, of course) transmit note and velocity (touch response) information via the MIDI OUT connector whenever a note is played on the keyboard. If the MIDI OUT connector is connected to the MIDI IN connector of a second keyboard (synthesizer, etc.) or a tone generator (essentially a synthesizer with no keyboard), the second keyboard or tone generator will respond precisely to notes played on the original transmitting keyboard. The result is that you can effectively play two instruments at once, providing thick multi-instrument sounds.

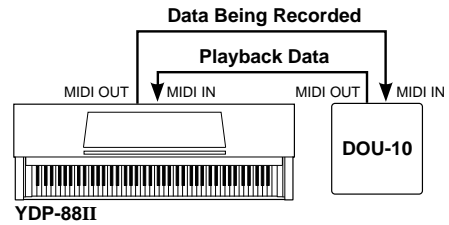

This same type of musical information transfer is used for MIDI sequence recording. A sequence recorder can be used to “record” MIDI data received from a YDP-88II, for example. When the recorded data is played back, the YDP-88II automatically “plays” the recorded performance in precise detail.

The examples given above really only scratch the surface. MIDI can do much, much more. The YDP-88II offers a number of MIDI functions that allows it to be used in fairly sophisticated MIDI systems.



- Always use a high-quality MIDI cable to connect MIDI OUT to MIDI IN terminals. Never use MIDI cables longer than about 15 feet, since cables longer than this can pick up noise which can cause data errors.

## □ MIDI “Messages” Transmitted & Received by the YDP-88II.....

The MIDI information (messages) transmitted and received by the YDP-88II are as follows:

### ● Note and Velocity Data

This information tells the receiving keyboard or tone generator to play a certain note (specified by the MIDI note number) at a certain dynamic level (specified by the MIDI velocity value). Note and velocity data is transmitted by the YDP-88II whenever a key is pressed, and the YDP-88II’s internal AWM tone generator will “play” the corresponding note(s) whenever note and velocity data is received from an external MIDI device.

### ● Program Change Numbers

The YDP-88II transmits a MIDI program change number between 0 and 4 when one of its voice selectors is pressed. This normally causes the correspondingly numbered voice to be selected on a receiving MIDI device. The YDP-88II will respond in the same way, automatically selecting the appropriate voice when a MIDI program change number is received. See “Program Change ON/OFF” on page 15 for information on turning program change number reception and transmission ON or OFF.

### ● Control Change Numbers

Control Change data representing Damper pedal operation is transmitted by the YDP-88II whenever one of these pedals is used. If the receiving device is a tone generator or another keyboard, it will respond in the same way as the YDP-88II’s internal tone generator when one of the pedals is used. The YDP-88II also receives and responds to the appropriate control change data. See “Control Change ON/OFF” on page 15 for information on turning control change number reception and transmission ON or OFF.

## MIDI Transmit & Receive Channel Selection

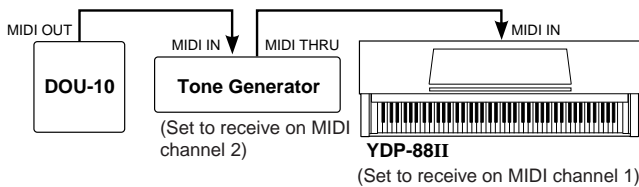

The MIDI system allows transmission and reception of MIDI data on 16 different channels. Multiple channels have been implemented to allow selective control of certain instruments or devices connected in series. For example, a single MIDI sequence recorder could be used to “play” two different instruments or tone generators. One of the instruments or tone generators could be set to receive only on channel 1, while the other is set to receive on channel 2. In this situation the first instrument or tone generator will respond only to channel-1 information transmitted by the sequence recorder, while the second instrument or tone generator will respond only to channel-2 information. This allows the sequence recorder to “play” two completely different parts on the receiving instruments or tone generators.

In any MIDI control setup, the MIDI channels of the transmitting and receiving equipment must be matched for proper data transfer. An “OMNI” receive mode is also available, which allows reception on all 16 MIDI channels. In the OMNI mode it is not necessary to match the receive channel of the receiving device to the transmit channel of the transmitting device (except when receiving mode messages).

### ● Setting the YDP-88II MIDI Channels

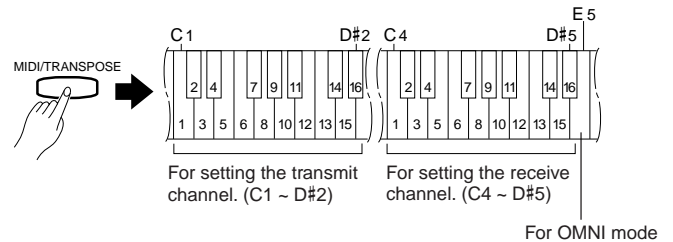

- 1 Press and hold the [MIDI/TRANPOSE] button.
- 2 Press the key on the keyboard corresponding to the desired MIDI transmit or receive channel.\*
- 3 Release the [MIDI/TRANPOSE] button.

\* Keys C1 through D#2 on the keyboard are used to set the MIDI transmit channel, and keys C4 through D#5 are used to turn the OMNI mode OFF and set the MIDI receive channel as shown in the illustration to the left. The E5 key sets the OMNI receive mode and basic receive channel 1.



NOTE

• When the power is initially turned ON, MIDI receive is set to the OMNI mode and the transmit channel is set to 1.

## MIDI Transmit Transpose

This function allows the MIDI note data transmitted by the YDP-88II to be transposed up or down in semitone increments by up to plus or minus 6 semitones. The pitch of the YDP-88II itself is not affected.

### ● Setting the MIDI Transpose Function

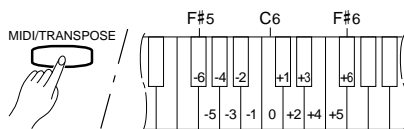

- 1 Press and hold the [MIDI/TRANPOSE] button.
  - 2 Press the key on the keyboard corresponding to the desired amount of transposition.\*
  - 3 Release the [MIDI/TRANPOSE] button.
- \* Keys F#5 through F#6 on the keyboard are used to set the MIDI transmit transpose function as shown in the illustration to the left.



NOTE

• When the power is turned ON, MIDI transmit transpose is set to 0 (no transposition).

## Other MIDI Functions

The MIDI functions listed to the right are engaged by holding down the [MIDI/TRANPOSE] button and pressing the corresponding voice selector. Full details are given in the following pages.

### MIDI FUNCTION CHART

Function	YDP-88II Voice Selector
Local Control ON/OFF	[PIANO]
Program Change ON/OFF	[E. PIANO 1]
Control Change ON/OFF	[E. PIANO 2]
Multi-Timbre Mode	[HARPSICHORD]
MIDI Split & Left Local OFF	[ORGAN]



## Local Control ON/OFF

“Local Control” refers to the fact that, normally, the YDP-88II keyboard controls its internal tone generator, allowing the internal voices to be played directly from the keyboard. This situation is “Local Control ON” since the internal tone generator is controlled locally by its own keyboard.

Local control can be turned OFF, however, so that the YDP-88II keyboard does not play the internal voices, but the appropriate MIDI information is still transmitted via the MIDI OUT connector when notes are played on the keyboard. At the same time, the internal tone generator responds to MIDI information received via the MIDI IN connector.

When using the DOU-10 Disk Orchestra Unit with the YDP-88II, for example, Local Control should be turned OFF when recording using the DOU-10 voices only, and ON when recording the YDP-88II voices while listening to playback of the DOU-10 voices.

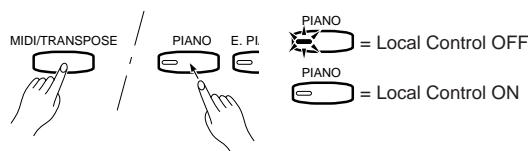

- 1** Hold down the [MIDI/TRANSCOPE] button.
- 2** Press the [PIANO] voice selector. If the PIANO LED is lit when the [PIANO] voice selector is pressed, you have turned local control OFF. If the PIANO LED is not lit when the [PIANO] voice selector is pressed, you have turned local control ON.
- 3** Release the [MIDI/TRANSCOPE] button.

## Program Change ON/OFF

Normally the YDP-88II will respond to MIDI program change numbers received from an external keyboard or other MIDI device, causing the correspondingly numbered YDP-88II voice to be selected. The YDP-88II will normally also send a MIDI program change number whenever one of its voices is selected, causing the correspondingly numbered voice or program to be selected on the external MIDI device if the device is set up to receive and respond to MIDI program change numbers.

This function makes it possible to cancel program change number reception and transmission so that voices can be selected on the YDP-88II without affecting the external MIDI device, and vice versa.

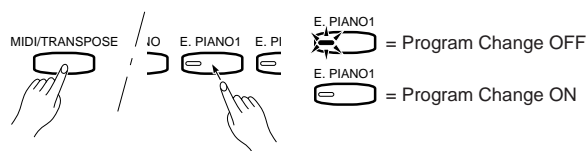

- 1** Hold down the [MIDI/TRANSCOPE] button.
- 2** Press the [E. PIANO 1] voice selector. If the E. PIANO 1 LED is lit when the [E. PIANO 1] voice selector is pressed, you have turned program change reception/transmission OFF. If the E. PIANO 1 LED is not lit when the [E. PIANO 1] voice selector is pressed, you have turned program change reception/transmission ON.
- 3** Release the [MIDI/TRANSCOPE] button.

## Control Change ON/OFF

Normally the YDP-88II will respond to MIDI control change data received from an external MIDI device or keyboard, causing the selected YDP-88II voice to be affected by pedal and other “control” settings received from the controlling device. The YDP-88II also transmits MIDI control change information when one of its pedals are operated.

This function makes it possible to cancel control change data reception and transmission if you do not want the YDP-88II voices to be affected by control change data received from an external device or vice versa.

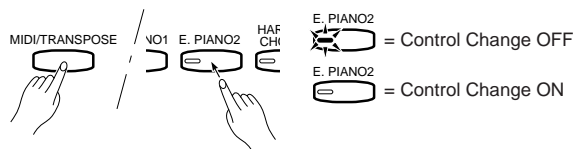

- 1** Hold down the [MIDI/TRANSCOPE] button.
- 2** Press the [E. PIANO 2] voice selector. If the E. PIANO 2 LED is lit when the [E. PIANO 2] voice selector is pressed, you have turned control change reception/transmission OFF. If the E. PIANO 2 LED is not lit when the [E. PIANO 2] voice selector is pressed, you have turned control change reception/transmission ON.
- 3** Release the [MIDI/TRANSCOPE] button.

## The Multi-Timbre Mode

The Multi-Timbre mode is a special mode in which the YDP-88II voices can be independently controlled on different MIDI channel numbers by an external MIDI device. The Multi-Timbre mode can be activated as follows:

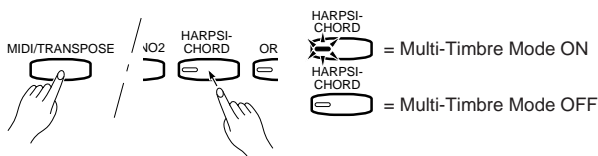

- 1 Hold down the [MIDI/TRANPOSE] button.
- 2 Press the [HARPSICHORD] voice selector. If the HARPSICHORD LED is lit when the [HARPSICHORD] voice selector is pressed, you have turned the Multi-Timbre mode ON. If the HARPSICHORD LED is not lit when the [HARPSICHORD] voice selector is pressed, you have turned the Multi-Timbre mode OFF.
- 3 Release the [MIDI/TRANPOSE] button.

## The MIDI Split & Left Local OFF Mode

In the MIDI split mode one section of the YDP-88II keyboard is used to play a YDP-88II voice in the normal way, while the remaining section is used to play a second MIDI keyboard or tone generator such as the Yamaha DOU-10 Disk Orchestra Unit. In this mode the right-hand section of the keyboard is used to play an internal YDP-88II voice, while the left-hand section of the keyboard plays the external keyboard or tone generator. Playing the left-hand section of the keyboard produces no sound from the YDP-88II. The “split point,” or the key that divides the left- and right-hand sections of the keyboard can be set at any desired key.

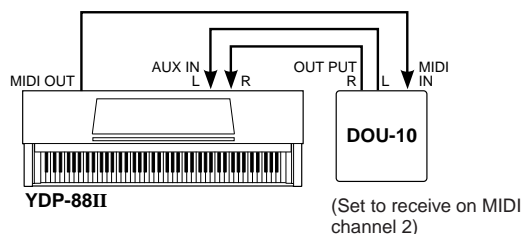

The MIDI split mode is useful if, for example, you want to play a piano (YDP-88II) voice with the right hand while playing a synthesizer bass line or string section with the left hand.

When the MIDI split mode is activated, notes played on the left-hand section are transmitted via the YDP-88II MIDI OUT connector on MIDI channel 2. Notes played on the right-hand section are transmitted on the “basic channel” (i.e. the channel set using the MIDI channel selection function described previously).

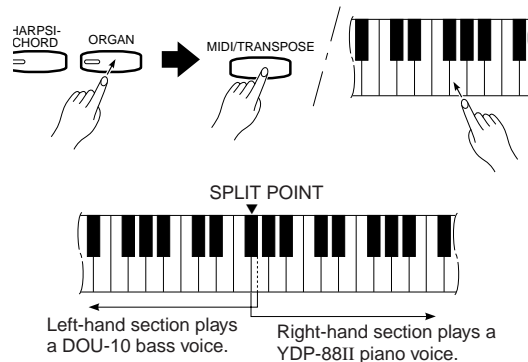

- 1 Press the [ORGAN] voice selector while holding down the [MIDI/TRANPOSE] button. The ORGAN LED will flash.
- 2 While still holding the [MIDI/TRANPOSE] button, press the key on the keyboard at which you want to set the split point. The ORGAN LED will light continuously. The split-point becomes the first key of the left-hand section.
- 3 Release the [MIDI/TRANPOSE] button.
- 4 To return to the normal full-keyboard mode, hold the [MIDI/TRANPOSE] button and press the [ORGAN] voice selector, then release both buttons.

**NOTE** • When the power is turned ON the default split point key — F#2 — will be automatically selected. If a new split point is selected it remains active until the power is turned OFF or a different split point is selected.

## Bulk Data Dump

This function is used to transmit all data stored in the Recorder memory to a MIDI data storage device such as the Yamaha DOU-10 Disk Orchestra Unit, other sequence recorders, or MIDI compatible computers.

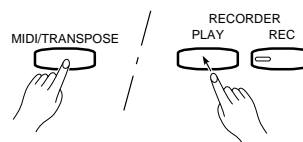

- 1 Hold [MIDI/TRANPOSE] and press the [PLAY] button. Transmission will begin.
- 2 Release the buttons.

**NOTE** • Bulk dump will not function when the metronome is on or when the recorder is in operation.

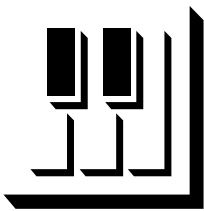

# Troubleshooting

If you encounter what appears to be a malfunction, please check the following points before assuming that your YDP-88II is faulty.

## 1. No Sound When the Power is Turned ON

Is the AC plug properly connected to an AC wall outlet? Check the AC connection carefully. Is the MASTER VOLUME control turned up to a reasonable listening level?

Also make sure that a pair of headphones is not plugged into the PHONES jack, and the Local Control (page 15) is ON.

## 2. The Damper Pedal Doesn't Work

If the damper pedal doesn't work, or notes are sustained even when the pedal is not pressed, make sure that the pedal cord is properly plugged into the main unit (page iii).

## 3. The YDP-88II Reproduces Radio or TV Sound

This can occur if there is a high-power transmitter in your vicinity. Contact your Yamaha dealer.

## 4. Intermittent Static Noise

This is usually due to turning ON or OFF a household appliance or other electronic equipment which is fed by the same AC mains line as your YDP-88II.

## 5. Interference Appears On Radio or TV Sets Located Near the YDP-88II

The YDP-88II contains digital circuitry which can generate radio-frequency noise. The solution is to move the YDP-88II further away from the affected equipment, or vice versa.

## 6. Distorted Sound When the YDP-88II is Connected to An External Amplifier/Speaker System

If the YDP-88II is connected to a stereo system or instrument amplifier and the sound is distorted, reduce the setting of the YDP-88II volume control to a level at which the distortion ceases.

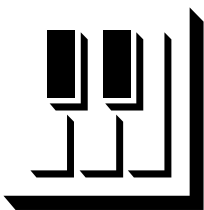

# Options & Expander Modules

## ● Options

### BC-8 Bench

A comfortable bench styled to match your Yamaha YDP-88II.

### HPE-160 Stereo Headphones

High-performance lightweight dynamic headphones with extra-soft ear pads.

## ● Expander Modules

### DOU-10 Disk Orchestra Unit

A range of MIDI recording and playback functions, plus Yamaha DOC software, Disklavier PianoSoft™, General MIDI, and Standard MIDI File disk playback capability.

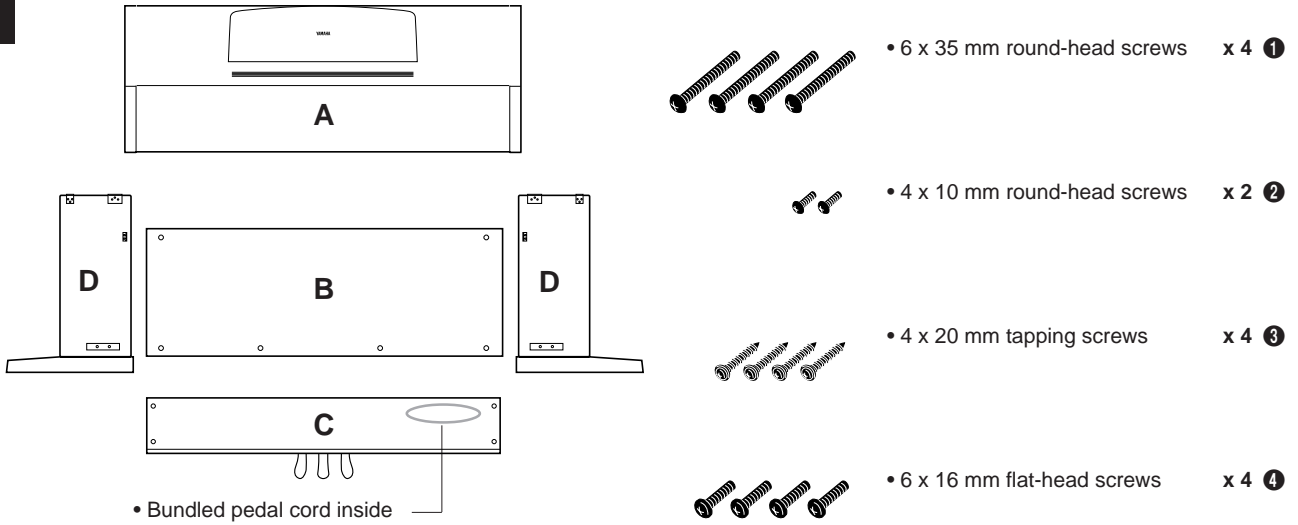
**1**

## Keyboard Stand Assembly

### NOTE

- Be careful not to confuse parts, and be sure to install all parts in the correct direction. Please assemble in accordance with the sequence given below.
- Assembly should be carried out by at least two persons.
- Be sure to use the correct screw size, as indicated above. Use of incorrect screws can cause damage.
- Be sure to tighten up all screws upon completing assembly of each unit.
- To disassemble, reverse the assembly sequence given below.

### 1 Open the box and remove all the parts.

On opening the box you should find the parts shown in the illustration above. Check to make sure that all the required parts are provided.

**2**

- Use the vinyl tie attached to the bottom of the pedal box to secure the cord.

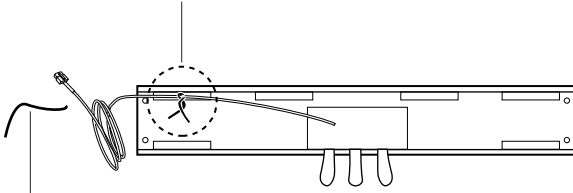

- The other vinyl tie will be used later in step **6**.

**3**

- 6 x 35 mm round-head screws **1**

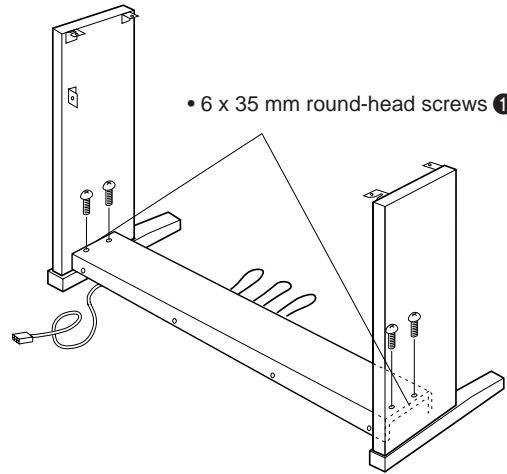

## **2 Untie the two vinyl ties.**

Untie both vinyl ties and straighten out the bundled cord attached to the bottom of the pedal box. Use the vinyl tie attached to the bottom of the pedal box to secure the cord. Don't discard the other vinyl tie, you'll need it later in step **6**.

## **3 Attach the side panels (D) to the pedal box (C).**

Place the pedal box on top of the wooden blocks attached to the side panels (D), and while eliminating any gaps between the pedal box and side panels, attach using the four 6 x 35 millimeter round-head screws **1** — two screws on each side. Make sure the pedals extend in the same direction as the side panel feet.

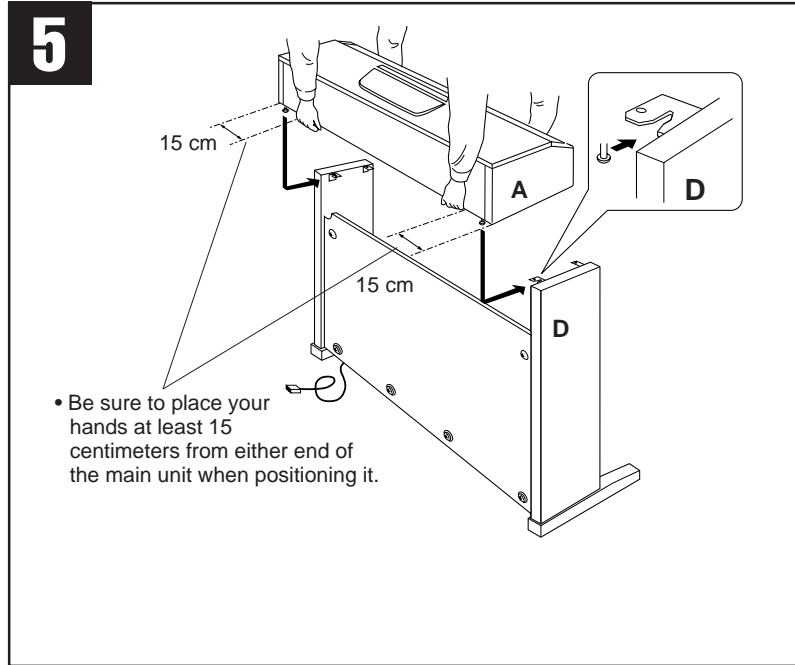
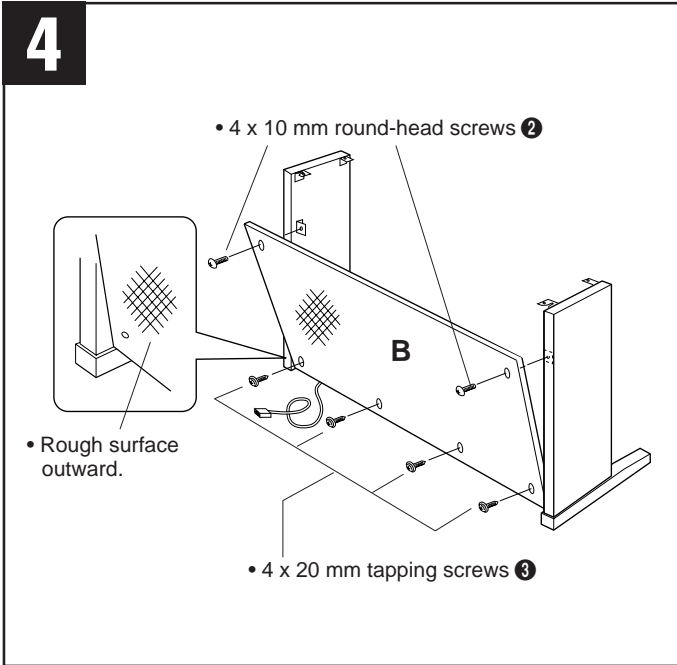

**4 Attach the rear panel (B).**

With the rear panel's rough surface facing outward and the panel slightly angled as shown in the illustration, lower it onto the feet's protruding edge at the rear of the pedal box. Then, while eliminating any gaps between the rear and side panels, secure the top of the rear panel to the side panel brackets using two 4 x 10 mm round-head screws ②. Finally, secure the bottom of the rear panel to the pedal box using four 4 x 20 mm tapping screws ③.

**5 Install the main unit (A).**

Place the main unit (A) on the side panels (D) with the screws on its bottom panel (toward the rear of the main unit) just behind the grooves in the brackets located at the top of the side panels. Then slide the main unit forward until it stops. **WATCH YOUR FINGERS WHEN DOING THIS!!**

• 6 x 16 mm flat-head screws ④

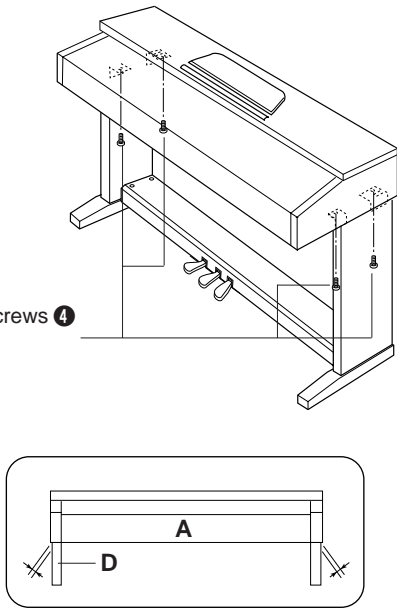

6

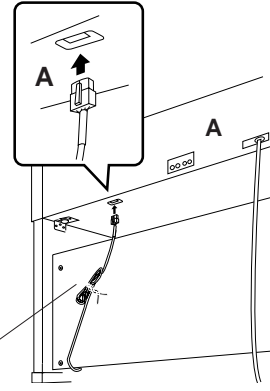

• Use the vinyl tie that was removed from the bundled pedal cord in step ② to tie up any slack in the pedal cord.

Align the holes on the bottom panel of the main unit with the holes in the brackets on the side panels (also center the main unit to produce equal clearance on the left and right sides, as shown in the illustration), then screw in and securely tighten the four 6 x 16 millimeter flat-head screws ④.

**CAUTION**

- Do not hold the keyboard in any position other than the position shown in the above illustration.
- Fingers can become pinched between the main unit and the rear or side panels, be extra careful so as not to drop the main unit.

**6 Connect the pedal cord.**

The pedal cord from the pedal box must be plugged into the corresponding connector in the main unit. The plug only goes in one way (the lug on the connector should face the rear of the main unit, as shown in the illustration), so don't try to force it in the wrong way around.

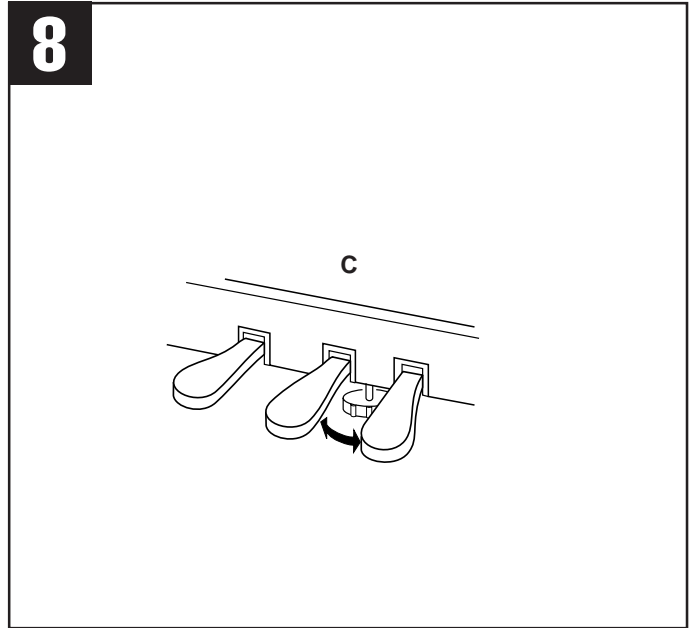
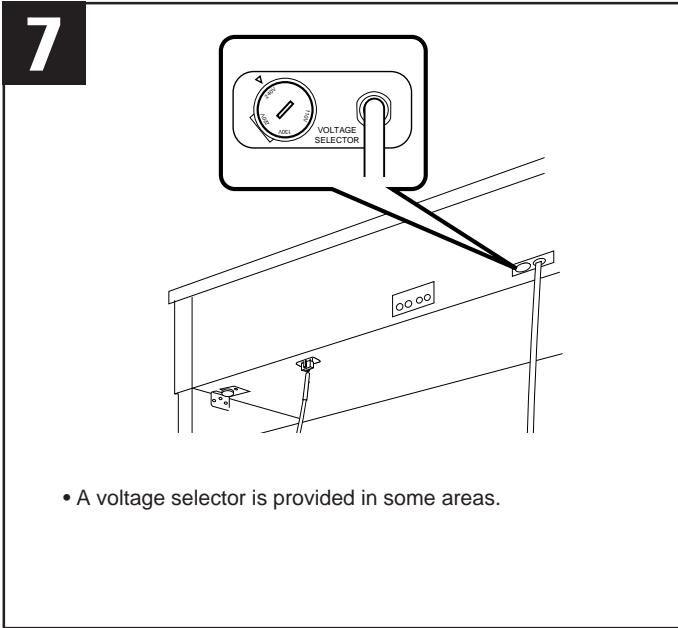

**7 Voltage Selector**

Before connecting the AC power cord, check the setting of the voltage selector which is provided in some areas. To set the selector for 110V, 130V, 220V or 240V main voltages, use a “minus” screwdriver to rotate the selector dial so that the correct voltage for your region appears next to the pointer on the panel. The voltage selector is set at 240V when the unit is initially shipped. After the proper voltage has been selected connect the AC power cord. A plug adaptor may be also provided in some areas to match the pin configuration of the AC wall outlets in your area.

**8 Set the adjuster.**

For stability, an adjuster is provided on the bottom of the pedal box (C). Rotate the adjuster until it comes in firm contact with the floor surface. The adjuster ensures stable pedal operation and facilitates pedal effect control. If the adjuster is not in firm contact with the floor surface, distorted sound may result.



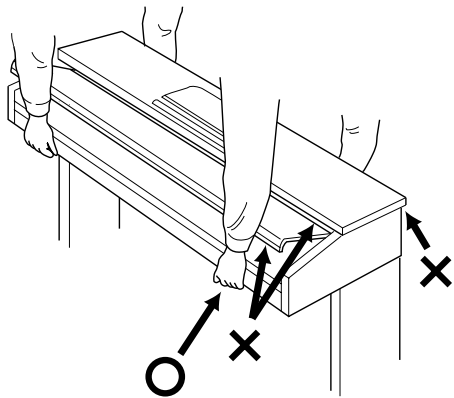

**CAUTION**

- When moving the instrument after assembly, always hold the lower surface of the main unit, NEVER the top portion. Improper handling can result in damage to the instrument or personal injury.

**■ After completing the assembly, please check the following.**

- Are there any parts left over?
  - ➔ Review the assembly procedure and correct any errors.
- Is the YDP-88II clear of doors and other movable fixtures?
  - ➔ Move the YDP-88II to an appropriate location.
- Does the YDP-88II make a rattling noise when you shake it?
  - ➔ Tighten all screws.
- Does the pedal box rattle or give way when you step on the pedals?
  - ➔ Turn the adjuster so that it is set firmly against the floor.
- Is the pedal cord inserted securely into the socket?
  - ➔ Check the connection.
- If the main unit creaks or is otherwise unsteady when you play on the keyboard, refer to the assembly diagrams and retighten all screws.

# MIDI Data Format

If you're already very familiar with MIDI, or are using a computer to control your music hardware with computer-generated MIDI messages, the data provided in this section can help you to control the YDP-88II.

## 1. NOTE ON/OFF

Data format: [9nH] -> [kk] -> [vv]

9nH = Note ON/OFF event (n = channel number)

kk = Note number

Transmit: 15 ~ 114 = D#-1 ~ F#7

Receive: 21 ~ 108 = A-1 ~ C7

vv = Velocity (Key ON = 1 ~ 127. Key OFF = 0)

Data format: [8nH] -> [kk] -> [vv]

8nH = Note OFF event (n = channel number)

kk = Note number

Transmit: 15 ~ 114 = D#-1 ~ F#7

Receive: 21 ~ 108 = A-1 ~ C7

vv = Velocity (Key OFF = 0 ~ 127)

\* 8nH (note off) is receive only.

9nH (vvH=00H) used for transmission.

## 2. CONTROL CHANGE & MODE MESSAGES

Data format: [BnH] -> [cc] -> [vv]

BnH = Control event (n = channel number)

cc = Control number

vv = Control value

cc	CONTROL	VALUE [vv]
07H	Volume	00H : ∞ (reception only) 6FH : -3dB 7FH : ±0dB
0AH	Panpot	00H ~ 17H : Left 6 (reception only) 18H ~ 1FH : Left 5 20H ~ 27H : Left 4 28H ~ 2FH : Left 3 30H ~ 37H : Left 2 38H ~ 3FH : Left 1 40H ~ 47H : Center 48H ~ 4FH : Scaling pan 50H ~ 57H : Right 1 58H ~ 5FH : Right 2 60H ~ 67H : Right 3 68H ~ 6FH : Right 4 70H ~ 77H : Right 5 78H ~ 7FH : Right 6
0BH	Expression	00H : ∞ (reception only) 6FH : -3dB 7FH : ±0dB
40H	Damper	00H ~ 3FH : OFF
	Pedal	40H ~ 7FH : ON
42H	Sostenuto	00H ~ 3FH : OFF
	Pedal	40H ~ 7FH : ON
43H	Soft Pedal	00H ~ 3FH : OFF 40H ~ 7FH : ON
78H	All Sound OFF (reception only)	00H
79H	Reset All Controller (reception only)	00H
7AH	Local Control ON/OFF	00H : OFF (reception only) 7FH : ON
7BH	All Notes OFF (reception only)	00H
7CH	Omni OFF/All Notes OFF	00H (reception only)
7DH	Omni ON/All Notes OFF	00H (reception only)

## 3. PROGRAM CHANGE

Data format: [CnH] -> [pp]

CnH = program event (n = channel number)

pp = Program number

pp	VOICE NAME	pp	VOICE NAME
00	PIANO	03	HARPSICHORD
01	E. PIANO1	04	ORGAN
02	E. PIANO2		

## 4. SYSTEM REALTIME MESSAGES

[rrH]

rr = Control

F8H : Timing clock

FAH : Start

FCH : Stop

FEH : Active sensing

Data	Transmission	Reception
F8H	Transmitted every 96 clocks	Received as 96-clock tempo timing when MIDI clock is set to External
FAH	Recorder start	Recorder start
FCH	Recorder stop	Recorder stop
FEH	Transmitted every 200 milliseconds	All notes are turned off if no data is received for more than 400 milliseconds

\* **Caution:** If an overrun framing error occurs the Damper, Sostenuto, and Soft effects for all channels are turned off and an All Note Off occurs.

## 5. SYSTEM EXCLUSIVE MESSAGES

### (1) YAMAHA MIDI Format

Data format: [F0H] -> [43H] -> [xnH] -> [ff] ... [F7H]

43H : Yamaha

xn : Substatus + channel number.

ff : Format number.

#### x ff Information

0 7CH Panel Data receive.

2 7CH Panel Data Send occurs when this data received.

2 7DH Name Data Send occurs when this data received.

\* This message is effective only when the channel number "n" is set to the same as the YDP-88II receive channel number.

### PANEL DATA SEND FORMAT

F0H, 43H, 0nH, 7CH, 00H, 1BH (n: channel number)

53H, 4BH, 20H, 20H (SK)

43H, 4CH, 50H, 27H, 39H, 34H (x, y: version number)

3xH, 3yH

[PANEL DATA]

[CHECK SUM (1byte)] = 0-(53H+4BH+20H+...+Data end)

F7H

#### • Panel Data Contents

(1) VOICE

(2) DUAL VOICE

(3) DUAL ON/OFF

(4) DUAL BALANCE

(5) 0

(6) 0

(7) 0

(8) 0

(9) 0

(10) 0

(11) 0

(12) SPLIT POINT

(13) 0

(14) Absolute tempo low byte

(15) Absolute tempo high byte

### SEQUENCE DATA FORMAT

F0H, 43H, 73H

38H (Product ID)

06H (Bulk ID)

02H (Bulk number)

03H, 0FH, 0AH, 02H (Data length= wxyzH 0x1fd1\*2 bytes)

[PANEL DATA] (Sequence data)

[CHECK SUM (1byte)] = 0-sum (BULK DATA)

F7H

### MODEL ID CODE SEND FORMAT

F0H, 43H, 0nH, 7DH, 00H, 10H (n: channel number)

53H, 4BH, 20H, 20H ] (Model ID)

43H, 4CH, 50H, 27H, 39H, 34H ] (Model ID)

3xH, 3yH, 20H, 20H, 20H, 20H (x, y: version number)

[CHECK SUM (1byte)] = 0-(53H+4BH+20H+.....+20H)

F7H

### (2) YDP-88II MIDI Format

Data format: [F0H] -> [43H] -> [73H] -> [38H]

-> [yy] -> [F7H]

43H : Yamaha ID

73H : ] Model ID

38H : ] Substatus

yy : Substatus

#### yy Information

02H Internal MIDI clock.

03H External MIDI clock.

13H Multi-timbre mode OFF.

15H Multi-timbre mode ON.

61H MIDI FA cancel ON.

62H MIDI FA cancel OFF.

7cH All notes OFF; receive channel = c+1; omni OFF.

\* When yy=2, 3, 13, 15 or 7c, YDP common ID

(01H) is recognized as well as 73H, 38H.

\* All Control Change values are reset when [13H] or

[15H] is received. All voices and other parameters

are also reset when [15H] is received in order to

ensure the same initial settings.

\* When [61H] is received, playback will not start

when "start" (FAH) is received. However, "stop"

(FCH) and the "timing clock" (F8H) will not be

affected. Use [62H] to cancel this function.

### (3) Special Control

Data format: [F0H] -> [43H] -> [73H] -> [38H]

-> [11H] -> [0nH] -> [cc] -> [vv] -> [F7H]

43H : Yamaha ID

73H : ] Model ID

38H : ]

11H : Special control

0nH : Control MIDI change + channel number

cc : Control number

vv : Value

#### cc Control Value [vv]

08H Dual Balance 00H : Left Voice Max.

7FH : Right Voice Max.

1BH Metronome 00H : Off

(reception only) 01H : On

5AH Dual Mode 00H : Dual Off

01H : Dual On (Normal)

02H : Dual On (Left voice 1

octave up)

03H : Dual On (Right voice 1

octave up)

5CH Dual Voice [vv] : Dual Voice

### (4) Absolute Tempo

Data format: [F0H] -> [43H] -> [73H] -> [xx]

-> [11H] -> [1nH] -> [cc] -> [dd] -> [F7H]

43H : Yamaha ID

73H : ] Model ID

38H : ]

11H : Special control

1nH : Control MIDI change

(Transmit: n=control channel number)

(Receive: any channel OK)

ccH : Absolute tempo low byte

ddH : Absolute tempo high byte

Tempo=dd\*128+cc

MIDI Implementation Chart

Function	Transmitted	Recognized	Remarks
Basic Default Channel Changed	1 1~16	1 1~16	
Mode Default Messages	3 × *****	1 OMNI on, OMNI off ×	
Note Number : True voice	15~114 *****	0~127 21~108	
Velocity Note on Note off	○ 9nH, v=1~127 × 9nH, v=0	○ v=1~127 ×	
After key's Touch Ch's	× ×	× ×	
Pitch Bender	×	×	
Control Change			
	07 ×	○	Volume Pan pot Expression
	10 ×	○	
	11 ×	○	
	64 ○	○	Damper Sostenuto Soft pedal
	66 ○	○	
	67 ○	○	
	120 ×	○	All sounds off *1 Reset All Controllers
	121 ×	○	
Program Change : True #	○ *****	○	
System Exclusive	○	○	
System : Song Position : Song Select Common : Tune	× × ×	× × ×	
System : Clock Real Time : Commands	○ ○	○ ○	
Aux : Local ON/OFF : All Notes Off Messages : Active Sense : Reset	× × ○ ×	× ○ (123~125) *1 ○ ×	
Notes : *1 = receive if omni off or multi-timbre on			

# Specifications

		<b>YDP-88II</b>
<b>KEYBOARD</b>		88 KEYS (A-1 ~ C7)
<b>POLYPHONY</b>		28 NOTES MAX.
<b>VOICE SELECTORS</b>		PIANO, E. PIANO1, E. PIANO2, HARPSICHORD, ORGAN
<b>RECORDER</b>		PLAY, REC
<b>PEDAL CONTROLS</b>		SOFT, SOSTENUTO, DAMPER
<b>OTHER CONTROLS</b>		MASTER VOLUME, TEMPO, METRONOME, DEMO, MIDI/TRANPOSE
<b>JACKS/CONNECTORS</b>		PHONES x 2, AUX OUT L/L+R & R, MIDI IN/OUT
<b>OUTPUT IMPEDANCE</b>		AUX OUT: Output impedance 600 Ω
<b>MAIN AMPLIFIERS</b>		10W x 2
<b>SPEAKERS</b>		16 cm x 2
<b>DIMENSIONS</b> (W x D x H)	Music stand down	1384 x 468 x 829 mm (54-1/2" x 18-1/2" x 32-5/8")
	Music stand up	1384 x 468 x 1001 mm (54-1/2" x 18-1/2" x 39-3/8")
<b>WEIGHT</b>		42 kg (92.6 lbs.)

- Specifications and descriptions in this owner's manual are for information purposes only. Yamaha Corp. reserves the right to change or modify products or specifications at any time without prior notice. Since specifications, equipment or options may not be the same in every locale, please check with your Yamaha dealer.

## IMPORTANT NOTICE FOR THE UNITED KINGDOM Connecting the Plug and Cord

IMPORTANT. The wires in this mains lead are coloured in accordance with the following code:

BLUE : NEUTRAL  
BROWN : LIVE

As the colours of the wires in the mains lead of this apparatus may not correspond with the coloured markings identifying the terminals in your plug proceed as follows:

The wire which is coloured BLUE must be connected to the terminal which is marked with the letter N or coloured BLACK.

The wire which is coloured BROWN must be connected to the terminal which is marked with the letter L or coloured RED.

Making sure that neither core is connected to the earth terminal of the three pin plug.

- This applies only to products distributed by Yamaha-Kemble Music (U.K.) Ltd.

For details of products, please contact your nearest Yamaha or the authorized distributor listed below.

Pour plus de détails sur les produits, veuillez-vous adresser à Yamaha ou au distributeur le plus proche de vous figurant dans la liste suivante.

Die Einzelheiten zu Produkten sind bei Ihrer unten aufgeführten Niederlassung und bei Yamaha Vertragshändlern in den jeweiligen Bestimmungsländern erhältlich.

Para detalles sobre productos, contacte su tienda Yamaha más cercana o el distribuidor autorizado que se lista debajo.

## NORTH AMERICA

### CANADA

**Yamaha Canada Music Ltd.**  
135 Milner Avenue, Scarborough, Ontario,  
M1S 3R1, Canada  
Tel: 416-298-1311

### U.S.A.

**Yamaha Corporation of America,  
Keyboard Division**  
6600 Orangethorpe Ave., Buena Park, Calif. 90620,  
U.S.A.  
Tel: 714-522-9011

## MIDDLE & SOUTH AMERICA

### MEXICO

**Yamaha De Mexico S.A. De C.V.,  
Departamento de ventas**  
Javier Rojo Gomez No.1149, Col. Gpe Del  
Moral, Deleg. Iztapalapa, 09300 Mexico, D.F.  
Tel: 686-00-33

### BRASIL

**Yamaha Musical Do Brasil LTDA.**  
Ave. Reboucas 2636, São Paulo, Brasil  
Tel: 011-853-1377

### PANAMA

**Yamaha De Panama S.A.**  
Edificio Interseco, Calle Elvira Mendez no.10,  
Piso 3, Oficina #105, Ciudad de Panama, Panama  
Tel: 507-69-5311

### OTHER LATIN AMERICAN COUNTRIES AND CARIBBEAN COUNTRIES

**Yamaha Music Latin America Corp.**  
6101 Blue Lagoon Drive, Miami, Florida 33126,  
U.S.A.  
Tel: 305-261-4111

## EUROPE

### THE UNITED KINGDOM

**Yamaha-Kemble Music (U.K.) Ltd.**  
Sherbourne Drive, Tilbrook, Milton Keynes,  
MK7 8BL, England  
Tel: 01908-366700

### IRELAND

**Danfay Ltd.**  
61D, Sallynoggin Road, Dun Laoghaire, Co. Dublin  
Tel: 01-2859177

### GERMANY/SWITZERLAND

**Yamaha Europa GmbH.**  
Siemensstraße 22-34, 25462 Rellingen,  
F.R. of Germany  
Tel: 04101-3030

### AUSTRIA

**Yamaha Music Austria**  
Schleiergasse 20, A-1100 Wien Austria  
Tel: 01-60203900

### THE NETHERLANDS

**Yamaha Music Nederland**  
Kanaalweg 18G, 3526KL, Utrecht, The Netherlands  
Tel: 030-2828411

### BELGIUM

**Yamaha Music Belgium**  
Keiberg Imperiastraat 8, 1930 Zaventem, Belgium  
Tel: 02-7258220

### FRANCE

**Yamaha Musique France,  
Division Claviers**  
BP 70-77312 Marne-la-Vallée Cedex 2, France  
Tel: 01-64-61-4000

### ITALY

**Yamaha Musica Italia S.P.A.,  
Home Keyboard Division**  
Viale Italia 88, 20020 Lainate (Milano), Italy  
Tel: 02-935-771

### SPAIN

**Yamaha-Hazen Electronica Musical, S.A.**  
Jorge Juan 30, 28001, Madrid, Spain  
Tel: 91-577-7270

### PORTUGAL

**Valentim de Carvalho CI SA**  
Estrada de Porto Salvo, Paço de Arcos 2780 Oeiras,  
Portugal  
Tel: 01-443-3398/4030/1823

### GREECE

**Philippe Nakas S.A.**  
Navarinou Street 13, P.Code 10680, Athens, Greece  
Tel: 01-364-7111

### SWEDEN

**Yamaha Scandinavia AB**  
J. A. Wettergrens Gata 1  
Box 30053  
S-400 43 Göteborg, Sweden  
Tel: 031 89 34 00

### DENMARK

**YS Copenhagen Liaison Office**  
Generatørvej 8B  
DK-2730 Herlev, Denmark  
Tel: 44 92 49 00

### FINLAND

**Warner Music Finland OY/Fazer Music**  
Aleksanterinkatu 11, P.O. Box 260  
SF-00101 Helsinki, Finland  
Tel: 0435 011

### NORWAY

**Narud Yamaha AS**  
Grini Næringspark 17  
N-1345 Østerås, Norway  
Tel: 67 14 47 90

### ICELAND

**Skifan HF**  
Skeifan 17 P.O. Box 8120  
IS-128 Reykjavik, Iceland  
Tel: 525 5000

### OTHER EUROPEAN COUNTRIES

**Yamaha Europa GmbH.**  
Siemensstraße 22-34, 25462 Rellingen, F.R. of  
Germany  
Tel: 04101-3030

## AFRICA

**Yamaha Corporation,  
International Marketing Division**  
Nakazawa-cho 10-1, Hamamatsu, Japan 430  
Tel: 053-460-2312

## MIDDLE EAST

### TURKEY/CYPRUS

**Yamaha Europa GmbH.**  
Siemensstraße 22-34, 25462 Rellingen,  
F.R. of Germany  
Tel: 04101-3030

### OTHER COUNTRIES

**Yamaha Corporation,  
International Marketing Division**  
Nakazawa-cho 10-1, Hamamatsu, Japan 430  
Tel: 053-460-2312

## ASIA

### HONG KONG

**Tom Lee Music Co., Ltd.**  
11/F., Silvercord Tower 1, 30 Canton Road,  
Tsimshatsui, Kowloon, Hong Kong  
Tel: 730-1098

### INDONESIA

**PT. Yamaha Music Indonesia (Distributor)  
PT. Nusantik**  
Gedung Yamaha Music Center, Jalan Jend. Gatot  
Subroto Kav. 4, Jakarta 12930, Indonesia  
Tel: 21-520-2577

### MALAYSIA

**Yamaha Music Malaysia, Sdn., Bhd.**  
16-28, Jalan SS 2/72, Petaling Jaya, Selangor,  
Malaysia  
Tel: 3-717-8977

### PHILIPPINES

**Yupango Music Corporation**  
339 Gil J. Puyat Avenue, P.O. Box 885 MCPO,  
Makati, Metro Manila, Philippines  
Tel: 819-7551

### SINGAPORE

**Yamaha Music Asia Pte., Ltd.**  
Blk 17A Toa Payoh #01-190 Lorong 7  
Singapore 1231  
Tel: 354-0133

### TAIWAN

**Kung Hsue She Trading Co., Ltd.**  
No. 322, Section 1, FuHsing S. Road,  
Taipei 106, Taiwan. R.O.C.  
Tel: 02-709-1266

### THAILAND

**Siam Music Yamaha Co., Ltd.**  
865 Phornprapha Building, Rama I Road,  
Patumwan, Bangkok 10330, Thailand  
Tel: 2-215-3443

### THE PEOPLE'S REPUBLIC OF CHINA AND OTHER ASIAN COUNTRIES

**Yamaha Corporation,  
International Marketing Division**  
Nakazawa-cho 10-1, Hamamatsu, Japan 430  
Tel: 053-460-2317

## OCEANIA

### AUSTRALIA

**Yamaha Music Australia Pty. Ltd.**  
17-33 Market Street, South Melbourne, Vic. 3205,  
Australia  
Tel: 3-699-2388

### NEW ZEALAND

**Music Houses of N.Z. Ltd.**  
146/148 Captain Springs Road, Te Papapa,  
Auckland, New Zealand  
Tel: 9-634-0099

### COUNTRIES AND TRUST TERRITORIES IN PACIFIC OCEAN

**Yamaha Corporation,  
International Marketing Division**  
Nakazawa-cho 10-1, Hamamatsu, Japan 430  
Tel: 053-460-2317

**HEAD OFFICE** Yamaha Corporation, Electronic Musical Instrument Division  
Nakazawa-cho 10-1, Hamamatsu, Japan 430  
Tel: 053-460-3273

