

**YAMAHA**

# *Digital Piano*

## **YDP-88**

### **Owner's Manual**

#### **IMPORTANT**

---

##### **Check Your Power Supply**

Make sure that your local AC mains voltage matches the voltage specified on the name plate on the bottom panel. In some areas a voltage selector may be provided on the bottom panel of the main keyboard unit near the power cord. Make sure that the voltage selector is set for the voltage in your area. A voltage selector is provided in some areas. The voltage selector is set at 220V when the unit is initially shipped. To change the setting use a "minus" screwdriver, coin, or similar implement to rotate the selector dial so that the correct voltage appears next to the pointer on the panel.

# Introduction

Thank you for choosing a Yamaha YDP-88 Digital Piano. Your YDP-88 is a fine musical instrument that employs advanced Yamaha music technology. With the proper care, your YDP-88 will give you many years of musical pleasure.

- Yamaha's AWM (Advanced Wave Memory) tone generator system offers rich, realistic voices.
- Touch-sensitive keys provide extensive expressive control and outstanding playability.
- Dual play mode allows 2 voices to be played simultaneously.
- Metronome feature with variable tempo facilitates practice.
- Record and play back anything you play on the keyboard (up to approximately 1,300 notes).

In order to make the most of your YDP-88's performance potential and features, we urge you to read this Owner's Manual thoroughly, and keep it in a safe place for later reference.

## Taking Care Of Your YDP-88

Your YDP-88 is a fine musical instrument, and deserves the most careful treatment. Observe the following points and your YDP-88 will sound and look great for many years.

- 1 Never open the case and touch or tamper with the internal circuitry.
  - 2 Always turn the POWER switch OFF after use, and cover the keyboard with the dust cover provided.
  - 3 Clean the cabinet and keys of your YDP-88 only with a clean, slightly damp cloth. A neutral cleanser may be used if desired. Never use abrasive cleansers, waxes, solvents or chemical dust cloths since these can dull or damage the finish.
  - 4 Never place any vinyl products on your YDP-88. Contact with vinyl can cause irreversible damage to the finish.
  - 5 Install your YDP-88 in a place that is away from direct sunlight, excessive humidity or heat.
  - 6 Never apply excessive force to the controls, connectors or other parts of your YDP-88, and avoid scratching or bumping it with hard objects.
  - 7 Make sure that your local AC mains voltage matches the voltage specified on the name plate on the bottom panel. In some areas a voltage selector may be provided on the bottom panel of the main keyboard unit near the power cord. Make sure that the voltage selector is set for the voltage in your area. The voltage selector is set at 220V when the unit is initially shipped. To change the setting use a "minus" screwdriver or similar implement to rotate the selector dial so that the correct voltage appears next to the pointer on the panel.
- **Name Plate Location**  
The YDP-88 name plate is located on the bottom panel.

## Contents

<b>The Control Panel</b> .....	2	<b>The Metronome &amp; Tempo Control</b> .....	8
<b>Selecting &amp; Playing Voices</b> .....	4	■ The Metronome .....	8
■ Playing the Demonstration Tunes .....	4	● Metronome Volume .....	8
<b>The Dual Mode</b> .....	5	● Metronome Time Signature .....	8
● Adjusting the Balance Between the Dual-mode Voices .....	5	■ Tempo Control .....	8
● Shifting a Dual-Mode Voice Up One Octave ..	5	<b>Using the Recorder</b> .....	9
<b>The Pedals</b> .....	6	■ Recording .....	9
● Soft/Sostenuto (Left) Pedal .....	6	● Changing the Initial Settings .....	10
● Damper (Right) Pedal .....	6	● Erasing the recorded data .....	10
<b>Transposition</b> .....	6	■ Playback .....	10
<b>Pitch Control</b> .....	7	● Fast Forward Playback .....	10
● Tuning Up .....	7	<b>Troubleshooting</b> .....	11
● Tuning Down .....	7	<b>Options</b> .....	11
● To Restore Standard Pitch .....	7	<b>Specifications</b> .....	11
		<b>Keyboard Stand Assembly</b> .....	12

# The Control Panel

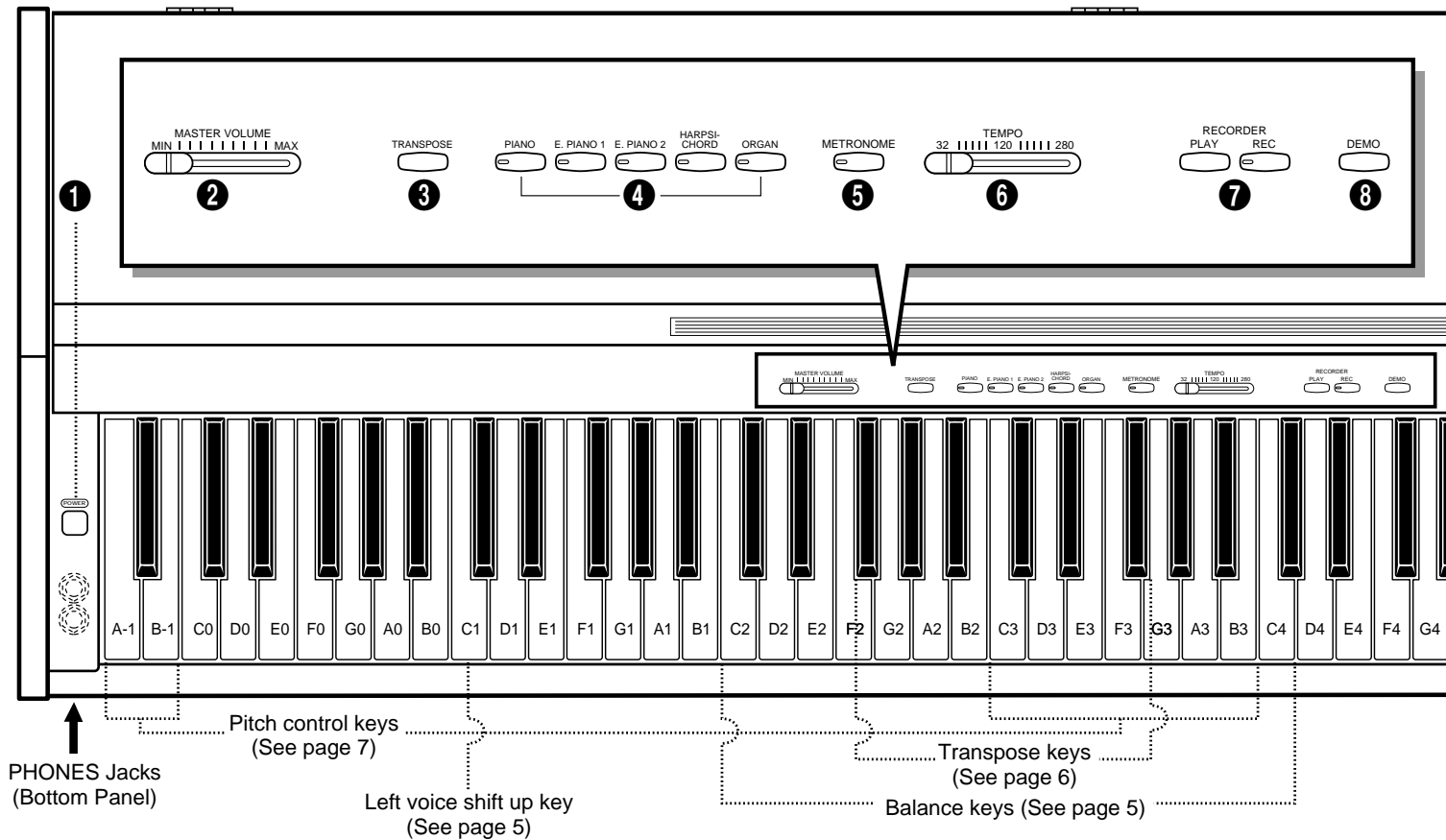

## 1 [POWER] Switch

Press the [POWER] switch once to turn the power ON, a second time to turn the power OFF. When the power is initially turned ON, the [PIANO] voice selector LED will light.

## 2 [MASTER VOLUME] Control

The [MASTER VOLUME] control adjusts the volume (level) of sound produced by the YDP-88's internal sound system. The [MASTER VOLUME] control also adjusts headphone volume when a pair of headphones is plugged into the PHONES jack.

## 3 [TRANPOSE] Button

The [TRANPOSE] button allows access to the YDP-88's TRANSPOSE function (to shift the pitch of the entire keyboard up or down). For details refer to "TRANSPOSITION" on page 6.

## 4 Voice Selectors

The YDP-88 has five voice selectors. Simply press any of the voice selectors to select the corresponding voice. The voice selector LED will light to indicate which voice is currently selected.

The YDP-88 also has a DUAL mode in which two voices can be played simultaneously across the full range of the keyboard — see page 5 for details.



- The PIANO voice is automatically selected whenever the [POWER] switch is initially turned ON.

## 5 [METRONOME] Button

Turns the metronome sound on and off. The [TEMPO] control, below, is used to set the tempo of the metronome sound. More precise tempo settings can be achieved by using the [METRONOME] button and the YDP-88 keyboard as described on page 8.

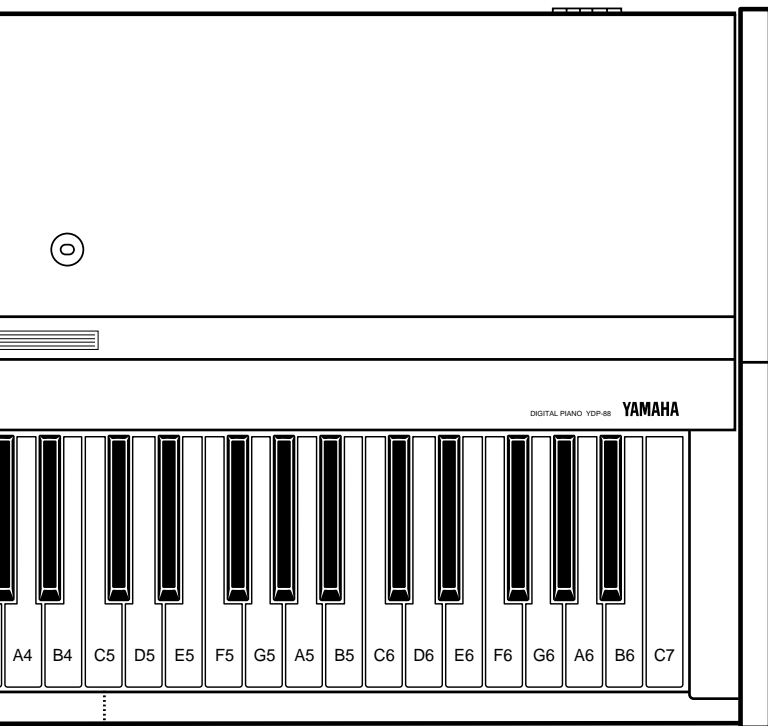

Right voice shift up key  
(See page 5)

## 6 [TEMPO] Control

This control adjusts the tempo of the YDP-88 metronome function as well as the playback tempo of the recorder function. The tempo range is from 32 to 280 quarter-note beats per minute.

## 7 RECORDER [PLAY] and [REC] Buttons

These buttons control the YDP-88 recorder, letting you record and play back just about anything you play on the keyboard — up to a maximum of about 1,300 notes. See page 9 for details.

## 8 [DEMO] Button

Activates the demo playback mode in which you can select playback of five pre-programmed demonstration sequences. See page 4 for details.

## 9 Pedals

The YDP-88's soft/sostenuto (left) and damper (right) pedals provide a range of expressive control capabilities similar to the pedal functions on an acoustic piano. See page 6 for details.

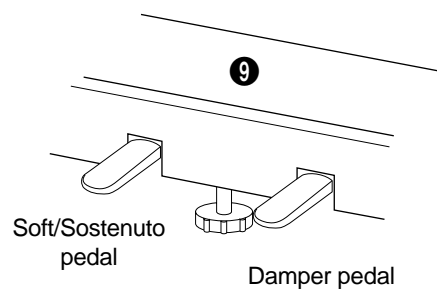

## ● The Music Stand

Insert the music stand pins into the corresponding holes in the YDP-88 top panel.

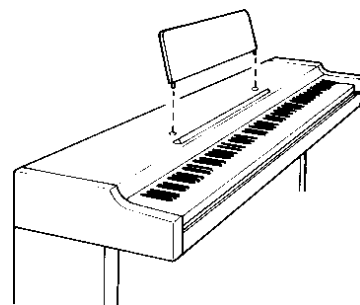

## ● PHONES Jacks (Bottom Panel)

Two pairs of standard pair of headphones can be plugged in here for private practice or late-night playing. The internal speaker system is automatically shut off when a pair of headphones is plugged into either of the PHONES jacks.

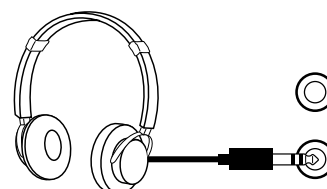



# Selecting & Playing Voices

## 1 Turn Power On

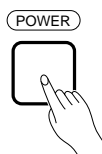

After making sure that the YDP-88's AC plug is properly inserted into a convenient AC wall outlet, press the **[POWER]** switch located to the left of the keyboard to turn the power ON. (In some areas a plug adaptor may be provided to match the pin configuration of the AC wall outlets in your area.)

When the power is turned ON, the **[PIANO]** voice selector LED will light (the PIANO voice is automatically selected whenever the power is turned ON).

## 2 Set the Volume

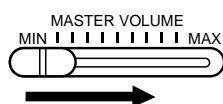

Initially set the **[MASTER VOLUME]** control about half way between the "MIN" and "MAX" settings. Then, when you start playing, re-adjust the **[MASTER VOLUME]** control for the most comfortable listening level.

## 3 Select a Voice

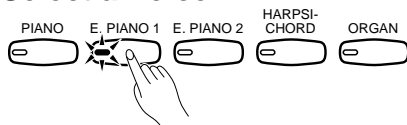

Select the desired voice by pressing one of the voice selectors.

## 4 Play

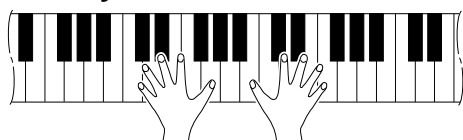

The YDP-88 offers keyboard touch response, so the volume and timbre of notes played can be controlled according to how "hard" you play the keys. The amount of variation available depends on the selected voice.

## Playing the Demonstration Tunes

The YDP-88 includes five demo tunes that effectively demonstrate its sound capabilities. Here's how you can select and play the demo tunes:

## 1 Engage the Demo Mode



Press the **[DEMO]** button to engage the demo mode — the voice selectors will flash in sequence.

## 2 Select a Demo Tune

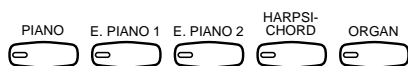

Press one of the flashing voice selectors to start playback of the corresponding demo tune — featuring the voice normally selected by that voice selector button. The demo tunes will play in sequence until stopped, starting with the selected tune. The voice selector indicator will flash during demo playback.

## 3 Set the Volume

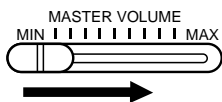

Use the **[MASTER VOLUME]** control to adjust the volume.

 **NOTE** • The **[TEMPO]** control does not affect demo playback.

## 4 Play a Different Demo

You can start playback of any other demo tune during playback by simply pressing the corresponding voice selector. Playback will stop and the playback-ready mode described in step 2, above, will be re-engaged if you press the voice selector of the demo that is currently playing.

## 5 Stop the Demo

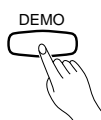

Press the **[DEMO]** button when you want to stop demo playback and return to the normal play mode.

### The Demo Tunes

- **[PIANO]** button: Piano Sonata A major K.V. 331 3rd movement "Turkischer Marsch" by W. A. Mozart
- **[E. PIANO 1]** button: "Pavane pour une infante défunte" by M. J. Ravel
- **[HARPSICHORD]** button: "The Harmonious Blacksmith" by G. F. Händel
- **[ORGAN]** button: Wedding March from "A Midsummer Night Dream" by J. L. F. Mendelssohn

\* The demonstration pieces listed above are short excerpts from the original compositions. The other demo tune is original (© 1994 by YAMAHA CORPORATION).



# The Dual Mode

The DUAL mode makes it possible to play two voices simultaneously across the entire range of the keyboard. To activate the DUAL mode simply press two voice selectors at the same time (or press one voice selector while holding another). The voice indicators of both selected voices will light when the DUAL mode is active. To return to the normal single-voice play mode, press any single voice selector.

## ● Adjusting the Balance Between the Dual-mode Voices

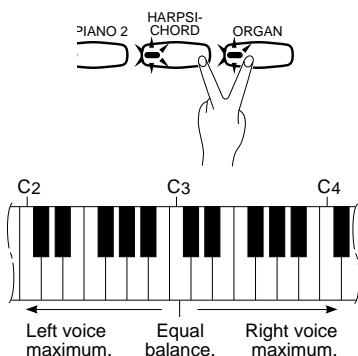

The volume levels of the two voices combined in the DUAL mode are normally set automatically to produce a pleasing balance (see “Default Settings” below). The balance can be adjusted manually by using the **C2** through **C4** keys on the keyboard while pressing the two voice selectors corresponding to the voices to be combined in the DUAL mode.

The **C3** key produces equal (50:50) balance between the two voices, while keys to the left of **C3** increase the volume of the left voice in relation to the right voice, and keys to the right of **C3** increase the volume of the right voice in relation to the left voice. By “left” and “right” voice we refer to the relative positions of the voice selectors — i.e. in a HARPSICHORD/ORGAN combination HARP-SICHORD is the left voice and ORGAN is the right voice.

### Default Settings

Voice Combinations	Balance keys
PIANO/ORGAN .....	E2
E. PIANO 1/ORGAN .....	F2
E. PIANO 2/ORGAN .....	E2
HARPSICHORD/ORGAN .....	G2

\* All other voice combinations are set to C3 (equal balance).

## ● Shifting a Dual-Mode Voice Up One Octave

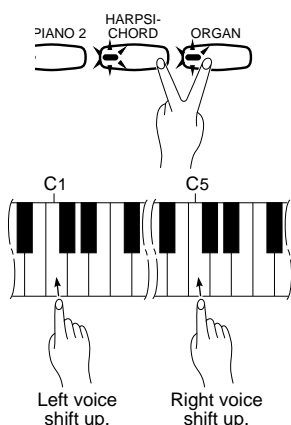

Depending on which voices you combine using the DUAL mode, the combination may sound better if one of the voices is shifted up an octave. To shift the right voice, press the **C5** key while pressing the two voice selectors corresponding to the voices to be combined in the DUAL mode. Press **C5** again to shift the voice back to its normal range. Use the **C1** key in the same way to shift the left voice.

All voice combinations are set to the same octave by default.

# The Pedals

The YDP-88 has two foot pedals that produce a range of expressive effects similar to those produced by the pedals on an acoustic piano.

## ● Soft/Sostenuto (Left) Pedal

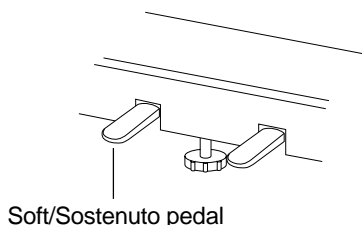

When the power is turned on the left pedal is set for soft pedal operation. Pressing the soft pedal reduces the volume and slightly changes the timbre of notes played.

The left pedal can be switched to sostenuto operation by pressing the pedal while holding the [TRANSDPOSE] button. If you play a note or chord on the keyboard and press the sostenuto pedal while the note(s) are held, those notes will be sustained as long as the pedal is held (as if the damper pedal had been pressed) but all subsequently played notes will not be sustained. This makes it possible to sustain a chord, for example, while other notes are played “staccato.” You can switch back to soft pedal operation at any time simply by pressing the pedal while holding the [TRANSDPOSE] button again.

## ● Damper (Right) Pedal

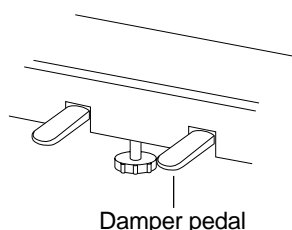

The damper pedal functions in the same way as a damper pedal on an acoustic piano. When the damper pedal is pressed notes played have a long sustain. Releasing the pedal immediately stops (damps) any sustained notes.

# Transposition

The YDP-88's TRANSDPOSE function makes it possible to shift the pitch of the entire keyboard up or down in semitone intervals up to a maximum of six semitones. “Transposing” the pitch of the YDP-88 keyboard facilitates playing in difficult key signatures, and you can easily match the pitch of the keyboard to the range of a singer or other instrumentalist.

The [TRANSDPOSE] button and keys **F#2** through **F#3** on the keyboard are used for transposition.

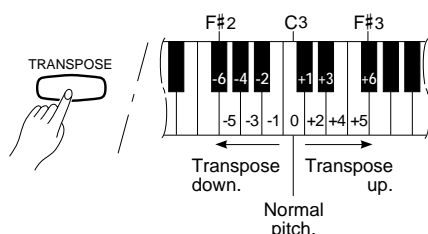

- 1** Press and hold the [TRANSDPOSE] button.
- 2** Press a key between **F#2** and **F#3** according to the desired amount of transposition.\*
- 3** Release the [TRANSDPOSE] button.

\* Pressing the **C3** key produces normal keyboard pitch. Pressing the key to the left of **C3** (**B2**) transposes the pitch of the keyboard down a semitone, the next key to the left (**Bb2**) transposes down a whole tone (two semitones), etc., down to the **F#2** key which transposes down 6 semitones. Upward transposition is accomplished in the same way using the keys to the right of **C3**, up to **F#3** which transposes up 6 semitones.



• Notes below and above the A-1 — C7 of the YDP-88 sound one octave higher and lower, respectively.



# Pitch Control

Pitch control makes it possible to tune the YDP-88 over a  $\pm 50$ -cent range (approximate) in approximately 1.6-cent intervals. A hundred "cents" equals one semitone, so the tuning range provided allows fine tuning of overall pitch over a range of approximately a semitone. Pitch control is useful for tuning the YDP-88 to match other instruments or recorded music.

## ● Tuning Up

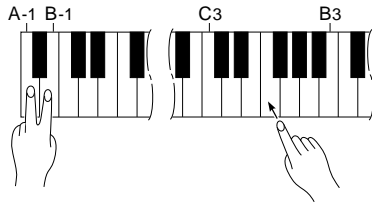

- 1** To tune up (raise pitch), hold the **A-1** and **B-1** keys simultaneously.
- 2** Press any key between **C3** and **B3**. Each time a key in this range is pressed the pitch is increased by approximately 1.6 cents, up to a maximum of 50 cents above standard pitch.
- 3** Release the **A-1** and **B-1** keys.

## ● Tuning Down

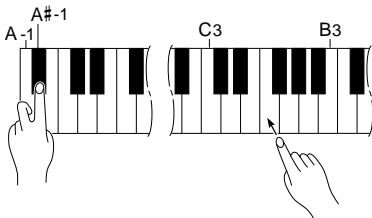

- 1** To tune down (lower pitch), hold the **A-1** and **A#-1** keys simultaneously.
- 2** Press any key between **C3** and **B3**. Each time a key in this range is pressed the pitch is decreased by approximately 1.6 cents, up to a maximum of 50 cents below standard pitch.
- 3** Release the **A-1** and **A#-1** keys.

## ● To Restore Standard Pitch\*

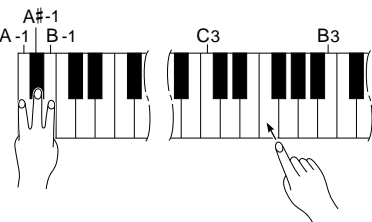

- 1** To restore standard pitch ( $A_3 = 440$  Hz), hold the **A-1**, **A#-1** and **B-1** keys simultaneously.
- 2** Press any key between **C3** and **B3**.
- 3** Release the **A-1**, **A#-1** and **B-1** keys.

\* Standard pitch ( $A_3 = 440$  Hz) is set when the [POWER] switch is initially turned ON.





# The Metronome & Tempo Control

The YDP-88 built-in metronome is a convenient feature for practice, and it can also provide a solid rhythmic guide when recording using the Recorder feature, described below.

## The Metronome



The metronome sound is turned on and off via the [METRONOME] button. Press the [METRONOME] button so that its indicator lights to turn the metronome on, then again so the indicator goes out to turn the metronome off.

### ● Metronome Volume

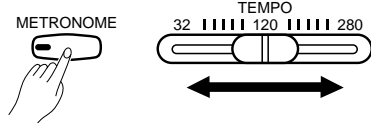

The volume of the metronome sound can be independently adjusted by using the [TEMPO] control while holding the [METRONOME] button. Sliding the control to the right increases the metronome volume.

### ● Metronome Time Signature

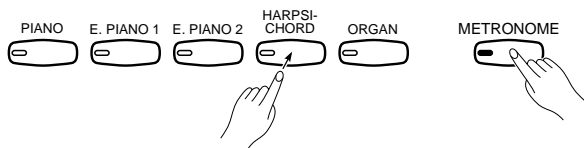

The time signature of the metronome sound can be set by pressing the appropriate voice selector button while holding the [METRONOME] button, as follows:

[METRONOME] + [PIANO]	No accent (default)
[METRONOME] + [E. PIANO 1]	2 time
[METRONOME] + [E. PIANO 2]	3 time
[METRONOME] + [HARPSICHORD]	4 time
[METRONOME] + [ORGAN]	6 time

## Tempo Control

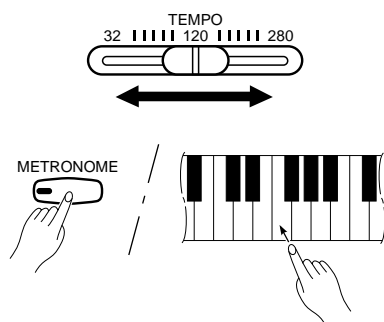

The tempo of the metronome and recorder playback can be controlled in two ways:

- Use the panel [TEMPO] control to set the required tempo from 32 to 280 quarter-note beats per minute.
- For more precise tempo settings press the appropriate key on the keyboard while holding the [METRONOME] button.

### Tempo/Key Chart

Key	Tempo	Key	Tempo	Key	Tempo	Key	Tempo	Key	Tempo	Key	Tempo	Key	Tempo	Key	Tempo
A-1	32	G#0	54	G1	76	F#2	98	F3	120	E4	142	D#5	168	D6	212
A#-1	34	A0	56	G#1	78	G2	100	F#3	122	F4	144	E5	172	D#6	216
B-1	36	A#0	58	A1	80	G#2	102	G3	124	F#4	146	F5	176	E6	220
C0	38	B0	60	A#1	82	A2	104	G#3	126	G4	148	F#5	180	F6	224
C#0	40	C1	62	B1	84	A#2	106	A3	128	G#4	150	G5	184	F#6	232
D0	42	C#1	64	C2	86	B2	108	A#3	130	A4	152	G#5	188	G6	240
D#0	44	D1	66	C#2	88	C3	110	B3	132	A#4	154	A5	192	G#6	248
E0	46	D#1	68	D2	90	C#3	112	C4	134	B4	156	A#5	196	A6	256
F0	48	E1	70	D#2	92	D3	114	C#4	136	C5	158	B5	200	A#6	264
F#0	50	F1	72	E2	94	D#3	116	D4	138	C#5	160	C6	204	B6	272
G0	52	F#1	74	F2	96	E3	118	D#4	140	D5	164	C#6	208	C7	280



# Using the Recorder

The YDP-88 recorder lets you record what you play on the keyboard and then play it back. This is a useful adjunct to any keyboard study program, since it lets you hear exactly how you sound from the listener's perspective. It can also be just plain fun.

The recorder actually records the following data:

- Notes played
- Voice selection
- Dual mode voices
- Dual balance
- Damper pedal
- Left pedal
- Tempo (Initial setting only.)

## Recording

### 1 Engage the Record Ready Mode

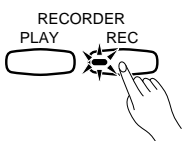

Press the **RECORDER [REC]** button to engage the record ready mode (recording does not actually start yet). The **[REC]** button indicator will light.

### 2 Make All Necessary Initial Settings

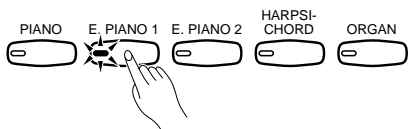

Before actually beginning to record, select the voice you want to record with (or voices if you will be using the dual mode). You might also want to set the volume and tempo controls.

### 3 Start Recording

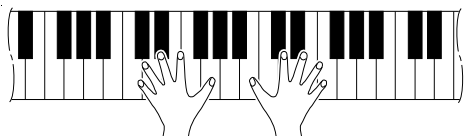

Recording will begin automatically as soon as you play a note on the keyboard or press the **[PLAY]** button.



- If the metronome was on when you started recording, you'll be able to keep time with the metronome while recording, but the metronome sound will not be recorded.
- You can record up to a maximum of about 1,300 notes, depending on pedal usage and other factors. The **[REC]** button indicator will begin to flash when recorder memory is almost full, and recording will stop automatically.

### 4 Stop Recording

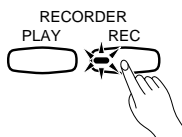

Press either the **RECORDER [REC]** or **[PLAY]** button to stop recording.

# Using the Recorder

## ● Changing the Initial Settings

The initial voice (including dual mode), damper pedal, soft pedal, and tempo settings made in step 2 of the recording procedure are actually recorded by the YDP-88. These initial settings can be changed after the recording is finished by pressing the **[REC]** button to engage the record ready mode, making the required changes, and then pressing the **[REC]** button again to exit from the record ready mode and register the changes. If you do this, be careful not to press the **[PLAY]** button or a key on the keyboard, either of which will start recording and erase all previous recorded data.

## ● Erasing the recorded data

The recorded data can be erased by first pressing the **[REC]** button to engage the record ready mode, and then pressing the **[PLAY]** button twice without recording any data.

## Playback

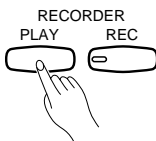

To play back what you've recorded, simply press the **RECORDER [PLAY]** button. Playback starts from the beginning of the recorded data, and will stop automatically at the end of the recorded data. You can also stop playback at any time by pressing the **[PLAY]** button.

### NOTE

- It is possible to play along on the keyboard during playback.
- The playback volume and tempo can be adjusted by using the **[MASTER VOLUME]** and **[TEMPO]** controls, respectively.
- If the metronome is being used during playback, the metronome will stop when playback is stopped.
- All recorder data will be erased when the YDP-88 power is turned off.

## ● Fast Forward Playback

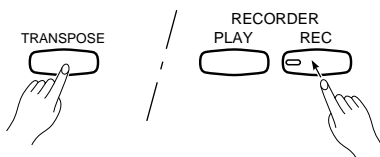

When you want to locate a specific point in a recording you can quickly move forward through the recording while monitoring the sound by pressing the **[REC]** button while holding the **[TRANSPOSE]** button.

# Troubleshooting

If you encounter what appears to be a malfunction, please check the following points before assuming that your YDP-88 is faulty.

## 1. No Sound When the Power is Turned ON

Is the AC plug properly connected to an AC wall outlet? Check the AC connection carefully. Is the MASTER VOLUME control turned up to a reasonable listening level?

## 2. The YDP-88 Reproduces Radio or TV Sound

This can occur if there is a high-power transmitter in your vicinity. Contact your Yamaha dealer.

## 3. Intermittent Static Noise

This is usually due to turning ON or OFF a household appliance or other electronic equipment which is fed by the same AC mains line as your YDP-88.

## 4. Interference Appears On Radio or TV Sets Located Near the YDP-88

The YDP-88 contains digital circuitry which can generate radio-frequency noise. The solution is to move the YDP-88 further away from the affected equipment, or vice versa.

# Options

### BC-8 Bench

A comfortable bench styled to match your Yamaha YDP-88.

### HPE-150 Stereo Headphones

High-performance lightweight dynamic headphones with extra-soft ear pads.

# Specifications

		YDP-88
KEYBOARD		88 KEYS (A-1 ~ C7)
POLYPHONY		28 NOTES MAX.
VOICE SELECTORS		PIANO, E. PIANO 1, E. PIANO 2, HARPSICHORD, ORGAN
RECORDER		PLAY, REC
PEDAL CONTROLS		SOFT/SOSTENUTO, DAMPER
OTHER CONTROLS		MASTER VOLUME, TEMPO, METRONOME, DEMO, TRANSPOSE
JACKS		PHONES x 2
MAIN AMPLIFIER		7W x 1
SPEAKER		16 cm x 1
DIMENSIONS (W x D x H)	Music stand down	1346.2 x 423.0 x 771.5 mm (53" x 16-5/8" x 30-3/8")
	Music stand up	1346.2 x 423.0 x 951.7 mm (53" x 16-5/8" x 37-1/2")
WEIGHT		31.5 kg (69.4 lbs.)

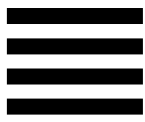

# Keyboard Stand Assembly

1

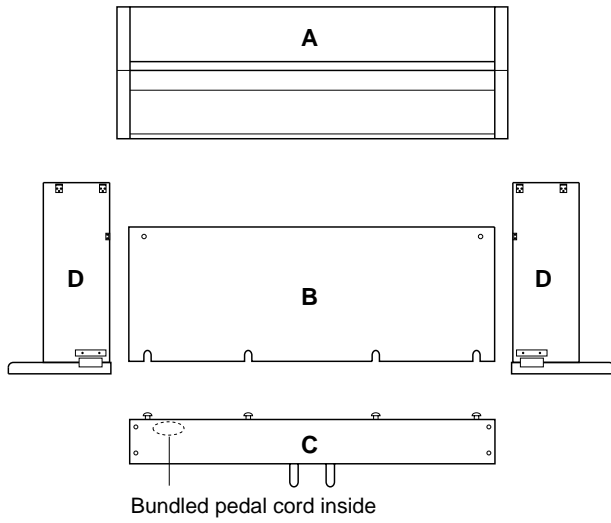

6 x 35 mm round-head screws x 4 ①



4 x 10 mm round-head screws x 2 ②



6 x 16 mm flat-head screws x 4 ③

2

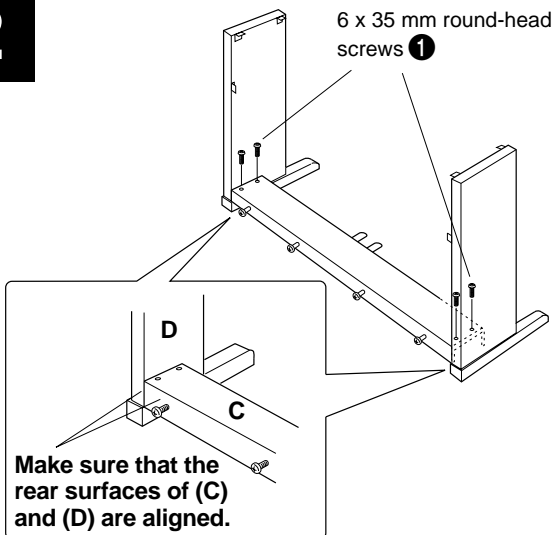

4

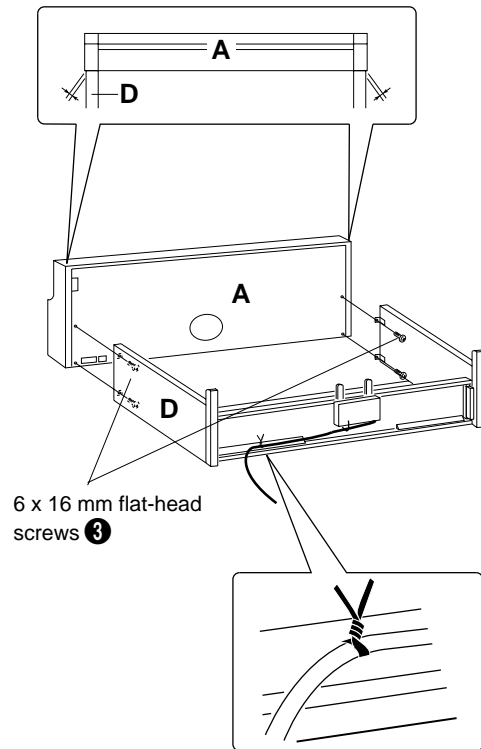

3

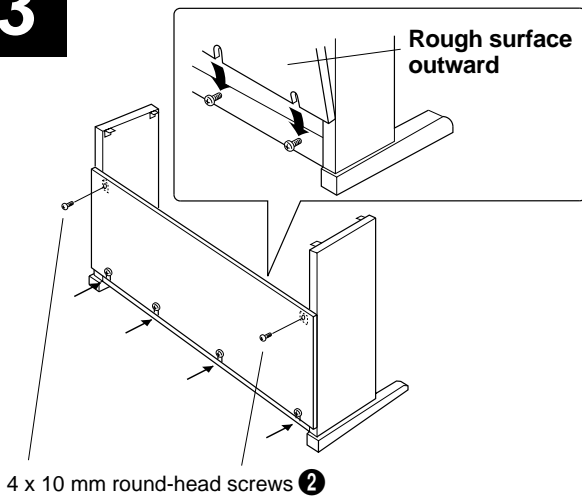

**5**

- A voltage selector is provided in some areas.

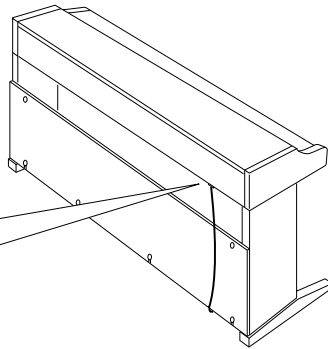
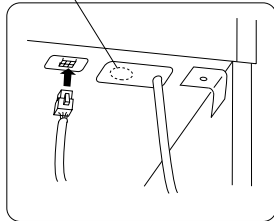
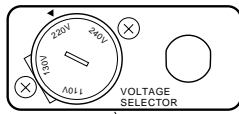
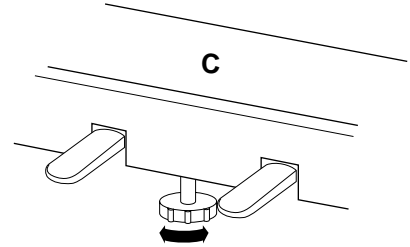
**6****NOTE**

- We do not recommend attempting to assemble the YDP-88 alone. The job can be easily accomplished, however, with only two people.
- Use only the screws provided or replacements of exactly the specified size. Using screws of the wrong size can result in damage to the instrument.

## 1 Open the box and remove all the parts.

On opening the box you should find the parts shown in the illustration above. Check to make sure that all the required parts are provided.

## 2 Attach the side panels (D) to the pedal box (C).

Place the pedal box on top of the wooden blocks attached to the side panels (D), align the rear surfaces, and attach using the four 6 x 35 millimeter round-head screws ① — two screws on each side. Make sure the pedals extend in the same direction as the feet.

## 3 Attach the rear panel (B).

With the rough surface of the rear panel facing outward and the panel angled slightly as shown in the illustration, lower it onto the screws protruding from the rear of the pedal box so that the screws fit into the corresponding slots in the lower edge of the rear panel. Then, while eliminating any gaps between the rear and side panels, secure the top of the rear panel to the side panel brackets using the two 4 x 10 millimeter round-head screws ②. Finally, tighten the screws holding the rear panel to the pedal box.

## 4 Install the main unit (A).

Lay the completed stand on its side as shown in the illustration. Stand the main unit (A) on its rear panel and position it so that the screw holes on the bottom panel are aligned with the brackets on the side panels of the stand. Also center the main unit so that it extends an equal dis-

tance from both sides of the stand, as shown in the illustration. When the stand and main unit are properly positioned, screw in and securely tighten the four 6 x 16 millimeter flat-head screws ③.

Untie and unravel the pedal cord which is coiled and attached to the bottom of the pedal box with a vinyl tie, extend the cord and re-fasten it to the bottom of the pedal box with the vinyl tie (see illustration).

## 5 Connect the pedal cord.

Raise the completed keyboard and stand assembly to its normal playing position. Pass the pedal cord behind the rear panel and plug the free end of the cord into the connector on the bottom of the main unit (A). The plug only goes in one way (the lug on the connector should face the rear of the main unit, as shown in the illustration) — don't try to force it in the wrong way around.

**NOTE**

- A voltage selector is provided in some areas. To set the selector for 110V, 130V, 220V or 240V mains voltages, use a "minus" screwdriver or similar implement to rotate the selector dial so that the correct voltage appears next to the pointer on the panel.

## 6 Set the adjuster.

For stability, an adjuster is provided on the bottom of the pedal box (C). Rotate the adjuster until it comes in firm contact with the floor surface. The adjuster ensures stable pedal operation and facilitates pedal effect control. If the adjuster is not in firm contact with the floor surface, distorted sound may result.

**IMPORTANT**

- After assembling the YDP-88, check once more to make sure that all screws have been securely fastened.
- If the stand leans to the side, makes unusual noises, or otherwise seems unstable during use, check and tighten all screws while following the assembly instructions given above.

# SPECIAL MESSAGE SECTION

**IMPORTANT NOTICE:** All Yamaha electronic products are tested in order that you may be sure that when it is properly installed and used in its normal and customary manner, all foreseeable risks have been eliminated. DO NOT modify this unit or commission others to do so unless specifically authorized by Yamaha. Product performance and/or safety standards may be diminished. Claims filed under the expressed warranty may be denied if the unit is/has been modified. Implied warranties may also be affected.

**SPECIFICATIONS SUBJECT TO CHANGE:** The information contained in this manual is believed to be correct at the time of printing. However, Yamaha reserves the right to change or modify any of the specifications without notice or obligation to update existing units.

**ENVIRONMENTAL ISSUES:** Yamaha strives to produce products that are both user safe and environmentally friendly. We sincerely believe that our products and the production methods used to produce them, meet these goals. In keeping with both the letter and the spirit of the law, we want you to be aware of the following:

**Disposal Notice:** Should this product become damaged beyond repair, or for some reason its useful life is considered to be at an end, please observe all local, state, and federal regulations that relate to the disposal of products that contain lead, batteries, plastics, etc.

**NOTICE:** Service charges incurred due to lack of knowledge relating to how a function or effect works (when the unit is operating as

designed) are not covered by the manufacturer's warranty, and are therefore the owners responsibility. Please study this manual carefully and consult your dealer before requesting service.

**NAME PLATE LOCATION:** The graphic below indicates the location of the name plate. The model number, serial number, power requirements, etc., are located on this plate. You should record the model number, serial number, and the date of purchase in the spaces provided below and retain this manual as a permanent record of your purchase.

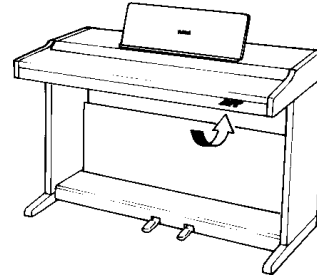

Model \_\_\_\_\_

Serial No. \_\_\_\_\_

Purchase Date \_\_\_\_\_

## IMPORTANT SAFETY INSTRUCTIONS

### INFORMATION RELATING TO PERSONAL INJURY, ELECTRICAL SHOCK, AND FIRE HAZARD POSSIBILITIES HAS BEEN INCLUDED IN THIS LIST.

**WARNING-** When using any electrical or electronic product, basic precautions should always be followed. These precautions include, but are not limited to, the following:

1. Read all Safety Instructions, Installation Instructions, Special Message Section items, and any Assembly Instructions found in this manual BEFORE marking any connections, including connection to the main supply.
2. Main Power Supply Verification: Yamaha products are manufactured specifically for the supply voltage in the area where they are to be sold. If you should move, or if any doubt exists about the supply voltage in your area, please contact your dealer for supply voltage verification and (if applicable) instructions. The required supply voltage is printed on the name plate. For name plate location, please refer to the graphic found in the Special Message Section of this manual.
3. **WARNING:** Do not place this product or any other objects on the power cord or place it in a position where anyone could walk on, trip over, or roll anything over power or connecting cords of any kind. The use of an extension cord is not recommended! If you must use an extension cord, the minimum wire size for a 25' cord (or less) is 18 AWG. NOTE: The smaller the AWG number, the larger the current handling capacity. For longer extension cords, consult a local electrician.
4. Ventilation: Electronic products, unless specifically designed for enclosed installations, should be placed in locations that do not interfere with proper ventilation. If instructions for enclosed installations are not provided, it must be assumed that unobstructed ventilation is required.
5. Temperature considerations: Electronic products should be installed in locations that do not significantly contribute to their operating temperature. Placement of this product close to heat sources such as; radiators, heat registers and other devices that produce heat should be avoided.
6. This product was NOT designed for use in wet/damp locations and should not be used near water or exposed to rain. Examples of wet/damp locations are; near a swimming pool, spa, tub, sink, or wet basement.

7. This product should be used only with the components supplied or; a cart, rack, or stand that is recommended by the manufacturer. If a cart, rack, or stand is used, please observe all safety markings and instructions that accompany the accessory product.
8. The power supply cord (plug) should be disconnected from the outlet when electronic products are to be left unused for extended periods of time. Cords should also be disconnected when there is a high probability of lightning and/or electrical storm activity.
9. Care should be taken that objects do not fall and liquids are not spilled into the enclosure through any openings that may exist.
10. Electrical/electronic products should be serviced by a qualified service person when:
  - a. The power supply cord has been damaged; or
  - b. Objects have fallen, been inserted, or liquids have been spilled into the enclosure through openings; or
  - c. The product has been exposed to rain; or
  - d. The product does not operate, exhibits a marked change in performance; or
  - e. The product has been dropped, or the enclosure of the product has been damaged.
11. Do not attempt to service this product beyond that described in the user-maintenance instructions. All other servicing should be referred to qualified service personnel.
12. This product, either alone or in combination with headphones, may be capable of producing sound levels that could cause permanent hearing loss. DO NOT operate for a long period of time at a high volume level or at a level that is uncomfortable. If you experience any hearing loss or ringing in the ears, you should consult an audiologist.

**IMPORTANT:** The louder the sound, the shorter the time period before damage occurs.
13. Some Yamaha products may have benches and/or accessory mounting fixtures that are either supplied as a part of the product or as optional accessories. Some of these items are designed to be dealer assembled or installed. Please make sure that benches are stable and any optional fixtures (where applicable) are well secured BEFORE using. Benches supplied by Yamaha are designed for seating only. No other uses are recommended.

## PLEASE KEEP THIS MANUAL

---

**HEAD OFFICE** Yamaha Corporation, International Marketing Division  
Nakazawa-cho 10-1, Hamamatsu, Japan 430  
Tel: 053-460-2317

**YAMAHA**  
YAMAHA CORPORATION

M.D.G., EMI Division © Yamaha Corporation 1995

[CL] YDP-88

Printed in Indonesia