



DIGITAL PIANO
P-85/85S

ENGLISH

DEUTSCH

FRANÇAIS

ESPAÑOL

Owner's Manual
Bedienungsanleitung
Mode d'emploi
Manual de instrucciones

EN
DE
FR
ES

SPECIAL MESSAGE SECTION

This product utilizes batteries or an external power supply (adapter). DO NOT connect this product to any power supply or adapter other than one described in the manual, on the name plate, or specifically recommended by Yamaha.

WARNING: Do not place this product in a position where anyone could walk on, trip over, or roll anything over power or connecting cords of any kind. The use of an extension cord is not recommended! If you must use an extension cord, the minimum wire size for a 25' cord (or less) is 18 AWG. NOTE: The smaller the AWG number, the larger the current handling capacity. For longer extension cords, consult a local electrician.

This product should be used only with the components supplied or; a cart, rack, or stand that is recommended by Yamaha. If a cart, etc., is used, please observe all safety markings and instructions that accompany the accessory product.

SPECIFICATIONS SUBJECT TO CHANGE:

The information contained in this manual is believed to be correct at the time of printing. However, Yamaha reserves the right to change or modify any of the specifications without notice or obligation to update existing units.

This product, either alone or in combination with an amplifier and headphones or speaker/s, may be capable of producing sound levels that could cause permanent hearing loss. DO NOT operate for long periods of time at a high volume level or at a level that is uncomfortable. If you experience any hearing loss or ringing in the ears, you should consult an audiologist.

IMPORTANT: The louder the sound, the shorter the time period before damage occurs.

Some Yamaha products may have benches and / or accessory mounting fixtures that are either supplied with the product or as optional accessories. Some of these items are designed to be dealer assembled or installed. Please make sure that benches are stable and any optional fixtures (where applicable) are well secured BEFORE using.

Benches supplied by Yamaha are designed for seating only. No other uses are recommended.

NOTICE:

Service charges incurred due to a lack of knowledge relating to how a function or effect works (when the unit is operating as designed) are not covered by the manufacturer's warranty, and are therefore the owners responsibility. Please study this manual carefully and consult your dealer before requesting service.

ENVIRONMENTAL ISSUES:

Yamaha strives to produce products that are both user safe and environmentally friendly. We sincerely believe that our products and the production methods used to produce them, meet these goals. In keeping with both the letter and the spirit of the law, we want you to be aware of the following:

Battery Notice:

This product MAY contain a small non-rechargeable battery which (if applicable) is soldered in place. The average life span of this type of battery is approximately five years. When replacement becomes necessary, contact a qualified service representative to perform the replacement.

This product may also use "household" type batteries. Some of these may be rechargeable. Make sure that the battery being charged is a rechargeable type and that the charger is intended for the battery being charged.

When installing batteries, do not mix batteries with new, or with batteries of a different type. Batteries MUST be installed correctly. Mismatches or incorrect installation may result in overheating and battery case rupture.

Warning:

Do not attempt to disassemble, or incinerate any battery. Keep all batteries away from children. Dispose of used batteries promptly and as regulated by the laws in your area. Note: Check with any retailer of household type batteries in your area for battery disposal information.

Disposal Notice:

Should this product become damaged beyond repair, or for some reason its useful life is considered to be at an end, please observe all local, state, and federal regulations that relate to the disposal of products that contain lead, batteries, plastics, etc. If your dealer is unable to assist you, please contact Yamaha directly.

NAME PLATE LOCATION:

The name plate is located on the bottom of the product. The model number, serial number, power requirements, etc., are located on this plate. You should record the model number, serial number, and the date of purchase in the spaces provided below and retain this manual as a permanent record of your purchase.

Model

Serial No.

Purchase Date

PLEASE KEEP THIS MANUAL

FCC INFORMATION (U.S.A.)

1. IMPORTANT NOTICE: DO NOT MODIFY THIS UNIT!

This product, when installed as indicated in the instructions contained in this manual, meets FCC requirements. Modifications not expressly approved by Yamaha may void your authority, granted by the FCC, to use the product.

2. IMPORTANT:

When connecting this product to accessories and/or another product use only high quality shielded cables. Cable/s supplied with this product MUST be used. Follow all installation instructions. Failure to follow instructions could void your FCC authorization to use this product in the USA.

3. NOTE:

This product has been tested and found to comply with the requirements listed in FCC Regulations, Part 15 for Class "B" digital devices. Compliance with these requirements provides a reasonable level of assurance that your use of this product in a residential environment will not result in harmful interference with other electronic devices. This equipment generates/uses radio frequencies and, if not installed and used according to the instructions found in the users manual, may cause interference harmful to the operation of other electronic devices. Compliance with FCC regulations does

not guarantee that interference will not occur in all installations. If this product is found to be the source of interference, which can be determined by turning the unit "OFF" and "ON", please try to eliminate the problem by using one of the following measures:

Relocate either this product or the device that is being affected by the interference.

Utilize power outlets that are on different branch (circuit breaker or fuse) circuits or install AC line filter/s.

In the case of radio or TV interference, relocate/reorient the antenna. If the antenna lead-in is 300 ohm ribbon lead, change the lead-in to co-axial type cable.

If these corrective measures do not produce satisfactory results, please contact the local retailer authorized to distribute this type of product. If you can not locate the appropriate retailer, please contact Yamaha Corporation of America, Electronic Service Division, 6600 Orangethorpe Ave, Buena Park, CA90620

The above statements apply ONLY to those products distributed by Yamaha Corporation of America or its subsidiaries.

* This applies only to products distributed by YAMAHA CORPORATION OF AMERICA.

(class B)

OBSERVERA!

Apparaten kopplas inte ur växelströmskällan (nätet) så länge som den är ansluten till vägguttaget, även om själva apparaten har stängts av.

ADVARSEL: Netspændingen til dette apparat er IKKE afbrudt, så længe netledningen sidder i en stikkontakt, som er t endt — også selvom der er slukket på apparatets afbryder.

VAROITUS: Laitteen toisiopiiriin kytketty käyttökytökin ei irroita koko laitetta verkosta.

(standby)

IMPORTANT NOTICE FOR THE UNITED KINGDOM Connecting the Plug and Cord

IMPORTANT. The wires in this mains lead are coloured in accordance with the following code:

BLUE : NEUTRAL
BROWN : LIVE

As the colours of the wires in the mains lead of this apparatus may not correspond with the coloured markings identifying the terminals in your plug proceed as follows:

The wire which is coloured BLUE must be connected to the terminal which is marked with the letter N or coloured BLACK.

The wire which is coloured BROWN must be connected to the terminal which is marked with the letter L or coloured RED.

Making sure that neither core is connected to the earth terminal of the three pin plug.

• This applies only to products distributed by Yamaha-Kemble Music (U.K.) Ltd.

(2 wires)

PRECAUTIONS

PLEASE READ CAREFULLY BEFORE PROCEEDING

* Please keep this manual in a safe place for future reference.



WARNING

Always follow the basic precautions listed below to avoid the possibility of serious injury or even death from electrical shock, short-circuiting, damages, fire or other hazards. These precautions include, but are not limited to, the following:

Power supply/AC power adaptor

- Only use the voltage specified as correct for the instrument. The required voltage is printed on the name plate of the instrument.
- Use the specified adaptor (PA-5D, PA-150 or an equivalent recommended by Yamaha) only. Using the wrong adaptor can result in damage to the instrument or overheating.
- Check the electric plug periodically and remove any dirt or dust which may have accumulated on it.
- Do not place the AC adaptor cord near heat sources such as heaters or radiators, and do not excessively bend or otherwise damage the cord, place heavy objects on it, or place it in a position where anyone could walk on, trip over, or roll anything over it.

Do not open

- Do not open the instrument or attempt to disassemble the internal parts or modify them in any way. The instrument contains no user-serviceable parts. If it should appear to be malfunctioning, discontinue use immediately and have it inspected by qualified Yamaha service personnel.

Water warning

- Do not expose the instrument to rain, use it near water or in damp or wet conditions, or place containers on it containing liquids which might spill into any openings. If any liquid such as water seeps into the instrument, turn off the power immediately and unplug the power cord from the AC outlet. Then have the instrument inspected by qualified Yamaha service personnel.
- Never insert or remove an electric plug with wet hands.

Fire warning

- Do not put burning items, such as candles, on the unit. A burning item may fall over and cause a fire.

If you notice any abnormality

- If the AC adaptor cord or plug becomes frayed or damaged, or if there is a sudden loss of sound during use of the instrument, or if any unusual smells or smoke should appear to be caused by it, immediately turn off the power switch, disconnect the adaptor plug from the outlet, and have the instrument inspected by qualified Yamaha service personnel.



CAUTION

Always follow the basic precautions listed below to avoid the possibility of physical injury to you or others, or damage to the instrument or other property. These precautions include, but are not limited to, the following:

Power supply/AC power adaptor

- When removing the electric plug from the instrument or an outlet, always hold the plug itself and not the cord.
- Unplug the AC power adaptor when not using the instrument, or during electrical storms.
- Do not connect the instrument to an electrical outlet using a multiple-connector. Doing so can result in lower sound quality, or possibly cause overheating in the outlet.

Location

- Do not expose the instrument to excessive dust or vibrations, or extreme cold or heat (such as in direct sunlight, near a heater, or in a car during the day) to prevent the possibility of panel disfiguration or damage to the internal components.
- Do not use the instrument in the vicinity of a TV, radio, stereo equipment, mobile phone, or other electric devices. Otherwise, the instrument, TV, or radio may generate noise.

- Do not place the instrument in an unstable position where it might accidentally fall over.
- Before moving the instrument, remove all connected adaptor and other cables.
- When setting up the product, make sure that the AC outlet you are using is easily accessible. If some trouble or malfunction occurs, immediately turn off the power switch and disconnect the plug from the outlet. Even when the power switch is turned off, electricity is still flowing to the product at the minimum level. When you are not using the product for a long time, make sure to unplug the power cord from the wall AC outlet.
- Use only the stand specified for the instrument. When attaching the stand or rack, use the provided screws only. Failure to do so could cause damage to the internal components or result in the instrument falling over.

Connections

- Before connecting the instrument to other electronic components, turn off the power for all components. Before turning the power on or off for all components, set all volume levels to minimum. Also, be sure to set the volumes of all components at their minimum levels and gradually raise the volume controls while playing the instrument to set the desired listening level.

Maintenance

- When cleaning the instrument, use a soft, dry cloth. Do not use paint thinners, solvents, cleaning fluids, or chemical-impregnated wiping cloths.

Handling caution

- Do not insert a finger or hand in any gaps on the instrument.
- Never insert or drop paper, metallic, or other objects into the gaps on the panel or keyboard. If this happens, turn off the power immediately and unplug the power cord from the AC outlet. Then have the instrument inspected by qualified Yamaha service personnel.
- Do not place vinyl, plastic or rubber objects on the instrument, since this might discolor the panel or keyboard.
- Do not rest your weight on, or place heavy objects on the instrument, and do not use excessive force on the buttons, switches or connectors.
- Do not use the instrument/device or headphones for a long period of time at a high or uncomfortable volume level, since this can cause permanent hearing loss. If you experience any hearing loss or ringing in the ears, consult a physician.

Saving data

Saving and backing up your data

- Some data will be saved to internal memory of the instrument. The data is maintained even when the power is turned off. Saved data may be lost due to malfunction or incorrect operation. Save important data to a computer (page 27).

Yamaha cannot be held responsible for damage caused by improper use or modifications to the instrument, or data that is lost or destroyed.

Always turn the power off when the instrument is not in use.

Even when the power switch is in the "STANDBY" position, electricity is still flowing to the instrument at the minimum level. When you are not using the instrument for a long time, make sure you unplug the AC power adaptor from the wall AC outlet.

Introduction

*Thank you for purchasing the Yamaha P-85/P-85S!
We recommend that you read this manual carefully
so that you can fully take advantage of the advanced and
convenient functions of the P-85/P-85S.
We also recommend that you keep this manual in a safe and
handy place for future reference.*

Main Features

■ Graded Hammer Standard Keyboard

Thanks to our experience as the world's leading manufacturer of acoustic pianos, we've developed a keyboard with action that's virtually indistinguishable from the real thing. Just as on a traditional acoustic piano, the keys of the lower notes have a heavier touch, while the higher ones are more responsive to lighter playing. The keyboard's sensitivity can even be adjusted to match your playing style. This Graded Hammer technology also enables the P-85 to provide authentic touch in a lightweight instrument.

■ AWM Stereo Sampling

The Yamaha P-85 offers unmatched sonic realism and natural grand-piano type playability as well as Yamaha's original "AWM Stereo Sampling" tone-generation technology for rich, musical voices.

In particular, the Grand Piano 1 and 2 voices feature samples painstakingly recorded from a full concert grand piano, while the Electric Piano 1 and 2 voice features multiple samples for different velocities (Dynamic Sampling); in other words, it uses different samples depending on the strength of your playing.

About this Owner's Manual

The documentation for this instrument includes: Owner's Manual (this document), Quick Operation Guide, and Data List.

■ Owner's Manual

● Introduction (page 6):

Please read this section first.

● Reference (page 14):

This section explains how to make detailed settings for the instrument's various functions.

● Appendix (page 34):

This section features a variety of essential, detailed information on the instrument.

■ Quick Operation Guide

This explains the button/key assignments of the instrument and how to use them.

■ Data List

The Data List contains MIDI related information. The Data List is available for downloading from the Yamaha Manual Library.

Yamaha Manual Library

<http://www.yamaha.co.jp/manual/>

- * The illustrations as shown in this owner's manual are for instructional purposes only, and may appear somewhat different from those on your instrument.
- * Copying of the commercially available musical data including but not limited to MIDI data and/or audio data is strictly prohibited except for your personal use.
- * For the sake of simplicity, both models P-85 and P-85S are hereafter referred to in this Owner's Manual as P-85.

This product incorporates and bundles computer programs and contents in which Yamaha owns copyrights or with respect to which it has license to use others' copyrights. Such copyrighted materials include, without limitation, all computer software, style files, MIDI files, WAVE data, musical scores and sound recordings. Any unauthorized use of such programs and contents outside of personal use is not permitted under relevant laws. Any violation of copyright has legal consequences. DON'T MAKE, DISTRIBUTE OR USE ILLEGAL COPIES.

- The company names and product names in this Owner's Manual are the trademarks or registered trademarks of their respective companies.

Accessories

• Owner's Manual

This manual contains complete instructions for operating your instrument.

• Quick Operation Guide

• Music Rest

• Pedal (FC5)

• AC Power Adaptor (PA-5D, PA-150 or an equivalent*)

* May not be included depending on your particular area. Please check with your Yamaha dealer.

Table of Contents

Introduction

Main Features.....	6
About this Owner's Manual	7
Accessories	7
Application Index.....	9
Panel Controls and Terminals.....	10
Before Using.....	11
Turning the Power On	11
Setting the Volume.....	11
Using the Pedal.....	12
Using Headphones	13
Music Rest.....	13

Reference

Listening to the Demo Songs	14
Listening to the Piano Preset Songs.....	15
Using the Metronome.....	16
Selecting & Playing Voices.....	18
Selecting Voices	18
Combining Voices (Dual).....	19
Adding Variations to the Sound – Reverb	20
Transposition.....	21
Fine tuning of the Pitch.....	21
Touch Sensitivity	22
Recording Your Performance	23
Recording a performance.....	23
Play back the recorded performance	24
Changing the Initial Settings (Data recorded at the beginning of a song)	25
Connecting MIDI Instruments	26
Connecting MIDI [IN] [OUT] terminals	26
MIDI Capabilities.....	26
Connecting a Personal Computer	27
Transferring Data between the Computer and the Instrument.....	27
MIDI Functions	28
MIDI Transmit/Receive Channel Selection	28
Local Control ON/OFF	28
Program Change ON/OFF	29
Control Change ON/OFF	30
Troubleshooting.....	31
Optional Equipment.....	31
Index.....	32

Appendix

Preset Song List.....	34
Specifications	35

Application Index

Use this index to find reference pages that may be helpful for your particular application and situation.

Listening

Listening to demo songs with different voices..... Listening to the Demo Songs on page 14

Listening to piano preset songs Listening to the Piano Preset Songs on page 15

Playing

Using the sustain pedal Using the Pedal on page 12

Changing the key of the P-85 to facilitate playing in difficult/unfamiliar key signatures Transposition on page 21

Fine tuning the pitch of the entire instrument when you play the instrument along with other instruments or CD music

..... Fine tuning of the Pitch on page 21

Selecting a touch sensitivity type..... Touch Sensitivity on page 22

Using a built-in metronome Using the Metronome on page 16

Changing voices

Viewing the list of voices Selecting Voices on page 18

Simulating a concert hall Adding Variations to the Sound – Reverb on page 20

Combining two voices Combining Voices (Dual) on page 19

Recording

Recording your performance..... Recording Your Performance on page 23

Connecting the P-85 to other devices

What is MIDI? About MIDI on page 26

Connecting a computer Connecting a Personal Computer on page 27

Panel Controls and Terminals

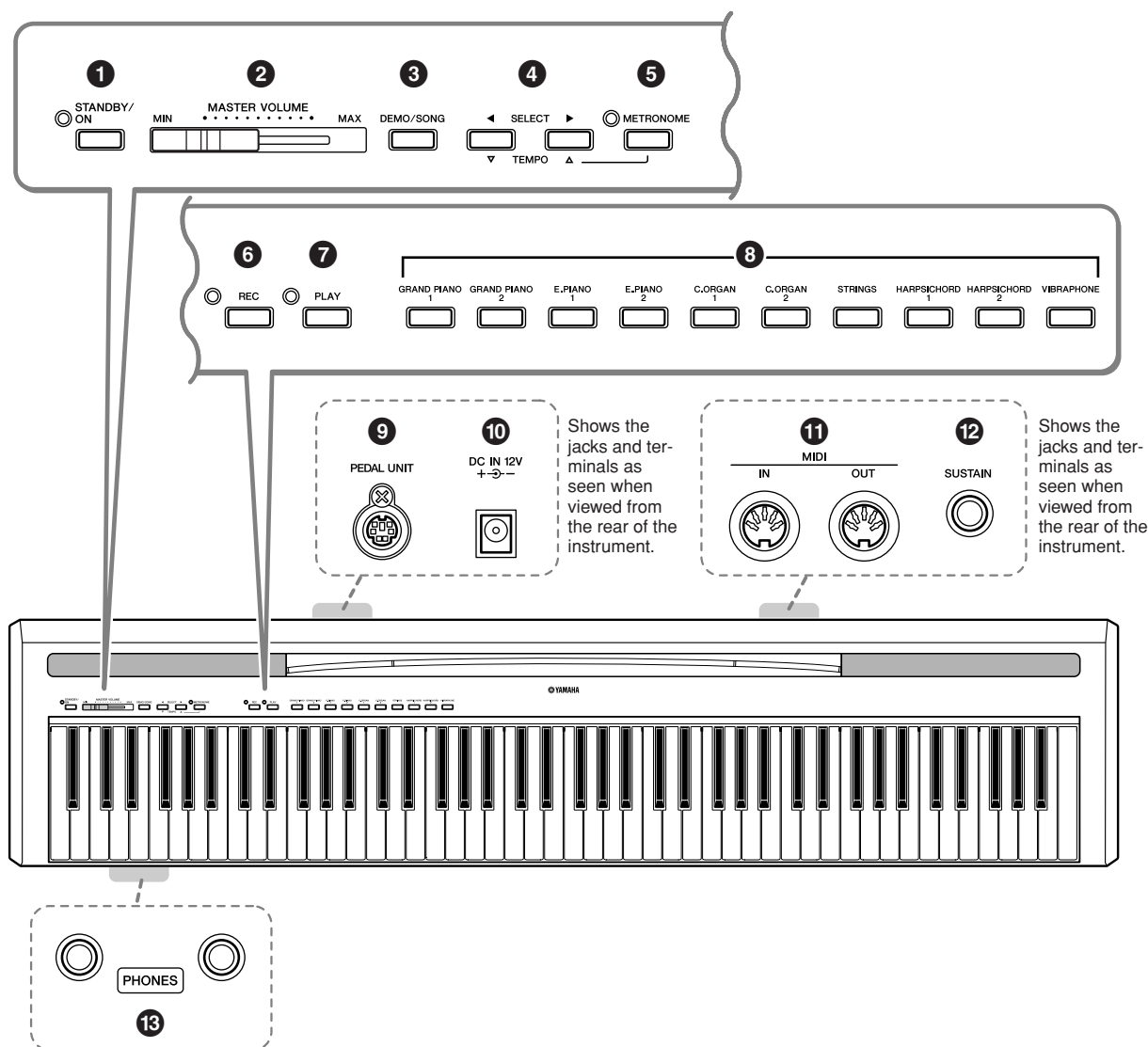

ENGLISH

- 1 [STANDBY/ON] switch** page 11
For turning the power on or off.
- 2 [MASTER VOLUME] slider** page 11
For adjusting the volume level of the entire sound.
- 3 [DEMO/SONG] button** pages 14, 15
For playing the demo songs and the piano preset songs.
- 4 SELECT [◀] [▶]/TEMPO [▽] [△] buttons** pages 14, 15
While playing a voice demo or piano preset song, pressing these buttons lets you select the next or previous song. These buttons can also be used to change the song tempo.
- 5 [METRONOME] button**..... page 16
For using the metronome.
- 6 [REC] button** page 23
For recording your keyboard performance.
- 7 [PLAY] button** page 24
For playing back the recorded performance.
- 8 VOICE buttons** page 18
For selecting voices from 10 internal sounds including Grand Piano 1 and 2. You can also combine two voices and use them together.
- 9 [PEDAL UNIT] jack**..... page 12
For connecting an optional pedal unit (LP-5).
- 10 [DC IN 12V] jack**..... page 11
For connecting the power adaptor.
- 11 MIDI [IN] [OUT] terminals** page 26
For connecting external MIDI devices, allowing the use of various MIDI functions.
- 12 [SUSTAIN] jack** page 12
For connecting an included pedal (FC5), optional FC3 foot pedal or FC4 foot switch.
- 13 [PHONES] jack**..... page 13
For connecting a set of standard stereo headphones, allowing private practice.

Before Using

Turning the Power On

1. Connect the AC adaptor to the power supply jack.
2. Plug the AC adaptor into an AC outlet.

⚠ WARNING

Use **ONLY** a Yamaha PA-5D/PA-150 AC Power Adaptor (or other adaptor specifically recommended by Yamaha) to power your instrument from the AC mains. The use of other adaptors may result in irreparable damage to both the adaptor and the P-85.

⚠ CAUTION

Unplug the AC Power Adaptor when not using the instrument, or during electrical storms.

3. Press the [STANDBY/ON] switch to turn on the power.

The power indicator located to the left of the [STANDBY/ON] switch lights up.

Pressing the switch again turns the power off.

⚠ CAUTION

Even when the instrument is turned off, electricity is still flowing to the instrument at the minimum level. When you are not using the instrument for a long time, make sure you unplug the AC power adaptor from the wall AC outlet.

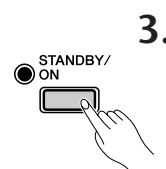
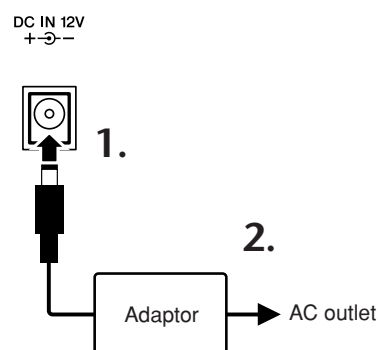

Setting the Volume

Initially set the [MASTER VOLUME] slider about halfway between the “MIN” and “MAX” settings. Then, when you start playing, re-adjust the [MASTER VOLUME] slider to the most comfortable listening level.

TERMINOLOGY

MASTER VOLUME:

The volume level of the entire keyboard sound



The level decreases. The level increases.

Using the Pedal

[SUSTAIN] jack

This jack is for connecting the included pedal (FC5). The pedal functions in the same way as a damper pedal on an acoustic piano. Connect an optional pedal to this jack and press the pedal to sustain the sound. An optional FC3 foot pedal or FC4 foot switch can also be connected to this jack.

Do not press the footswitch while turning the power on. Doing this changes the recognized polarity of the footswitch, resulting in reversed footswitch operation.

If you connect an optional pedal of FC3, the half pedal function* can be used.

* half pedal function

While you playing the piano with SUSTAIN and if you need to delete the cloudy sound, release the foot from pedal to half position.

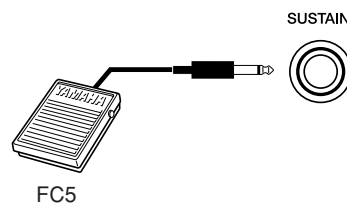

[PEDAL UNIT] jack

This jack is for connecting an optional LP-5 pedal unit. When connecting the pedal unit, make sure to also assemble the unit on an optional keyboard stand (L-85/L-85S).

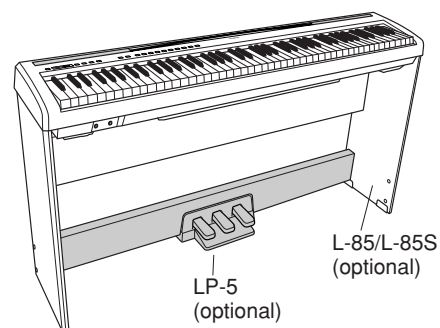
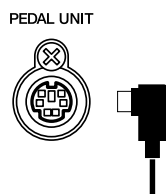

Make sure that power is OFF when connecting or disconnecting the pedal.

Pedal Unit Functions

The optional pedal unit has three foot pedals that produce a range of expressive effects similar to those produced by the pedals on an acoustic piano.

Damper (Right) Pedal

The damper pedal functions in the same way as a damper pedal on an acoustic piano. When the damper pedal is pressed, notes sustain longer. Releasing the pedal immediately stops (damps) any sustained notes. When you select the GRAND PIANO 1 voice on the P-85, pressing the damper pedal activates the instrument's special "Sustain Samples" to accurately recreate the unique resonance of an acoustic grand piano's soundboard and strings. A "half-pedal" effect lets you use the damper pedal to create partial sustain effects, depending on how far down you press the pedal.

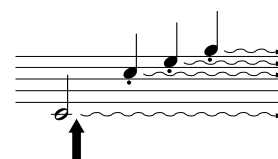
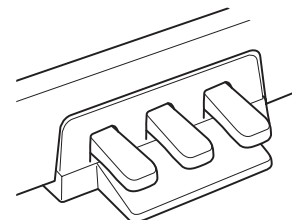

When you press the damper pedal here, the notes you play before you release the pedal have a longer sustain.

Sostenuto (Center) Pedal

If you play a note or chord on the keyboard and press the sostenuto pedal while the note(s) are held, those notes will sustain as long as you hold the pedal (as if the damper pedal had been pressed) but all subsequently played notes will not be sustained. This makes it possible to sustain a chord, for example, while other notes are played "staccato."

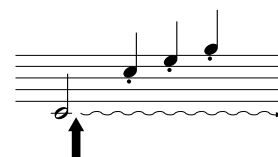

When you press the sostenuto pedal here while holding the note, the note will sustain as long as you hold the pedal.

Soft (Left) Pedal

The soft pedal reduces the volume and slightly changes the timbre of notes played while the pedal is pressed. The soft pedal will not affect notes that are already playing when it is pressed.

Using Headphones

Connect a set of headphones to one of the [PHONES] jacks.

Two [PHONES] jacks are provided.

You can connect two sets of standard stereo headphones. (If you are using only one set of headphones, you can plug them into either jack.)

CAUTION

To protect your hearing, avoid listening to the P-85 at a high volume level for long periods of time.

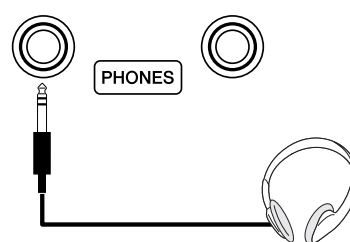

Music Rest

The P-85 includes a music rest that can be attached to the instrument by inserting it into the slot at the top of the control panel.

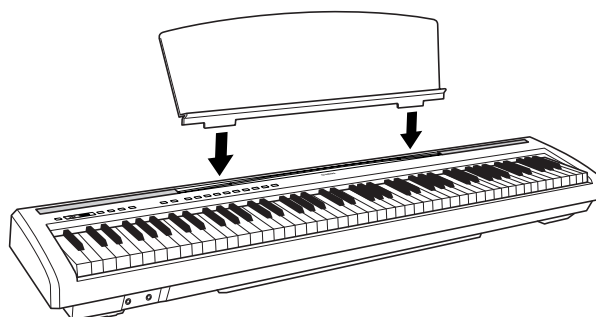

Speakers are built into the instrument at the bottom.

Though you can enjoy playing the instrument even when putting it on a desk or table, we recommend that you use an optional keyboard stand for better sound.

Listening to the Demo Songs

Demo songs are provided that effectively demonstrate each of the voices.

1. Press the [STANDBY/ON] switch to turn the power on.

When the power is turned ON, the power indicator located to the left of the [STANDBY/ON] switch lights up.

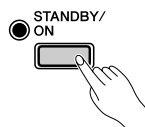

Refer to the voice list on page 18 for more information on the characteristics of each preset voice.

2. Adjust the volume.

Initially set the [MASTER VOLUME] slider about half way between the “MIN” and “MAX” settings. Then, when you start playing, re-adjust the [MASTER VOLUME] slider to the most comfortable listening level.

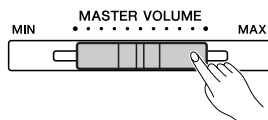

The demo songs will not be transmitted via MIDI.

3. While holding down the [DEMO/SONG] button, press one of the voice buttons to listen to the demo songs.

The demo song will start. Demo songs provided for each voice will play back in sequence until you press the [DEMO/SONG] button.

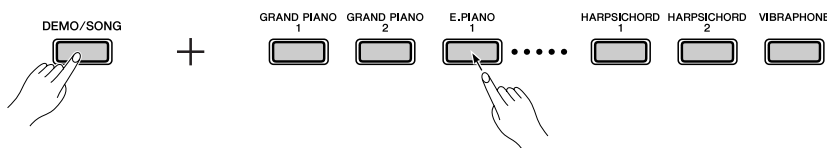

Simply by pressing the [DEMO/SONG] button, you can start the GRAND PIANO 1 demo song and the other demo songs provided for each voice will play back in sequence.

Changing a Demo Song

You can change to another demo song during playback by pressing the SELECT [◀]/[▶] button.

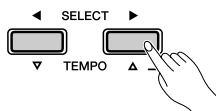

You can also change to another demo song during playback by pressing any one of the voice buttons.

While holding down the [METRONOME] button, use the TEMPO [▽]/[△] buttons to change the playback tempo.

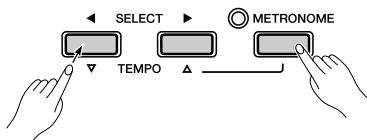

Demo Song List

Voice Name	Title	Composer
HARPSICHORD 1	Gavotte	J.S. Bach
HARPSICHORD 2	Invention No. 1	J.S. Bach

- The demonstration pieces listed above are short rearranged excerpts of the original compositions.
- All other songs are original (© 2005 Yamaha Corporation).

4. Press the [DEMO/SONG] button to stop the voice demo.



Listening to the Piano Preset Songs

The P-85 provides performance data for piano songs as well as voice demo songs, for your listening pleasure.

1. While holding down the [DEMO/SONG] button, press one of the C2–C#6 keys to select a song to play back.

The number of each piano preset song is assigned to the C2–C#6 keys.

Refer to the Quick Operation Guide for details on key assignments.

The preset songs will play back consecutively in sequence until you press the [DEMO/SONG] button.

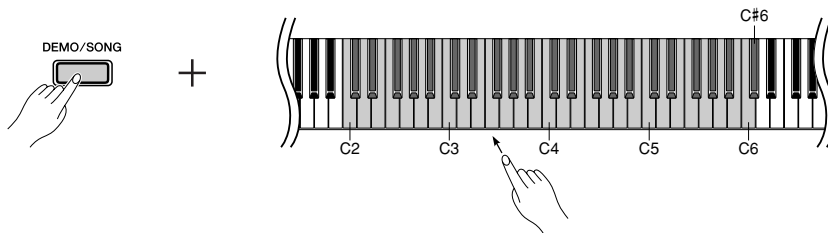

Press the **SELECT** [◀] or [▶] button to change to the next piano song.

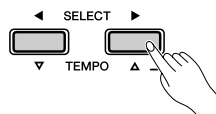

While holding down the [METRONOME] button, use the **TEMPO** [▽]/[△] buttons to change the playback tempo.

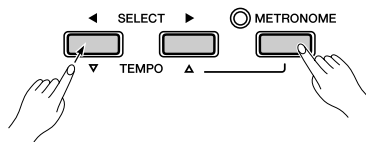

2. Press the [DEMO/SONG] button to stop playback.

To continue playing other songs, see step 1 above.



TERMINOLOGY

Song:

On the P-85, performance data is called a "Song." This includes demonstration tunes and piano preset tunes.

Preset:

Preset Data supplied with the internal memory of the P-85 shipped from the factory.



The Preset Song List appears on page 34.



You can play the keyboard along with the preset song. You can change the voice playing on the keyboard.



When you select a different song (or a different song is selected during chained playback), an appropriate reverb type will be selected accordingly.



The piano preset songs are not transmitted via MIDI.

Using the Metronome

This instrument features a built-in metronome (a device that keeps an accurate tempo) that is convenient for practicing.

1. Press the [METRONOME] button to turn on the metronome.

Start the metronome.

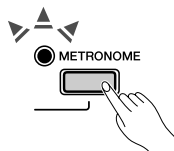

Determine the time signature

While holding down the [METRONOME] button, press one of the A0–D1 keys.

The first beat is accented with a bell sound and the rest with clicks.

Default set is 0/4 (A0). In this setting, clicks sound in all beats.

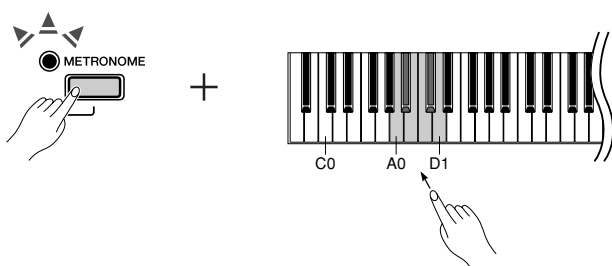

The time signature can also be changed by the following operation.

While holding down the [METRONOME] button, press one of the voice buttons (GRAND PIANO 1–C.ORGAN 2).

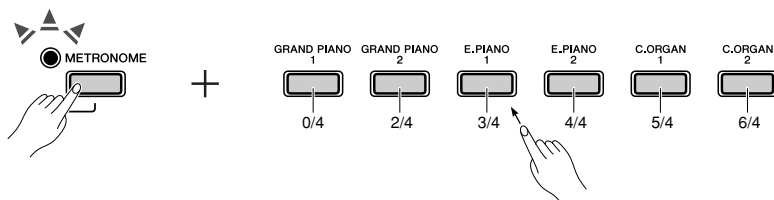

Adjust the Tempo

The tempo of the metronome and song playback can be set from 32 to 280 beats per minute.

A number is assigned to each of the following keys.

While holding down the [METRONOME] button, press a sequence of F3–D4 keys to specify a three-digit number.

Select a number starting from the left-most digit. For example, to set the tempo “95,” press the F3 (0), D4 (9) and A#3 (5) keys in sequence.

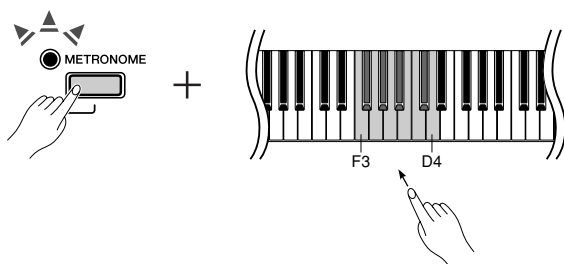

Key	Time signature
A0	0/4
A#0	2/4
B0	3/4
C1	4/4
C#1	5/4
D1	6/4

TERMINOLOGY

Default setting:

The “Default setting” refers to the factory setting obtained when you first turn on the power to the P-85.

Increasing the tempo value in steps of one:

While holding down the [METRONOME] button, press the F#4 key.

Decreasing the tempo value in steps of one:

While holding down the [METRONOME] button, press the E4 key.

Increasing the tempo value in steps of ten:

While holding down the [METRONOME] button, press the G4 key.

Decreasing the tempo value in steps of ten:

While holding down the [METRONOME] button, press the D#4 key.

Resetting the tempo to default:

While holding down the [METRONOME] button, press the F4 key.

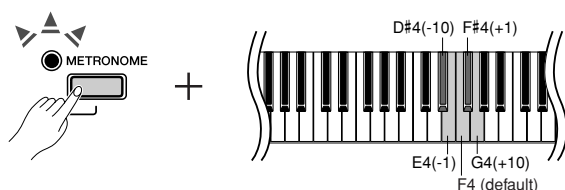

The tempo value can also be changed by the following operation.

While holding down the [METRONOME] button, use the TEMPO [▽]/[△] button to increase or decrease in single steps.

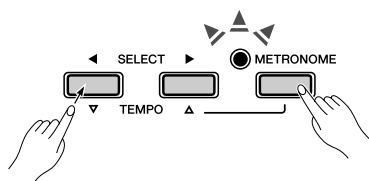

While holding down the [METRONOME] button, press both TEMPO [▽]/[△] buttons simultaneously to restore the default tempo.

Adjusting the volume

You can change the volume of the metronome sound.

While holding down the [METRONOME] button, press one of the A-1–F#0 keys to determine the volume.

Pressing a higher key in the key range results in a higher volume, while pressing a lower key results in lower volume.

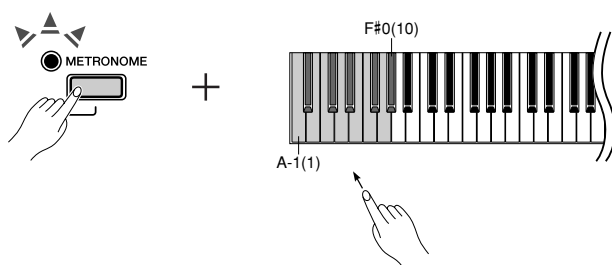
**Metronome volume range:**

A-1 (1)–F#0 (10)

Default setting: D#0 (7)

2. Press the [METRONOME] button to stop the Metronome.



Selecting & Playing Voices

Selecting Voices

1. Press one of the voice buttons.

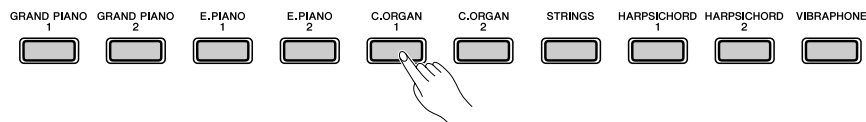

Voice Name	Description
Grand Piano 1	Recorded samples from a full concert grand piano. Perfect for classical compositions as well as any other style that requires acoustic piano.
Grand Piano 2	Clear piano with bright reverb. Good for popular music.
E.Piano 1	An electronic piano sound created by FM synthesis. Good for popular music.
E.Piano 2	The sound of an electric piano using hammer-struck metallic "tines." Soft tone when played lightly, and an aggressive tone when played hard.
C.Organ 1	This is a typical pipe organ sound (8' + 4' + 2'). Good for sacred music from the Baroque period.
C.Organ 2	This is the organ's full coupler sound, often associated with Bach's "Toccatà and Fugue."
Strings	Spacious and large-scale string ensemble. Try combining this voice with piano in DUAL.
Harpsichord 1	The definitive instrument for baroque music. Since the strings of a harpsichord are plucked, there is no touch response.
Harpsichord 2	Mixes the same voice an octave higher for a more brilliant tone.
Vibraphone	The sound of a vibraphone played with relatively soft mallets.



To familiarize yourself with the characteristics of the voices, listen to the demo songs for each voice (page 14).

TERMINOLOGY

Voice:

On the P-85, the term "voice" means "instrument sound."



When you select a voice, an appropriate reverb type will be selected automatically (page 20).

2. Adjust the volume.

Re-adjust the [MASTER VOLUME] slider for the most comfortable listening level during your performance.

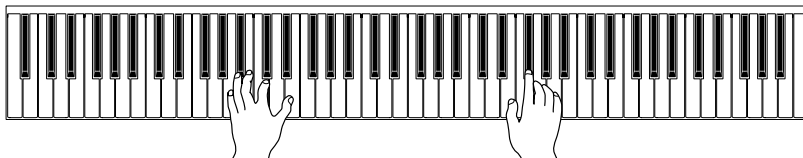

Combining Voices (Dual)

You can play voices simultaneously across the entire range of the keyboard. In this way, you can combine similar voices to create a thicker sound.

1. Press two voice buttons simultaneously to engage Dual.

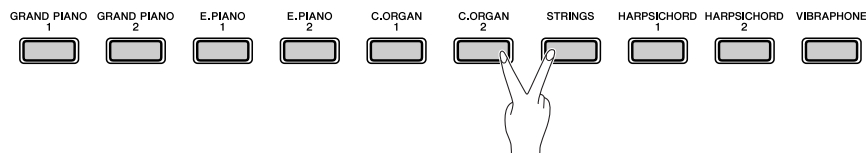

According to the voice button position on the panel, the voice on the left will be designated as Voice 1, and the other will be designated as Voice 2.

You can make the following settings for Voices 1 and 2 in Dual:

Setting the Octave

You can shift the pitch up and down in octave steps for Voice 1 and Voice 2 independently. Depending on which voices you combine in Dual, the combination may sound better if one of the voices is shifted up or down an octave.

While holding down the [METRONOME] button, press one of the A4–D5 keys.

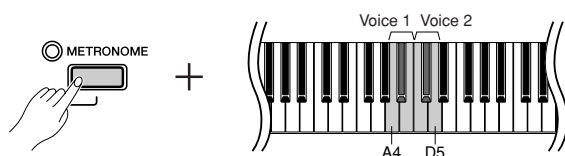

Voice 1	A4	-1	Voice 2	C5	-1
	A#4	0		C#5	0
	B4	+1		D5	+1

Setting the Balance

You can adjust the volume balance between two voices. For example, you can set one voice as the main voice with a louder setting, and make the other voice softer. While holding down the [METRONOME] button, press one of the F#5–F#6 keys. A setting of “0” produces an equal balance between the two Dual voices. Settings below “0” increase the volume of Voice 2 in relation to Voice 1, and settings above “0” increase the volume of Voice 1 in relation to Voice 2.

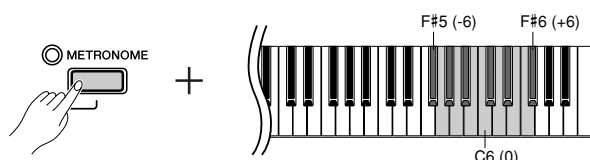

2. Press one of the voice buttons to exit Dual and return to the normal single-voice play.



Reverb in Dual

The reverb type assigned to Voice 1 will take priority. If the reverb assigned to Voice 1 is set to OFF, the reverb assigned to Voice 2 will be in effect.

Adding Variations to the Sound – Reverb

This control enables you to select four different types of reverb effect that add extra depth and expression to the sound to create a realistic acoustic ambience.

Key	Reverb Type	Description
G#6	Room	This setting adds a continuous reverb effect to the sound, similar to the acoustic reverberation you would hear in a room.
A6	Hall1	For a “bigger” reverb sound, use the HALL 1 setting. This effect simulates the natural reverberation of a small-size concert hall.
A#6	Hall2	For a truly spacious reverb sound, use the HALL 2 setting. This effect simulates the natural reverberation of a large concert hall.
B6	Stage	Simulates the reverb of a stage environment.
C7	Off	No effect is applied.

Selecting a Reverb Type

While holding down the [METRONOME] button, press one of the G#6–C7 keys to select a reverb type.

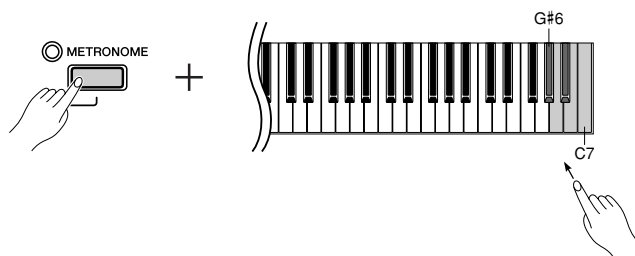

Adjusting Reverb Depth

While holding down the [METRONOME] button, press one of the F1–C#3 keys to adjust the reverb depth for the selected voice.

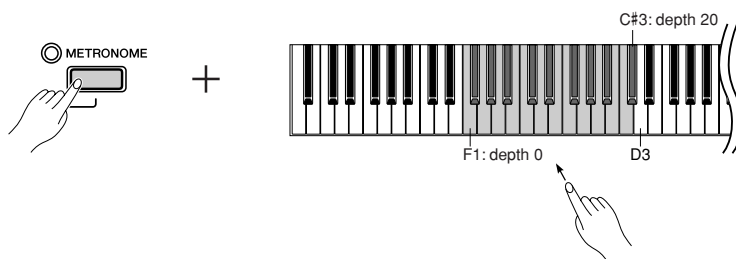

The depth value increases as you press higher keys.

While holding down the [METRONOME] button, press the D3 key to set the reverb to the depth most suitable for the selected voice.



Reverb depth range:
0 (no effect)–
20 (maximum depth)



The default reverb type (including OFF) and depth settings are different for each voice.

Transposition

The Transpose function makes it possible to shift the pitch of the entire keyboard up or down in semitone intervals to facilitate playing in difficult key signatures, and to let you easily match the pitch of the keyboard to the range of a singer or other instruments. For example, if you set the transposition amount to “+5,” playing key C produces pitch F. In this way, you can play a song as though it were in C major, and the P-85 will transpose it to the key of F.

Setting the amount of transposition

While holding down the [DEMO/SONG] and [METRONOME] buttons, press one of the F#2–F#3 keys to set the desired amount of transposition.

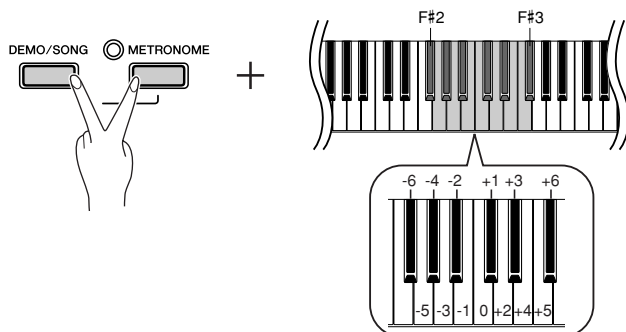

To transpose the pitch down (in semitone steps)

While holding down the [DEMO/SONG] and [METRONOME] buttons, press any key between F#2 and B2.

To transpose the pitch up (in semitone steps)

While holding down the [DEMO/SONG] and [METRONOME] buttons, press any key between C#3 and F#3.

To restore the normal pitch

While holding down the [DEMO/SONG] and [METRONOME] buttons, press the C3 key.

TERMINOLOGY

Transpose:

Changing the key signature. On the P-85, transposing shifts the pitch of the entire keyboard.



Transposition range:

F#2 (-6 semitones)–
C3 (normal pitch)–
F#3 (+6 semitones)

Fine tuning of the Pitch

You can fine tune the pitch of the entire instrument. This function is useful when you play the P-85 along with other instruments or CD music.

Setting the Pitch

To raise the pitch

(in steps of roughly 0.2 Hz):

Hold down the A-1, B-1 and C0 keys simultaneously and press any key between C3 and B3.

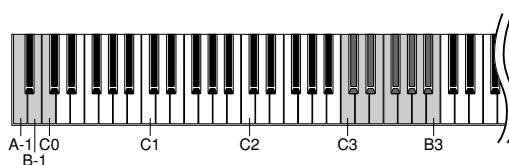

To lower the pitch

(in steps of roughly 0.2 Hz):

Hold down the A-1, B-1 and C#0 keys simultaneously and press any key between C3 and B3.

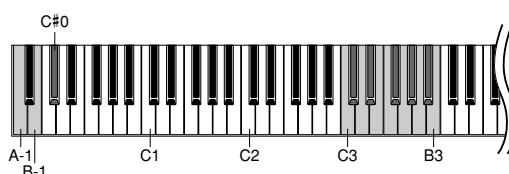

To restore standard pitch:

Hold down the A-1, B-1, C0 and C#0 keys simultaneously and press any key between C3 and B3.

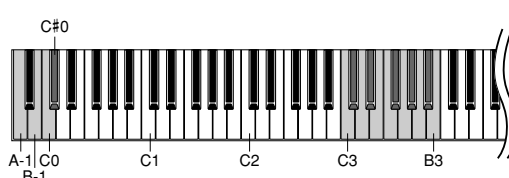

TERMINOLOGY

Hz (Hertz):

This unit of measurement refers to the frequency of a sound and represents the number of times a sound wave vibrates in a second.

Default setting:

The “Default setting” refers to the factory setting obtained when you first turn on the power to the P-85.



Setting range: 427.0–453.0 Hz
Standard pitch: 440.0 Hz

Touch Sensitivity

You can adjust the volume level that changes depending on how fast or strong you hit the keys. The following four settings are available.

Key	Touch Sensitivity	Description
A6	FIXED	The volume level does not change at all regardless of whether you play the keyboard soft or hard.
A#6	SOFT	The volume level does not change much when you play the keyboard soft or hard.
B6	MEDIUM	This is the standard piano touch response (default setting).
C7	HARD	The volume level changes very widely from pianissimo to fortissimo to facilitate dynamic and dramatic expression. You have to hit the keys hard to produce a loud sound.

Setting the Touch Sensitivity Type

While holding down the [DEMO/SONG] button and the [METRONOME] button, press one of the A6–C7 keys to select the desired touch sensitivity.

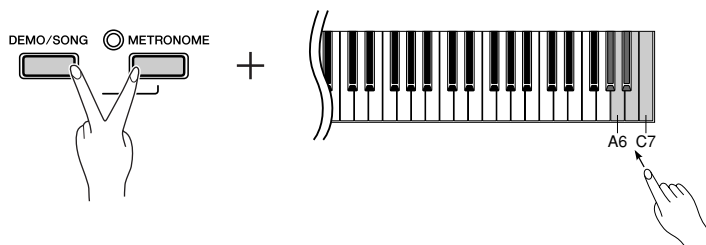

The touch sensitivity settings may have little or no effect with C.ORGAN 1, 2 and Harpsichord 1, 2 voices that are not normally responsive to keyboard dynamics.

Default setting: B6

Recording Your Performance

The ability to record and play back what you've played on the P-85 keyboard can be an effective practice aid.

The P-85's Song Recorder allows the recording of one User song.

TERMINOLOGY

Recording vs. Saving:

The format of performance data recorded on a cassette tape differs from that of data recorded on the P-85. A cassette tape records audio signals. The P-85 "saves" information regarding note timing, voices, and a tempo value, but not audio signals. When you play back recorded songs, the P-85 produces sound based on the saved information. Therefore, recording on the P-85 may be more accurately called "saving information." However, this book often uses the word "recording" because it seems to make more sense.

Recording a performance

1. Make all the initial settings.

Before you begin to record, select the voice you want to record (or voices if you will be using Dual mode). Make any other desired settings (reverb, tempo, etc.) as well. You might also want to set the volume.

You can also adjust the playback volume using the [MASTER VOLUME] slider.

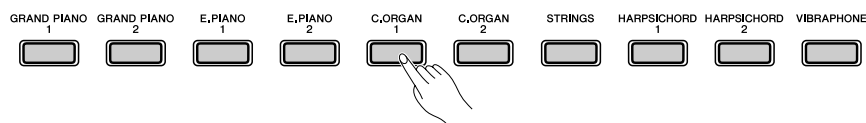

2. Press the [REC] button to engage Record Ready mode.

The [REC] lamp will flash.

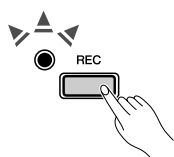

You can turn on the metronome in this step, and adjust the tempo by using the TEMPO [▽]/[△] buttons. (Range: 32–280)

Record Ready mode can be disengaged before recording by pressing the [REC] button again.

3. Start recording.

Recording will begin automatically as soon as you play a note on the keyboard or press the [PLAY] button.

The [REC] lamp will light, and the [PLAY] lamp flashes at the current tempo while recording.

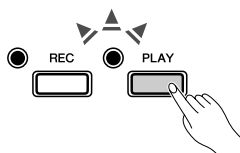

When the instrument is playing back a demo song or preset song, Record mode cannot be engaged.



Recording capacity
P-85 can record up to 65KB
(approximately 11,000 notes).



If the metronome was on when you started recording, you'll be able to keep time with the metronome while recording, but the metronome sound will not be recorded.



For more recording information, see page 24.

4. Press either [REC] or [PLAY] button to stop recording.

When recording is stopped, the [REC] lamp and the [PLAY] lamp flash to indicate that the recorded data is being saved to the instrument automatically. After the data is saved, the [REC] lamp will turn off and the [PLAY] lamp will light.

⚠ CAUTION

Do not turn off the power of the instrument when the lamps are flashing. Doing so may prevent saving of the song data which you have recorded.

The user song recorder records the following data:

Data in addition to the notes and voices you play is recorded.

- Notes played
- Voice selection
- Pedal (Sustain/Soft/Sostenuto)
- Reverb depth
- Dual mode voices
- Dual balance
- Dual octave shift
- Tempo
- Reverb type (including OFF)



Both the [REC] lamp and the [PLAY] lamp will begin to flash when the recorder memory is almost full. If the memory becomes full, recording will stop automatically. (All recorded data up to that point will be retained.)



You can save the recorded data to a computer. You can also load the recorded data back from a computer and play it back on this instrument (page 27).

Play back the recorded performance

Press the [PLAY] button to play back the recorded performance. To stop playback in the middle of a song, press the [PLAY] button again.

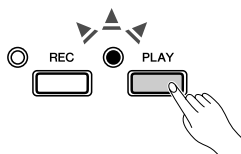

While holding down the [METRONOME] button, use the TEMPO [▽]/[△] buttons to change the playback tempo.

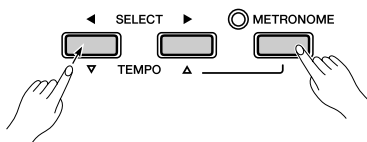

Pressing the [REC] button to start recording, then pressing the [PLAY] button to stop recording will erase all previously-recorded data.



You cannot re-record in the middle of a song.

Changing the Initial Settings (Data recorded at the beginning of a song)

The initial settings (data recorded at the beginning of a song) can be changed after the recording. For example, after recording, you can change the voice to create a different ambience or adjust the song tempo to your taste.

You can change the following initial settings.

- Voice selection
- Dual mode voices
- Sustain/soft pedal depth
- Tempo

1. Press the [REC] button to engage Record Ready mode.

The [REC] lamp will flash.

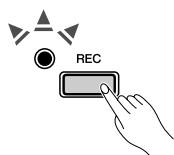

2. Change the settings via the panel controls.

For example, if you wish to change the recorded voice from [E.PIANO 1] to [E.PIANO 2], press the [E.PIANO 2] button. When you wish to change the damper/soft pedal depth, press and hold the pedal.

Be careful not to press the [PLAY] button or a key on the keyboard, either of which will start recording and erase all previously-recorded data on the selected part.

3. Press the [REC] button to exit Record mode.

Be careful not to press the [PLAY] button or a key on the keyboard, either of which will start recording and erase all previously-recorded data.

Connecting MIDI Instruments

The P-85 features MIDI IN/OUT terminals, allowing you to connect the P-85 to other instruments and devices—including computers—and take advantage of the various performance and recording capabilities in MIDI applications.

Connecting MIDI [IN] [OUT] terminals

MIDI [IN] [OUT] terminals

Use MIDI cables to connect external MIDI devices to these connectors.

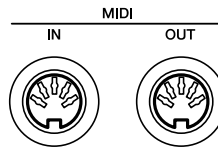

Since MIDI data that can be transmitted or received varies depending on the type of MIDI device, check the “MIDI Implementation Chart” to find out what MIDI data and commands your devices can transmit or receive. The MIDI Implementation Chart is included in the Data List, which can be found at the Yamaha website (See page 7).

About MIDI

MIDI (Musical Instrument Digital Interface) is a standard format for data transmission/reception. It enables the transfer of performance data and commands between MIDI devices and personal computers. Using MIDI, you can control a connected MIDI device from the P-85, or control the P-85 from a connected MIDI device or computer.

MIDI Capabilities

MIDI functions enable you to transfer performance data between MIDI devices.

CAUTION

Before connecting the instrument to other electronic components, turn off the power of all the components.



You cannot transmit the voice demo songs and the piano preset songs from the P-85 to another MIDI device.

● Transferring performance data to and from another MIDI device

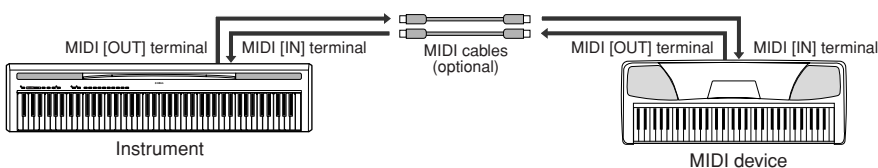

For MIDI connections, use a standard (optional) MIDI cable, available at most musical instrument stores.

● Transferring MIDI data to and from a computer

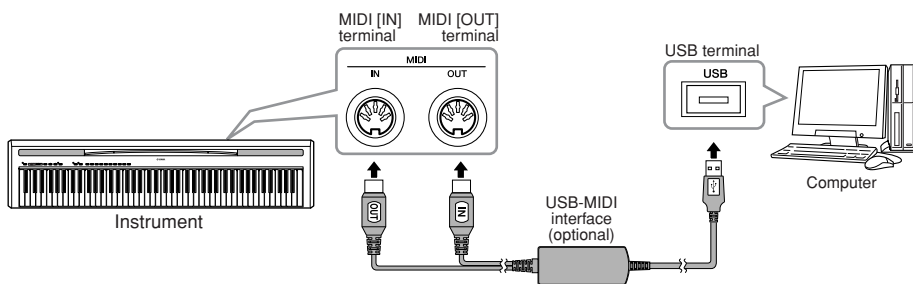

Connecting a Personal Computer

By connecting a computer to the MIDI terminals, you can transfer data between the P-85 and the computer via MIDI.

CAUTION

When connecting the P-85 to a computer, first turn off the power to both the P-85 and the computer before connecting any cables. After making connections, turn on the power to the computer first, then to the P-85.

Connecting the USB port on the computer to the P-85 via an optional USB-MIDI interface (such as the Yamaha UX16)

Use a USB-MIDI interface device to connect the USB port on your computer to the P-85's MIDI terminals. You must install the USB-MIDI interface (such as the UX16) driver. For more information, refer to the user's manual that came with the USB-MIDI interface device.

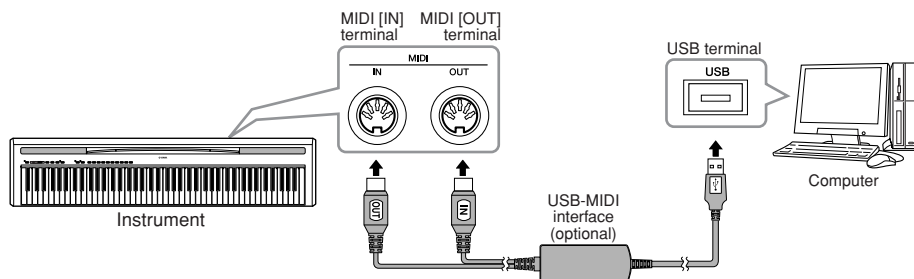

When the P-85 is used as a tone module, performance data with voices that are not found on the P-85 will not be played correctly.



You must install a software application on the computer to be able to transfer MIDI data between the P-85 and a computer.

Transferring Data between the Computer and the Instrument

You can save backup data of this instrument, such as recorded songs, etc., to a computer, as well as load the saved data back to the instrument from the computer.

To transfer the backup data, you must first download Musicsoft Downloader (free software) from Yamaha website at the following URL, and install it on your computer.

<http://music.yamaha.com/download/>

Please visit the URL above to get the information on the computer system requirement for Musicsoft Downloader.

For more information on transferring data, please refer to “Transferring Data Between the Computer and Instrument (for unprotected data)” in the Help file that came with Musicsoft Downloader.

CAUTION

Do not turn off the power to this instrument or unplug the instrument during data transmission. Otherwise, the data being transmitted will not be saved. Furthermore, flash memory operation may become unstable, causing the entire memory to be erased when you turn the power to the instrument on or off.

CAUTION

Do not rename the backup file on the computer. If you do so, it will not be recognized when transferred to the instrument.

Initializing the settings

Turn off the power to the instrument. Then turn the power on while holding the C7 key (right-most key on the keyboard). When you initialize the settings, all data, excluding the recorded data loaded from a computer, will be initialized and reset to the factory default settings.

CAUTION

Do not turn off the power to this instrument while it is initializing the data in its internal memory (that is, while the [REC] and [PLAY] button indicators are flashing).



Backup Data

The following data will be stored in flash memory on this instrument. This data will be kept after you turn off the power to the instrument.

- Metronome volume
- Metronome tempo
- Touch sensitivity
- Tuning
- Recorded performance data



The backup data file is automatically named “NPP88.BUP”.



Keep in mind that the [REC] and [PLAY] indicators are lit when Musicsoft Downloader is being used.



Before you use this instrument, close the Musicsoft Downloader window and quit the application.



If this instrument somehow becomes disabled or malfunctions, turn off the power to the instrument, then perform the initialization procedure.

MIDI Functions

You can make detailed adjustments to MIDI settings.

MIDI Transmit/Receive Channel Selection

In any MIDI control setup, the MIDI channels of the transmitting and receiving devices must be matched for proper data transfer.

This parameter enables you to specify the channel on which the P-85 transmits or receives MIDI data.

Setting the Transmit Channel

While holding down the [DEMO/SONG] and [METRONOME] buttons, press one of the C1–E2 keys.

Setting the Receive Channel

While holding down the [DEMO/SONG] and [METRONOME] buttons, press one of the C4–F5 keys.

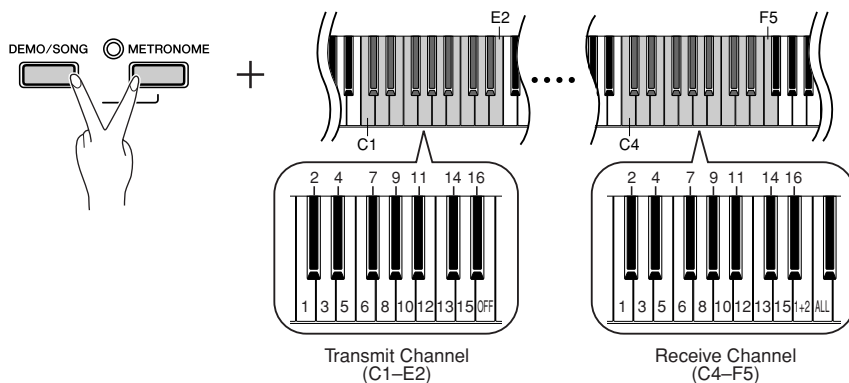

In Dual, Voice 1 data is transmitted on its specified channel and Voice 2 data is transmitted on the next greater channel number relative to the specified channel. In this case, no data is transmitted if the transmit channel is set to "OFF."

ALL:

"Multi-timbre" Receive. This allows simultaneous reception of different parts on all 16 MIDI channels, enabling the P-85 to play multi-channel song data received from a music computer or sequencer.

1+2:

"1+2" Receive. This allows simultaneous reception on channels 1 and 2 only, enabling the P-85 to play 1 and 2 channel song data received from a music computer or sequencer.

Program change and other like channel messages received will not affect the P-85's panel settings or the notes you play on the keyboard.

Data for the demo song and piano preset songs cannot be transmitted via MIDI.

Local Control ON/OFF

"Local Control" refers to the fact that, normally, the P-85 keyboard controls its internal tone generator, allowing the internal voices to be played directly from the keyboard. This situation is "Local Control On," since the internal tone generator is controlled locally by its own keyboard.

Local control can be turned OFF, however, so that the P-85 keyboard does not play the internal voices, but the appropriate MIDI information is still transmitted via the MIDI OUT terminal when notes are played on the keyboard. At the same time, the internal tone generator responds to MIDI information received via the MIDI IN terminal.

While holding down the [DEMO/SONG] and [METRONOME] buttons, press the C6 key. Pressing the C6 key repeatedly toggles between Local Control On and Off.

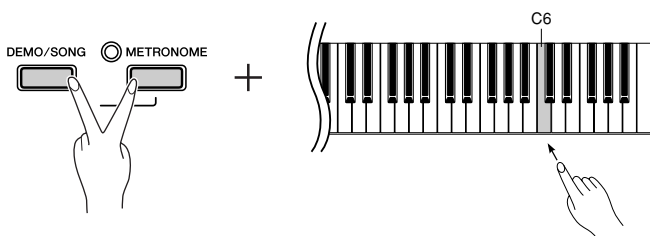

Default setting: ON

Program Change ON/OFF

Normally the P-85 will respond to MIDI program change numbers received from an external keyboard or other MIDI device, causing the same numbered voice to be selected on the corresponding channel (the keyboard voice does not change). The P-85 will normally also send a MIDI program change number whenever one of its voices is selected, causing the same numbered voice or program to be selected on the external MIDI device if the device is set up to receive and respond to MIDI program change numbers. This function makes it possible to cancel program change number reception and transmission so that voices can be selected on the P-85 without affecting the external MIDI device.

While holding down the **[DEMO/SONG]** and **[METRONOME]** buttons, press the C#6 key. Pressing the C#6 key repeatedly toggles between Program Change On and Off.

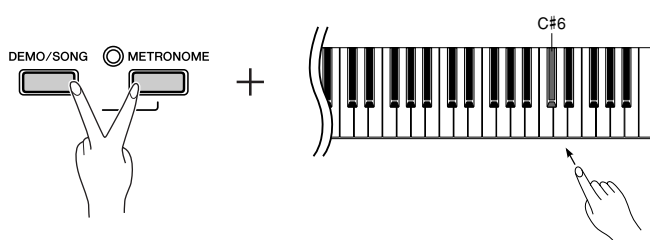

Default setting: ON

PROGRAM CHANGE

Data format: [CnH] -> [ppH]

CnH = Program event (n = channel number)

ppH = Program change number

Voice Name	MSB	LSB	P.C.#
Grand Piano 1	0	122	1
Grand Piano 2	0	112	1
E.Piano 1	0	122	6
E.Piano 2	0	122	5
C.Organ 1	0	123	20
C.Organ 2	0	122	20
Strings	0	122	49
Harpichord 1	0	122	7
Harpichord 2	0	123	7
Vibraphone	0	122	12

P.C.# = Program Change number

- When program change reception is turned OFF, no program change data is transmitted or received.
- When you specify a program change as a number in the range of 0–127, specify a number that is one less than the program change number listed above. For example, to specify program change number 1, you would specify a value of 0.

Control Change ON/OFF

Normally the P-85 will respond to MIDI control change data received from an external MIDI device or keyboard, causing the voice on the corresponding channel to be affected by pedal and other “control” settings received from the controlling device (the keyboard voice is not affected). The P-85 also transmits MIDI control change information when the pedal or other appropriate controls are operated.

This function makes it possible to cancel control change data reception and transmission so that, for example, the P-85’s pedal and other controls can be operated without affecting an external MIDI device.

While holding down the **[DEMO/SONG]** and **[METRONOME]** buttons, press the D6 key. Pressing the D6 key repeatedly toggles between Control Change On and Off.

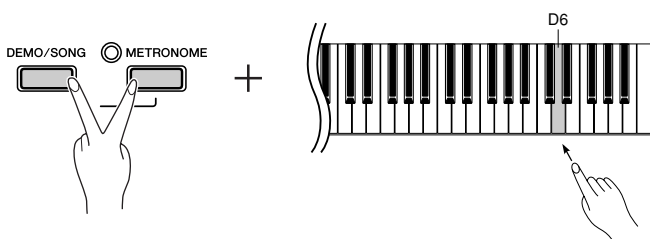

For information on control changes that can be used with the P-85, refer to the MIDI Data Format section in the Data List, which can be found at the Yamaha website (See page 7).

Default setting: ON

Troubleshooting

Problem	Possible Cause and Solution
The P-85 does not turn on.	The P-85 has not been plugged in properly. Securely insert the female plug into the jack on the P-85, and the male plug into a proper AC outlet (page 11).
Noise is heard from the speakers or headphones.	The noise may be due to interference caused by the use of a mobile phone in close proximity to the P-85. Turn off the mobile phone, or use it further away from the P-85.
The overall volume is low, or no sound is heard.	The Master Volume is set too low; set it to an appropriate level using the [MASTER VOLUME] control (page 11).
	Make sure a pair of headphones is not connected to the headphones jack (page 13).
	Make sure that Local Control (page 28) is ON.
The pedal has no effect.	The pedal cable/plug may not be properly connected. Make sure to securely insert the pedal plug into the SUSTAIN/PEDAL UNIT jack (page 12).

Optional Equipment

Foot Pedal (FC3/FC4)

Keyboard Stand (L-85/L-85S)

Pedal Unit (LP-5)

USB-MIDI interface (UX16)

Headphones (HPE-150/HPE-30)

Index

B

Backup Data27

C

Combining Voices (Dual).....19

Connecting a Personal Computer27

Control Change ON/OFF30

D

DC IN 12V11

Default setting21

Demo Songs14

[DEMO/SONG] button.....14, 15

Dual.....19

H

Hz (Hertz)21

L

Local Control ON/OFF28

M

[MASTER VOLUME] slider.....11

Metronome.....16

MIDI [IN] [OUT]26

MIDI terminals.....26

MIDI Transmit/Receive Channel Selection.....28

Music Rest.....13

Musicsoft Downloader.....27

O

Optional Equipment31

P

Panel Controls and Terminals.....10

[PEDAL UNIT] jack12

[PHONES] jack.....13

Piano Preset Songs15, 34

[PLAY] button24

PRECAUTIONS.....4, 5

Preset songs → Piano Preset Songs15, 34

Program Change ON/OFF29

R

[REC] button23

Recording23

Reverb.....20

S

SELECT [◀] [▶] buttons.....14, 15

Song15

Specifications.....35

[STANDBY/ON] switch11

Start/stop playback.....15

 Demo songs14

 Piano Preset Songs15

[SUSTAIN] jack12

T

TEMPO [▼] [▲] buttons14, 15

Touch Sensitivity.....22

Transposition21

Troubleshooting.....31

Tuning →Fine tuning of the Pitch21

V

Voice18

Volume11

Preset Song List / Liste der voreingestellten Songs / Liste des morceaux prédéfinis / Lista de canciones preseleccionadas

No.	Title	Composer
1	Invention No. 1	J.S.Bach
2	Invention No. 8	J.S.Bach
3	Gavotte	J.S.Bach
4	Prelude (Wohltemperierte Klavier I No.1)	J.S.Bach
5	Menuett G dur BWV.Anh.114	J.S.Bach
6	Le Coucou	L-C.Daquin
7	Piano Sonate No.15 K.545 1st mov.	W.A.Mozart
8	Turkish March	W.A.Mozart
9	Menuett G dur	W.A.Mozart
10	Little Serenade	J.Haydn
11	Perpetuum mobile	C.M.v.Weber
12	Ecossaise	L.v.Beethoven
13	Für Elise	L.v.Beethoven
14	Marcia alla Turca	L.v.Beethoven
15	Piano Sonate op.13 "Pathétique" 2nd mov.	L.v.Beethoven
16	Piano Sonate op.27-2 "Mondschein" 1st mov.	L.v.Beethoven
17	Piano Sonate op.49-2 1st mov.	L.v.Beethoven
18	Impromptu op.90-2	F.P.Schubert
19	Moments Musicaux op.94-3	F.P.Schubert
20	Frühlingslied op.62-2	J.L.F.Mendelssohn
21	Jägerlied op.19b-3	J.L.F.Mendelssohn
22	Fantaisie-Impromptu	F.F.Chopin
23	Prelude op.28-15 "Raindrop"	F.F.Chopin
24	Etude op.10-5 "Black keys"	F.F.Chopin
25	Etude op.10-3 "Chanson de l'adieu"	F.F.Chopin
26	Etude op.10-12 "Revolutionary"	F.F.Chopin
27	Valse op.64-1 "Petit chien"	F.F.Chopin
28	Valse op.64-2	F.F.Chopin
29	Valse op.69-1 "L'adieu"	F.F.Chopin
30	Nocturne op.9-2	F.F.Chopin
31	Träumerei	R.Schumann
32	Fröhlicher Landmann	R.Schumann
33	La prière d'une Vierge	T.Badarzewska
34	Dolly's Dreaming and Awakening	T.Oesten
35	Arabesque	J.F.Burgmüller
36	Pastorale	J.F.Burgmüller
37	La chevaleresque	J.F.Burgmüller
38	Liebesträume Nr.3	F.Liszt
39	Blumenlied	G.Lange
40	Barcarolle	P.I.Tchaikovsky
41	Melody in F	A.Rubinstein
42	Humoresque	A.Dvořák
43	Tango (España)	I.Albéniz
44	The Entertainer	S.Joplin
45	Maple Leaf Rag	S.Joplin
46	La Fille aux Cheveux de Lin	C.A.Debussy
47	Arabesque 1	C.A.Debussy
48	Clair de lune	C.A.Debussy
49	Rêverie	C.A.Debussy
50	Golliwog's Cakewalk	C.A.Debussy

Specifications / Technische Daten / Caractéristiques techniques / Especificaciones

Keyboard	88 keys (A-1–C7)
Sound Source	AWM Stereo Sampling
Polyphony (Max.)	64
Voice Selection	10
Effect	Reverb
Volume	Master Volume
Controls	Dual, Metronome, Transpose, Tuning, Touch (Hard/Medium/Soft/Fixed)
Pedal	SUSTAIN PEDAL*
Demo Songs	10 Voice Demo Songs, 50 Piano Preset Songs
Recording/Playback	one song: 65 KB (approx. 11,000 notes)
MIDI	Local On/Off, Transmit/Receive channel, Program change On/Off, Control change On/Off
Jacks/Connectors	MIDI (IN/OUT), PHONES, DC IN 12V, SUSTAIN, PEDAL UNIT
Main Amplifiers	6 W + 6 W
Speakers	(12 cm × 6 cm) × 2
Dimensions (W × D × H)	1,326mm × 295mm × 151.5mm [52-3/16" × 11-5/8" × 5-15/16"]
Weight	11.6 kg (25 lbs., 9 oz.)
Power Supply	Adaptor: PA-5D, PA-150, or an equivalent recommended by Yamaha
Power Consumption	20 W
Accessories	Owner's Manual, Quick Operation Guide, AC Power Adaptor, Pedal (FC5), Music Rest

- When an optional FC3 Foot Pedal or an optional LP-5 Pedal Unit is connected, the half pedal effect can be used.
- Wenn ein optionales Fußpedal FC3 oder eine optionale Pedaleinheit LP-5 angeschlossen wird, kann der Halbpedal-Effekt verwendet werden.
- Lorsqu'une pédale au pied FC3 ou une unité de pédales LP-5 fournies en option sont connectées, il est possible d'utiliser l'effet de pédale à mi-course.
- Si se conecta un pedal FC3 o una unidad de pedal LP-5 opcionales, se puede utilizar el efecto de medio pedal.
- Specifications and descriptions in this owner's manual are for information purposes only. Yamaha Corp. reserves the right to change or modify products or specifications at any time without prior notice. Since specifications, equipment or options may not be the same in every locale, please check with your Yamaha dealer.
- Die technischen Daten und Beschreibungen in dieser Bedienungsanleitung dienen nur der Information. Yamaha Corp. behält sich das Recht vor, Produkte oder deren technische Daten jederzeit ohne vorherige Ankündigung zu verändern oder zu modifizieren. Da die technischen Daten, das Gerät selbst oder Sonderzubehör nicht in jedem Land gleich sind, setzen Sie sich im Zweifel bitte mit Ihrem Yamaha-Händler in Verbindung.
- Les caractéristiques techniques et les descriptions du mode d'emploi ne sont données que pour information. Yamaha Corp. se réserve le droit de changer ou modifier les produits et leurs caractéristiques techniques à tout moment sans aucun avis. Du fait que les caractéristiques techniques, les équipements et les options peuvent différer d'un pays à l'autre, adressez-vous au distributeur Yamaha le plus proche.
- Las especificaciones y descripciones de este manual del propietario tienen sólo el propósito de servir como información. Yamaha Corp. se reserva el derecho a efectuar cambios o modificaciones en los productos o especificaciones en cualquier momento sin previo aviso. Puesto que las especificaciones, equipos u opciones pueden no ser las mismas en todos los mercados, solicite información a su distribuidor Yamaha.

For details of products, please contact your nearest Yamaha representative or the authorized distributor listed below.

Pour plus de détails sur les produits, veuillez-vous adresser à Yamaha ou au distributeur le plus proche de vous figurant dans la liste suivante.

Die Einzelheiten zu Produkten sind bei Ihrer unten aufgeführten Niederlassung und bei Yamaha Vertragshändlern in den jeweiligen Bestimmungsländern erhältlich.

Para detalles sobre productos, contacte su tienda Yamaha más cercana o el distribuidor autorizado que se lista debajo.

NORTH AMERICA

CANADA

Yamaha Canada Music Ltd.
135 Milner Avenue, Scarborough, Ontario,
M1S 3R1, Canada
Tel: 416-298-1311

U.S.A.

Yamaha Corporation of America
6600 Orangethorpe Ave., Buena Park, Calif. 90620,
U.S.A.
Tel: 714-522-9011

CENTRAL & SOUTH AMERICA

MEXICO

Yamaha de México S.A. de C.V.
Calz. Javier Rojo Gómez #1149,
Col. Guadalupe del Moral
C.P. 09300, México, D.F., México
Tel: 55-5804-0600

BRAZIL

Yamaha Musical do Brasil Ltda.
Rua Joaquim Floriano, 913 - 4º andar, Itaim Bibi,
CEP 04534-013 Sao Paulo, SP. BRAZIL
Tel: 011-3704-1377

ARGENTINA

Yamaha Music Latin America, S.A.
Sucursal de Argentina
Viamonte 1145 Piso2-B 1053,
Buenos Aires, Argentina
Tel: 1-4371-7021

PANAMA AND OTHER LATIN AMERICAN COUNTRIES/ CARIBBEAN COUNTRIES

Yamaha Music Latin America, S.A.
Torre Banco General, Piso 7, Urbanización Marbella,
Calle 47 y Aquilino de la Guardia,
Ciudad de Panamá, Panamá
Tel: +507-269-5311

EUROPE

THE UNITED KINGDOM

Yamaha Music U.K. Ltd.
Sherbourne Drive, Tilbrook, Milton Keynes,
MK7 8BL, England
Tel: 01908-366700

IRELAND

Danfay Ltd.
61D, Sallynoggin Road, Dun Laoghaire, Co. Dublin
Tel: 01-2859177

GERMANY

Yamaha Music Central Europe GmbH
Siemensstraße 22-34, 25462 Rellingen, Germany
Tel: 04101-3030

SWITZERLAND/LIECHTENSTEIN

Yamaha Music Central Europe GmbH,
Branch Switzerland
Seefeldstrasse 94, 8008 Zürich, Switzerland
Tel: 01-383 3990

AUSTRIA

Yamaha Music Central Europe GmbH,
Branch Austria
Schleiergasse 20, A-1100 Wien, Austria
Tel: 01-60203900

CZECH REPUBLIC/SLOVAKIA/ HUNGARY/SLOVENIA

Yamaha Music Central Europe GmbH,
Branch Austria, CEE Department
Schleiergasse 20, A-1100 Wien, Austria
Tel: 01-602039025

POLAND

Yamaha Music Central Europe GmbH
Sp.z o.o. Oddział w Polsce
ul. 17 Stycznia 56, PL-02-146 Warszawa, Poland
Tel: 022-868-07-57

THE NETHERLANDS/ BELGIUM/LUXEMBOURG

Yamaha Music Central Europe GmbH,
Branch Benelux
Clarissenhof 5-b, 4133 AB Vianen, The Netherlands
Tel: 0347-358 040

FRANCE

Yamaha Musique France
BP 70-77312 Marne-la-Vallée Cedex 2, France
Tel: 01-64-61-4000

ITALY

Yamaha Musica Italia S.P.A.
Viale Italia 88, 20020 Lainate (Milano), Italy
Tel: 02-935-771

SPAIN/PORTUGAL

Yamaha Música Ibérica, S.A.
Ctra. de la Coruna km. 17, 200, 28230
Las Rozas (Madrid), Spain
Tel: 91-639-8888

GREECE

Philippos Nakas S.A. The Music House
147 Skiathou Street, 112-55 Athens, Greece
Tel: 01-228 2160

SWEDEN

Yamaha Scandinavia AB
J. A. Wettergrens Gata 1, Box 30053
S-400 43 Göteborg, Sweden
Tel: 031 89 34 00

DENMARK

YS Copenhagen Liaison Office
Generatorvej 6A, DK-2730 Herlev, Denmark
Tel: 44 92 49 00

FINLAND

F-Musiikki Oy
Kluuvikatu 6, P.O. Box 260,
SF-00101 Helsinki, Finland
Tel: 09 618511

NORWAY

Norsk filial av Yamaha Scandinavia AB
Grini Næringspark 1, N-1345 Østerås, Norway
Tel: 67 16 77 70

ICELAND

Skeifan HF
Skeifan 17 P.O. Box 8120, IS-128 Reykjavik, Iceland
Tel: 525 5000

RUSSIA

Yamaha Music (Russia)
Office 4015, entrance 2, 21/5 Kuznetskii
Most street, Moscow, 107996, Russia
Tel: 495 626 0660

OTHER EUROPEAN COUNTRIES

Yamaha Music Central Europe GmbH
Siemensstraße 22-34, 25462 Rellingen, Germany
Tel: +49-4101-3030

AFRICA

Yamaha Corporation,
Asia-Pacific Music Marketing Group
Nakazawa-cho 10-1, Naka-ku, Hamamatsu,
Japan 430-8650
Tel: +81-53-460-2312

MIDDLE EAST

TURKEY/CYPRUS

Yamaha Music Central Europe GmbH
Siemensstraße 22-34, 25462 Rellingen, Germany
Tel: 04101-3030

OTHER COUNTRIES

Yamaha Music Gulf FZE
LOB 16-513, P.O.Box 17328, Jubel Ali,
Dubai, United Arab Emirates
Tel: +971-4-881-5868

ASIA

THE PEOPLE'S REPUBLIC OF CHINA

Yamaha Music & Electronics (China) Co.,Ltd.
25/F., United Plaza, 1468 Nanjing Road (West),
Jingan, Shanghai, China
Tel: 021-6247-2211

HONG KONG

Tom Lee Music Co., Ltd.
11/F., Silvercord Tower 1, 30 Canton Road,
Tsimshatsui, Kowloon, Hong Kong
Tel: 2737-7688

INDONESIA

PT. Yamaha Music Indonesia (Distributor)
PT. Nusantik
Gedung Yamaha Music Center, Jalan Jend. Gatot
Subroto Kav. 4, Jakarta 12930, Indonesia
Tel: 21-520-2577

KOREA

Yamaha Music Korea Ltd.
8F, 9F, Dongsung Bldg. 158-9 Samsung-Dong,
Kangnam-Gu, Seoul, Korea
Tel: 080-004-0022

MALAYSIA

Yamaha Music Malaysia, Sdn., Bhd.
Lot 8, Jalan Perbandaran, 47301 Kelana Jaya,
Petaling Jaya, Selangor, Malaysia
Tel: 3-78030900

PHILIPPINES

Yupangco Music Corporation
339 Gil J. Puyat Avenue, P.O. Box 885 MCPO,
Makati, Metro Manila, Philippines
Tel: 819-7551

SINGAPORE

Yamaha Music Asia Pte., Ltd.
#03-11 A-Z Building
140 Paya Lebor Road, Singapore 409015
Tel: 747-4374

TAIWAN

Yamaha KHS Music Co., Ltd.
3F, #6, Sec.2, Nan Jing E. Rd. Taipei.
Taiwan 104, R.O.C.
Tel: 02-2511-8688

THAILAND

Siam Music Yamaha Co., Ltd.
891/1 Siam Motors Building, 15-16 floor
Rama 1 road, Wangmai, Pathumwan
Bangkok 10330, Thailand
Tel: 02-215-2626

OTHER ASIAN COUNTRIES

Yamaha Corporation,
Asia-Pacific Music Marketing Group
Nakazawa-cho 10-1, Naka-ku, Hamamatsu,
Japan 430-8650
Tel: +81-53-460-2317

OCEANIA

AUSTRALIA

Yamaha Music Australia Pty. Ltd.
Level 1, 99 Queensbridge Street, Southbank,
Victoria 3006, Australia
Tel: 3-9693-5111

NEW ZEALAND

Music Houses of N.Z. Ltd.
146/148 Captain Springs Road, Te Papapa,
Auckland, New Zealand
Tel: 9-634-0099

COUNTRIES AND TRUST TERRITORIES IN PACIFIC OCEAN

Yamaha Corporation,
Asia-Pacific Music Marketing Group
Nakazawa-cho 10-1, Naka-ku, Hamamatsu,
Japan 430-8650
Tel: +81-53-460-2312



Yamaha Home Keyboards Home Page (English Only)
<http://music.yamaha.com/homekeyboard>
Yamaha Manual Library
<http://www.yamaha.co.jp/manual/>

U.R.G., Pro Audio & Digital Musical Instrument Division, Yamaha Corporation
© 2007 Yamaha Corporation

WK66530 | 712POXXXX.X-XXB0
Printed in China