



# *Clavinova*®

CVP-305/303/301

O W N E R ' S M A N U A L

**IMPORTANT —Check your power supply—**

Make sure that your local AC mains voltage matches the voltage specified on the name plate on the bottom panel. In some areas a voltage selector may be provided on the bottom panel of the main keyboard unit near the power cord. Make sure that the voltage selector is set for the voltage in your area. The voltage selector is set at 240V when the unit is initially shipped. To change the setting use a "minus" screwdriver to rotate the selector dial so that the correct voltage appears next to the pointer on the panel.

# SPECIAL MESSAGE SECTION

**PRODUCT SAFETY MARKINGS:** Yamaha electronic products may have either labels similar to the graphics shown below or molded/stamped facsimiles of these graphics on the enclosure. The explanation of these graphics appears on this page. Please observe all cautions indicated on this page and those indicated in the safety instruction section.

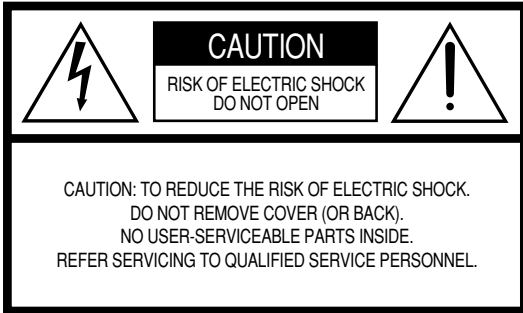

See bottom of Keyboard enclosure for graphic symbol markings.



The exclamation point within the equilateral triangle is intended to alert the user to the presence of important operating and maintenance (servicing) instructions in the literature accompanying the product.

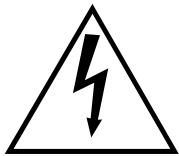

The lightning flash with arrowhead symbol, within the equilateral triangle, is intended to alert the user to the presence of uninsulated “dangerous voltage” within the product’s enclosure that may be of sufficient magnitude to constitute a risk of electrical shock.

**IMPORTANT NOTICE:** All Yamaha electronic products are tested and approved by an independent safety testing laboratory in order that you may be sure that when it is properly installed and used in its normal and customary manner, all foreseeable risks have been eliminated. DO NOT modify this unit or commission others to do so unless specifically authorized by Yamaha. Product performance and/or safety standards may be diminished. Claims filed under the expressed warranty may be denied if the unit is/has been modified. Implied warranties may also be affected.

**SPECIFICATIONS SUBJECT TO CHANGE:** The information contained in this manual is believed to be correct at the time of printing. However, Yamaha reserves the right to change or modify any of the specifications without notice or obligation to update existing units.

**ENVIRONMENTAL ISSUES:** Yamaha strives to produce products that are both user safe and environmentally friendly. We sincerely believe that our products and the production methods used to produce them, meet these goals. In keeping with both the letter and the spirit of the law, we want you to be aware of the following:

**Battery Notice:** This product MAY contain a small non-rechargeable battery which (if applicable) is soldered in place. The average life span of this type of battery is approximately five years. When replacement becomes necessary, contact a qualified service representative to perform the replacement.

**Warning:** Do not attempt to recharge, disassemble, or incinerate this type of battery. Keep all batteries away from children. Dispose of used batteries promptly and as regulated by applicable laws. Note: In some areas, the servicer is required by law to return the defective parts. However, you do have the option of having the servicer dispose of these parts for you.

**Disposal Notice:** Should this product become damaged beyond repair, or for some reason its useful life is considered to be at an end, please observe all local, state, and federal regulations that relate to the disposal of products that contain lead, batteries, plastics, etc.

**NOTICE:** Service charges incurred due to lack of knowledge relating to how a function or effect works (when the unit is operating as designed) are not covered by the manufacturer’s warranty, and are therefore the owners responsibility. Please study this manual carefully and consult your dealer before requesting service.

**NAME PLATE LOCATION:** The graphic below indicates the location of the name plate. The model number, serial number, power requirements, etc., are located on this plate. You should record the model number, serial number, and the date of purchase in the spaces provided below and retain this manual as a permanent record of your purchase.

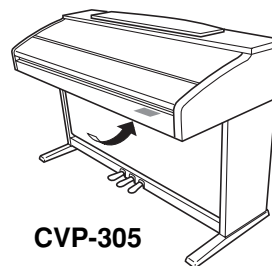

CVP-305

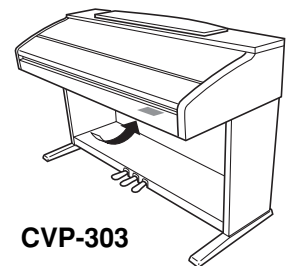

CVP-303

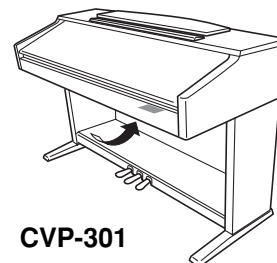

CVP-301

**Model** \_\_\_\_\_

**Serial No.** \_\_\_\_\_

**Purchase Date** \_\_\_\_\_

# PRECAUTIONS

## PLEASE READ CAREFULLY BEFORE PROCEEDING

\* Please keep this manual in a safe place for future reference.



### WARNING

Always follow the basic precautions listed below to avoid the possibility of serious injury or even death from electrical shock, short-circuiting, damages, fire or other hazards. These precautions include, but are not limited to, the following:

#### Power supply/Power cord

- Only use the voltage specified as correct for the instrument. The required voltage is printed on the name plate of the instrument.
- Check the electric plug periodically and remove any dirt or dust which may have accumulated on it.
- Use only the supplied power cord/plug.
- Do not place the power cord near heat sources such as heaters or radiators, and do not excessively bend or otherwise damage the cord, place heavy objects on it, or place it in a position where anyone could walk on, trip over, or roll anything over it.

#### Do not open

- Do not open the instrument or attempt to disassemble the internal parts or modify them in any way. The instrument contains no user-serviceable parts. If it should appear to be malfunctioning, discontinue use immediately and have it inspected by qualified Yamaha service personnel.

#### Water warning

- Do not expose the instrument to rain, use it near water or in damp or wet conditions, or place containers on it containing liquids which might spill into any openings.
- Never insert or remove an electric plug with wet hands.

#### Fire warning

- Do not put burning items, such as candles, on the unit.  
A burning item may fall over and cause a fire.

#### If you notice any abnormality

- If the power cord or plug becomes frayed or damaged, or if there is a sudden loss of sound during use of the instrument, or if any unusual smells or smoke should appear to be caused by it, immediately turn off the power switch, disconnect the electric plug from the outlet, and have the instrument inspected by qualified Yamaha service personnel.



### CAUTION

Always follow the basic precautions listed below to avoid the possibility of physical injury to you or others, or damage to the instrument or other property. These precautions include, but are not limited to, the following:

#### Power supply/Power cord

- When removing the electric plug from the instrument or an outlet, always hold the plug itself and not the cord. Pulling by the cord can damage it.
- Remove the electric plug from the outlet when the instrument is not to be used for extended periods of time, or during electrical storms.
- Do not connect the instrument to an electrical outlet using a multiple-connector. Doing so can result in lower sound quality, or possibly cause overheating in the outlet.

#### Assembly

- Read carefully the attached documentation explaining the assembly process. Failure to assemble the instrument in the proper sequence might result in damage to the instrument or even injury.

#### Location

- Do not expose the instrument to excessive dust or vibrations, or extreme cold or heat (such as in direct sunlight, near a heater, or in a car during the day) to prevent the possibility of panel disfiguration or damage to the internal components.
- Do not use the instrument in the vicinity of a TV, radio, stereo equipment, mobile phone, or other electric devices. Otherwise, the instrument, TV, or radio may generate noise.
- Do not place the instrument in an unstable position where it might accidentally fall over.
- Before moving the instrument, remove all connected cables.

## Connections

- Before connecting the instrument to other electronic components, turn off the power for all components. Before turning the power on or off for all components, set all volume levels to minimum. Also, be sure to set the volumes of all components at their minimum levels and gradually raise the volume controls while playing the instrument to set the desired listening level.

## Maintenance

- When cleaning the instrument, use a soft, dry or slightly damp cloth. Do not use paint thinners, solvents, cleaning fluids, or chemical-impregnated wiping cloths.

## Handling caution

- Take care that the key cover does not pinch your fingers, and do not insert a finger or hand in any gaps on the key cover or instrument.
- Never insert or drop paper, metallic, or other objects into the gaps on the key cover, panel or keyboard. If this happens, turn off the power immediately and unplug the power cord from the AC outlet. Then have the instrument inspected by qualified Yamaha service personnel.
- Do not place vinyl, plastic or rubber objects on the instrument, since this might discolor the panel or keyboard.
- Do not rest your weight on, or place heavy objects on the instrument, and do not use excessive force on the buttons, switches or connectors.
- Do not operate the instrument for a long period of time at a high or uncomfortable volume level, since this can cause permanent hearing loss. If you experience any hearing loss or ringing in the ears, consult a physician.

## Using the bench (If included)

- Do not place the bench in an unstable position where it might accidentally fall over.
- Do not play carelessly with or stand on the bench. Using it as a tool or step-ladder or for any other purpose might result in accident or injury.
- Only one person should sit on the bench at a time, in order to prevent the possibility of accident or injury.
- If the bench screws become loose due to extensive long-term use, tighten them periodically using the included tool.

## Saving data

### Saving and backing up your data

- The data of the types listed below are lost when you turn off the power to the instrument. Save the data to the USER tab display (page 26), floppy disk, SmartMedia card, or appropriate external media.
  - Recorded/Edited Songs (page 41, 133, 148)
  - Created/Edited Styles (page 107)
  - Edited Voices (page 89)
  - Memorized One Touch Settings (page 50)
  - Edited MIDI settings (page 192)

Data in the USER tab display (page 26) may be lost due to malfunction or incorrect operation. Save important data to a floppy disk, SmartMedia card, or external media.

When you change settings in a display page and then exit from that page, System Setup data (listed in the Parameter Chart of the separate Data List booklet) is automatically stored. However, this edited data is lost if you turn off the power without properly exiting from the relevant display.

Yamaha cannot be held responsible for damage caused by improper use or modifications to the instrument, or data that is lost or destroyed.

Always turn the power off when the instrument is not in use.

Thank you for purchasing this Yamaha Clavinova!  
We recommend that you read this manual carefully so that you can fully take advantage of the advanced and convenient functions of the Clavinova.  
We also recommend that you keep this manual in a safe and handy place for future reference.

## About this Owner's Manual and Data List

---

This manual consists of the following sections.

### Owner's Manual

- Introduction (page 12)..... Please read this section first.  
Quick Guide (page 23)..... This section explains how to use the basic functions.  
Basic Operation (page 57)..... This section explains how to use the basic operations including display-based controls.  
Reference (page 72) ..... This section explains how to make detailed settings for the Clavinova's various functions.  
Appendix (page 197)..... This section contains additional information such as Troubleshooting and Specifications.

### Data List

Voice List, MIDI Data Format, etc.

- The models CVP-305/303/301 will be referred to as the CVP/Clavinova in this Owner's Manual.
- The illustrations and LCD screens as shown in this owner's manual are for instructional purposes only, and may appear somewhat different from those on your instrument.
- The example Operation Guide displays shown in this Manual are in English.
- Copying of the commercially available software is strictly prohibited except for your personal use.

This product incorporates and bundles computer programs and contents in which Yamaha owns copyrights or with respect to which it has license to use others' copyrights. Such copyrighted materials include, without limitation, all computer software, style files, MIDI files, WAVE data and sound recordings. Any unauthorized use of such programs and contents outside of personal use is not permitted under relevant laws. Any violation of copyright has legal consequences. DON'T MAKE, DISTRIBUTE OR USE ILLEGAL COPIES.

- The photos of the harpsichord, bandoneon, hackbrett, music box, dulcimer and cimbalom, shown in the displays of the CVP-305/303/301, are courtesy of the Gakkigaku Shiryokan (Collection for Organology), Kunitachi College of Music.
- The following instruments, shown in the displays of the CVP-305/303/301, are on display at the Hamamatsu Museum of Musical Instruments: balafon, gender, kalimba, kanoon, santur, gamelan gong, harp, hand bell, bagpipe, banjo, carillon, mandolin, oud, pan flute, pungi, rabab, shanai, sitar, steel drum, and tambra.
- (CVP-305/303) This product is manufactured under license of U.S. Patents No.5231671, No.5301259, No.5428708, and No.5567901 from IVL Technologies Ltd.
- The bitmap fonts used in this instrument have been provided by and are the property of Ricoh Co., Ltd.
- This product utilizes NF, an embedded Internet browser from ACCESS Co., Ltd. NF is used with the patented LZW, licensed from Unisys Co., Ltd. NF may not be separated from this product, nor may it be sold, lent or transferred in any way. Also, NF may not be reverse-engineered, reverse-compiled, reverse-assembled or copied. This software includes a module developed by the Independent JPEG Group.

**ACCESS**

### Trademarks:

- Apple and Macintosh are trademarks of Apple Computer, Inc.
- Windows is the registered trademark of Microsoft® Corporation.
- SmartMedia is a trademark of Toshiba Corporation.
- All other trademarks are the property of their respective holders.

## Accessories

---

- Guide to Yamaha Online Member Product User Registration**
- “50 greats for the Piano” Music Book**
- Owner’s Manual**
- Data List**

The following items may be included or optional, depending on your locale:

- Floppy Disk Drive**
- SmartMedia card**
- Bench**

### ■ **Tuning**

Unlike an acoustic piano, the Clavinova does not need to be tuned. It always stays perfectly in tune.

### ■ **Transporting**

If you move to another location, you can transport the Clavinova along with other belongings. You can move the unit as it is (assembled) or you can disassemble the unit down to the condition it was in when you first took it out of the box. Transport the keyboard horizontally. Do not lean it up against a wall or stand it up on its side. Do not subject the instrument to excessive vibration or shock.

When transporting the assembled Clavinova, make sure all screws are properly tightened and have not been loosened by moving the instrument.

# Table of Contents

## Introduction

Welcome to the Wonderful Musical World of the Clavinova CVP! .....	10
Panel Controls .....	12
Playing the Keyboard .....	14
Setting Up the Clavinova .....	16
Music Rest .....	16
Sheet Music Braces .....	17
Using Headphones .....	17
Changing the Display Language .....	18
Display Settings .....	19
Handling the Floppy Disk Drive (FDD) and Floppy Disks .....	21
Handling SmartMedia™*Memory Cards .....	22

## Quick Guide

Playing the Demos .....	23
Operations in the Basic Displays .....	25
Operation of the Main Display .....	25
Operation of the File Selection Display .....	25
Operation of the Function Display .....	26
Playing Voices .....	28
Playing the Piano Voice .....	28
Playing Various Voices .....	31
Practicing with the Preset Songs .....	34
Playing Back Songs Before Practicing .....	34
One-handed Practice with the Guide Lamps .....	38
Practicing with the Repeat Playback Function .....	40
Recording Your Performance .....	41
Playing Backing Parts with the performance assistant Technology .....	42
Playing Accompaniment with the Auto Accompaniment Feature (Style Playback) .....	44
Playing “Mary Had a Little Lamb” with the Auto Accompaniment Feature .....	44
Calling Up Ideal Setups for Each Song —Music Finder .....	50
Singing Along with Song Playback (Karaoke) or Your Own Performance .....	52
Connecting a Microphone (CVP-305/303) .....	52
Singing with the Lyrics Display .....	53
Convenient Functions for Karaoke .....	53
Convenient Functions for Singing Along with Your Own Performance .....	55

## Basic Operation

Trying Out the Basic Features (Help) .....	57
The Messages Shown in the Display .....	57
Instant Selection of the Displays —Direct Access .....	58
Basic Displays (Main Display and File Selection Display) .....	59
Main Display .....	59
File Selection Display Configuration and Basic Operation .....	60
File/Folder Operations in the File Selection Display ..	62
Restoring the Factory-programmed Settings ...	69
Restoring the Factory-programmed System .....	69
Restoring the Factory-programmed Settings Independently by Item .....	69
Saving and Recalling Your Original Settings as a Single File .....	70
Data Backup .....	71

## Reference

Using, Creating and Editing Voices ..	72
Voice Characteristics .....	72
Playing Different Voices Simultaneously .....	73
Keyboard Parts (Right 1, Right 2, Left) .....	73
Playing Two Voices Simultaneously (Right 1 and 2 Parts) .....	74
Playing Different Voices with the Left and Right Hands (Right 1 and Left Parts) .....	75
Changing Pitch .....	76
Transpose .....	76
Fine-tuning the Pitch of the Entire Instrument .....	76
Scale Tuning .....	76
Adding Effects to Voices Played on the Keyboard .....	78
Editing the Volume and Tonal Balance (MIXING CONSOLE) .....	80
Basic Procedure .....	80
Voice Creating (Sound Creator) .....	89
Basic Procedure .....	89
Creating Your Original Organ Flutes Voices .....	93

Various display pages and menus appear on the LCD display of this instrument, indicating the functions and operations. Throughout this manual, arrows are used in the instructions, indicating in shorthand the process of calling up these functions. The example shorthand below describes a four step operation:

1) press the [FUNCTION] button, 2) press the [D] button to select the Controller page, 3) press the TAB [▶] button to select the Keyboard/Panel page, and 4) press the [A] button to select the Initial Touch parameter.

[FUNCTION] → [D] CONTROLLER → TAB [▶] KEYBOARD/PANEL → [A] 1 INITIAL TOUCH

## **Using, Creating and Editing the Auto Accompaniment Styles .....97**

Style Characteristics .....	97
Selecting a Chord Fingering Type .....	97
Playing Only the Rhythm Channels of a Style ...	98
Style Playback-related Settings .....	100
<b>Editing the Volume and Tonal Balance of the Style (MIXING CONSOLE) .....</b>	<b>102</b>
<b>Convenient Music Finder feature .....</b>	<b>102</b>
Searching the Records .....	102
Creating a Set of Favorite Records .....	103
Editing Records .....	104
Saving the Record .....	105
<b>Style Creator .....</b>	<b>107</b>
Style Structure .....	107
Creating a Style .....	107
Editing the Created Style .....	113

## **Registering and Recalling Custom Panel Setups—Registration Memory .....121**

<b>Registering and Saving Custom Panel Setups .....</b>	<b>121</b>
<b>Recalling the Registered Panel Setups .....</b>	<b>122</b>
Deleting an Unneeded Panel Setup/Naming a Panel Setup .....	123
Disabling Recall of Specific Items (Freeze Function) .....	123
Calling Up Registration Memory Numbers in Order—Registration Sequence .....	124

## **Using, Creating and Editing Songs .....126**

<b>Compatible Song Types .....</b>	<b>126</b>
<b>Operations for Song Playback .....</b>	<b>127</b>
<b>Adjusting the Volume Balance and Voice Combination, etc. (MIXING CONSOLE) .....</b>	<b>130</b>
<b>Using the Practice Function (Guide) .....</b>	<b>131</b>
Selecting the Guide Function Type .....	131
<b>Recording Your Performance .....</b>	<b>133</b>
Recording Methods .....	133
Editing a Recorded Song .....	148

## **Using a Microphone (CVP-305/303) .....157**

<b>Editing Vocal Harmony Parameters .....</b>	<b>157</b>
<b>Adjusting the Microphone and Harmony Sound .....</b>	<b>160</b>
<b>Talk Setting .....</b>	<b>164</b>

## **Connecting the Clavinova Directly to the Internet .....166**

<b>Connecting the Instrument to the Internet ...</b>	<b>166</b>
<b>Accessing the Special Clavinova Website .....</b>	<b>167</b>
<b>Operations in the Special Clavinova Website .....</b>	<b>167</b>
Scrolling the Display .....	167
Following Links .....	168
Entering Characters .....	168
Return to the Previous Web Page .....	169
Refreshing a Web Page/Canceling Loading of a Web Page .....	170
Purchasing and Downloading Data .....	170
Saving Bookmarks of Your Favorite Pages .....	171
Changing the Home Page .....	174
About the Internet Settings Display .....	175
Initializing Internet Settings .....	178
<b>Glossary of Internet Terms .....</b>	<b>179</b>

## **Using Your Instrument with Other Devices .....180**

<b>Using Headphones ([PHONES] jacks) .....</b>	<b>180</b>
<b>Connecting a Microphone or Guitar ([MIC./LINE IN] jack) (CVP-305/303) .....</b>	<b>180</b>
<b>Connecting Audio &amp; Video Devices .....</b>	<b>180</b>
Using External Audio Devices for playback and Recording ([AUX OUT] Jacks, [AUX OUT (LEVEL FIXED)] Jacks, [OPTICAL OUT] Jack) .....	180
Playing External Audio Devices with the Built-in Speakers ([AUX IN] Jacks) .....	181
Showing the Instrument's Display Contents on a Separate TV Monitor (CVP-305) .....	181

## **Using the Footswitch or Foot Controller ([AUX PEDAL] jack) .....182**

Assigning Specific Functions to Each Foot Pedal ..	182
<b>Connecting External MIDI Devices ([MIDI] Terminals) .....</b>	<b>185</b>
<b>Connecting a Computer or USB Device .....</b>	<b>185</b>
Connecting a Computer ([USB TO HOST] and [MIDI] Terminals) .....	185
Connecting to a USB-type LAN Adaptor and USB Storage Device (via the [USB TO DEVICE] Terminal) .....	186

## **What is MIDI? .....188**

## **What You Can Do With MIDI .....191**

<b>MIDI Settings .....</b>	<b>192</b>
Basic Operation .....	192
Pre-Programmed MIDI Templates .....	192
MIDI System Settings .....	194
MIDI Transmit Settings .....	194
MIDI Receive Settings.....	195
Setting the Bass Note for Style Playback via MIDI Receive .....	195
Setting the Chord Type for Style Playback via MIDI Receive .....	196



## Appendix

Troubleshooting .....	197
CVP-305: Keyboard Stand Assembly .....	202
CVP-303: Keyboard Stand Assembly .....	204
CVP-301: Keyboard Stand Assembly .....	206
Installing the Floppy Disk Drive (Included/Optional) .....	208
Specifications .....	209
Index .....	211

---

## Introduction

---

---

## Quick Guide

---

---

## Basic Operation

---

---

## Reference

Using, Creating and Editing Voices

---

Using, Creating and Editing the Auto  
Accompaniment Styles

---

Registering and Recalling Custom Panel Setups

---

Using, Creating and Editing Songs

---

Using a Microphone

---

Connecting the Clavinova Directly to the  
Internet

---

Using Your Instrument with Other  
Devices

---

---

## Appendix

---

## Authentic Acoustic Piano-like Touch with Graded Hammer (GH) and Graded Hammer 3 (GH3) Keyboard

The Clavinova is the next best thing to a real piano. It features an exceptional natural piano touch and expressive response—thanks to the remarkable Graded Hammer keyboard. Just as on an actual grand piano, the lower keys are heavy in touch and the higher keys are light, with all the natural gradations in between.

The CVP-305 features the enhanced, improved Graded Hammer 3 (GH3) technology, providing performance functions and expressive power found only on grand pianos, such as having repeated plays of the same note perfectly articulated, even when playing at high speed or with partial key release.

## Playing the Clavinova

### Playing Piano Voices ..... page 28

With just the press of a button, you can reconfigure the entire Clavinova for optimum piano performance, no matter what settings you've made from the panel. Now you can enjoy performing and practicing with authentic grand piano sounds and response—instantly.



### Playing Other Instrument Voices ..... page 31

The Clavinova gives you not only various realistic piano Voices, but also features an exceptionally wide variety of authentic instruments, both acoustic and electronic.

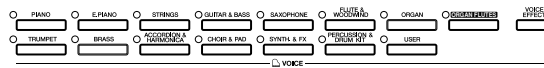

### Perform Along with a Full Band —Song Playback..... page 34

Play along with previously recorded Song data, and fill out your solo performance with the sounds and arrangement of an entire band or orchestra.



### Ease in Playing Backing Parts with Songs, —performance assistant technology ..... page 42

The new performance assistant technology features make it exceptionally easy to play professional-sounding backing parts along with Song playback.



### Playing Melodies along with Auto Accompaniment, —Style Playback ..... page 44

Use the Style playback features to automatically produce full backing parts and accompaniment, while you play melodies on top. It's like having an expert ensemble playing behind you. Select an accompaniment Style—such as pop, jazz, Latin, etc.—and let the Clavinova be your backing band!

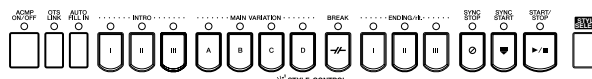

## Practicing

**Displaying and Playing along with the Music Score .....page 56**

While playing back a Song, you can have the music score (notation) automatically shown on the display—an exceptionally convenient tool for learning and practicing pieces.



**Guide Lamps .....page 38**

The key guide lamps are also helpful in learning and practicing, since they indicate the notes you should play, when you should play them, and how long you should hold them down.



**Recording Your Performances ..... page 41**

The Clavinova lets you easily record your own performances and save them to internal memory or a SmartMedia card. This, too, is an excellent practice tool, letting you listen back to your playing and spot your strong and weak points.



## Expand Your Song Collection

**Internet Direct Connection ..... page 166**

The Clavinova also connects directly to the Internet, letting you download Song data from special websites, and save them to internal memory or a SmartMedia card.

# Panel Controls

The panel shown below is that of the CVP-305.

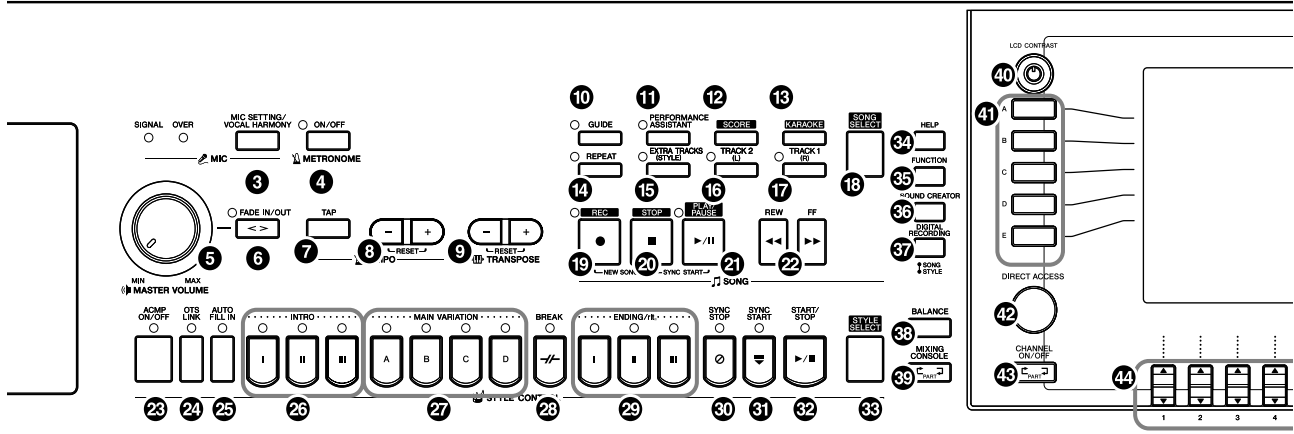

1 [POWER] switch .....	P. 14
2 SmartMedia slot .....	P. 22
<b>MIC. (CVP-305/303)</b>	
3 [MIC SETTING/VOCAL HARMONY] button .....	P. 54
<b>METRONOME</b>	
4 [ON/OFF] button .....	P. 30
<b>VOLUME</b>	
5 [MASTER VOLUME] dial .....	P. 15
6 [FADE IN/OUT] button .....	P. 46
<b>TEMPO</b>	
7 [TAP] button .....	P. 46
8 [-][+] buttons .....	P. 30
<b>TRANPOSE</b>	
9 [-] [+] buttons .....	P. 53
<b>SONG</b>	
10 [GUIDE] button .....	P. 38
11 [PERFORMANCE ASSISTANT] button .....	P. 42
12 [SCORE] button .....	P. 37
13 [KARAOKE] button .....	P. 53
14 [REPEAT] button .....	P. 40
15 [EXTRA TRACKS (STYLE)] button .....	P. 134
16 [TRACK 2 (L)] button .....	P. 40
17 [TRACK 1 (R)] button .....	P. 38
18 [SONG SELECT] button .....	P. 34
19 [REC] button .....	P. 41
20 [STOP] button .....	P. 35
21 [PLAY/PAUSE] button .....	P. 35
22 [REW]/[FF] buttons .....	P. 128

## STYLE CONTROL

23 [ACMP ON/OFF] button .....	P. 45
24 [OTS LINK] button .....	P. 50
25 [AUTO FILL IN] button .....	P. 47
26 INTRO [I]/[II]/[III] buttons .....	P. 46
27 MAIN VARIATION [A]/[B]/[C]/[D] buttons .....	P. 47
28 [BREAK] button .....	P. 47
29 ENDING/rit. [I]/[II]/[III] buttons .....	P. 47
30 [SYNC STOP] button .....	P. 47
31 [SYNC START] button .....	P. 46
32 [START/STOP] button .....	P. 46
33 [STYLE SELECT] button .....	P. 45
34 [HELP] button .....	P. 57
35 [FUNCTION] button .....	P. 26
36 [SOUND CREATOR] button .....	P. 89
37 [DIGITAL RECORDING] button .....	P. 113, 137
38 [BALANCE] button .....	P. 39
39 [MIXING CONSOLE] button .....	P. 80
40 [LCD CONTRAST] knob .....	P. 19
41 [A]-[J] buttons .....	P. 25
42 [DIRECT ACCESS] button .....	P. 58
43 [CHANNEL ON/OFF] button .....	P. 99, 133
44 [1 ▲ ▼] - [8 ▲ ▼] buttons .....	P. 25
45 TAB [◀] [▶] buttons .....	P. 26
46 [EXIT] button .....	P. 26
47 [DEMO] button .....	P. 23
48 [MUSIC FINDER] button .....	P. 50
49 [DATA ENTRY] dial .....	P. 61
50 [ENTER] button .....	P. 61

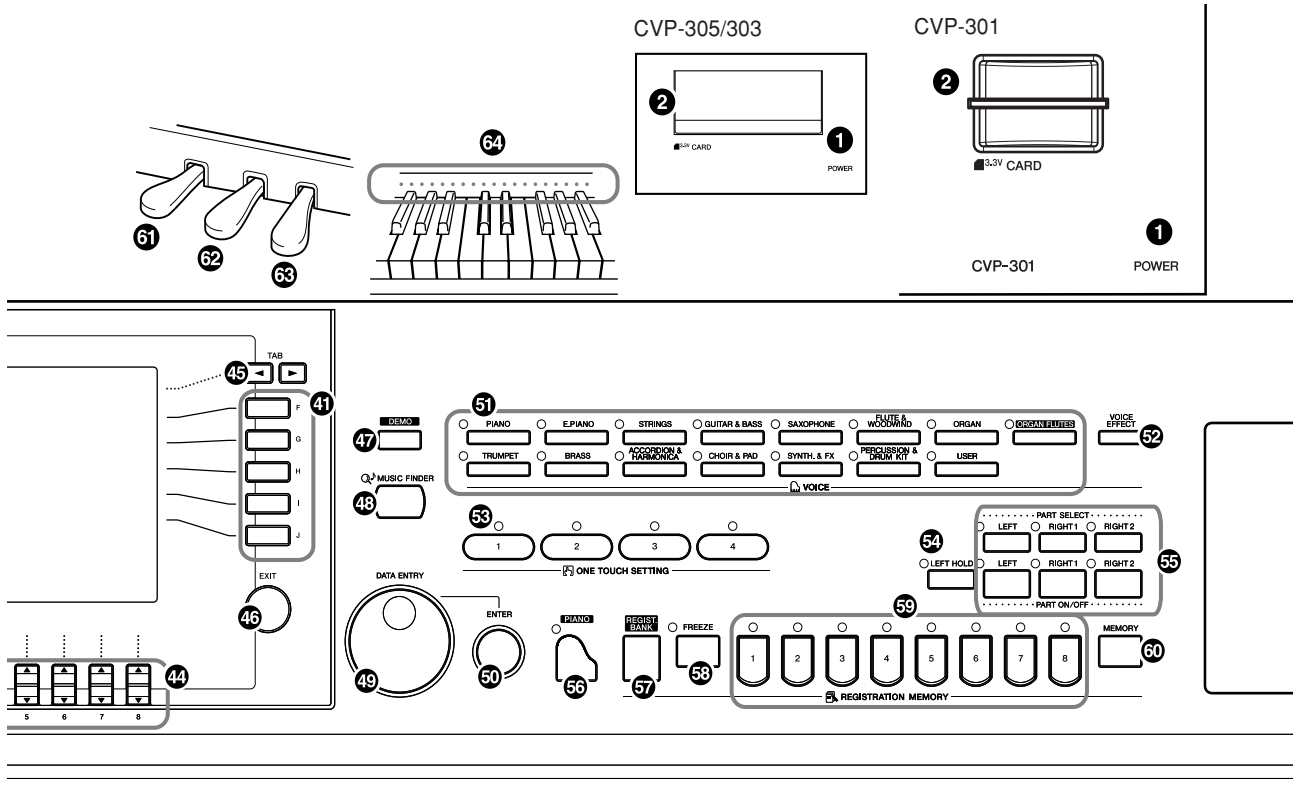

**VOICE**

- 61 VOICE buttons ..... P. 31
- 52 [VOICE EFFECT] button ..... P. 78

**ONE TOUCH SETTING**

- 53 [1]–[4] buttons ..... P. 49
- 54 [LEFT HOLD] button ..... P. 48

**PART**

- 55 PART buttons ..... P. 73

**PIANO Setting**

- 56 [PIANO] button ..... P. 28

**REGISTRATION MEMORY**

- 57 [REGIST. BANK] button ..... P. 122
- 58 [FREEZE] button ..... P. 123
- 59 [1]–[8] buttons ..... P. 121
- 60 [MEMORY] button ..... P. 121

**Pedals**

- 61 Left pedal ..... P. 29
- 62 Sostenuto pedal ..... P. 29
- 63 Damper pedal ..... P. 29
- 64 Keyboard guide lamps ..... P. 38

For information on the jacks and connectors located on the bottom left of the instrument, see page 180.

# Playing the Keyboard

## 1 Connecting the power cable.

First insert the plug of the power cable into the AC connector on the Clavinova, then plug the other end of the cable into the proper AC outlet on the wall.

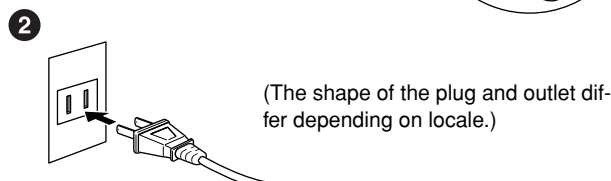
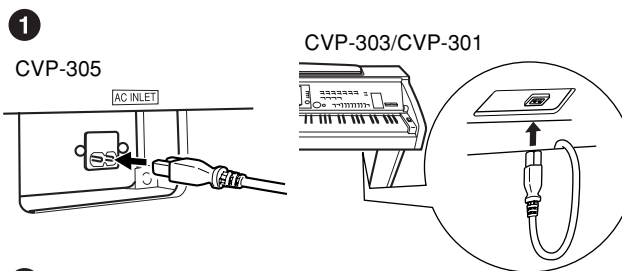

## 2 Opening the key cover

CVP-305/CVP-303: Using the hand grip on the front, lift open the key cover.  
CVP-301: Lift the cover slightly, then push and slide it open.

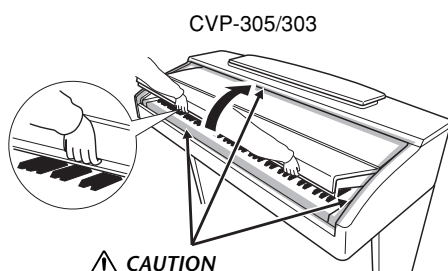

**CAUTION**  
Be careful to avoid catching your fingers when opening the cover.

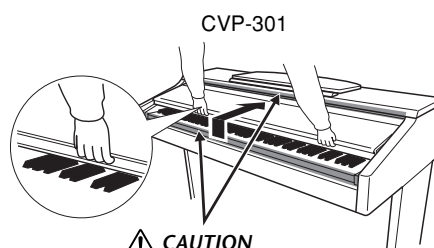

**CAUTION**  
Be careful to avoid catching your fingers when opening the cover.

### CAUTION

Hold the cover with both hands when opening or closing it. Do not release it until it is fully opened or closed. Be careful to avoid catching fingers (yours or others, especially children's) between the cover and the unit.

### CAUTION

Do not place objects such as a piece of metal or paper on top of the key cover. Small objects placed on the key cover may fall inside the unit when the cover is opened and may be nearly impossible to remove. This could cause electric shock, short circuit, fire or other serious damage to the instrument.

## 3 Turning the power on

Press the [POWER] switch located on the right of the keyboard to turn the power on. The display located in the center of the front panel and the power indicator located below the left end of the keyboard lights up.

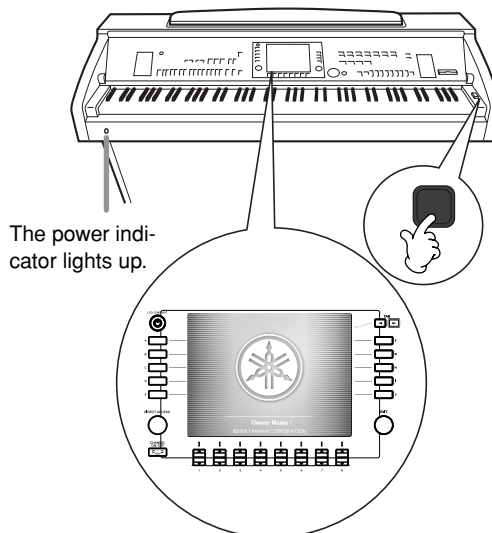

## 4 Playing the keyboard

Play the keyboard to produce sound.

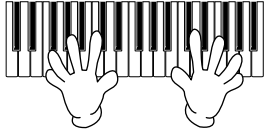

### Adjusting the volume

While playing the keyboard, adjust the volume level by using the [MASTER VOLUME] located at the left of the panel.

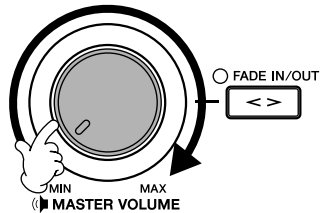

## 5 Turning the power off

Press the [POWER] switch to turn the power off.  
The screen and the power indicator turn off.

## 6 Closing the key cover

CVP-305/CVP-303: Grip the metal rim at the top of the panel, and close the key cover.

CVP-301: Slide the cover toward you and gently lower the cover over the keys.

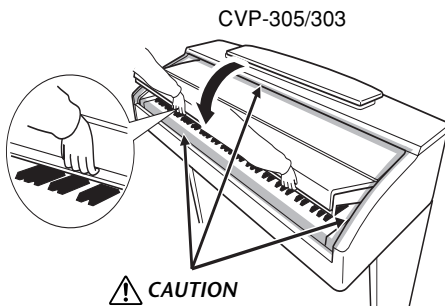

**CAUTION**  
Be careful to avoid catching your fingers when closing the cover.

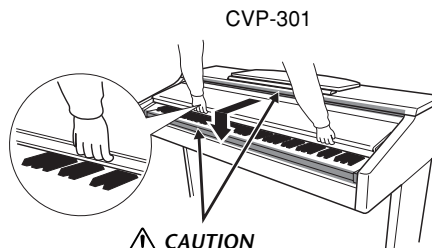

**CAUTION**  
Be careful to avoid catching your fingers when closing the cover.

**CAUTION**

When raising or lowering the music rest, do not release your hands from the music rest until it is all the way up or down.

**CAUTION**

Do not try to use the music rest in a half-raised position.

**CAUTION (CVP-305/303)**

Before lowering the music rest, close the sheet music braces (see page 17). The music rest will not close unless the sheet music braces are also closed.

## Music Rest

### To Raise the Music Rest:

CVP-305/303:

Pull the music rest toward yourself as far as it will go.

When raised, the music rest is fixed at a certain angle and cannot be adjusted.

CVP-301:

- 1 Pull the music rest up and toward yourself as far as it will go.
- 2 Flip down the two metal supports at the left and right on the rear of the music rest.
- 3 Lower the music rest so that it rests on the metal supports.

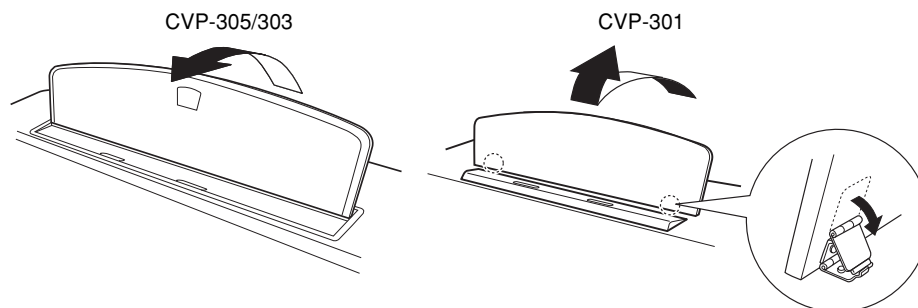

### To Lower the Music Rest:

CVP-305/303:

Lift the music rest slightly, then turn it back slowly.

CVP-301:

- 1 Pull the music rest toward yourself as far as it will go.
- 2 Raise the two metal supports (at the rear of the music rest).
- 3 Gently lower the music rest backward until it is all the way down.

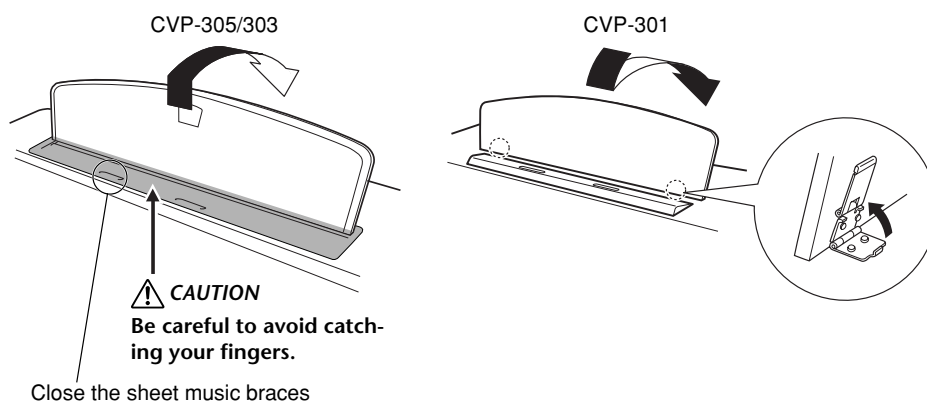



## Sheet Music Braces

These braces are for holding the pages of music books in place.

### To Open

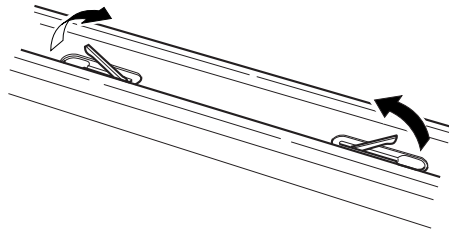

### To Close

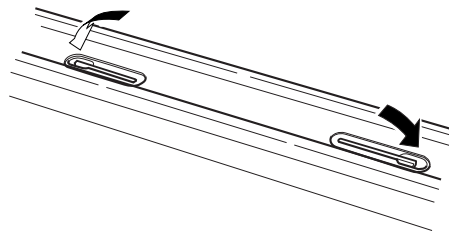

## Using Headphones

Connect a pair of headphones to one of the [PHONES] jacks located on the bottom left of the instrument.

Two sets of standard stereo headphones can be connected. (If you are using only one pair of headphones, you can plug them into either of these jacks.)

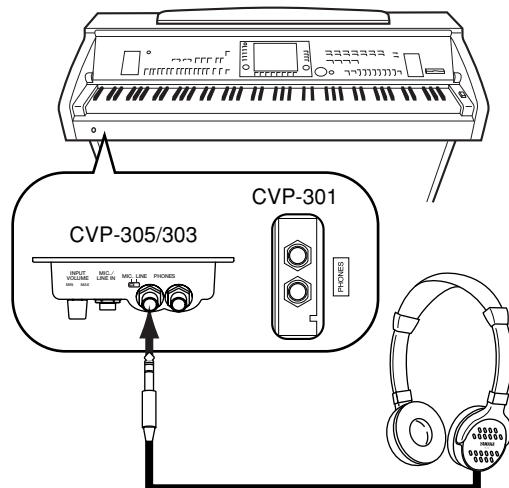

### ⚠ CAUTION

Do not listen with the headphones at high volume for long periods of time. Doing so may cause hearing loss.

**CAUTION**

Do not hang anything other than the headphones on the hanger. Otherwise, the Clavinova or the hanger may be damaged.

## Using the Headphone Hanger

A headphone hanger is included in the Clavinova package so that you can hang the headphones on the Clavinova. Install the headphone hanger using included two screws (4 x 10mm) as shown in the figure.

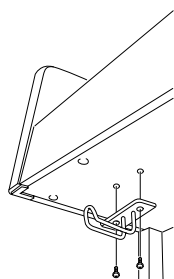

CVP-305/303

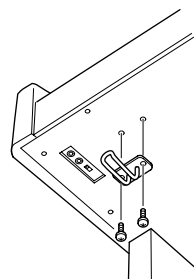

CVP-301

### Outputting sound from the speaker while headphones are connected

- 1 Call up the operation display.  
[FUNCTION] → [I] UTILITY → TAB[◀][▶] CONFIG 2
- 2 Press the [5 ▼]/[6 ▼] (SPEAKER) button to select "ON."

### Outputting sound only from the headphones

From the display called up in step 1 above, press the [5 ▼]/[6 ▼] (SPEAKER) button to select "OFF."

When "OFF" is selected, the speakers will not sound and you can only hear the Clavinova sound via the headphones.

## Changing the Display Language

This determines the language used in the display for messages, file names, and character input.

- 1 Call up the operation display.  
[FUNCTION] → [I] UTILITY → TAB[◀][▶] OWNER
- 2 Press the [4 ▲ ▼]/[5 ▲ ▼] button to select a language.

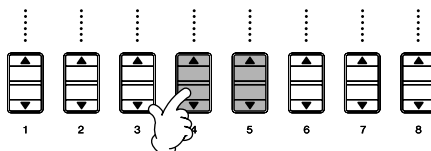
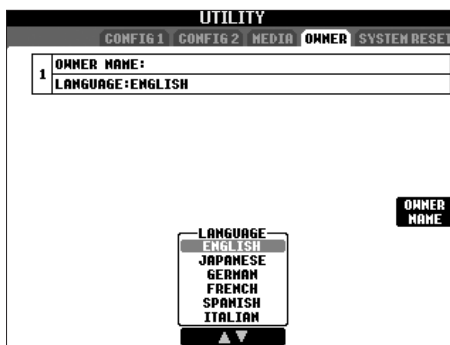

# Display Settings

## Adjusting the Contrast of the Display

You can adjust the contrast of the display by turning the [LCD CONTRAST] knob located to the left of the display.

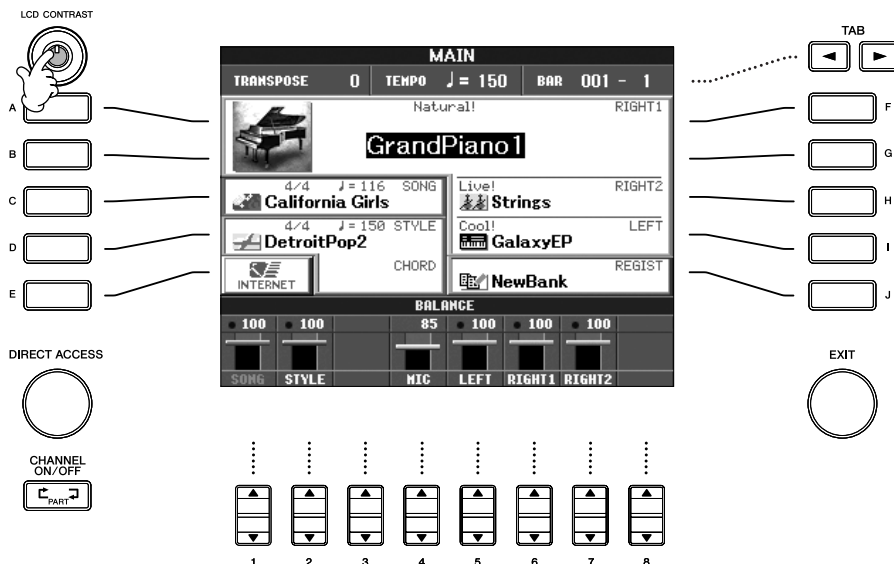

## Adjusting the Brightness of the Display (CVP-305/303)

Adjust the brightness of the display.

- 1 Call up the operation display.  
[FUNCTION] → [I] UTILITY → TAB[◀][▶] CONFIG 2
- 2 Press the [2▲▼] button to adjust the brightness of the display.

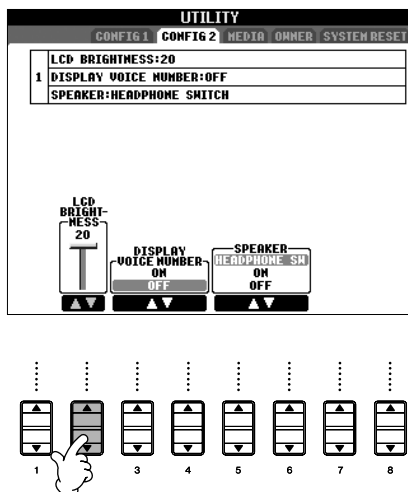

## Entering the Owner Name in the Opening Display

You can have your name appear in the opening display (the display that first appears when the power is turned on).



- 1 **Call up the operation display.**  
[FUNCTION] → [I] UTILITY → TAB[◀][▶] OWNER
- 2 **Press the [I] (OWNER NAME) button and call up the Owner Name display.**  
Refer to page 67 for character-entry details.

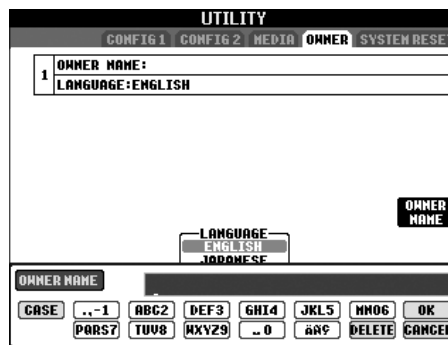

### Displaying the version number

To check the version number of this instrument, press and hold the [I] (OWNER NAME) button in the display in step 2 above.

# Handling the Floppy Disk Drive (FDD) and Floppy Disks

**(The floppy disk drive may be included or optional, depending on your locale. For instructions on installing the floppy disk drive, see page 208.)**

The floppy disk drive lets you save original data you've created on the instrument to floppy disk, and allows you to load data from floppy disk to the instrument. Be sure to handle floppy disks and treat the disk drive with care. Follow the important precautions below.

## Floppy Disk Compatibility

- 3.5" 2DD and 2HD type floppy disks can be used.

## Formatting a Floppy Disk

- If you find that you are unable to use new, blank disks or old disks that have been used with other devices, you may need to format them. For details on how to format a disk, see page 62. Keep in mind that all data on the disk will be lost after formatting. Make sure to check beforehand whether or not the disk contains important data.

### NOTE

Floppy disks formatted on this device may or may not be useable as is on other devices.

## Inserting/Removing Floppy Disks

### Inserting a Floppy Disk into the Disk Drive:

- Hold the disk so that the label of the disk is facing upward and the sliding shutter is facing forward, towards the disk slot. Carefully insert the disk into the slot, slowly pushing it all the way in until it clicks into place and the eject button pops out.

### NOTE

Never insert anything but floppy disks into the disk drive. Other objects may cause damage to the disk drive or floppy disks.

### Removing a Floppy Disk

- After checking that the instrument is not accessing\* the floppy disk (checking that the use lamp on the floppy disk drive is off), firmly press the eject button at the upper right of the disk slot all the way in. When the floppy disk is ejected, pull it out of the drive. If the floppy disk cannot be removed because it is stuck, do not try to force it, but instead try pressing the eject button again, or try re-inserting the disk and attempt to eject it again.

\* Access of the disk indicates an active operation, such as recording, playback, or deletion of data. If a floppy disk is inserted while the power is on, the disk is automatically accessed, since the instrument checks whether the disk has data.

### CAUTION

Do not remove the floppy disk or turn off the instrument itself while the disk is being accessed. Doing so may result not only in loss of data on the disk but also damage to the floppy disk drive.

- Be sure to remove the floppy disk from the disk drive before turning off the power. A floppy disk left in the drive for extended periods can easily pick up dust and dirt that can cause data-read and -write errors.

## Cleaning the Disk Drive Read/Write Head

- Clean the read/write head regularly. This instrument employs a precision magnetic read/write head which, after an extended period of use, will pick up a layer of magnetic particles from the disks used that will eventually cause read and write errors.
- To maintain the disk drive in optimum working order Yamaha recommends that you use a commercially-available dry-type head cleaning disk to clean the head about once a month. Ask your Yamaha dealer about the availability of proper headcleaning disks.

## About Floppy Disks

### Handle floppy disks with care, and follow these precautions:

- Do not place heavy objects on a disk or bend or apply pressure to the disk in any way. Always keep floppy disks in their protective cases when they are not in use.
- Do not expose the disk to direct sunlight, extremely high or low temperatures, or excessive humidity, dust or liquids.
- Do not open the sliding shutter and touch the exposed surface of the floppy disk inside.
- Do not expose the disk to magnetic fields, such as those produced by televisions, speakers, motors, etc., since magnetic fields can partially or completely erase data on the disk, rendering it unreadable.
- Never use a floppy disk with a deformed shutter or housing.
- Do not attach anything other than the provided labels to a floppy disk. Also make sure that labels are attached in the proper location.

### To Protect Your Data (Write-protect Tab):

- To prevent accidental erasure of important data, slide the disk's write-protect tab to the "protect" position (tab open). When saving data, make sure that the disk's write-protect tab is set to the "overwrite" position (tab closed).

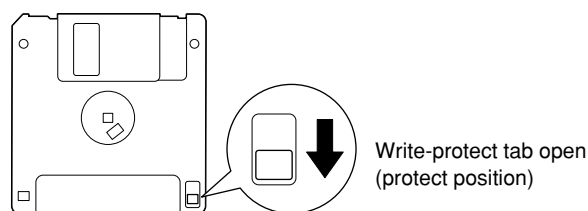

# Handling SmartMedia™\*Memory Cards

**\*SmartMedia is a trademark of Toshiba Corporation.**

This instrument features a built-in SmartMedia card slot (on the front panel). It lets you save original data you've created on the instrument to a SmartMedia card, and allows you to load data from a card to the instrument. Be sure to handle SmartMedia cards with care. Follow the important precautions below.

## Compatible SmartMedia Types

- 3.3V (3V) SmartMedia can be used. 5V type SmartMedia is not compatible with this instrument.
- SmartMedia cards of seven different memory capacities of (2MB, 4MB, 8MB, 16MB, 32MB, 64MB, and 128MB) can be used with the instrument. SmartMedia cards greater than 32MB can be used if they conform to the SSFDC Forum standard.

### **NOTE**

SSFDC is an abbreviation for Solid State Floppy Disk Card (another name for SmartMedia cards). The SSFDC Forum is a voluntary organization established for the promotion of SmartMedia.

## Formatting SmartMedia Cards

If you find that you are unable to use new, blank SmartMedia cards or cards that have been used with other devices, you may need to format them. For details on how to format a SmartMedia card, see page 62. Keep in mind that all data on the card will be lost after formatting. Make sure to check beforehand whether or not the card contains important data.

### **NOTE**

SmartMedia cards formatted on this device may or may not be useable as is on other devices.

## Inserting/Removing SmartMedia Cards

### Inserting SmartMedia Cards

- CVP-305/303:  
Insert the SmartMedia card with the terminal (gold-plated) side face down into the card slot, until it clicks into place.
- CVP-301:  
Insert the SmartMedia card with the terminal (gold-plated) side face down into the card slot, until it fits into place.
- Do not insert the SmartMedia card in the wrong direction.
- Do not insert anything other than a SmartMedia card in the slot.

### Removing SmartMedia Cards

- CVP-305/303:  
After making sure that the instrument is not accessing\* the SmartMedia card, insert the card until it clicks into place and release it. When the SmartMedia card is ejected, pull it out of the drive. If the card cannot be removed because it is stuck, do not try to force it, but instead try re-inserting the card completely into the slot and attempt to eject it again.

- CVP-301:  
Before removing the SmartMedia card, be sure to confirm that the card is not in use, or it is not being accessed by the instrument. Then pull the card out slowly by hand. If the SmartMedia card is being accessed\*, a message indicating that it is in use appears on the instrument's display.

\* Accessing includes saving, loading, formatting, deleting and making directory. Also, be aware that the instrument will automatically access the SmartMedia to check the media type when it is inserted while the instrument is turned on.

### **CAUTION**

**Never attempt to remove the SmartMedia card or turn the power off during accessing. Doing so can damage the data on the instrument or card and possibly damage the SmartMedia card itself.**

## About SmartMedia Cards

### Handle SmartMedia cards with care, and follow these precautions:

- There are times when static electricity affects SmartMedia. Before you touch a SmartMedia card, touch something metallic such as a door knob and aluminum sash, to reduce the possibility of static electricity.
- Be sure to remove the SmartMedia card from the SmartMedia slot when it is not in use for a long time.
- Do not expose the SmartMedia to direct sunlight, extremely high or low temperatures, or excessive humidity, dust or liquids.
- Do not place heavy objects on a SmartMedia card or bend or apply pressure to the card in any way.
- Do not touch the gold-plated terminals of the SmartMedia card or put any metallic plate onto the terminals.
- Do not expose the SmartMedia card to magnetic fields, such as those produced by televisions, speakers, motors, etc., since magnetic fields can partially or completely erase data on the SmartMedia, rendering it unreadable.
- Do not attach anything other than the provided labels to a SmartMedia. Also make sure that labels are attached in the proper location.

### To Protect Your Data (Write-protect):

- To prevent inadvertent erasure of important data, affix the write-protect seal (provided in the SmartMedia package) onto the designated area (within the circle) of the SmartMedia card. Conversely, to save data on the SmartMedia card, make sure to remove the write-protect seal from the card.
- Do not reuse a seal that has been peeled off.

## Playing the Demos

The Demos are more than just songs—they also provide helpful, easy-to-understand introductions to the features, functions and operations of the instrument. In a way, the Demos are an interactive “mini-manual”—complete with sound demonstrations and text showing what it can do for you.

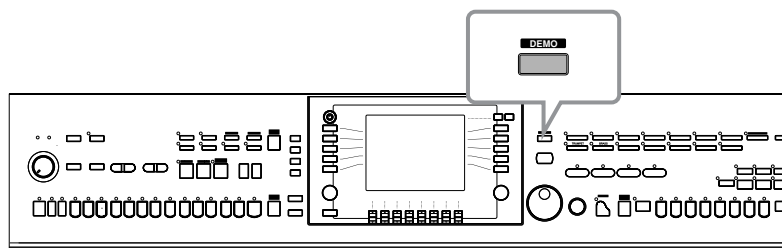

### 1 Select the desired Language.

1 Press the [HELP] button to call up the language selection display.

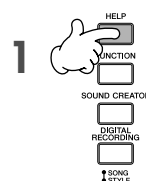

2 Press the [6 ▲ ▼]/[7 ▲ ▼] buttons to select the desired language.

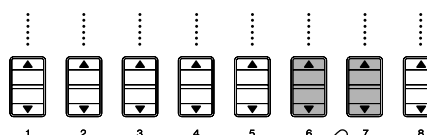
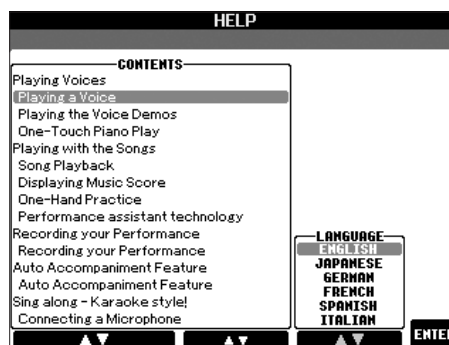

2

### 2 Press the [DEMO] button to start the Demos.

Demos will play back continuously until stopped.



### 3 Press the [EXIT] button to stop the Demo playback.

When the Demo stops, the display returns to the MAIN display.



# Showing Specific Demo Topics

**1 Press the [7▲▼]/[8▲▼] buttons in the Demo display to call up the specific Demo menu.**

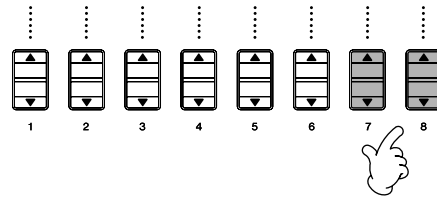

**2 Press one of the [A]–[I] buttons to show a specific Demo.**

To return back to the previous display, press the [J] button.

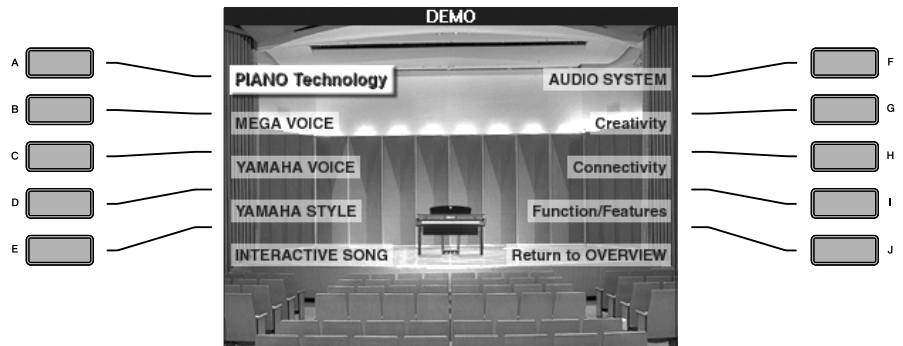

**When the Demo has more than one screen.**  
Press a [▼] button corresponding to the screen number.

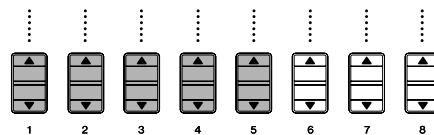

**3 Press the [EXIT] button to exit from Demo.**





# Operations in the Basic Displays

To start with, you should know a little about the basic displays that appear in the Quick Guide. There are three basic displays:

- Main display** > See below.
- File selection display** > See below.
- Function display** > page 26

## Operation of the Main Display

The Main display shows the basic settings and important information for the instrument (It is the same display that appears when the instrument is turned on.). You can also call up display pages related to the displayed function from the Main display.

**NOTE** About information in the Main display  
See page 59.

### 1 [A]–[J] buttons

The [A]–[J] buttons correspond to the settings indicated next to the buttons.  
For example, press the [F] button, and the Voice (RIGHT 1) selection display will appear in the display.

### 2 [1▲▼]–[8▲▼] buttons

The [1▲▼]–[8▲▼] buttons correspond to the parameters which are indicated above the buttons. (On CVP-301, open the volume balance display by pressing the [BALANCE] button.)  
For example, pressing the [1▲] button will increase the Song (page 34) volume.

### 3 [DIRECT ACCESS] and [EXIT] buttons

Here's a convenient way to return to the Main display from any other display: Simply press the [DIRECT ACCESS] button, then the [EXIT] button.

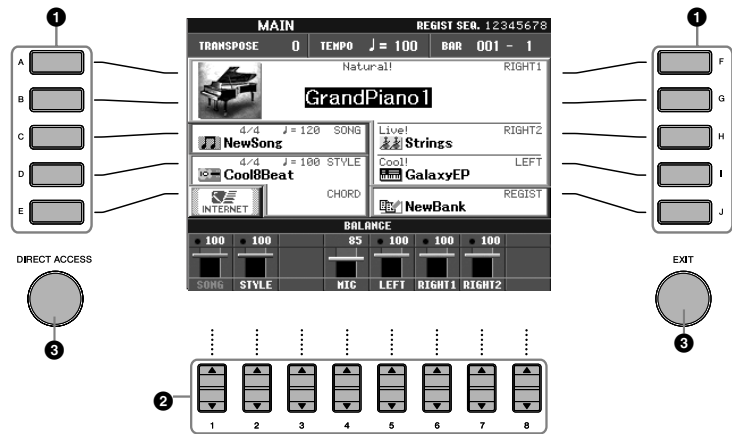

## Operation of the File Selection Display

In the File Selection display, you can select the Voice (page 28)/Song (page 34)/Style (page 44), etc. In the example here, we'll call up and use the Song Selection display.

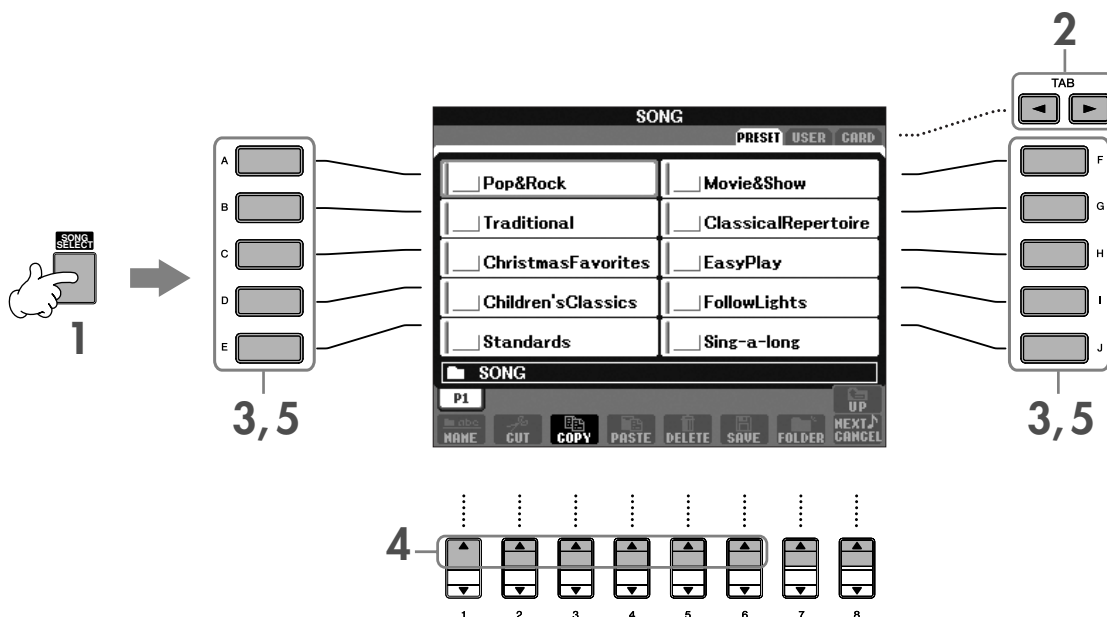

### 1 Press the [SONG SELECT] button to call up the Song Selection display.

### 2 Press the TAB [◀]/[▶] buttons to select the desired drive (PRESET/USER/CARD).

#### About PRESET/USER/CARD

PRESET ..... Internal memory to which the preprogrammed data are installed as preset data.

USER ..... Internal memory that allows both reading and writing of data.

CARD ..... For transferring data to and from SmartMedia, with the CVP's card slot.

**NOTE** When the USB storage device such as the Floppy Disk drive will be connected to the USB [TO DEVICE] connector, "USB" will be displayed on the File Selection display (See page 186, "Using USB Storage Devices," Step2.).

### 3 Select a folder (if necessary).

Several Songs may be together in a folder. In this case, the folder(s) will appear in the display (see the illustration at right). Press one of the [A]–[J] buttons to select a folder.

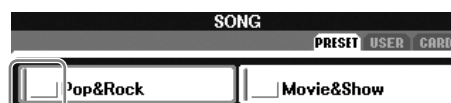

### 4 Select a page (if the display has several pages).

When the drive contains more than ten Songs, the display is divided up into several pages. The page indications are shown at the bottom of the display. Press one of the [1 ▲]–[6 ▲] buttons to select a page.

### 5 Press one of the [A]–[J] buttons to select a Song.

You can also select a Song by using the [DATA ENTRY] dial, then press the [ENTER] button to execute.

### 6 Press the [EXIT] button to return to the previous display.

## Operation of the Function Display

In the Function display, you can make detailed settings.

In the example here, we'll call up and use the keyboard touch sensitivity setting display.

### 1 Press the [FUNCTION] button.

Categories of detailed settings are shown.

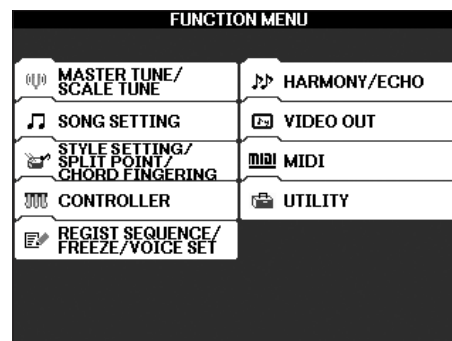
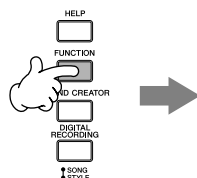

## 2 Press the [D] button to select the category CONTROLLER.

When the selected category is further divided into sub-categories, the tab(s) will be shown in the display.

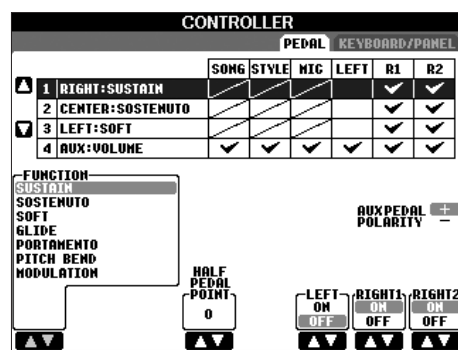

## 3 Press the TAB [▶] button to select the KEYBOARD/PANEL tab.

When the setting is further divided into additional settings, a list will be shown in the display.

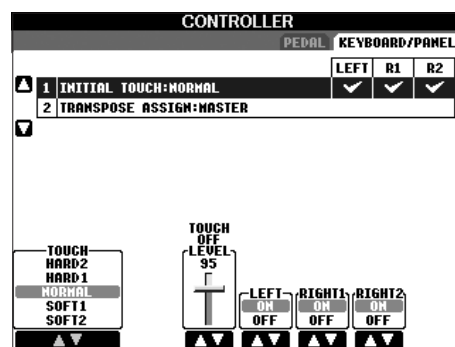

## 4 Press the [A] button to select the "1 INITIAL TOUCH."

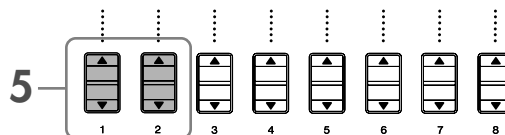
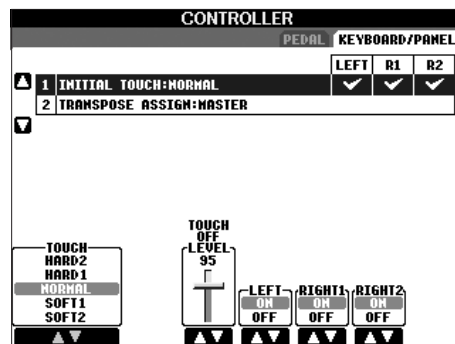
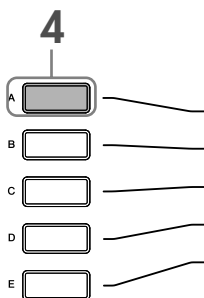

## 5 Press the [1 ▲ ▼]/[2 ▲ ▼] button to select touch sensitivity for the keyboard.

Throughout this manual, arrows are used in the instructions, indicating in shorthand the process of calling up certain displays and functions.

For example, the instructions above can be indicated in shorthand as: [FUNCTION] → [D] CONTROLLER → TAB [▶] KEYBOARD/PANEL → [A] 1 INITIAL TOUCH.

# Playing Voices

The Clavinova features a variety of Voices, including exceptionally realistic piano Voices.

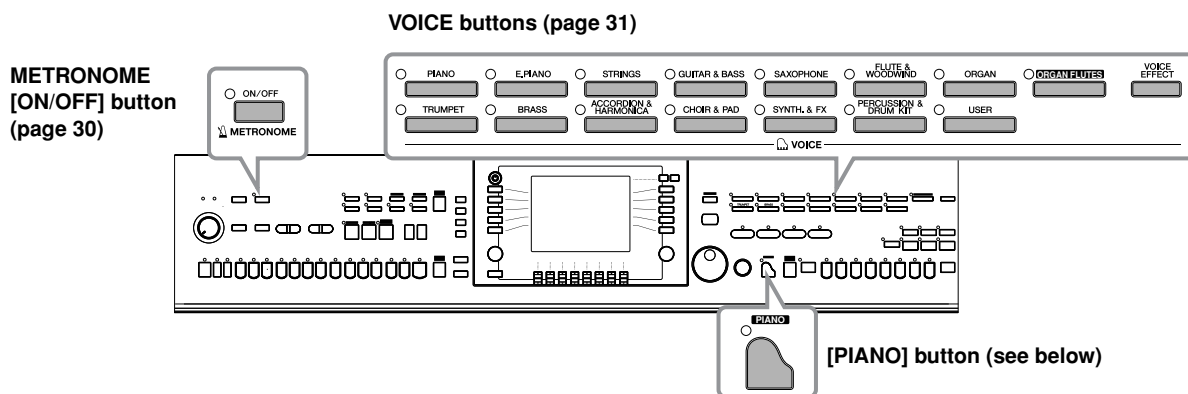

## Playing the Piano Voice

Here, we'll call up and play the piano voice. You can play the piano voice using the pedals or metronome.

### One-touch Piano Play

This convenient, easy-to-use feature completely and automatically reconfigures the entire CVP for optimum piano performance. No matter what settings you've made from the panel, you can instantly call up the piano settings by a single button press.

**Press the piano-shaped [PIANO] button on the lower right of the panel.**



### Piano Lock Function

The convenient Piano Lock function lets you "lock" the piano so that you don't inadvertently change the settings by pressing another button on the panel. Once locked, the CVP stays in the piano mode, even if other buttons are pressed—preventing you from accidentally starting a Song (page 34) during your piano performance.

- 1 Hold down the [PIANO] button on the lower right of the panel for a short time, until a message appears prompting you to enable Piano Lock.
- 2 Press the [F] (OK) button to enable Piano Lock.
- 3 To turn Piano Lock off, hold down the [PIANO] button again for a short time.

### Setting the touch sensitivity of the keyboard

You can adjust the touch response of the instrument (how the sound responds to the way you play the keys). The touch sensitivity type becomes the common setting for all Voices.

- 1 Call up the operation display:  
[FUNCTION] → [D] CONTROLLER → TAB [▶] KEYBOARD/  
PANEL → [A] 1 INITIAL TOUCH
- 2 Press the [1 ▲ ▼]/[2 ▲ ▼] buttons to specify the touch response.  
HARD 2 ..... Requires strong playing to produce high volume. Best for players with a heavy touch.  
HARD 1 ..... Requires moderately strong playing for high volume.  
NORMAL... Standard touch response.  
SOFT 1..... Produces high volume with moderate playing strength.  
SOFT 2..... Produces relatively high volume even with light playing strength. Best for players with a light touch.

- NOTE**
- This setting does not change the weight of the keyboard.
  - When you do not want to apply touch sensitivity, set Touch to OFF for the corresponding parts by pressing the [5 ▼]–[7 ▼] buttons. When Touch is set to OFF, you can specify the fixed volume level by pressing the [4 ▲ ▼] button.

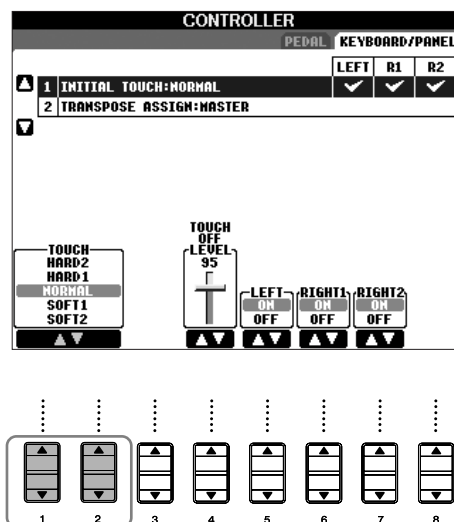

## Using the Pedals

The Clavinova features three pedals.

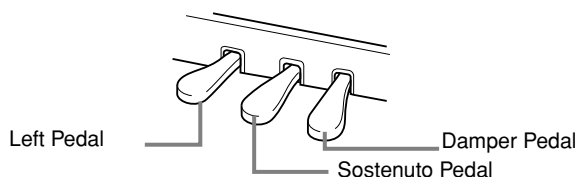

### ● Damper Pedal (Right)

The damper pedal performs the same function as the damper pedal on an actual acoustic piano, letting you sustain the sound of the voices even after releasing the keys.

- NOTE**
- Some Voices may sound continuously or have a long decay after the notes have been released while the damper pedal is held.
  - Certain Voices in the "PERCUSSION & DRUM KIT," "GM&XG" and "GM2" groups may not be affected by use of the damper pedal.

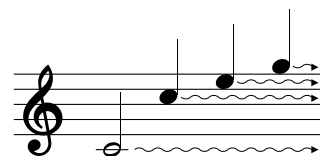

When you press the damper pedal here, the notes you play before you release the pedal have a longer sustain.

### ● Sostenuto Pedal (Center)

If you play a note or chord on the keyboard and press the sostenuto pedal while holding the note(s), the notes will sustain as long as the pedal is held. All subsequent notes will not sustain.

- NOTE**
- Certain Voices, such as [STRINGS] or [BRASS], sustain continuously when the sostenuto pedal is pressed.
  - Certain Voices in the "PERCUSSION & DRUM KIT," "GM&XG" and "GM2" groups may not be affected by use of the sostenuto pedal.

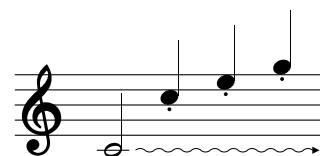

When you press the sostenuto pedal here while holding the note(s), the notes will sustain as long as you hold the pedal.

### ● Left Pedal

When the Piano voice is selected, pressing this pedal reduces the volume and slightly changes the timbre of the notes you play.

The settings assigned to this pedal may differ depending on the selected Voice.

- NOTE** The depth of the left pedal effect can be adjusted (page 91).

### ● Foot Controller/Footswitch

An optional Yamaha foot controller (FC7) or footswitch (FC4 or FC5) can be connected to the AUX PEDAL jack and used to control various functions assigned (page 182).

#### Making Settings for the Pedals

You can assign one of the various functions to the three pedals or an optional foot controller/footswitch, doing things like starting and stopping the Style (page 182).

## Using the Metronome

The metronome provides a click sound, giving you an accurate tempo guide when you practice, or letting you hear and check how a specific tempo sounds.

1 Press the **METRONOME [ON/OFF]** button to start the metronome.

2 To stop the metronome, press the **METRONOME [ON/OFF]** button again.

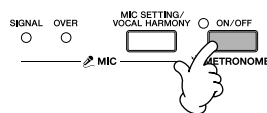

## Adjusting the Tempo or Setting the Time Signature of the Metronome Sound

### ■ Adjusting the Metronome Tempo

1 Press the **TEMPO [-]/[+]** button to call up the pop-up tempo setting display.

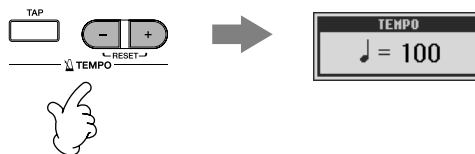

2 Press the **TEMPO [-]/[+]** buttons to set the tempo.

Pressing and holding either button lets you continuously increase or decrease the value.

You can also use the [DATA ENTRY] dial to adjust the value. To reset the tempo, press the TEMPO [-]/[+] buttons simultaneously.

#### **NOTE** About the Tempo display

The number in the display indicates how many quarter-note beats there are in one minute. The range is between 5 and 500. The higher the value, the faster the tempo.

3 Press the **[EXIT]** button to close the Tempo display.

### ■ Determine the Metronome Time Signature and Other Settings

1 Call up the operation display:

[FUNCTION] → [I] UTILITY → TAB [◀] CONFIG 1 → [B] 2 METRONOME

**2** Set the parameters by pressing the [2▲▼]-[7▲▼] buttons.

<b>VOLUME</b>	Determines the level of the metronome sound.
<b>SOUND</b>	Determines which sound is used for the metronome. Bell Off..... Conventional metronome sound, with no bell. Bell On..... Conventional metronome sound, with bell. English Voice ..... Count in English German Voice .... Count in German Japanese Voice ... Count in Japanese French Voice..... Count in French Spanish Voice..... Count in Spanish
<b>TIME SIGNATURE</b>	Determines the time signature of the metronome sound.

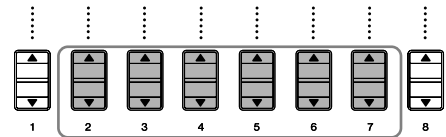
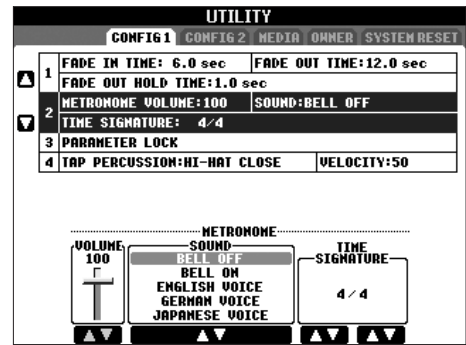

## Playing Various Voices

The Clavinova features a variety of Voices such as strings or wind instruments, including exceptionally realistic piano Voices.

## Playing Preset Voices

The preset Voices are categorized and contained in appropriate folders. Voice buttons on the panel correspond to the categories of the preset Voices. For example, press the [PIANO] button to display various piano Voices.

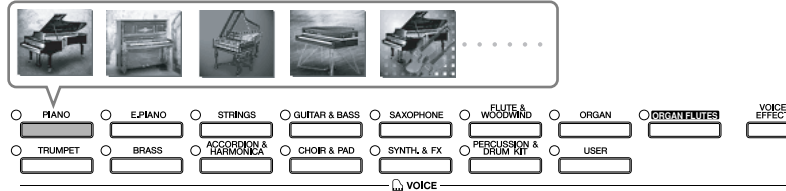

**NOTE** About the various Voices  
 Refer to the Voice List in the separate Data List booklet.

**1** Press the PART ON/OFF [RIGHT 1] button to turn the right-hand part on.

The Voice selected here is the RIGHT 1 Voice. For the Voice part, see page 73.

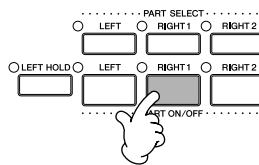

**2** Press one of the VOICE buttons to select a Voice category and call up the Voice selection display.

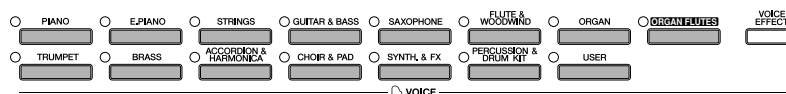

**3** Press the TAB [◀] button to select the PRESET display.

**NOTE** The Voice type and its defining characteristics are indicated above the Preset Voice name. For details on the characteristics, see page 72.

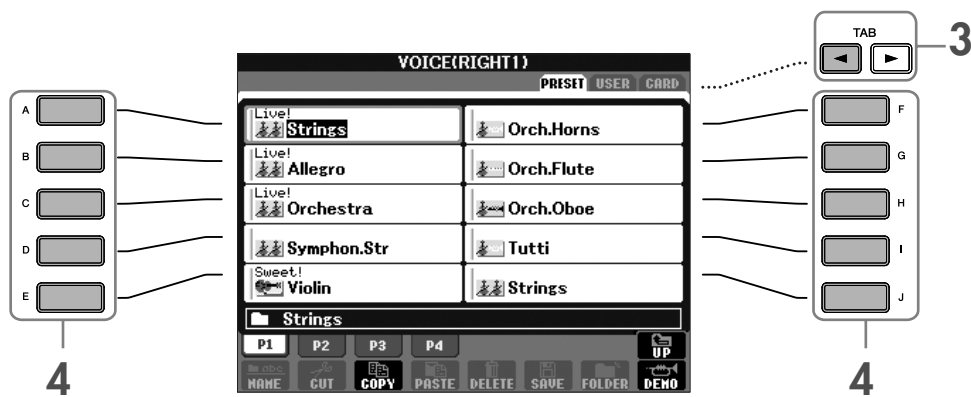

#### 4 Press one of the [A]–[J] buttons to select the desired Voice.

**NOTE** You can instantly jump back to the Main display by “double-clicking” on one of the [A]–[J] buttons.

#### 5 Play the keyboard.



**NOTE** Restoring the Piano settings  
Press the piano-shaped [PIANO] button.

#### Recalling your favorite Voices easily

The CVP has a huge amount of high-quality Voices, covering an exceptionally broad range of instrument sounds—making it perfect for virtually every musical application. However, the sheer number of Voices may seem overwhelming at first. To easily recall your favorite Voice, there are two methods:

- **Save your favorite Voice to the USER display in the Voice Selection display and recall it by using the VOICE [USER] button**

- 1 Copy your favorite Voices from the Preset drive to the User drive.  
Refer to page 64 for details on the copy operation.
- 2 Press the Voice [USER] button to call up the Voice Selection display and press one of the [A]–[J] buttons to select the desired Voice.

- **Register your favorite Voice to Registration Memory and recall it with the REGISTRATION MEMORY [1]–[8] buttons**

Refer to page 121 for details on Registration Memory operations.



## Playing the Voice Demos

To listen to the various Voices and hear how they sound especially in context, listen to the demo songs for each Voice.

**1 In the Voice Selection display (page 31 step 2), press the [8 ▼] (DEMO) button to start the Demo for the selected Voice.**

**2 To stop the Demo, press the [8 ▼] (DEMO) button again.**

### Selecting percussion sounds

When one of the Drum Kit Voices in the [PERCUSSION & DRUM KIT] group is selected, you can play various drums and percussion instrument sounds on the keyboard. Details are given in the Drum Kit List of the separate Data List. To check which "Standard Kit 1" percussion sounds are assigned to each key, look at the icons printed above the keys.

### Selecting sound effects

You can play individual sound effects, such as bird chirps and ocean sounds from the keyboard. The sound effects are categorized as "GM&XG"/"GM2."

- 1 Press the PART SELECT [RIGHT 1] button to call up the Voice selection display.
- 2 Press the [8 ▲] (UP) button to call up the Voice categories.
- 3 Press the [2 ▲] button to display page 2.
- 4 Press the [E]/[F] button to select "GM&XG"/"GM2."
- 5 Press the [2 ▲] button to display page 2.
- 6 Press the [F] button to select "SoundEffect."
- 7 Press one of the [A]–[J] buttons to select the desired sound effect.
- 8 Play the keyboard.

### Selecting GM/XG/GM2 Voices

You can select the GM/XG/GM2 Voices directly via the panel operation. Perform steps 1–4 described above, select the desired category, then select the desired voice.

### Playing different Voices simultaneously

The Clavinova can play different Voices simultaneously (page 73).

#### • Layering two different Voices

This is useful for creating rich and thick sounds.

#### • Setting separate Voices for the left and right sections of the keyboard

You can play different Voices with the left and right hands. For example, you can set up the keyboard to play the bass Voice with your left hand and the piano Voice with your right hand.

# Practicing with the Preset Songs

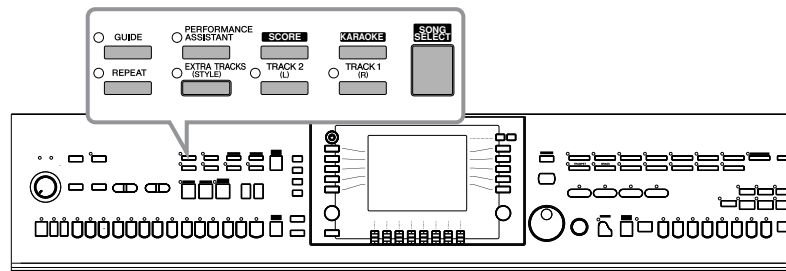

## **NOTE** Song

On the Clavinova, performance data is called a “Song.”

## Playing Back Songs Before Practicing

Clavinova includes not only the preset demo Songs, but also many preset Songs. This section covers basic information on playing back the preset Songs or Songs in a SmartMedia card. You can also have the score (notation) of the selected Song shown in the display.

## Playing a Preset Song

- 1 Press the [SONG SELECT] button to call up the Song selection display.



- 2 Press the TAB [◀] button to select the PRESET tab.

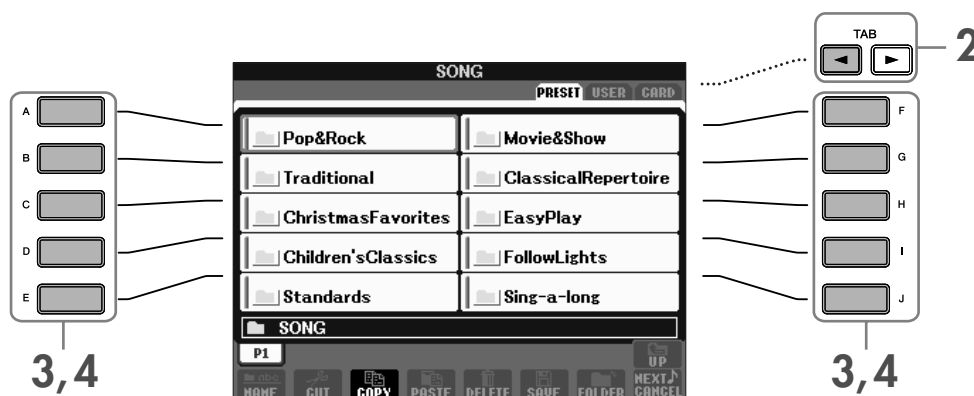

- 3 Press one of the [A]–[J] buttons to select a Song category.

The preset Songs are categorized and contained in appropriate folders.

- 4 Press one of the [A]–[J] buttons to select the desired Song.

You can also select the file by using the [DATA ENTRY] dial, then press the [ENTER] button to execute.

**NOTE** You can instantly jump back to the Main display by “double-clicking” on one of the [A]–[J] buttons.

## 5 Press the SONG [PLAY/PAUSE] button to start playback.

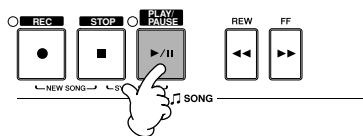

## 6 Press the SONG [STOP] button to stop playback.

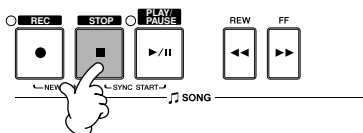

### Playing a Song from SmartMedia card

#### ⚠ CAUTION

Make sure to read page 22 for information on how to handle SmartMedia cards and the card slot.

- 1 Hold the SmartMedia card so that the connector section (gold) of the card is facing downward and forward, towards the card slot. (CVP-305/303) Carefully insert the card into the slot, slowly pushing it all the way in until it clicks into place. (CVP-301) Carefully insert the card into the slot, slowly pushing it all the way in until it is fitted in place.
- 2 Press the [SONG SELECT] button to call up the Song selection display.
- 3 Press the TAB [◀][▶] button to select the CARD tab.



- 4 Press one of the [A]–[J] buttons to select the desired Song.

### Playing Songs in sequence

You can play all Songs in a folder continuously.

- 1 Select a Song in the desired folder.
- 2 Call up the operation display.  
[FUNCTION] → [B] SONG SETTING
- 3 Press the [H] (REPEAT MODE) button to select "ALL."
- 4 Press the SONG [PLAY/PAUSE] button to start playback.  
All Songs in the folder play back continuously, in order.
- 5 To turn off the Song sequence playback, press the [H] button to select "OFF" in the display in step 2.

**Boost the volume of the part to be practiced**

On the CVP, a single Song can contain separate data for up to sixteen MIDI channels. Specify the channel for practicing and increase the playback volume for the channel.

- 1 Select a Song. The method for selecting a Song is the same as “Playing a preset Song (page 34)” or “Playing a Song from SmartMedia card (page 35).”
- 2 Press the [MIXING CONSOLE] button to call up the MIXING CONSOLE display.

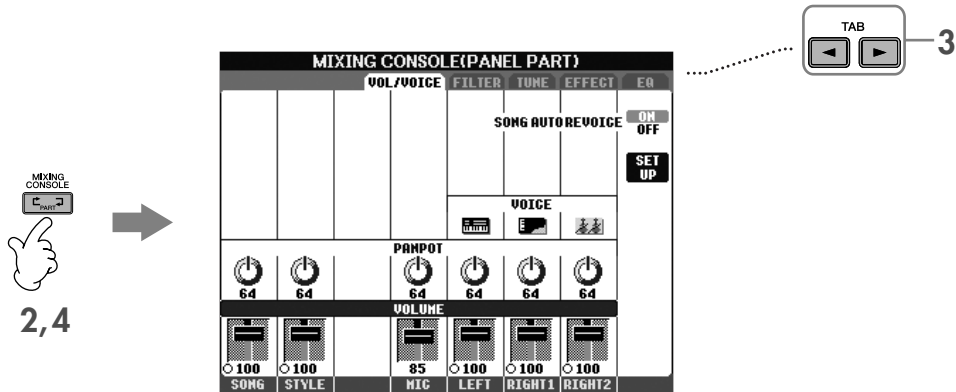

- 3 Press the TAB [◀][▶] buttons to select the VOL/VOICE tab.
- 4 Press the [MIXING CONSOLE] button until “MIXING CONSOLE (SONG CH1–8)” is shown at the top of the display.
- 5 Press the [E]/[I] button to select “VOLUME.”
- 6 To raise the level of the desired channel(s), press the appropriate buttons [1 ▲ ▼]–[8 ▲ ▼].  
If the desired channel is not shown in the MIXING CONSOLE (SONG CH1–8) display, press the [MIXING CONSOLE] button to call up the MIXING CONSOLE (SONG CH9–16) display.

**If you don't know which channel's volume to raise:**

- Look at the illustrations of the instruments indicated below “VOICE.”

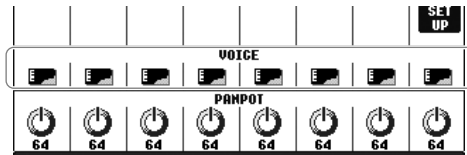

- Look at the channel indicators, which light as the Song plays back. Watching these as you listen can show you which channel you wish to boost.

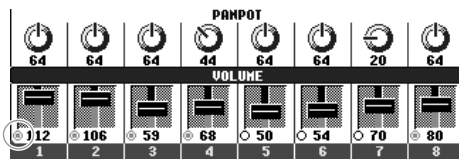

## Displaying Music Notation (Score)

You can view the music notation of the selected Song. We suggest that you read through the music notation before starting to practice.

- NOTE • The Clavinova can display the music notation of commercially-available music data or your recorded Songs.
- The displayed notation is generated by the Clavinova based on the Song data. As a result, it may not be exactly the same as commercially available sheet music of the same song—especially when displaying notation of complicated passages or many short notes.
- The notation functions cannot be used to create Song data by inputting notes. For information on creating Song data, see page 133.

### 1 Select a Song (page 34).

### 2 Press the [SCORE] button to display the music notation.

- NOTE Look through the entire score before playing back the Song  
Press the TAB [▶] button to select subsequent pages.

### 3 Press the SONG [PLAY/PAUSE] button to start playback.

The “ball” bounces along through the score, indicating the current position.

### 4 Press the SONG [STOP] button to stop playback.

## Changing the Notation Display

You can change the notation display as desired to suit your personal preferences.

### 1 Press the [SCORE] button to display the music notation.

### 2 Change the following settings as desired.

- **Changing the size of the music notation**  
Press the [7 ▲ ▼] button to change the size of the music notation.
- **Displaying only right-hand part/left-hand part notation**  
Press the [1 ▲ ▼]/[2 ▲ ▼] button to disable display of the left-hand part/right-hand part.
- **Customizing the notation display**
  - **Display the note name at the left of the note**
    - 1 Press the [5 ▲ ▼] (NOTE) button to display the note name.
    - 2 Press the [8 ▲ ▼] (SET UP) button to call up the detailed setting display.
    - 3 Press the [6 ▼] (NOTE NAME) button to select “Fixed Do.”
    - 4 Press the [8 ▲] (OK) button to apply the setting.
  - **Turn on the note colors (CVP-305)**  
Press the [6 ▲ ▼] button to turn the COLOR on.

#### NOTE About the note colors

These colors are fixed for each note and cannot be changed.  
C: red, D: yellow, E: green, F: orange, G: blue, A: purple, and B: gray

- **Increase the number of measures in the display**

You can increase the number of measures that will be displayed by decreasing the other items to be displayed (part, lyrics, chords, etc.).

Use the [1 ▲ ▼]–[4 ▲ ▼] buttons to turn off the items you want not to be displayed.

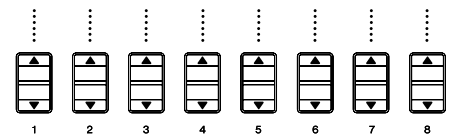

Set the detailed parameters of the view type as desired.

- 1 Press the [8 ▲ ▼] (SETUP) button to call up the detailed setting display.
- 2 Press the [1 ▲ ▼]–[6 ▲ ▼] buttons to set the view type.

<b>LEFT CH/RIGHT CH</b>	<p>Determines which MIDI channel in the Song data is used for the left-hand/right-hand part. This setting returns to AUTO when a different Song is selected.</p> <p><b>AUTO</b> The MIDI channels in the Song data for the right- and left-hand parts are assigned automatically—setting the parts to the same channel as the channel which is specified in the [FUNCTION] → [B] SONG SETTING.</p> <p><b>1–16</b> Assigns the specified MIDI channel (1–16) to each of the left- and right-hand parts.</p> <p><b>OFF (LEFT CH only)</b> No channel assignment: This disables display of the left-hand key range.</p>
<b>KEY SIGNATURE</b>	<p>This lets you enter key signature changes in the middle of a song, at the stopped position. This menu is useful when the selected Song contains no key signature settings for displaying notation.</p>
<b>QUANTIZE</b>	<p>This gives you control over the note resolution in the notation, letting you shift or correct the timing of all displayed notes so that they line up to a particular note value. Make sure to select the smallest note value used in the song.</p>
<b>NOTE NAME</b>	<p>Selects the type of the note name indicated at the left of the note in the notation from among the following three types. The settings here are available when the NOTE parameter in “Display the note name at the left of the note” step 1 is set to ON.</p> <p><b>A, B, C</b> Note names are indicated as letters (C, D, E, F, G, A, B).</p> <p><b>FIXED DO</b> Note names are indicated in solfeggio and differ depending on the selected language. The language is specified in LANGUAGE of the HELP display (page 57).</p> <p><b>MOVABLE DO</b> Note names are indicated in solfeggio according to the scale intervals, and as such are relative to the key. The root note is indicated as Do. For example, in the key of G major the root note of “So” would be indicated as “Do.” As with “Fixed Do,” the indication differs depending on the selected language.</p>

- 3 Press the [8 ▲] (OK) button to apply the setting.

**NOTE** Save the notation view settings  
The notation view settings can be saved as part of a Song (page 152).

## One-handed Practice with the Guide Lamps

The key guide lamps indicate the notes you should play, when you should play them, and how long you should hold them down. You can also practice at your own pace—since the accompaniment waits for you to play the notes correctly. Here, mute the right- or left-hand part and try practicing the part using the guide lamps.

### Practicing the Right-hand Part (TRACK 1) Using the Guide Lamps

- 1 Select a Song (page 34).

- 2 Turn the [GUIDE] button on.

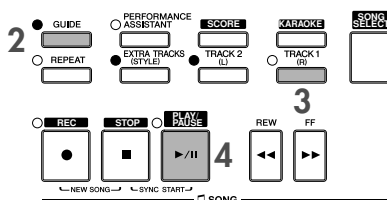

### 3 Press the [TRACK 1 (R)] button to mute the right-hand part.

The indicator of the [TRACK 1 (R)] button goes out. You can now play that part by yourself.

### 4 Press the SONG [PLAY/PAUSE] button to start playback.

Practice the muted part using the guide lamps.

#### **NOTE** Adjusting the tempo

- 1 Press the TEMPO [-]/[+] button to call up the Tempo display.
- 2 Press the TEMPO [-]/[+] button to change the tempo. Pressing and holding either button continuously increases or decreases the value. You can also use the [DATA ENTRY] dial to adjust the value.

#### Quickly changing tempo during a performance (Tap function)

The tempo can also be changed during Song playback by tapping the [TAP] button twice at the desired tempo.

#### Have the guide lamp flash a lead-in to the music

In the GUIDE LAMP TIMING, select NEXT (page 132).

### 5 Press the SONG [STOP] button to stop playback.

### 6 Turn the [GUIDE] button off.

#### Adjusting the volume balance between the Song and the keyboard

This lets you adjust the volume balance between Song playback and the sound you play on the keyboard.

- 1 Press the [BALANCE] button to call up the volume balance display.
- 2 To adjust the Song volume, press the [1 ▲ ▼] button. To adjust the keyboard (RIGHT 1) volume, press the [6 ▲ ▼] button.
- 3 Press the [EXIT] button to close the volume balance display.

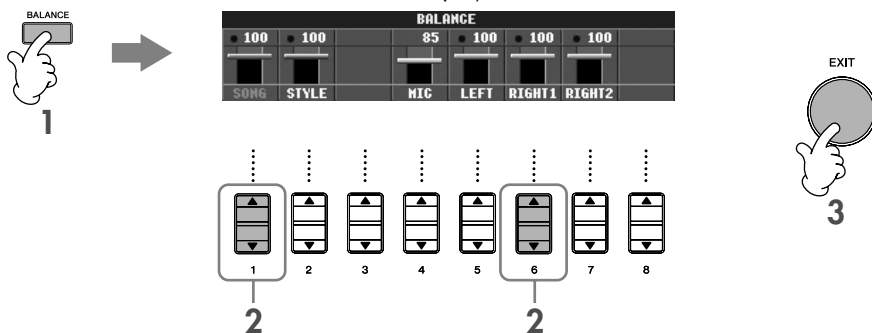

**NOTE** About keyboard parts (Right 1, Right 2, Left)  
See page 73.

#### Other guide functions

The initial setting “Follow Lights” was used in the instructions “One-handed Practice with the Guide Lamps” above. There are additional functions in the Guide feature, as described below. To select a guide function, see page 131.

##### For keyboard performance

- **Any Key**  
This lets you practice the timing of playing the keys.

##### For Karaoke

- **Karao-Key**  
This automatically controls the timing of Song playback to match your singing—a convenient feature for singing along with your keyboard performance.
- **Vocal CueTIME (CVP-305/303)**  
This automatically controls the timing of the accompaniment to match the melody (pitch) of your singing—allowing you to practice singing with the correct pitch.

**NOTE** About Karaoke  
See page 52.

## Practicing the Left-hand Part (TRACK 2) Using the Guide Lamps

**1,2** Follow the same steps as in “Practice the right-hand part (TRACK 1) using the guide lamps” on page 38.

**3** Press the [TRACK 2] button to mute the left-hand part.

The indicator of the [TRACK 2 (L)] button goes out. You can now play that part by yourself.

**4** Press the SONG [PLAY/PAUSE] button to start playback and practice the muted part using the guide lamps.

**5** Press the SONG [STOP] button to stop playback.

**6** Turn the [GUIDE] button off.

## Practicing with the Repeat Playback Function

The Song Repeat functions can be used to repeatedly play back a Song or a specific range of measures in a Song. This is useful for repeated practicing of difficult-to-play phrases.

### Playing Back a Song Repeatedly

- 1 Select a Song (page 34).
- 2 Press the [REPEAT] button to turn on Repeat playback.
- 3 Press the SONG [PLAY/PAUSE] button to start playback.  
The Song will be played back repeatedly until you press the SONG [STOP] button.
- 4 Press the [REPEAT] button to turn off Repeat playback.

### Specifying a Range of Measures and Playing them Back Repeatedly (A-B Repeat)

- 1 Select a Song (page 34).
- 2 Press the SONG [PLAY/PAUSE] button to start playback.
- 3 Specify the repeat range.  
Press the [REPEAT] button at the starting point (A) of the range to be repeated. Press the [REPEAT] button again at the ending point (B). After an automatic lead-in (to help guide you into the phrase), the range from Point A to Point B is played back repeatedly.

**NOTE** Instantly returning to Point A

Regardless of whether the Song is playing back or is stopped, pressing the [STOP] button returns to Point A.

- 4 Press the SONG [STOP] button to stop playback.
- 5 Press the [REPEAT] button to turn off Repeat playback.



## Other Methods for Specifying the A–B Repeat Range

### ● Specifying the repeat range while Songs are stopped

- 1 Press the [FF] button to advance to the Point A location.
- 2 Press the [REPEAT] button to specify Point A.
- 3 Press the [FF] button to advance to the Point B location.
- 4 Press the [REPEAT] button again to specify Point B.

### ● Specifying the repeat range between Point A and the end of the Song

Specifying only Point A results in repeat playback between Point A and the end of the Song.

## Recording Your Performance

Record your performance by using the Quick Recording feature. This is an effective practice tool, allowing you to easily compare your own performance to the original song you are practicing. You can also use it to practice duet pieces by yourself, if you have your teacher or partner record his or her part beforehand.

### 1 Press the [REC] and [STOP] buttons simultaneously.

A blank Song for recording is automatically set.

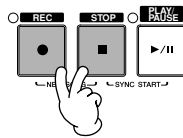

### 2 Select a Voice (page 31). The selected Voice will be recorded.

### 3 Press the [REC] button.

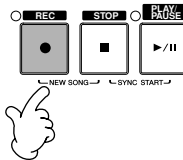

### 4 Start recording.

Recording begins automatically as soon as you play a note on the keyboard.

### 5 Press the SONG [STOP] button to stop recording.

A message prompting you to save the recorded performance appears. To close the message, press the [EXIT] button.

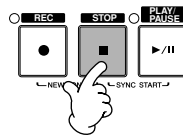

## 6 Press the SONG [PLAY/PAUSE] button to play back the recorded performance.

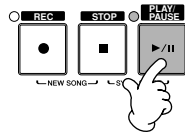

## 7 Save the recorded performance.

- 1 Press the [SONG SELECT] button to call up the Song selection display.
- 2 Press the TAB [◀]/[▶] buttons to select the appropriate tab (USER, CARD, etc.) to which you want to save the data. Select USER to save the data to internal memory, or select CARD to save the data to a SmartMedia card.
- 3 Press the [6▼] (SAVE) button to call up the file naming display.
- 4 Enter the file name (page 67).
- 5 Press the [8▲] (OK) button to save the file.  
To cancel the Save operation, press the [8▼] (CANCEL) button.

### ⚠ CAUTION

The recorded song will be lost if you change to another Song or you turn the power off without executing the Save operation.

### When the following message appears: "Song" changed. Save?/"Song" speichern?/"Song" modifié. Sauv.?"Song" cambiado. ¿Guardar?/Salvare "Song" ?

The recorded data has not yet been saved. To save the data, press the [G] (YES) button to open the Song selection display and save the data (see above). To cancel the operation, press the [H] (NO) button.

## Playing Backing Parts with the performance assistant Technology

This feature makes it exceptionally easy to play the backing parts along with Song playback.

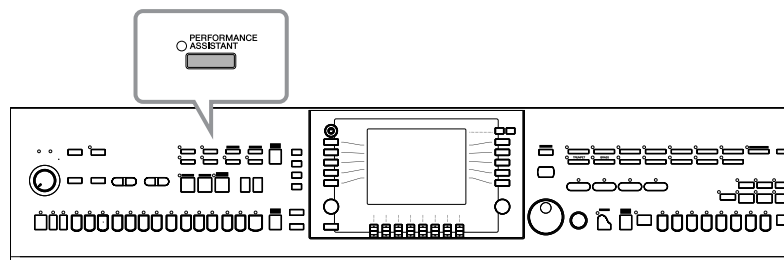

### NOTE Before using performance assistant technology

To use the performance assistant technology, the Song must contain chord data. If the Song contains this data, the current chord name will be displayed in the Main display during Song playback, letting you easily check whether the Song contains chord data or not.

## 1 Select a Song (page 34).

In these example instructions, we recommend that you use the Songs in the "Sing-a-long" folder.

**2 Press the [PERFORMANCE ASSISTANT] button to turn the feature on.**

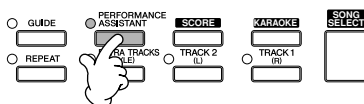

**3 Press the SONG [PLAY/PAUSE] button to start playback.**

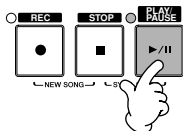

**4 Play the keyboard.**

The instrument automatically matches your performance on the keyboard to the Song playback and chords, no matter what keys you play. It even changes the sound according to the way you play. Try playing in the three different ways below.

- Playing the left and right hand together (method 1).

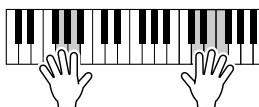

Play three notes at the same time with your right hand.

- Playing the left and right hand together (method 2).

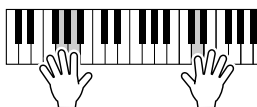

Play several notes one after the other with different fingers of your right hand.

- Playing the left hand and right hand alternately.

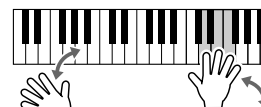

Play three notes at the same time with your right hand.

**5 Press the SONG [STOP] button to stop playback.**

**6 Press the [PERFORMANCE ASSISTANT] button again to turn the feature off.**

# Playing Accompaniment with the Auto Accompaniment Feature (Style Playback)

The Auto Accompaniment features let you produce automatic accompaniment playback simply by playing “chords” with your left hand. This lets you automatically recreate the sound of a full band or orchestra—even if you’re playing by yourself. The Auto Accompaniment sound is made up of the rhythm patterns of the Styles. The Styles of the instrument cover a wide range of different musical genres including pop, jazz, and many others.

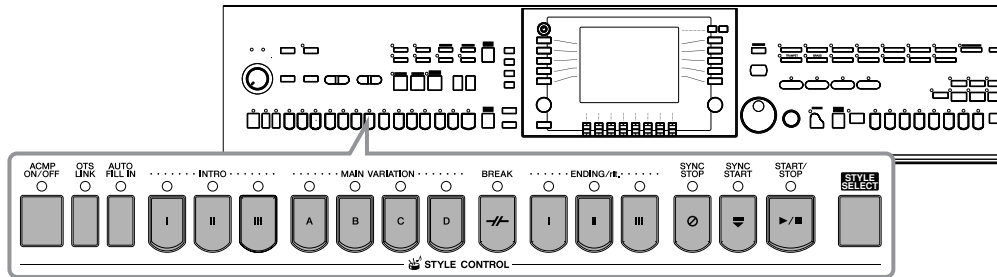

## Playing “Mary Had a Little Lamb” with the Auto Accompaniment Feature

### MARY HAD A LITTLE LAMB

Traditional

Style: Country Pop

The musical notation is presented in two systems. Each system consists of a treble clef staff with a melody line and a bass clef staff with a bass line. Chord symbols (C, G) are placed above the treble staff. Fingerings (1-5) are indicated for the right hand. Below each measure, a piano keyboard diagram shows the chord voicing for the left hand. The first system covers the first four measures, and the second system covers the next four measures, ending with a box labeled 'Ending' and a downward arrow.

**1 Press the [STYLE SELECT] button to call up the Style selection display.**

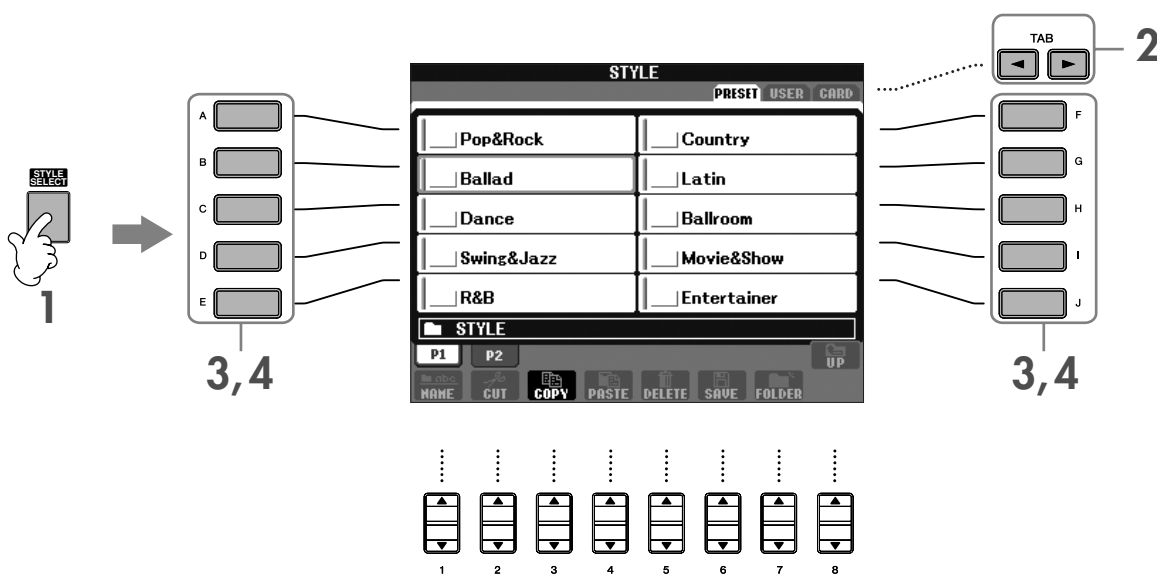

**2 Press the TAB [◀] button to select the PRESET tab.**

**NOTE** The Style type and its defining characteristics are indicated above the Preset Style name. For details on the characteristics, see page 97.

**3 Press one of the [A]-[J] buttons to select the Style category "Country."**

**4 Press one of the [A]-[J] buttons to select a Style "CountryPop."**

**NOTE** You can instantly jump back to the Main display by "double-clicking" on one of the [A]-[J] buttons.

**5 Press the [ACMP ON/OFF] button to turn on Auto Accompaniment.**

Use the left-hand section (lower part) of the keyboard to play the chords for sounding the Auto Accompaniment.

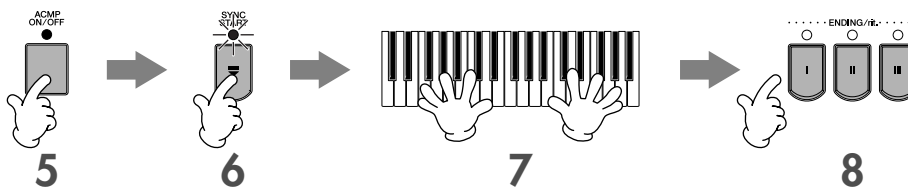

**6 Press the [SYNC START] button to set Auto Accompaniment to standby—letting you simultaneously start the accompaniment as soon as you start playing.**

**7 As soon as you play a chord with your left hand, the Auto Accompaniment starts.**

Try playing chords with your left hand and play a melody with your right hand.

**NOTE Chord Fingerings**

There are seven different fingering methods you can use to specify chords (page 98).

## 8 Automatically play an appropriate ending by pressing the [ENDING] button, at the point in the score indicated by "Ending."

When Ending playback is finished, the Style automatically stops.

- **NOTE** • **About the various Styles**  
Refer to the Style List in the separate Data List booklet.
- **Quickly changing the Style tempo during a performance (Tap function)**  
The tempo can also be changed during playback by tapping the [TAP] button twice at the desired tempo.
- **Specifying the split point (the border between the right- and left-hand range)**  
See page 100.
- **Turns touch response on/off for the Style playback (Style Touch)**  
See page 101.

### Adjusting the volume balance between the Style and the keyboard

This lets you adjust the volume balance between Style playback and the sound you play on the keyboard.

- 1 Press the [BALANCE] button to call up the volume balance display.
- 2 To adjust the Style volume, press the [2 ▲ ▼] button. To adjust the keyboard (RIGHT 1) volume, press the [6 ▲ ▼] button.
- 3 Press the [EXIT] button to close the volume balance display.

## Pattern Variation

While you play, you can automatically add specially created intros and endings, as well as variations in the rhythm/chord patterns, for more dynamic, professional-sounding performances. There are several different auto accompaniment pattern variations for each situation: starting your performance, during your performance, and ending your performance. Try out the variations and combine them freely.

## To Start Playing

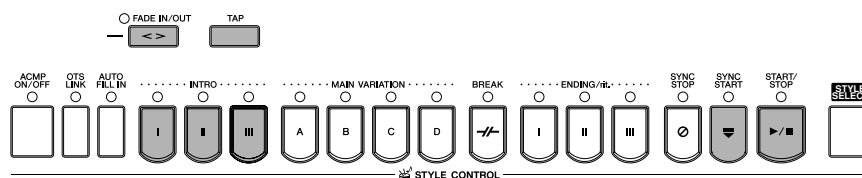

### ● Start/Stop

Styles start playing back as soon as the STYLE CONTROL [START/STOP] button is pressed.

### ● Intro

This is used for the beginning of the song. Each preset Style features three different intros. When the intro finished playing, accompaniment shifts to the Main section (see "Main" in the "During Style playback" below).

Press one of the INTRO [I]–[III] buttons before starting Style playback and press the STYLE CONTROL [START/STOP] button to start Style playback.

### ● Synchro Start

This lets you start playback as soon as you play the keyboard.

Press the [SYNC START] button when Style playback is stopped and play a chord in the chord section of the keyboard to start Style playback.

### ● Fade In

The Fade In produces smooth fade-ins when starting the Style.

Press the [FADE IN/OUT] button when Style playback is stopped and press the STYLE CONTROL [START/STOP] button to start Style playback.

### ● Tap

Tap out the tempo and automatically start the Style at that tapped speed. Simply tap (press/release) the [TAP] button (four times for a 4/4 time signature), and the Style playback starts automatically at the tempo you tapped.

● **NOTE** The particular drum sound and the velocity (loudness) of the sound when the Tap function is used can be selected in the following display.

[FUNCTION] → [I] UTILITY → TAB[◀] CONFIG 1 → [B] 4 TAP

## During Style Playback

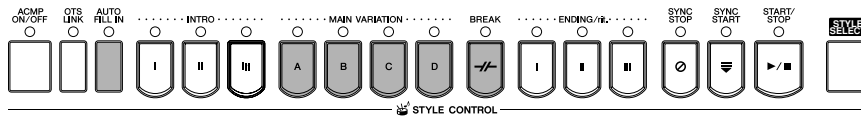

### ● Main

This is used for playing the main part of the Song. It plays an accompaniment pattern of several measures, and repeats indefinitely. Each preset Style features four different patterns.

Press one of the MAIN [A]–[D] buttons during Style playback.

### ● Fill In

The fill-in sections let you add dynamic variations and breaks in the rhythm of the accompaniment, to make your performance sound even more professional.

Turn on the [AUTO FILL IN] button before starting Style playback or during playback. Then, simply press one of the MAIN VARIATION (A, B, C, D) buttons as you play, and the selected fill-in section plays automatically (AUTO FILL), spicing up the auto accompaniment. When the fill-in is finished, it leads smoothly into the selected main section (A, B, C, D).

Even when [AUTO FILL IN] button is turned off, pressing the same button of the currently playing section automatically plays a fill-in before returning to the same main section.

### ● Break

This lets you add dynamic breaks in the rhythm of the accompaniment, to make your performance sound even more professional.

Press the [BREAK] button during Style playback.

## To Finish Playing

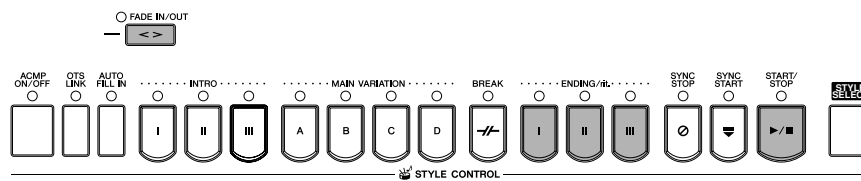

### ● Start/stop

Styles stop as soon as the STYLE CONTROL [START/STOP] button is pressed.

### ● Ending

This is used for the ending of the Song. Each preset Style features three different endings. When the ending is finished, the Style stops automatically.

Press one of the ENDING/rit. [I]–[III] buttons during Style playback. You can have the ending gradually slow down (ritardando) by pressing the same ENDING/rit. button again while the ending is playing back.

### ● Fade Out

The Fade Out produces smooth fade-outs when stopping the Style.

Press the [FADE IN/OUT] button during Style playback.

**NOTE** For details on setting the fade-in and fade-out time, see page 99.

## Others

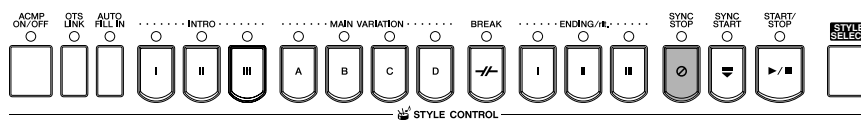

### ● Synchro Stop

When Synchro Stop is on, you can stop and start the Style anytime you want by simply releasing or playing the keys (in the chord section of the keyboard). This is a great way to add dramatic breaks and accents to your performance.

Press the [SYNC STOP] button before starting the Style playback.

#### **NOTE** • Enable Synchro Stop by pressing/releasing keys (Synchro Stop Window)

See page 101.

#### • Fixing the section pattern to either Intro or Main (Section Set)

For example, you can set this function to Intro to conveniently have an Intro play automatically whenever you select a Style (page 101).

**About the section button (INTRO/MAIN/ENDING, etc.) lamps**

- Green  
The section is not selected.
- Red  
The section is currently selected.
- Off  
The section contains no data and cannot be played.

**Holding the LEFT part Voice (Left Hold)**

This function causes the LEFT part Voice to be held even when the keys are released. Non-decaying voices such as strings are held continuously, while decay-type voices such as piano decay more slowly (as if the sustain pedal has been pressed). This function adds a natural richness to the overall accompaniment sound.

- 1 Press the PART ON/OFF [LEFT] button to turn the left-hand part on.
- 2 Press the [LEFT HOLD] button to turn the Left Hold function on.

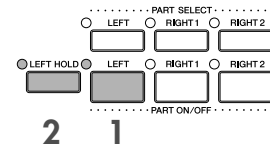

## Learning How to Play (Indicate) Chords for Style Playback

### Learning the Notes to Play for Certain Chords

If you know the name of a chord but don't know how to play it, you can have the instrument show you the notes to play (Chord Tutor function).

**1 Call up the operation display.**

[FUNCTION] → [C] STYLE SETTING/SPLIT POINT/CHORD FINGERING → TAB[◀|▶] CHORD FINGERING

**2 Press the [6▲▼] button to select the root note.**

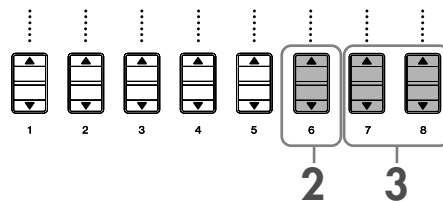
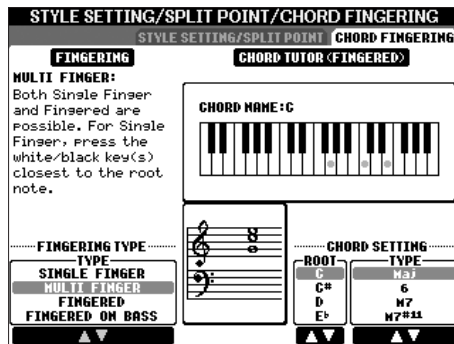

**3 Press the [7▲▼]/[8▲▼] button to select the chord type.**

The notes you need to play to make the selected chord are shown in the display.

**NOTE** The notes that are displayed correspond to Fingering, no matter which fingering type is selected (page 98).



## Checking How to Play Chords with the Guide Lamps

For Songs containing chord data, you can have the individual notes of the chords indicated with the Guide lamps on the instrument.

**1 Select a Song (page 34).**

**2 Press the [FUNCTION] button and press the [B] button to call up the Song Setting display, and make sure that the GUIDE MODE is set to "Follow Lights."**

**3 Press the [ACMP ON/OFF] button to turn on Auto Accompaniment.**

**4 Press the [GUIDE] button.**

**5 Press the SONG [PLAY/PAUSE] button to start playback.**

The Guide lamps in the chord section of the keyboard flash according to the chords of the Song. Try practicing the chords, matching the Guide lamps.

## Appropriate Panel Settings for the Selected Style (One Touch Setting)

One Touch Setting is a powerful and convenient feature that automatically calls up the most appropriate panel settings (Voices or effects, etc.) for the currently selected Style, with the touch of a single button. If you've already decided which Style you wish to use, you can have One Touch Setting automatically select the appropriate Voice for you.

**1 Select a Style (page 45).**

**2 Press one of the ONE TOUCH SETTING [1]–[4] buttons.**

Not only does this instantly call up all the settings (Voices, effects, etc.) that match the current Style—it also automatically turns on ACMP and SYNC START, so that you can immediately start playing the Style.

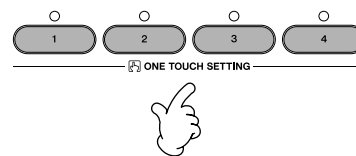

**3 As soon as you play a chord with your left hand, the selected Style starts.**

### **NOTE** Parameter Lock

You can "lock" specific parameters (e.g., effect, split point, etc.) to make them selectable only via the panel controls (page 122).

### Helpful hints for using One Touch Setting

#### ● Automatically changing One Touch Settings with the Main sections (OTS Link)

The convenient OTS (One Touch Setting) Link function lets you automatically have One Touch Settings change when you select a different Main section (A–D). To use the OTS Link function, press the [OTS LINK] button.

#### NOTE Setting the timing for OTS changes

The One Touch Settings can be set to change with the sections in one of two different timings (page 101).

#### ● Memorizing the panel settings to the OTS

You can also create your own One Touch Setting setups.

- 1 Set up the panel controls (such as Voice, Style, effects, and so on) as desired.
- 2 Press the [MEMORY] button.
- 3 Press one of the ONE TOUCH SETTING [1]–[4] buttons. A message appears in the display prompting you to save the panel settings.
- 4 Press the [F] (YES) button to call up the Style selection display and save the panel settings as a Style file (page 63).

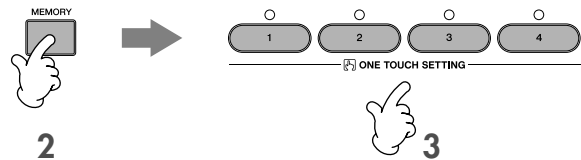

#### CAUTION

The panel settings memorized to each OTS button will be lost if you change the Style or turn the power off without executing the Save operation.

## Calling Up Ideal Setups for Each Song—Music Finder

If you want to play in a certain genre of music but don't know which Style and Voice settings would be appropriate, the convenient Music Finder function can help you out. Simply select the desired music genre from among the Music Finder "Records," and the CVP automatically makes all appropriate panel settings to let you play in that music style.

A new record can be created by editing the currently selected one (page 104).

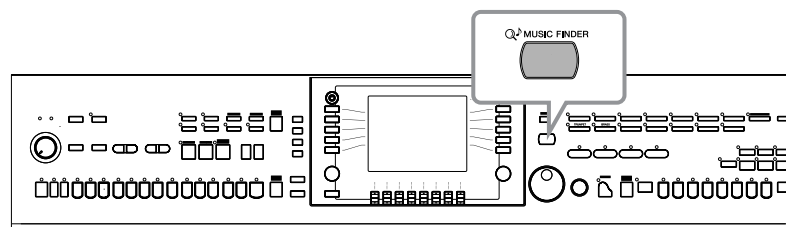

NOTE The data (records) of the Music Finder are not the same as Song data and cannot be played back.

- 1 Press the [MUSIC FINDER] button to call up the MUSIC FINDER display.

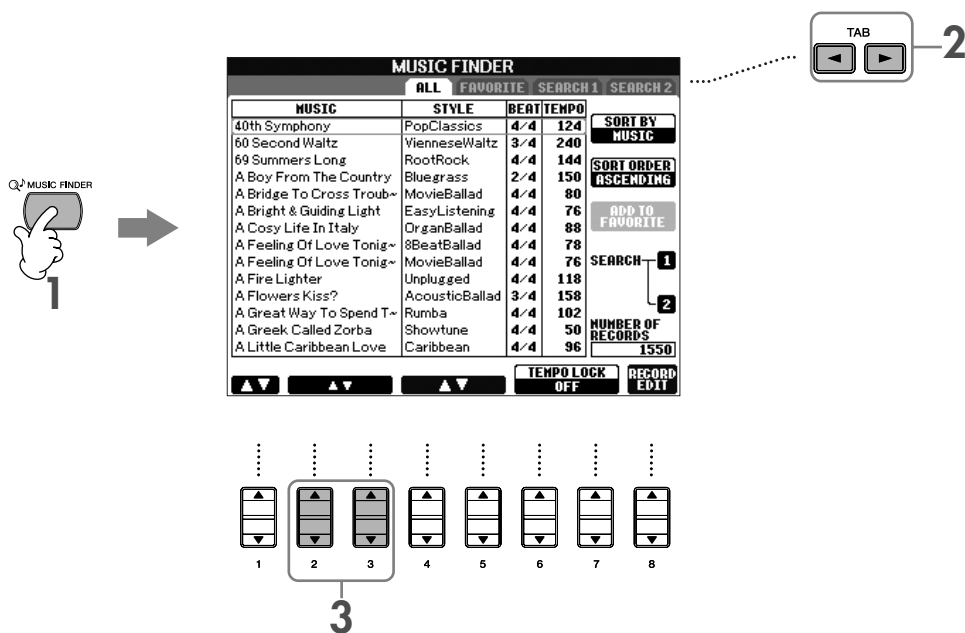

MUSIC FINDER				
ALL		FAVORITE	SEARCH 1	SEARCH 2
MUSIC	STYLE	BEAT	TEMPO	
40th Symphony	PopClassics	4/4	124	<b>SORT BY</b> MUSIC  <b>SORT ORDER</b> ASCENDING  <b>ADD TO</b> FAVORITE  <b>SEARCH</b> 1 2  <b>NUMBER OF</b> RECORDS 1550  <b>TEMPO LOCK</b> OFF  <b>RECORD</b> EDIT
60 Second Waltz	VienneseWaltz	3/4	240	
69 Summers Long	RootRock	4/4	144	
A Boy From The Country	Bluegrass	2/4	150	
A Bridge To Cross Troub	MovieBallad	4/4	80	
A Bright & Guiding Light	EasyListening	4/4	76	
A Cosy Life In Italy	OrganBallad	4/4	88	
A Feeling Of Love Tonig	8BeatBallad	4/4	78	
A Feeling Of Love Tonig	MovieBallad	4/4	76	
A Fire Lighter	Unplugged	4/4	118	
A Flowers Kiss?	AcousticBallad	3/4	158	
A Great Way To Spend T	Rumba	4/4	102	
A Greek Called Zorba	Showtune	4/4	50	
A Little Caribbean Love	Caribbean	4/4	96	

## 2 Press the TAB [◀] button to select the ALL tab.

The ALL tab contains the preset records.

## 3 Select the desired record by using the following four search categories. To select a record, press the [2▲▼]/[3▲▼] buttons

**NOTE** • You can also select the desired record by using the [DATA ENTRY] dial, then press the [ENTER] button to execute.

### • Searching the records

The Music Finder is also equipped with a convenient search function that lets you enter a song title or keyword—and instantly call up all the records that match your search criteria (page 102).

- **MUSIC** ..... Contains the song title or music genre that describes each record, letting you easily find the desired music style.

#### **NOTE** Skipping up or down through the song alphabetically

When sorting records by song title, use the [1▲▼] button to skip up or down through the songs alphabetically. Simultaneously press the [▲▼] buttons to move the cursor to the first record.

- **STYLE**..... This is the preset Style assigned to the record.

#### **NOTE** Skipping up or down through the Style alphabetically

When sorting records by Style name, use the [4▲▼]/[5▲▼] button to skip up or down through the Styles alphabetically. Simultaneously press the [▲▼] buttons to move the cursor to the first record.

- **BEAT** ..... This is the time signature registered to each Record.
- **TEMPO** ..... This is the assigned tempo setting for the record.

## 4 Play the keyboard.

Notice that the panel settings have been automatically changed to match the music genre of the selected record.

### **NOTE** • Tempo Lock

Tempo Lock function lets you avoid changing the Tempo during Style playback when selecting another record. To turn on the Tempo Lock function, press the [6▲▼]/[7▲▼] (TEMPO LOCK) button in the Music Finder display.

### • Parameter Lock

You can “lock” specific parameters (e.g., effect, split point, etc.) to make them selectable only via the panel controls (page 122).

### Sorting the records

Press the [F] (SORT BY) button to sort the records.

- **MUSIC** ..... The record is sorted by song title.
- **STYLE**..... The record is sorted by Style name.
- **BEAT** ..... The record is sorted by beat.
- **TEMPO** ..... The record is sorted by tempo.

### Changing the order of the records

Press the [G] (SORT ORDER) button to change the order of the records (ascending or descending).

# Singing Along with Song Playback (Karaoke) or Your Own Performance

Connect a microphone to the CVP (CVP-305/303) and sing along with Song playback (Karaoke) or your own performance. The lyrics can be displayed when the Song contains lyric data. Sing with the microphone as you read the lyrics shown in the display. Lyrics can also be displayed with the music score, letting you play and sing while following along with the notation and lyrics.

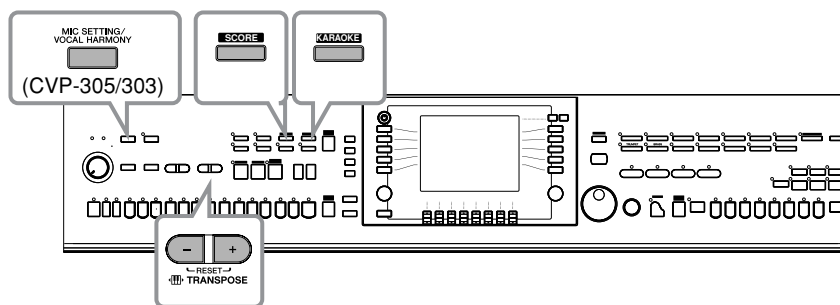

## Connecting a Microphone (CVP-305/303)

- 1 Make sure you have a conventional dynamic microphone.
- 2 Set the [INPUT VOLUME] knob on the bottom panel of the instrument to the minimum position.
- 3 Connect the microphone to the [MIC./LINE IN] jack.

**NOTE** Always set the INPUT VOLUME to minimum when nothing is connected to the [MIC./LINE IN] jack. Since the [MIC./LINE IN] jack is highly sensitive, it may pick up and produce noise when nothing is connected.

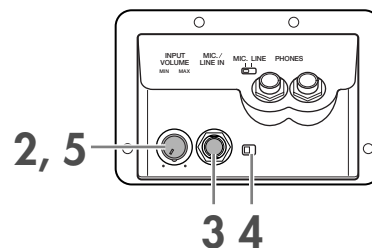

- 4 Set the [MIC. LINE] switch to "MIC."
- 5 (For microphones having a power source, turn on the power first.) Adjust the [INPUT VOLUME] knob while singing into the microphone.

Adjust the controls while checking the SIGNAL and OVER lamps. The SIGNAL lamp lights to indicate that an audio signal is being received. Make sure to adjust the INPUT VOLUME so that this lamp is light. The OVER lamp lights when the input level is too high. Make sure to adjust the INPUT VOLUME so that this lamp does not light.

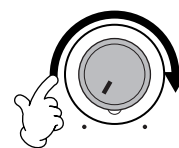

### Disconnecting the microphone

- 1 Set the [INPUT VOLUME] knob on the bottom panel of the instrument to the minimum position.
- 2 Disconnect the microphone from the [MIC./LINE IN] jack.

**NOTE** Set the [INPUT VOLUME] knob to the minimum position before turning off the power.

# Singing with the Lyrics Display

Try singing while playing back a Song containing lyric data

**1 Select a Song (page 34).**

**2 Press the [KARAOKE] button to display the lyrics.**

**3 Press the SONG [PLAY/PAUSE] button to start playback.**

Sing while following along with the lyrics on the display. The color of the lyrics changes as the Song plays.

**4 Press the SONG [STOP] button to stop playback.**

## Displaying the lyrics on an external TV monitor (CVP-305)

The lyrics indicated on the display can also be output via the VIDEO OUT terminal.

- 1** Use an appropriate video cable to connect the [VIDEO OUT] connector of the CVP to the [Video Input] connector on the TV monitor.
- 2** Set the external television/video monitor signal (NTSC or PAL) used by your video equipment, if necessary.
  - 1** Call up the operation display.  
[FUNCTION] → [G] VIDEO OUT
  - 2** Press the [1 ▲ ▼] button to select the external television/video monitor signal.

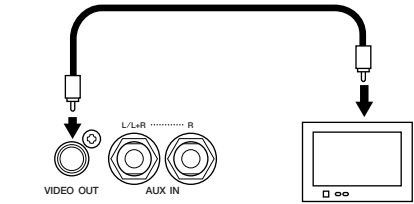

### **NOTE** • When the lyrics are unreadable

You may need to change the Lyrics Language setting to “International” or “Japanese” in the Song Setting display ([FUNCTION] → [B] SONG SETTING), if the lyrics shown are garbled or unreadable. This setting can be memorized as part of the Song data (page 152).

### • Changing the Lyrics Background Picture (CVP-305)

You can change the background picture of the Lyrics display. Press the [7 ▲ ▼]/[8 ▲ ▼] (BACKGROUND) button in the Lyrics display to call up the Lyrics picture selection display for the available picture files and select the desired one. Press the [EXIT] button to return to the previous display.

### • Changing the lyrics

You can change the lyrics as desired (page 156).

## Convenient Functions for Karaoke

Adjusting the tempo	➤	page 30
Transpose	➤	See below.
Applying Effects to Your Voice (CVP-305/303)	➤	page 54
Adding Harmony Vocals to Your Voice (CVP-305/303)	➤	page 54
Practicing Singing with Proper Pitch (Vocal CueTIME) (CVP-305/303)	➤	page 131

## Transpose

You can use this to adjust the key of the Song if it is too high or low.

- Transposing the Song key up..... Press the TRANSPOSE [+] button.
- Transposing the Song key down..... Press the TRANSPOSE [-] button.
- Resetting the transposition ..... Press the TRANSPOSE [+][-] buttons simultaneously.

To close the Transpose display, press the [EXIT] button.

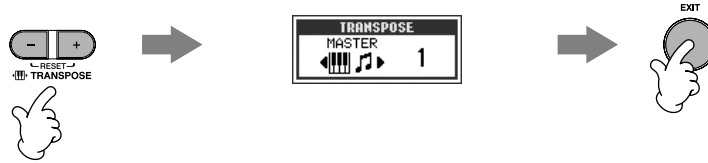

## Applying Effects to Your Voice (CVP-305/303)

You can also apply various effects to your voice.

- 1 Press the [MIC SETTING/VOCAL HARMONY] button to call up the Mic Setting display.

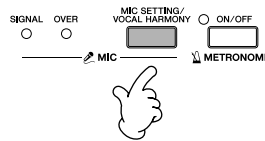

- 2 Press the [4▲▼]/[5▲▼] buttons to turn the effect on.

**NOTE** Selecting an effect type  
You can select the effect type in the Mixing Console (page 84).

## Adding Harmony Vocals to Your Voice (CVP-305/303)

You can also automatically apply various harmony vocals to your voice.

- 1 Select a Song which contains chord data (page 34).

If the Song contains this data, the current chord name will be displayed in the Main display during Song playback, letting you easily check whether the Song contains chord data or not.

- 2 Press the [MIC SETTING/VOCAL HARMONY] button to call up the harmony vocals (Vocal Harmony) Setting display.

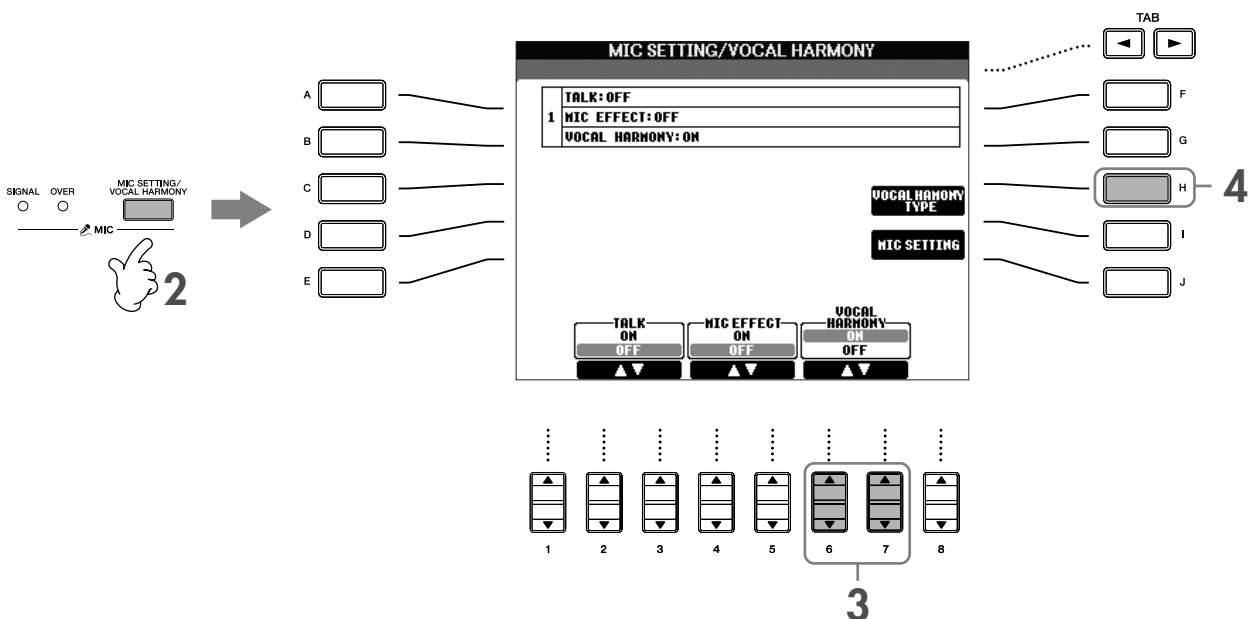

- 3 Press the [6▲▼]/[7▲▼] buttons to turn the harmony vocals (Vocal Harmony) on.

**4 Press the [H] button to call up the Vocal Harmony selection display.**

**5 Press one of the [A]–[J] buttons to select a Vocal Harmony type.**

For details on the Vocal Harmony types, refer to the separate Data List.

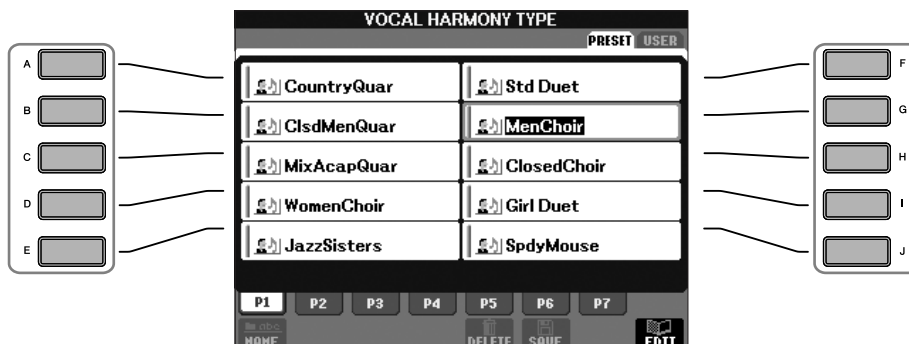

**6 Press the [ACMP ON/OFF] button to turn on Auto Accompaniment.**

**7 Press the SONG [PLAY/PAUSE] button and sing into the microphone.**

The harmony is applied to your voice according to the chord data.

**Adjusting the microphone and Song volume**

You can adjust the volume balance between the Song playback and the microphone.

- 1 Press the [BALANCE] button to call up the Volume Balance display.
- 2 To adjust the microphone volume, press the [4 ▲ ▼] button.  
To adjust the Song volume, press the [1 ▲ ▼] button.
- 3 Press the [EXIT] button to close the volume balance display.

## Convenient Functions for Singing Along with Your Own Performance

Changing the Key (Transpose)	➤ See below.
Displaying the Music Score on the Instrument and the Lyrics on TV (CVP-305)	➤ page 56
Making Announcements Between Songs (CVP-305/303)	➤ page 56
Controlling Playback Timing by Your Voice (Karao-Key)	➤ page 131

### Changing the Key (Transpose)

You can match both the Song and your keyboard performance to a certain key. For example, the Song data is in F, but you feel most comfortable singing in D, and you are accustomed to playing the keyboard part in C. To match up the keys, set the Master Transpose to “0,” the Keyboard Transpose to “2,” and the Song Transpose to “-3.” This brings the keyboard part up and the song data down to your desired singing key.

**1 Call up the operation display.**

[FUNCTION] → [D] CONTROLLER → TAB [▶] KEYBOARD/PANEL → [B] TRANSPOSE ASSIGN

**2 Press the [4 ▲ ▼]/[5 ▲ ▼] button to select the desired transpose type.**

The following types are available. Select the one most suited to your purpose.

### ●KEYBOARD

Transpose pitch of the keyboard played Voices and Style playback (controlled by what you play in the chord section of the keyboard).

### ●SONG

Transposes the pitch of Song playback.

### ●MASTER

Transpose the overall pitch of the CVP.

## 3 Press the **TRANPOSE [-]/[+] button to transpose.**

You can set the value in semitone steps.

To reset the transpose value, press the [+][-] buttons simultaneously.

## 4 Press the **[EXIT] button to close the TRANPOSE display.**

## Displaying the Music Score on the Instrument and the Lyrics on TV (CVP-305)

This convenient sing-along function lets you have the music score shown on the display of the instrument (for your playing purposes), while only the lyrics are shown on a separate TV monitor (page 53) so your audience can sing along.

### 1 Call up the operation display.

[FUNCTION] → [G] VIDEO OUT

### 2 Press the **[3▲]/[4▲] button to select LYRICS.**

## Making Announcements Between Songs (CVP-305/303)

This function is ideal for making announcements between your singing performances. When singing a song, several effects are usually assigned to the MIC Setup. When speaking to your audience, however, these effects may sound disturbing or unnatural. Whenever the TALK function is turned on, effects are automatically turned off.

### 1 Before your performance, press the **[MIC SETTING/VOCAL HARMONY] button to call up the MIC SETTING/VOCAL HARMONY display.**

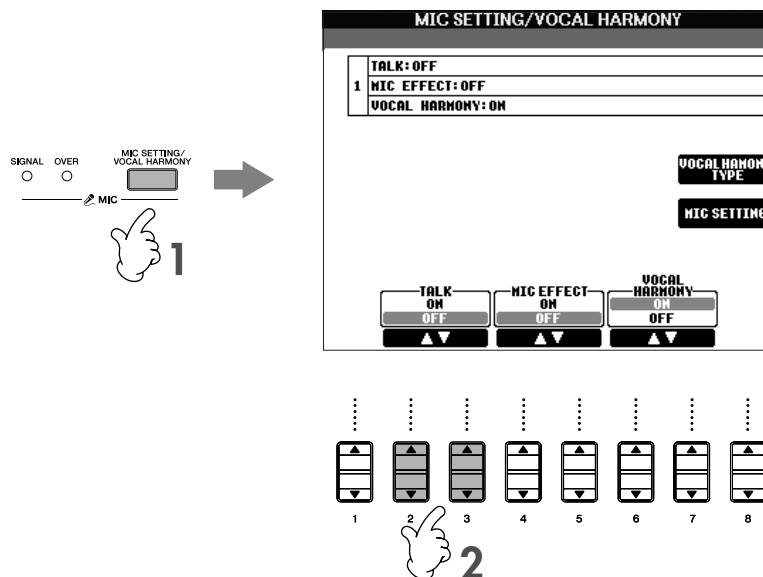

### 2 Press the **[2▲]/[3▲] (TALK) button to turn the function on.**

**NOTE** Talk settings can be customized as well, allowing you to add any desired effects to your voice as you speak to your audience (page 164).



## Trying Out the Basic Features (Help)

The Help function introduces some of the basic features of the instrument. Try them out, following the directions shown in the Help display.

- 1 Press the [HELP] button to call up the Help display.

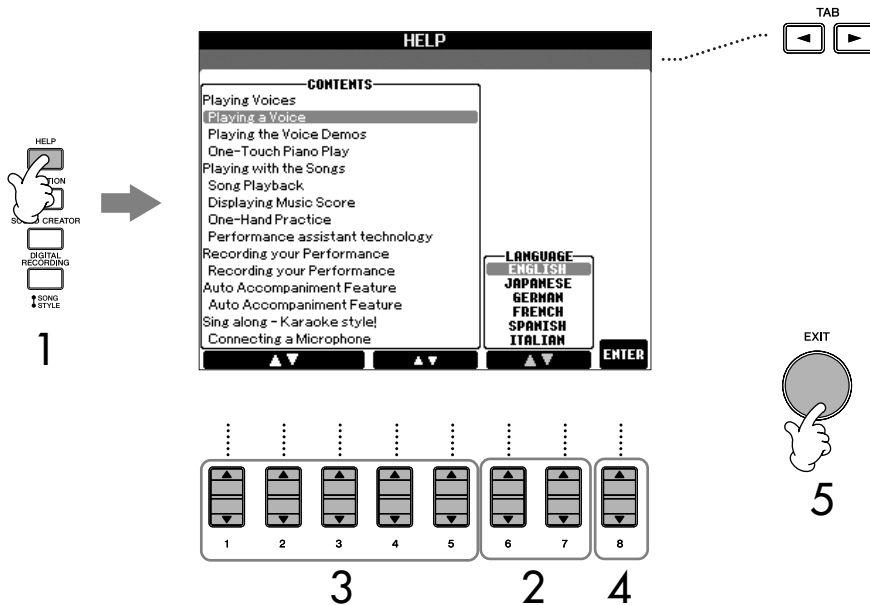

The language selected here is also used for various “Messages” shown during operations.

- 2 If necessary, use the [6▲▼]/[7▲▼] buttons to select the language.
- 3 Select one of the features you want to try by using the [1▲▼]-[5▲▼] buttons.
- 4 Press the [8▲▼] button to confirm your selection.  
A display explaining the selected feature appears.  
Use the TAB [◀][▶] buttons to select different pages if there are additional pages (The “P1,” “P2,” etc, tabs appear.)
- 5 Press the [EXIT] button to return to the previous display.

## The Messages Shown in the Display

A message (information or confirmation dialog) sometimes appears on the screen to facilitate operation. When the message appears, simply press the appropriate button.

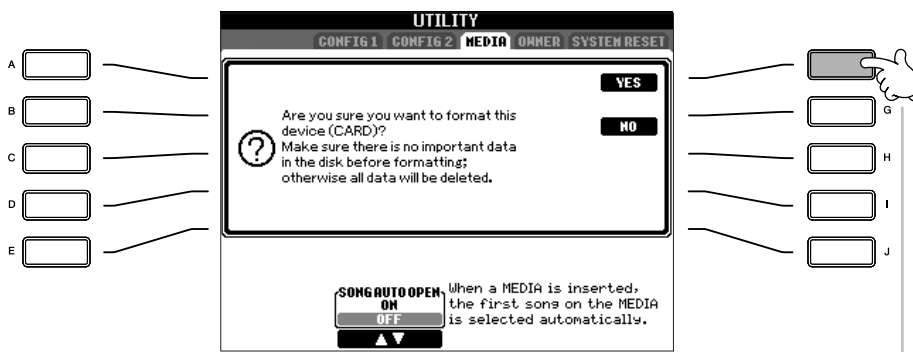

In this example, press the [F] (YES) button to start formatting the SmartMedia card.

**Selecting message language**  
You can select the desired language of the display messages in the Help display (see above).

# Instant Selection of the Displays—Direct Access

With the convenient Direct Access function, you can instantly call up the desired display—with just a single additional button press.

- 1 **Press the [DIRECT ACCESS] button.**  
A message appears in the display prompting you to press the appropriate button.
- 2 **Press the button corresponding to the desired setting display to instantly call up that display.**  
Refer to the separate Data List for a list of the displays that can be called up with the Direct Access function.

### Example of calling up the Guide function display

Press the [DIRECT ACCESS] button, then press the [GUIDE] button.

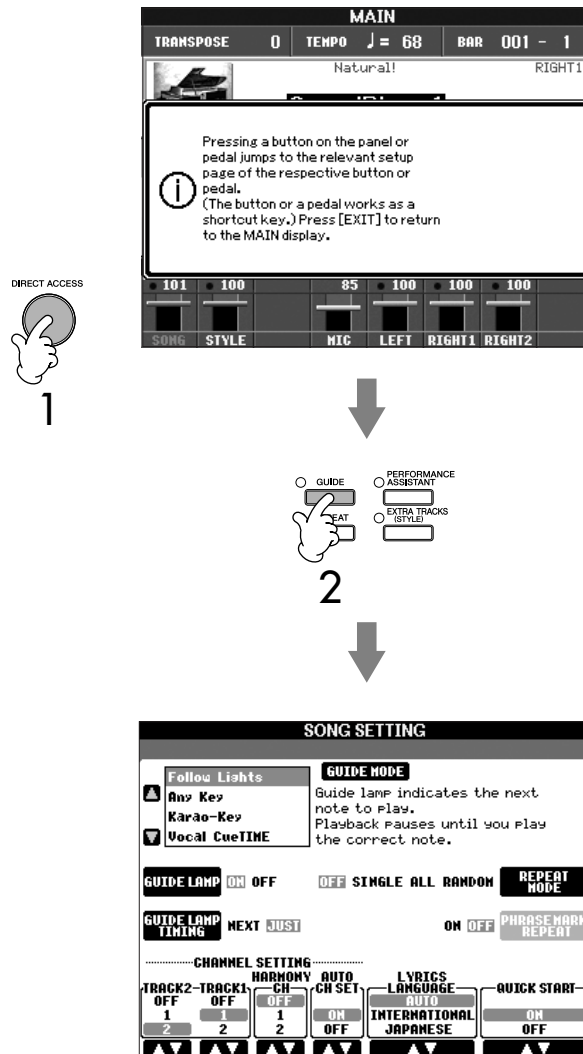

### Returning to the Main display

Here's a convenient way to return to the Main display from any other display: Simply press the [DIRECT ACCESS] button, then the [EXIT] button.

# Basic Displays (Main Display and File Selection Display)

There are two basic display types – Main and Selection. Here are explanations of each display segment and its basic operation.

## Main Display

The Main display shows the current basic settings of the instrument such as the currently selected Voice and Style, allowing you to see them at a single glance. The Main display is the one you'll usually see when you play the keyboard.

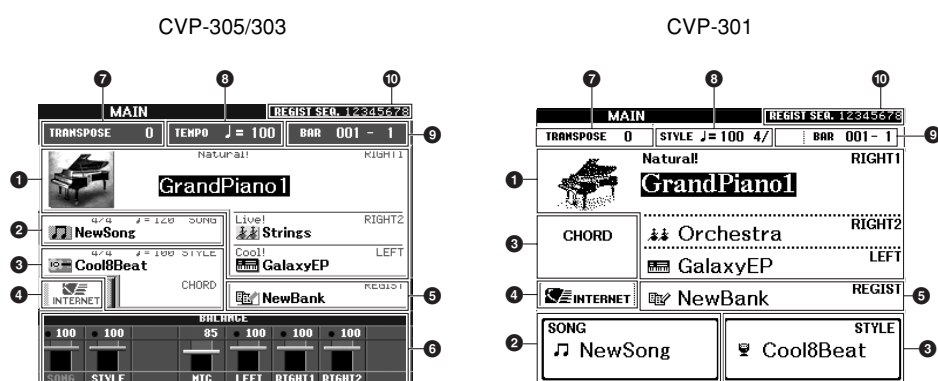

### 1 Voice name

- RIGHT 1 (indicated at the right edge of the display):  
Voice name currently selected for the RIGHT 1 part (page 73).
- RIGHT 2 (indicated at the right edge of the display):  
Voice name currently selected for the RIGHT 2 part (page 73).
- LEFT (indicated at the right edge of the display):  
Voice name currently selected for the LEFT part (page 73).

Pressing one of the [A], [B] and [F]–[I] buttons calls up the Voice Selection display for each part (page 31).

### 2 Song name and related information

Displays the currently selected Song name. The time signature and tempo are also indicated on the CVP-305/303.

If the Song contains the chord data, the current chord name will be displayed in the “CHORD” segment (see 3 below).

On the CVP-305/303, pressing the [C] button calls up the Song Selection display (page 34).

### 3 Style name and related information; current chord name

Displays the currently selected Style name. The time signature and tempo are also indicated on the CVP-305/303.

If the [ACMP ON/OFF] button is set to On, the chord specified in the chord section of the keyboard will be displayed.

On the CVP-305/303, pressing the [D] button calls up the Style Selection display (page 45).

### 4 Internet function

Pressing the [E] button calls up the Internet Direct Connection display (page 166).

### 5 Registration Memory Bank name

Displays the currently selected Registration Memory Bank name.

Pressing the [J] button calls up the Registration Memory Bank Selection display (page 122).

### 6 Volume Balance

Displays the volume balance among the parts. (On CVP-301, open the volume balance display by pressing the [BALANCE] button.)

Adjust the volume balance among the parts by using the [1 ▲ ▼]–[8 ▲ ▼] buttons.

### 7 Transpose

Displays the amount of transposition in semitone units (page 53).

### 8 Tempo

Displays the current tempo of the Song or Style. On the CVP-301, the time signature is also displayed.

### Returning to the Main display

Here's a convenient way to return to the Main display from any other display: Simply press the [DIRECT ACCESS] button, then the [EXIT] button.

9 **BAR (current position of the Song or Style)**

Displays the current position of the Song or bar and beat number from playback start of the Style.

10 **Registration Sequence**

Appears when the Registration Sequence is active (page 124).

## File Selection Display Configuration and Basic Operation

The File Selection display appears when you press one of the buttons shown below. From here you can select Voices, Styles, and other data.

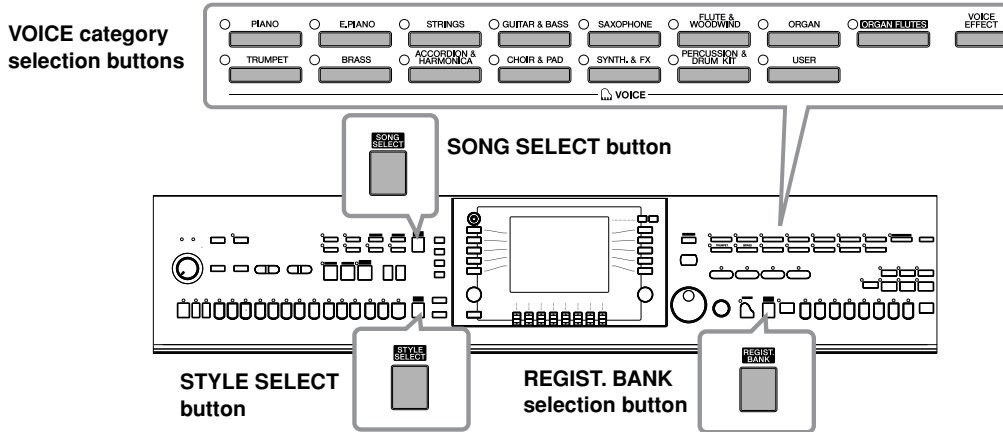

## File Selection Display Configuration

• **Location (drive) of data**

**Preset**

Location where pre-programmed (preset) data is stored.



**User**

Location where recorded or edited data is saved.

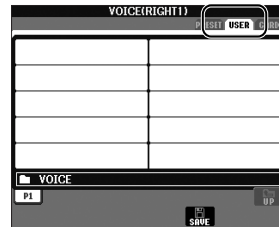

**Card**

Location where data on SmartMedia card is saved.

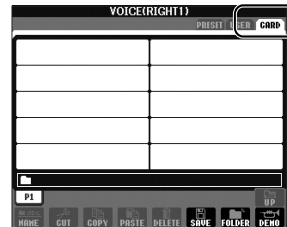

• **Data files and folders**

The data, both pre-programmed and your own original, are saved as "files." You can drop files into a folder.

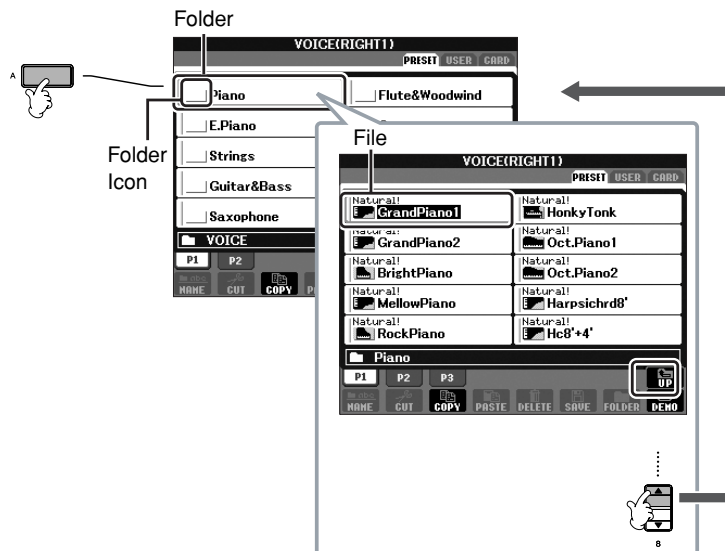

# File Selection Display Basic Operation

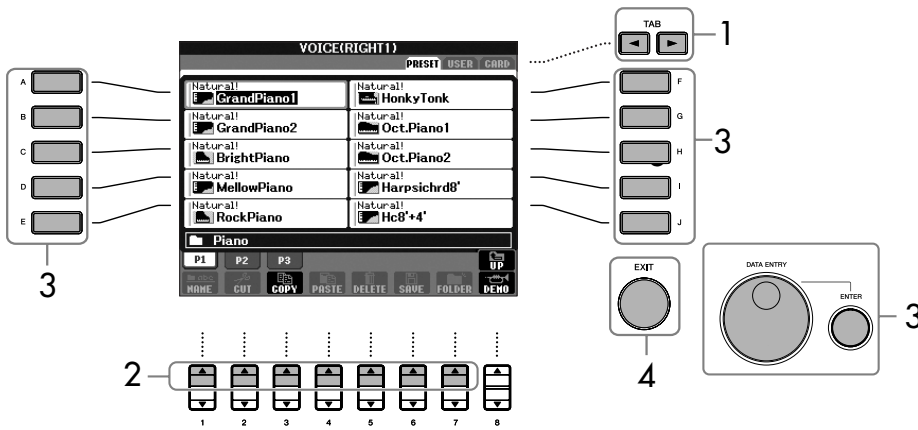

- 1 Select the tab containing the desired file by using the TAB [◀]/[▶] buttons.
- 2 Select the page containing the desired file by using the [1▲]–[7▲] buttons ([1▲]–[6▲] buttons for Voice and Song).
- 3 Select the file. There are two ways to do so.
  - Press one of the [A]–[J] buttons.
  - Select the file by using the [DATA ENTRY] dial, then press the [ENTER] button to execute.
- 4 Press the [EXIT] button to return to the previous display.

## Closing the current folder and calling up the next highest level folder

To close the current folder and call up the next highest level folder, press the [8▲] (UP) button.

### Example of the PRESET Voice Selection display

The PRESET Voice files are categorized and contained in appropriate folders.



This display shows the Voice files in a folder.



The next highest level—in this case, folder—is shown. Each folder shown in this display contains appropriately categorized Voices.

## File/Folder Operations in the File Selection Display

- Saving Files ..... page 63
- Copying Files/Folders (Copy & Paste)..... page 64
- Moving Files (Cut & Paste)..... page 65
- Deleting Files/Folders..... page 65
- Renaming Files/Folders..... page 66
- Selecting Custom Icons for Files (shown at the left of file name) ..... page 66
- Creating a New Folder ..... page 67
- Entering characters..... page 67

### Formatting a SmartMedia card

A new SmartMedia card or one which has been used with other devices may not be immediately usable with the CVP. If the SmartMedia card inserted in the instrument's card slot cannot be accessed by the instrument, you will need to format the card for the instrument.

**⚠ CAUTION**

- Formatting a SmartMedia card completely erases all data on the card. Make sure that the SmartMedia card you're formatting does not contain important data!
- Make sure to read page 22 for how to handle the SmartMedia card and card slot.
- The SmartMedia cards formatted with this instrument may become unusable with other instruments.

- 1 Insert a SmartMedia card for formatting into the card slot.
- 2 Call up the operation display.  
[FUNCTION] → [I]UTILITY → TAB[◀]/[▶]MEDIA
- 3 Press the [A] button to select "CARD."
- 4 Press the [H] button to format the card.

**Formatting a floppy disk**  
To format a floppy disk, select "USB" in step 3 at right.

**⚠ CAUTION**  
Make sure to read page 21 for how to handle the floppy disk drive and floppy disk.

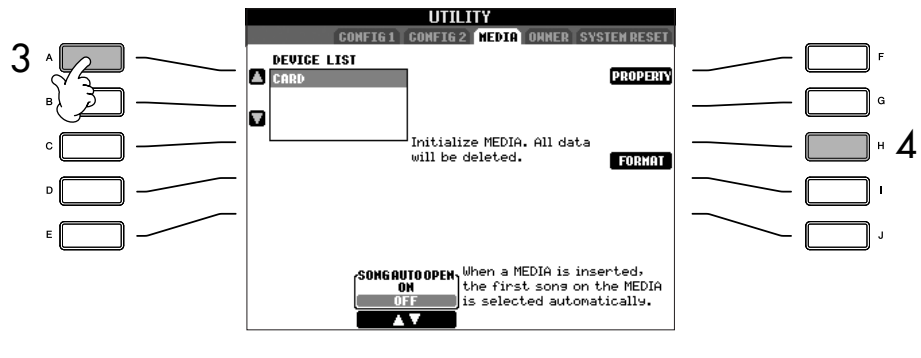

## Saving Files

This operation lets you save your original data (such as Songs and Voices you've created) to a file.

- 1 After you've created a Song or Voice in the relevant SONG CREATOR or SOUND CREATOR display, press the [SAVE] display button. The File Selection display for the corresponding data appears. Keep in mind that the Save operation is executed from the File Selection display.

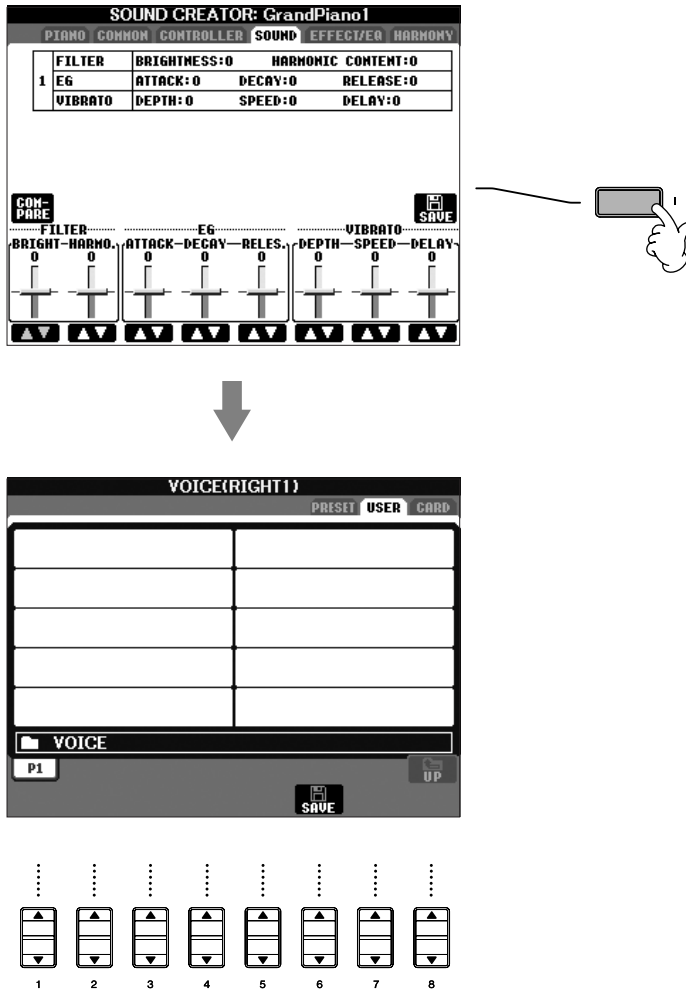

- 2 Select the appropriate tab (USER, CARD, etc.) to which you want to save the data by using the TAB [◀]/[▶] buttons.
- 3 Press the [6 ▼] (SAVE) button to call up the file naming display.



- 4 Enter the file name (page 67).
- 5 Press the [8 ▲] (OK) button to save the file. If you want to cancel the Save operation, press the [8 ▼] (CANCEL) button. The saved file will be automatically located at the appropriate position among the files in alphabetical order.

### Internal memory (User tab displays) capacity

The internal memory capacity of the instrument is about 1.5MB (CVP-305/303)/650KB (CVP-301). This capacity applies to all file types, including Voice, Style, Song, and Registration data files.

### Restrictions for protected Songs

Commercially available song data may be copy protected to prevent illegal copying or accidental erasure. They are marked by the indications at the upper left side of the file names. The indications and relevant restrictions are detailed below.

<b>Prot. 1</b>	Indicates Preset Songs saved to the User tab display, Disk Orchestra Collection (DOC) Songs, and Disklavier Piano Soft Songs. These cannot be copied/moved/saved to external devices such as SmartMedia cards and hard disk.
<b>Prot. 2 Orig</b>	Indicates Yamaha-protection-formatted Songs. These cannot be copied. These can be moved/saved only to the USER tab display and SmartMedia cards with ID.
<b>Prot. 2 Edit</b>	Indicates edited "Prot. 2 Orig" Songs. Make sure to save these to the same folder containing the corresponding "Prot. 2 Orig" Song. These cannot be copied. These can be moved/saved only to the USER tab display and SmartMedia cards with ID.

#### Note for "Prot. 2 Orig" and "Prot. 2 Edit" Song file operation

Make sure to save the "Prot. 2 Edit" Song to the same folder containing its original "Prot. 2 Orig" Song. Otherwise the "Prot. 2 Edit" Song cannot be played back. Also, if you move a "Prot. 2 Edit" Song, be sure to move its original "Prot. 2 Orig" Song to the same location (folder) at the same time.

## Copying Files/Folders (Copy & Paste)

This operation lets you copy a file/folder and paste it to another location (folder).

- 1 **Call up the display containing the file/folder you want to copy.**
- 2 **Press the [3 ▼] (COPY) button to copy the file/folder.**  
The pop-up window for the Copy operation appears at the bottom of the display.

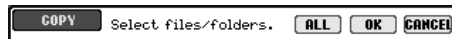

- 3 **Press one of the [A]–[J] buttons corresponding to the desired file/folder.**  
To cancel the selection, press the same [A]–[J] button again.
  - **Selecting all files/folders**  
Press the [6 ▼] (ALL) button to select all files/folders indicated on the current display including the other pages.  
To cancel the selection, press the [6 ▼] (ALL OFF) button again.
- 4 **Press the [7 ▼] (OK) button to confirm the file/folder selection.**  
To cancel the Copy operation, press the [8 ▼] (CANCEL) button.
- 5 **Select the destination tab (USER, CARD, etc.) to paste the file/folder, by using the TAB [◀]/[▶] buttons.**
- 6 **Press the [4 ▼] (PASTE) button to paste the file/folder.**  
The folder/file copied and pasted appears on the display at the appropriate position among the files in alphabetical order.



## Moving Files (Cut & Paste)

This operation lets you cut a file and paste it to another location (folder).

- 1 Call up the display containing the file you want to move.
- 2 Press the [2 ▼] (CUT) button to cut the file.  
The pop-up window for the Cut operation appears at the bottom of the display.



- 3 Press one of the [A]–[J] buttons corresponding to the desired file.  
To cancel the selection, press the same [A]–[J] button again.
  - **Selecting all files**  
Press the [6 ▼] (ALL) button to select all files indicated on the current display including the other pages.  
To cancel the selection, press the [6 ▼] (ALL OFF) button again.
- 4 Press the [7 ▼] (OK) button to confirm the file selection.  
To cancel the Cut operation, press the [8 ▼] (CANCEL) button.
- 5 Select the destination tab (USER, CARD, etc.) to which the file is to be pasted, by using the TAB [◀]/[▶] buttons.
- 6 Press the [4 ▼] (PASTE) button to paste the file.  
The file moved and pasted appears on the display at the appropriate position among the files in alphabetical order.

## Deleting Files/Folders

This operation lets you delete a file/folder.

- 1 Call up the display containing the file/folder you want to delete.
- 2 Press the [5 ▼] (DELETE) button.  
The pop-up window for the Delete operation appears at the bottom of the display.

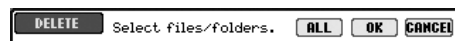

- 3 Press one of the [A]–[J] buttons corresponding to the desired file/folder.  
To cancel the selection, press the same [A]–[J] button again.
  - **Selecting all files/folders**  
Press the [6 ▼] (ALL) button to select all files/folders indicated on the current display including the other pages.  
To cancel the selection, press the [6 ▼] (ALL OFF) button again.

**Deleting all data in a Smart-Media card at once**  
Formatting a SmartMedia card completely erases all data on the SmartMedia card (page 62).

**4 Press the [7 ▼] (OK) button to confirm the file/folder selection.**  
To cancel the Delete operation, press the [8 ▼] (CANCEL) button.

**5 Follow the on-display instructions.**  
YES .....Delete the file/folder  
YES ALL .....Delete all selected files/folders  
NO .....Leave the file/folder as is without deleting  
CANCEL.....Cancel the Delete operation

## Renaming Files/Folders

This operation lets you rename files/folders.

**1 Call up the display containing the file/folder you want to rename.**

**2 Press the [1 ▼] (NAME) button.**  
The pop-up window for the Rename operation appears at the bottom of the display.



**3 Press one of the [A]–[J] buttons corresponding to the desired file/folder.**

**4 Press the [7 ▼] (OK) button to confirm the file/folder selection.**  
To cancel the Rename operation, press the [8 ▼] (CANCEL) button.

**5 Input the name (characters) of the selected file or folder (page 67).**  
The renamed folder/file appears on the display at the appropriate position among the files in alphabetical order.

## Selecting Custom Icons for Files (Shown at the Left of File Name)

You can select custom icons for files (shown at the left of file name).

**1–4 Operations are the same as the above “Renaming Files/Folders” section.**

**5 Press the [1 ▼] (ICON) button to call up the ICON display.**

**6 Select the icon by using the [A]–[J] buttons or [3 ▲ ▼]–[5 ▲ ▼] buttons.**  
The ICON display includes several pages. Press the TAB [▶] button to select different pages.  
To cancel the operation, press the [8 ▼] (CANCEL) button.

**7 Press the [8 ▲] (OK) button to apply the selected icon.**

## Creating a New Folder

This operation lets you create new folders. Folders can be created, named and organized as desired, making it easier to find and select your original data.

- 1 Call up the page of the File Selection display for which you wish to create a new folder.
- 2 Press the [7▼] (FOLDER) button to call up the naming display for a new folder.

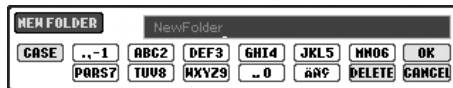

- 3 Input the name of the new folder (see below).

## Entering Characters

The instructions that follow show you how to enter characters in naming your files/folders and when inputting the Keyword for Music Finder function. The method is much the same as inputting names and numbers to a conventional mobile phone. Entering characters should be done in the display shown below.



- 1 Change the type of character by pressing the [1▲] button.
  - If you select a language other than Japanese as the Language (page 57), the following different types of characters are available:
    - CASE.....Alphabet (capital letters, half size), numbers (half size), marks (half size)
    - case.....Alphabet (lowercase letters, half size), numbers (half size), marks (half size)
  - (CVP-305/303) If you select Japanese as the Language (page 57), the following different types of characters and sizes can be entered:
    - かな漢 (kana-kan) ... Hiragana and Kanji, marks (full size)
    - カナ (kana) ..... Katakana (normal size), marks (full size)
    - カナ (kana) ..... Katakana (half size), marks (half size)
    - A B C.....Alphabet (capital and small letters, full size), numbers (full size), marks (full size)
    - ABC.....Alphabet (capital and small letters, half size), numbers (half size), marks (half size)
- 2 Use the [DATA ENTRY] dial to move the cursor to the desired position.

A new folder cannot be made in the PRESET tab.

### Folder directories for the USER tab display

In the USER tab display, folder directories can contain up to four levels. The maximum total number of files and folders which can be stored is 740 (CVP-305/303)/370 (CVP-301), but this may differ depending on the length of the file names. The maximum number of files/folders which can be stored in a folder in the USER tab is 250.

The following half-size marks cannot be entered for a file/folder name.  
 ¥ \ / : \* ? " < > |

In the case of characters which are not accompanied by special character marks (with the exception of kanakan and half-size katakana), you can call up the mark list by pressing the [6 ▼] button after selecting a character (before actual entry of a character).

**3** Press the [2 ▲ ▼]–[6 ▲ ▼] and [7 ▲] buttons, corresponding to the character you wish to enter.



Several different characters are assigned to each button, and the characters change each time you press the button.

- **Deleting characters**  
 Move the cursor to the character you wish to delete by using the [DATA ENTRY] dial, and press the [7 ▼] (DELETE) button. To delete all characters on the line at once, press and hold the [7 ▼] (DELETE) button.
- **Actual entry of characters**  
 Move the cursor or press another letter-input button.
- **Canceling the character-entering operation**  
 Press the [8 ▼] (CANCEL) button.
- **Entering special character marks (umlaut, accent, Japanese “ ` ” and “ ° ”)**  
 Select a character to which a character mark is to be added and press the [6 ▼] button before actual entry of the character.
- **Entering marks**
  - 1 After actually entering a character by moving the cursor, press the [6 ▼] button to call up the mark list.
  - 2 Use the [DATA ENTRY] dial to move the cursor to the desired mark, then press the [8 ▲] (OK) button.
- **Entering numbers**  
 First, select one of the following: “A B C” (full-size alphabet), “ABC” “CASE” (half-size capital alphabet) and “case” (half-size lowercase alphabet). Then, press and hold down the appropriate button, [2 ▲ ▼]–[5 ▲ ▼], [6 ▲] and [7 ▲] button for a while, or press it repeatedly until the desired number is selected.
- **Converting into Kanji (Japanese language)**  
 When the input “hiragana” characters are shown in reverse display (highlighted), press the [ENTER] button one or several times to convert the characters into the appropriate kanji. To actually enter the change, press the [8 ▲] (OK) button or enter the next character.

**When the input “hiragana” characters are shown in reverse display (highlighted):**

- **Re-converting the characters into other kanji**  
 Press the [ENTER] button.
- **Changing the reversed area**  
 Use the [DATA ENTRY] dial.
- **Changing the converted kanji back to “hiragana”**  
 Press the [7 ▼] (DELETE) button.
- **Clearing the reversed area at once**  
 Press the [8 ▼] (CANCEL) button.
- **Entering the “hiragana” itself (without converting it)**  
 Press the [8 ▲] (OK) button.

**4** Press the [8 ▲] (OK) button to actually enter the new name and return to the previous display.

# Restoring the Factory-programmed Settings

## Restoring the Factory-programmed System

While holding the C7 key (right-most key on the keyboard), turn the [POWER] button ON.

This operation has the same result as and is a shortcut for the System Setup restore operation explained in step 2 of the following section.

The operation of restoring the factory-programmed settings does not affect the Internet Settings. To reset the Internet Settings, refer to page 178.

## Restoring the Factory-programmed Settings Independently by Item

- 1 Call up the operation display.  
[FUNCTION] → [I]UTILITY → TAB[▶]SYSTEM RESET
- 2 Select items by pressing the [1▲▼]–[3▲▼] buttons.

**CAUTION**  
This operation deletes all your original data for the respective item (MIDI SETUP, USER EFFECT, MUSIC FINDER, and FILES&FOLDERS).

SYSTEM SETUP	Restores the System Setup parameters to the original factory settings. Refer to the separate Data List booklet for details about which parameters belong to the System Setup.
MIDI SETUP	Restores the MIDI settings including the MIDI templates on the User tab display to the original factory status.
USER EFFECT	Restores the User Effect settings including the user effect types, user master EQ types, and user vocal harmony types (CVP-305/303) created via the Mixing Console display to the original factory settings.
MUSIC FINDER	Restores the Music Finder data (all records) to the original factory settings.
FILES&FOLDERS	Deletes all files and folders stored in the User tab display.
REGIST	Temporarily deletes the current Registration Memory settings of the selected Bank. The same can be done also by turning the [POWER] button ON while holding the B6 key (right-most B key on the keyboard).

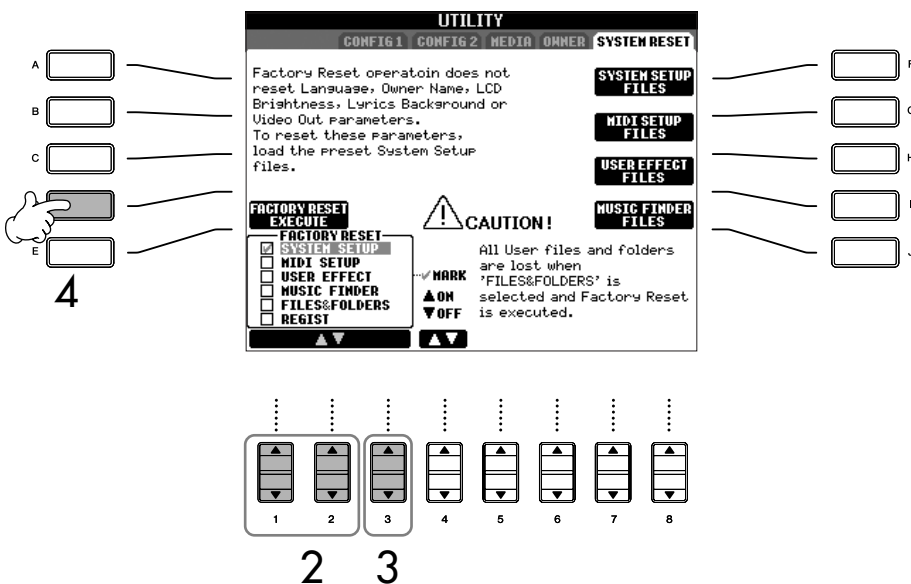

- 3 Checkmark the box of the item to be reset to the factory programmed settings by pressing the [4▲▼] button.
- 4 Press the [D] button to execute the Factory Reset operation for all checkmarked items.

## Saving and Recalling Your Original Settings as a Single File

For the items below, you can save your Original Settings as a Single File for future recall.

- 1 Make all desired settings on the instrument.
- 2 Call up the operation display.  
[FUNCTION] → [I]UTILITY → TAB[▶]SYSTEM RESET
- 3 Press one of the [F]-[I] buttons to call up the relevant display for saving your data.

<b>SYSTEM SETUP</b>	Parameters set on the various displays such as the [FUNCTION] → UTILITY are handled as a single System Setup file. Refer to the separate Data List booklet for details on which parameters belong to the System Setup.
<b>MIDI SETUP</b>	The MIDI settings including the MIDI templates on the User tab display are handled as a single file.
<b>USER EFFECT</b>	The User Effect settings including the user effect types, user master EQ types, and user vocal harmony types (CVP-305/303) created via the Mixing Console displays are managed as a single file.
<b>MUSIC FINDER</b>	All the preset and created records of the Music Finder are handled as a single file.

- 4 Select one of the tabs (other than the PRESET) by pressing the TAB [◀][▶] buttons.  
Note that the file in the PRESET tab display is the file of factory-programmed settings. If you select it, the factory-programmed settings for the respective item will be restored. (This is the same results as on page 69 “Restoring the Factory-programmed Settings Independently by Item.”)
- 5 Save your file (page 63).
- 6 To recall your file, select the tab and page to which you’ve saved the file (same tab and page as specified in step 4), and press the corresponding [A]-[J] button.

## Data Backup

For maximum data security Yamaha recommends that you copy or save your important data to separate storage media, such as a SmartMedia card or USB storage device. This provides a convenient backup if the internal memory is damaged.

### Data that can be saved

- 1 Song\*, Style, Registration Memory Bank and Voice
- 2 Music Finder Record, Effect\*\*, MIDI Template and System File
  - \* Protected Songs (those with a "Prot.1/Prot.2" indication at the upper left of the file name) cannot be saved. However, Songs with a "Prot.2" indication can be moved (cut-and-paste operation) to a SmartMedia card with ID. Songs with a "Prot.1" indication cannot be moved to external media.
  - \*\*Effect data includes the following:
    - Edited or saved data in the Mixing Console "EFFECT/EQ."
    - (CVP-305/303) Edited or saved data of the Vocal Harmony type.

The backup procedure is different for the data types in 1 and 2 above.

## Backup procedure

### Song, Style, Registration Memory Bank and Voice Data

- 1 Insert/connect the backup media (destination), such as a SmartMedia card or USB storage device.
- 2 Call up the display containing the desired file to be copied.
  - Song:**  
Press the [SONG SELECT] button.
  - Style:**  
Press the [STYLE SELECT] button.
  - Registration Memory Bank:**  
Press the [REGIST. BANK] button.
  - Voice:**  
Press one of the VOICE buttons.
- 3 Select the USER tab by using the TAB [◀]/[▶] buttons.

- 4 Press the [3 ▼] (COPY) button to copy the file/folder.

The pop-up window for the Copy operation appears at the bottom of the display.

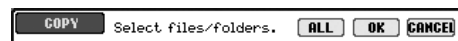

- 5 Press the [6 ▼] (ALL) button to select all files/folders indicated on the current display and all other pages. To cancel the selection, press the [6 ▼] (ALL OFF) button again.
- 6 Press the [7 ▼] (OK) button to confirm the file/folder selection. To cancel the Copy operation, press the [8 ▼] (CANCEL) button.
- 7 Select the destination Tab (CARD or USB) to which the file/folder is to be copied, by using the TAB [◀]/[▶] buttons.
- 8 Press the [4 ▼] (PASTE) button to paste the file/folder.

### If a message appears indicating data cannot be copied

Protected Songs ("Prot. 1/Prot.2" is indicated at the upper left side of the file names) are included in the copied files. These protected Songs cannot be copied. However, Songs with a "Prot.2" indication can be moved (cut-and-paste operation) to a SmartMedia card with ID.

### Music Finder Record, Effect, MIDI Template and System Data

- 1 Insert/connect the backup media (destination), such as a SmartMedia card or USB storage device.
- 2 Call up the operation display.  
[FUNCTION] → [I] UTILITY → TAB [◀]/[▶] SYSTEM RESET
- 3 Press one of the [F]-[I] buttons to call up the relevant display for saving your data.
- 4 Select the appropriate tab (CARD or USB) to which you want to save the data by using the TAB [◀]/[▶] buttons.
- 5 Save your data (page 63).

## Reference to Quick Guide pages

Playing Voices .....	page 28
Playing the Piano Voice .....	page 28
Playing Various Voices .....	page 31

## Voice Characteristics

The Voice type and its defining characteristics are indicated above the Preset Voice name.

<b>Natural!</b>	These rich and luscious Voices are comprised mostly of keyboard instrument sounds and are especially intended for playing piano and other keyboard parts. They also take full advantage of Yamaha's advanced sampling technology such as Stereo Sampling, Dynamic Sampling, Sustain Sampling, and Key-off Sampling.
<b>Live!</b>	These acoustic instrument sounds were sampled in stereo, to produce a truly authentic, rich sound—full of atmosphere and ambience.
<b>Cool!</b>	These Voices capture the dynamic textures and subtle nuances of electric instruments—thanks to a huge amount of memory and some very sophisticated programming.
<b>Sweet!</b>	These acoustic instrument sounds also benefit from Yamaha's sophisticated technology—and feature a sound so finely detailed and natural, you'll swear you're playing the real thing!
<b>Drums</b>	Various drum and percussion sounds are assigned to individual keys, letting you play the sounds from the keyboard.
<b>SFX</b>	Various special effect sounds are assigned to individual keys, letting you play the sounds from the keyboard.
<b>Organ Flutes!</b>	This authentic organ Voice lets you use the Sound Creator to adjust the various footages and craft your own original organ sounds. See page 93 for details.
<b>Mega Voice (CVP-305)</b>	<p>The Mega Voices are not intended to be played from the keyboard. They are primarily designed for use with recorded MIDI sequence data (such as songs and styles). Some of the guitar and bass Voices in particular have been created as Mega Voices for the Clavinova, and are easily distinguished from the normal Voices by their icons in the Voice Selection display.</p> <p>What makes Mega Voices special is their use of velocity switching. Normal Voices use velocity switching, too—to make the sound quality and/or level of a Voice according to how strongly or softly you play it. This makes the Clavinova Voices sound authentic and natural. However, with Mega Voices, each velocity range (the measure of your playing strength) has a completely different sound.</p> <p>For example, a Mega guitar Voice includes the sounds of various performance techniques. In conventional instruments, different Voices having those sounds would be called up via MIDI and played in combination to achieve the desired effect. However, now with Mega Voices, a convincing guitar part can be played with just a single Voice, using specific velocity values to play the desired sounds.</p> <p>Because of the complex nature of these Voices and the precise velocities need to play the sounds, they're not intended for playing from the keyboard. They are, however, very useful and convenient when creating MIDI data—especially when you want to avoid using several different Voices just for a single instrument part.</p>

### Mega Voices Compatibility (CVP-305)

Mega Voices are unique to the Clavinova and are not compatible with other models. Any song/style data you've created on the Clavinova using the Mega Voices will not sound properly when played back on other instruments.



# Playing Different Voices Simultaneously

The Clavinova keyboard features various functions and performance conveniences that are simply unavailable on an acoustic instrument. It allows you to play several different Voices together in a layer, or play one Voice with your left hand while you play a different Voice (or even two layered Voices!) with your right.

## Keyboard Parts (Right 1, Right 2, Left)

Voices can be assigned independently to each keyboard part: Right 1, Right 2, and Left. You can combine these parts by using the PART ON/OFF buttons to create a rich, ensemble sound.

### Keyboard Part Combinations

#### ■ Playing a single Voice (Right 1 part)

You can play a single Voice over the entire keyboard range. This is used for normal performance—for example, with the piano Voice.

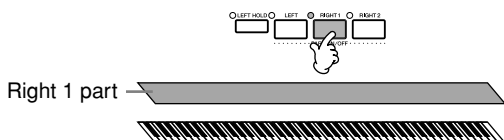

#### ■ Playing Two Voices Simultaneously (Right 1 and 2 parts)

You can simulate a melody duet or combine two similar Voices to create a thicker sound.

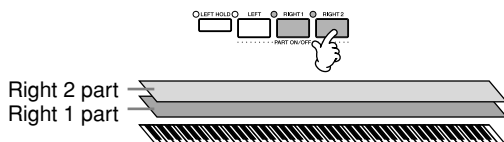

Refer to page 74 for Voice selection operations for the Right 2 part.

#### ■ Playing Different Voices with the Left and Right Hands (Right 1 and Left parts)

You can play different Voices with the left and right hands. For example, try playing the bass Voice with your left hand and the piano Voice with your right. The keyboard lamp will light at the split point of the keyboard.

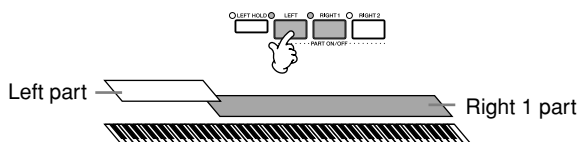

Refer to page 75 for Voice selection operations for the Left part.

#### ■ Playing Three Different Voices with the Left and Right Hands (Right 1, 2 and Left parts)

You can combine these three parts to create a rich, ensemble sound.

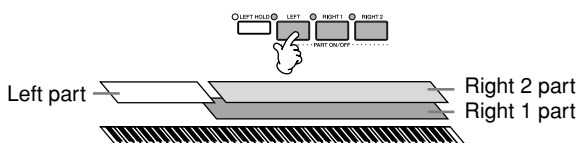

**Adjusting the volume balance among parts**  
Adjust the volume balance among the parts in the BALANCE display (page 39).

**Specifying the split point (the border between the right- and left-hand range)**  
See page 100.

## Playing Two Voices Simultaneously (Right 1 and 2 Parts)

You can play two Voices simultaneously with the Right 1 and 2 parts.

- 1 Make sure the PART ON/OFF [RIGHT 1] button is turned on.
- 2 Press the PART ON/OFF [RIGHT 2] button to turn it on.

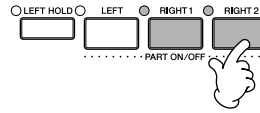

- 3 Press one of the VOICE buttons to call up the Voice selection display for the Right 2 part.

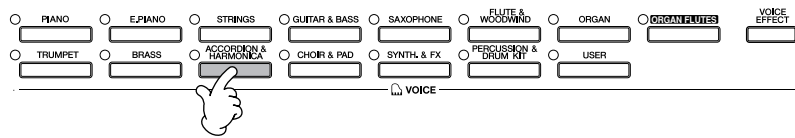

- 4 Press the TAB [◀] button to select the PRESET display.

- 5 Press one of the [A]-[J] buttons to select a Voice.
- 6 Play the keyboard.
- 7 Press the PART ON/OFF [RIGHT 2] button again to turn it off.

For the selected part, the Voice name is highlighted in the Main display.

### Quickly selecting Voices for Right 1 and 2 parts

You can quickly select the Right 1 and 2 part Voices, just from the Voice buttons. Press and hold one Voice button, then press another. The Voice of the first pressed button is automatically set for the Right 1 part, while the Voice of the second pressed button is set for the Right 2 part.

### Switching the Right 2 part on/off with a pedal

You can use a pedal to switch the Right 2 part on/off (when the Right 2 part is appropriately assigned; page 182). This is useful for turning the Right 2 part on and off while you play.

## Playing Different Voices with the Left and Right Hands (Right 1 and Left Parts)

You can play different Voices with the Left and Right Hands (Right 1 and Left parts).

- 1 Make sure the PART ON/OFF [RIGHT 1] button is turned on.
- 2 Press the PART ON/OFF [LEFT] button to turn it on.

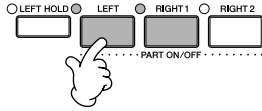

- 3 Press one of the VOICE buttons to call up the Voice selection display for the Left part.

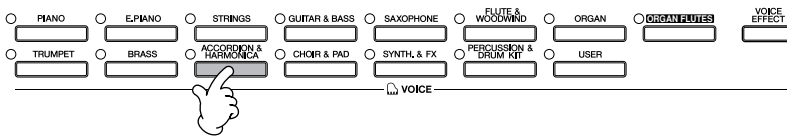

- 4 Press the TAB [◀] button to select the PRESET display.

5

A [ ]

B [ ]

C [ ]

D [ ]

E [ ]

VOICE(LEFT)

PRESET USER CARD

Musette	Steirisch
TuttiAccrd	Bandoneon
SmallAccrd	SoftAccrd
Accordion	Sweet! Harmonica
TangoAccrd	ModernHarp
Accordion&Harmonica	

P1 P2

NAME CUT COPY PASTE DELETE SAVE FOLDER DEMO

TAB

4 [◀] [▶]

5 [A] [B] [C] [D] [E]

1 2 3 4 5 6 7 8

- 5 Press one of the [A]–[J] buttons to select a Voice.
- 6 Play the keyboard.
- 7 Press the PART ON/OFF [LEFT] button again to turn it off.

For the selected part, the Voice name is highlighted in the Main display.

### Switching the Left part on/off with a pedal

You can use a pedal to switch the Left part on/off (when the Left part is appropriately assigned; page 182). This is useful for turning the Left part on and off while you play.

### Specifying the split point (the border between the right- and left-hand range)

See page 100.

Please note that the Tune function does not affect the Drum Kit or SFX Kit Voices.

#### Hz (Hertz):

This unit of measurement refers to the frequency of a sound and represents the number of times a sound wave vibrates in a second.

## Changing Pitch

### Transpose

Transpose the pitch of the keyboard up or down (in semitones).

- **Transposing during performance**  
You can easily set the desired transposition of the overall sound of the instrument by pressing the TRANSPOSE [-]/[+] buttons.
- **Transposing before performance**  
Change the transpose settings in the MIXING CONSOLE display. You can set the transposition for the keyboard pitch (KBD), song playback (SONG), or overall sound of the instrument (MASTER), respectively.
  - 1 **Call up the operation display.**  
[MIXING CONSOLE] → TAB [◀][▶] TUNE
  - 2 **Use the [1 ▲ ▼]-[3 ▲ ▼] buttons to set the transposition.**

### Fine-tuning the Pitch of the Entire Instrument

You can fine-tune the pitch of the entire instrument—useful when you play the Clavinova along with other instruments or CD music.

- 1 **Call up the operation display.**  
[FUNCTION] → [A] MASTER TUNE/SCALE TUNE → TAB [◀] MASTER TUNE
- 2 **Use the [4 ▲ ▼]/[5 ▲ ▼] buttons to set the tuning.**  
Press the 4 or 5's [▲] and [▼] buttons simultaneously to reset the value to the factory setting of 440.0 Hz.

### Scale Tuning

You can select various scales for playing in custom tunings for specific historical periods or music genres.

- 1 **Call up the operation display.**  
[FUNCTION] → [A] MASTER TUNE/SCALE TUNE → TAB [▶] SCALE TUNE
- 2 **Select the desired part for which you want to set the scale by using the [6 ▲ ▼]/[7 ▲ ▼] buttons.**  
Checkmark the box by pressing the [8 ▲] button.
- 3 **Use the [A]/[B] buttons to select the desired scale.**  
The tuning of each note for the currently selected scale is indicated in the keyboard illustration at the upper right of the display.

## 4 Change the following settings as necessary.

- **Tuning the individual notes of the keyboard (TUNE)**

- 1 Press the [3 ▲ ▼] button to select the note for tuning.
- 2 Use the [4 ▲ ▼]/[5 ▲ ▼] buttons to set the tuning in cents.

- **Determines the base note for each scale.**

Press the [2 ▲ ▼] button to select the base note.

When the base note is changed, the pitch of the keyboard is transposed, yet maintains the original pitch relationship between the notes.

**Cent:**

In musical terms a “cent” is 1/100th of a semitone. (100 cents equal one semitone.)

**Instantly recalling the desired scale**

Register the desired scale to the Registration Memory. Be sure to checkmark the SCALE item when registering (page 121).

### Preset Scale Types

<b>EQUAL TEMPERAMENT</b>	The pitch range of each octave is divided equally into twelve parts, with each half-step evenly spaced in pitch. This is the most commonly used tuning in music today.
<b>PURE MAJOR PURE MINOR</b>	These tunings preserve the pure mathematical intervals of each scale, especially for triad chords (root, third, fifth). You can hear this best in actual vocal harmonies – such as choirs and a cappella singing.
<b>PYTHAGOREAN</b>	This scale was devised by the famous Greek philosopher and is created from a series of perfect fifths, which are collapsed into a single octave. The 3rd in this tuning are slightly unstable, but the 4th and 5th are beautiful and suitable for some leads.
<b>MEAN-TONE</b>	This scale was created as an improvement on the Pythagorean scale, by making the major third interval more “in tune.” It was especially popular from the 16th century to the 18th century. Handel, among others, used this scale.
<b>WERCKMEISTER KIRNBERGER</b>	This composite scale combines the Werckmeister and Kirnberger systems, which were themselves improvements on the mean-tone and Pythagorean scales. The main feature of this scale is that each key has its own unique character. The scale was used extensively during the time of Bach and Beethoven, and even now it is often used when performing period music on the harpsichord.
<b>ARABIC</b>	Use these tunings when playing Arabic music.

### Tuning values for Preset Scales (base note: C) (in cents)

	C	C#	D	Eb	E	F	F#	G	Ab	A	Bb	B
<b>EQUAL TEMPERAMENT</b>	0	0	0	0	0	0	0	0	0	0	0	0
<b>PURE MAJOR</b>	0	-29.7	3.9	15.6	-14.1	-2.3	-9.4	2.3	-27.3	-15.6	18.0	-11.7
<b>PURE MINOR</b>	0	33.6	3.9	15.6	-14.1	-2.3	31.3	2.3	14.1	-15.6	18.0	-11.7
<b>PYTHAGOREAN</b>	0	14.1	3.9	-6.3	7.8	-2.3	11.7	2.3	15.6	6.3	-3.9	10.2
<b>MEAN-TONE</b>	0	-24.2	-7.0	10.2	-14.1	3.1	-20.3	-3.1	-27.3	-10.2	7.0	-17.2
<b>WERCKMEISTER</b>	0	-10.2	-7.8	-6.3	-10.2	-2.3	-11.7	-3.9	-7.8	-11.7	-3.9	-7.8
<b>KIRNBERGER</b>	0	-10.2	-7.0	-6.3	-14.1	-2.3	-10.2	-3.1	-7.8	-10.2	-3.9	-11.7
<b>ARABIC 1</b>	0	0	-50.0	0	0	0	0	0	0	-50.0	0	0
<b>ARABIC 2</b>	0	0	0	0	-50.0	0	0	0	0	0	0	-50.0

\* In the display, the rounded off value is shown.

# Adding Effects to Voices Played on the Keyboard

The CVP features a sophisticated multi-processor effect system which can add extraordinary depth and expression to your sound.

- 1 Select the desired part for which you want to add effects by pressing one of the PART SELECT buttons.
- 2 Press the [VOICE EFFECT] button to call up the VOICE EFFECT display.

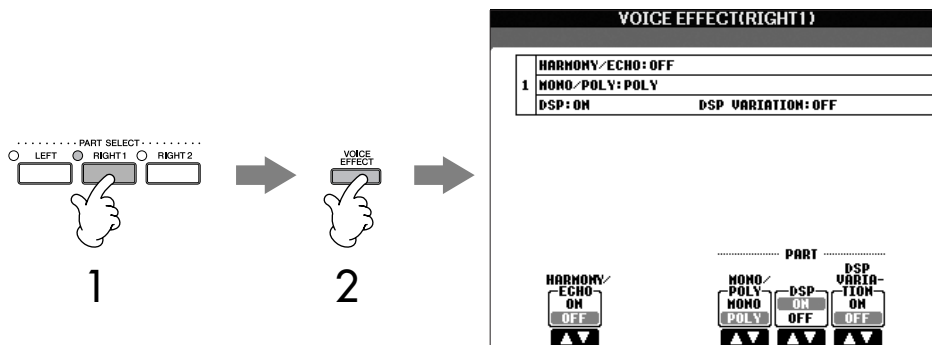

- 3 Use the buttons at the lower part of the display to apply effects to the Voices.

## Effect Parameters

<b>HARMONY/ECHO</b>	The Harmony/Echo types are applied to the right-hand Voices (page 79).
<b>MONO/POLY</b>	This determines whether the part's Voice is played monophonically (only one note at a time) or polyphonically. Using the MONO mode lets you play single, lead sounds (such as brass instruments) more realistically. It also lets you expressively control the Portamento effect (depending on the selected Voice) by playing legato.
<b>DSP/DSP VARIATION</b>	With the digital effects built into the Clavinova, you can add ambience and depth to your music in a variety of ways—such as adding reverb that makes you sound like you are playing in a concert hall. <ul style="list-style-type: none"> <li>• The DSP switch is used to turn the DSP (Digital Signal Processor) effect on or off for the currently selected keyboard part.</li> <li>• The DSP Variation switch is used to change between variations of the DSP effect. You could use this while you play, for example, to change the rotating speed (slow/fast) of the rotary speaker effect.</li> </ul>

## Selecting the Harmony/Echo type

You can select the desired Harmony/Echo effect from a variety of types. In order to make the type you've selected here effective, set HARMONY/ECHO to On in the display shown in step 2 above.

- 1 Call up the operation display.  
[FUNCTION] → [F] HARMONY/ECHO
- 2 Use the [1 ▲ ▼]–[3 ▲ ▼] buttons to select the Harmony/Echo type (page 79).
- 3 Use the [4 ▲ ▼]–[8 ▲ ▼] buttons to select various Harmony/Echo settings (page 80).  
The available settings differ depending on the Harmony/Echo type.

You can use a pedal to turn the Harmony/Echo effects on and off (page 182).

### Portamento:

Portamento is a function that creates a smooth transition in pitch from the first note played on the keyboard to the next. The portamento time (the pitch transition time) can be set via the MIXING CONSOLE display (page 82).

### DSP:

Stands for Digital Signal Processor (or Processing). DSP changes and enhances the audio signal in the digital realm to produce a wide range of effects.

## Harmony/Echo Types

The Harmony/Echo types are divided into the following groups, depending on the particular effect applied.

### Harmony Types

These types apply the harmony effect to notes played in the right-hand section of the keyboard according to the chord specified in the left-hand section of the keyboard. (Note that the "1+5" and "Octave" settings are not affected by the chord.)

### Multi Assign Type

This type applies a special effect to chords played in the right-hand section of the keyboard.

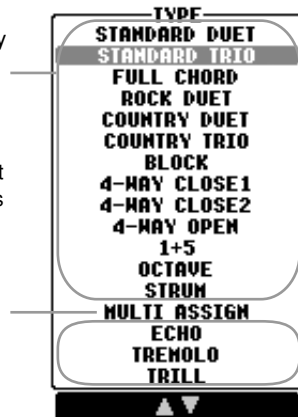

### Echo Types

These types apply echo effects to notes played in the right-hand section of the keyboard in time with the currently set tempo.

## ● Harmony Types

When one of the Harmony Types is selected, the Harmony effect is applied to notes played in the right-hand section of the keyboard according to the type selected above and the chord specified in the chord section of the keyboard shown below.

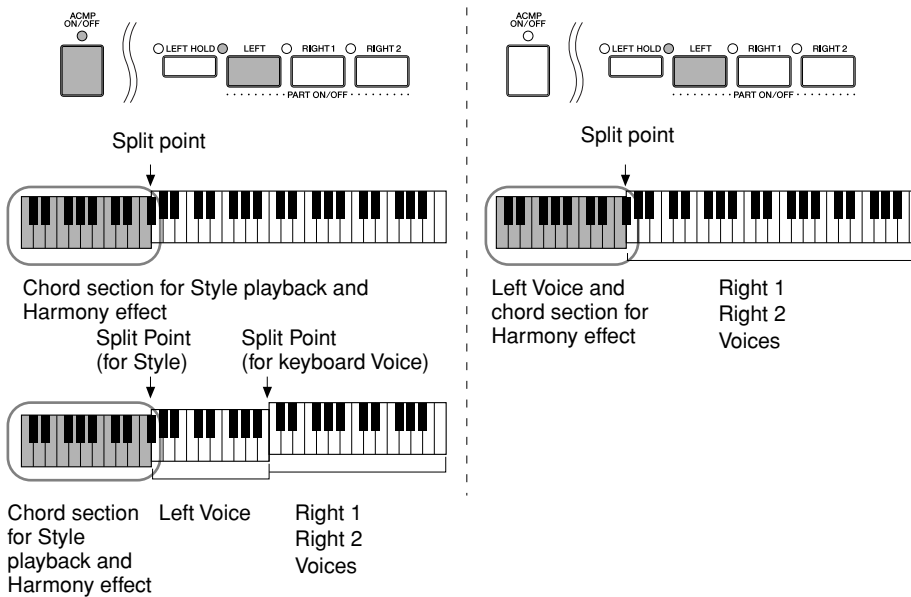

## ● Multi Assign Type

Multi Assign effect automatically assigns notes played simultaneously in the right-hand section of the keyboard to separate parts (Voices). Both of the keyboard part [RIGHT 1] and [RIGHT 2] should be turned on when using the Multi Assign effect. The Right 1 and Right 2 Voices are alternately assigned to the notes in the order you play.

## ● Echo Types

When one of the Echo Types is selected, the corresponding effect (echo, tremolo, trill) is applied to the note played in the right-hand section of the keyboard in time with the currently set tempo, regardless of the [ACMP ON/OFF] and the LEFT part on/off status. Keep in mind that Trill works when you hold down two notes on the keyboard simultaneously (last two notes if more than two notes are held), and it plays those notes alternately.

### Canceling the chord sound for the harmony effect

This cancels the sound of the chord played in the chord range of the keyboard—letting you hear only the Harmony effect. Set [ACMP ON/OFF] to On, set [SYNC START] to Off, and select "Off" for the Stop Accompaniment parameter.

### Harmony/Echo Settings

<b>VOLUME</b>	This parameter is available for all types with the exception of “Multi Assign.” It determines the level of the harmony/echo notes generated by the Harmony/Echo effect.
<b>SPEED</b>	This parameter is only available when Echo, Tremolo, or Trill is selected in Type above. It determines the speed of the Echo, Tremolo, and Trill effects.
<b>ASSIGN</b>	This parameter is available for all types with the exception of “Multi Assign.” This lets you determine the keyboard part via which the harmony/echo notes will be sounded.
<b>CHORD NOTE ONLY</b>	This parameter is available when one of the Harmony Types is selected. When this is set to “ON,” the Harmony effect is applied only to the note (played in the right-hand section of the keyboard) that belongs to a chord played in the chord section of the keyboard.
<b>TOUCH LIMIT</b>	This parameter is available for all types with the exception of “Multi Assign.” It determines the lowest velocity value at which the harmony note will sound. This allows you to selectively apply the harmony by your playing strength, letting you create harmony accents in the melody. The harmony effect is applied when you play the key strongly (above the set value).

## Editing the Volume and Tonal Balance (MIXING CONSOLE)

The Mixing Console gives you intuitive control over aspects of the keyboard parts and Song/Style channels, including volume balance and the timbre of the sounds. It lets you adjust the levels and stereo position (pan) of each Voice to set the optimum balance and stereo image, and lets you set how the effects are applied.

### Basic Procedure

- 1 Press the [MIXING CONSOLE] button to call up the MIXING CONSOLE display.

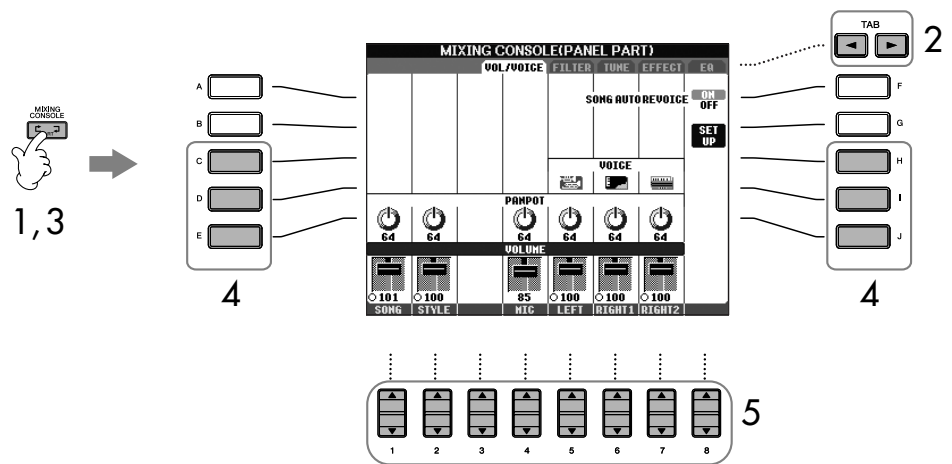

- 2 Use the TAB [◀]/[▶] buttons to call up the relevant setting display. For information on the available parameters, see the section “Adjustable items (parameters) in the MIXING CONSOLE displays” on page 82.



- 3 Press the [MIXING CONSOLE] button repeatedly to call up the MIXING CONSOLE display for the relevant parts. The MIXING CONSOLE displays actually consist of several different part displays. The part name is indicated at the top of the display. The various MIXING CONSOLE displays alternate among the following: PANEL PART display → STYLE PART display → SONG CH 1–8 display → SONG CH 9–16 display
- 4 Press one of the [A]–[J] buttons to select the desired parameter.
- 5 Use the [1▲▼]–[8▲▼] buttons to set the value.
- 6 Save your MIXING CONSOLE settings.
  - **Saving the PANEL PART display settings**  
Register them to Registration Memory (page 121).
  - **Saving the STYLE PART display settings**  
Save them as Style data.
    - 1 Press the [DIGITAL RECORDING] button.
    - 2 Press the [B] button to call up the STYLE CREATOR display.
    - 3 Press the [EXIT] button to close the RECORD display.
    - 4 Press the [I] (SAVE) button to call up the Style Selection display for saving your data, then save it (page 63).
  - **Saving the SONG CH 1–8/9–16 display settings**  
First register the edited settings as part of the Song data (SET UP), then save the Song.  
See the SONG CREATOR → CHANNEL display → SETUP item explanation on page 152.

### About Parts

#### PANEL PART

In the PANEL PART display of the MIXING CONSOLE, you can independently adjust the level balance among the Keyboard parts (RIGHT 1, RIGHT 2 and LEFT), SONG, STYLE, and MIC (CVP-305/303) parts. The part components are the same as those that appear in the display when you press the panel [BALANCE] button.

#### STYLE PART

A Style consists of eight separate channels. Here you can adjust the level balance among these eight channels or parts. These part components are the same as those that appear in the display when you press the panel [CHANNEL ON/OFF] button to call up the STYLE display.

#### SONG CH 1–8/9–16

A Song consists of sixteen separate channels. Here you can adjust the level balance among these sixteen channels or parts. These part components are the same as those that appear in the display when you press the panel [CHANNEL ON/OFF] button to call up the SONG display.

### About Parts

See below.

### Instantly setting all parts to the same value

Once you've selected a parameter in step 4, you can instantly set the same value to all other parts. To do this, simultaneously hold down one of the [A]–[J] buttons, and use the [1]–[8] buttons or the [DATA ENTRY] dial.

- The RHY1 channel in the STYLE PART display cannot be assigned to Organ Flute Voices.
- The RHY2 channel in the STYLE PART display can only be assigned to Drumkit Voices and SFX kit Voices.
- When playing GM song data, channel 10 (in the SONG CH 9–16 page) can only be used for a Drum Kit Voice.

## Adjustable Items (parameters) in the MIXING CONSOLE Displays

The following explanations cover the available items (parameters) in the MIXING CONSOLE displays.

### VOL/VOICE

<b>SONG AUTO REVOICE</b>	See page 83.
<b>VOICE</b>	Allows you to re-select the Voices for each part. When the Style channels are called up, neither Organ Flutes Voices nor User Voices can be selected. When the Song channels are called up, User Voices cannot be selected.
<b>PANPOT</b>	Determines the stereo position of the selected part (channel).
<b>VOLUME</b>	Determines the level of each part or channel, giving you fine control over the balance of all the parts.

### FILTER

<b>HARMONIC CONTENT</b>	Allows you to adjust the resonance effect (page 91) for each part.
<b>BRIGHTNESS</b>	Determines the brightness of the sound for each part by adjusting the cutoff frequency (page 91).

### TUNE

<b>PORTAMENTO TIME</b>	Portamento is a function that creates a smooth transition in pitch from the first note played on the keyboard to the next. The Portamento Time determines the pitch transition time. Higher values result in a longer pitch change time. Setting this to "0" results in no effect. This parameter is available when the selected keyboard part is set to Mono (page 78).
<b>PITCH BEND RANGE</b>	Determines the range of the PITCH BEND in semitones for each keyboard part (when a pedal is assigned to this function).
<b>OCTAVE</b>	Determines the range of the pitch change in octaves for each keyboard part.
<b>TUNING</b>	Determines the pitch of each keyboard part.
<b>TRANSPOSE</b>	Allows you to set the transposition for the keyboard pitch (KEYBOARD), Song playback (SONG), or overall sound of the instrument (MASTER), respectively.

### EFFECT

<b>TYPE</b>	Select the desired effect type (page 85). After editing various parameters for the selected effect type, you can save it as an original effect.
<b>REVERB</b>	Adjusts the amount of the Reverb sound for each part or channel. At the right side of the title indication of "REVERB," the currently selected reverb type name is shown.
<b>CHORUS</b>	Adjusts the amount of the Chorus sound for each part or channel.
<b>DSP</b>	Adjusts the amount of the DSP sound for each part or channel.

### EQ (Equalizer)

<b>TYPE</b>	Select the desired EQ type to suit the type of music and the performance environment (page 87). This affects the overall sound of the CVP.
<b>EDIT</b>	For editing the EQ (page 87).
<b>EQ HIGH</b>	Determines the center frequency of the high EQ band that is attenuated/boosted for each part.
<b>EQ LOW</b>	Determines the center frequency of the low EQ band that is attenuated/boosted for each part.

### Song Auto Revoice

This feature lets you use the high-quality sounds of the instrument to full advantage with XG-compatible song data. When you play back any commercially available XG song data or that created on other instruments, you can use Auto Revoice to automatically assign the specially created Voices of the Clavinova (Natural!, Live!, Cool!, etc.) instead of the conventional XG Voices of the same type.

- 1-3 Same operation as in the "Basic Procedure" on page 80. In step 2, select the VOL/VOICE tab.
- 4 Press the [G] (SETUP) button to call up the AUTO REVOICE SETUP display.
- 5 Use the [1▲▼]-[3▲▼] buttons to select the Voice to be replaced.

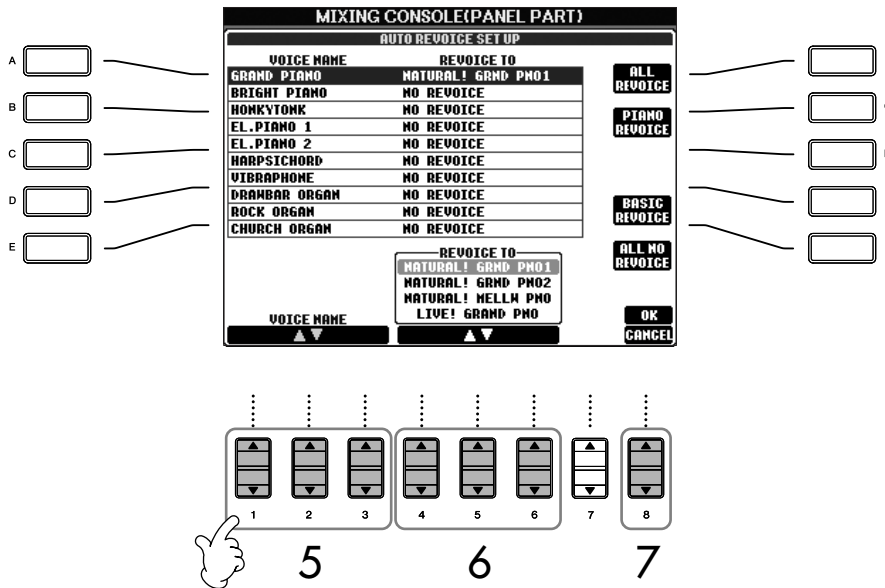

- 6 Use the [4▲▼]-[6▲▼] buttons to select the Voice for replacing the XG selected in step 5. Several different Revoice settings are available by using the [F]/[G]/[H] buttons, for conveniently calling up the recommended Revoice settings in one action.

- ALL REVOICE:** Replaces all of the replaceable XG Voices with the high-quality Voices of the Clavinova.
- PIANO REVOICE:** Replaces only the piano Voices.
- BASIC REVOICE:** Replaces only the recommended Voices that are suitable for playing back the song.
- ALL NO REVOICE:** All Voices are returned to the original XG Voices.

- 7 Press the [8▲] (OK) button to apply your Revoice settings.  
To cancel the Revoice operation, press the [8▼] (CANCEL) button.
- 8 In the VOL/VOICE tab display, press the [F] button to set SONG AUTO REVOICE to ON.

## Effect Type

### ■ Selecting an Effect type

- 1-3 Same operation as in the "Basic Procedure" on page 80. In step 2, select the EFFECT tab.
- 4 Press the [F] (TYPE) button to call up the Effect Type selection display.

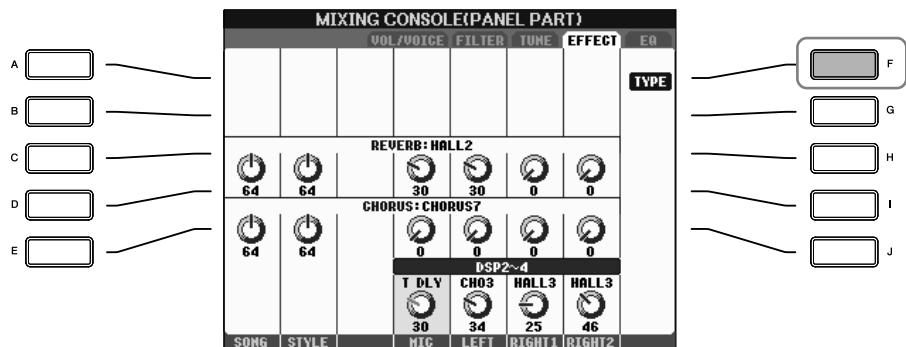

- 5 Use the [1▲▼]/[2▲▼] buttons to select the effect BLOCK.

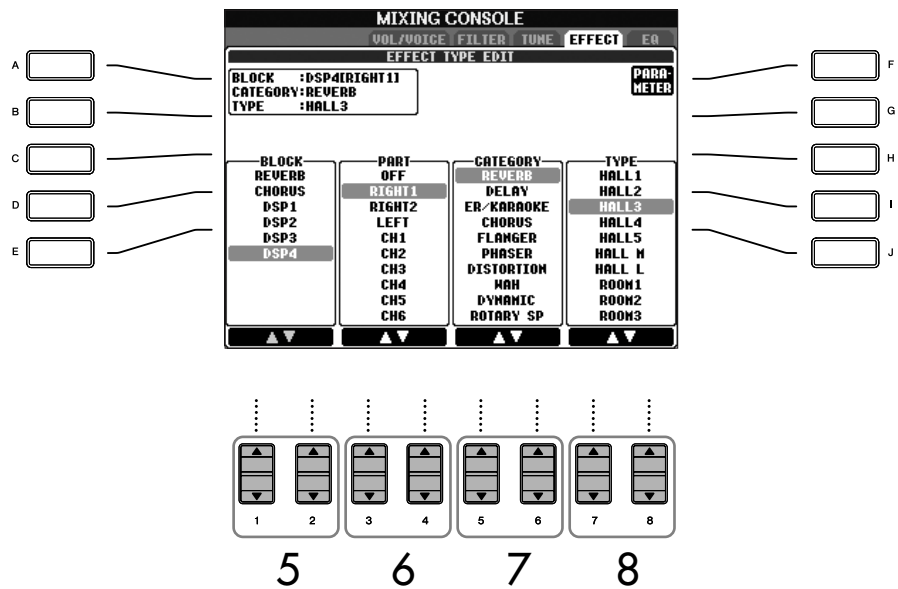

**DSP:**  
Stands for Digital Signal Processor (or Processing). DSP changes and enhances the audio signal in the digital realm to produce a wide range of effects.

Effect Block	Effect-applicable parts	Effect characteristics
REVERB	All parts	Reproduces the warm ambience of playing in a concert hall or jazz club.
CHORUS	All parts	Produces a rich "fat" sound as if several parts are being played simultaneously.
DSP1	STYLE PART SONG CHANNEL 1-16	In addition to the Reverb and Chorus types, the Clavinova has special DSP effects, that include additional effects usually used for a specific part, such as distortion and tremolo.
DSP2 DSP3	RIGHT 1, RIGHT 2, LEFT, SONG CHANNEL 1-16	Any unused DSP blocks are automatically assigned to the appropriate parts (channels) as needed.
DSP4	RIGHT 1, RIGHT 2, LEFT, SONG CHANNEL 1-16, MIC (CVP-305/303)	

- 6 Use the [3 ▲ ▼]/[4 ▲ ▼] buttons to select the part to which you want to apply the effect.
- 7 Use the [5 ▲ ▼]/[6 ▲ ▼] buttons to select the effect CATEGORY.
- 8 Use the [7 ▲ ▼]/[8 ▲ ▼] buttons to select the effect TYPE.

If you want to edit the effect parameters, go on to the next operation.

■ Editing and Saving the selected effect

- 9 Press the [F] (PARAMETER) button to call up the display for editing the effect parameters.

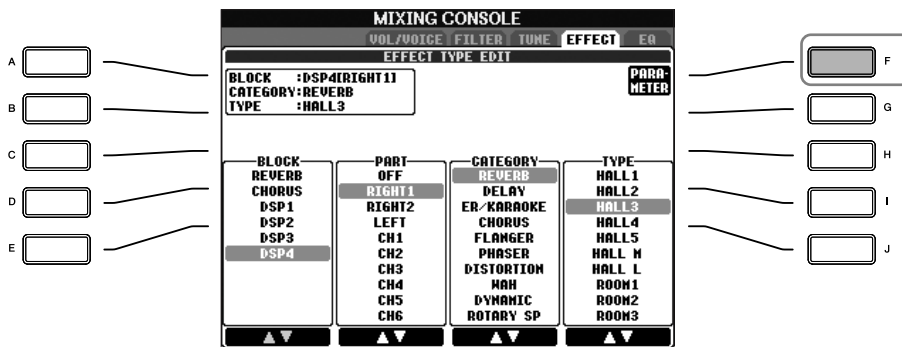

- 10 If you have selected one of the DSP 2-4 effect blocks in step 5: You can edit its standard parameters as well as its variation parameter. To select the standard type of parameters, press the [B] button. To select its variation parameter, press the [E] button.

**Re-selecting the Effect block, category and type**  
Use the [1 ▲ ▼]–[3 ▲ ▼] buttons. The re-selected effect configuration is displayed at the upper left side box in the display.

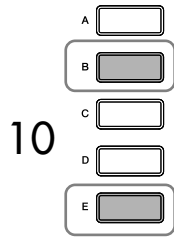

10

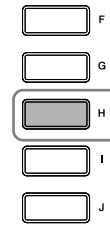
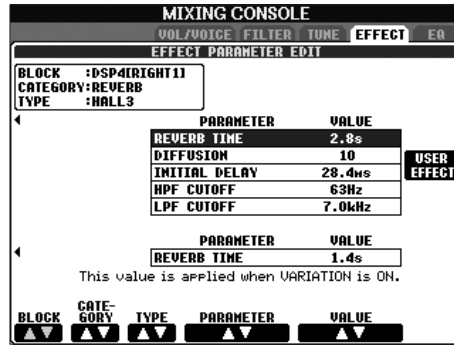

13

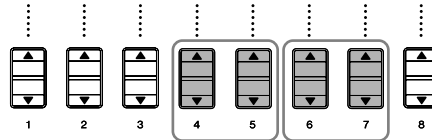

11 12

- 11** Select one of the parameters you want to edit by using the [4 ▲ ▼]/ [5 ▲ ▼] buttons.  
Available parameters differ depending on the selected Effect type.
- 12** Adjust the value for the selected parameter by using the [6 ▲ ▼]/ [7 ▲ ▼] buttons.  
If you have selected the REVERB, CHORUS or DSP1 effect block in step 5: Adjust the Effect Return Level by pressing [8 ▲ ▼] button.
- 13** Press the [H] (USER EFFECT) button to call up the display for saving your original effect.
- 14** Use the [3 ▲ ▼]–[6 ▲ ▼] buttons to select the destination for saving the effect.  
The maximum number for effects that can be saved differs depending on the effect block.

**Effect Return Level:**  
Determines the level or amount of effect applied.  
This is set for all parts or channels.

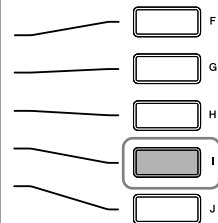
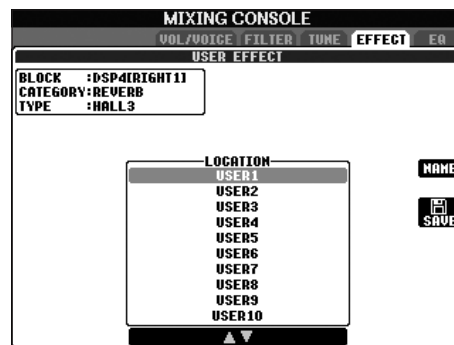
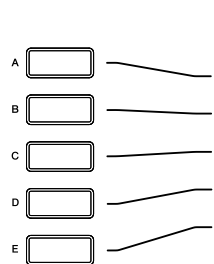

15

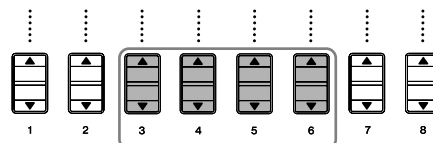

14

- 15** Press the [I] (SAVE) button to save the effect (page 63).  
When recalling the saved effect, use the same procedure as in step 8. If you want to change the effect name, press the [H] (NAME) button.

## EQ (Equalizer)

Equalizer (also called “EQ”) is a sound processor that divides the frequency spectrum into multiple bands that can be boosted or cut as required to tailor the overall frequency response. Usually an equalizer is used to correct the sound from speakers to match the special character of the room. For example, you can cut some of the low range frequencies when playing in large spaces where the sound is too “boomy,” or boost the high frequencies in rooms and close spaces where the sound is relatively “dead” and free of echoes. The Clavinova possesses a high-grade five-band digital EQ. With this function, a final effect—tone control can be added to the output of your instrument. You can select one of the five preset EQ settings in the EQ display. You can even create your own custom EQ settings by adjusting the frequency bands, and save the settings to one of two User Master EQ types.

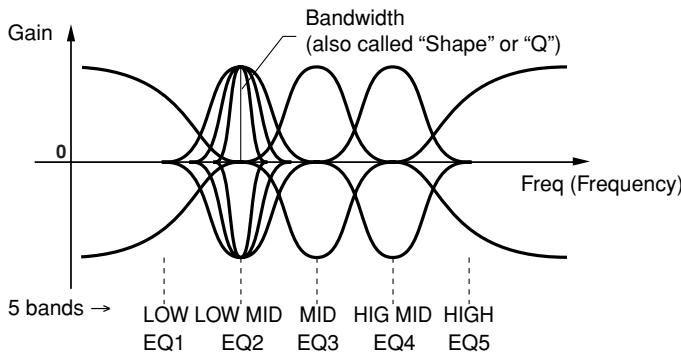

### ■ Select a Preset EQ type

- 1–3 Same operation as in the “Basic Procedure” on page 80. In step 2, select the EQ tab.
- 4 Use the [A]/[B] buttons to select a preset EQ type to suit your performance (music style or environment).

If you want to edit the EQ parameters, go on to the next operation.

### ■ Editing and Saving the selected EQ

- 5 Press the [F] (EDIT) button to call up the MASTER EQ EDIT display.

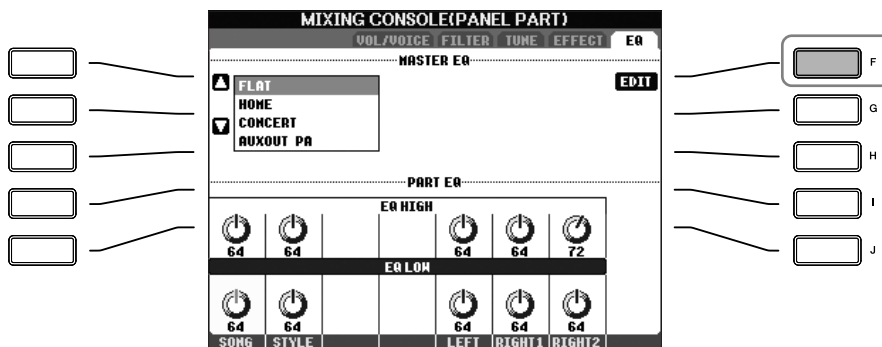

6 Use the [A]/[B] buttons to select a preset EQ type.

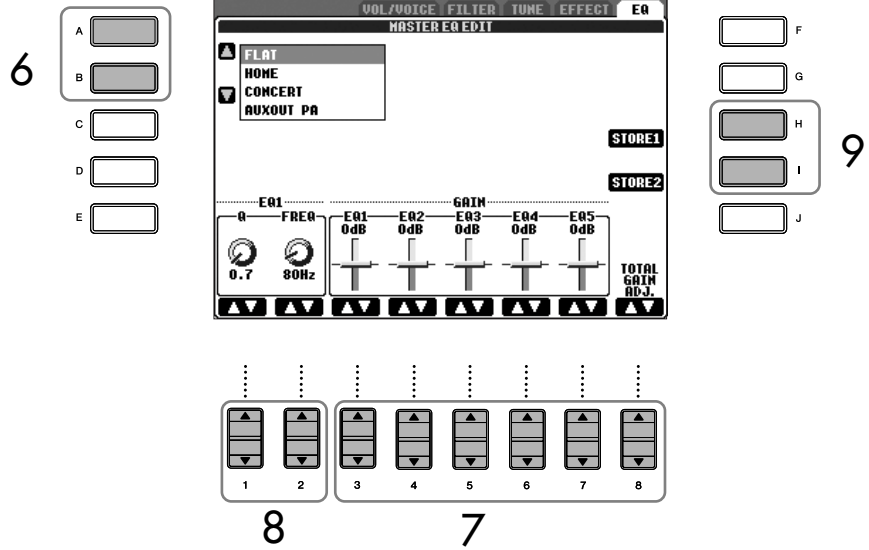

7 Use the [3 ▲ ▼]-[7 ▲ ▼] buttons to boost or cut each of the five bands.  
Use the [8 ▲ ▼] button to boost or cut all the five bands at the same time.

8 Adjust the Q (bandwidth) and the FREQ (center frequency) of the band selected in step 7.

- **Bandwidth (also called "Shape" or "Q")**  
Use the [1 ▲ ▼] button. The higher the value of Q, the narrower the band width.
- **FREQ (center frequency)**  
Use the [2 ▲ ▼] button. The available FREQ range is different for each band.

9 Press the [H] or [I] (STORE 1 or 2) button to save the edited EQ type (page 63).  
Up to two types of EQ can be created and saved. When recalling the saved EQ type, use the same procedure as in step 6.



# Voice Creating (Sound Creator)

The Clavinova has a Sound Creator feature that allows you to create your own Voices by editing some parameters of the existing Voices. Once you've created a Voice, you can save it as a User Voice to the USER/CARD/(USB) display for future recall. The editing method is different for the ORGAN FLUTES Voices and for other Voices.

## Editing the ORGAN FLUTES Voices

The editing method is different for the ORGAN FLUTES Voices compared to other Voices. For instructions on editing the ORGAN FLUTES Voices, see page 93.

## Basic Procedure

- 1 Select the desired Voice (other than an Organ Flutes Voice) (page 31).
- 2 Press the [SOUND CREATOR] button to call up the SOUND CREATOR display.

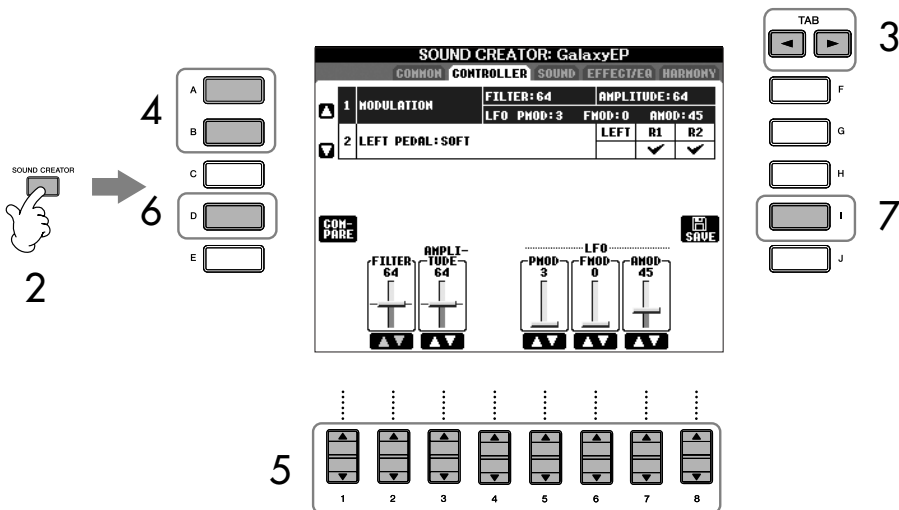

- 3 Use the TAB [◀]/[▶] buttons to call up the relevant setting display. For information on the available parameters, see the “Editable Parameters in the SOUND CREATOR Displays” on page 90.
- 4 As necessary, use the [A]/[B] buttons to select the item (parameter) to be edited.
- 5 Use the [1▲▼]–[8▲▼] buttons to edit the Voice.
- 6 Press the [D] (COMPARE) button to compare the sound of the edited Voice with the unedited Voice.
- 7 Press the [I] (SAVE) button to save your edited Voice (page 63).

### ⚠ CAUTION

If you select another Voice without saving the settings, the settings will be lost. If you wish to store the settings here, make sure to save the settings as a User Voice before selecting another Voice or turning the power off.

The available parameters differ depending on the Voice.

## Editable Parameters in the SOUND CREATOR Displays

The following covers in detail the editable parameters that are set in the displays explained in step 3 of the “Basic Procedure” on page 89. The Sound Creator parameters are organized into five different displays. The parameters in each display are described separately, below. These are also treated as part of the Voice Set parameters (page 96), which are automatically called up when the Voice is selected.

### PIANO

This display is available only when the Natural! piano Voice (page 72) is selected.

<b>TUNING CURVE</b>	Determines the tuning curve. Select “FLAT” if you feel the tuning curve of the piano Voice does not quite match that of other instruments Voices. <b>STRETCH</b> Tuning curve particularly for pianos <b>FLAT</b> Tuning curve in which the frequency is octave doubled over the entire keyboard range
<b>KEY OFF SAMPLE (CVP-305/303)</b>	Adjusts the volume of the key-off sound (the subtle sound that occurs when you release a key).
<b>SUSTAIN SAMPLE (CVP-305/303)</b>	Adjusts the depth of sustain sampling for the damper pedal.
<b>STRING RESONANCE (CVP-305)</b>	Adjusts the depth of string resonance.

### COMMON

<b>VOLUME</b>	Adjusts the volume of the current edited Voice.
<b>TOUCH SENSE</b>	Adjusts the touch sensitivity, or how greatly the volume responds to your playing strength. A setting of “0” produces more extreme drops in level, the more softly you play, while a setting of “64” is normal response, and “127” produces high volume for any playing strength (fixed).
<b>PART OCTAVE</b>	Shifts the octave range of the edited Voice up or down in octaves. When the edited Voice is used as any of the RIGHT 1–2 parts, the R1/R2 parameter is available; when the edited Voice is used as the LEFT part, the LEFT parameter is available.
<b>MONO/POLY</b>	Determines whether the edited Voice is played monophonically or polyphonically (page 78).
<b>PORTAMENTO TIME</b>	Sets the portamento time when the edited Voice is set to “MONO” above.

**Portamento Time:**  
The Portamento Time determines the pitch transition time. Portamento is a function that creates a smooth transition in pitch from the first note played on the keyboard to the next.

### CONTROLLER 1. MODULATION

When a pedal function is assigned to MODULATION, the pedal can be used to modulate the parameters below as well as the pitch (vibrato). Here, you can set the degree to which the pedal modulates each of the following parameters.

<b>FILTER</b>	Determines the degree to which the pedal modulates the Filter Cut-off Frequency. For details about the filter, see page 91.
<b>AMPLITUDE</b>	Determines the degree to which the pedal modulates the amplitude (volume).
<b>LFO PMOD</b>	Determines the degree to which the pedal modulates the pitch, or the vibrato effect.
<b>LFO FMOD</b>	Determines the degree to which the pedal modulates the Filter modulation, or the wah effect.

<b>FILTER</b>	Determines the degree to which the pedal modulates the Filter Cut-off Frequency. For details about the filter, see page 91.
<b>LFO AMOD</b>	Determines the degree to which the pedal modulates the amplitude, or the tremolo effect.

**2. LEFT PEDAL**

This allows you to select the function to be assigned to the left pedal.

<b>FUNCTION</b>	Selects the function to be assigned to the left pedal. For details on the pedal functions, see page 182.
<b>[2 ▲ ▼]–[8 ▲ ▼] buttons (RIGHT 1, RIGHT 2, LEFT, etc.)</b>	Determines whether the assigned function is effective or not for the respective keyboard part. This also determines the depth for the function. For details, see page 183.

**SOUND**

● **FILTER**

Filter is a processor that changes the timbre or tone of a sound by either blocking or passing a specific frequency range. The parameters below determine the overall timbre of the sound by boosting or cutting a certain frequency range. In addition to making the sound either brighter or mellower, Filter can be used to produce electronic, synthesizer-like effects.

<b>BRIGHTNESS</b>	<p>Determines the cutoff frequency or effective frequency range of the filter (see diagram). Higher values result in a brighter sound.</p> <p>Volume</p> <p>Cutoff frequency</p> <p>Frequency (pitch)</p> <p>Cutoff range</p> <p>These frequencies are "passed" by the filter.</p>
<b>HARMONIC CONTENT</b>	<p>Determines the emphasis given to the cutoff frequency (resonance), set in BRIGHTNESS above (see diagram). Higher values result in a more pronounced effect.</p> <p>Volume</p> <p>Resonance</p> <p>Frequency (pitch)</p>

● **EG**

The EG (Envelope Generator) settings determine how the level of the sound changes in time. This lets you reproduce many sound characteristics of natural acoustic instruments—such as the quick attack and decay of percussion sounds, or the long release of a sustained piano tone.

<b>ATTACK</b>	Determines how quickly the sound reaches its maximum level after the key is played. The lower the value, the quicker the attack.
<b>DECAY</b>	Determines how quickly the sound reaches its sustain level (a slightly lower level than maximum). The lower the value, the quicker the decay.
<b>RELEASE</b>	Determines how quickly the sound decays to silence after the key is released. The lower the value, the quicker the decay.

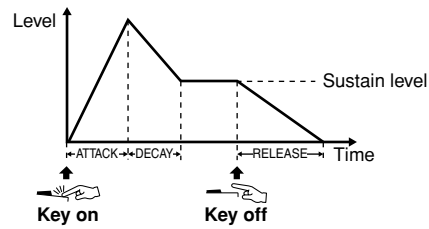

● **VIBRATO**

<b>DEPTH</b>	Determines the intensity of the Vibrato effect. Higher settings result in a more pronounced Vibrato.
<b>SPEED</b>	Determines the speed of the Vibrato effect.
<b>DELAY</b>	Determines the amount of time that elapses between the playing of a key and the start of the Vibrato effect. Higher settings increase the delay of the Vibrato onset.

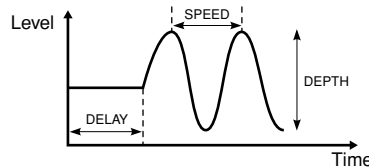

**Vibrato:**

A quavering, vibrating sound effect that is produced by regularly modulating the pitch of the Voice.

**EFFECT/EQ**

**1. REVERB DEPTH/CHORUS DEPTH/DSP DEPTH**

<b>REVERB DEPTH</b>	Adjusts the reverb (page 85) depth.
<b>CHORUS DEPTH</b>	Adjusts the chorus (page 85) depth.
<b>DSP DEPTH</b>	Adjusts the DSP (page 85) depth. If you want to re-select the DSP type, you can do so in the DSP menu explained on page 93.
<b>DSP ON/OFF</b>	Determines whether the DSP is on or off.
<b>VIBE ROTOR</b>	This will be displayed only if VIBE VIBRATE is selected for the DSP Type parameter explained on page 85. Determines whether VIBE VIBRATE should be set to on or off when selecting the Voice.

**Switching the VIBE ROTOR on/off with a pedal**

You can use a pedal to switch the VIBE ROTOR on/off (when the VIBE ROTOR ON/OFF function is properly assigned; page 182).

## 2. DSP

<b>DSP TYPE</b>	Selects the DSP effect category and type. Select a type after selecting a category.
<b>VARIATION</b>	<p>Two variations are provided for each DSP type. Here, you can edit the VARIATION on/off status and variation-parameter value setting.</p> <p><b>ON/OFF</b> The factory-programmed assignments are set to variation-off for all Voices (standard variation of DSP is assigned). If you select VARIATION ON here, a variation of the DSP effect is assigned to the Voice. The variation parameter value can be adjusted in the VALUE menu explained below.</p> <p><b>PARAMETER</b> Displays the variation parameter.</p> <p><b>VALUE</b> Adjusts the value of the DSP variation parameter.</p>

## 3. EQ

<b>EQ LOW/HIGH</b>	These determine the Frequency and Gain of the Low and High EQ bands.
--------------------	--

### HARMONY

Same as in the [FUNCTION] → [F] HARMONY/ECHO display. See page 78.

## Creating Your Original Organ Flutes Voices

The Clavinova features a variety of lush, dynamic organ Voices that you can call up with the [ORGAN FLUTES] button. It also gives you the tools to create your own original organ sounds by using the Sound Creator function. Just as on a traditional organ, you can create your own sounds by adjusting the levels of the flute footages.

### Basic Procedure

- 1 Select the desired Organ Flutes Voice to be edited (page 31).

2 In the ORGAN FLUTES Voice Selection display, press the [7 ▲] (FOOTAGE) button to call up the SOUND CREATOR [ORGAN FLUTES] display.

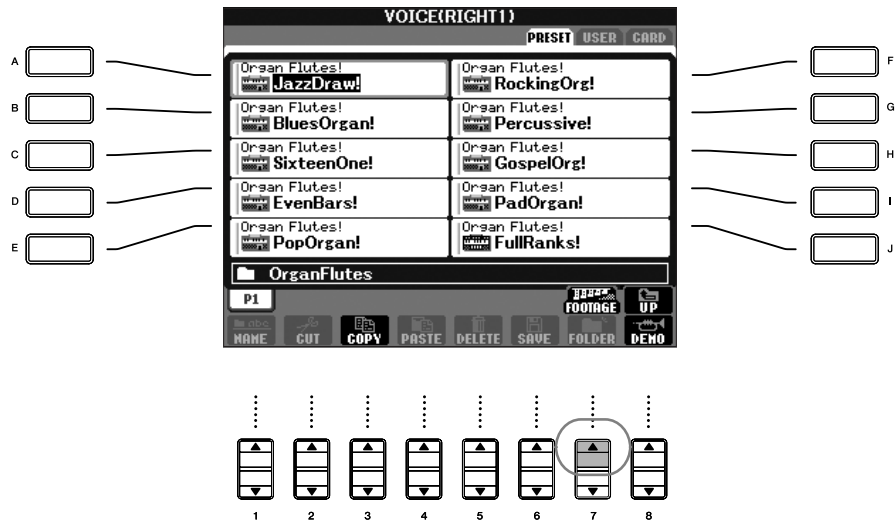

3 Use the TAB [◀]/[▶] buttons to call up the relevant setting display. For information on the available parameters, see the “Editable Parameters in the SOUND CREATOR [ORGAN FLUTES] displays” on page 95.

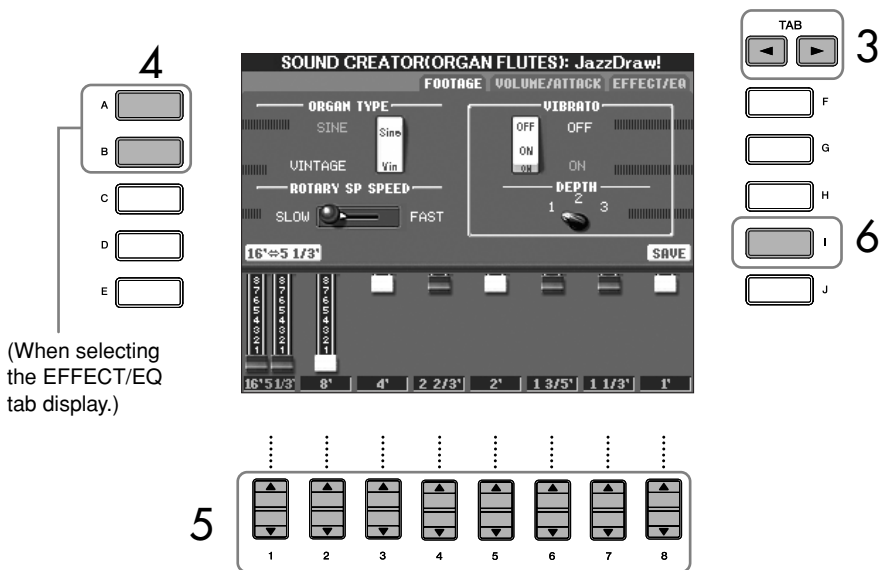

(When selecting the EFFECT/EQ tab display.)

4 If you select the EFFECT/EQ tab display, use the [A]/[B] buttons to select the parameter to be edited.

5 Use the [A]-[D], [F]-[H] and [1 ▲ ▼]-[8 ▲ ▼] buttons to edit the Voice.

6 Press the [I] (SAVE) button to save your edited ORGAN FLUTES Voice (page 63).

**CAUTION**

If you select another Voice without saving the settings, the settings will be lost. If you wish to store the settings here, make sure to save the settings as a User Voice before selecting another Voice or turning the power off.

## Editable Parameters in the SOUND CREATOR [ORGAN FLUTES] displays

The following covers in detail the editable parameters that are set in the displays explained in step 3 of the “Basic Procedure” on page 89. The Organ Flutes parameters are organized into three different pages. The parameters in each page are described separately, below. These are also treated as part of the Voice Set parameters (page 96), which are automatically called up when the Voice is selected.

### FOOTAGE, VOLUME/ATTACK (common parameters)

<b>ORGAN TYPE</b>	Specifies the type of organ tone generation to be simulated: Sine or Vintage.
<b>ROTARY SP SPEED</b>	Alternately switches between the slow and fast rotary speaker speeds when a rotary speaker effect is selected for the Organ Flutes (see “EFFECT/EQ” DSP TYPE parameter on page 93), and the Voice Effect DSP (page 93) is turned on (this parameter has the same effect as the Voice Effect VARIATION ON/OFF parameter).
<b>VIBRATO ON/OFF</b>	Alternately turns the vibrato effect for the Organ Flutes Voice ON or OFF.
<b>VIBRATO DEPTH</b>	Sets the Vibrato depth to one of three levels: 1 (low), 2 (mid), or 3 (high).

### FOOTAGE

<b>16' ← → 5 1/3'</b>	Switches the controllable footage (by using the [D] button), between 16' and 5 1/3'.
<b>16'-1'</b>	Determines the basic sound of the organ flutes. The longer the pipe, the lower the pitch of the sound. Hence, the 16' setting determines the lowest pitched component of the Voice, while the 1' setting determines the highest pitched component. The higher the value of the setting, the greater the volume of the corresponding footage. Mixing various volumes of the footages lets you create your own distinctive organ sounds.

### VOLUME/ATTACK

<b>VOL</b>	Adjusts the overall volume of the Organ Flutes. The longer the graphic bar, the greater the volume.
<b>RESP</b>	Affects both the attack and release (page 92) portion of the sound, increasing or decreasing the response time of the initial swell and release, based on the FOOTAGE controls. The higher the value, the slower the swell and release.
<b>VIBRATO SPEED</b>	Determines the speed of the vibrato effect controlled by the Vibrato On/Off and Vibrato Depth above.
<b>MODE</b>	The MODE control selects between two modes: FIRST and EACH. In the FIRST mode, attack is applied only to the first notes played and held simultaneously; while the first notes are held, any subsequently played notes have no attack applied. In the EACH mode, attack is applied equally to all notes.
<b>4', 2 2/3', 2'</b>	These determine the attack sound volume of the ORGAN FLUTE Voice. The 4', 2-2/3' and 2' controls increase or reduce the volume of attack sound at the corresponding footages. The longer the graphic bar, the greater the attack sound volume.
<b>LENG</b>	Affects the attack portion of the sound producing a longer or shorter decay immediately after the initial attack. The longer the graphic bar, the longer the decay.

#### Footage:

The term “footage” is a reference to the sound generation of traditional pipe organs, in which the sound is produced by pipes of different lengths (in feet).

## EFFECT/EQ

Same parameters as in the SOUND CREATOR "EFFECT/EQ" tab display explained on page 92.

### **Disabling automatic selection of Voice Sets (effects, etc.)**

Each Voice is linked to its related parameter settings that are indicated in the SOUND CREATOR displays, including effects and EQ. Usually these settings are automatically called up when a Voice is selected. However, you can also disable this feature by the operation in the relevant display as explained below.

For example, if you want to change the Voice yet keep the same Harmony effect, set the HARMONY/ECHO parameter to OFF (in the display explained below).

You can set these independently by keyboard part and parameter group.

#### **1 Call up the operation display.**

[FUNCTION] → [E] REGIST.SEQUENCE/FREEZE/VOICE SET → TAB [▶]  
VOICE SET

#### **2 Use the [A]/[B] buttons to select a keyboard part.**

#### **3 Use the [4▲▼]-[8▲▼] buttons to enable/disable automatic calling up of the settings (ON or OFF) independently for each parameter group.**

Refer to the separate Data List for a list of parameters contained in each parameter group.



## Reference to Quick Guide pages

### Playing “Mary Had a Little Lamb” with the Auto

Accompaniment Feature .....	page 44
Pattern Variation .....	page 46
Learning How to Play (Indicate) Chords for Style Playback .....	page 48
Appropriate Panel Settings for the Selected Style (One Touch Setting) .....	page 49

## Style Characteristics

The Style type and its defining characteristics are indicated above the Preset Style name.

<b>Pro</b>	These Styles provide professional and exciting arrangements combined with perfect playability. The resulting accompaniment exactly follows the chords of the player. As a result, your chord changes and colorful harmonies are instantly transformed into lifelike musical accompaniment.
<b>Session</b>	These Styles provide even greater realism and authentic backing by mixing in original chord types and changes, as well as special riffs with chord changes, with the Main sections. These have been programmed to add “spice” and a professional touch to your performances of certain songs and in certain genres. Keep in mind, however, that the Styles may not necessarily be appropriate—or even harmonically correct—for all songs and for all chord playing. In some cases for example, playing a simple major triad for a country song may result in a “jazzy” seventh chord, or playing an on-bass chord may result in inappropriate or unexpected accompaniment.
<b>Pianist</b>	These special Styles provide piano-only accompaniment. Just by playing the proper chords with your left hand, you can automatically add complicated, professional-sounding arpeggios and bass/chord patterns.

## Selecting a Chord Fingering Type

Style playback can be controlled by the chords you play in the chord section of the keyboard. There are seven types of fingerings.

- 1 **Call up the operation display.**  
[FUNCTION] → [C] STYLE SETTING/SPLIT POINT/CHORD FINGERING → TAB [▶] CHORD FINGERING
- 2 **Press the [1 ▲ ▼]–[3 ▲ ▼] buttons to select a fingering.**

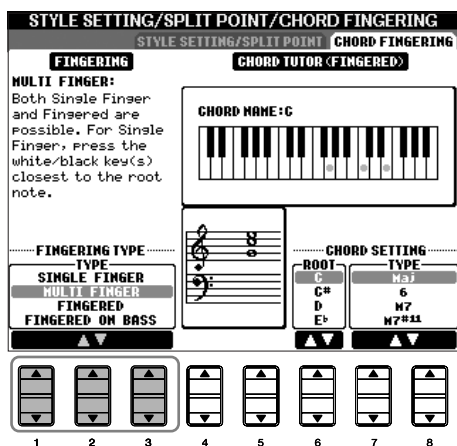





**AI:**  
Artificial Intelligence

**Starting the rhythm with Sync Start**

You can also start the rhythm simply by playing a key of the chord section of the keyboard, if Sync Start is enabled (turn on the [SYNC START] button).

The rhythm does not sound for the Pianist Styles (or other similar Styles). When you want to use any of these Styles, always make sure that ACMP ON/OFF is turned on.

<b>SINGLE FINGER</b>	<p>Makes it simple to produce orchestrated accompaniment using major, seventh, minor and minor-seventh chords by pressing a minimum number of keys on the Chord section of the keyboard. This type is available only for Style playback. The abbreviated chord fingerings described at right are used:</p>	 <p><b>C</b> For a major chord, press the root key only.</p>  <p><b>Cm</b> For a minor chord, simultaneously press the root key and a black key to its left.</p>  <p><b>C7</b> For a seventh chord, simultaneously press the root key and a white key to its left.</p>  <p><b>Cm7</b> For a minor-seventh chord, simultaneously press the root key a both a white and black key to its left</p>
<b>MULTI FINGER</b>	<p>Automatically detects Single Finger or Fingered chord fingerings, so you can use either type of fingering without having to switch fingering types.</p>	
<b>FINGERED</b>	<p>Lets you finger your own chords on the Chord section of the keyboard, while the CVP supplies appropriately orchestrated rhythm, bass, and chord accompaniment in the selected Style. The Fingered type recognizes the various chord types which are listed on the separate Data List booklet and can be looked up using the Chord Tutor function (page 48).</p>	
<b>FINGERED ON BASS</b>	<p>Accepts the same fingerings as the Fingered, but the lowest note played in the Chord section of the keyboard is used as the bass note, allowing you to play "on bass" chords (in the Fingered mode the root of the chord is always used as the bass note).</p>	
<b>FULL KEYBOARD</b>	<p>Detects chords in the entire key range. Chords are detected in a way similar to Fingered, even if you split the notes between your left and right hands—for example, playing a bass note with your left hand and a chord with your right, or by playing a chord with your left hand and a melody note with your right.</p>	
<b>AI FINGERED</b>	<p>Basically the same as Fingered, with the exception that less than three notes can be played to indicate the chords (based on the previously played chord, etc.).</p>	
<b>AI FULL KEYBOARD</b>	<p>When this advanced fingering type is engaged, the CVP will automatically create appropriate accompaniment while you play just about anything, anywhere on the keyboard using both hands. You don't have to worry about specifying the Style chords. Although the AI Full Keyboard type is designed to work with many songs, some arrangements may not be suitable for use with this feature. This type is similar to Full Keyboard, with the exception that less than three notes can be played to indicate the chords (based on the previously played chord, etc.). 9th, 11th and 13th chords cannot be played. This type is available only for Style playback.</p>	

## Playing Only the Rhythm Channels of a Style

Rhythm is one of the most important parts of a Style. Try to play the melody along with just the rhythm. You can sound different rhythms for each Style. Keep in mind, however, that not all Styles contain rhythm channels.

- 1 Select a Style (page 45).
- 2 Press the [ACMP ON/OFF] to turn Auto Accompaniment off.
- 3 Press the STYLE CONTROL [START/STOP] button to play back the rhythm channels.
- 4 Press the STYLE CONTROL [START/STOP] button to stop the rhythm.

### Turning channels of the Style on/off

A Style contains eight channels: RHY1 (Rhythm 1) – PHR2 (Phrase 2). You can add variations and change the feeling of a Style by selectively turning channels on/off as the Style plays.

- 1 Press the [CHANNEL ON/OFF] button to call up the CHANNEL ON/OFF display.

When the STYLE tab is not selected, press the [CHANNEL ON/OFF] button again.



- 2 Press the [1 ▼]–[8 ▼] buttons to turn the channels on or off.

To listen to only one instrument by itself, hold down the appropriate button for the channel to set the channel to SOLO. To cancel SOLO, simply press the appropriate channel button again.

### Playing the chords in free tempo (without Style playback)

You can have the accompaniment chords sound without playing back the Style, by setting [ACMP ON/OFF] to on, and [SYNC START] to off. For example, if MULTI FINGER is selected (page 98), you can perform with your own pace while sounding the chord by pressing the chord section of the keyboard with your one finger.

### Setting the fade in/out time

You can set the time of the fade in and fade out (page 47).

- 1 Call up the operation display.

[FUNCTION] → [I] UTILITY → TAB[◀] CONFIG 1 → [A] FADE IN/OUT/HOLD TIME

- 2 Set the parameters related to fade in/out by using the [3 ▲ ▼]–[5 ▲ ▼] buttons.

FADE IN TIME	Determines the time it takes for the volume to fade in, or go from minimum to maximum.
FADE OUT TIME	Determines the time it takes for the volume to fade out, or go from maximum to minimum.
FADE OUT HOLD TIME	Determines the time the volume is held at 0 following the fade out.

# Style Playback-related Settings

The CVP has a variety of Style playback functions, including Split Point and many others—which can be accessed in the display below.

- 1 **Call up the operation display.**  
[FUNCTION] → [C] STYLE SETTING/SPLIT POINT/CHORD FINGERING → TAB[◀] STYLE SETTING/SPLIT POINT
- 2 **Use the [F]–[H] buttons to set the Split Point (see below) and use the [1▲▼]–[5▲▼] buttons for each setting (page 101).**

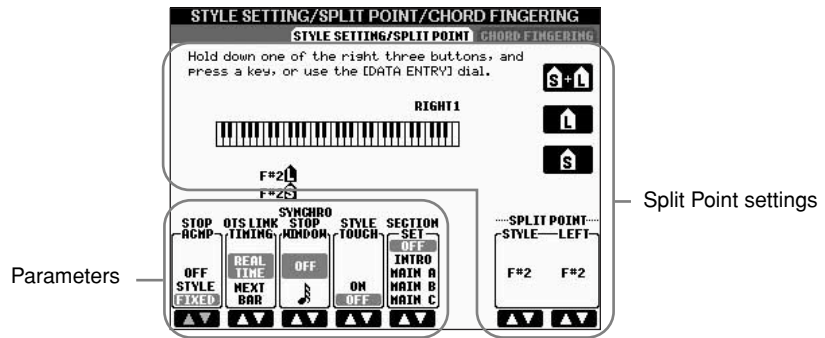

## • SPLIT POINT

These are the settings (there are two Split Points) that separate the different sections of the keyboard: the Chord section, the LEFT part section and the RIGHT 1 and 2 section. The two Split Point settings (below) are specified as note names.

- Split Point (S)—separates the Chord section for Style playback from the section(s) for playing Voices (RIGHT 1, 2 and LEFT)
- Split Point (L)—separates the two sections for playing Voices, LEFT and RIGHT 1–2.

These two settings can be set to the same note (as in the default) or two different notes as desired.

### Setting the Split Point (S) and the Split Point (L) to the same note

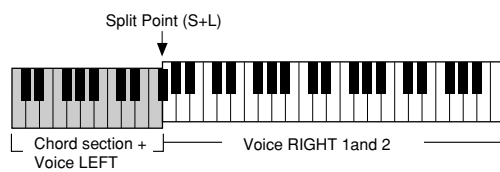

Press the [F] (S+L) button and rotate the [DATA ENTRY] dial.

### Setting the Split Point (S) and the Split Point (L) to different notes

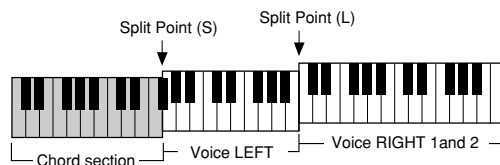

Press the [H] (S) button or the [G] (L) button and rotate the [DATA ENTRY] dial.

#### Specifying the Split Point by note name

Press the [7▲▼]/[8▲▼] (SPLIT POINT) button. You can specify the Split Point of the Voice and chord section of the keyboard by using STYLE in the display, and you can specify the Split Point of the left and right Voices by using LEFT.

Split Point (L) cannot be set lower than Split Point (S), and Split Point (S) cannot be set higher than Split Point (L).

• **Stop Accompaniment**

When [ACMP ON/OFF] is turned on and [SYNC START] is off, you can play chords in the chord section of the keyboard with the Style stopped, and still hear the accompaniment chord. In this condition—called “Stop Accompaniment”—any valid chord fingerings are recognized and the chord root/type are shown in the display.

From the display in page 100, you can determine whether the chord played in the chord section will sound or not in the Stop Accompaniment status.

- OFF**..... The chord played in the chord section will not sound.
- STYLE**..... The chord played in the chord section will sound via the Voices of the selected Style.
- FIXED**..... The chord played in the chord section will sound via the specified Voice, regardless of the selected Style.

• **OTS Link Timing**

This applies to the OTS Link function (page 50). This parameter determines the timing in which the One Touch Settings change with the MAIN VARIATION [A]–[D] change. (The [OTS LINK] button must be on.)

- Real Time**..... One Touch Setting is immediately called up when you press a MAIN VARIATION button.
- Next Bar**..... One Touch Setting is called up at the next measure, after you press a MAIN VARIATION button.

• **Synchro Stop Window**

This determines how long you can hold a chord before the Synchro Stop function is automatically cancelled. When the [SYNC STOP] button is turned on and this is set to a value other than “OFF,” this automatically cancels the Synchro Stop function if you hold a chord for longer than the time set here. This conveniently resets Style playback control to normal, letting you release the keys and still have the Style play.

• **Style Touch**

Turns touch response for the Style playback on/off. When this is set to “ON,” the Style volume changes in response to your playing strength in the chord section of the keyboard.

• **Section Set**

Determines the default section that is automatically called up when selecting different Styles (when Style playback is stopped). When set to “OFF” and Style playback is stopped, the active section is maintained even if the different Style is selected.

When any of the MAIN A–D sections is not included in the Style data, the nearest section is automatically selected. For example, when MAIN D is not contained in the selected Style, MAIN C will be called up.

**Data that is recorded when recording a Song**

Please note that both the Voice that is sounded and the chord data will be recorded when set to “STYLE,” and only the chord data will be recorded when set to “OFF” or “FIXED.”

# Editing the Volume and Tonal Balance of the Style (MIXING CONSOLE)

You can set various mixing-related parameters of the Style. (See “Adjustable items (parameters) in the MIXING CONSOLE display” on page 82.) Call up the “STYLE PART” display in step #3 of the Basic Procedure in “Editing the Volume Balance and Voice Combination (MIXING CONSOLE)” on page 80, and follow the instructions.

## Convenient Music Finder feature

Music Finder (page 50) is a convenient feature that calls up pre-programmed panel settings (for Voices, Styles, etc.) that match the song or type of music you want to play. The records of the Music Finder can be searched and edited.

## Searching the Records

You can search the records by specifying a song name or keyword, using the Search function of the Music Finder. You can also save your favorite records in the FAVORITE display.

- 1 Press the [MUSIC FINDER] button to call up the MUSIC FINDER display.
- 2 Press the TAB [◀] button to select the ALL tab. The ALL tab display contains the preset Records.
- 3 Press the [I] (SEARCH 1) button to call up the Search display.

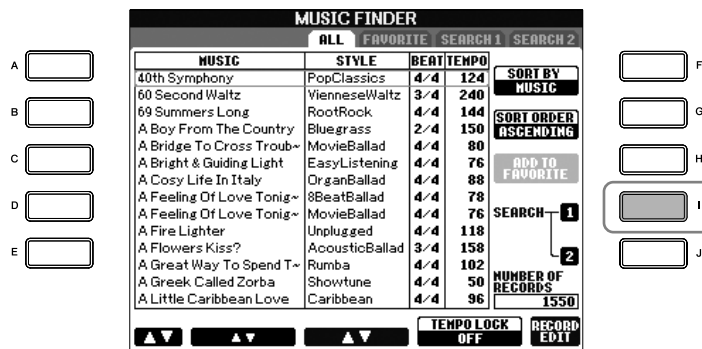

- 4 Enter the search criteria.

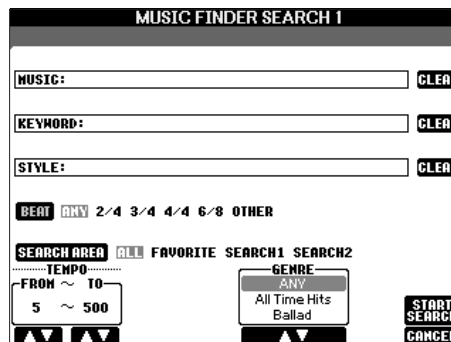

### Clear the search criteria

To clear the entered Music/Keyword/Style, press the [F]/[G]/[H] (CLEAR) button.

- **Search by song title or music genre (MUSIC) or keyword**
  - 1 Press the [A] (MUSIC)/[B](KEYWORD) button to call up the character entry display.
  - 2 Enter the song title or music genre, or the keyword (page 67).
- **Search by Style name**
  - 1 Press the [C] (STYLE) button to call up the Style selection display.
  - 2 Use the [A]–[J] buttons to select a Style.
  - 3 Press the [EXIT] button to return to the search display.

• **Adding other Search Criteria**

You can specify other search criteria in addition to the song name/keyword/Style name.

- BEAT** .....Select the beat (time signature) you want to use in your performance by pressing the [D] button. All beat settings are included in the search if you select ANY.
- SEARCH AREA** .....Select the pages to be included in the search by pressing the [E] button. (These correspond to the tabs at the top of the Music Finder display.)
- TEMPO**.....Set the range of the tempo you want to use in your performance by using the [1 ▲ ▼]/[2 ▲ ▼] (TEMPO) buttons.
- GENRE** .....Select the desired music genre by using the [5 ▲ ▼]/[6 ▲ ▼] (GENRE) buttons.

- 5 Press the [8 ▲] (START SEARCH) button to start the search.**  
 The Search 1 display appears, showing the results of the search. To cancel searching, press the [8 ▼] (CANCEL) button.

**Detailed Search**  
 When you want to search the records further based on the results of the above search or search other music genres, press the [J] (SEARCH 2) button in the Music Finder display. The search result is displayed in the SEARCH 2 display.

**Creating a Set of Favorite Records**

As convenient as the Search function is in plumbing the depths of the Music Finder records, you may want to create a “folder” of favorite records—so you can quickly call up those Styles and settings you use most often in your performance.

- 1 Select the desired record from the Music Finder display.

**Entering several different keywords**  
 You can search several different keywords simultaneously by inserting a separator (comma) between each.

- Press the [H] (ADD TO FAVORITE) button to add the selected record to the FAVORITE display.

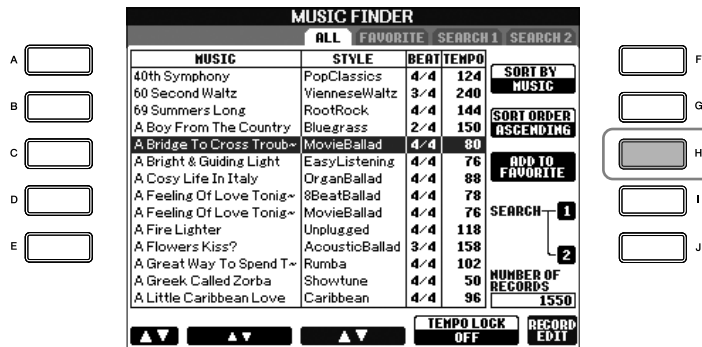

- Call up the FAVORITE display by using the TAB [◀][▶] buttons, and check to see if the record has been added.

### Deleting Records from the FAVORITE Display

- Select the record you want to delete from the FAVORITE display.
- Press the [H] (DELETE FROM FAVORITE) button.

### Editing Records

You can create a new record by editing the currently selected record. The newly created records are automatically saved in the internal memory.

- Select the desired record to be edited in the Music Finder display.
- Press the [8▲▼] (RECORD EDIT) button to call up the Edit display.



- Edit the record as desired.

#### ⚠ CAUTION

You can also change a preset record to create a new one. If you want to keep the original preset, make sure to change the name and register the edited record as a new record (see step 5, page 105).



- **Editing the song name/keyword/Style name**  
Input each item in the same way as done in the Search display (page 103).
- **Changing the Tempo**  
Press the [1 ▲ ▼] (TEMPO) button.
- **Memorizing the Section (Intro/Main/Ending)**  
Use the [2 ▲ ▼]/[4 ▲ ▼] buttons to select the section that will automatically be called up set when the record is selected. This is useful, for example, when you want to have a selected Style automatically be set up to start with an Intro section.
- **Editing the Genre**  
Select the desired genre by using the [5 ▲ ▼]/[6 ▲ ▼] (GENRE) buttons. When creating a new genre, press the [7 ▲ ▼] (GENRE NAME) button and input the genre name. (page 68)
- **Deleting the Currently Selected Record**  
Press the [I] (DELETE RECORD) button.
- **Canceling and Quitting the Edit functions**  
Press the [8 ▼] (CANCEL) button.

**4** To enter the edited record to the FAVORITE display, press the [E] (FAVORITE) button to turn on the FAVORITE.

**5** Enter the edits you've made to the record as described below.

- **Creating a new record**  
Press the [J] (NEW RECORD) button. The record is added to the ALL display. If you've entered the record to the FAVORITE display in step 4 above, the record is added to both the ALL display and the FAVORITE display.
- **Overwriting an existing record**  
Press the [8 ▲] (OK) button. If you set the record as a Favorite in step 4 above, the record is added to the FAVORITE display. When you edit the record in the FAVORITE display, the record is overwritten.

## Saving the Record

The Music Finder feature handles all the Records including the presets and additionally created records as a single file. Keep in mind that individual records (panel setups) cannot be handled as separate files.

- 1** Call up the Save display.  
[FUNCTION] → [I]UTILITY → TAB[▶] SYSTEM RESET → [I] MUSIC FINDER FILES
- 2** Press the TAB [◀][▶] buttons to select the location for saving (USER/CARD).
- 3** Press the [6 ▼] button to save the file (page 63).  
All records are saved together as a single file.

### Searching by Beat (time signature)

When searching records according to their beat (time signature), press the [D] (BEAT) button. Keep in mind that the Beat setting made here is only for the Music Finder search function; this does not affect the actual Beat setting of the Style itself.

The maximum number of records is 2500 (CVP-305/303)/1200 (CVP-301), including internal records.

**CAUTION**  
 Selecting "REPLACE" automatically deletes all your original records from internal memory and replaces them with the factory Music Finder data.

**Restoring the Music Finder Data**  
 You can restore the CVP's Music Finder to its original factory settings (page 69).

**Calling up Music Finder Records Saved to USER/CARD**

To call up the Music Finder records you've saved to USER/CARD, follow the instructions below.

- 1 Call up the operation display.  
 [FUNCTION] → [I] UTILITY → TAB [◀][▶] SYSTEM RESET
  - 2 Press the [I](MUSIC FINDER) button to call up the Music Finder USER/CARD tab display.
  - 3 Use the TAB [◀][▶] buttons to select USER/CARD.
  - 4 Press the [A]–[J] buttons to select the desired Music Finder file.
- When you select a file, a message appears prompting you to select one of the menu items below.

- **REPLACE**  
 All Music Finder records currently in the instrument are deleted and replaced with the records of the selected file.
  - **APPEND**  
 The records called up are added to the vacant record numbers.
- Select one of the settings above to call up the Music Finder file. Select "CANCEL" to abort this operation.

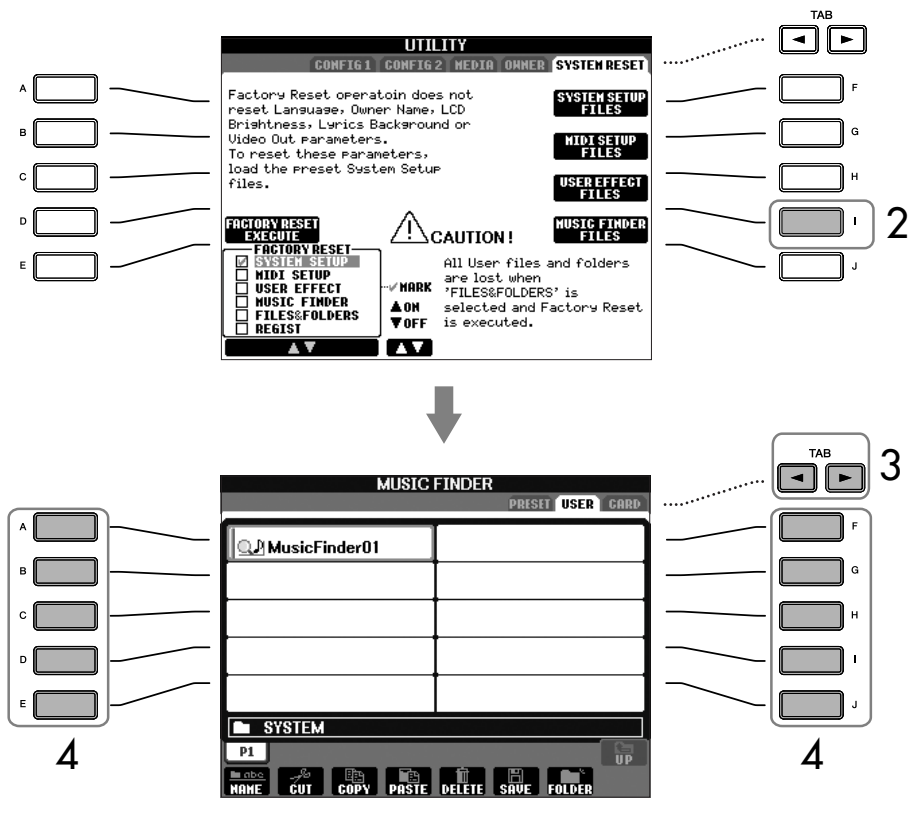

# Style Creator

You can create your own Styles—recording them by yourself or by combining the internal Style data. The created Styles can be edited.

## Style Structure

Styles are made up of fifteen different sections and each section has eight separate channels. With the Style Creator feature, you can create a Style by separately recording the channels, or by importing pattern data from other existing Styles.

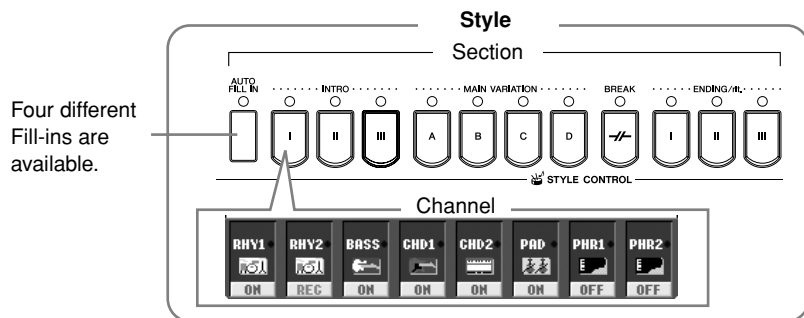

## Creating a Style

You can use one of the three different methods described below to create a Style. The created Styles can also be edited (page 113).

### ■ Realtime Recording ▶ See page 108

This method lets you record the Style by simply playing the instrument. You can select an internal Style that most closely matches your image of the Style you want to create and then re-record parts of the Style as desired, or you can create a new Style from scratch.

### ■ Step Recording ▶ See page 111

This method is like writing music notation on paper, since it allows you to enter each note or individually, and specify its length. This allows you to create a Style without having to play the parts on the instrument, since you can enter each event manually.

### ■ Style Assembly ▶ See page 112

This convenient feature lets you create composite Styles by combining various patterns from the internal preset Styles. For example, if you want to create your own original 8-beat Style, you could take rhythm patterns from the “Live8Beat” Style, use the bass pattern from “Cool8Beat” Style and import the chord patterns from the “8BeatModern” Style—combining the various elements to create one Style.

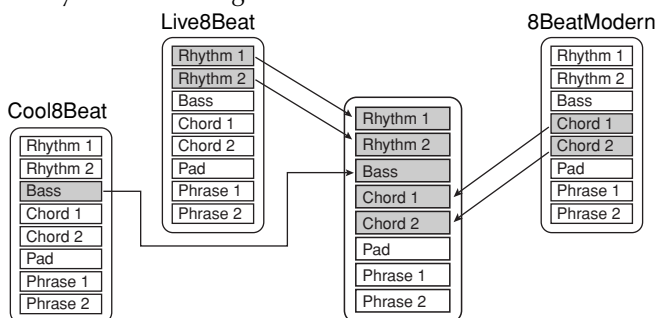

## Realtime Recording (BASIC)

Create a single Style by recording the individual channels one-by-one, using real-time recording.

### Realtime Recording Characteristics

- **Loop Recording**

Style playback repeats the rhythm patterns of several measures in a “loop,” and Style recording is also done using loops. For example, if you start recording with a two-measure main section, the two measures are repeatedly recorded. Notes that you record will play back from the next repetition (loop), letting you record while hearing previously recorded material.

- **Overdub Recording**

This method records new material to a channel already containing recorded data, without deleting the original data. In Style recording, the recorded data is not deleted, except when using functions such as Rhythm Clear (page 110) and Delete (page 109). For example, if you start recording with a two-measure MAIN section, the two measures are repeated many times. Notes that you record will play back from the next repetition, letting you overdub new material to the loop while hearing previously recorded material.

When creating a Style based on an existing internal Style, overdub recording is applied only to the rhythm channels. For all other channels (except rhythm), delete the original data before recording.

#### When using realtime recording based on the internal Styles:



Overdub recording possible.

Overdub recording not possible.  
Delete the data before recording.

- 1 Select the desired Style to serve as the basis for recording/editing (page 45).**

When creating a new Style from scratch, press the [C] (NEW STYLE) button from the display shown in step 5 below.

- 2 Press the [DIGITAL RECORDING] button.**

- 3 Press the [B] button to call up the Style Creator display.**

- 4 Use the TAB [◀][▶] buttons to select the BASIC tab.**

- 5 Specify the channel to be recorded by simultaneously holding down the [F] (REC CH) button and pressing the appropriate numbered button, [1 ▼]–[8 ▼].**

When recording channels BASS-PHR2 based on an internal Style, delete the original data before recording. Overdub recording is not possible on channels BASS-PHR2 (see above).

When the channel indication at the lower part of the display disappears, you can press the [F] (REC CH) button to re-display it.

To cancel the selection, press the appropriate numbered button [1 ▼]–[8 ▼] again.

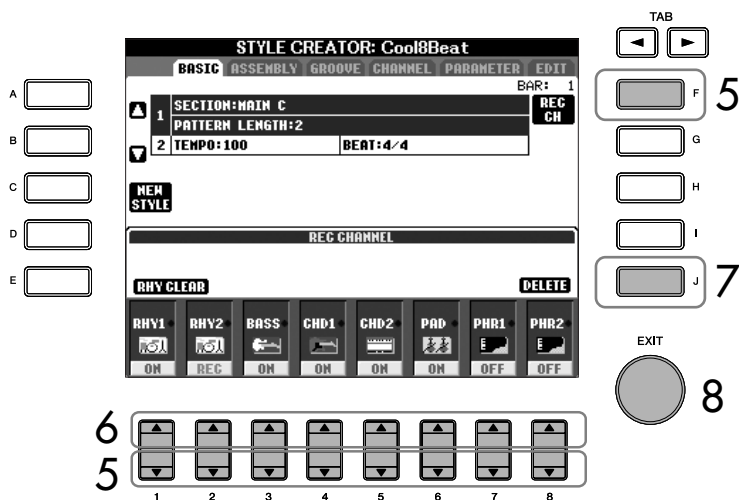

**6** Call up the Voice Selection display by using the [1 ▲]–[8 ▲] buttons and select the desired Voice for the corresponding recording channels.

Press the [EXIT] button to return to the previous display.

**7** To delete a channel, simultaneously hold down the [J] (DELETE) button and press the appropriate numbered button, [1 ▲]–[8 ▲].

You can cancel the deletion by pressing the same numbered button again, before releasing your finger from the [J] button.

**8** Call up the display for selecting sections, etc. by pressing the [EXIT] button.

**9** Use the [3 ▲ ▼]/[4 ▲ ▼] buttons to select the section (page 107) to be recorded.

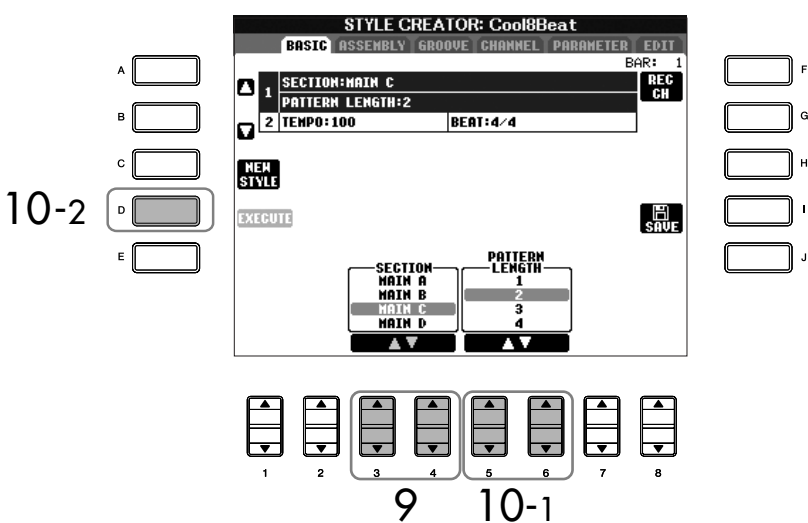

**Limits on the recordable Voices**

- **RHY1 channel:**  
Any except Organ Flute Voice
- **RHY2 channel:**  
Only drum/SFX kits
- **BASS–PHR2 channels:**  
Any except Organ Flute Voice and drum/SFX kits

**Muting specific channels during recording**

Turn off the desired channels by pressing the [1 ▼]–[8 ▼] buttons.

**Specifying sections from the panel buttons**

You can specify the sections to be recorded by using the Section buttons ([INTRO]/[MAIN]/[ENDING], etc) on the panel. Pressing one of the Section buttons calls up the SECTION display. Change the sections by using the [6 ▲ ▼]/[7 ▲ ▼] buttons and execute the selection by pressing the [8 ▲] button.

**Deleting the recorded rhythm channel (RHY 1, 2)**

To delete a specific instrument sound, simultaneously hold down the [E] (RHY CLEAR) button (from the display where the recorded channels are shown) and press the appropriate key.

**CAUTION**

The recorded Style will be lost if you change to another Style or you turn the power off without executing the Save operation (page 63).

Any desired chord or chord progression can be used for the INTRO and ENDING sections.

**Changing the Source Chord**

If you want to record the pattern with a Source Chord other than CM7, set the PLAY ROOT and PLAY CHORD parameters on the PARAMETER page (page 117) before recording.

**10 Use the [5 ▲ ▼]/[6 ▲ ▼] buttons to determine the length (number of measures) of the selected section.**

Actually enter the specified length for the selected section by pressing the [D] (EXECUTE) button.

**11 Start recording by pressing the Style Control [START/STOP] button.**

Playback of the specified section starts. Since the accompaniment pattern plays back repeatedly in a loop, you can record individual sounds one by one, listening to the previous sounds as they play. For information on recording to channels other than the rhythm channels (RHY1, 2), refer to the section "Rules when recording non-rhythm channels" (see below).

**12 To continue recording with another channel, simultaneously hold down the [F] (REC CH) button and press the appropriate [1 ▼]–[8 ▼] button to specify the channel, then play the keyboard.**

**13 Stop recording by pressing the Style Control [START/STOP] button.**

**14 Press the [I] (SAVE) button to call up the Style Selection display to save your data.**

Save the data in the Style Selection display (page 63).

**Rules when recording non-rhythm channels**

- Use only the CM7 scale tones when recording the BASS and PHRASE channels (i.e., C, D, E, G, A, and B).
- Use only the chord tones when recording the CHORD and PAD channels (i.e., C, E, G, and B).



C = Chord notes  
C, R = Recommended notes

Using the data recorded here, the auto accompaniment (Style playback) is appropriately converted depending on the chord changes you make during your performance. The chord which forms the basis for this note conversion is called the Source Chord, and is set by default to CM7 (as in the example illustration above). You can change the Source Chord (its root and type) from the PARAMETER display on page 117. Keep in mind that when you change the Source Chord from the default CM7 to another chord, the chord notes and recommended notes will also change. For details on chord notes and recommended notes, see page 118.

## Step Recording (EDIT)

The explanation here applies when selecting the EDIT tab in step 4 of “Realtime Recording” (page 108).

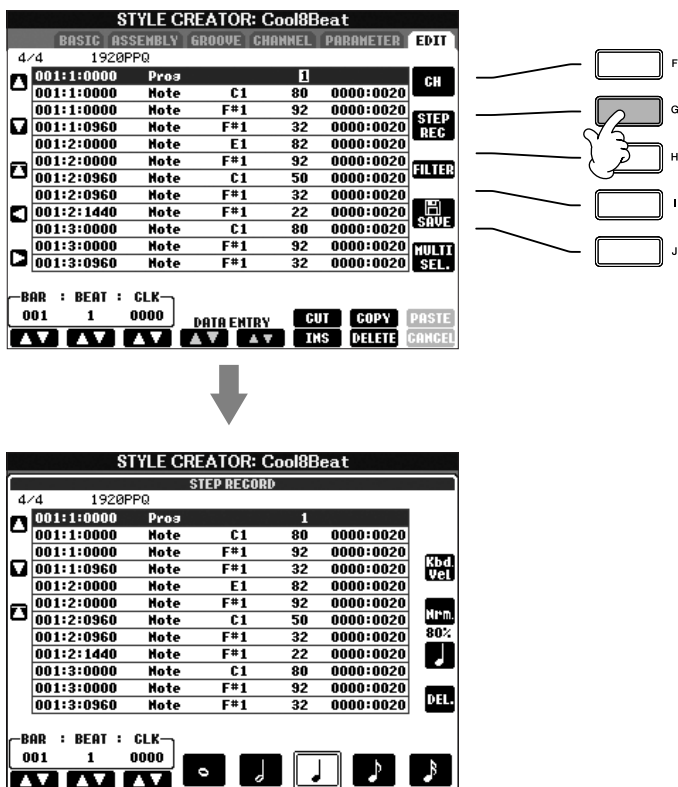

In the EDIT display, you can record notes with absolutely precise timing. This Step Recording procedure is essentially the same as that for Song Recording (page 111), with the exception of the points listed below:

- In the Song Creator, the End Mark position can be changed freely; in the Style Creator, it cannot be changed. This is because the length of the Style is automatically fixed, depending on the selected section. For example, if you create a Style based on a section of four measures length, the End Mark position is automatically set to the end of the fourth measure, and cannot be changed in the Step Recording display.
- Recording channels can be changed in the Song Creator 1–16 tab display; however, they cannot be changed in the Style Creator. Select the recording channel in the BASIC tab display.
- In the Style Creator, only the channel data and System Exclusive messages can be entered. You can switch between the two types of lists by pressing the [F] button. Chord and Lyrics data are not available.

## Style Assembly (ASSEMBLY)

Style Assembly allows you to create a single Style by mixing the various patterns (channels) from existing internal Styles.

### 1 Select the basic Style, then call up the display for Style Assembly.

The operation steps are the same as steps 1–4 in “Realtime recording” (page 108). In step 4, select the ASSEMBLY tab.

### 2 Select the desired section (Intro, Main, Ending, etc.) for your new Style.

Call up the SECTION display by pressing one of the Section buttons ([INTRO]/[MAIN]/[ENDING], etc.) on the panel. Change the section as desired by using the [6 ▲ ▼]/[7 ▲ ▼] buttons and execute the operation by pressing the [8 ▲] (OK) button.

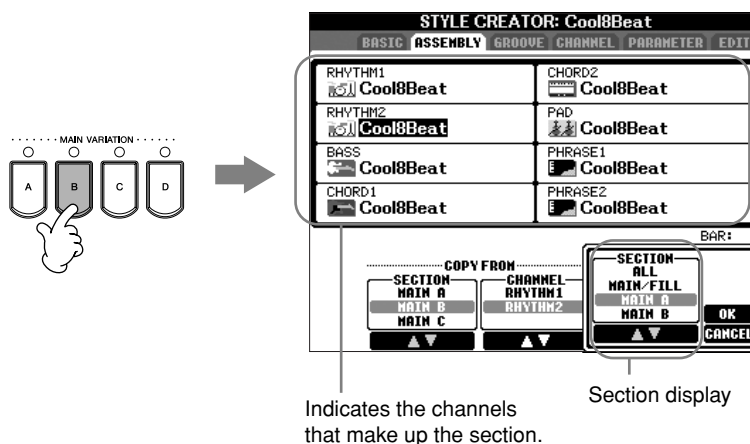

### 3 Select the channel for which you wish to replace the pattern by using the [A]–[D] and [F]–[I] buttons. Call up the Style Selection display by pressing the same button again. Select the Style containing the pattern you want to replace in the Style Selection display.

To return to the previous screen, press the [EXIT] button after selecting the Style.

### 4 Select the desired section of the newly imported Style (chosen in step 3 above) by using the [2 ▲ ▼]/[3 ▲ ▼] (SECTION) buttons.

### 5 Select the desired channel for the section (chosen in step 4 above) by using the [4 ▲ ▼]/[5 ▲ ▼] (CHANNEL) buttons.

### 6 Repeat steps 3–5 above to replace the patterns of other channels.

### 7 Press the [J] (SAVE) button to call up the Style Selection display, and save your data from the display (page 63).

**CAUTION**

The recorded Style will be lost if you change to another Style or you turn the power off without executing the Save operation (page 63).



**Playing the Style During Style Assembly**

While you are assembling a Style, you can play back the Style and select the method of playback. Use the [6 ▲ ▼]/[7 ▲ ▼] (PLAY TYPE) buttons in the Style Assembly display to select the playback method.

- **SOLO**

Mutes all but the selected channel in the ASSEMBLY tab display. Any channels set to ON in the RECORD display on the BASIC page are played back simultaneously.

- **ON**

Plays back the selected channel in the ASSEMBLY tab display. Any channels set to something other than OFF in the RECORD display on the BASIC page are played back simultaneously.

- **OFF**

Mutes the selected channel in the ASSEMBLY tab display.

## Editing the Created Style

You can edit the Style you've created by using Realtime recording, Step recording and/or Style Assembly.

### Basic Operation for Editing Styles

- 1 Select a Style to be edited.
- 2 Press the [DIGITAL RECORDING] button.
- 3 Call up the Style Creator/Edit display by pressing the [B] button.
- 4 Press the TAB[◀][▶] button to select a tab.
  - **Changing the Rhythmic Feel (GROOVE) ▶ See page 114**  
These versatile features give you a wide variety of tools for changing the rhythmic feel of your created Style.
  - **Editing Data for each Channel (CHANNEL) ▶ See page 116**  
The editing features let you delete data as desired and apply quantize settings for each channel in the Style data.
  - **Making Style File Format Settings (PARAMETER) ▶ See page 117**  
For playback of your created Style, you can decide how notes will be converted and sounded for the accompaniment when changing chords in the chord section of the keyboard.
- 5 Edit the selected Style.

## Changing the Rhythmic Feel (GROOVE)

The explanation here applies when you select the GROOVE tab in step 4 of “Basic Operation for Editing Styles” (page 113).

- 1 Press the [A]/[B] button to select the edit menu (page 115).

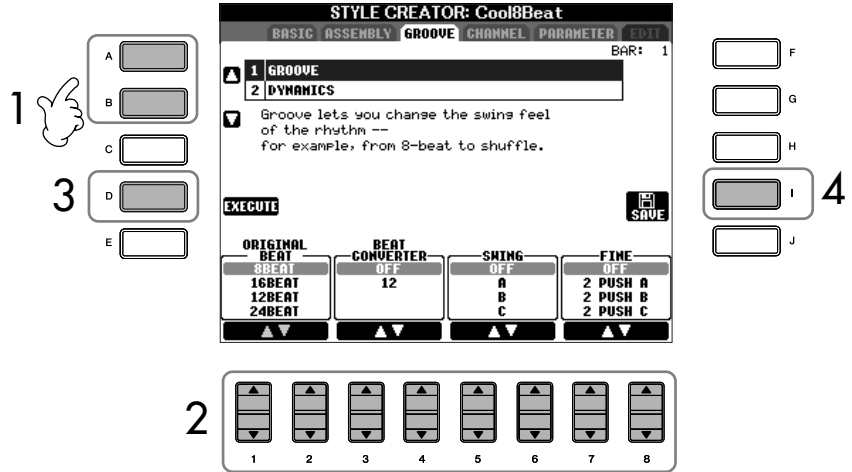

- 2 Use the [1 ▲ ▼]-[8 ▲ ▼] buttons to edit the data.  
For details on editable parameters, see page 115.

- 3 Press the [D] (EXECUTE) button to actually enter the edits for each display.  
After the operation is completed, you can execute the edition and this button changes to “UNDO,” letting you restore the original data if you’re not satisfied with the Groove or Dynamics results. The Undo function only has one level; only the previous operation can be undone.

- 4 Press the [I] (SAVE) button to call up the Style Selection display to save your data.  
Save the data in the Style Selection display (page 63).

**CAUTION**

The edited Style will be lost if you change to another Style or you turn the power off without executing the Save operation (page 63).

## ■ GROOVE

This lets you add swing to the music or change the “feel” of the beat by making subtle shifts in the timing (clock) of the Style. The Groove settings are applied to all channels of the selected Style.

<b>ORIGINAL BEAT</b>	Specifies the beats to which Groove timing is to be applied. In other words, if “8 Beat” is selected, Groove timing is applied to the 8th notes; if “12 Beat” is selected, Groove timing is applied to 8th-note triplets.
<b>BEAT CONVERTER</b>	Actually changes the timing of the beats (specified in the ORIGINAL BEAT parameter above) to the selected value. For example, when ORIGINAL BEAT is set to “8 Beat” and BEAT CONVERTER is set to “12,” all 8th notes in the section are shifted to 8th-note triplet timing. The “16A” and “16B” Beat Converter which appear when ORIGINAL BEAT is set to “12 Beat” are variations on a basic 16th-note setting.
<b>SWING</b>	Produces a “swing” feel by shifting the timing of the back beats, depending on the ORIGINAL BEAT parameter above. For example, if the specified ORIGINAL BEAT value is “8 Beat,” the Swing parameter will selectively delay the 2nd, 4th, 6th, and 8th beats of each measure to create a swing feel. The settings “A” through “E” produce different degrees of swing, with “A” being the most subtle and “E” being the most pronounced.
<b>FINE</b>	Selects a variety of Groove “templates” to be applied to the selected section. The “PUSH” settings cause certain beats to be played early, while “HEAVY” settings delay the timing of certain beats. The numbered settings (2, 3, 4, 5) determine which beats are to be affected. All beats up to the specified beat—but not including the first beat—will be played early or delayed (for example, the 2nd and 3rd beats, if “3” is selected). In all cases, “A” types produce minimum effect, “B” types produce medium effect, and “C” types produce maximum effect.

## ■ DYNAMICS

This changes the velocity/volume (or accent) of certain notes in the Style playback. The Dynamics settings are applied to each channel or all channels of the selected Style.

<b>CHANNEL</b>	Selects the desired channel (part) to which Dynamics is to be applied.
<b>ACCENT TYPE</b>	Determines the type of accent applied—in other words, which notes in the part(s) are emphasized with the Dynamics settings.
<b>STRENGTH</b>	Determines how strongly the selected Accent Type (above) will be applied. The higher the value, the stronger the effect.
<b>EXPAND/COMP.</b>	Expands or compresses the range of velocity values. Values higher than 100% expand the dynamic range, while values lower than 100% compress it.
<b>BOOST/CUT</b>	Boosts or cuts all velocity values in the selected section/channel. Values above 100% boost the overall velocity, while values below 100% reduce it.

## Editing Data for Each Channel (CHANNEL)

The explanation here applies when you select the CHANNEL tab in step 4 of “Basic Operation for Editing Styles” (page 113).

- 1 Press the [A]/[B] button to select the edit menu (see below).

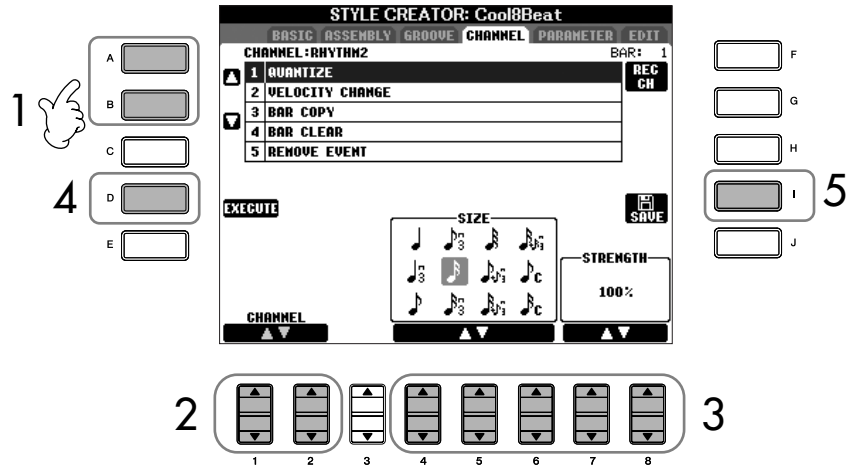

- 2 Use the [1 ▲ ▼]/[2 ▲ ▼] (CHANNEL) buttons to select the channel to be edited.

The selected channel is shown at the upper left of the display.

- 3 Use the [4 ▲ ▼]-[8 ▲ ▼] buttons to edit the data.

For details on editable parameters, see below.

- 4 Press the [D] (EXECUTE) button to actually enter the edits for each display.

After the operation is completed, you can execute the edition and this button changes to [UNDO], letting you restore the original data if you're not satisfied with the results of the edit. The Undo function only has one level; only the previous operation can be undone.

- 5 Press the [I] (SAVE) button to call up the Style Selection display to save your data.

Save the data in the Style Selection display (page 63).

**CAUTION**

The edited Style will be lost if you change to another Style or you turn the power off without executing the save operation (page 63).

<b>QUANTIZE</b>	Same as in the Song Creator (page 151), with the exception of the two additional available parameters below. ♪ <sup>c</sup> Eighth notes with swing ♪ <sup>c</sup> Sixteenth notes with swing
<b>VELOCITY CHANGE</b>	Boosts or cuts the velocity of all notes in the specified channel, according to the percentage specified here.
<b>BAR COPY</b>	This function allows data to be copied from one measure or group of measures to another location within the specified channel. SOURCE specifies the first (TOP) and last (LAST) measures in the region to be copied. DEST specifies the first measure of the destination location, to which the data is to be copied.
<b>BAR CLEAR</b>	This function clears all data from the specified range of measures within the selected channel.
<b>REMOVE EVENT</b>	This function lets you remove specific events from the selected channel.

# Making Style File Format Settings (PARAMETER) Special Parameter Settings Based on Style File Format

**Source Pattern**  
SOURCE ROOT  
(Chord Root setting of a Source Pattern)  
SOURCE CHORD  
(Chord Type setting of a Source Pattern)

↓ Chord change via the chord section of the keyboard.

**Note Transposition**  
NTR  
(Note Transposition Rule applied to the Chord Root change)  
NTT  
(Note Transposition Table applied to the Chord Type change)



**Other Settings**  
HIGH KEY  
(Upper limit of the octaves of the note transposing caused by the Chord Root change)  
NOTE LIMIT (Note range in which the note is sounded)  
RTR  
(Retrigger Rules that determine how notes held through chord changes will be handled)

↓ Output

The Style File Format (SFF) combines all of Yamaha's auto accompaniment (Style playback) know-how into a single unified format. By using the Style Creator, you can take advantage of the power of the SFF format and freely create your own Styles.  
The chart shown at left indicates the process by which the Style is played back. (This does not apply to the rhythm track.) These parameters can be set via the Style Creator feature.

- **Source Pattern**  
There are a variety of possibilities for Style playback notes, depending on the particular root note and chord type that are selected. The Style data is appropriately converted depending on the chord changes you make during your performance. This basic Style data that you create with the Style Creator is referred to as the "Source Pattern."
- **Note Transposition**  
This parameter group features two parameters that determine how the notes of the Source Pattern are to be converted in response to chord changes.
- **Other Settings**  
Using the parameters of this group, you can fine-tune how Style playback responds to the chords you play. For example, the Note Limit parameter allows you to have the Voices of the Style sound as realistic as possible by shifting the pitch to an authentic range—ensuring that no notes sound outside the natural range of the actual instrument (e.g., very low notes of a piccolo sound).

Editing of Style File Format data is related only to note conversion. Editing the rhythm channels has no effect.

The explanation here applies when you select the PARAMETER tab in step 4 of "Basic Operation for Editing Styles" (page 113).

1 Press the [A]/[B] button to select the edit menu (page 118).

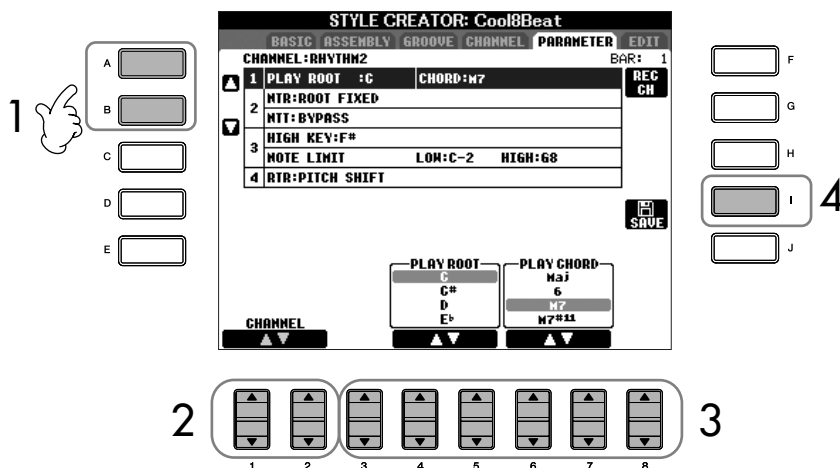

**⚠ CAUTION**

The edited Style will be lost if you change to another Style or you turn the power off without executing the Save operation (page 63).

**Auditioning Your Style with a Specific Chord**

Normally in the Style Creator, you can hear your original Style-in-process with the Source Pattern. However, there is a way to hear it played by a specific chord and root. To do this, set NTR to "Root Fixed," NTT to "Bypass," and NTT BASS to "OFF" then change the newly displayed "Play Root" and "Play Chord" parameters to the desired settings.

- 2 Use the [1 ▲ ▼]/[2 ▲ ▼] (CHANNEL) buttons to select the channel to be edited.  
The selected channel is shown at the upper left of the display.
- 3 Use the [3 ▲ ▼]-[8 ▲ ▼] buttons to edit the data.  
For details on editable parameters, see below.
- 4 Press the [I] (SAVE) button to call up the Style Selection display to save your data.  
Save the data in the Style Selection display (page 63).

**■ SOURCE ROOT/CHORD**

These settings determine the original key of the source pattern (i.e., the key used when recording the pattern). The default setting of CM7 (with a Source Root of "C" and a Source Type of "M7"), is automatically selected whenever the preset data is deleted prior to recording a new Style, regardless of the Source Root and Chord included in the preset data. When you change Source Root/Chord from the default CM7 to another chord, the chord notes and recommended notes will also change, depending on the newly selected chord type.

**When the Source Root is C:**

C = Chord notes      C, R = Recommended notes

**■ NTR (Note Transposition Rule)**

This determines the relative position of the root note in the chord, when converted from the Source Pattern in response to chord changes.

<p><b>ROOT TRANS (Root Transpose)</b></p>	<p>When the root note is transposed, the pitch relationship between notes is maintained. For example, the notes C3, E3 and G3 in the key of C become F3, A3 and C4 when they are transposed to F. Use this setting for channels that contain melody lines.</p>	<p>When playing a C major chord.      When playing an F major chord.</p>
<p><b>ROOT FIXED</b></p>	<p>The note is kept as close as possible to the previous note range. For example, the notes C3, E3 and G3 in the key of C become C3, F3 and A3 when they are transposed to F. Use this setting for channels that contain chord parts.</p>	<p>When playing a C major chord.      When playing an F major chord.</p>

## ■ NTT (Note Transposition Table)

This sets the note transposition table for the source pattern.

<b>BYPASS</b>	When NTR is set to ROOT FIXED, the transposition table used does not do any note conversion. When NTR is set to ROOT TRANS, the table used only converts the root note.
<b>MELODY</b>	Suitable for melody line transposition. Use this for melody channels such as Phrase 1 and Phrase 2.
<b>CHORD</b>	Suitable for chord transposition. Use this for the Chord 1 and Chord 2 channels, especially when they contain piano or guitar-like chordal parts.
<b>MELODIC MINOR</b>	When the played chord changes from a major to a minor chord, this table lowers the third interval in the scale by a semitone. When the chord changes from a minor to a major chord, the minor third interval is raised by a semitone. Other notes are not changed. Use this for melody channels of Sections which respond only to major/minor chords, such as Intros and Endings.
<b>MELODIC MINOR 5th</b>	In addition to the Melodic Minor transposition above, augmented and diminished chords affect the 5th note of the Source Pattern.
<b>HARMONIC MINOR</b>	When the played chord changes from a major to a minor chord, this table lowers the third and sixth intervals in the scale by a semitone. When the chord changes from a minor to a major chord, the minor third and flatted sixth intervals are raised by a semitone. Other notes are not changed. Use this for chord channels of Sections which respond only to major/minor chords, such as Intros and Endings.
<b>HARMONIC MINOR 5th</b>	In addition to the Harmonic Minor transposition above, augmented and diminished chords affect the 5th note of the Source pattern.
<b>NATURAL MINOR</b>	When the played chord changes from a major to a minor chord, this table lowers the third, sixth and seventh intervals in the scale by a semitone. When the chord changes from a minor to a major chord, the minor third, flatted sixth and flatted seventh intervals are raised by a semitone. Other notes are not changed. Use this for chord channels of Sections which respond only to a Major/minor chord such as Intros and Endings.
<b>NATURAL MINOR 5th</b>	In addition to the Natural Minor transposition above, augmented and diminished chords affect the 5th note of the Source pattern.
<b>DORIAN</b>	When the played chord changes from a major to a minor chord, this table lowers the third and seventh intervals in the scale by a semitone. When the chord changes from a minor to a major chord, the minor third and flatted seventh intervals are raised by a semitone. Other notes are not changed. Use this for chord channels of Sections which respond only to a Major/minor chord such as Intros and Endings.
<b>DORIAN 5th</b>	In addition to the Dorian transposition above, augmented and diminished chords affect the 5th note of the Source pattern.

## ■ NTT BASS ON/OFF

The channels for which this is set to ON will be played back by the bass root note, when the on-bass chord is recognized by the instrument.

■ **HIGH KEY**

This sets the highest key (upper octave limit) of the note transposition for the chord root change. Any notes calculated to be higher than the highest key are transposed down to the next lowest octave. This setting is available only when the NTR parameter (page 118) is set to “Root Trans.”

**Example—When the highest key is F.**

Root changes → CM      C#M      . . .      FM      F#M      . . .

Notes played → C3-E3-G3      C#3-F3-G#3      F3-A3-C4      F#2-A#2-C#3

■ **NOTE LIMIT**

This sets the note range (highest and lowest notes) for voices recorded to the style channels. By judicious setting of this range, you can ensure that the voices sound as realistic as possible—in other words, that no notes outside the natural range are sounded (e.g., high bass sounds or low piccolo sounds). The actual notes that sound are automatically shifted to the set range.

**Example—When the lowest note is C3 and the highest is D4.**

Root changes → CM      C#M      . . .      FM      . . .

Notes played → E3-G3-C4      F3-G#3-C#4      F3-A3-C4

■ **RTR (Retrigger Rule)**

These settings determine whether notes stop sounding or not and how they change pitch in response to chord changes.

<b>STOP</b>	The notes stop sounding.
<b>PITCH SHIFT</b>	The pitch of the note will bend without a new attack to match the type of the new chord.
<b>PITCH SHIFT TO ROOT</b>	The pitch of the note will bend without a new attack to match the root of the new chord.
<b>RETRIGGER</b>	The note is retriggered with a new attack at a new pitch corresponding to the next chord.
<b>RETRIGGER TO ROOT</b>	The note is retriggered with a new attack at the root note of the next chord. However, the octave of the new note remains the same.



The registration Memory function allows you to save (or “register”) virtually all panel settings to a Registration Memory button, and then instantly recall your custom panel settings by pressing a single button. The registered settings for eight Registration Memory buttons should be saved as a single Bank (file).

## Registering and Saving Custom Panel Setups

### Registering Custom Panel Setups

- 1 Set up the panel controls (such as Voice, Style, effects, and so on) as desired.  
Refer to the separate Data List for a list of parameters that can be registered with the Registration Memory function.
- 2 Press the REGISTRATION MEMORY [MEMORY] button. The display for selecting the items to be registered appears.  
Only the items selected here will be registered.

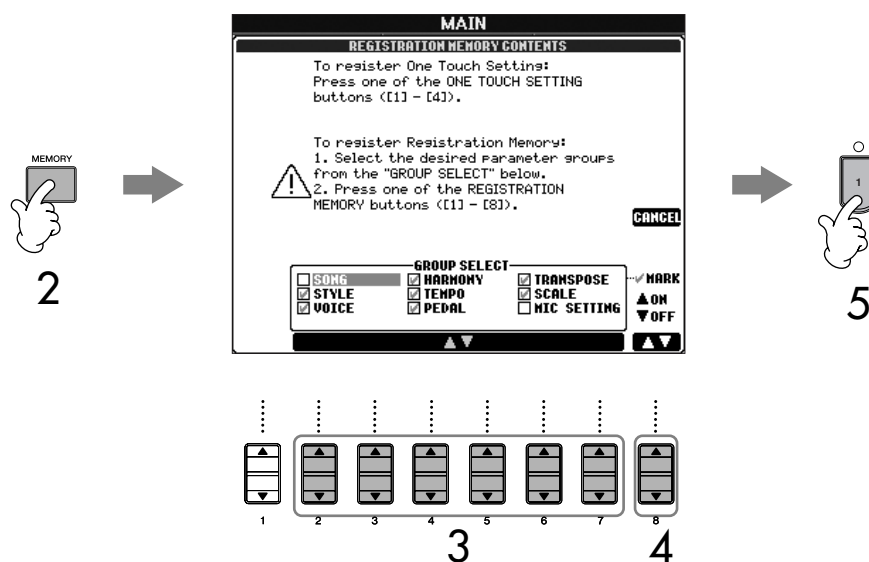

- 3 Press the [2▲▼]-[7▲▼] buttons to select items.  
To cancel the operation, press the [I] (CANCEL) button.
- 4 Enter or remove the checkmark in the box of the item to determine whether the item should be registered or not, by pressing the [8▲▼] button.
- 5 Press one of the REGISTRATION MEMORY [1]-[8] buttons to register your settings.  
It is recommended that you select a button whose lamp is not lit in red or green. Buttons that are lit in red or green, already contain the panel setup data. Any panel setup previously registered to the selected REGISTRATION MEMORY button (lamp lights in green or red) will be erased and replaced by the new settings.
- 6 Register various panel setups to other buttons by repeating steps #1-#5.

When recalling registration setups, you can also select the items to be recalled or not, even if you selected all items when registering (page 123).

**About the lamp status:**  
 Off..... no data registered  
 On (green)...data registered, but not currently selected  
 On (red).....data registered, and currently selected

**Deleting an unneeded panel setup**  
 See page 123.

**Deleting all eight current panel setups**  
 To delete all the eight current panel setups, turn the [POWER] button ON while holding the B6 key (right-most B key on the keyboard).

## Saving the Registered Panel Setups

You can save all the eight registered panel setups as a single Registration Memory Bank file.

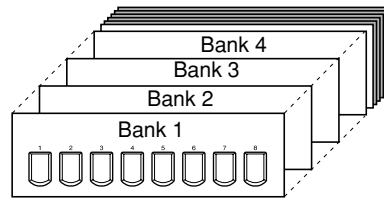

- 1 Press the REGISTRATION MEMORY [REGIST. BANK] button to call up the REGISTRATION BANK Selection Display.
- 2 Press the [6 ▼] button to save the Bank file (page 63).

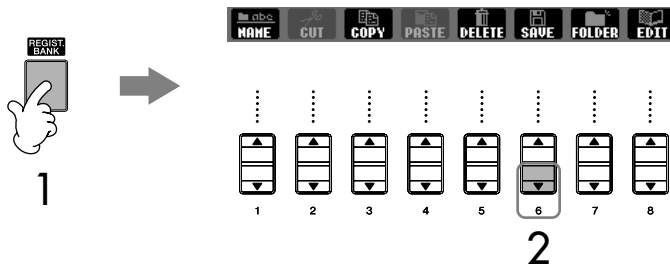

### Registration Memory data compatibility

In general, Registration Memory data (Bank files) is compatible among the models CVP-309/307/305/303/301. However, the data may not be perfectly compatible, depending on the specifications of each model.

## Recalling the Registered Panel Setups

- 1 Press the REGISTRATION MEMORY [REGIST. BANK] button to call up the REGISTRATION BANK Selection Display.



- 2 Press one of the [A]–[J] buttons to select a bank.

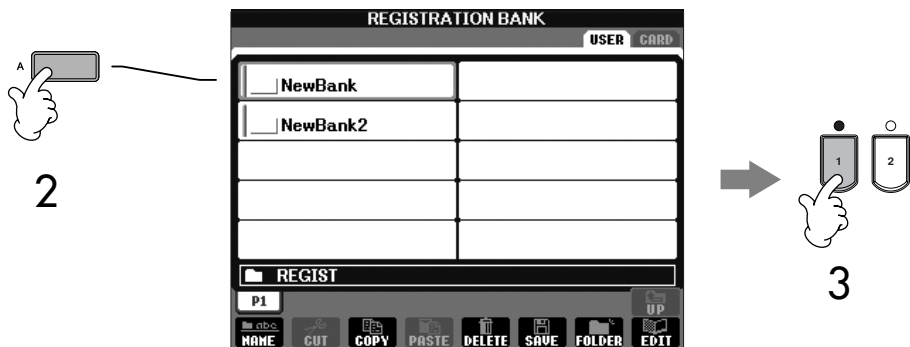

- 3 Press one of the green-lit numbered buttons ([1]–[8]) in the Registration Memory section.

### Parameter Lock

You can “lock” specific parameters (e.g., effect, split point, etc.) to make them selectable only via the panel controls—in other words, instead of via Registration Memory, One Touch Setting, Music Finder, Song or incoming MIDI data, etc. Call up the Parameter Lock display ([FUNCTION] → [I] UTILITY → TAB [◀] CONFIG 1 → [B] 3 PARAMETER LOCK). Select the desired parameter by using the [1 ▲ ▼]–[7 ▲ ▼] buttons, then lock it with the [8 ▲] (OK) button.

### About recalling setups from a SmartMedia card or floppy disk

When recalling the setups including Song/Style file selection from a SmartMedia card or floppy disk, make sure that the appropriate SmartMedia card or floppy disk including the registered Song/Style is inserted into the card slot or floppy disk drive.

## Deleting an Unneeded Panel Setup/Naming a Panel Setup

The panel setups can be deleted or named individually as desired.

- 1 Press the REGISTRATION MEMORY [REGIST. BANK] button to call up the REGISTRATION BANK Selection Display.
- 2 Press one of the [A]–[J] buttons to select a bank to be edited.
- 3 Press the [8 ▼] (EDIT) button to call up the REGISTRATION EDIT Display.
- 4 Edit the panel setups.
  - **Deleting a panel setup**  
Press the [5 ▼] button to delete a panel setup (page 65).
  - **Renaming a panel setup**  
Press the [1 ▼] button to rename a panel setup (page 66).

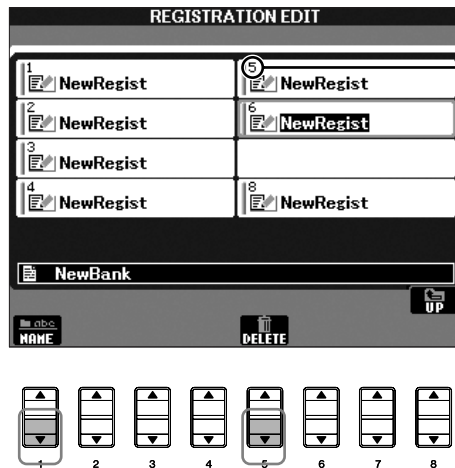

The number above the file name corresponds to the REGISTRATION MEMORY [1]–[8] buttons.

- 5 Press the [8 ▲] (UP) button to return to the REGISTRATION BANK Selection display.

## Disabling Recall of Specific Items (Freeze Function)

Registration Memory lets you recall all the panel setups you made with a single button press. However, there may be times that you want certain items to remain the same, even when switching Registration Memory setups. For example, you may want to switch Voices or effect settings while keeping the same accompaniment Style. This is where the Freeze function comes in handy. It lets you maintain the settings of certain items and leave them unchanged, even when selecting other Registration Memory buttons.

- 1 **Call up the operation display.**  
[FUNCTION] → [E] REGIST SEQUENCE/FREEZE/VOICE SET → TAB [◀]/[▶] FREEZE

**CAUTION**

Settings in the REGISTRATION FREEZE display are automatically saved to the instrument when you exit from this display. However, if you turn the power off without exiting from this display, the settings will be lost.

- 2 Press the [2▲▼]–[7▲▼] buttons to select items.
- 3 Enter checkmarks for the items to be “Frozen” (i.e., to remain unchanged), by pressing the [8▲▼] button.
- 4 Press the [EXIT] button to exit from the operation display.
- 5 Press the [FREEZE] button on the panel to turn the Freeze function on.

## Calling Up Registration Memory Numbers in Order—Registration Sequence

As convenient as the Registration Memory buttons are, there may be times during a performance when you want to quickly switch between settings—without having to take your hands from the keyboard. The convenient Registration Sequence function lets you call up the eight setups in any order you specify, by simply using the TAB [◀]/[▶] buttons or the pedal as you play.

- 1 Select the desired Registration Memory bank to program a sequence (page 122).
- 2 Call up the operation display.  
[FUNCTION] → [E] REGIST SEQUENCE/FREEZE/VOICE SET → TAB [◀]/[▶] REGISTRATION SEQUENCE

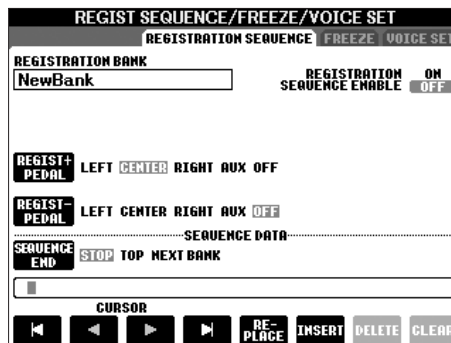

- 3 If you intend to use a pedal to switch Registration Memory settings, specify here how the pedal will be used—to advance or to reverse through the sequence.  
Use the [C] button to select the pedal for advancing through the sequence.  
Use the [D] button to select the pedal for reversing through the sequence.
- 4 Use the [E] button to determine how Registration Sequence behaves when reaching the end of the sequence (SEQUENCE END).  
STOP .....Pressing the TAB [▶] button or the “advance” pedal has no effect. The sequence is “stopped.”  
TOP .....The sequence starts again at the beginning.  
NEXT BANK.....The sequence automatically moves to the beginning of the next Registration Memory Bank in the same folder.
- 5 Program the Sequence order.  
The numbers shown at the lower part of the display correspond to the REGISTRATION MEMORY [1]–[8] buttons on the panel.  
Program the Sequence order from left to right.

Press one of the REGISTRATION MEMORY [1]–[8] button on the panel, then press the [6 ▲ ▼] (INSERT) button to input the number.

- **Replacing the number**  
Press the [5 ▲ ▼] (REPLACE) button to replace the number at the cursor position with the currently selected Registration Memory number.
- **Deleting the number**  
Press the [7 ▲ ▼] (DELETE) button to delete the number at the cursor position.
- **Deleting all numbers**  
Press the [8 ▲ ▼] (CLEAR) button to delete all numbers in the sequence.

**6** Press the [F] button to turn the Registration Sequence function on.

**7** Press the [EXIT] button to return to the Main display and confirm whether the Registration Memory numbers are called up according to the sequence programmed above.

- Use the TAB [▶] button to call up the Registration Memory numbers in the order of the sequence, or use the TAB [◀] button to call them up in reverse order. The TAB [◀] [▶] buttons can only be used for Registration Sequence when the Main display is called up.
- When pedal operation has been set in step 3, you can use a pedal to select the Registration Memory numbers in order. The pedal can be used for Registration Sequence no matter which display is called up (except for the display in step 3 above).



The Registration Sequence is indicated at the top right of the Main display, letting you confirm the currently selected number.

## Saving the Registration Sequence Settings

The settings for the Sequence order and how Registration Sequence behaves when reaching the end of the sequence (SEQUENCE END) are included as part of the Registration Memory Bank file. To store your newly programmed Registration Sequence, save the current Registration Memory Bank file.

- 1** Press the REGISTRATION MEMORY [REGIST. BANK] button to call up the REGISTRATION BANK Selection display.
- 2** Press the [6 ▼] button to save the Bank file (page 63).

### ⚠ CAUTION

Settings in the REGISTRATION SEQUENCE display are automatically saved to the instrument when you exit from this display. However, if you turn the power off without exiting from this display, the settings will be lost.

### Returning to the first Sequence in one action

In the Main display, press the TAB [◀] and [▶] buttons simultaneously. This cancels the currently selected Sequence number (the box indicator at the top right goes out). The first Sequence will be selected by pressing one of the TAB [◀]/[▶] buttons or by pressing the pedal.

### ⚠ CAUTION

Keep in mind that all Registration Sequence data is lost when changing Registration Memory Banks, unless you've saved it with the Registration Memory Bank file.

## Reference to Quick Guide Pages

<b>Practicing with the Preset Songs</b> .....	<b>page 34</b>
Playing Back Songs Before Practicing .....	page 34
One-handed Practice with the Guide Lamps .....	page 38
Practicing with the Repeat Playback Function .....	page 40
Recording Your Performance.....	page 41
<b>Singing Along with Song playback (Karaoke) or Your Own Performance</b> .....	<b>page 52</b>
Connecting a Microphone (CVP-305/303).....	page 52
Singing with the Lyrics Display .....	page 53
Convenient Functions for Karaoke .....	page 53
Convenient Functions for Singing Along with Your Own Performance .....	page 55

## Compatible Song Types

The Clavinova can play back the following Song types.

### Preset Songs

Songs in the Song Selection PRESET display.

### Your Own Recorded Songs

These are Songs which you've recorded (page 41, page 133) and saved to the USER/CARD/USB display. (USB is available when you connect an external storage device to the instrument such as a floppy disk drive.)

### Commercially Available Song Data

Song data downloaded from the Yamaha Web site and commercially available Disk Songs are available when you connect the optional floppy disk drive to the instrument. The CVP is compatible with the Song disks (floppy disks) that bear the following marks:



Before using a SmartMedia card and the card slot, be sure to read "Handling SmartMedia™\*Memory Cards" on page 22.

Before using a floppy disk and the disk slot, be sure to read "Handling the Floppy Disk Drive (FDD) and Floppy Disks" on page 21

Commercially available music data is subject to protection by copyright laws. Copying commercially available data is strictly prohibited, except for your own personal use.

See page 191 for information on the types of Song data that can be played on the instrument.

# Operations for Song Playback

This section explains detailed operations and functions related to Song playback which are not covered in the “Quick Guide.”

## ■ Starting/Stopping a Song

Press the SONG [PLAY/PAUSE] button to start Song playback, and press the SONG [STOP] button to stop. In addition, there are several other convenient ways to start/stop a Song.

## Starting Playback

### Synchro Start

You can start playback as soon as you start playing the keyboard.

While playback is stopped, simultaneously press the SONG [STOP] and [PLAY/PAUSE] buttons simultaneously.

To cancel the Synchro Start function, simultaneously press the SONG [STOP] and [PLAY/PAUSE] buttons simultaneously once again.

### • Tap function

This useful function lets you press the TEMPO [TAP] button to tap out the tempo and automatically start the Song at that tapped speed. Simply tap (press/release) the button (four times for a 4/4 time signature) while the instrument is in Synchro Start standby mode, and the Song playback starts automatically at the tempo you tapped.

### Fade In

The [FADE IN/OUT] button can be used to produce smooth fade-ins when starting the Song playback. To produce fade-ins, press the [FADE IN/OUT] button while playback is stopped and then press the SONG [PLAY/PAUSE] button to start playback.

## Stopping Playback

### Fade Out

The [FADE IN/OUT] button can be used to produce smooth fade-outs when stopping the Song playback. Press the [FADE IN/OUT] button at the beginning of the phrase you want to fade out.

### Set the Fade In/Out time

The times of the fade-in and fade-out can be set independently.

#### 1 Call up the operation display.

[FUNCTION] → [I] UTILITY → TAB [◀] CONFIG 1 → [A] FADE IN/OUT/HOLD TIME

#### 2 Set the parameters related to the Fade In/Out by using the [3▲▼]–[5▲▼] buttons.

FADE IN TIME	Determines the time it takes for the volume to fade in, or go from minimum to maximum.
FADE OUT TIME	Determines the time it takes for the volume to fade out, or go from maximum to minimum.
FADE OUT HOLD TIME	Determines the time the volume is held at 0 following the fade out.

**Phrase Mark:**  
Phrase Mark is a pre-programmed marker in certain Song data, which specifies a certain location (set of measures) in the Song.

The preset Songs in the "Follow Lights" folder contain the Guide settings. These Songs are inappropriate for use with ALL or RANDOM repeat.

## ■ Top/Pause/Rewind/Fast Forward

### Moving to the top position of the Song

Press the SONG [STOP] button, regardless of whether the Song is stopped or playing back.

### Pausing the Song

Press the SONG [PLAY/PAUSE] button during Song playback. Press the SONG [PLAY/PAUSE] button again and the Song will resume from the current position.

### Moving back and forth (rewind and fast forward)

- 1 Pressing the SONG [FF] or SONG [REW] button automatically calls up a pop-up window showing the current measure number (or Phrase Mark number) in the Main display.
- 2 Press the SONG [REW] or SONG [FF] button to move back and forth (rewind and fast forward).

For Songs containing Phrase Marks, you can use the [FF] or [REW] buttons to navigate through the Phrase Marks in the Song. If you don't want to set the Song position by the phrase marks, press the [E] button and select "BAR" in the window showing the Song position.

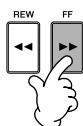

For Songs not containing Phrase Marks



For Songs containing Phrase Mark

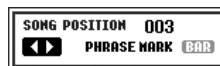

- 3 Press the [EXIT] button to close the pop-up window showing the current measure number (or Phrase Mark number).

## ■ Repeat Playback/Chain Playback

- 1 Call up the operation display.  
[FUNCTION] → [B] SONG SETTING
- 2 Set the parameters related to the Repeat Playback by using the [H]/[I] buttons. The available parameters are shown below.

<b>REPEAT MODE</b>	<p><b>OFF</b> Plays through the selected Song, then stops.</p> <p><b>SINGLE</b> Plays through the selected Song repeatedly.</p> <p><b>ALL</b> Continues playback through all the Songs in the folder containing the current Song repeatedly.</p> <p><b>RANDOM</b> Randomly and repeatedly plays back all Songs in the folder containing the current Song.</p>
<b>PHRASE MARK REPEAT</b>	<p>For Songs containing Phrase Marks, you can set Repeat Playback to "ON" or "OFF." When this is on, the part corresponding to the specified Phrase Mark number is repeatedly played back. The steps for specifying the Phrase Mark number are the same as in the steps 1–2 of the section "Moving back and forth (rewind and fast forward)" (see above).</p>



## ■ Queuing the Next Playback Song

While a Song is playing back, you can queue up the next Song for playback. This is convenient for chaining it to the next Song smoothly during stage performance. Select the Song you want play next in the Song Selection display, while a Song is playing back.

The “NEXT” indication appears at the upper right of the corresponding Song name. To cancel this setting, press the [8 ▼] (Cancel) button. When playing back a Song and a Style at the same time, we recommend that you use the Preset Songs in the “Sing-a-long” folder.

## ■ Using the Auto Accompaniment Features with the Song Playback

When playing back a Song and a Style at the same time, channels 9–16 in the Song data are replaced with style channels—allowing you to play the accompaniment parts of the Song yourself. Try playing chords along with the Song playback as shown in the instructions below. When playing back a Song and a Style at the same time, we recommend that you use the Preset Songs in the “Sing-a-long” folder.

- 1 Select a Song (page 34).
- 2 Select a Style (page 45).
- 3 Press the STYLE CONTROL [ACMP ON/OFF] button to turn on the Auto Accompaniment function.
- 4 Press the STYLE CONTROL [SYNC START] button to enable standby—letting you simultaneously start the accompaniment as soon as you start playing.
- 5 Press the SONG [PLAY/PAUSE] button to start playback.
- 6 Play chords along with the Song.  
The chord name is indicated in the Main display. To return to the Main display, press the [DIRECT ACCESS] button, then press the [EXIT] button.

When the Song playback is stopped, the style playback is also stopped at the same time.

- **Tempo for playing back a Song and a style at the same time**

When playing back a Song and a Style at the same time, the tempo value set in the Song is automatically used.

### Playing Songs with the Quick Start function

With the default settings, the Quick Start function is turned on. On some commercially available Song data, certain settings related to the Song (such as voice selection, volume, etc.) are recorded to the first measure, before the actual note data. When Quick Start is set to “ON,” the instrument reads all initial non-note data of the Song at the highest possible speed, then automatically slows down to the appropriate tempo at the first note. This allows you to start playback as quickly as possible, with a minimum pause for reading of data. When Quick Start is set to “ON,” a Song is played back directly from the first note (which may be in the middle of a measure). If you want to play from the beginning of the measure that has silence prior to the first note, turn Quick Start “OFF.”

- 1 Call up the operation display.  
[FUNCTION] → [B] SONG SETTING
- 2 Press the [7 ▼]/[8 ▼] (QUICK START) buttons to turn the Quick Start “OFF.”

### Parameter Lock

You can “lock” specific parameters (e.g., effect, split point, etc.) to make them selectable only via the panel controls (page 122).

**About the [SONG CH 1-8]/  
[SONG CH 9-16] displays**

A Song consists of 16 separate channels. Separate settings can be made for each of the 16 channels in the MIXING CONSOLE display. Adjust the parameters in the SONG CH 1-8 or SONG CH 9-16 display respectively. Usually, CH 1 is assigned to the [TRACK 1] button, CH 2 is assigned to the [TRACK 2] button, and CH 3-16 are assigned to the [EXTRA TRACKS] button, respectively.

**Reading Song data automatically when inserting a SmartMedia card**

You can have the instrument automatically call up the first Song (not contained in a folder) on a SmartMedia card, as soon as the card is inserted in the Card slot. The same operation will also be applied to other external storage devices.

- 1 Call up the operation display.  
[FUNCTION] → [I] UTILITY → TAB [◀]/[▶] MEDIA
- 2 Press the [3 ▲]/[4 ▲](SONG AUTO OPEN) button to select "ON."

## Adjusting the Volume Balance and Voice Combination, etc. (MIXING CONSOLE)

You can set the mixing-related parameters of a Song. Refer to the section "Adjustable items (parameters) in the MIXING CONSOLE display" on page 82. Call up the "SONG CH 1-8" or "SONG CH 9-16" display in step 3 of the Basic Procedure in "Editing the Volume Balance and Voice Combination (MIXING CONSOLE)" on page 80. Below are two operation examples.

### Adjusting the Volume Balance of Each Channel

- 1 Select a Song (page 34).
- 2 Press the [MIXING CONSOLE] button to call up the MIXING CONSOLE display.
- 3 Select the [VOL/VOICE] tab by pressing the TAB [◀][▶] buttons.
- 4 Press the [MIXING CONSOLE] button repeatedly to call up the display of "SONG CH 1-8" or "SONG CH 9-16."
- 5 Press the [J] button to select the "VOLUME."
- 6 Adjust the volume balance of each channel by using the [1 ▲ ▼]-[8 ▲ ▼] buttons.
- 7 You can save the volume settings to the Song in the Setup operation of the SETUP (page 152).  
Make sure to checkmark the "VOICE" item in step 2 of the Setup procedure.

## Changing Voices

- 1-4 The operation steps are the same as in the "Adjusting the Volume Balance of Each Channel" (see page 130).
- 5 Press the [H] button to select the "VOICE."
- 6 Press one of the [1▲▼]-[8▲▼] buttons to call up the Voice selection display for the channel.
- 7 Press one of the [A]-[J] buttons to select a Voice.
- 8 You can save the changed Voice selection to the Song in the Setup operation (page 152).  
Make sure to checkmark the "VOICE" item in step 2 of the Setup procedure.

## Using the Practice Function (Guide)

The keyboard guide lamps indicate the notes (location and timing) for you to play. Also, when you sing along with a Song playback using a connected microphone, the instrument automatically adjusts the timing of the Song playback to match your vocal performance (CVP-305/303).

To use the practice function, press the [GUIDE] button.

### Saving the Guide settings in the SONG SETTING display

You can save the Guide settings as a part of the Song data (page 152). For Songs to which Guide settings have been saved, the Guide function will be automatically turned on and the related settings will be recalled when the Song is selected.

## Selecting the Guide Function Type

- 1 Call up the setting display:  
[FUNCTION] → [B] SONG SETTING
- 2 Use the [A]/[B] buttons to select the desired Guide function type. The following types are available.

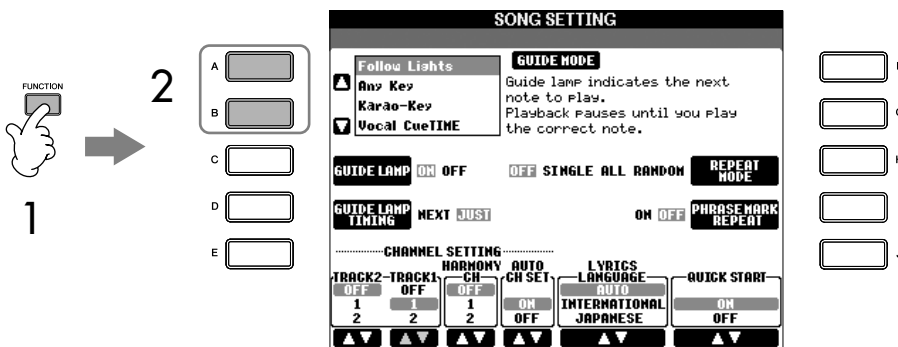

### Turning the keyboard guide lamps off

Press the [C] (GUIDE LAMP) button in the SONG SETTING display (in step 1 as described at left) to turn the keyboard guide lamps off.

## For Keyboard Performance

### Follow lights

With this function, the keyboard guide lamps indicate which notes you should play (page 38). Song playback pauses and waits for you to play. When you play the correct notes, Song playback continues.

### Any key

With this function, you can play the melody of a Song just by pressing a single key (any key is OK) in time with the rhythm. Song playback pauses and waits for you to play any key. Simply play a key on the keyboard in time with music (any key is OK) and the Song playback continues.

## For Karaoke

### Karao-key

This function lets you control the Song playback timing with just one finger, while you sing along. This is useful for singing to your own performance. Song playback pauses, waiting for you to sing. Simply play a key on the keyboard and the Song playback continues.

### Vocal CueTIME (CVP-305/303)

This function lets you practice singing with the proper pitch. Song playback pauses, waiting for you to sing. When you sing with proper pitch, Song playback continues.

### Determining the timing by which the keyboard guide lamps light (GUIDE LAMP TIMING)

Press the [D] button in the SONG SETTING display in step 1 (page 131) to select the timing by which the keyboard guide lamps light.

**JUST**..... The guide lamps light in time with the music, at the same timing you should play.

**NEXT** ..... The guide lamps light slightly ahead of the music, indicating the notes you should play next. The guide lamps flash if you fail to play the keys with the correct timing.

### If the guide lamps do not light as intended

The guide lamps light according to Song channels recorded to Track 1 and 2 and the chord data in the Song (when such data is included).

If the guide lamps do not light as intended, you may need to assign the appropriate right- and left-hand channels to Track 1 and 2 respectively, by using the [1 ▲ ▼]/[2 ▲ ▼] buttons in the SONG SETTING display as described in step 1 on the previous page.

**Turning playback channels of the Song on and off**

A Song consists of 16 separate channels. You can independently turn each channel of the selected Song playback on or off. Usually, CH 1 is assigned to [TRACK 1] button, CH 2 is assigned to [TRACK 2] button, and CH 3–16 are assigned to the [EXTRA TRACKS] button.

1 Press the [CHANNEL ON/OFF] button to call up the Song CHANNEL ON/OFF display.

If the display shown below does not appear, press the [CHANNEL ON/OFF] button again.

SONG		STYLE		CHANNEL ON/OFF											
1	2	3	4	5	6	7	8	9	10	11	12	13	14	15	16
ON	ON	ON	ON	ON	ON	ON	ON	ON	ON	ON	ON	ON	ON	ON	ON
ON	ON	ON	ON	ON	ON	ON	ON	ON	ON	ON	ON	ON	ON	ON	ON

2 Use the [1 ▲ ▼]–[8 ▲ ▼] buttons to turn each channel on or off.

If you want to play back only one particular channel (muting all other channels), press and hold down one of the [1 ▲ ▼]–[8 ▲ ▼] buttons corresponding to the desired channel. To cancel solo playback, press the same button again.

## Recording Your Performance

You can record your own performances and save them to the User tab display or a external storage devices, such as a SmartMedia card. Several different recording methods are available:

Quick Recording which lets you record performance conveniently and quickly, Multi track Recording which lets you record several different parts to multiple channels, and Step Recording which lets you enter notes one by one. You can also edit the Songs you've recorded.

## Recording Methods

There are three methods as shown below.

Realtime Recording	<b>Quick Recording</b> ▶ page 134	This convenient and simple recording method lets you quickly record your performance—useful, for example, in recording solo piano pieces. You can record to the [TRACK 1 (R)] or [TRACK 2 (L)] button, and also to the [EXTRA TRACKS (STYLE)] track, which can be used for recording at the same time.
	<b>Multi track Recording</b> ▶ page 135	This lets you record a whole Song including several different instrument parts, to create the sound of a full band or orchestra. Record the performance of each instrument part one by one and create fully orchestrated compositions. You can also record over already-recorded parts of an existing Song (Preset Song or a Song on an external device, such as SmartMedia card) with your own performance.
Step Recording	<b>Step Recording</b> ▶ page 137	This method lets you compose your performance by “writing” it down one event at a time. This is a non-realtime, manual recording method—similar to writing music notation onto paper. You can input notes, chords and other events one by one (realtime performance is not needed).

You can also edit Songs after they've been recorded (page 148).

For example, you can edit specific notes one by one, or you can use the Punch In/Out function to re-record a specific part.

The microphone input signal can not be recorded (CVP-305/303).

### Internal memory (User tab displays) capacity

The internal memory capacity of the instrument is about 1.5MB (CVP-305/303)/650KB (CVP-301). This capacity applies to all file types, including Voice, Style, Song, and Registration data files.

## Quick Recording

This lets you conveniently and quickly record your performance.

- 1 Press the **SONG [REC]** and **SONG [STOP]** buttons simultaneously. A blank Song (“New Song”) is called up for recording.

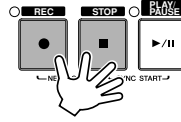

- 2 Make the desired panel settings for your keyboard performance. Below are some example settings you may want to try.

- **Recording the RIGHT 2 and/or LEFT parts**

The [RIGHT 2] and/or [LEFT] keyboard parts should be turned on. Select the voice for each keyboard part (RIGHT 2, LEFT) by calling up the Voice selection display (page 74, page 75).

- **Recording Styles**

- 1 Select a Style (page 45).
- 2 Set the tempo for recording by pressing the TEMPO [-][+] buttons, as necessary.

- **Using Registration Memory panel setups**

Press one of the REGISTRATION MEMORY [1–8] buttons.

- 3 While holding the **SONG [REC]** button, press the **SONG TRACK** buttons to be recorded.

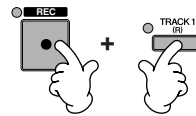

- **Recording your performance**

Press the SONG [TRACK 1 (R)] button for the right-hand part recording, and/or the SONG [TRACK 2 (L)] button for the left-hand part recording.

- **Recording Styles**

Press the SONG [EXTRA TRACKS (STYLE)] button.

- **Recording your performance and the Style playback simultaneously**

Press the SONG [TRACK 1 (R)]/[TRACK 2 (L)] buttons and the SONG [EXTRA TRACKS (STYLE)] button.

The RIGHT 2 and/or LEFT parts are recorded onto separate tracks.

## 4 Start recording.

There are several different ways you can start recording.

- **Starting by playing the keyboard**

If you've selected the SONG [TRACK 1(R)]/[TRACK 2 (L)] buttons in step 3 above, play in the right-hand section of the keyboard (page 73). If you've selected the SONG [EXTRA TRACKS (STYLES)] button in step 3 above, play in the left-hand (chord) section of the keyboard (page 100). Recording begins automatically as soon as you play a note on the keyboard.

- **Starting by pressing the SONG [PLAY/PAUSE] button**

If you start recording in this way, "empty" data is recorded until you play a note on the keyboard. This is useful for starting a Song with a short one-or two-beat pick-up or lead-in.

- **Starting by pressing the STYLE CONTROL [START/STOP] button.**

In this case the rhythm parts (channels) of the Style begin playing back and recording starts simultaneously.

## 5 Press the SONG [STOP] button to stop recording.

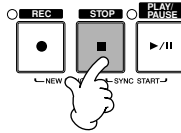

When recording is finished, a message prompting you to save the recorded performance data appears. To close the message, press the [EXIT] button. See step 7 for instructions on saving your recording.

## 6 Listen to your newly recorded performance. Press the SONG [PLAY/PAUSE] button to play back the performance you just recorded.

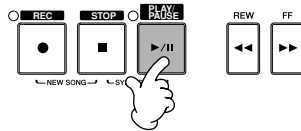

## 7 Press the [SONG SELECT] button to call up the Song Selection display for saving your data, then save the data in the Song Selection display (page 63).

## Multi Track Recording

A Song consists of 16 separate channels. With this method, you can record data to each channel independently, one by one. Both Keyboard and Style parts can be recorded.

### 1 Press the SONG[REC] and SONG[STOP] buttons simultaneously.

A blank Song ("New Song") is called up for recording.

Select Voices for recording the keyboard parts (RIGHT 1, RIGHT 2, and/or LEFT) (page 31, page 74, page 75). Select a Style for recording also, as necessary (page 45).

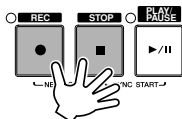

#### Example

##### Recording the keyboard RIGHT 2 part to the channel 2

Press the PART SELECT [RIGHT 2] button to call up the Voice selection display, and select a Voice for the RIGHT 2 part. Also be sure to turn the PART ON/OFF [RIGHT 2] button on.

#### Using the metronome

You can record your performance while playing back the metronome (page 30). But the metronome sound is not recorded.

#### Pausing and restarting your recording

To pause recording, press the SONG [PLAY/PAUSE] button during recording. To restart recording, follow the operations shown below.

- For recording to [TRACK 1]/[TRACK 2] recording, press the SONG [PLAY/PAUSE] button.
- For recording to [EXTRA TRACKS (STYLES)] recording, press the STYLE CONTROL [SYNC START] button, then play in the chord section of the keyboard.

#### ⚠ CAUTION

The recorded Song data will be lost if you select another Song or turn the power to the instrument off without executing the Save operation (page 63).

#### About Channels

See page 137.

**Setting all of the 9–16 channels to “REC” simultaneously**  
While holding the SONG [REC] button, press the SONG [EXTRA TRACKS (STYLE)] button.

**When selecting the MIDI part**

- Setting a single channel to MIDI  
All incoming data received via any of the MIDI channels 1–16 is recorded. When using an external MIDI keyboard or controller to record, this lets you record without having to set the MIDI transmit channel on the external device.
- Setting several channels to MIDI  
When using an external MIDI keyboard or controller to record, this records data only over the set MIDI channel—meaning the external device must also be set to the same channel.

**Recording each channel with the same tempo**

Use the Metronome function (page 30) to record each channel with the same tempo. Keep in mind that the metronome sound is not recorded.

**Pausing and restarting your recording**

See page 135.

**2 While holding the SONG [REC] button, press the [1 ▲ ▼]–[8 ▲ ▼] buttons to set the desired channels to “REC.”**

Normally, the keyboard parts should be recorded to channels 1–8, and the Styles should be recorded to channels 9–16. To cancel the channel selection, press the SONG [REC] button again.

While holding the SONG [REC] button, press the [2 ▲] button to set the channel 2 to “REC.”

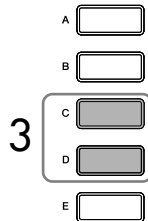

3

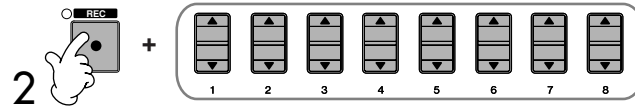

**3 Use the [C]/[D] buttons to select the desired part for the channel to be recorded.**

This determines which part—keyboard or Style (Rhythm 1/2, Bass, etc.)—is recorded to each of the channels selected in step 2. Default channel/part assignments are shown in the section “About Song channels” (page 137).

Press the [D] button to select the “RIGHT2.”

**4 Start recording.**

The method for starting is the same as in step 4 of Quick Recording (page 135).

**5 Press the SONG [STOP] button to stop recording.**

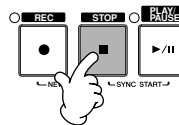

When recording is finished, a message appears prompting you to save the recorded performance appears. To close the message, press the [EXIT] button. For instructions on saving Song data, see step 8.

**6 Listen to your newly recorded performance. Press the SONG [PLAY/PAUSE] button to playback the performance you just recorded.**

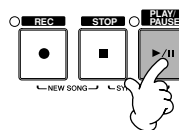

**7 To record another channel, repeat steps 2 through 6.**



- 8 Press the [SONG SELECT] button to call up the Song Selection display for saving your data, then save the data in the Song Selection display (page 63).

### About Song channels

Default channel/part assignments are shown below.

Channels	Default Parts		Channels	Keyboard parts	
1	RIGHT1	Keyboard Parts	9	RHYTHM1	Style parts
2			10	RHYTHM2	
3			11	BASS	
4			12	CHORD1	
5			13	CHORD2	
6			14	PAD	
7			15	PHRASE1	
8			16	PHRASE2	

### About keyboard parts

There are three keyboard parts, RIGHT 1, RIGHT 2 and LEFT. As the default, the RIGHT 1 part is assigned to each of the channels 1–8. Normally, the keyboard parts should be recorded to the channels 1–8.

### About Style parts

As the default, each of the Style parts is assigned to the channels 9–16, respectively as shown below. Normally, the Style parts should be recorded to the channels 9–16.

- RHYTHM ..... This is the basic part of the Style, containing the drum and percussion rhythm patterns. Usually one of the drum kits is used.
- BASS ..... The bass part uses various appropriate instrument sounds to match the style.
- CHORD ..... This is the rhythmic chord backing, commonly used with piano or guitar Voices.
- PAD ..... This part is used for sustained instruments such as strings, organ, choir, etc.
- PHRASE ..... This part is used for punchy brass stabs, arpeggiated chords, and other extras that make the accompaniment more interesting.

### ⚠ CAUTION

The recorded Song data will be lost if you select another Song or turn the power to the instrument off without executing the Save operation (page 63).

## Step Recording

This method lets you record regular music data such as melodies and chords.

### Basic Operations for Step Recording

- 1 Press the SONG[REC] and SONG[STOP] buttons simultaneously. A blank Song ("New Song") is called up for recording.

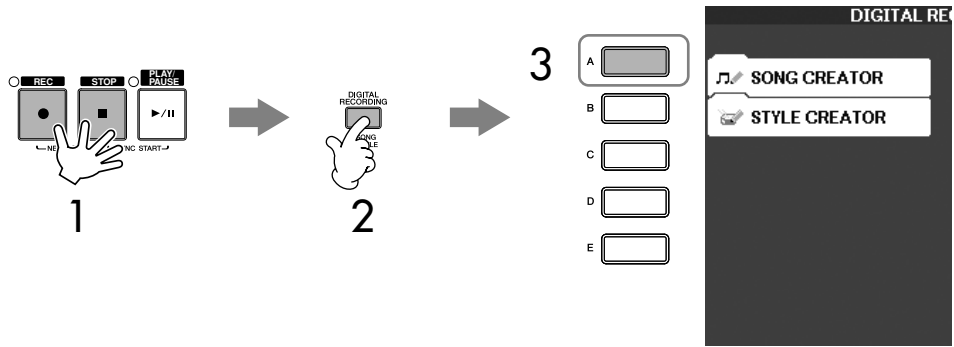

- 2 Press the [DIGITAL RECORDING] button.
- 3 Press the [A] button to call up the Song Creator display for recording/editing a Song.
- 4 Select the appropriate tab by using the TAB [◀][▶] buttons.  
 For recording melodies ..... Select the [1-16] tab.  
 For recording chords ..... Select the [CHORD] tab.

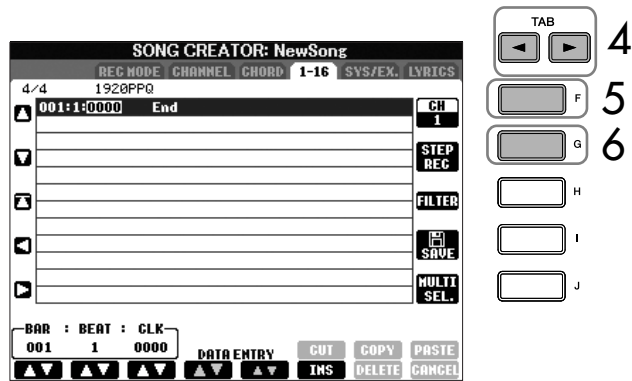

- 5 If you select the "1-16" tab in step 4, press the [F] button to select the channel for recording.
- 6 Press the [G] button to call up the STEP RECORD display.
- 7 Start Step Recording.  
 For recording melodies ..... See page 139.  
 For recording chords ..... See page 146.

## Recording Melodies

This section explains how to step-record notes, using three music score examples.

### Example 1

The explanations here apply to step 7 of the section “Basic Operations for Step Recording” on page 138.

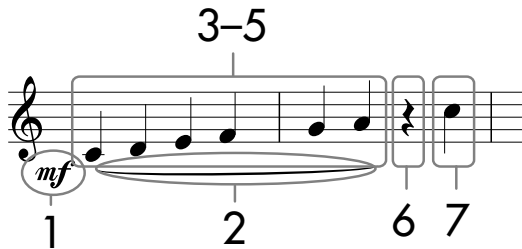

\* The numbers shown in the notation correspond to the following operation step numbers.

Select the Voice for recording after calling up the Step Record display.

1 Press the [G] button to select “mf.”

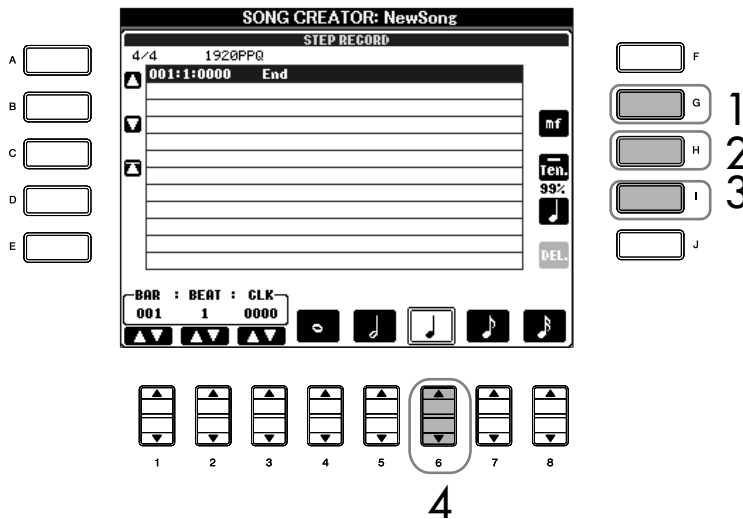

2 Press the [H] button to select “Tenuto.”

3 Press the [I] button to select “normal” note type.

4 Press the [6▲▼] button to select the quarter-note length.

5 Play the keys C3, D3, E3, F3, G3, and A3 in order, according to the notation example.

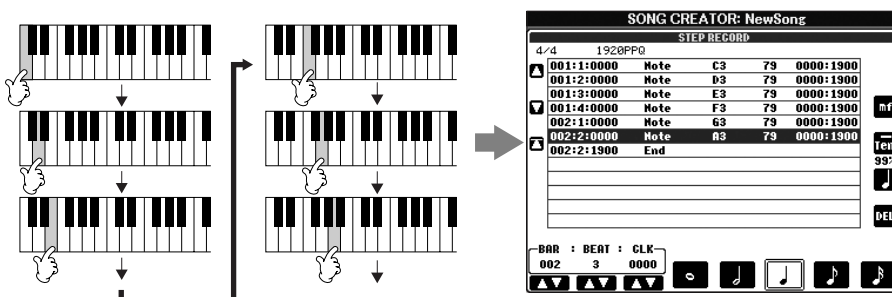

Since the music score displayed on the instrument is generated from the recorded MIDI data, it may not appear exactly the same as shown below.

About the items which can be selected via the [G] [H] [I] buttons  
See page 141.

- 6 Press the [6 ▲ ▼] button to enter a quarter-note rest.**  
 To enter the rest, use the [4 ▲ ▼]–[8 ▲ ▼] buttons. (Press the button once to select the rest value, and once again to actually enter it.) A rest having specified note length will be entered.

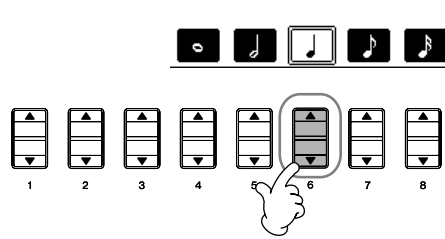

- 7 Play the C4 key.**

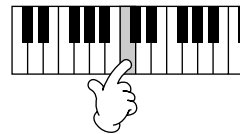

- 8 Press the SONG [STOP] button to move the cursor to the beginning of the Song.**

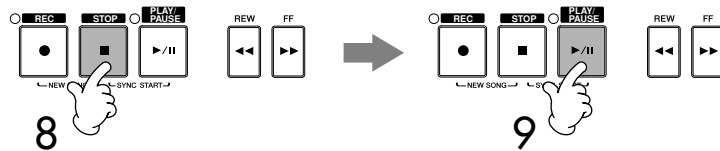

- 9 Press the SONG [PLAY/PAUSE] button to hear the newly entered notes.**
- 10 Press the [EXIT] button to exit from the Step Record display.**  
 If you want, you can also edit already recorded Songs in the same manner (page 148).
- 11 Press the [I] (SAVE) button to call up the Song Selection display for saving your data, then save the data in the Song Selection display (page 63).**

**CAUTION**  
 The recorded Song data will be lost if you select another Song or turn the power to the instrument off without executing the Save operation (page 63).

**Deleting data**

Mistakenly entered notes can be deleted.





- 1 Use the [A]/[B] buttons in the STEP RECORD display (page 138) to select the data you want to delete.
- 2 Press the [J] (DELETE) button to delete the selected data.

**About items which can be selected via the [G] [H] [I] buttons in the Step Record display**

**[G] button** ..... Determines the velocity (loudness) of the note to be entered.

Items	Velocity to be recorded
Kbd.Vel	Actual velocity you play the keyboard with
fff	127
ff	111
f	95
mf	79
mp	63
p	47
pp	31
ppp	15

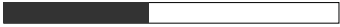
**[H] button** ..... Determines the gate time (note length) of the note to be entered.

Items	Gate time to be recorded
Normal	 80%
Tenuto	 99%
Staccato	 40%
Staccatissimo	 20%
Manual	The gate time (note length) can be set to any desired percentage by using the [DATA ENTRY] dial.

**[I] button** ..... Determines the note type to be entered. Pressing the button alternately switches the note selectors (at the bottom of the display) among three basic note values: normal, dotted and triplet.

**About velocity**

Velocity is determined by how strongly you play the keyboard. The more strongly you play the keyboard, the higher the velocity value and the louder the sound. The velocity value can be specified within a range from 1 to 127. The higher the velocity value, the louder the sound becomes.

**Example 2**

The explanations here apply to step 7 of the “Basic Operations for Step Recording” on page 138.

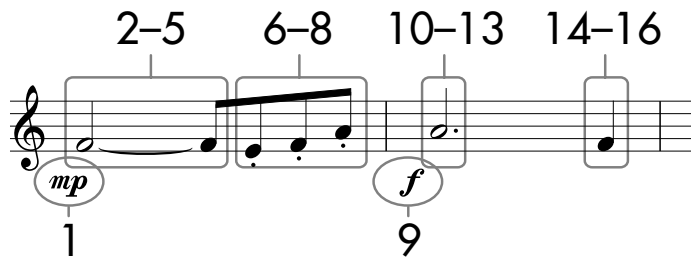

\* The numbers shown in the sheet correspond to the following operation step numbers.

In this example, keep in mind that one of the steps involves holding down a key on the keyboard while executing the operation. Select the Voice for recording after calling up the Step Record display.

**1 Press the [G] button to select “mp.”**

About the items which can be selected via the [G] [H] [I] buttons  
See page 141.

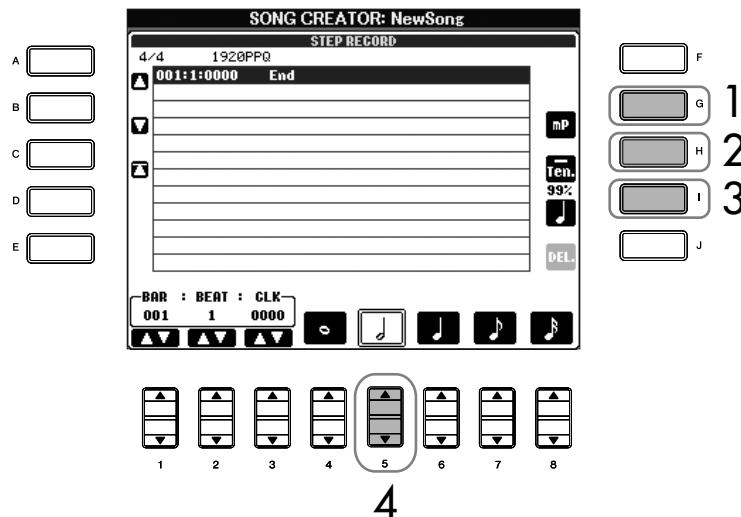

**2 Press the [H] button to select “Tenuto.”**

**3 Press the [I] button to select “normal” note type.**

**4 Press the [5 ▲ ▼] button to select the half-note length.**

**5 While holding F3 on the keyboard, press the [7 ▲ ▼] button.**

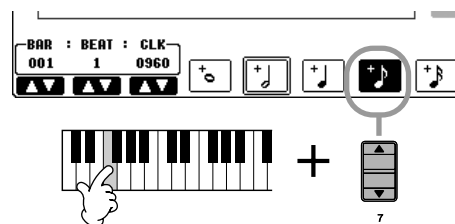

**6 Press the [H] button to select the “Staccato.”**

**7 Press the [7 ▲ ▼] button to select the eighth-note length.**

- 8 Play the keys E3, F3, and A3 in order, according to the notation example.

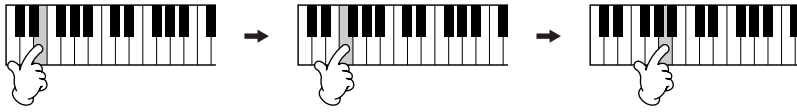

- 9 Press the [G] button to select "*f*."
- 10 Press the [H] button to select "Tenuto."
- 11 Press the [I] button to select "dotted."
- 12 Press the [5 ▲ ▼] button to select the dotted half-note length.
- 13 Play the A3 key on the keyboard, as specified in the example.
- 14 Press the [I] button to select "normal" note type.
- 15 Press the [6 ▲ ▼] button to select the quarter-note length.
- 16 Play the F3 key on the keyboard, as specified in the example.
- 17 Press the SONG [STOP] button to move the cursor to the beginning of the Song.

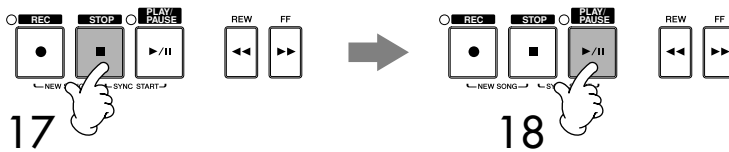

- 18 Press the SONG [PLAY/PAUSE] button to hear the newly entered notes.
- 19 Press the [EXIT] button to exit from the Step Record display. You can also edit the Songs you've recorded as necessary (page 148).
- 20 Press the [I] (SAVE) button to call up the Song Selection display for saving your data, then save the data in the Song Selection display (page 63).

**CAUTION**  
The recorded Song data will be lost if you select another Song or turn the power to the instrument off without executing the Save operation (page 63).

**Example 3**

The explanations here apply to step 7 of the “Basic Operations for Step Recording” on page 138.

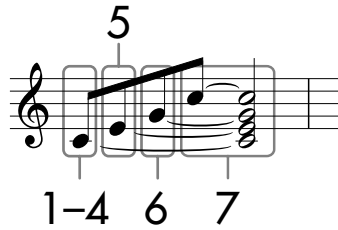

\* The numbers shown in the sheet correspond to the following operation step numbers.

In this example, keep in mind that one of the steps involves holding down a key on the keyboard while executing the entire operations. Select the Voice for recording after calling up the Step Record display.

**1** Press the [H] button to select “Normal.”

About the items which can be selected via the [G] [H] [I] buttons  
See page 141.

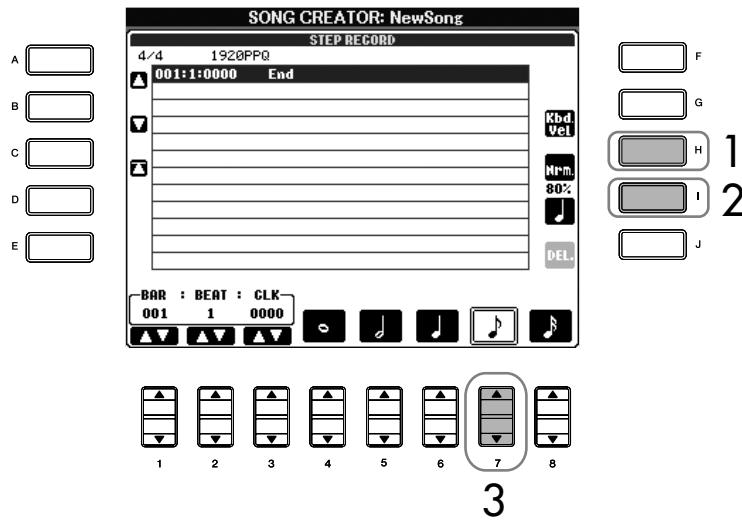

**2** Press the [I] button to select “normal” note type.

**3** Press the [7 ▲ ▼] button to select the eighth note.

**4** While holding C3 key on the keyboard, press the [7 ▲ ▼] button. Do not release the C3 key yet. Keep holding it while executing the following steps.

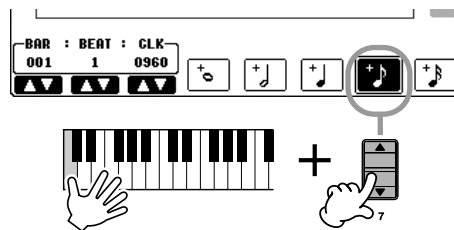



- 5 While holding the C3 and E3 keys on the keyboard, press the [7▲▼] button.

Do not release the C3 and E3 keys yet. Keep holding them while executing the following steps.

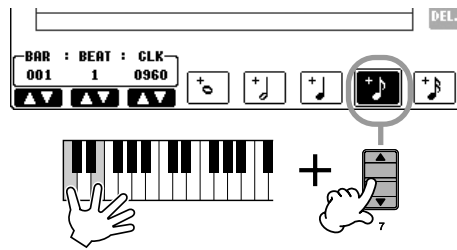

- 6 While holding the C3, E3 and G3 keys on the keyboard, press the [7▲▼] button.

Do not release the C3, E3 and G3 keys yet. Keep holding them while executing the following steps.

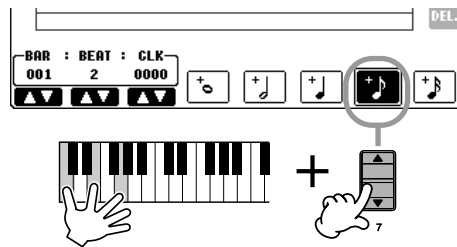

- 7 While holding the C3, E3, G3 and C4 keys on the keyboard, press the [7▲▼] button, and successively press the [5▲▼] button.

After you press the [5▲▼] button, release the keys.

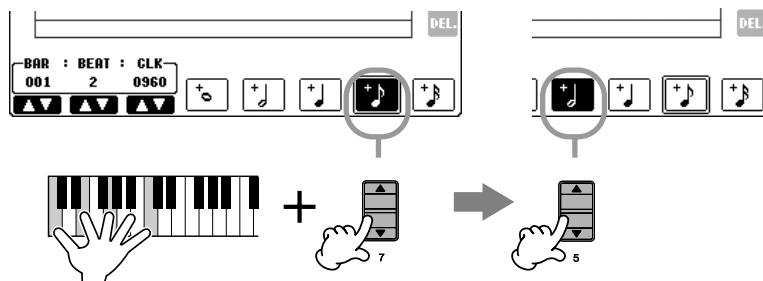

- 8 Press the SONG [STOP] button to move the cursor to the beginning of the Song.

- 9 Press the SONG [PLAY/PAUSE] button to hear the newly entered notes.

- 10 Press the [EXIT] button to exit from the Step Record display.  
If you want, you can also edit already recorded Songs in the same manner (page 148).

- 11 Press the [I] (SAVE) button to call up the Song Selection display for saving your data, then save the data in the Song Selection display (page 63).

**⚠ CAUTION**

The recorded Song data will be lost if you select another Song or turn the power to the instrument off without executing the Save operation (page 63).

## Recording Chords

You can record Chords and Sections (Intro, Main, Ending, and so on) one at a time with precise timing. These instructions show how to record chord changes using the Step Record function.

The explanations here apply to step 7 of the “Basic Operations for Step Recording” on page 138.

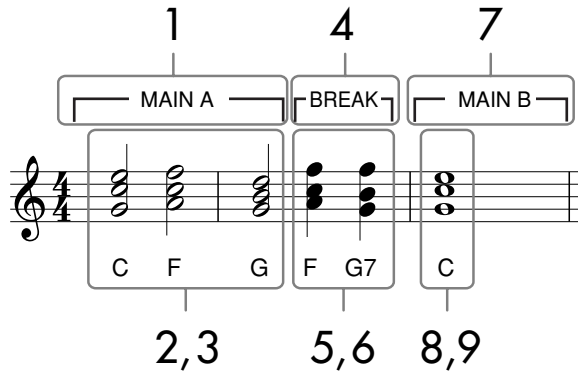

\* The numbers shown in the notation correspond to the following operation step numbers.

- 1 Make sure the STYLE CONTROL [AUTO FILL IN] button is set to OFF, then press the STYLE CONTROL [MAIN VARIATION A] button.

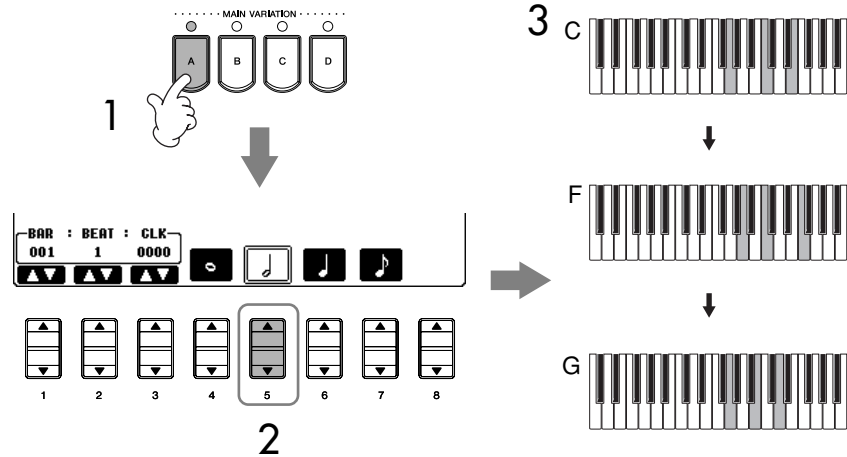

- 2 Press the [5▲▼] button to select the half-note length.
- 3 Play the chords C, F and G in the chord section of the keyboard.
- 4 Press the STYLE CONTROL [BREAK] button.

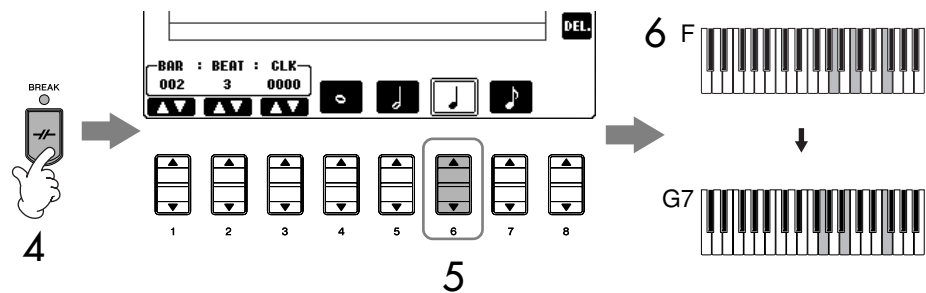

- 5 Press the [6 ▲ ▼] button to select the quarter-note length.
- 6 Play the chords F, and G7 in the chord section of the keyboard.
- 7 Press the STYLE CONTROL [MAIN VARIATION B] button.

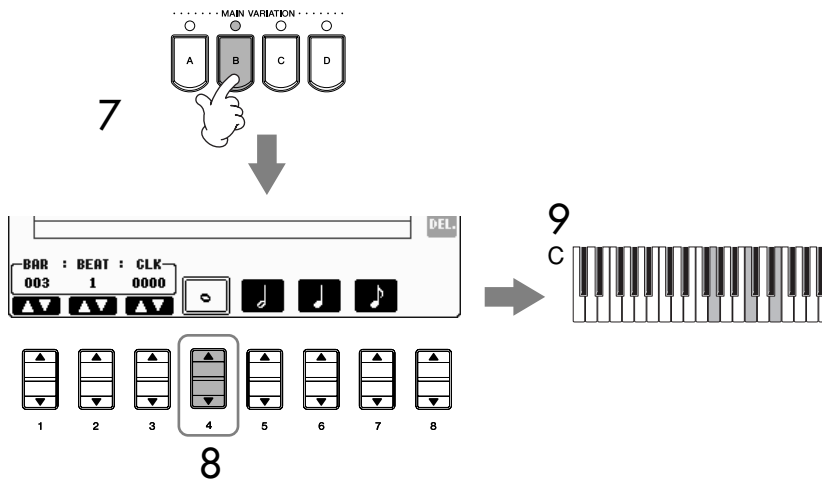

- 8 Press the [4 ▲ ▼] button to select the whole-note length.
- 9 Play the chord C in the chord section of the keyboard.
- 10 Press the SONG [STOP] button to move the cursor to the beginning of the Song.
- 11 Press the SONG [PLAY/PAUSE] button to hear the newly entered notes.
- 12 Press the [EXIT] button to exit from the Step Record display.  
If you want, you can also edit already recorded Songs in the same manner (page 148).
- 13 Press the [F] (EXPAND) button to convert the input chord change data into the Song data.
- 14 Press the [I] (SAVE) button to call up the Song Selection display for saving your data, then save the data in the Song Selection display (page 63).

**CAUTION**

The recorded Song data will be lost if you select another Song or turn the power to the instrument off without executing the Save operation (page 63).

**Deleting data**

Mistakenly entered notes can be deleted (page 140).

**Entering fill-ins**

Turn the STYLE CONTROL [AUTO FILL IN] button to ON, and simply press one of the STYLE CONTROL [MAIN VARIATION (A, B, C, D)] buttons. (The appropriate fill-in section plays and then automatically goes to the selected [MAIN VARIATION (A, B, C, D)] pattern playback.)

## Editing a Recorded Song

You can edit the Songs you've recorded with any recording method—Quick Recording, Multi Track Recording, or Step Recording.

### Basic Editing Operation

- 1 Select a Song for editing.
- 2 Press the [DIGITAL RECORDING] button.

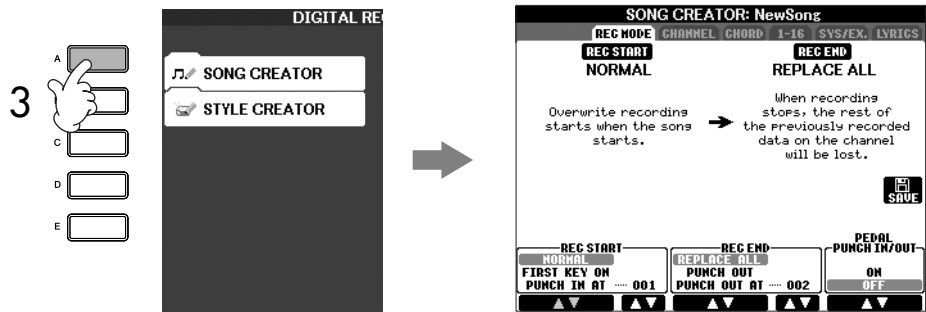

- 3 Press the [A] button to call up the SONG CREATOR display to record or edit Songs.
- 4 Select the appropriate tab by using the TAB [◀][▶] buttons and edit the Song.

- **Re-Recording a Specific Section**  
—Punch In/Out (REC MODE) ..... page 149  
This lets you re-record a specific section of a Song.
- **Editing Channel Events (CHANNEL)** ..... page 150  
This lets you edit the channel events. For example, you can delete data or transpose notes by channel.
- **Editing Note or Chord Events (CHORD, 1-16)** ..... page 153  
This lets you change or delete the recorded notes or chords.
- **Editing System Event (SYS/EX.)** ..... page 155  
This lets you change the tempo or the time signature.
- **Editing Lyrics (LYRICS)**..... page 156  
This lets you change the Song name or lyrics events.

## Re-Recording a Specific Section—Punch In/Out (REC MODE)

When re-recording a specific section of an already-recorded Song, use the Punch IN/OUT function. In this method, only the data between the Punch In point and the Punch Out point is overwritten with the newly recorded data. Keep in mind that the notes before and after the Punch In/Out points are not recorded over, although you will hear them play back normally to guide you in the Punch In/Out timing. You can specify the Punch In and Punch Out points as measure numbers beforehand for automatic operation, or manually execute the Punch In/Out recording by using a Foot Pedal or simply by playing the keyboard.

The explanations here apply to the REC MODE display in step 4 of the “Basic Editing Operation” on page 148.

- 1 Use the [1 ▲ ▼]–[6 ▲ ▼] buttons to determine the settings for re-recording (see below).
- 2 While holding the SONG [REC] button, press the desired track button.

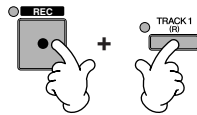

- 3 Press the SONG [PLAY/PAUSE] button to start playback. Play the keyboard at the Punch In point and stop recording at the Punch Out point.
- 4 Press the [I] (SAVE) button to call up the Song Selection display for saving your data, then save the data in the Song Selection display (page 63).

### ■ PUNCH IN settings

NORMAL	Overwrite recording starts when pressing the SONG [PLAY/PAUSE] button or when you play the keyboard in the Synchro Standby mode.
FIRST KEY ON	The Song plays back normally, then starts overwrite recording as soon as you play the keyboard.
PUNCH IN AT	The Song plays back normally up to the beginning of the indicated Punch In measure, then starts overwrite recording at that point. You can set the Punch In measure by pressing the [3 ▲ ▼] button.

### ■ PUNCH OUT settings

REPLACE ALL	This deletes all data after the point at which recording is stopped.
PUNCH OUT	The Song position at which recording is stopped is regarded as the Punch Out point. This setting maintains all data after the point at which recording is stopped.
PUNCH OUT AT	Actual overwrite recording continues until the beginning of the specified Punch Out measure (set with the corresponding display button), at which point recording stops and normal playback continues. This setting maintains all data after the point at which recording is stopped. You can set the Punch Out measure by pressing the [6 ▲ ▼] buttons.

### ⚠ CAUTION

The recorded Song data will be lost if you select another Song or turn the power to the instrument off without executing the Save operation (page 63).

### Examples of re-recording with various Punch In/Out settings

This instrument features several different ways you use the Punch In/Out function. The illustrations below indicate a variety of situations in which selected measures in an eight-measure phrase are re-recorded.

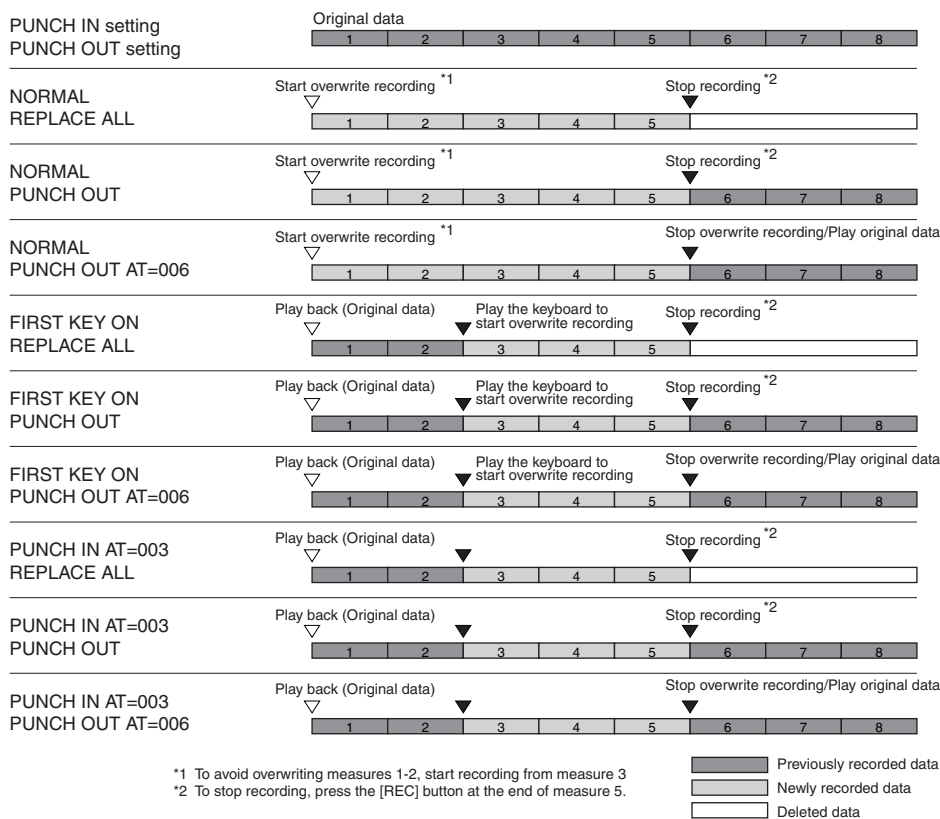

### ■ Pedal Punch In/Out settings

When this is set to ON, you can use the sostenuto pedal to control the punch-in and punch-out points. While a Song is playing back, pressing (and holding) the sostenuto pedal instantly enables Punch In recording, while releasing the pedal stops recording (Punch Out). You can press and release the sostenuto pedal as often as you want during playback, to punch in/out of overwrite recording. Note that the current function assignment of the sostenuto pedal is cancelled when the Pedal Punch In/Out function is set to ON.

## Editing Channel Events (CHANNEL)

The explanations here apply to the CHANNEL tab display in the step 4 of the Basic Editing Operation on page 148.

- 1** Use the [A]/[B] buttons to select the Edit menu (page 151).
- 2** Use the [1▲▼]-[8▲▼] buttons to edit the data.  
For information on the available parameters, see page 151.
- 3** Press the [D] (EXECUTE) button to execute the operation for the current display.  
After the operation (with the exception of the SETUP menu display) is completed, this button changes to "UNDO," letting you restore the original data if you are not satisfied with the Operation results. The Undo function only has one level; only the immediate operation can be undone.

**4** Press the [I] (SAVE) button to call up the Song Selection display for saving your data, then save the data in the Song Selection display (page 63).

**■ QUANTIZE menu**

The Quantize function allows you to align the timing of all the notes in a channel. For example, if you record the musical phrase shown at right, you may not play it with absolute precision, and your performance may have been slightly ahead of or behind the precise timing. Quantize is a convenient way of correcting for this.



**⚠ CAUTION**  
The recorded Song data will be lost if you select another Song or turn the power to the instrument off without executing the Save operation (page 63).

<b>CHANNEL</b>	Determines the channel in the Song to be quantized.										
<b>SIZE</b>	<p>Selects the quantize size (resolution). For optimum results, you should set the Quantize size to the shortest note value in the channel. For example, if eighth notes are the shortest in the channel, you should use eighth note as the Quantize size.</p> <p style="text-align: right;">After eighth note quantization</p> <p><b>Settings</b></p> <table style="width: 100%; text-align: center;"> <tr> <td> quarter note</td> <td> eighth note</td> <td> sixteenth note</td> <td> thirty-second note</td> <td> sixteenth note + eighth note triplet*</td> </tr> <tr> <td> quarter note triplet</td> <td> eighth note triplet</td> <td> sixteenth note triplet</td> <td> eighth note + eighth note triplet*</td> <td> sixteenth note + sixteenth note triplet*</td> </tr> </table> <p>The three Quantize settings marked with asterisks (*) are exceptionally convenient, since they allow you to quantize two different note values at the same time. For example, when the straight eighth notes and eighth notes triplet are contained in the same channel, if you quantize by the straight eighth notes, all notes in the channel are quantized to straight eighth notes—completely eliminating any triplet feel. However, if you use the eighth note + eighth note triplet setting, both the straight and triplet notes will be quantized correctly.</p>	quarter note	eighth note	sixteenth note	thirty-second note	sixteenth note + eighth note triplet*	quarter note triplet	eighth note triplet	sixteenth note triplet	eighth note + eighth note triplet*	sixteenth note + sixteenth note triplet*
quarter note	eighth note	sixteenth note	thirty-second note	sixteenth note + eighth note triplet*							
quarter note triplet	eighth note triplet	sixteenth note triplet	eighth note + eighth note triplet*	sixteenth note + sixteenth note triplet*							
<b>STRENGTH</b>	<p>Determines how strongly the notes will be quantized. A setting of 100% produces exact timing. If a value less than 100% is selected, notes will be moved toward the specified quantization beats according to the specified percentage. Applying less than 100% quantization lets you preserve some of the “human” feel in the recording.</p>										

**■ Deleting the data of the specified channel (DELETE menu)**

You can delete the data of the specified channel in the Song. Select the channel whose data to be deleted by using the [1 ▲ ▼]–[8 ▲ ▼] buttons, then press the [D] (EXECUTE) button to execute the operation.

**About Quantize size (resolution)**  
The Quantize size or resolution is the number of clocks per quarter note.

### ■ Mixing (merging) the data of the specified two channels (MIX menu)

This function lets you mix the data of the two channels and place the results in a different channel. It also lets you copy the data from one channel to another.

<b>SOURCE 1</b>	Selects the channel (1–16) to be mixed. All MIDI events in the selected channel are copied to the destination channel.
<b>SOURCE 2</b>	Selects the channel (1–16) to be mixed. Only note events in the selected channel are copied to the destination channel. In addition to the values 1–16, there is a “COPY” setting that allows you to copy the data from Source 1 to the destination channel. If “COPY” is selected here, the data from Source 1 is copied to the destination channel. (The original channel data is maintained.)
<b>DESTINATION</b>	Selects the channel into which the mix or copy results will be placed.

### ■ CHANNEL TRANSPOSE menu

This allows you to transpose the recorded data of individual channels up or down by a maximum of two octaves in semitone increments.

#### To display the channels 9–16

Press the [F] button to toggle between the two channel displays—Channels 1–8, and Channels 9–16.

#### Transposing to the same value for all channels simultaneously

While holding the [G] (ALL CH) button, press one of the [1 ▲ ▼]–[8 ▲ ▼] buttons.

### SETUP menu

The current settings of the Mixing Console (page 80) displays and other panel settings can be recorded to the top position of the Song as the Setup data. The Mixing Console and panel settings recorded here are automatically recalled when the Song starts.

### ■ Setup recording procedure

- 1 **Call up the operation display.**  
[DIGITAL RECORDING] → [A] SONG CREATOR → TAB [◀]/[▶] CHANNEL → [B] SET UP
- 2 **Use the [1 ▲ ▼]–[7 ▲ ▼] buttons to determine the settings to be automatically called up when the Song starts.**

<b>SONG</b>	Records the tempo setting and all settings made from the Mixing Console.
<b>KEYBOARD VOICE</b>	Records the panel settings including the Voice selection of the keyboard parts (RIGHT1, 2, and LEFT) and their on/off status. Panel settings recorded here are same as the ones memorized to the One Touch Setting. This can be recorded at any point in a Song (the other items in this chart can be recorded only to the top position of the Song).
<b>SCORE SETTING</b>	Records the settings in the Score display.
<b>GUIDE SETTING</b>	Records the settings of the Guide functions including the Guide ON/OFF setting.
<b>LYRICS SETTING</b>	Records the settings in the Lyrics display.
<b>MIC SETTING (CVP-305/303)</b>	Records the microphone and the Vocal Harmony settings in the Mixing Console display (page 80).

- 3 **Checkmark the selected item by pressing the [8 ▲] button.**



- 4 Press the [D] (EXECUTE) button to execute the SETUP recording operation.
- 5 Press the [I] (SAVE) button to call up the Song Selection display for saving your data, then save the data in the Song Selection display (page 63).

## Editing Note or Chord Events (CHORD, 1–16)

The explanations here apply to the CHORD and 1–16 tab displays in step 4 of the Basic Editing Operation on page 148.

- 1 When the 1–16 tab display is selected, press the [F] button to select the channel to be edited.
- 2 Move the cursor to the desired data.
  - To move the cursor up or down ..... Use the [A]/[B] button.
  - To move the cursor to the top data ..... Press the [C] button.
  - To move the cursor by Measure/Beat/Clock units .... Use the [1 ▲ ▼]–[3 ▲ ▼] buttons.
- 3 Edit the data.
  - Editing the data line by line**  
Use the [6 ▲ ▼]–[8 ▲] buttons to cut/copy/paste/insert/delete the events.
  - Editing each parameter of the data**
    - 1 Use the [D]/[E] buttons to select the parameter to be edited.
    - 2 Use the [4 ▲ ▼]/[5 ▲ ▼] buttons to edit the parameter value. The [DATA ENTRY] dial can also be used. To actually enter an edited value, simply move the cursor away from the parameter.

To restore the original value, press the [8 ▼] (CANCEL) button before move the cursor.
- 4 When the CHORD tab display is selected, press the [F] (EXPAND) button to convert the data into Song data.
- 5 Press the [I] (SAVE) button to call up the Song Selection display for saving your data, then save the data in the Song Selection display (page 63).

### ⚠ CAUTION

The recorded Song data will be lost if you select another Song or turn the power to the instrument off without executing the Save operation (page 63).

### Selecting multiple lines of data

While holding the [J] (MULTI SELECT) button, press the [A]/[B] buttons.

### Displaying specific types of event (FILTER)

You can select the event types to be displayed in the [CHORD] and [1–16] tab displays. This is convenient, for example, when you wish to have only the note events shown (page 155).

### ⚠ CAUTION

The recorded Song data will be lost if you select another Song or turn the power to the instrument off without executing the Save operation (page 63).

**About Clock**

A unit of note resolution. The Quantize size is the number of clocks per quarter note. On the CVP-305/303/301, one clock is equal to 1/1920th of a quarter note.

**About the events shown in the display**

Example **001 : 1 : 1440**

Measure number (BAR) | Beat | Clock

- ❶ Indicates the location (position) of the corresponding event. Same as the indication at the lower left of the display.
- ❷ Indicates the event types (see below).
- ❸ Indicates the event values.

**Event types shown on the 1-16 tab display**

<b>Note</b>	The individual note of a Song. Includes the note number which corresponds to the key which was played, plus a velocity value based on how hard the key is played, and the gate time value (the length of a note).
<b>Ctrl (Control Change)</b>	Settings to control the Voice, such as volume, pan, filter and effect depth (edited via the Mixing Console described on page 80), etc.
<b>Prog (Program Change)</b>	MIDI program change number for selecting a Voice.
<b>P.Bnd (Pitch Bend)</b>	Data for changing the pitch of a Voice continuously.
<b>A.T.(Aftertouch)</b>	This event is generated when pressure is applied to a key after the note is played.

**Event types shown on the CHORD tab display**

<b>Style</b>	Style
<b>Tempo</b>	tempo
<b>Chord</b>	chord root, chord type, on bass chord
<b>Sect</b>	Accompaniment Style Section (Intro, Main, Fill In, Break, Ending)
<b>OnOff</b>	On/off status for each part (channel) of the Accompaniment Style
<b>CH.Vol</b>	Volume for each part (channel) of the Accompaniment Style
<b>S.Vol</b>	Overall volume of the Accompaniment Style

## Displaying Specific Types of Events (FILTER)

In the edit displays various types of events are shown. It may sometimes be difficult to pinpoint the ones you want to edit. This is where the Filter function comes in handy. It lets you determine which event types will be shown in the edit displays.

- 1 Press the [H] (FILTER) button in the edit displays.
- 2 Select the event type by using the [2▲▼]–[5▲▼] buttons.
- 3 Checkmark (show) or remove the checkmark for the selected item by using the [6▲▼]/[7▲▼] buttons.
  - [H](ALL ON)..... Checkmarks for all event types.
  - [I] (NOTE/CHORD)..... Selects only NOTE/CHORD data.
  - [J] (INVERT) ..... Reverses the checkmark settings for all boxes. In other words, this enters checkmarks to all boxes that were previously unchecked and vice versa.
- 4 Press the [EXIT] button to execute the settings.

Pressing the [C]–[E] buttons calls up the respective Filter displays as shown below.

MAIN ..... Call up the Main Filter display.  
 CTRL CHG ..... Call up the Control Change Filter display.  
 STYLE ..... Call up the Accompaniment Style Filter Display.

## Editing System Exclusive Events (SYS/EX.)

The explanations here apply to the [SYS/EX] tab display in step 4 of the Basic Editing Operation on page 148.

From this display, you can edit recorded System Exclusive events, which do not belong to a specific channel, such as tempo and beat (time signature). The operations here are basically the same as those in the section “Editing Note or Chord Events” on page 153.

### System Events

<b>ScBar (Score Start Bar)</b>	Determines the top measure of a Song.
<b>Tempo</b>	Determines the tempo value.
<b>Time (Time Signature)</b>	Determines the time signature.
<b>Key (Key Signature)</b>	Determines the key signature, as well as the major/minor setting, for the music score shown on the display.
<b>XGPrm (XG Parameters)</b>	Allows you to make various detailed changes to the XG parameters. Refer to the “MIDI Data Format” in the separate Data List booklet for details.
<b>SysEx (System exclusive)</b>	Displays the System Exclusive data in the Song. Keep in mind that you cannot create new data or change the contents of the data here; however, you can delete, cut, copy, and paste the data.
<b>Meta (Meta Event)</b>	Displays the SMF meta events in the Song. Keep in mind that you cannot create new data or change the contents of the data here; however, you can delete, cut, copy, and paste the data.

Press the [I] (SAVE) button to call up the Song Selection display for saving your data, then save the data in the Song Selection display (page 63).



### CAUTION

The recorded Song data will be lost if you select another Song or turn the power to the instrument off without executing the Save operation (page 63).

## Editing Lyrics (LYRICS)

The explanations here apply to the LYRICS tab display in step 4 of the Basic Editing Operation on page 148. From this display, you can edit the recorded Lyrics events. The operations here are basically the same as in the section “Editing Note or Chord Events” on page 153.

### Lyrics Events

<b>Name</b>	Allows you to enter the Song name.
<b>Lyrics</b>	Allows you to enter lyrics.
<b>Control Codes</b>	<p><b>CR</b> Enters a line break in the lyrics text.</p> <p><b>LF</b> Unavailable on the Clavinova. On some MIDI devices, this event may delete the currently displayed lyrics and display the next set of lyrics.</p>

### Inputting and Editing Lyrics

- 1 Use the [4▲▼]/[5▲▼](DATA ENTRY) buttons to call up the lyrics editing display.  
Operations are the same as in the section “Entering Characters” (page 67).
- 2 Press the [I] (SAVE) button to call up the Song Selection display for saving your data, then save the data in the Song Selection display (page 63).

**⚠ CAUTION**  
The recorded Song data will be lost if you select another Song or turn the power to the instrument off without executing the Save operation (page 63).

## Reference to Quick Guide pages

<b>Singing Along with Song Playback (Karaoke) or Your Own Performance</b> .....	page 52
<b>Connecting a Microphone</b> .....	page 52
<b>Singing with the Lyrics Display</b> .....	page 53
<b>Convenient Functions for Karaoke</b> .....	page 53
Adjusting the tempo .....	page 30
Transpose .....	page 53
Applying effects to Your Voice .....	page 54
Adding Harmony Vocals to Your Voice.....	page 54
Practicing Singing with Proper Pitch (Vocal CueTIME).....	page 131
<b>Convenient Functions for Singing Along with Your Own Performance</b> .....	page 55
Changing the Key (Transpose).....	page 55
Displaying the Music Score on Instrument and Lyrics on TV (CVP-305) .....	page 56
Making Announcements Between Songs .....	page 56
Controlling Playback Timing by Your Voice (Karao-Key) .....	page 131

## Editing Vocal Harmony Parameters

This section explains briefly how to create your own Vocal Harmony (page 54) types, and lists the detailed parameters for editing. Up to ten Vocal Harmony types can be created and saved.

1 Press the [MIC SETTING/VOCAL HARMONY] button.

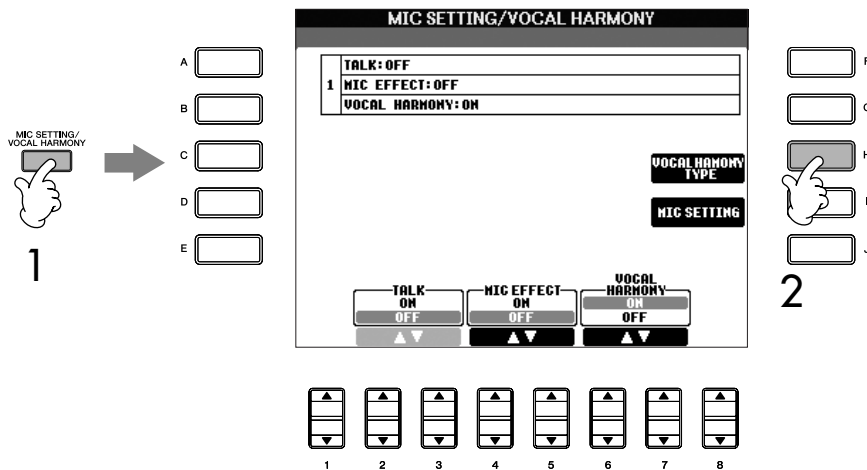

2 Press the [H] (VOCAL HARMONY TYPE) button to call up the VOCAL HARMONY TYPE selection display.

3 Press one of the [A]-[J] buttons to select a Vocal Harmony type to be edited.

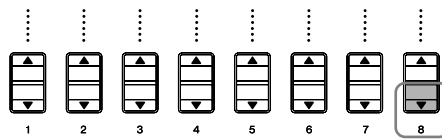
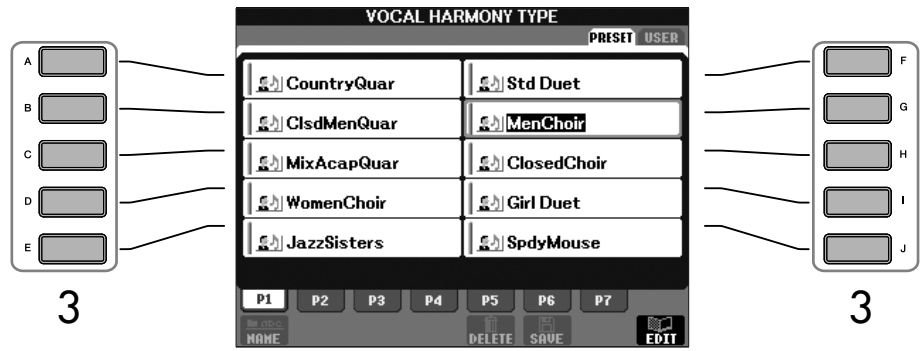

4 Press the [8 ▼] (EDIT) button to call up the VOCAL HARMONY EDIT display.

5 If you want to re-select the Vocal Harmony type, use the [1 ▲ ▼]/ [2 ▲ ▼] buttons.

Or you can re-select the Vocal Harmony type by pressing the [8 ▲ ▼] (RETURN) button to return to the Vocal Harmony selection display.

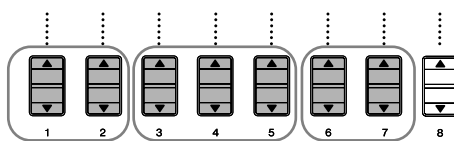
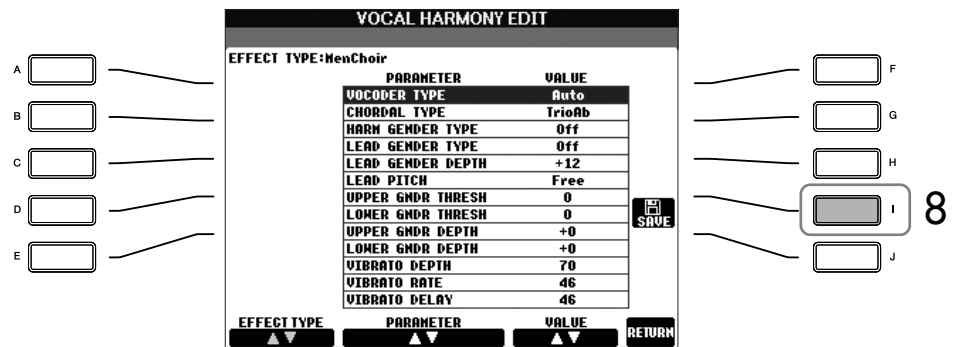

6 Use the [3 ▲ ▼]-[5 ▲ ▼] buttons to select the parameter (page 159) you want to edit.

7 Set the value of the parameter selected above.

8 Press the [I] (SAVE) button to save your edited Vocal Harmony type (page 63).

**CAUTION**  
The settings here will be lost if you change to another Vocal Harmony type or you turn the power off without executing the save operation (page 63).

**Editable Parameters in the VOCAL HARMONY EDIT Display**

<b>VOCODER TYPE</b>	Determines how the harmony notes are applied to the microphone sound when the Harmony mode (page 163) is set to "VOCODER."
<b>CHORDAL TYPE</b>	Determines how the harmony notes are applied to the microphone sound when the Harmony mode (page 163) is set to "CHORDAL."
<b>HARMONY GENDER TYPE</b>	Determines whether the gender of the harmony sound is changed or not. <b>Off</b> The gender of the harmony sound is not changed. <b>Auto</b> The gender of the harmony sound is changed automatically.
<b>LEAD GENDER TYPE</b>	Determines whether and how the gender of the lead vocal sound (i.e., the direct microphone sound) will be changed. Please note that the number of harmony notes differs depending on the selected type. When set to Off, three harmony notes are produced. Other settings produce two harmony notes. <b>Off</b> No gender change occurs. <b>Unison</b> No gender change occurs. You can adjust the LEAD GENDER DEPTH below. <b>Male</b> The corresponding gender change is applied to the lead vocal. <b>Female</b> The corresponding gender change is applied to the lead vocal.
<b>LEAD GENDER DEPTH</b>	Adjusts the degree of lead vocal gender change. This is available when the LEAD GENDER TYPE above is set to other than Off. The higher the value, the more "feminine" the harmony voice becomes. The lower the value, the more "masculine" the voice.
<b>LEAD PITCH CORRECTION</b>	When "Correct" is selected, the pitch of the lead vocal is shifted in precise semitone steps. This parameter is only effective when the LEAD GENDER TYPE above is set to other than Off.
<b>UPPER GENDER THRESHOLD</b>	Gender change will occur when the harmony pitch reaches or exceeds the specified number of semitones above the lead vocal pitch.
<b>LOWER GENDER THRESHOLD</b>	Gender change will occur when the harmony pitch reaches or exceeds the specified number of semitones below the lead vocal pitch.
<b>UPPER GENDER DEPTH</b>	Adjusts the degree of gender change applied to harmony notes higher than the UPPER GENDER THRESHOLD. The higher the value, the more "feminine" the harmony voice becomes. The lower the value, the more "masculine" the voice.
<b>LOWER GENDER DEPTH</b>	Adjusts the degree of gender change applied to harmony notes lower than the LOWER GENDER THRESHOLD. The higher the value, the more "feminine" the harmony voice becomes. The lower the value, the more "masculine" the voice.
<b>VIBRATO DEPTH</b>	Sets the depth of vibrato applied to the harmony sound. Also affects the lead vocal sound when the LEAD GENDER TYPE above is set to other than Off.
<b>VIBRATO RATE</b>	Sets the speed of the vibrato effect. Also affects the lead vocal sound when the LEAD GENDER TYPE above is set to other than Off.
<b>VIBRATO DELAY</b>	Specifies the length of the delay before the vibrato effect begins when a note is produced. Higher values result in a longer delay.

<b>HARMONY1/2/3 VOLUME</b>	Sets the volume of the first (lowest), second, and third (highest) harmony notes.
<b>HARMONY1/2/3 PAN</b>	Specifies the stereo (pan) position of the first (lowest), second, and third (highest) harmony notes. <b>Random</b> The stereo position of the sound will change randomly whenever the keyboard is played. This is effective when the Harmony mode (page 163) is set to "VOCODER" or "CHORDAL." <b>L63&gt;R - C - L&lt;R63</b> A setting of L63>R pans the sound hard left, while C is at center, and L<R63 is at hard right.
<b>HARMONY1/2/3 DETUNE</b>	Detunes the first (lowest), second, and third (highest) harmony notes by the specified number of cents.
<b>PITCH TO NOTE</b>	When this is set to "ON," you can "play" the voices of the Clavinova with your voice. (The Clavinova tracks the pitch of your voice and converts it to note data for the tone generator. Keep in mind, however, that dynamic changes in your voice do not affect the volume of the tone generator.)
<b>PITCH TO NOTE PART</b>	Determines which of the Clavinova parts will be controlled by the lead vocal when the Pitch to Note parameter is "ON."

## Adjusting the Microphone and Harmony Sound

1 Press the [MIC SETTING/VOCAL HARMONY] button.

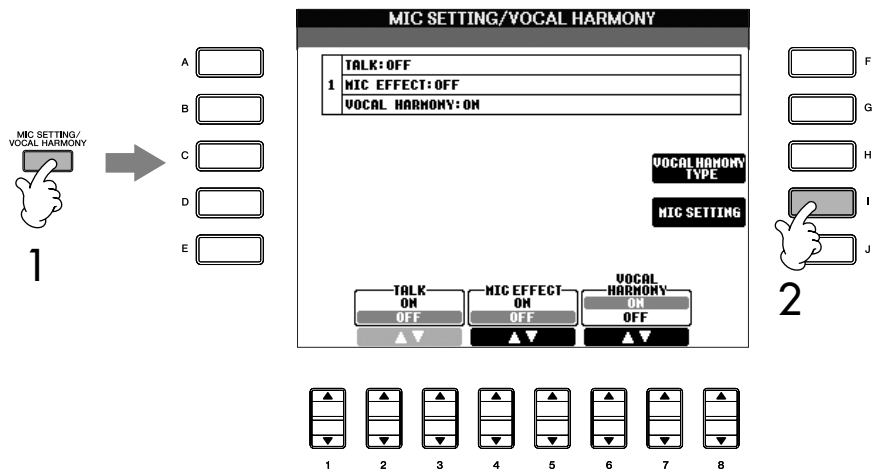

2 Press the [I] (MIC SETTING) button to call up the MICROPHONE SETTING display.



3 Press the TAB [◀] button to select the OVERALL SETTING tab display.

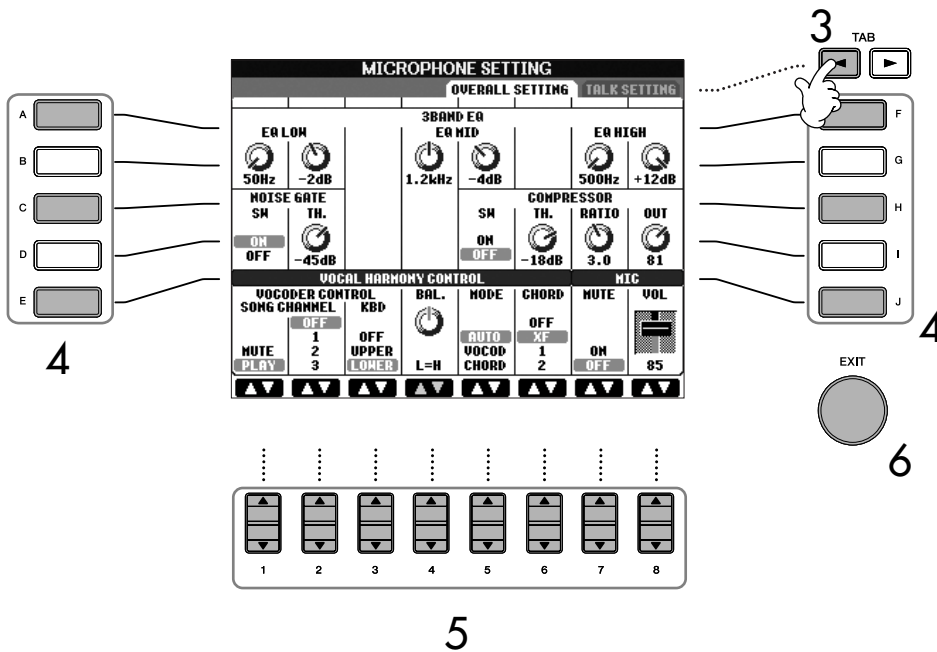

4 Use the [A]-[J] buttons to select the item (parameter) (see below) to be adjusted.

5 Use the [1▲▼]-[8▲▼] buttons to set the value.

6 Press the [EXIT] button to exit from the MICROPHONE SETTING display.

**CAUTION**  
Settings in the OVERALL SETTING tab display are automatically saved to the instrument when you exit from the display. However, if you turn the power off without exiting from this display, the settings will be lost.

### Adjustable Items (Parameters) in the OVERALL SETTING Tab Display

#### ■ 3BAND EQ

EQ (Equalizer) is a processor that divides the frequency spectrum into multiple bands, which can be boosted or cut as required to tailor the overall frequency response. The Clavinova features a high-grade three-band (LOW, MID and HIGH) digital equalizer function for the microphone sound.

- **Hz**  
Adjusts the center frequency of the corresponding band.
- **dB**  
Boosts or cuts the level of the corresponding band by up to 12 dB.

#### ■ NOISE GATE

This effect mutes the input signal when the input from the microphone falls below a specified level. This effectively cuts off extraneous noise, allowing the desired signal (vocal, etc.) to pass.

- **SW (Switch)**  
This turns the Noise Gate on or off.
- **TH. (Threshold)**  
This adjusts the input level at which the gate begins to open.

■ **COMPRESSOR**

This effect holds down the output when the input signal from the microphone exceeds a specified level. This is especially useful for smoothing out vocals that have widely varying dynamics. It effectively “compresses” the signal, making soft parts louder and loud parts softer.

- **SW (Switch)**  
This turns the Compressor on or off.
- **TH. (Threshold)**  
This adjusts the input level at which compression begins to be applied.
- **RATIO**  
This adjusts the compression ratio.
- **OUT**  
This adjusts the final output level.

■ **VOCAL HARMONY CONTROL**

The following parameters determine how the harmony is controlled.

• **VOCODER CONTROL**

The Vocal Harmony effect in Vocoder mode (page 163) is controlled by note data—the notes you play on the keyboard and/or the notes of the song data. This parameter lets you determine which notes are used to control the harmony.

<b>SONG CHANNEL</b>	<p><b>MUTE/PLAY</b> When set to “MUTE,” the channel selected below (to control Harmony) is muted (turned off) during song playback.</p> <p><b>OFF/Channels 1–16</b> When set to “OFF,” song data control over harmony is turned off. When set to one of the values 1–16, note data (played from a song on the CVP or an external MIDI sequencer) contained on the corresponding channel is used to control the harmony. This setting is linked to the HARMONY CH setting in the SONG SETTING display (page 131).</p>
<b>KEYBOARD</b>	<p><b>OFF</b> Keyboard control over harmony is turned off.</p> <p><b>UPPER</b> Notes played to the right of the split point control the harmony.</p> <p><b>LOWER</b> Notes played to the left of the split point control the harmony.</p>

- **BAL.**  
This lets you set the balance between the lead vocal (your own voice) and Vocal Harmony. Raising this value increases the volume of the Vocal Harmony and decreases that of the lead vocal.  
When this is set to L<H63 (L: Lead Vocal, H: Vocal Harmony), only the Vocal Harmony is output; when it is set to L63>H, only the lead vocal is output.

- **MODE**

All of the Vocal Harmony types fall into one of three modes, which produce harmony in different ways. The harmony effect is dependent on the selected Vocal Harmony mode, and this parameter determines how the harmony is applied to your voice. The three modes are described below.

<b>AUTO</b>	When the [ACMP ON/OFF] or [LEFT] is set to ON and if chord data exists in the song, the mode is automatically set to CHORDAL. In all other cases, the mode is set to VOCODER.
<b>VOCODER</b>	The harmony notes are determined by the notes you play on the keyboard and/or song data. You can specify whether the Vocoder effect is controlled by your keyboard performance or by the Song data (page 162).
<b>CHORDAL</b>	The harmony notes are determined by the following three types of chord: chords played in the chord section of the keyboard (with the [ACMP] turned on), chords played in the LEFT Voice section of the keyboard (with the [ACMP] turned off and the [LEFT] turned on), and chords contained in song data for controlling the harmony. (Not available if the song does not contain any chord data.)

- **CHORD**

The following parameters determine which data in a recorded song is used for chord detection.

<b>OFF</b>	Chords are not detected from the song data.
<b>XF</b>	Chords of XF format are used for the Vocal Harmony.
<b>1-16</b>	Chords are detected from note data in the specified song channel.

- **MIC**

The following parameters determine how the microphone sound is controlled.

- **MUTE**

When set to ON, the microphone sound is turned off.

- **VOLUME**

Adjusts the output volume of the microphone sound.

# Talk Setting

This function lets you have special settings for making announcements between songs, separate from the settings for your singing performance.

- 1 Press the [MIC SETTING/VOCAL HARMONY] button to call up the MIC SETTING/VOCAL HARMONY display.

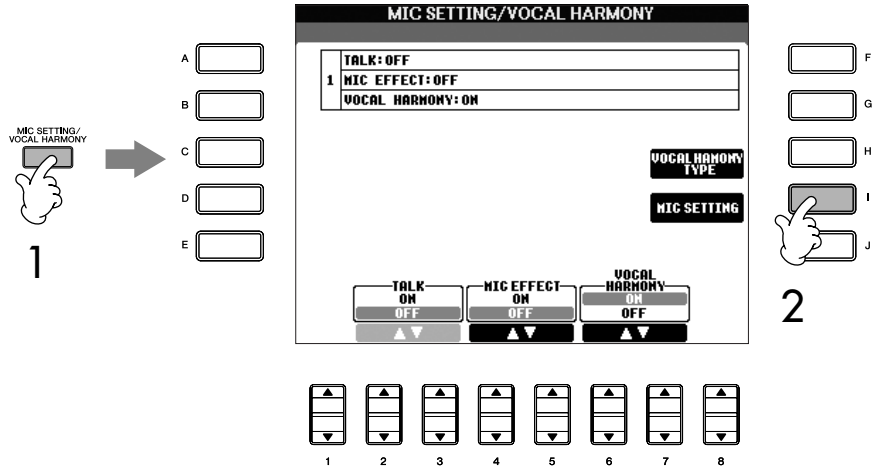

- 2 Press the [I] (MIC SETTING) button to call up the MICROPHONE SETTING display.

- 3 Press the TAB [▶] button to select the TALK SETTING tab display.

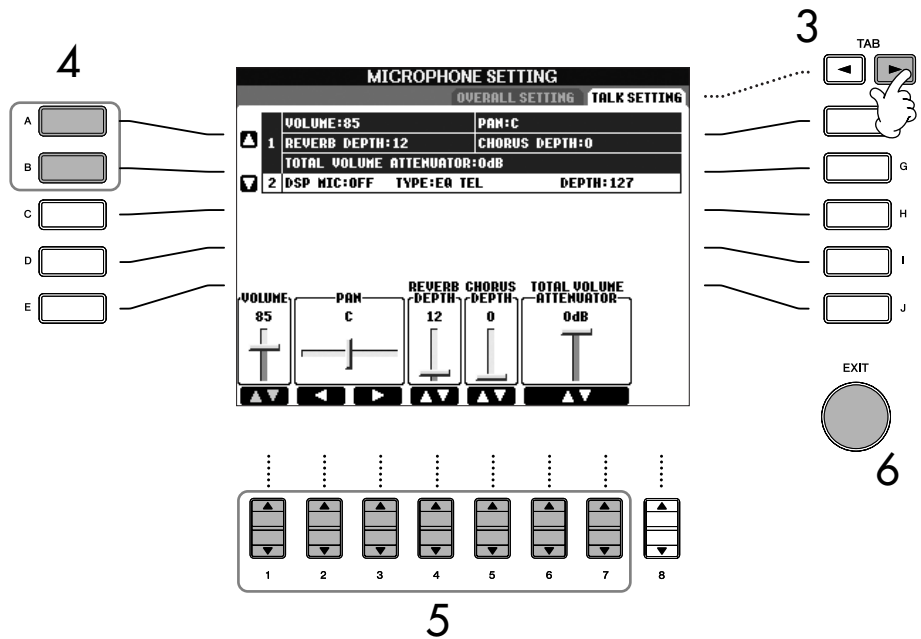

- 4 Use the [A]/[B] buttons to select the item (parameter) (page 165) to be set.

- 5 Use the [1 ▲ ▼]-[7 ▲ ▼] buttons to set the value.

- 6 Press the [EXIT] button to exit from the MICROPHONE SETTING display.

**CAUTION**

Settings in the TALK SETTING tab display are automatically saved to the instrument when you exit from the display. However, if you turn the power off without exiting from this display, the settings will be lost.

**Adjustable Items (Parameters) in the TALK SETTING Tab Display**

<b>VOLUME</b>	This determines the output volume of the microphone sound.
<b>PAN</b>	This sets the stereo pan position of the microphone sound.
<b>REVERB DEPTH</b>	This sets the depth of the reverb effects applied to the microphone sound.
<b>CHORUS DEPTH</b>	This sets the depth of the chorus effects applied to the microphone sound.
<b>TOTAL VOLUME ATTENUATOR</b>	This determines the amount of attenuation to be applied to the overall sound (excepting the microphone input)—allowing you to effectively adjust the balance between your voice and the overall instrument sound.
<b>DSP MIC ON/OFF</b>	This turns the DSP effect applied to the microphone sound ON or OFF.
<b>DSP MIC TYPE</b>	This selects the type of DSP effect to be applied to the microphone sound.
<b>DSP MIC DEPTH</b>	This sets the depth of the DSP effect applied to the microphone sound.

# Connecting the Clavinova Directly to the Internet

The special Clavinova website can be opened when directly connecting the Clavinova to the Internet.

Depending on the Internet connection, you may not be able to connect to two or more devices (for example, a computer and the instrument), depending on the contract with the provider. This means you cannot connect with the Clavinova. If in doubt, check your contract or contact your provider.

Some types of modems require an optional hub network for simultaneously connecting to several devices (such as computer, musical instrument, etc.).

You can purchase and download Song data and other types of data from the special Clavinova website by directly connecting the Clavinova to the Internet. This section contains terms related to computers and online communications. If there are some terms you are unfamiliar with, refer to the Internet Glossary (page 179).

## Connecting the Instrument to the Internet

You can connect the instrument to a full-time online connection (ADSL, optical fiber, cable Internet, etc.) via a router or a modem equipped with a router. For specific instructions on connecting (as well as information on compatible LAN adapters, routers, etc.), refer to the Yamaha Clavinova website:

CVP-305 <http://music.yamaha.com/CVP-305>

CVP-303 <http://music.yamaha.com/CVP-303>

CVP-301 <http://music.yamaha.com/CVP-301>

Use a computer to connect to the Internet and get online before connecting the instrument, since no modem or router settings can be made from the instrument itself.

To use the Internet connection, you will first need to subscribe to an Internet service or provider.

### Connection example 1: Connecting by cable (using a modem without router)

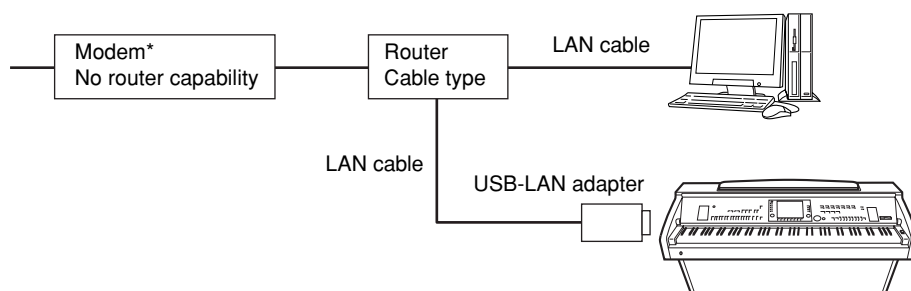

\* Here, "modem" refers to an ADSL modem, optical network unit (ONU) or cable modem.

### Connection example 2: Connecting by cable (using a modem with router)

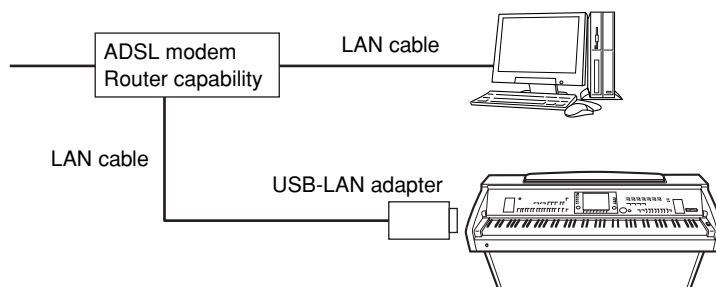

### Connection example 3: Wireless connection

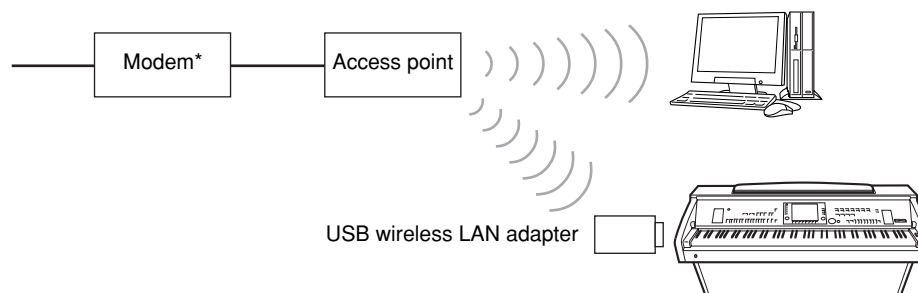

\* Here, "modem" refers to an ADSL modem, optical network unit (ONU) or cable modem.

# Accessing the Special Clavinova Website

From the special Clavinova website, you can audition and purchase Song data, among other things. To access the site, press the [E] (INTERNET) button in the Main display, while the instrument is connected to the Internet.

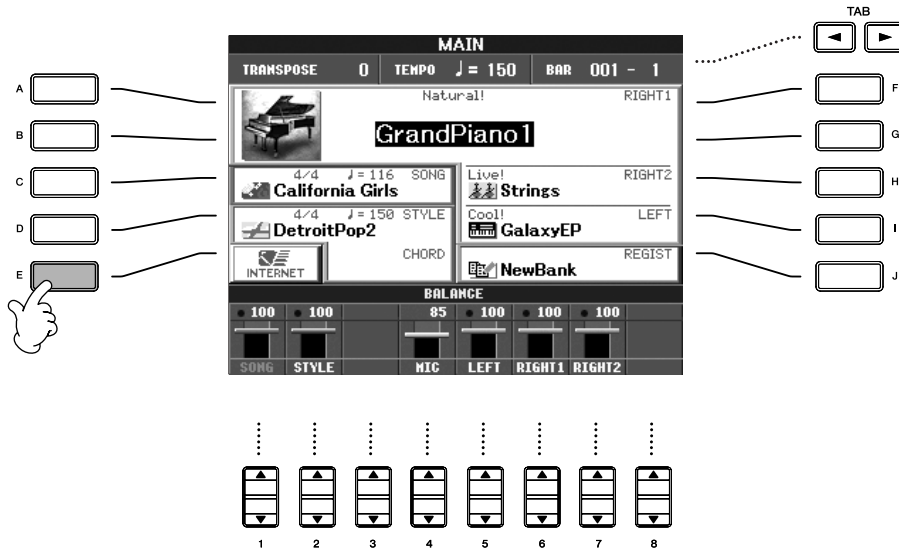

To close the website display and return to the operation display of the instrument, press the [EXIT] button.

### Returning to the Main display

You can conveniently return to the Main display from any other display by simply pressing the [DIRECT ACCESS] button, then the [EXIT] button.

### Entering characters

For instructions on entering characters in the website, see page 168.

# Operations in the Special Clavinova Website

## Scrolling the Display

When the size of the web page is too large to be shown at one time in the browser display of the instrument, a scroll bar appears at the right side of the display. Use the [DATA ENTRY] dial to scroll through the display and view those parts of the page that are not shown.

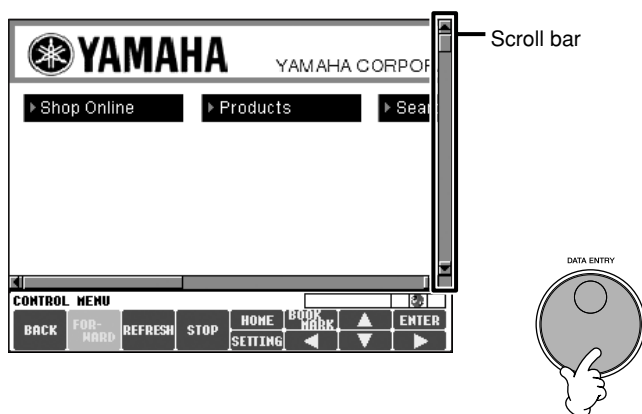

## Following Links

When there is a link in the page, it is shown as a button or in colored text, etc. To select the link, press the [6 ▼]/[7 ▲ ▼]/[8 ▼] buttons. Press the [8 ▲] (ENTER) button to actually call up the link destination.

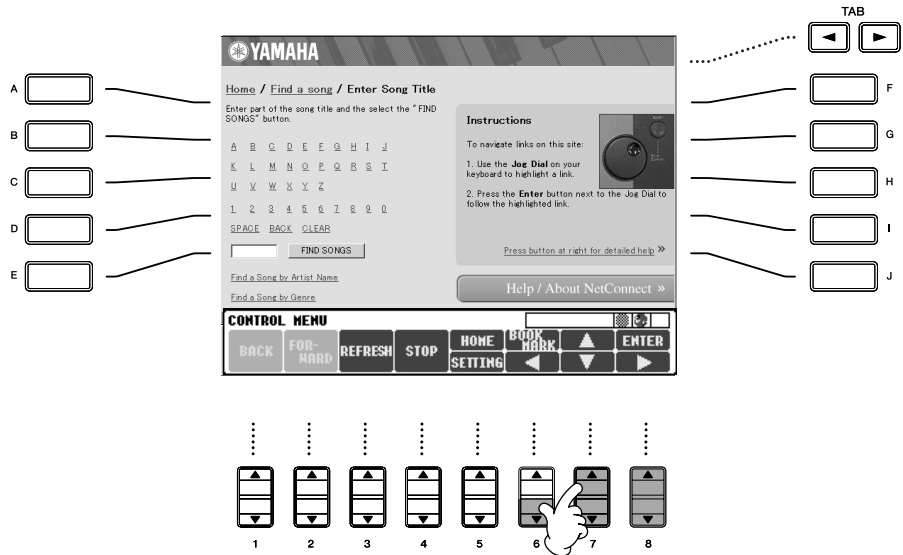

You can also select and call up links by using the [DATA ENTRY] dial and pressing the [ENTER] button.

## Entering Characters

This section explains how to enter characters within the website, for inputting a password or searching for data, etc.

- 1 With the cursor at a field for character entry (such as a password box, or other field; see "Following Links" above), press the [ENTER] button to call up the character input display.

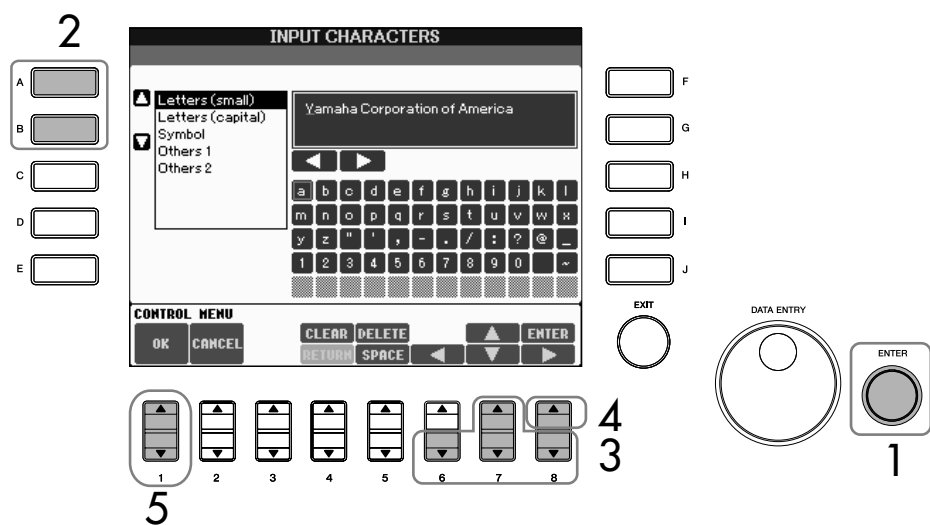

- 2 Select the desired character type by pressing the [A]/[B] buttons.



**3 Use the [6▼]/[7▲▼]/[8▼] buttons to move the highlight to the desired character.**  
 You can also use the [DATA ENTRY] dial to move the highlight to the desired position.

**4 Press the [8▲] (ENTER) button to enter the characters.**  
 You can also press the panel [ENTER] button to enter the characters.

**Deleting Characters**

- To delete the previous character, press the [5▲] (DELETE) button.
- To delete a specific character:
  - 1 **Move the cursor to the character you wish to delete.**
    - 1-1 Use the [6▼]/[7▲▼]/[8▼] buttons to move the cursor to “◀▶” below the character box.
    - 1-2 Press the [8▲] (ENTER) button to move the cursor.
  - 2 **Press the [5▲](DELETE) button to delete the character.**
- To delete all characters at once, press the [4▲] (CLEAR) button.

**Inserting a Character**

- 1 **Move the cursor to the desired position.**  
 Use the same operation as in step 1 of “Deleting Characters” above.
- 2 **Use the [6▲]/[7▲▼]/[8▼] buttons to move the highlight to the desired character.**
- 3 **Press the [8▲] (ENTER) button to enter the character.**

**Entering a Space**

- 1 **Move the cursor to the desired position.**  
 Use the same operation as in step 1 of “Deleting Characters” above.
- 2 **Press the [5▼] (SPACE) button to enter a space.**

**Entering a Line Break (Return)**

When selecting a text box that allows for several lines, press the [4▼] (RETURN) button to enter a line break.

**5 Press the [1▲▼] (OK) button to actually enter the characters.**  
 To cancel the operation, press the [2▲▼] (CANCEL) button.

**Return to the Previous Web Page**

To return to a previously selected web page, press the [1▲▼] (BACK) button. To return to the page selected before pressing the [1▲▼] (BACK) button, press the [2▲▼] (FORWARD) button.

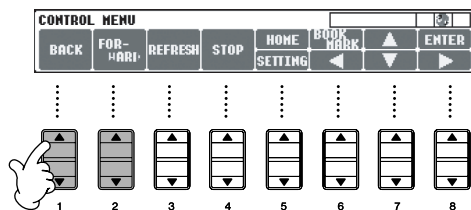

## Refreshing a Web Page/Canceling Loading of a Web Page

To refresh a web page (to make sure you have the latest version of the page, or to try reloading), press the [3 ▲ ▼] (REFRESH) button.

To cancel loading of a page (if the page is taking too long to open), press the [4 ▲ ▼] (STOP) button.

### Monitoring the Internet Connection Status

The three icons at the bottom right of the Internet display indicate the current Internet connection status.

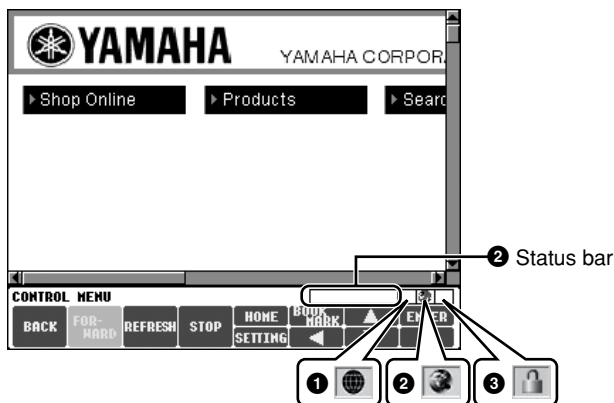

#### 1 Offline indicator

This is shown when the instrument is not connected to the Internet. When this appears, you cannot view any web pages.

#### 2 Communication Status indicator

These indicate that communication with the site is in progress.

#### 3 SSL indicator

This is shown when the opened website uses SSL, and it indicates that data is encrypted before transmission.

#### SSL:

SSL (Secure Sockets Layer) is an industry-standard method for protecting web communications by using data encryption and other tools.

When downloading data to the SmartMedia card, use a SmartMedia with ID.

## Purchasing and Downloading Data

You can purchase and download Song data (for playback on this instrument) and other types of data from the special Clavinova website. For details on purchasing and downloading data, refer to the instructions on the site itself.

### Operation after purchase and download

When downloading is completed, a message appears asking you whether or not to open the File Selection display. Select "YES" to call up the File Selection display, from which you can select the downloaded data. To return to the Internet display, select "NO." When the File Selection display is open, press the [8 ▲] (UP) button to call up the next highest level folder.

#### Download Destination

The download destination depends on the use of storage media, as described below.

- When a SmartMedia card is inserted to the instrument during purchase: The downloaded data is saved in the "MyDownloads" folder in the Card tab display of the File Selection display. To close the folder and call up the next highest level folder, press the [8 ▲] (UP) button in the File Selection display.

#### ⚠ CAUTION

The purchased data will be lost if you turn the power to the instrument off during download.

- When a SmartMedia card is not inserted to the instrument during purchase:  
The downloaded data is saved in the “MyDownloads” folder in the User tab display of the File Selection display. To close the folder and call up the next highest level folder, press the [8▲] (UP) button in the File Selection display.

## Saving Bookmarks of Your Favorite Pages

You can “bookmark” the page you’re viewing, and set up a custom link so the page can be instantly called up in the future.

- 1 With the desired page currently selected, press the [6▲] (BOOK-MARK) button. The Bookmark display appears, showing a list of the currently saved bookmarks.  
The title of the currently selected web page is shown below the list.
- 2 Call up the display for registering bookmarks by pressing the [3▲▼] (ADD) button.

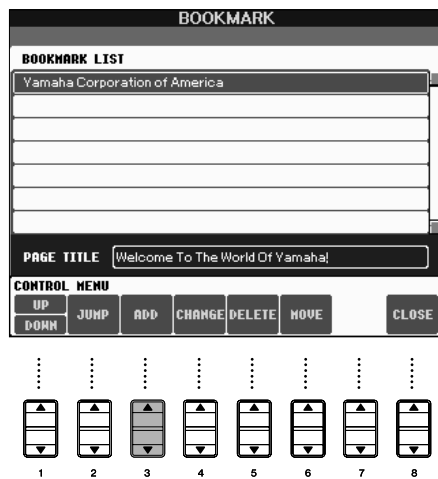

- 3 Select the position of the new bookmark by pressing the [1▲▼] (UP/DOWN) button.

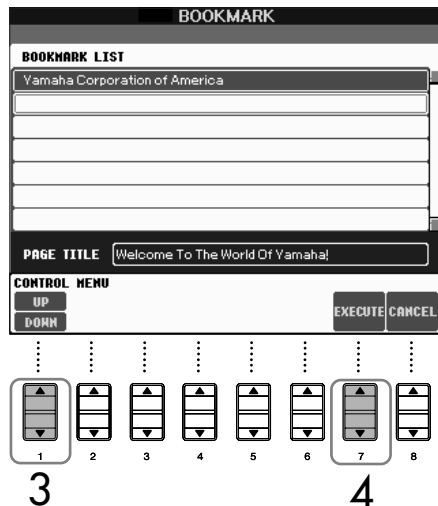

4 To save the bookmark, press the [7▲▼] (EXECUTE) button, or press the [8▲▼] (CANCEL) button to cancel.

5 To return to the browser, press the [8▲▼] (CLOSE) button.

**Opening a Bookmarked Page**

1 Press the [6▲] (BOOKMARK) button to call up the Bookmark display.

2 Press the [1▲▼] (UP/DOWN) button to select the desired bookmark.

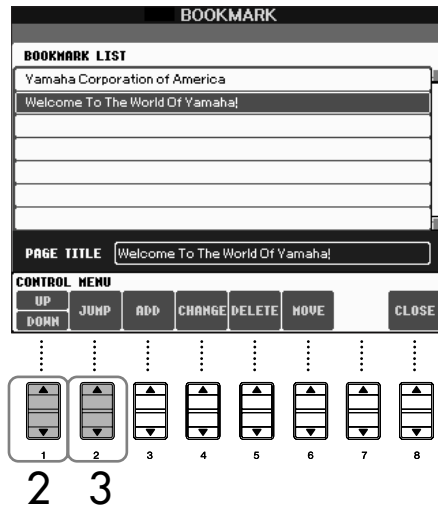

3 Press the [2▲▼] (JUMP) button to open the page of the selected bookmark.

## Editing Bookmarks

From the Bookmark display, you can change the names and rearrange the order of your bookmarks, as well as delete unnecessary bookmarks from the list.

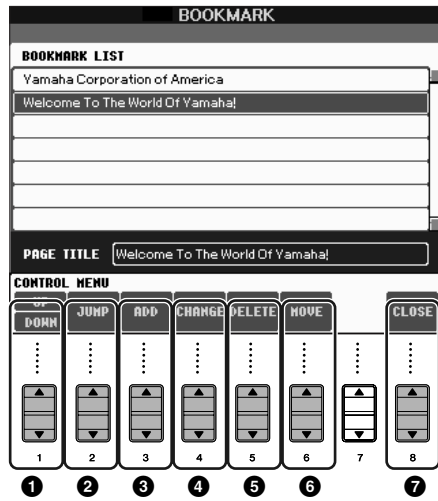

### 1 Cursor up/down

Moves the selection position in the Bookmark list.

### 2 Jump

Opens the web page of the selected bookmark.

### 3 Add

Used when saving a bookmark (page 171).

### 4 Changing names

Changes the name of the selected bookmark. Pressing the [4 ▲ ▼] (CHANGE) button calls up the display for entering characters. For details on entering characters, see page 168.

### 5 Delete

Deletes the selected bookmark from the Bookmark list.

### 6 Move

Changes the order of the bookmarks.

#### 1 Select the bookmark you wish to move, then press the [6 ▲ ▼] (MOVE) button.

The lower part of the display changes, letting you select the new position for the bookmark.

#### 2 Select the intended position by pressing the [1 ▲ ▼] (UP/DOWN) button.

#### 3 Move the bookmark to the selected position by pressing the [7 ▲ ▼] (EXECUTE) button.

### 7 Close

Closes the Bookmark display and returns to the browser display.

## Changing the Home Page

In the default condition, the top page of the special Clavinova website is automatically set to be the Home page for the browser. However, you can specify any desired page on the special Clavinova website to be the Home page.

- 1 Open the page you wish to set as your new Home page.
- 2 Press the [5 ▼] (SETTING) button to call up the Internet Setting display.
- 3 Press the TAB [◀] button to select the BROWSER tab.

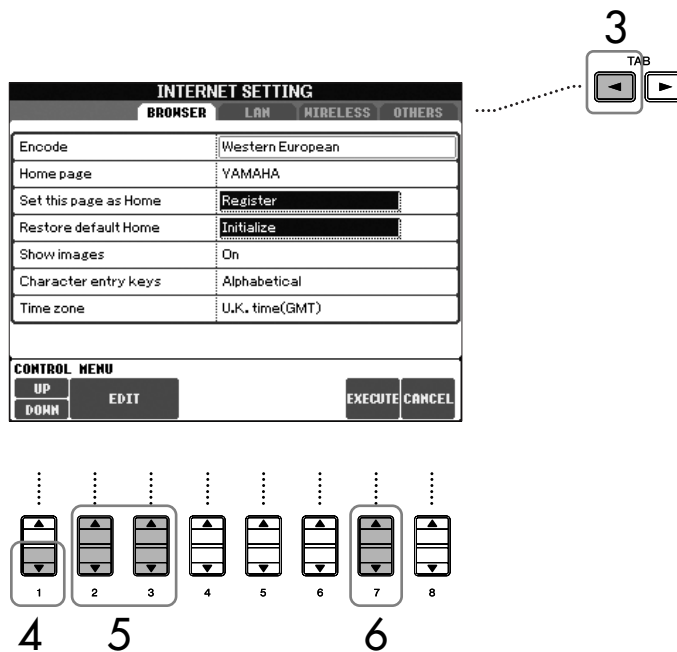

- 4 Press the [1 ▼] (DOWN) button to select the setting "Set this page as Home."
- 5 Use the [2 ▲ ▼]/[3 ▲ ▼] (EDIT) buttons to actually set the selected page as your new Home page.
- 6 To return to the browser, press the [7 ▲ ▼] (EXECUTE) button. To cancel, press the [8 ▲ ▼] (CANCEL) button.

## About the Internet Settings Display

From the Internet Settings display, you can make various settings related to the Internet connection, including preferences for the menus and displays. The Internet Settings display has four sub-displays: Browser, LAN, Wireless LAN, and Others.

### Basic Operation

- 1 Press the [5 ▼] (SETTING) button to call up the Internet Setting display.
- 2 Press the TAB [◀]/[▶] buttons to select the desired display.
- 3 Select the desired item by pressing the [1 ▲ ▼] (UP/DOWN) button.

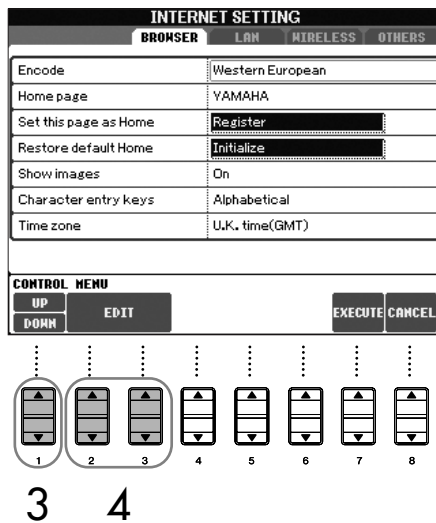

- 4 To call up the relevant Edit display, press the [2 ▲ ▼]/[3 ▲ ▼] (EDIT) button.  
For some items, the Edit display may not be shown, but the setting or change may be executed.
- 5 Press the [2 ▲ ▼] (UP/DOWN) button to select the setting or change the value.  
This can also be done by using the [DATA ENTRY] dial.

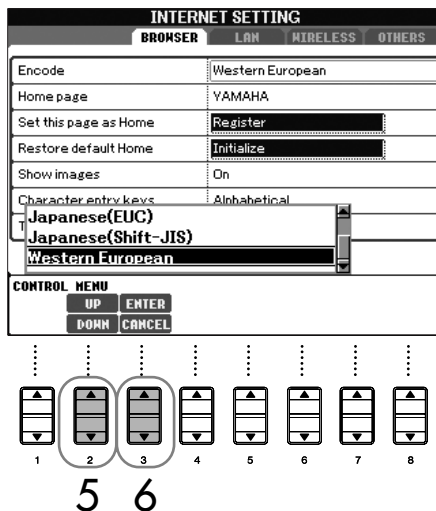

- 6 To execute the setting, press the [3 ▲] (ENTER) button. To cancel, press the [3 ▼] (CANCEL) button.

**Entering Characters**  
When the character input display is opened, you can enter characters. (Refer to “Entering Characters” on page 168.)

- 7** To actually apply all settings changed in the Internet Settings display, press the [7 ▲ ▼] (EXECUTE) button.  
To cancel, press the [8 ▲ ▼] (CANCEL) button.

### Browser

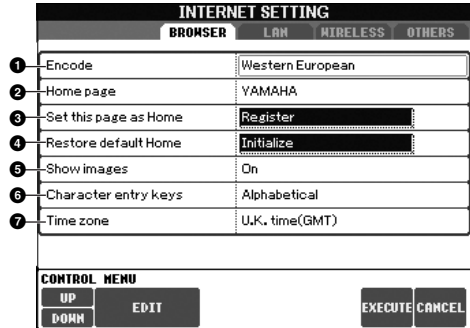

- 1 Encode**  
Selects the character code encoding for the browser.
- 2 Home Page**  
Shows and allows editing of the web page which is set as the home page.
- 3 Set this page as Home**  
For details, refer to “Changing the Home Page” on page 174.
- 4 Restore Default Home**  
Restores the home page setting.
- 5 Show images**  
Image data and pictures in the web page are shown in the browser when this is set to on. Image data is not shown when this is set to off.
- 6 Character entry keys**  
This setting lets you select the character order of the virtual keyboard for entering characters. When this is set to “Alphabetical,” the keys are in alphabetical order. When this is set to “ASCII,” the keys are arranged as a conventional “QWERTY” keyboard.
- 7 Time zone**  
This determines the time setting for the browser.

### LAN

Both the wired LAN and wireless LAN need to be set in this display.

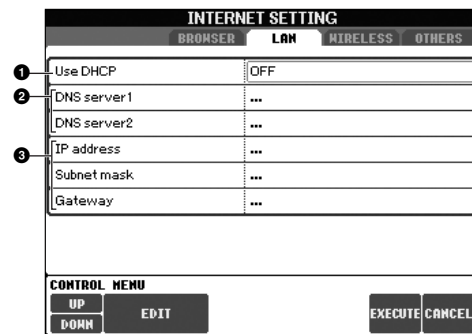

Make a written note of the settings here, in case you have to enter them again.

Use DHCP	
DNS server1	
DNS server2	
IP address	
Subnet mask	
Gateway	

- 1 Use DHCP**  
Determines whether or not DHCP is used. If your router is compatible with DHCP, select “ON.”
- 2 DNS server 1/DNS server 2**  
These determine the addresses of the primary and secondary DNS servers. These settings must be made when “Use DHCP” above is set to “ON (set DNS manually)” or “OFF.”
- 3 IP address/Subnet mask/Gateway**  
These settings are available only when DHCP is not used. The settings here are: IP address, subnet mask, and gateway server address. These settings must be made when “Use DHCP” above is set to “OFF.”



## Wireless LAN

For a wireless LAN setup, make sure to set both the LAN settings (page 176) and the Wireless LAN settings below.

INTERNET SETTING	
BROWSER LAN WIRELESS OTHERS	
1 SSID	0
2 Channel	Ch10
3 Encryption	On
4 WEP key type	Hexadecimal
WEP key length	64bit
WEP key	
CONTROL MENU	
UP	EDIT
DOWN	EXECUTE CANCEL

Make a written note of the settings here, in case you have to enter them again.

SSID	
Channel	
Encryption	
WEP key type	
WEP key length	
WEP key	

### 1 SSID

Determines the SSID setting.

### 2 Channel

Determines the channel.

### 3 Encryption

Determines whether or not the data is encrypted.

### 4 WEP key type/WEP key length/WEP key

These settings are available only when Encryption above is enabled. These set the type and length of the encryption key.

## Others

INTERNET SETTING	
BROWSER LAN WIRELESS OTHERS	
Proxy server	
1 Proxy port	8080
Non-proxy server	
2 Delete cookies	Delete
3 Delete all bookmarks	Delete
4 Initialize setup	Initialize
5 Connect information	Display information
CONTROL MENU	
UP	EDIT
DOWN	EXECUTE CANCEL

### 1 Proxy server/Proxy port/Non-proxy server

Determines the proxy server name, port number and the host name for the non-proxy server. The settings here are only necessary when using a proxy server. When using a non-proxy server, enter a separator (comma) between each server name.

### 2 Delete cookies

Deletes the contents of all saved cookies.

### 3 Delete all bookmarks

Deletes all saved bookmarks.

### 4 Initialize setup

Restores all settings in the Internet Settings displays to their defaults. See "Initializing Internet Settings" on page 178.

### 5 Connection information

Shows detailed information on the current connection.

## Initializing Internet Settings

The settings of the Internet function are not initialized when using the Initialize operation of the Clavinova; Internet settings must be initialized separately, as explained here. Initializing will reset to the default values not only the settings of the browser, but also all settings you have made in the Internet Settings displays (except for the cookies and bookmarks), including those related to Internet connection.

- 1 Press the [5 ▼] (SETTING) button to call up the Internet Settings display.
- 2 Press the TAB [▶] button to select the OTHERS tab.
- 3 Press the [1 ▲ ▼] (UP/DOWN) button to select "Initialize."

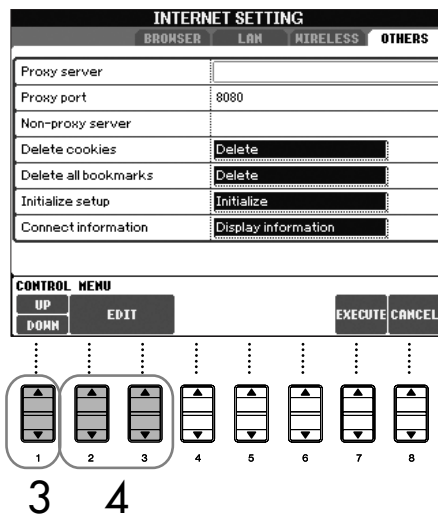

- 4 Use the [2 ▲ ▼]/ [3 ▲ ▼] (EDIT) buttons to initialize the Internet settings.

### Delete cookies/bookmarks

Cookies and bookmarks are still remain after executing the initialize operation above.

To delete the cookies or bookmarks, use the appropriate operations in the OTHERS tab display (page 177).

Cookies contain personal information.

# Glossary of Internet Terms

<b>Broadband</b>	An Internet connection technology/service (such as ADSL and optical fiber) that allows for high-speed, high-volume data communication.
<b>Browser</b>	The software used to search for, access, and view web pages. For this instrument, this refers to the display that shows the contents of the web pages.
<b>Cookie</b>	A system that records certain information that the user transfers when visiting a website and using the Internet. The function is similar to a preference file in a conventional computer program, in that it “remembers” certain information such as your user name and password, so you don’t have to re-enter the information each time you visit the site.
<b>DHCP</b>	This is a standard or protocol by which IP addresses and other low-level network configuration information can be dynamically and automatically assigned each time connection is made to the Internet.
<b>DNS</b>	A system that translates names of computers connected to a network to their corresponding IP addresses.
<b>Download</b>	Transferring data over a network, from a larger “host” system to a smaller “client” system’s hard drive or other local storage device—much like copying files from your hard disk drive to a floppy disk. For this instrument, this refers to the process of transferring Song and other data from a website to the instrument.
<b>Gateway</b>	A system which links different networks or systems, and makes possible data transfer and conversion despite differing communications standards.
<b>Home page</b>	The first page shown when opening a browser and connecting to the Internet. This phrase is also used to mean the “front screen” or top page of a website.
<b>Internet</b>	A huge network made up of networks, the Internet allows high-speed data transfer among computers, mobile phones and other devices.
<b>IP address</b>	A string of numbers assigned to each computer connected to a network, and indicating the device’s location on the network.
<b>LAN</b>	Short for Local Area Network, this is a data-transfer network that connects a group of computers at a single location (such as an office or home) by means of a special cable.
<b>Link</b>	A highlighted word, button or icon within a web page that, when clicked, opens another web page.
<b>Modem</b>	A device which connects and allows data transfer between a conventional telephone line and a computer. It converts the digital signals from the computer to analog audio for sending over the phone line, and vice versa.
<b>NTP</b>	Short for Network Time Protocol, a standard for setting the internal system clock of the computer over a network. For this instrument, the internal clock of the computer is used to specify the valid time/date for cookies and SSL.
<b>Provider</b>	A communications business that offers Internet connection services. In order to connect to the Internet, it is necessary to contract to a provider.
<b>Proxy</b>	A proxy server is a server that all computers on a local network have to go through before accessing information on the Internet. It intercepts all or designated requests to the real server to see if it can fulfill the requests itself. If not, it forwards the request to the real server. Proxy servers are used to improve performance and speed, and to filter requests, usually for security and to prevent unauthorized access to an internal network.
<b>Router</b>	A device for connecting multiple computer networks. For example, a router is necessary when connecting several computers in a house or office, and allow them to all access the Internet and share data. A router is usually connected between a modem and a computer, although some modems have a built-in router.
<b>Server</b>	A hardware system or computer used as a central point for a network, providing access to files and services.
<b>Site</b>	Short for “website,” this refers to the group of web pages that are opened together. For example, the collection of web pages whose addresses begin with “http://www.yamaha.com/” is referred to as the Yamaha site.
<b>SSID</b>	This is an identification name for specifying a particular network over a wireless LAN connection. Communication is possible only between terminals with matching SSID names.
<b>SSL</b>	Short for Secure Sockets Layer, a standard for transmitting confidential data such as credit card numbers over the Internet.
<b>Subnet mask</b>	A setting used to divide a large-scale network into several smaller networks.
<b>URL</b>	Short for Uniform Resource Locator, a string of characters used to identify and link to specific websites and pages on the Internet. A complete URL usually starts with the characters “http://.”
<b>Web page</b>	Refers to each individual page that makes up a website.
<b>Wireless LAN</b>	A LAN connection that allows data transfer through a wireless, cable-free connection.

# Using Your Instrument with Other Devices

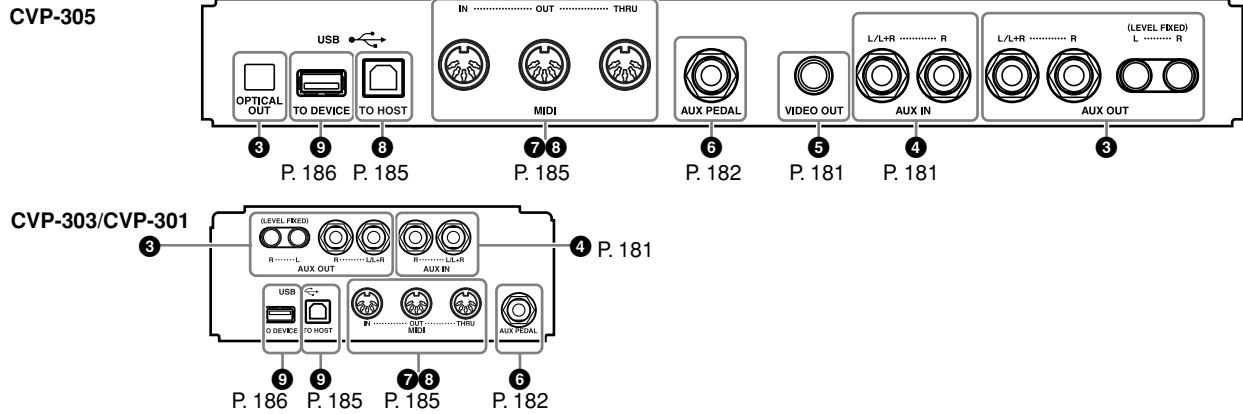

**CAUTION**  
Before connecting the instrument to other electronic components, turn off the power of all the components. Also, before turning any components on or off, make sure to set all volume levels to minimum (0). Otherwise, electrical shock or damage to the components may occur.

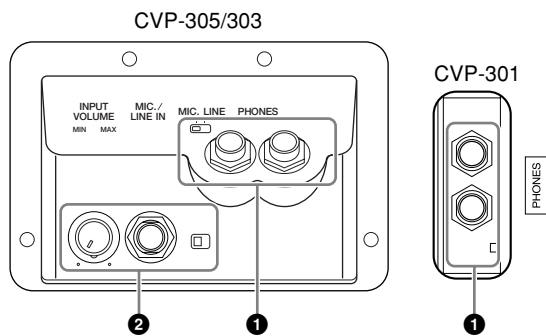

## 1 Using Headphones ([PHONES] jacks)

Connect a pair of headphones to one of the [PHONES] jacks (standard 1/4" phone jacks) located on the leftward underside of the instrument. For details, see page 17.

## 2 Connecting a Microphone or Guitar ([MIC./LINE IN] jack) (CVP-305/303)

By connecting a microphone to the [MIC./LINE IN] jack (standard 1/4" phone jack) located on the left underside of the instrument, you can enjoy singing along with Song playback (KARAOKE) or with your own performance. The instrument outputs your vocals or guitar sounds through the built-in speakers. For instructions on connecting, see page 52. Please note that when connecting devices of high output level, make sure to set the [MIC. LINE] switch to "LINE."

## 3 4 5 Connecting Audio & Video Devices

**NOTE**  
Use audio cables and adaptor plugs having no (zero) resistance.

## 3 Using External Audio Devices for playback and Recording ([AUX OUT] Jacks, [AUX OUT (LEVEL FIXED)] Jacks, [OPTICAL OUT] Jack)

You can connect these jacks to a stereo system to amplify the instrument's sound or to a cassette tape recorder or a digital audio device for recording your performance. The microphone or guitar sound connected to the instrument's [MIC./LINE IN] jack (CVP-305/303) is output at the same time. Refer to the diagrams below and use audio cables for connection. These jacks are located on the underside jacks panel of the instrument.

**CAUTION**  
When the instrument's sound is output to an external device, first turn on the power to the instrument, then to the external device. Reverse this order when you turn the power off.  
Do not route the output from the [AUX OUT] [AUX OUT (LEVEL FIXED)] jacks to the [AUX IN] jacks. If you make this connection, the signal input at the [AUX IN] jacks is output from the [AUX OUT] [AUX OUT (LEVEL FIXED)] jacks. These connections could result in a feedback loop that will make normal performance impossible, and may even damage both pieces of equipment.

### [AUX OUT] Jacks

(Standard phone jacks of [L/L+R] and [R])

When these are connected, you can use the instrument's [MASTER VOLUME] control to adjust the volume of the sound output to the external device. Connect the instrument's AUX OUT [L/L+R]/[R] jacks and the input jacks of a pair of powered speakers using appropriate audio cables. Use only the [L/L+R] jack for connection with a monaural device.

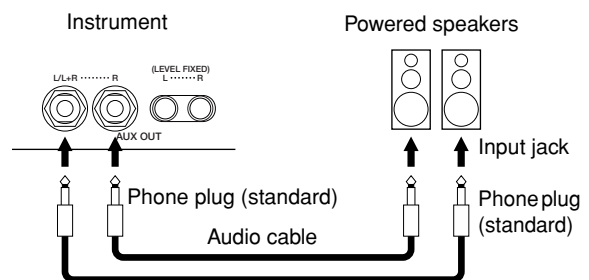

### [AUX OUT (LEVEL FIXED)] Jacks

(RCA pin jacks of [L] and [R])

When these are connected (with RCA pin plug; LEVEL FIXED), the sound is output to the external device at a fixed level, regardless of the [MASTER VOLUME] control setting. Use these when controlling volume with an external audio system, or recording the instrument's sound to an external audio system. Connect the instrument's AUX OUT [L]/[R] (LEVEL FIXED) jacks and the AUX IN jacks of an external audio system using appropriate audio cables.

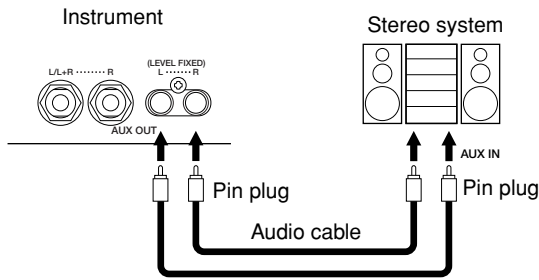

### [OPTICAL OUT] Terminal (CVP-305)

This is used for optical output of digital audio (frequency: 44.1 kHz) for highest sound quality. The output level from the [OPTICAL OUT] terminal is fixed and is unaffected by the master volume control on the instrument. Use an appropriate optical cable to connect this terminal to the optical digital input terminal of a minidisk (MD) recorder or CD recorder. (Make sure the connectors of the cable match the terminals on both devices.)

Since digital transfer allows you record a clear, noise-free signal with no degradation or distortion, you can record your favorite performances with the highest possible quality.

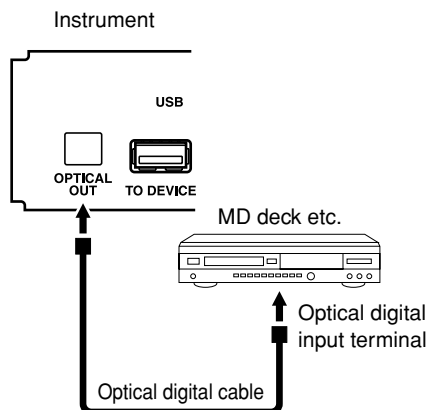

### 4 Playing External Audio Devices with the Built-in Speakers ([AUX IN] Jacks)

The stereo outputs from another instrument can be connected to these jacks, allowing the sound of an external instrument to be reproduced via the instrument's speakers. Connect the output jacks (LINE OUT etc.) of an external synthesizer or the tone generator module and the instrument's AUX IN [L/L+R]/[R] jacks using appropriate audio cables.

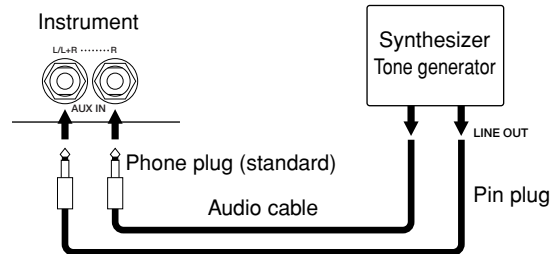

**CAUTION**  
When the sound of an external device is output to the instrument, first turn on the power to the external device, then to the instrument. Reverse this order when you turn the power off.

#### NOTE

- Use only the [L/L+R] jack for connection with a monaural device.
- The instrument's [MASTER VOLUME] setting affects the input signal from the [AUX IN] jacks.

### 5 Showing the Instrument's Display Contents on a Separate TV Monitor (CVP-305)

Connect the instrument to an external TV monitor, and you can have the current display contents or lyrics (for group sing-alongs and the like) displayed on the TV. For instructions on connecting, see page 53.

#### Video out settings

- 1 Call up the operation display.  
[FUNCTION] → [G] VIDEO OUT
- 2 Select the video equipment standard "NTSC" or "PAL" by using the [1 ▲ ▼] button. Select the contents of the Video Out signal—the current display contents (LCD) or lyrics (LYRICS)—by using the [3 ▲ ▼]/[4 ▲ ▼] buttons.

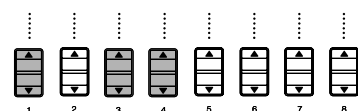
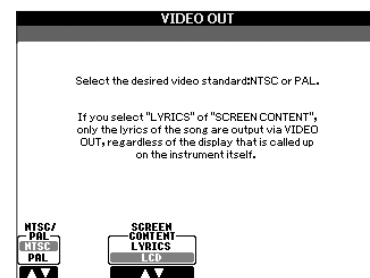

**NOTE**

- Set the NTSC or PAL to correspond to the standard used by your video equipment.
- When LYRICS is selected as the contents of the Video Out signal, only the lyrics of the song are output via VIDEO OUT, regardless of the display that is called up on the instrument.
- Avoid looking at the television or video monitor for prolonged periods of time since doing so could damage your eyesight. Take frequent breaks and focus your eyes on distant objects to avoid eyestrain.

## 6 Using the Footswitch or Foot Controller ([AUX PEDAL] jack)

By connecting a Foot Controller or Footswitch to the [AUX PEDAL] jack, you can have convenient control over various user-assignable functions. For example, connecting the Foot controller FC7 and assigning it the volume control function allows you to add expression to your performance by controlling the volume level of the notes you play. Or by connecting the FC4 or FC5 footswitch and assigning it to the Style playback start/stop function, you can start and stop the Style with your foot. (In this case, the pedal has the same function as the panel STYLE CONTROL [START/STOP] button.) The assignable functions are listed following the instructions below.

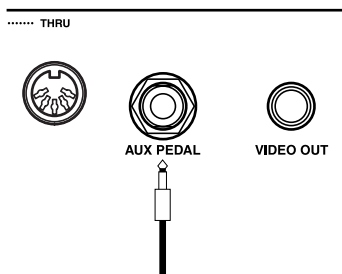

Foot Pedals



**CAUTION**

Make sure to connect or disconnect the pedal only when the power is off.

## Assigning Specific Functions to Each Foot Pedal

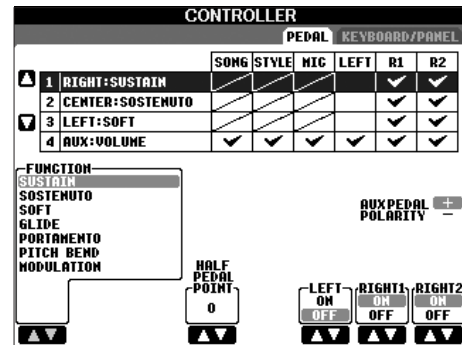

In addition to the footswitch or foot controller, the three piano pedals installed to the instrument (Right, Center and Left pedals) can also be assigned to various functions here. The following explanations cover the related operations and assignable functions (parameters).

- 1 **Call up the operation display.**  
[FUNCTION] → [D] CONTROLLER → TAB [◀] PEDAL
- 2 **Use the [A]/[B] buttons to select one of the three pedals or the AUX-connected pedal, to which the function is to be assigned.**
- 3 **Use the [1 ▲ ▼] button to select the functions to be assigned to the pedal specified in step 2.**  
Details on the pedal functions are listed below.
- 4 **Use the [2 ▲ ▼]–[8 ▲ ▼] buttons to set the details of the selected functions.**  
The available parameters differ depending on the function selected in step 3. Details on the parameters are given below.
- 5 **Check that the desired function is controllable with the pedal by actually pressing the pedal.**

**Set the polarity of the pedal**

Pedal on/off operation may differ depending on the particular pedal you've connected to the instrument. For example, pressing down on one pedal may turn the selected function on, while pressing a different make/brand of pedal may turn the function off. If necessary, use this setting to reverse the control. Press the [I] (AUX PEDAL POLARITY) button to switch the polarity.

Details on the pedal functions are listed here. For functions indicated with “\*”, use only the foot controller; proper operation cannot be done with a footswitch.

**Assignable Pedal Functions**

<b>VOLUME*</b>	Allows you to use a foot controller to control the volume. This function is available only for the pedal connected to the instrument's [AUX PEDAL] jack.
<b>SUSTAIN</b>	Allows you to use a pedal to control the sustain. When you press and hold the pedal, all notes played on the keyboard have a longer sustain. Releasing the pedal immediately stops (damps) any sustained notes.
<b>SOSTENUTO</b>	Allows if you play a note or chord on the keyboard and press the pedal while holding the note(s), the notes will sustain as long as the pedal is held. However, all subsequent notes will not sustain. This makes it possible to sustain a chord, for example, while other notes are played staccato.
<b>SOFT</b>	Allows you to use a pedal to control the Soft effect. Pressing this pedal reduces the volume and changes the timbre of the notes you play. This is effective only for certain appropriate Voices.
<b>GLIDE</b>	When the pedal is pressed, the pitch changes, and then returns to normal pitch when the pedal is released.
<b>PORTAMENTO</b>	The portamento effect (a smooth slide between notes) can be produced while the pedal is pressed. Portamento is produced when notes are played legato style (i.e., a note is played while the preceding note is still held). Portamento Time can also be adjusted from the Mixing Console (page 82). This function does not affect certain Natural Voices, which would not sound appropriately with this function.
<b>PITCH BEND*</b>	Allows you to bend the pitch of notes up or down by using the pedal. This can only be set to the right pedal or the pedal connected to the instrument's [AUX PEDAL] jack.
<b>MODULATION*</b>	Applies a vibrato effect to notes played on the keyboard. The depth of the effect increases while pedal is pressed. This can only be set to the right pedal or the pedal connected to the instrument's [AUX PEDAL] jack.
<b>DSP VARIATION</b>	Switches Voice Effect DSP VARIATION on and off.
<b>VIBE ROTOR ON/OFF</b>	Switches the VIBRATE SW parameter on and off when the VIBE VIBRATE effect type is selected.
<b>HARMONY/ECHO</b>	Switches the HARMONY/ECHO Voice Effect on and off.
<b>VOCAL HARMONY (CVP-305/303)</b>	Switches the Vocal Harmony function on and off.
<b>TALK (CVP-305/303)</b>	Switches the MIC SETTING Talk function on and off.
<b>SCORE PAGE+</b>	While the song is stopped, you can turn to the next score page.
<b>SCORE PAGE-</b>	While the song is stopped, you can turn to the previous score page.
<b>SONG PLAY/PAUSE</b>	Same as the SONG [PLAY/PAUSE] button.
<b>STYLE START/STOP</b>	Same as the STYLE CONTROL [START/STOP] button.
<b>TAP TEMPO</b>	Same as the [TAP] button.
<b>SYNCHRO START</b>	Same as the [SYNC START] button.
<b>SYNCHRO STOP</b>	Same as the [SYNC STOP] button.
<b>INTRO1-3</b>	Same as the [INTRO I-III] buttons.
<b>MAIN A-D</b>	Same as the [MAIN VARIATION A-D] buttons.
<b>FILL DOWN</b>	Plays a fill-in, which is automatically followed by the Main section of the button on the immediate left.
<b>FILL SELF</b>	Plays a fill-in.
<b>FILL BREAK</b>	Plays a break.
<b>FILL UP</b>	Plays a fill-in, which is automatically followed by the Main section of the button on the immediate right.
<b>ENDING1-3</b>	Same as the [ENDING/rit. I-III] buttons.
<b>FADE IN/OUT</b>	Same as the [FADE IN/OUT] button.
<b>FING/ON BASS</b>	The pedal alternately switches between the Fingered and On Bass modes (page 97).

<b>BASS HOLD</b>	While the pedal is pressed, the Accompaniment Style bass note will be held even if the chord is changed during Style playback. If the fingering is set to "AI FULL KEYBOARD," the function does not work.
<b>PERCUSSION</b>	The pedal plays a percussion instrument selected by the [4 ▲ ▼]–[8 ▲ ▼] buttons. You can use the keyboard to select the desired percussion instrument.
<b>RIGHT1 ON/OFF</b>	Same as the PART ON/OFF [RIGHT 1] button.
<b>RIGHT2 ON/OFF</b>	Same as the PART ON/OFF [RIGHT 2] button.
<b>LEFT ON/OFF</b>	Same as the PART ON/OFF [LEFT] button.
<b>OTS+</b>	Calls up the next One Touch Setting.
<b>OTS–</b>	Calls up the previous One Touch Setting.

**NOTE** The Sostenuto and Portamento functions will not affect the Organ Flute Voices, even they have been assigned to the Foot Pedals.

### Adjustable Parameters for Each Function

The parameters below correspond to buttons [2 ▲ ▼]–[8 ▲ ▼], and their availability depends on the selected control type. For example, if SUSTAIN is selected as the type, the parameters "HALF PEDAL POINT," "RIGHT 1," "RIGHT 2" and "LEFT" automatically appear in the display.

<b>SONG, STYLE, MIC, LEFT, RIGHT1, RIGHT2</b>	These specify the part(s) that will be affected by the pedal.
<b>HALF PEDAL POINT*</b>	You can specify how far down you should press on the pedal until the damper or soft effect (page 183) starts working. This can only be set to the right pedal, and the pedal connected to the instrument's [AUX PEDAL] jack.
<b>DEPTH</b>	Determines the depth of the pedal effect.
<b>UP/DOWN</b>	When GLIDE or PITCH BEND is selected, this determines whether the pitch change is raised or lowered.
<b>RANGE</b>	When GLIDE or PITCH BEND is selected, this determines the range of the pitch change, in semitones. Linked to the Mixing Console → Pitch Bend Range (page 82) setting.
<b>ON SPEED</b>	When GLIDE is selected, this determines the speed of the pitch change, when the pedal is pressed.
<b>OFF SPEED</b>	When GLIDE is selected, this determines the speed of the pitch change, when the pedal is released.
<b>KIT</b>	When PERCUSSION is assigned to the pedal, all available drum kits are shown here, letting you select the particular drum kit used for the pedal.
<b>PERCUSSION</b>	When PERCUSSION is assigned to the pedal, all sounds of the selected drum kit (in KIT above) are shown here. This determines the particular instrument sound assigned to the pedal.



## 7 Connecting External MIDI Devices ([MIDI] Terminals)

Use the built-in [MIDI] terminals and standard MIDI cables to connect external MIDI devices.

<b>MIDI IN</b>	Receives MIDI messages from an external MIDI device.
<b>MIDI OUT</b>	Transmits MIDI messages generated by the instrument.
<b>MIDI THRU</b>	Simply relays the MIDI messages received at MIDI IN.

For a general overview of MIDI and how you can effectively use it, refer to the following sections:

- What is MIDI?.....page 188
- What You Can Do With MIDI.....page 191
- MIDI Settings.....page 192

## 8 Connecting a Computer or USB Device

### 8 Connecting a Computer ([USB TO HOST] and [MIDI] Terminals)

By connecting a computer to the [USB TO HOST] or [MIDI] terminals, you can transfer data between the instrument and the computer via MIDI, and take advantage of sophisticated computer music programs. Keep in mind that you also need to install an appropriate USB MIDI driver.

The instructions below explain how to connect and use the terminals.

#### NOTE

If you are using a computer that has a USB interface, we recommend that you connect the computer and the instrument by USB, rather than by MIDI.

#### NOTE

##### Driver

A driver is software that provides a data-transfer interface between the computer's operating system and a connected hardware device. You need to install a USB MIDI driver to connect the computer and the instrument.

This explanation is divided into two parts, covering the two connections: connection to the [USB TO HOST] terminal and connection to the [MIDI] terminal.

#### • Connecting to the [USB TO HOST] terminal

When connecting the instrument to the computer via USB, use a standard USB cable (having the USB logo) to connect the [USB TO HOST] terminal on the instrument to the USB terminal of the computer. Then, install the USB MIDI driver.

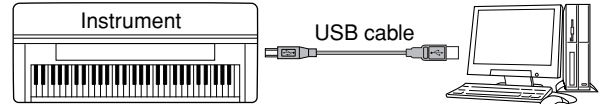

#### NOTE

##### About the [USB TO HOST] and [USB TO DEVICE] terminals

There are two different types of USB terminals on the instrument: [USB TO HOST] and [USB TO DEVICE]. Take care not to confuse the two terminals and the corresponding cable connectors.

Be careful to connect the proper plug in the proper direction.

Explanations on the [USB TO DEVICE] terminal follow in the next section.

#### CAUTION

##### Precautions when using the [USB TO HOST] terminal

When connecting the computer to the [USB TO HOST] terminal, make sure to observe the following points. Failing to do so risks freezing the computer and corrupting or losing data. If the computer or the instrument freezes, turn the power to the instrument off and restart the computer.

- Before connecting the computer to the [USB TO HOST] terminal, exit from any power-saving mode of the computer (such as suspended, sleep, standby), and quit any open application software, also turns off the power to the instrument.
- Execute the following before turning the power to the instrument off or unplugging the USB cable to/from the instrument/computer.
  - Quit any open application software on the computer.
  - Make sure that data is not being transmitted from the instrument. (Data is transmitted only by playing notes on the keyboard or playing back a song.)
- **While a USB device is connected to the instrument, you should wait for six seconds or more between these operations: When turning the power of the instrument off then on again, or when alternately connecting/disconnecting the USB cable.**

#### NOTE

- The instrument will begin transmission a short time after the USB connection is made.
- When using a USB cable to connect the instrument to your computer, make the connection directly without passing through a USB hub.
- For information on setting up your sequence software, refer to the owner's manual of the relevant software.

• **Connection by [MIDI] terminals**

There are two ways to connect the instrument via MIDI to a computer. If you have a MIDI interface built into your computer, connect the MIDI OUT terminal of the computer interface to the [MIDI IN] terminal of the instrument, and connect the [MIDI OUT] terminal of the instrument to the MIDI IN terminal of the interface.

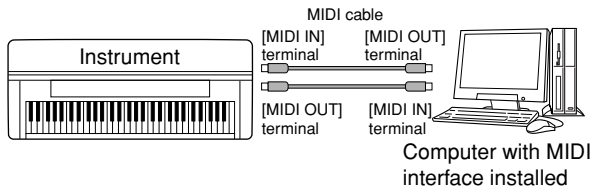

The second connection possibility involves a separate, external MIDI interface connected to the computer via a USB port or a serial port (modem or printer terminal). Using standard MIDI cables, connect the MIDI OUT terminal of the external interface to the [MIDI IN] terminal of the instrument, and connect the [MIDI OUT] terminal of the instrument to the MIDI IN terminal of the interface.

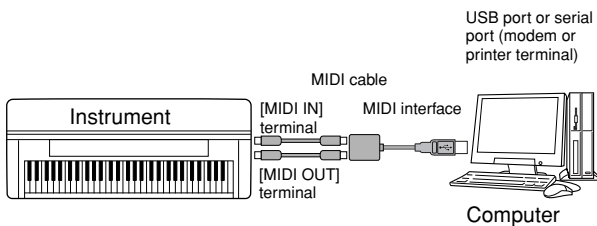

**NOTE**

Make sure to use the appropriate MIDI interface for your computer.

**9 Connecting to a USB-type LAN Adaptor and USB Storage Device (via the [USB TO DEVICE] Terminal)**

There are two ways of using the [USB TO DEVICE] terminal on the bottom panel of the instrument.

- By connecting the USB-type LAN adaptor, you can directly access special Internet websites for downloading music data (page 166).
- By connecting the instrument to a USB storage device with a standard USB cable, you can save data you've created to the connected device, as well as read data from the connected device.

**NOTE**

**About the [USB TO HOST] and [USB TO DEVICE] terminals**  
There are two different types of USB terminals on the instrument: [USB TO HOST] and [USB TO DEVICE]. Take care not to confuse the two terminals and the corresponding cable connectors. Be careful to connect the proper plug in the proper direction. Explanations on the [USB TO HOST] terminal can be found in the previous section.

**Using USB Storage Devices**

This type is used to connect the instrument to a USB storage device, and allows you to save data you've created to the connected device, as well as read data from the connected device. The following description generally explains about how to connect and use them.

• **Compatible USB storage devices**

Up to two USB storage devices, such as a floppy disk drive, hard disk drive, CD-ROM drive, flash memory reader/writer, etc., can be connected to the [USB TO DEVICE] terminal. (If necessary, use a USB hub.)

Other USB devices such as a computer keyboard or mouse cannot be used. The instrument does not necessarily support all commercially available USB storage devices. Yamaha cannot guarantee operation of USB storage devices that you purchase. Before purchasing USB storage devices, please consult your Yamaha dealer, or an authorized Yamaha distributor (see list at end of the Owner's Manual) for advice, or see the following web page:  
<http://www.yamahaclavinova.com/>

**NOTE**

**CD-ROM drive**

Although CD-R/RW drives can be used to read data to the instrument, they cannot be used for saving data.

- 1 **Connect the USB storage device to the [USB TO DEVICE] terminal with a standard USB cable.**
- 2 **After that, exit once from the selection display then return to the display (or press the Tab switch buttons [◀] and [▶] simultaneously from the selection display). The USB tabs (USB 1, USB 2, etc.) are automatically called up, allowing you to save files and play back music data from the devices.**

**NOTE**

**USB hub**

If you are connecting two or three devices at the same time (such as two USB storage devices and a LAN adaptor), use a USB hub device. The USB hub must be self-powered (with its own power source) and the power must be on. Only one USB hub can be used. If an error message appears while using the USB hub, disconnect the hub from the instrument, then turn on the power of the instrument and re-connect the USB hub.

**NOTE**

**About the USB Tabs**

The tabs indicating the connected USB devices (USB 1, USB 2, etc.) may be displayed up to USB 20 for each device or partition. The numbers are not fixed and may change according to the order in which the devices are connected and disconnected.

**NOTE**

**Checking remaining memory on the USB storage device**  
 You can check this in the display called up by the following operation:  
 [FUNCTION] → [I] UTILITY → TAB [◀]/[▶] MEDIA  
 Select the device by using the [A]/[B] buttons in this display and press [F] (PROPERTY).

**Formatting USB storage media**  
 When a USB storage device is connected or media is inserted, a message may appear prompting you to format the device/media. If so, execute the Format operation (page 62).

**CAUTION**  
 The format operation overwrites any previously existing data. Proceed with caution.

**CAUTION**  
 Avoid frequently turning the power on/off to the USB storage device, or connecting/disconnecting the cable too often. Doing so may result in the operation of the instrument “freezing” or hanging up. While the instrument is accessing data (such as in the Save, Copy and Delete operations), do NOT unplug the USB cable, do NOT remove the media from the device, and do NOT turn the power off to either device. Doing so may corrupt the data on either or both devices.

**To protect your data (write-protect):**  
 To prevent important data from being inadvertently erased, apply the write-protect provided with each storage device or media. If you are saving data to the USB storage device, make sure to disable write-protect.

**NOTE**  
 Even with a computer connected to the [USB TO HOST] terminal and a USB storage device connected to the [USB TO DEVICE] terminal, you cannot access the USB storage device from the computer via the instrument.

**NOTE**  
 Though the instrument supports the USB 1.1 standard, you can connect and use a USB 2.0 storage device with the instrument. However, note that the transfer speed is that of USB 1.1.

**Backing up your data to a computer**

**Backing up the instrument data to a computer**

Once you’ve saved data to a SmartMedia card or USB storage device, you can copy the data to the hard disk of your computer, then archive and organize the files as desired. Simply reconnect the device as shown below.

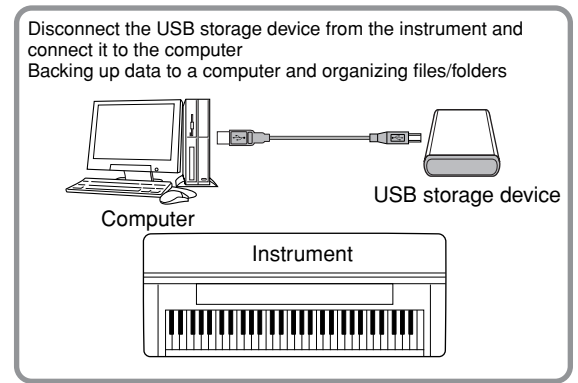
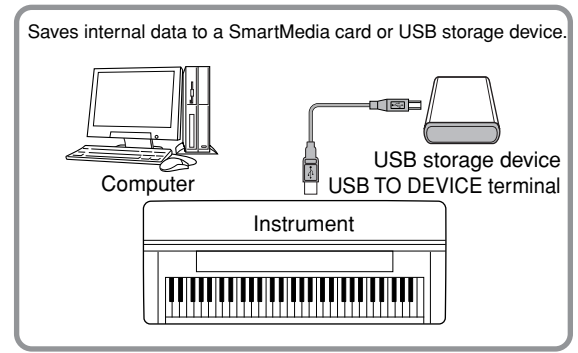

**NOTE**  
 Though the example here shows the use of a connected USB storage device, you can also back up your created data that you’ve saved to a SmartMedia card inserted to the CARD slot.

**Copying files from a computer hard disk to a USB storage device**

Files contained on the hard disk of a computer can be transferred to the instrument by first copying them to the storage media, then connecting/inserting the media to the instrument.

Not only files created on the instrument itself but also Standard MIDI files and Style File-formatted Style files created on other devices can be copied to SmartMedia card or a USB storage device from the hard disk of the computer. Once you've copied the data, insert the card into the Card slot or connect the device to the [USB TO DEVICE] terminal of the instrument, and play back the data on the instrument.

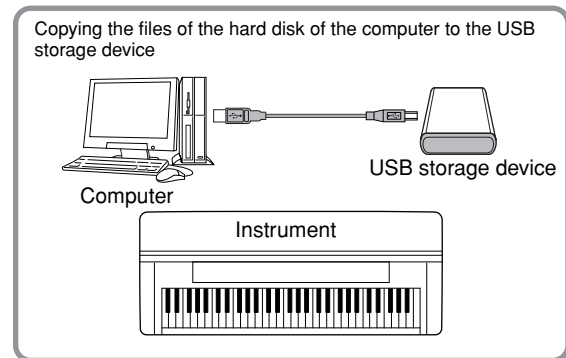

Disconnect the USB storage device from the computer and connect it to the instrument

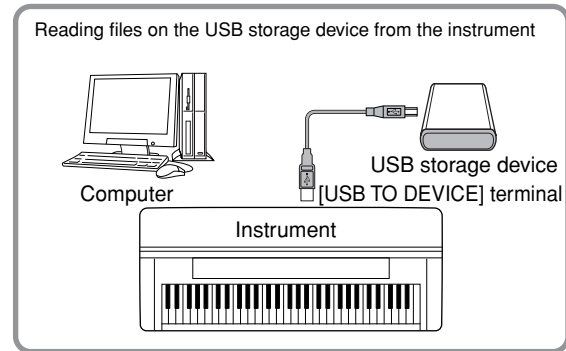

**What is MIDI?**

Put simply, MIDI is a data transfer standard that allows easy and comprehensive control among electronic/digital music instruments and other devices. To get a better idea of what MIDI does, let's first consider acoustic instruments, such as a grand piano and a classical guitar. With the piano, you strike a key, and a hammer inside hits some strings and plays a note. With the guitar, you directly pluck a string and the note sounds. But how does a digital instrument go about playing a note?

**Acoustic guitar note production**

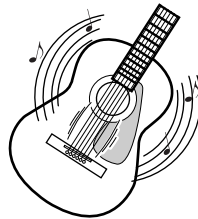

Pluck a string and the body resonates the sound.

**Digital instrument note production**

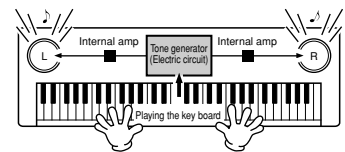

Based on playing information from the keyboard, a sampling note stored in the tone generator is played through the speakers.

As shown in the illustration above, in an electronic instrument the sampling note (previously recorded note) stored in the tone generator section (electronic circuit) is played based on information received from the keyboard.

Now, let's examine what happens when we playback a recording. When you play back a music CD (for example, a solo piano recording), you're hearing the actual sound (vibration in air) of the acoustic instrument. This is called audio data, to distinguish it from MIDI data.

**Recording and playing back the performance of an acoustic instrument (audio data)**

Recording

Playback

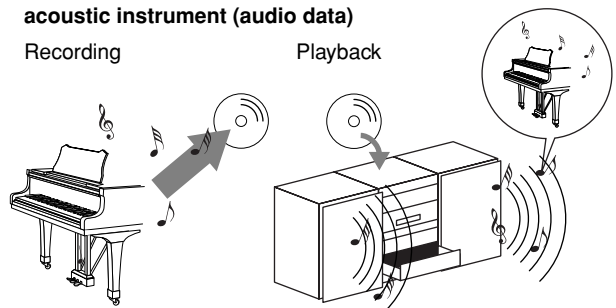

In the above example, the actual acoustic sounds of the pianist's performance are captured in the recording as audio data, and this is recorded to CD. When you play back that CD on your audio system, you can hear the actual piano performance. The piano itself is not necessary, since the recording contains the actual sounds of the piano, and your speakers reproduce them.

**Recording and play back the performance of a digital instrument (MIDI data)**

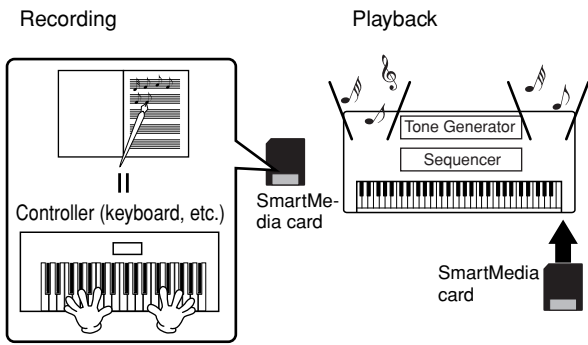

**NOTE**

In the case of digital instruments, the audio signals are sent through output jacks (such as [AUX OUT]) on the instrument.

The “controller” and “tone generator” in the illustration above are equivalent to the piano in our acoustic example. Here, the player’s performance on the keyboard is captured as MIDI song data (see illustration below). In order to record the audio performance on an acoustic piano, special recording equipment is needed. However, since the Clavinova features a built-in sequencer that lets you record performance data, this recording equipment is unnecessary. Instead, your digital instrument—the Clavinova—allows you to both record and play back the data.

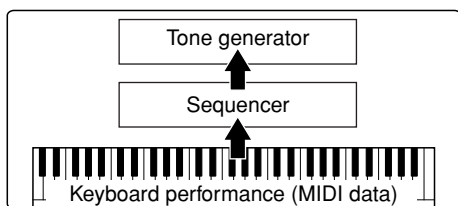

However, we also need a sound source to produce the audio, which eventually comes from your speakers. The tone generator of the Clavinova fills this function. The recorded performance is reproduced by the sequencer, playing back the song data, using a tone generator capable of accurately producing various instrument sounds—including that of a piano. Looked at in another way, the relation of the sequencer and the tone generator is similar to that of the pianist and the piano—one plays the other. Since digital instruments handle playback data and the actual sounds independently, we can hear our piano performance played by another instrument, such as guitar or violin.

**NOTE**

Even though it is a single musical instrument, the Clavinova can be thought of as containing several electronic components: a controller, a tone generator, and a sequencer.

Finally, we’ll take a look at the actual data that gets recorded and that serves as the basis for playing the sounds. For example, let’s say you play a “C” quarter note using the grand piano sound on the Clavinova keyboard. Unlike an acoustic instrument that puts out a resonated note, the electronic instrument puts out information from the keyboard such as “with what voice,” “with which key,” “about how strong,” “when was it pressed” and “when was it released.” Then each piece of information is changed into a number value and sent to the tone generator. Using these numbers as a basis for sound generation, the tone generator plays the stored sampled note.

**Example Keyboard Data**

<b>Voice number (with what voice)</b>	01 (grand piano)
<b>Note number (with which key)</b>	60 (C3)
<b>Note on (when was it pressed) and note off (when was it released)</b>	Timing expressed numerically (quarter note)
<b>Velocity (strength at which it was played)</b>	120 (strong)

Panel operations on the Clavinova, such as playing the keyboard and selecting voices, are processed and stored as MIDI data. The auto accompaniment Styles and Songs also consist of MIDI data.

MIDI is an acronym that stands for Musical Instrument Digital Interface, which allows electronic musical instruments to communicate with each other, by sending and receiving compatible Note, Control Change, Program Change and various other types of MIDI data, or messages.

The Clavinova can control a MIDI device by transmitting note related data and various types of controller data. The Clavinova can be controlled by incoming MIDI messages which automatically determine the tone generator mode, select MIDI channels, voices and effects, change parameter values and of course play the voices specified for the various parts.

**NOTE**

MIDI data has the following advantages over audio data:

- The amount of data is much less.
- The data can be effectively and easily edited, even to the point of changing voices and transforming the data.

MIDI messages can be divided into two groups: Channel messages and System messages.

**Channel Messages**

The Clavinova is an electronic instrument that can handle 16 MIDI channels (or reception of 32 channels for MIDI data reception when using the [USB] terminal). This is usually expressed as “it can play 16 instruments at the same time.” Channel messages transmit information such as Note ON/OFF, Program Change, for each of the 16 channels.

## What is MIDI?

<b>Message Name</b>	Clavinova Operation/Panel Setting
<b>Note ON/OFF</b>	Messages which are generated when the keyboard is played. Each message includes a specific note number which corresponds to the key which is pressed, plus a velocity value based on how hard the key is played.
<b>Program Change</b>	For selecting Voices (with control change bank select MSB/LSB settings)
<b>Control Change</b>	Volume, panpot (Mixing Console), etc.

### NOTE

The performance data of all Songs and Styles is handled as MIDI data.

### MIDI Channels

MIDI performance data is assigned to one of sixteen MIDI channels. Using these channels, 1–16, the performance data for sixteen different instrument parts can be simultaneously sent over one MIDI cable.

Think of the MIDI channels as TV channels. Each TV station transmits its broadcasts over a specific channel. Your home TV set receives many different programs simultaneously from several TV stations and you select the appropriate channel to watch the desired program.

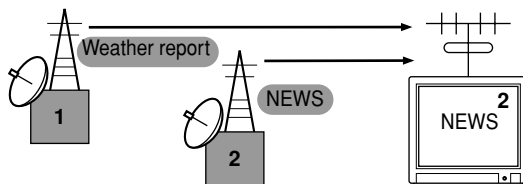

MIDI operates on the same basic principle. The transmitting instrument sends MIDI data on a specific MIDI channel (MIDI Transmit Channel) via a single MIDI cable to the receiving instrument. If the receiving instrument's MIDI channel (MIDI Receive Channel) matches the Transmit Channel, the receiving instrument will sound according to the data sent by the transmitting instrument.

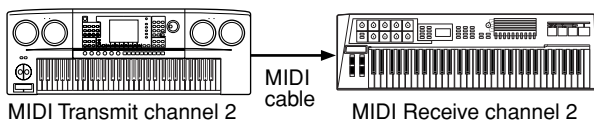

### NOTE

The Clavinova's keyboard and internal tone generator are also connected by MIDI. → LOCAL CONTROL (page 194)

For example, several parts or channels can be transmitted simultaneously, including the Style data (as shown below).

### Example: Recording a performance with the auto accompaniment (Style playback) sound of the Clavinova to an external sequencer

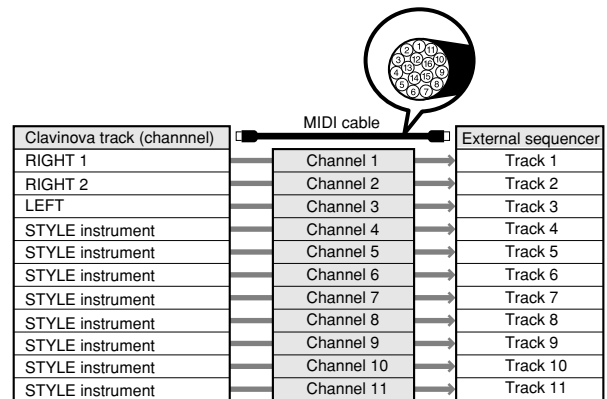

As you can see, it is essential to determine which data is to be sent over which MIDI channel when transmitting MIDI data (page 194).

The Clavinova also allows you to determine how the received data is played back (page 195).

### System Messages

This is data that is used in common by the entire MIDI system. These include System Exclusive messages for transferring data unique to each instrument manufacturer and Realtime messages for controlling the MIDI device.

<b>Message Name</b>	<b>Clavinova Operation/Panel Setting</b>
<b>System Exclusive Message</b>	Effect type settings (Mixing Console), etc.
<b>Realtime Messages</b>	Clock setting, Start/stop operation

The messages transmitted/received by the Clavinova are shown in the MIDI Data Format and MIDI Implementation Chart in the separate Data List.

## What You Can Do With MIDI

- Record your performance data (1–16 channels) using the Clavinova's auto accompaniment features on an external sequencer (or computer with sequencer software). After recording, edit the data with the sequencer, then play it back on the Clavinova.

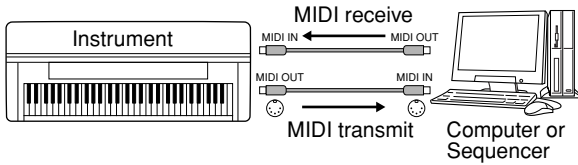

When you want to use the Clavinova as an XG-compatible multi-timbral tone generator, set the receive part for MIDI channels 1–16 to “SONG” in MIDI/USB 1 in MIDI Receive (page 195).

- Controlling from an external MIDI keyboard

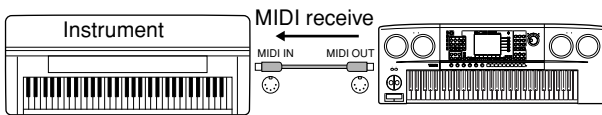

### MIDI Data Compatibility

This section covers basic information on data compatibility: whether or not other MIDI devices can playback the data recorded by CVP-305/303/301, and whether or not the CVP-305/303/301 can playback commercially available song data or song data created for other instruments or on a computer. Depending on the MIDI device or data characteristics, you may be able to playback the data without any problem, or you may have to perform some special operations before the data can be played back. If you run into problems playing back data, please refer to the information below.

### Sequence Formats

Song data is recorded and stored in a variety of different systems, referred to as “sequence formats.”

Playback is only possible when the sequence format of the Song data matches that of the MIDI device. The CVP-305/303/301 is compatible with the following formats.

#### ● SMF (Standard MIDI file)

This is the most common sequence format. Standard MIDI Files are generally available as one of two types: Format 0 or Format 1. Many MIDI devices are compatible with Format 0, and most commercially available software is recorded as Format 0.

- The CVP-305/303/301 is compatible with both Format 0 and Format 1.
- Song data recorded on the CVP-305/303/301 is automatically saved as SMF Format 0.

#### ● ESEQ

This sequence format is compatible with many of Yamaha's MIDI devices, including the Clavinova series instruments. This is a common format used with various Yamaha software.

- The CVP-305/303/301 is compatible with ESEQ.

#### ● XF

The Yamaha XF format enhances the SMF (Standard MIDI File) standard with greater functionality and open-ended expandability for the future. The Clavinova is capable of displaying lyrics when an XF file containing lyric data is played. (SMF is the most common format used for MIDI sequence files. The Clavinova is compatible with SMF Formats 0 and 1, and records “song” data using SMF Format 0.)

#### ● Style File

The Style File Format combines all of Yamaha's auto accompaniment know-how into a single unified format.

### Voice Allocation Format

With MIDI, Voices are assigned to specific numbers, called “program numbers.” The numbering standard (order of voice allocation) is referred to as the “voice allocation format.”

Voices may not playback as expected unless the voice allocation format of the song data matches that of the compatible MIDI device used for playback. The CVP-305/303/301 is compatible with the following formats.

#### NOTE

Even if the devices and data used satisfy all the conditions above, the data may still not be completely compatible, depending on the specifications of the devices and particular data recording methods.

#### ● GM System Level 1

This is one of the most common voice allocation formats. Many MIDI devices are compatible with GM System Level 1, as is most commercially available software.

#### ● GM System Level 2

“GM System Level 2” is a standard specification that enhances the original “GM System Level 1” and improves Song data compatibility. It provides for increased polyphony, greater voice selection, expanded voice parameters, and integrated effect processing.

#### ● XG

XG is a major enhancement of the GM System Level 1 format, and was developed by Yamaha specifically to provide more Voices and variations, as well as greater expressive control over Voices and effects, and to ensure compatibility of data well into the future. Song data recorded on the CVP-305/303/301 using Voices in the XG category is XG-compatible.

#### ● DOC (Disk Orchestra Collection)

This voice allocation format is compatible with many of Yamaha's MIDI devices, including the Clavinova series instruments.

#### ● GS

GS was developed by the Roland Corporation. In the same way as Yamaha XG, GS is a major enhancement of the GM specifically to provide more Voices and Drum kits and their variations, as well as greater expressive control over Voices and effects.

# MIDI Settings

In this section, you can make MIDI-related settings for the instrument. The Clavinova gives you a set of ten pre-programmed templates that let you instantly and easily reconfigure the instrument to match your particular MIDI application or external device. Also, you can edit the pre-programmed templates and save up to ten of your original templates to the USER display. You can then save all these original templates as a single file to SmartMedia card or other external USB storage devices, in the MIDI SETUP selection display (called up by pressing [FUNCTION] → [I] UTILITY → TAB [F] SYSTEM RESET).

## Basic Operation

- 1 Call up the operation (MIDI template selection) display.

Function → [H] MIDI



- 2 To use the pre-programmed templates or to edit them

Press the TAB [◀] button to select the PRESET display. Press one of the [A]–[J] buttons to select a MIDI template.

To use the templates already saved to the USER display or to edit them

Press the TAB [▶] button to select the USER display. Press one of the [A]–[J] buttons to select a MIDI template.

- 3 To edit a template, press the [8▼] (EDIT) button to call up the MIDI display for editing.

The individual parameters settings are shown for the selected template. Here you can edit each parameter.

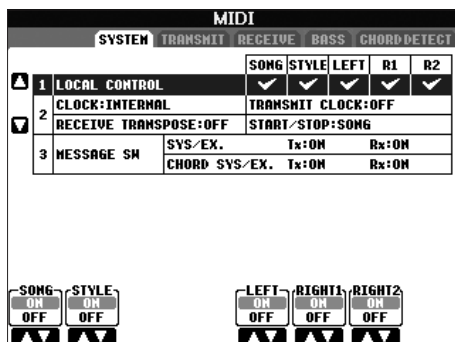

- 4 Use the TAB [◀]/[▶] buttons to call up the relevant setting display.

SYSTEM display	MIDI System Settings (page 194)
TRANSMIT display	MIDI Transmission Settings (page 194)
RECEIVE display	MIDI Reception Settings (page 195)
BASS display	Settings for the bass note of chord for Style playback via MIDI reception data (page 195)
CHORD DETECT display	Settings for the chord type for Style playback via MIDI reception data (page 196)

- 5 When you've finished editing, press the [EXIT] button to return to the MIDI template selection display (PRESET or USER).

- 6 Select the USER tab display to save the data by using the TAB [◀]/[▶] buttons (page 63).

## Pre-Programmed MIDI Templates





Template name	Description
<b>All Parts</b>	Transmits all parts including the keyboard parts (RIGHT1, 2, and LEFT), with the exception of Song parts.
<b>KBD &amp; STYLE</b>	Basically the same as "All Parts" with the exception of how keyboard parts are managed. The right-hand parts are handled as "UPPER" instead of RIGHT 1 and 2 and the left-hand part is handled as "LOWER."
<b>Master KBD</b>	In this setting, the instrument functions as a "master" keyboard, playing and controlling one or more connected tone generators or other devices (such as a computer/sequencer).
<b>Song</b>	All transmit channels are set to correspond to Song channels 1–16. This is used to play Song data with an external tone generator and to record Song data to an external sequencer.
<b>Clock Ext</b>	Playback (Song or Style) synchronizes with an external MIDI clock instead of the instrument's internal clock. This template should be used when you wish to set the tempo on the MIDI device connected to the instrument.
<b>MIDI Accord 1</b>	MIDI accordions allow you to transmit MIDI data and play connected tone generators from the keyboard and bass/chord buttons of the accordion. This template lets you play melodies from the keyboard and control Style playback on the instrument with the left-hand buttons.
<b>MIDI Accord 2</b>	Basically the same as "MIDI Accord1" above, with the exception that the chord/bass notes you play with your left hand on the MIDI Accordion are recognized also as MIDI note events.
<b>MIDI Pedal 1</b>	MIDI pedal units allow you play connected tone generators with your feet (especially convenient for playing single note bass parts). This template lets you play/control the chord root in Style playback with a MIDI pedal unit.
<b>MIDI Pedal 2</b>	This template lets you play the bass part for Style playback by using a MIDI pedal unit.
<b>MIDI OFF</b>	No MIDI signals are sent or received.

SYSTEM display

## MIDI System Settings

The explanations here apply to the SYSTEM display to be called up in step 4 of the “Basic Operation” on page 192.

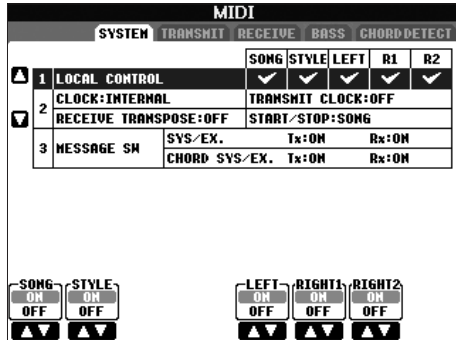

### LOCAL CONTROL

Determines whether the Clavinova is controlled by its own internal clock or a MIDI clock signal received from an external device. INTERNAL is the normal Clock setting when the Clavinova is being used alone or as a master keyboard to control external devices. If you are using the Clavinova with an external sequencer, MIDI computer, or other MIDI device, and you want to synchronize it to that device, set this parameter to the appropriate setting: MIDI, USB 1, or USB 2. In this case, make sure that the external device is connected properly (e.g., to the Clavinova’s MIDI IN terminal), and that it is properly transmitting a MIDI clock signal. When this is set for control by an external device (MIDI, USB 1 or USB 2), the Tempo is indicated as “Ext.” in the Main display

### Clock setting, etc.

#### CLOCK

Determines whether the Clavinova is controlled by its own internal clock or a MIDI clock signal received from an external device. INTERNAL is the normal Clock setting when the Clavinova is being used alone or used to control external devices as the master keyboard. If you are using the Clavinova with an external sequencer, MIDI computer, or other MIDI device, and you want to synchronize it to that device, set this parameter to the appropriate setting: MIDI, USB 1, or USB 2. In this case, make sure that the external device is connected properly (e.g., to the Clavinova’ MIDI IN terminal), and that it is properly transmitting a MIDI clock signal. When this is set to an external device (MIDI, USB 1 or USB 2), the Tempo is indicated as “Ext.” in the Main display.

#### TRANSMIT CLOCK

Turns MIDI clock (F8) transmission on or off. When set to OFF, no MIDI clock or Start/Stop data is transmitted even if a Song or Style is played back.

#### RECEIVE TRANPOSE

Determines whether or not the instrument's transpose setting (page 55) is applied to the note events received by the instrument via MIDI.

#### START/STOP

Determines whether incoming FA (start) and FC (stop) messages affect Song or Style playback.

### MESSAGE SW

#### SYS/EX.

The “Tx” setting turns MIDI transmission of MIDI System Exclusive messages on or off. The “Rx” setting turns MIDI reception and recognition of MIDI System Exclusive messages generated by external equipment on or off.

#### CHORD SYS/EX.

The “Tx” setting turns MIDI transmission of MIDI chord exclusive data (chord detect. root and type) on or off. The “Rx” setting turns MIDI reception and recognition of MIDI chord exclusive data generated by external equipment on or off.

TRANSMIT display

## MIDI Transmit Settings

The explanations here apply to the TRANSMIT display to be called up in step 4 of the “Basic Operation” on page 192. This determines which parts will be sent as MIDI data and over which MIDI channel the data will be sent.

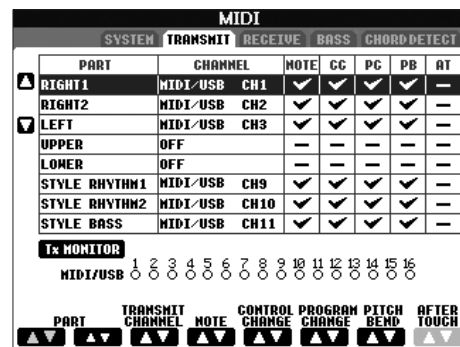

### Operation

Select the part to be transmitted and the channel via which the selected part will be transmitted. You can also determine the types of data to be sent.

● With the exception of the two parts below, the configuration of the parts is the same as those already explained elsewhere in this manual.

#### UPPER

The keyboard part played on the right side of the keyboard from the Split Point for the Voices (RIGHT1 and/ or 2).

#### LOWER

The keyboard part played on the control the left side of the keyboard from the Split Point for the Voices. This is not affected by the on/off status of the [ACMP ON/OFF] button.

● **Tx MONITOR**

The dots corresponding to each channel (1–16) flash briefly whenever any data is transmitted on the channel(s).

**NOTE**

**When different parts are assigned to the same transmit channel**

If the same transmit channel is assigned to several different parts, the transmitted MIDI messages are merged to a single channel—resulting in unexpected sounds and possible glitches in the connected MIDI device.

**NOTE**

**About the protected Songs**

Write-protected Songs and GS songs cannot be transmitted even if the proper Song channels 1–16 are set to be transmitted.

■ **MIDI messages which can be transmitted or received (recognized)**

The following MIDI messages can be set on the TRANSMIT/RECEIVE display.

- Note (Note events).....page 154
- CC (CONTROL CHANGE) .....page 154
- PC (PROGRAM CHANGE).....page 154
- PB (Pitch Bend).....page 154
- AT (Aftersustain).....page 154

RECEIVE display

**MIDI Receive Settings**

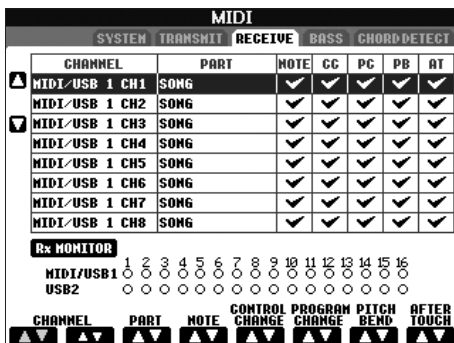

The explanations here apply to the RECEIVE display to be called up in step 4 of the “Basic Operation” on page 192. This determines which parts will receive MIDI data and over which MIDI channels the data will be received.

**Operation**

Select the channel to be received and the part via which the selected channel will be received. You can also determine the types of data to be received.

- **The Clavinova can receive MIDI messages over 32 channels (16 channels x 2 ports) by USB connection.**
- **With the exception of the two parts below, the configuration of the parts is the same as those already explained elsewhere in this manual.**

● **KEYBOARD**

The received note messages control the Clavinova’s keyboard performance.

● **EXTRA PART 1–5**

There are five parts specially reserved for receiving and playing MIDI data. Normally, these parts are not used by the instrument itself. The Clavinova can be used as a 32-channel multi-timbral tone generator by using these five parts in addition to the general parts (except for the microphone sound).

● **Rx MONITOR**

The dots corresponding to each channel (1–16) flash briefly whenever any data is received on the channel(s).

**NOTE** Parameter Lock

You can “lock” specific parameters (e.g., effect, split point, etc.) to make them selectable only via the panel controls (page 122).

■ **MIDI transmission/reception via the USB terminal and MIDI terminals**

The relationship between the [MIDI] terminals and the [USB] terminal which can be used for transmitting/receiving 32 channels (16 channels x 2 ports) of the MIDI messages is as follows:

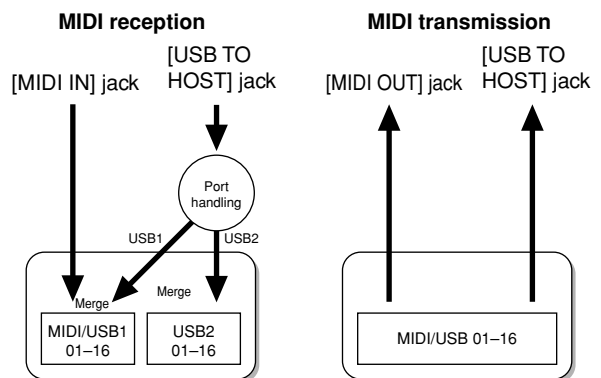

BASS display

**Setting the Bass Note for Style Playback via MIDI Receive**

The explanations here apply to the BASS display to be called up in step 4 of the “Basic Operation” on page 192.

These settings let you determine the bass note for Style playback, based on the note messages received via MIDI. The note on/off messages received at the channel(s) set to “ON” are recognized as the bass note of the chord of Style playback. The bass note will be detected regardless of the [ACMP ON/OFF] or split point settings. When several channels are simultaneously set to “ON,” the bass note is detected from merged MIDI data received over the channels.

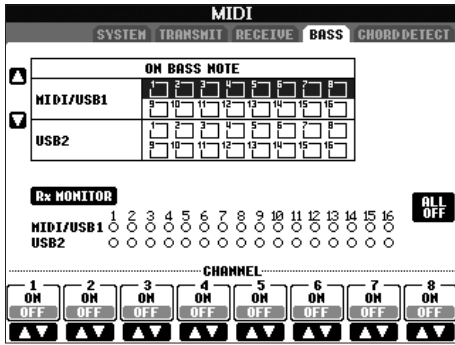

**Operation**

Select the channel and set the “ON/OFF” for that channel. Use the All OFF item to set all channels to OFF.

CHORD DETECT display

**Setting the Chord Type for Style Playback via MIDI Receive**

The explanations here apply to the CHORD DETECT display to be called up in step 4 of the “Basic Operation” on page 192. These settings let you determine the chord type for Style playback, based on the note messages received via MIDI. The note on/off messages received at the channel(s) set to “ON” are recognized as the notes for detecting chords in Style playback. The chords to be detected depend on the fingering type. The chord type will be detected regardless of the [ACMP ON/OFF] or split point settings. When several channels are simultaneously set to “ON,” the chord type is detected from merged MIDI data received over the channels. The operation procedure is basically the same as that of the BASS display above.

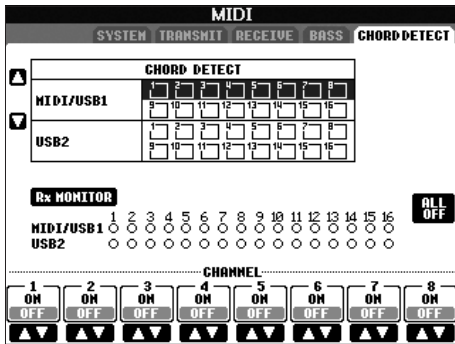

**Displaying the Voice Program Change Number**

Determines whether or not the Voice bank and number are shown in the Voice selection display. This is useful when you want to check which bank select MSB/LSB values and program change number you need to specify when selecting the Voice from an external MIDI device.

You can set this in the display called up by the following operations: [FUNCTION] → [I] UTILITY → TAB [◀]/[▶] CONFIG 2. Switch the DISPLAY VOICE NUMBER menu ON and OFF.

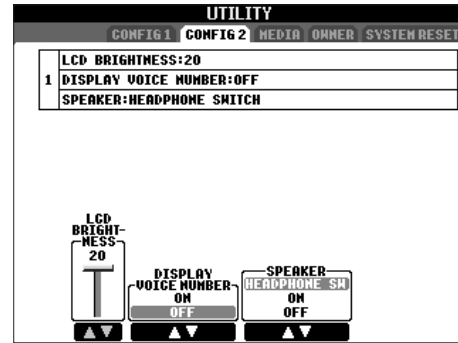

**NOTE**

- The numbers displayed here start from “1.” Accordingly the actual MIDI program change numbers are one lower, since that number system starts from “0.”
- For the GS Voices, this feature is not available (the program change numbers are not shown).

## Overall

### The Clavinova does not turn on.

- Securely insert the female plug into the socket on the Clavinova, and the male plug into a proper AC outlet.

### A click or pop is heard when the power is turned on or off.

- Electrical current is being applied to the instrument. This is normal.

### Noise is heard from the Clavinova's speakers.

- Noise may be heard if a mobile phone is used near the Clavinova or if the phone is ringing. Turn off the mobile phone, or use it further away from the Clavinova.

### The letters in the display cannot be read, because the display is too bright (or dark).

- Use the [LCD CONTRAST] knob to adjust for optimum visibility.
- (CVP-305/303) Adjust the brightness of the display (page 19).

### The overall volume is too low, or, no sound is heard.

- The master volume may be set too low. Set it to an appropriate level with the [MASTER VOLUME] dial.
- All keyboard parts are set to off. Use the PART ON/OFF [RIGHT 1]/[RIGHT 2]/[LEFT] button to turn it on.
- The volume of the individual parts may be set too low. Raise the volume in the BALANCE display (page 39).
- Make sure the desired channel is set to ON (page 99).
- Headphones are connected, disabling the speaker output. (This happens when the speaker setting is set to "HEADPHONE SW"; page 18.) Unplug the headphones.
- Make sure the speaker setting is set to ON (page 18).
- The [FADE IN/OUT] button is on, muting the sound. Press the [FADE IN/OUT] button to turn the function off.
- Make sure the Local Control function is set to ON (page 194).

### Not all simultaneously played notes sound.

- You are probably exceeding the maximum polyphony (page 209) of the CVP. When the maximum polyphony is exceeded, the earliest played notes will stop sounding, letting the latest played notes sound.

### The keyboard volume is lower than the Song/Style playback volume.

- The volume of the keyboard parts may be set too low. Raise the volume in the BALANCE display (page 39).

### Keys do not sound at the proper pitch.

- Make sure the [PERFORMANCE ASSISTANT] button is set to OFF.

### Certain notes sound at the wrong pitch.

The Scale parameter has probably been set to something other than "Equal," changing the tuning system of the keyboard. Make sure "Equal" is selected as the Scale in the Scale Tune display (page 76).

- There is a slight difference in sound quality among different notes played on the keyboard.

- Some Voices have a looping sound.

- Some noise or vibrato is noticeable at higher pitches, depending upon the voice.

- This is normal and is a result of the Clavinova's sampling system.

### Some Voices will jump an octave in pitch when played in the upper or lower registers.

- This is normal. Some voices have a pitch limit which, when reached, causes this type of pitch shift.

### The Main display does not appear even when turning the power on.

- This may occur if a USB storage device has been installed to the instrument. Installation of some USB storage device may result a long interval between turning the power on and appearance of the Main display. To avoid this, turn the power on after disconnecting the device.

## Pedals

### The damper, sostenuto and soft functions do not work for the relevant pedals.

- The pedal cord plug is not connected. Securely insert the pedal cord plug into the proper jack (page 203).
- Each pedal has been assigned to a different function. Make sure that each pedal is properly assigned to SUSTAIN, SOSTENUTO, and SOFT (page 182).
- Make sure the Registration Sequence function is set to OFF (page 125).

## Files/Folders

### Some characters of the file/folder name are garbled.

- The language settings have been changed. Set the appropriate language for the file/folder name (page 18).

### An existing file is not shown.

- The file extension (.MID, etc.) may have been changed or deleted. Manually rename the file, adding the appropriate extension, on a computer.

### The data contained in the external media (SmartMedia card, etc.) is not shown on the instrument itself.

- Data files with names of more than 50 characters cannot be handled by the instrument. Rename the file, reducing the number of characters to 50 or less.

### The file/folder copied or cut from one media (such as a SmartMedia card, etc.) cannot be directly copied or pasted to another media.

- This is normal. Since directly copying data is not possible, copy or paste the data once to the User display, then copy or paste it again to the Card/USB display after changing the media.

## Demo

### How can I stop the demo?

- Press the [EXIT] button.

## Help

### How can I leave the Help feature?

- Press the [EXIT] button.

## Voice

### The Voice selected from the Voice Selection display does not sound.

- Check whether or not the selected part is turned on (page 73).
- To select the Voice for the right-hand key range, press the PART SELECT [RIGHT 1] button. For the Voice to be layered in the right-hand range, press the PART SELECT [RIGHT 2] button. To select the Voice for the left-hand key range, press the PART SELECT [LEFT] button.

### A strange “flanging” or “doubling” sound occurs. The sound is slightly different each time the keys are played.

- The RIGHT 1 and RIGHT 2 parts are set to “ON,” and both parts are set to play the same Voice. Turn off the RIGHT 2 part or change the Voice of one of the parts.

### The sound seems strange or different than expected when changing a rhythm Voice (drum kit, etc.) of the Style or Song from the Mixer.

- When changing the rhythm/percussion Voices (drum kits, etc.) of the Style and Song from the VOICE parameter, the detailed settings related to the drum voice are reset, and in some cases you may be unable to restore the original sound. In the case of Song playback, you can restore the original sound by returning to the beginning of the Song and playing back from that point. In the case of Style play, you can restore the original sound by selecting the same Style again.

### Tremolo/Trill cannot be applied to the Organ Flute Voice.

- This is normal; Tremolo and Trill settings in the Harmony/Echo display are not effective for Organ Flute Voices.

### The Harmony function does not operate.

- Harmony cannot be used with the Full Keyboard or AI Full Keyboard fingering modes. Select an appropriate fingering mode (page 97).

### When a Voice is changed, the previously selected effect is changed.

- Each Voice has its own suitable preset settings, which are automatically recalled when the corresponding Voice Set parameters are turned on (page 96).

### The Voice produces excessive noise.

- Certain Voices may produce noise, depending on the Harmonic Content and/or Brightness settings in the FILTER page of the Mixing Console display (page 82).

### The sound is distorted or noisy.

- The volume may be turned up too high. Make sure all relevant volume settings are appropriate.
- This may be caused by certain effects. Try canceling all unnecessary effects, especially distortion-type effects (page 84).
- Some filter resonance settings in the Sound Creator display (page 91) can result in distorted sound. Adjust these settings if necessary.
- Noise may occur depending on the settings made in the Filter display of the Mixing Console. Adjust the Harmonic Content or Brightness controls in the Filter display (page 82).

### The sound does not change when replacing Voices with the Song Auto Revoice feature.

- Depending on the particular Song data, there are some instances where Song Auto Revoice has no effect, even when replacing Voices.

### The sound of the Voice doesn’t change, even when editing the Voice.

- Keep in mind that adjustments made to the parameters may not make much change in the actual sound depending on the original settings of the Voice.

### Voices other than those in the Preset display cannot be selected for Step recording.

- This is normal.

## Style

### Style playback does not start.

- Make sure to press the STYLE CONTROL [START/STOP] button.
- MIDI Clock may be set to “EXTERNAL.” Make sure this is set to “INTERNAL” (page 194).

### Only the rhythm channel plays.

- Make sure the Auto Accompaniment function is turned on; press the [ACMP ON/OFF] button.
- You may be playing keys in the right hand range of the keyboard. Make sure to play keys in the chord range of the keyboard.

### Styles cannot be selected.

- If the size of the Style data is large (120 KB or greater), the Style cannot be selected because the data is too large to be ready by the instrument.

### The desired chord is not recognized or output by the auto accompaniment.

- You may not be playing the correct keys for indicating the chord. Refer to “Chord Types Recognized in the Fingering Mode” of the separate Data List.
- You may be playing the keys according to a different fingering mode, and not the one currently selected. Check the accompaniment mode, and play the keys according to the selected mode (page 98).

### **Synchro Stop cannot be turned on.**

- Synchro Stop cannot be turned on when the fingering mode is set to “Full Keyboard” or “AI Full Keyboard,” or when Style On/Off is set to off. Make sure the fingering mode is set to something besides “Full Keyboard” or “AI Full Keyboard” and set Style On/Off to on.

### **Auto accompaniment chords are recognized regardless of the split point or where chords are played on the keyboard.**

- This is normal if the fingering mode is set to “Full Keyboard” or “AI Full Keyboard.” If either of these is selected, chords are recognized over the entire range of the keyboard, irrespective of the split point setting. If desired, select a different fingering mode (page 98).

### **When playing back one Style and selecting another, the newly selected Style doesn't play at the proper Tempo.**

- This is normal; the Tempo setting remains constant when changing Styles.

### **Starting a Song while playing back a Style stops Style playback.**

This is because Song playback has priority. The two ways shown below let you play back a Style and Song simultaneously.

- Set the Song to Synchro Start standby, then start the Style.
- Start the Style playback after playing back a Song.

### **The level balance of the various Parts becomes wrong or unexpected sounds are output when selecting a Style or a Voice after selecting a Song.**

- The level balance of the Parts can change and unexpected sounds can be produced because of the effects applied to each Part.

### **The “Off” setting is not shown for the Play Type parameter in the Assembly (Style Creator) feature.**

- The selected section is set to record enable. Release the recording assignment by pressing the appropriate [1 ▼]–[8 ▼] button in the recording channel display (TAB [◀] button → BASIC tab → [F] REC CH).

### **The channels BASS-PHR2 cannot be edited in Channel Edit.**

- This is normal; BASS-PHR2 channels of the Preset Styles cannot be edited.

## **Registration memory**

### **The Song/Style registered to the Registration Memory cannot be called up.**

- If the registered Song/Style is contained on external media such as SmartMedia card and the media is not inserted or connected to the instrument, the Song/Style cannot be called up. Insert or connect the appropriate media containing the Song/Style data.

### **The order for calling up Registration Memory settings is not shown on the Registration Sequence setting display.**

- The bank containing the Registration has not been selected. Select the appropriate bank (page 122).

### **When using the Freeze function of the Registration Memory, the On/Off setting of the Left Part does not change even when changing the Registration Memory setting.**

- The Left Part On/Off setting is included in the Style group. Remove the checkmark from “STYLE” in the Freeze setting display (page 123).

### **Even though a Registration Memory setting containing a User/Card voice is selected, the File Selection display shows a Preset Voice.**

- This is normal; even with the Preset Voice shown, the actual sounding Voice is the selected User/Card Voice. When a User/Card Voice is saved to the User/Card drive, the actual data is divided into two separate types: 1) the source Preset Voice itself, and 2) the parameter settings as set in the Sound Creator. When you recall a Registration Memory setting containing a User/Card Voice, the Clavinova selects the Preset voice (on which the User/Card Voice is based), then applies the relevant parameter settings to it—so that your original User/Card Voice is sounded.

## **Song**

### **Songs cannot be selected.**

- This may be because the language settings have been changed. Set the appropriate language for the Song file name.
- If the size of the Song data is large (300 KB or greater), the Song cannot be selected because the data is too large to be read by the instrument.

### **Song playback does not start.**

- “New Song” (a blank Song) has been selected. Make sure to select an appropriate Song in the Song Selection display (page 34).
- Make sure to press the SONG [PLAY/PAUSE] button.
- The Song has been stopped at the end of the Song data. Return to the beginning of the Song by pressing the SONG [STOP] button.
- In the case a Song to which write-protect has been applied (“Prot. 2 Edit” is shown at the upper left of the Song name), the original file may not be in the same folder. It cannot be played back unless the original file (showing “Prot.2 Orig” at the upper left of the Song name) is in the same folder.
- In case of a Song to which write-protect has been applied (“Prot. 2 Edit” is shown at the upper left of the Song name), the original file name may have been changed. Rename the file with the original file name (so that “Prot.2 Orig” is shown at the upper left of the Song name).

- In case of a Song to which write-protect has been applied ("Prot. 2 Edit" is shown at the upper left of the Song name), the file icon may have been changed. Songs to which write-protect has been applied cannot be played back when the file icon of the original has been changed.
- MIDI Clock may be set to "EXTERNAL." Make sure this is set to "INTERNAL" (page 194).

#### **Song playback stops before the Song is finished.**

- The Guide function is turned on. (In this case, playback is "waiting" for the correct key to be played.) Press the [GUIDE] button to turn off the guide function.

#### **The Song last selected before turning off the power is no longer available.**

- If the Song last selected before turning off the power is contained in external media such as a SmartMedia card, you'll need to reinsert/reconnect the same media to call up the Song again.

#### **The measure number is different from that of the score in the Song Position display, shown by pressing the [REW]/[FF] buttons.**

- This happens when playing back music data for which a specific, fixed tempo is set.

#### **In the AB Repeat function, the B point cannot be set.**

- The A point has not been set. Set the B point only after setting the A point.

#### **When playing back a Song, some channels do not play.**

- Playback of these channels may be set to "OFF." Turn playback on for those channels that are set to "OFF" (page 133).

#### **A Song to which write-protect has been applied ("Prot. 2 Edit" is shown at the upper left of the Song name) cannot be moved to an ID SmartMedia card.**

- If you are using an external card reader, write-protected Songs cannot be moved to an ID SmartMedia card. Use the card slot on this instrument.

#### **The Tuning Curve of the piano Voice does not quite match that of other instruments' Voices.**

- The Tuning Curve designed especially for piano Voices may not sound with the appropriate pitches when used with other instrument Voices. Set the Tuning Curve to "FLAT" (page 90).

## **Guide**

#### **The melody still plays back, even when specifying Track 1 as the part to be muted for one-handed practice.**

- A part other than the melody part has been assigned to Track 1. Reassign the channel containing the melody to Track 1 (page 131).

#### **The Guide lamps do not light during Song playback, even after pressing the [GUIDE] button.**

- Make sure to turn on the Guide lamps (page 131).
- Any notes outside of the 88-key range cannot be indicated by the Guide lamps.

#### **The Guide lamps light an octave or two lower/higher than the actual pitch.**

- The Guide lamps sometimes light an octave or two lower/higher than the actual pitch depending on the selected Voice.

#### **The lamps in the chord section of the keyboard light.**

- The Guide function for chords (page 49) has been enabled. Turn the Style off by pressing the [ACMP ON/OFF] button.

#### **The Guide lamps do not indicate how to play chords.**

- Make sure that the Guide Mode is set to "FollowLights" (page 98).
- You cannot check how to play chords with the Guide lamps if the chord fingering method is set to "Single Finger," "Full Keyboard" or "All Full Keyboard." Select another fingering method (page 98).

## **Score**

#### **When displaying the music score, long notes that have been entered, such as whole notes and ties, are not displayed correctly.**

- Long notes, such as whole notes and ties, may not be shown in the music score display exactly as they were entered. To have a more accurate display of these notes, select "Tenuto" by pressing the [H] button before inputting each note in the Step Record display (page 137).

#### **The tempo, beat, measure and music notation is not displayed correctly.**

- Some Song data for the Clavinova has been recorded with special "free tempo" settings. For such Song data, the tempo, beat, measure and music notation will not be displayed correctly.

#### **The note name partially obscures the note in the display.**

- When several notes occur close to each other, the note name may obscure the note at left.

#### **The music score of the right-hand/left-hand part is not displayed.**

- The appropriate channels have not been assigned to the right-hand and left-hand parts. Set RIGHT and LEFT to the appropriate channels (page 38).

#### **The notation in the display is cut off, with the middle of a measure starting on the next line.**

- When all the notes of a measure cannot fit on one line, the remaining notes in the measure are carried over to the next line.

#### **Dotted notes are indicated as rests.**

- This is normal; sometimes dotted notes are indicated as rests.

#### **Chords are not displayed.**

- If the selected Song does not contain chord data, chords are not displayed.



## Lyrics (Karaoke)

### Lyrics are not displayed.

- If the selected Song does not contain lyric data, lyrics are not displayed.

### Some of the lyrics overlap each other.

- This happens for Songs containing many lyrics.

### (CVP-305) The Lyrics Background setting cannot be changed.

- When the background color is specified in the song data, the Lyrics Background setting cannot be changed.

## Performance assistant technology

### Performance assistant technology does not work appropriately.

- Press the SONG [STOP] button to stop Song playback, then set the [ACMP ON/OFF] and PART ON/OFF [LEFT] to off. Finally, restart the Song.

## Video out (CVP-305)

### The Clavinova display contents cannot be sent via video out and do not show on an external monitor.

- Make sure that the NTSC or PAL setting corresponds to the standard of your particular video equipment (page 53).

### Some flashing parallel lines appear in the television or video monitor.

- Occasionally some flashing parallel lines may appear in the television or video monitor. This does not necessarily indicate that the monitor is malfunctioning. For optimum results, try adjusting the color settings on the monitor itself.

### The monitor you are using may not show the instrument's display contents as expected.

- Keep in mind that even after adjusting all settings as recommended, the monitor you are using may not show the instrument's display contents as expected (e.g., the display contents may not fit on the screen, the characters may not be completely clear, or the colors may be incorrect).

## Microphone/Vocal harmony (CVP-305/303)

### The microphone input signal cannot be recorded.

- The microphone input signal cannot be recorded to the instrument. However, you can connect a recorder to the output terminals [AUX OUT, AUX OUT (LEVEL FIXED), OPTICAL OUT (CVP-305)] and record the microphone signal.

### Harmony can be heard in addition to the microphone sound.

- Vocal Harmony is set to "ON." Turn Vocal Harmony off (page 54).

### The Vocal Harmony effect sounds distorted or out-of-tune.

Your vocal microphone may be picking up extraneous sounds, such as the Style sound from the instrument. In particular, bass sounds can cause mistracking of the Vocal Harmony. To remedy this:

- Sing as closely to the microphone as possible.
- Use a directional microphone.
- Turn down the Master volume, Style volume, or Song volume control (page 39).
- Separate the microphone from the external speakers as much as possible.
- Cut the Low band via the 3 Band EQ function in the MICROPHONE SETTING display (page 165).
- Raise the microphone input level (TH) via the Compressor function in the MICROPHONE SETTING display (page 162).

### Appropriate harmony notes are not produced by the Vocal Harmony feature.

- Make sure you are using the appropriate method to specify the harmony notes for the current Vocal Harmony mode (page 163).

# CVP-305: Keyboard Stand Assembly

## ⚠ CAUTION

- Be careful not to confuse parts, and be sure to install all parts in the correct direction. Please assemble in accordance with the sequence given below.
- Assembly should be carried out by at least two persons.
- Be sure to use the correct screw size, as indicated below. Use of incorrect screws can cause damage.
- Be sure to tighten up all screws upon completing assembly of each unit.
- To disassemble, reverse the assembly sequence given below.

Have a Phillips-head (+) screwdriver ready.

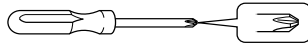

## 1 Open the package, take out the pedal box, take out the styrofoam pads, and place the main unit on top of the pads.

Position the pads so that they will protect the headphone jack and the connector panel located underneath the front left corner.

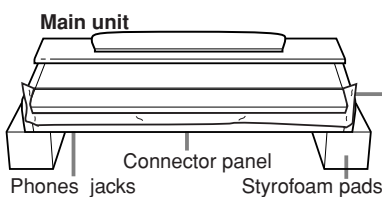

To prevent the key cover from accidentally opening during assembly, press down on the key cover, making sure that the sheet (shown) remain in place.

Remove the parts shown below from the box.

Front panel

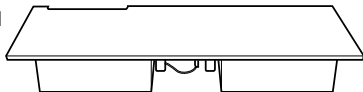

Rear panel

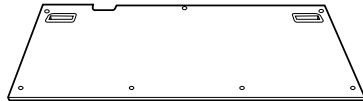

Pedal box

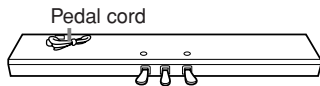

Side panel (left)

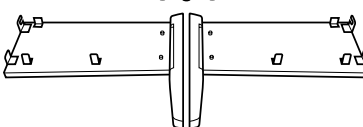

Side panel (right)

### Assembly Parts

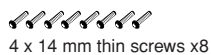

### AC power cord



## 2 Attach the side panels to the pedal box.

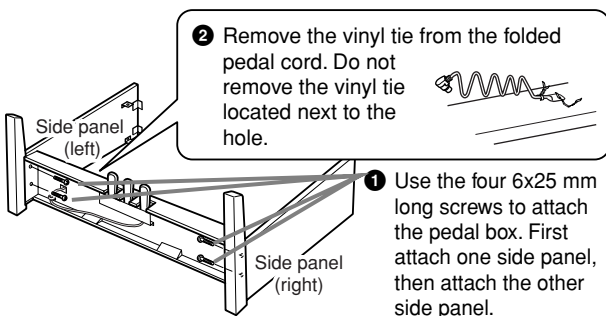

## 3 Attach the front panel.

- 1 Align and attach the front panel to the front side of the pedal box and both side panels.
- 2 Secure the panel using the 4x14mm thin screws.  
\* Insert six screws into the **smaller holes** on the brackets.

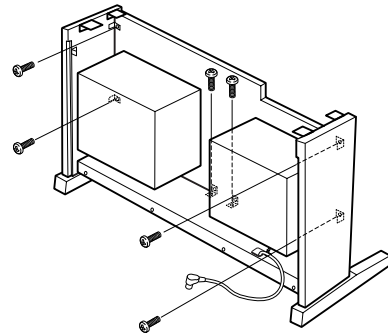

## 4 Mount the main unit.

### ⚠ CAUTION

- Fingers can become pinched between the main unit and the rear or side panels, be extra careful so as not to drop the main unit.
- Do not hold the keyboard in any position other than the position shown in the illustration.

Be sure to place your hands at least 10 cm from either end of the main unit when positioning it.

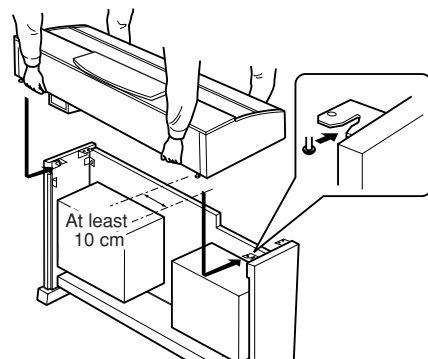

## 5 Fix the main unit.

- 1 Center the main unit to produce equal clearance on the left and right sides.

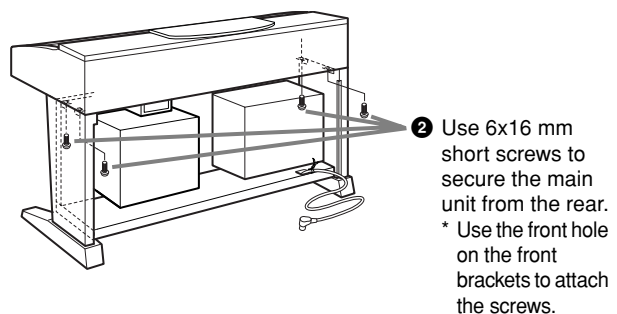
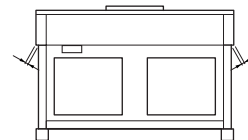

## 6 Connect the speaker cord.

- 1 Before connecting the speaker cord, remove the vinyl tie attaching the speaker cord to the front panel.

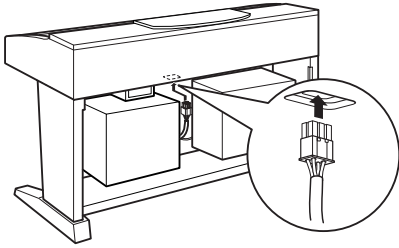

- 2 Insert the speaker cord plug into the connector, with the plug's tab facing the rear.

## 7 Connect the pedal cord.

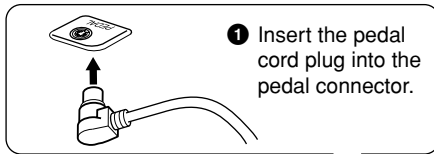

- 1 Insert the pedal cord plug into the pedal connector.

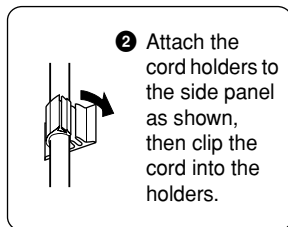

- 2 Attach the cord holders to the side panel as shown, then clip the cord into the holders.

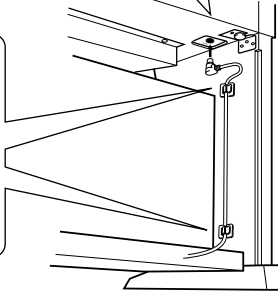

## 8 Attach the rear panel.

- 2 Secure the left and right corners using the 4x14mm thin screws.

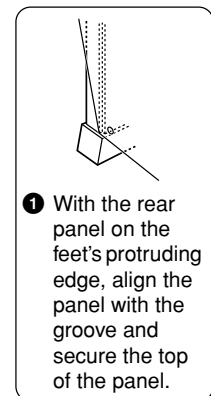

- 1 With the rear panel on the feet's protruding edge, align the panel with the groove and secure the top of the panel.

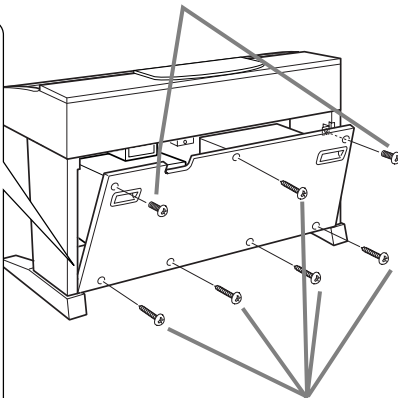

- 3 Secure the top center and bottom of the panel using the 4x20mm tapping screws.

## 9 Set the voltage selector and connect the power cord.

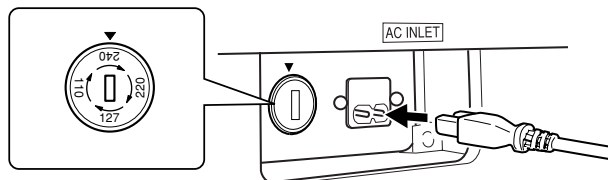

## Voltage Selector

Before connecting the AC power cord, check the setting of the voltage selector which is provided in some areas. To set the selector for 110V, 127V, 220V or 240V main voltages, use a "minus" screwdriver to rotate the selector dial so that the correct voltage for your region appears next to the pointer on the panel. The voltage selector is set at 240V when the unit is initially shipped. After the proper voltage has been selected, connect the AC power cord to the AC INLET and an AC wall outlet. A plug adaptor may be also provided in some areas to match the pin configuration of the AC wall outlets in your area.

### ⚠ WARNING

- An improper voltage setting can cause serious damage to the Clavinova or result in improper operation.

## 10 Set the adjuster.

Rotate the adjuster until it comes in firm contact with the floor surface.

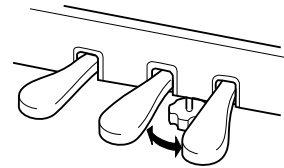

After completing the assembly, please check the following.

- Are there any parts left over?
  - Review the assembly procedure and correct any errors.
- Is the Clavinova clear of doors and other movable fixtures?
  - Move the Clavinova to an appropriate location.
- Does the Clavinova make a rattling noise when you shake it?
  - Tighten all screws.
- Does the pedal box rattle or give way when you step on the pedals?
  - Turn the adjuster so that it is set firmly against the floor.
- Are the pedal and power cords inserted securely into the sockets?
  - Check the connection.
- If the main unit creaks or is otherwise unsteady when you play on the keyboard, refer to the assembly diagrams and retighten all screws.

When moving the instrument after assembly, always hold instrument by the lower surface in the front of the main unit and by the handles in the rear panel.

### ⚠ CAUTION

Do not hold the key cover or top portion. Improper handling can result in damage to the instrument or personal injury.

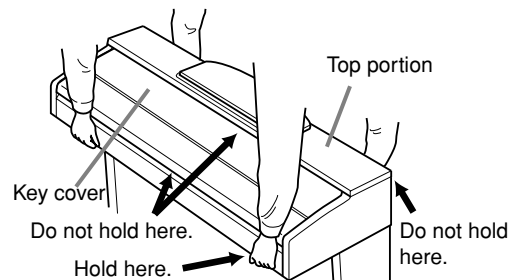

# CVP-303: Keyboard Stand Assembly

## ⚠ CAUTION

- Be careful not to confuse parts, and be sure to install all parts in the correct direction. Please assemble in accordance with the sequence given below.
- Assembly should be carried out by at least two persons.
- Be sure to use the correct screw size, as indicated below. Use of incorrect screws can cause damage.
- Be sure to tighten up all screws upon completing assembly of each unit.
- To disassemble, reverse the assembly sequence given below.

Have a Phillips-head (+) screwdriver ready.

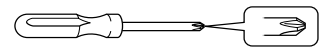

## 1 Open the package, take out the pedal box, take out the styrofoam pads, and place the main unit on top of the pads.

Position the pads so that they will protect the headphone jack located underneath the front left corner.

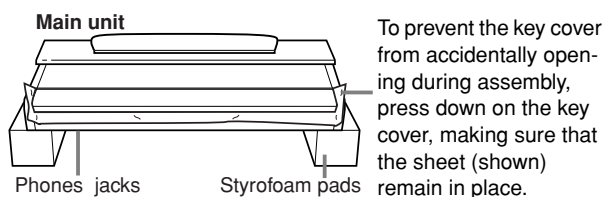

Remove the parts shown below from the box.

Rear panel

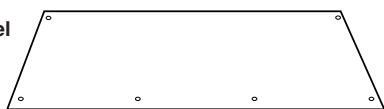

Pedal box

Bundled pedal cord inside



Side panel (left)

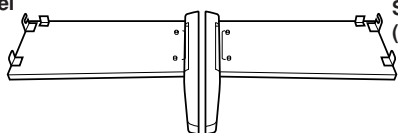

Side panel (right)

### Assembly Parts



6 x 25 mm long screws x4



6 x 16 mm short screws x4



4 x 12 mm thin screws x2

### AC power cord

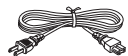

4 x 20 mm tapping screws x4



Cord holders x2

## 2 Attach the side panels to the pedal box.

- 1 Untie and straighten out the bundled cord attached to the bottom of the pedal box. Don't discard the vinyl tie, you'll need it later in step 6.

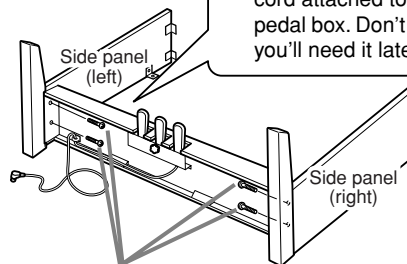

- 2 Use the four 6x25 mm long screws to attach the pedal box. First attach one side panel, then attach the other side panel.

## 3 Attach the rear panel.

- 1 Place the bottom edges of the rear panel on the feet's protruding edges, with the panel slightly angled as shown in the illustration. Then, align the top part of the panel with the side panels.
- 2 Secure the top of the rear panel to the side panel brackets using two 4x12 mm thin screws.
- 3 Secure the bottom of the rear panel to the pedal box using four 4x20 mm tapping screws.

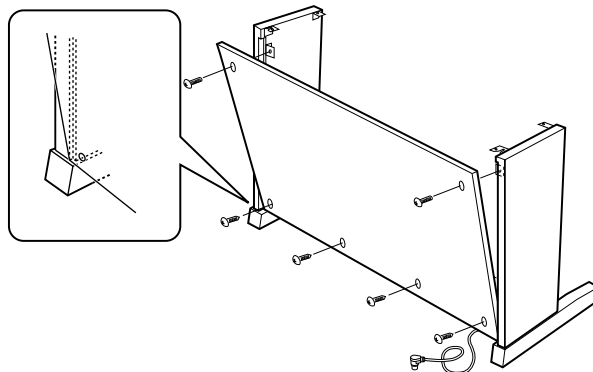

## 4 Mount the main unit.

### ⚠ CAUTION

- Fingers can become pinched between the main unit and the rear or side panels, be extra careful so as not to drop the main unit.
- Do not hold the keyboard in any position other than the position shown in the illustration.

**Be sure to place your hands at least 10 cm from either end of the main unit when positioning it.**

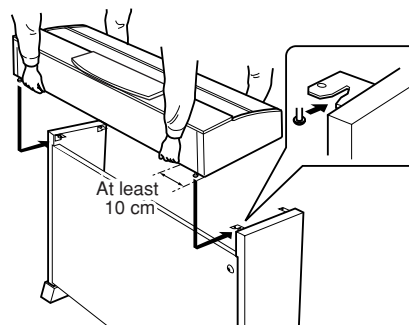

## 5 Fix the main unit.

- 1 Center the main unit to produce equal clearance on the left and right sides.
- 2 Use 6x16 mm short screws to secure the main unit from the front.

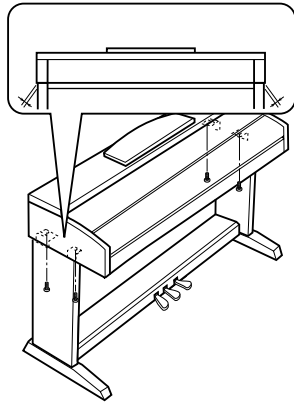

## 6 Connect the pedal cord.

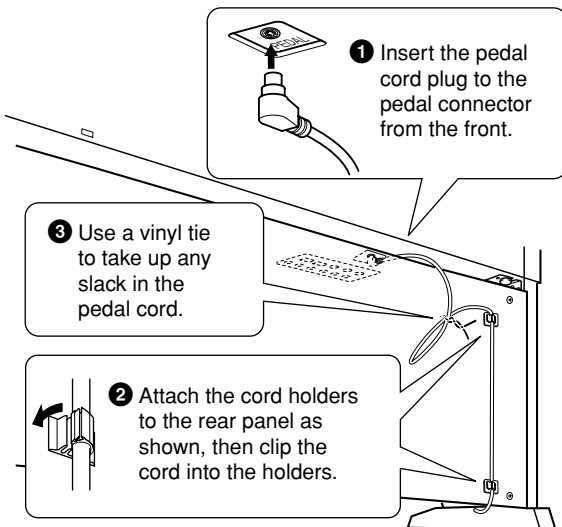

## 7 Set the voltage selector and connect the power cord.

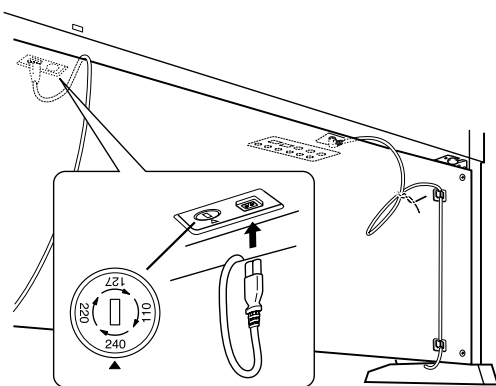

### Voltage Selector

Before connecting the AC power cord, check the setting of the voltage selector which is provided in some areas. To set the selector for 110V, 127V, 220V or 240V main voltages, use a "minus" screwdriver to rotate the selector dial so that the correct voltage for your region appears next to the pointer on the panel. The voltage selector is set at 240V when the unit is initially shipped.

After the proper voltage has been selected, connect the AC power cord to the AC INLET and an AC wall outlet. A plug adaptor may be also provided in some areas to match the pin configuration of the AC wall outlets in your area.

### ⚠ WARNING

An improper voltage setting can cause serious damage to the Clavinova or result in improper operation.

## 8 Set the adjuster.

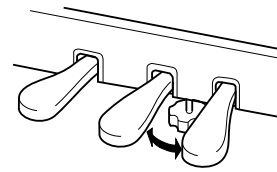

Rotate the adjuster until it comes in firm contact with the floor surface.

### ■ After completing the assembly, please check the following.

- Are there any parts left over?  
→ Review the assembly procedure and correct any errors.
- Is the Clavinova clear of doors and other movable fixtures?  
→ Move the Clavinova to an appropriate location.
- Does the Clavinova make a rattling noise when you shake it?  
→ Tighten all screws.
- Does the pedal box rattle or give way when you step on the pedals?  
→ Turn the adjuster so that it is set firmly against the floor.
- Are the pedal and power cords inserted securely into the sockets?  
→ Check the connection.
- If the main unit creaks or is otherwise unsteady when you play on the keyboard, refer to the assembly diagrams and retighten all screws.

When moving the instrument after assembly, always hold the bottom of the main unit.

### ⚠ CAUTION

Do not hold the key cover or top portion. Improper handling can result in damage to the instrument or personal injury.

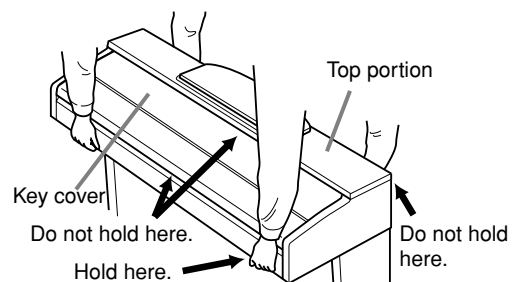

# CVP-301: Keyboard Stand Assembly

## ⚠ CAUTION

- Be careful not to confuse parts, and be sure to install all parts in the correct direction. Please assemble in accordance with the sequence given below.
- Assembly should be carried out by at least two persons.
- Be sure to use the correct screw size, as indicated below. Use of incorrect screws can cause damage.
- Be sure to tighten up all screws upon completing assembly of each unit.
- To disassemble, reverse the assembly sequence given below.

Have a Phillips-head (+) screwdriver ready.

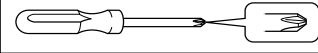

- 1 Open the package, take out the pedal box, take out the styrofoam pads, and place the main unit on top of the pads.

### Main unit

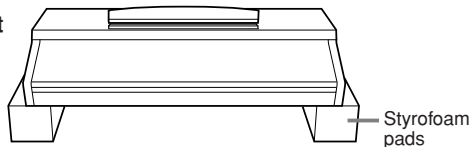

Remove the parts shown below from the box.

### Rear panel

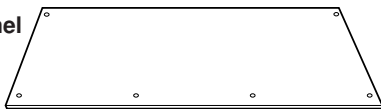

### Pedal box

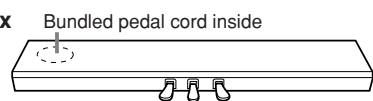

### Side panel (left)

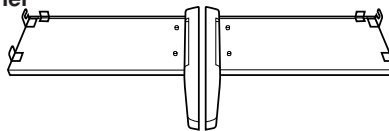

### Side panel (right)

### Assembly Parts



6 x 25 mm long screws x4



6 x 16 mm short screws x4



4 x 12 mm thin screws x2

### AC power cord



4 x 20 mm tapping screws x4



Cord holders x2

- 2 Attach the side panels to the pedal box.

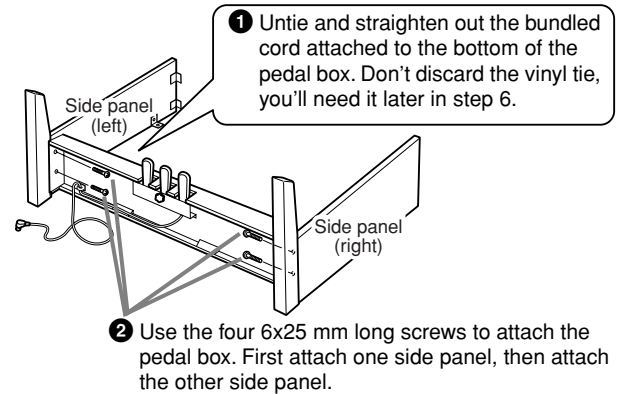

- 3 Attach the rear panel.

- 1 Place the bottom edges of the rear panel on the feet's protruding edges, with the panel slightly angled as shown in the illustration. Then, align the top part of the panel with the side panels.
- 2 Secure the top of the rear panel to the side panel brackets using two 4x12 mm thin screws.
- 3 Secure the bottom of the rear panel to the pedal box using four 4x20 mm tapping screws.

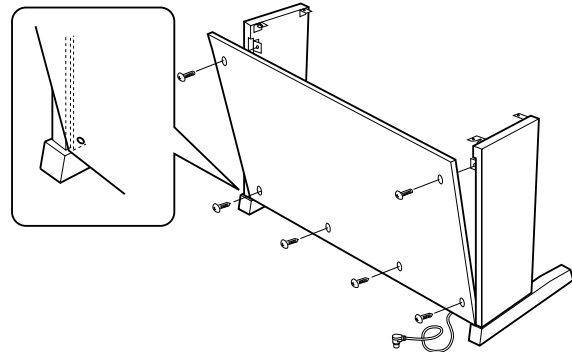

- 4 Mount the main unit.

## ⚠ CAUTION

- Fingers can become pinched between the main unit and the rear or side panels, be extra careful so as not to drop the main unit.
- Do not hold the keyboard in any position other than the position shown in the illustration.

**Be sure to place your hands at least 10 cm from either end of the main unit when positioning it.**

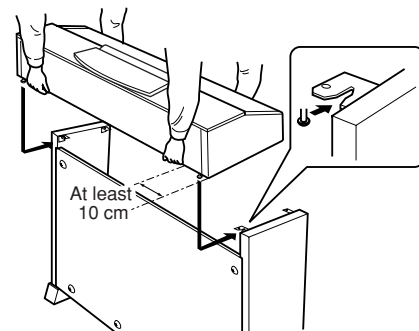

## 5 Fix the main unit.

- 1 Center the main unit to produce equal clearance on the left and right sides.
- 2 Use 6x16 mm short screws to secure the main unit from the front.

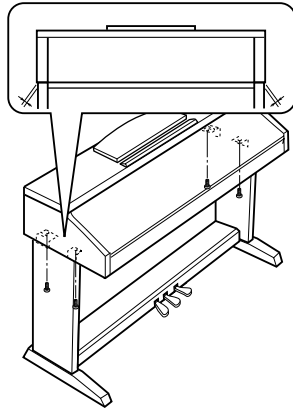

## 6 Connect the pedal cord.

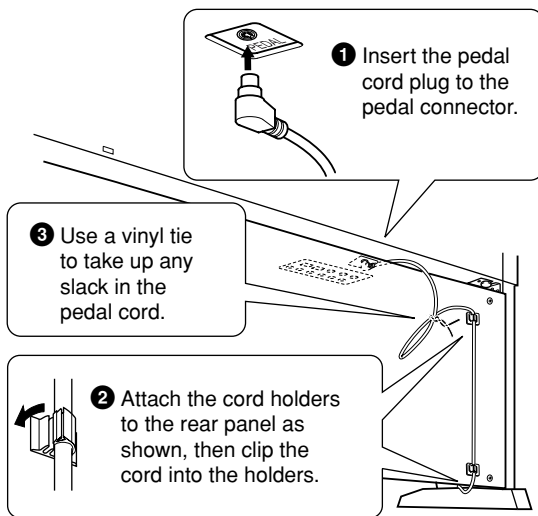

## 7 Set the voltage selector and connect the power cord.

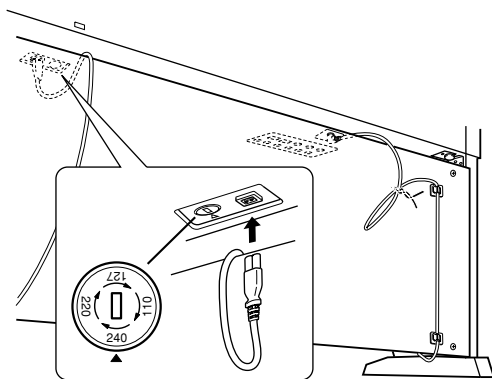

### Voltage Selector

Before connecting the AC power cord, check the setting of the voltage selector which is provided in some areas. To set the selector for 110V, 127V, 220V or 240V main voltages, use a "minus" screwdriver to rotate the selector dial so that the correct voltage for your region appears next to the pointer on the panel. The voltage selector is set at 240V when the unit is initially shipped.

After the proper voltage has been selected, connect the AC power cord to the AC INLET and an AC wall outlet. A plug adaptor may be also provided in some areas to match the pin configuration of the AC wall outlets in your area.

### ⚠ WARNING

An improper voltage setting can cause serious damage to the Clavinova or result in improper operation.

## 8 Set the adjuster.

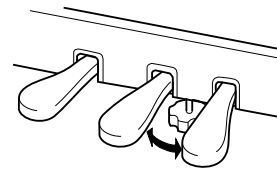

Rotate the adjuster until it comes in firm contact with the floor surface.

### ■ After completing the assembly, please check the following.

- Are there any parts left over?
  - Review the assembly procedure and correct any errors.
- Is the Clavinova clear of doors and other movable fixtures?
  - Move the Clavinova to an appropriate location.
- Does the Clavinova make a rattling noise when you shake it?
  - Tighten all screws.
- Does the pedal box rattle or give way when you step on the pedals?
  - Turn the adjuster so that it is set firmly against the floor.
- Are the pedal and power cords inserted securely into the sockets?
  - Check the connection.
- If the main unit creaks or is otherwise unsteady when you play on the keyboard, refer to the assembly diagrams and retighten all screws.

When moving the instrument after assembly, always hold the bottom of the main unit.

### ⚠ CAUTION

Do not hold the key cover or top portion. Improper handling can result in damage to the instrument or personal injury.

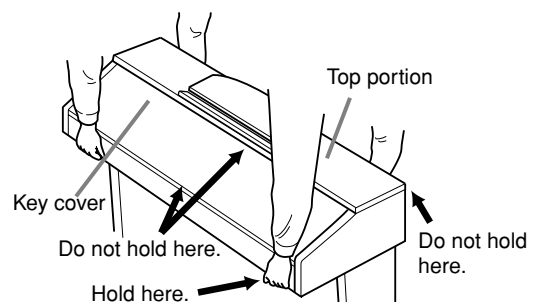

# Installing the Floppy Disk Drive (Included/Optional)

The floppy disk drive can be installed to the bottom of the instrument by using the included floppy disk drive case and screws. For a list of optional floppy disk drives available for this instrument, see "Optional Accessories" (page 210).

Have a Phillips-head (+) screwdriver ready.

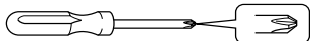

- 1** Remove the three backing papers from the adhesive tape in the case, and fit the floppy disk drive into the case.

Insert the drive to the case, with the side having the rubber stoppers facing the case.

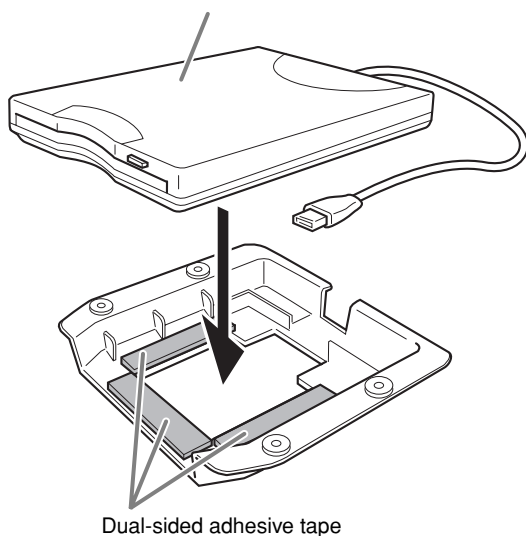

- 2** Fold the USB cable inside the case as shown.

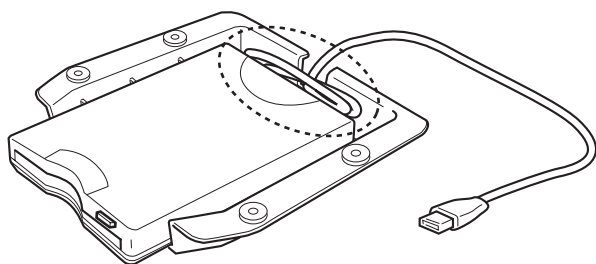

- 3** Attach the drive and case assembly to the left underside of the instrument, using the included four screws (4 mm x 10 mm).

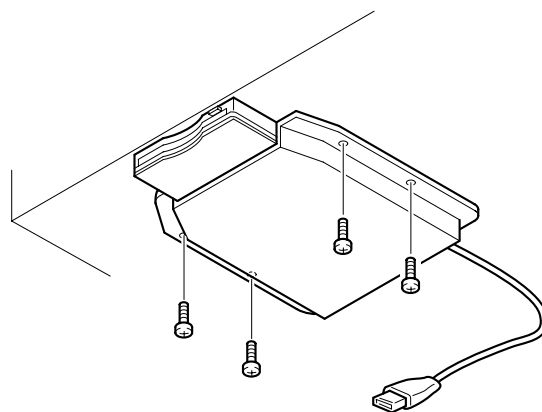

- 4** Connect the USB cable to the [USB TO DEVICE] terminal.



# Specifications

		CVP-305	CVP-303	CVP-301	
Sound Source		AWM Dynamic Stereo Sampling		AWM Stereo Sampling	
Keyboard		GH3 Keyboard 88 keys		GH Keyboard 88 keys	
Display		320 × 240 dots QVGA color LCD		320 × 240 dots QVGA B/W LCD	
Music Score, Lyrics		YES			
Voice	Polyphony (max)	128	96		
	Voice Selection	353 voices + 480 XG Voices 17 Drum/SFX Kits + GM2 + GS (GS Voices for GS Song playback)	319 voices + 480 XG Voices 14 Drum/SFX Kits + GM2 + GS (GS Voices for GS Song playback)	312 voices + 480 XG Voices 14 Drum/SFX Kits + GM2 + GS (GS Voices for GS Song playback)	
	Mega Voice	10	—		
	Regular Voice	261	271		
	Natural! Voice	21		14	
	Sweet! Voice	14	11		
	Cool! Voice	18	5		
	Live! Voice	19	1		
	Organ Flutes!	10			
Sound Creator		YES			
Effects	Effect Blocks	Reverb/ Chorus/ DSP	6		
		Micro- phone	1	—	
	Effect Types	Reverb/ Chorus/ DSP	Reverb: 35 Preset + 3 User Chorus: 30 Preset + 3 User DSP 1: 183 Preset + 3 User DSP2-4: 105 Preset + 10 User		
		Master EQ	5 Preset + 2 User		
		Part EQ	27 Parts		
Vocal Harmony		61 Preset + 10 User		—	
Accompani- ment Style	Accompaniment Styles	308	258	180	
		Pro Styles	248	208	133
		Session Styles	24	14	11
		Pianist Styles	36		
	Mega Voice Styles		YES	—	
	Fingering		Single Finger, Fingered, Fingered On Bass, Multi Finger, AI Fingered, Full Keyboard, AI Full Keyboard		
	Style Creator		YES		
	OTS (One Touch Setting)		4 for Each Style		
	OTS Link		YES		
	Music Finder	Preset	YES		
Edit		YES			
Song	Preset Songs		120	56	
	Guide		Follow Lights, Any Key, Karao-Key, Vocal CueTIME	Follow Lights, Any Key, Karao-Key	
	Guide Lamp		YES		
	Performance assistant technology		YES		
	Recording		Quick Recording, Multi Recording, Step Recording, Song Editing		
Record Channels		16			
Internet Direct Connection		External Adapter (via USB to DEVICE)			

		CVP-305	CVP-303	CVP-301
Memory Device	Floppy Disk (2HD, 2DD)	External Adapter (via USB to DEVICE)		
	Hard Disk	External Adapter (via USB to DEVICE)		
	Flash Memory (Internal)	1.5 MB	650KB	
	SmartMedia Slot	1 (Compatible with SmartMedia FAT 12 or 16 format.)		
Tempo	Tempo Range	5–500, Tap Tempo		
	Metronome	YES		
	Sound	Bell on/off, Human Voices (5 Languages)		
Registration Memory	Buttons	8		
	Regist. Sequence/Freeze	YES		
Others	Demo/Help	YES		
	Language for Display	6 Languages (English, Japanese, German, French, Spanish, Italian)	5 Languages (English, German, French, Spanish, Italian)	
	Direct Access	YES		
	Piano Button (incl. Piano Lock)	YES		
	Transpose	Keyboard/Song/Master		
	Scale Type	9		
USB Connection	USB to HOST (Computer)	YES		
	USB to DEVICE	YES		
Other Connectors		PHONES × 2, MIDI (THRU, OUT, IN), AUX PEDAL, AUX IN (L/L+R, R), AUX OUT (L/L+R, R), AUX OUT (LEVEL FIXED)(L, R)		
		MIC. (INPUT VOLUME, MIC./LINE IN), OPTICAL OUT, VIDEO OUT	MIC. (INPUT VOLUME, MIC./LINE IN)	—
Pedals	Functions	VOLUME, SUSTAIN, SOSTENUTO, SOFT, GLIDE, SONG PLAY/PAUSE, STYLE START/STOP, etc.		
Amplifiers/Speakers	Amplifiers	40 W × 2		
	Speakers	(16 cm + 5 cm) × 2		
Dimensions [W × D × H] (with the Music Rest)		1432 mm × 614 mm × 885 mm [56-3/8" × 24-3/16" × 34-13/16"] (1432 mm × 614 mm × 1042 mm) [56-3/8" × 24-3/16" × 41"]	1432 mm × 614 mm × 885 mm [56-3/8" × 24-3/16" × 34-13/16"] (1432 mm × 614 mm × 1044 mm) [56-3/8" × 24-3/16" × 41-1/8"]	1379 mm × 595 mm × 896 mm [54-5/16" × 23-7/16" × 35-1/4"] (1379 mm × 595 mm × 1070 mm) [54-5/16" × 23-7/16" × 42-1/8"]
Weight		86 kg (189 lbs., 10 oz)	70 kg (154 lbs., 5 oz)	68 kg (149 lbs., 15 oz)
Optional Accessories	Headphones	HPE-160		
	Foot Switch	FC 4/FC 5		
	Foot Controller	FC 7		
	USB-FDD Unit	UD-FD01		

\* Specifications and descriptions in this owner's manual are for information purposes only. Yamaha Corp. reserves the right to change or modify products or specifications at any time without prior notice. Since specifications, equipment or options may not be the same in every locale, please check with your Yamaha dealer.

## Numerics

1-16 ..... 138, 148

## A

A-B Repeat ..... 40  
 AI ..... 98  
 AI FINGERED ..... 98  
 AI FULL KEYBOARD ..... 98  
 Any key ..... 132  
 ARABIC ..... 77  
 Assembly ..... 202, 204, 206  
 ASSEMBLY (Style) ..... 112  
 Auto Accompaniment Feature ..... 44  
 AUTO REVOICE SETUP ..... 83

## B

Background (Lyrics) (CVP-305) ..... 53  
 Backup ..... 71  
 BALANCE ..... 39  
 BASIC ..... 108  
 BASS ..... 195  
 BOOKMARK ..... 171  
 Brightness (CVP-305/303) ..... 19  
 Browser ..... 176

## C

CARD ..... 26  
 Chain Playback ..... 128  
 CHANNEL ..... 116, 148  
 CHANNEL ON/OFF ..... 99  
 Characters ..... 67  
 CHORD ..... 138, 148  
 CHORD DETECT ..... 196  
 CHORD FINGERING ..... 97  
 Chord Tutor function ..... 48  
 COMMON ..... 90  
 CONFIG 1 ..... 30, 46, 99, 122  
 CONFIG 2 ..... 18, 19, 196  
 Contrast ..... 19  
 CONTROLLER ..... 90  
 Cool! ..... 72  
 COPY ..... 64  
 CUT ..... 65

## D

Damper Pedal ..... 29  
 DELETE ..... 65  
 Demo ..... 23  
 Demo (Voice) ..... 33  
 Direct Access ..... 58  
 DOC (Disk Orchestra Collection) ..... 191  
 Drums ..... 72  
 DSP ..... 78  
 DSP/DSP VARIATION ..... 78

## E

EDIT ..... 111  
 Edit (Bookmarks) ..... 173  
 Edit (Effect) ..... 85  
 Edit (EQ) ..... 87

Edit (Lyrics) ..... 148  
 Edit (Music Finder) ..... 104  
 Edit (OTS) ..... 50  
 Edit (Song) ..... 148  
 Edit (Style) ..... 113  
 Edit (Vocal Harmony) (CVP-305/303) ..... 157  
 Edit (Voice) ..... 89  
 EFFECT ..... 82  
 Effect (microphone) (CVP-305/303) ..... 54  
 Effect (Voice) ..... 78  
 Effect Return Level ..... 86  
 Effect Type ..... 84  
 EFFECT/EQ ..... 92  
 Entering characters ..... 67  
 Entering Characters (Internet Direct Connection) ..... 168  
 EQ (Equalizer) ..... 83  
 EQUAL TEMPERAMENT ..... 77  
 ESEQ ..... 191  
 EXIT ..... 61

## F

Factory Reset ..... 69  
 Factory-programmed Settings ..... 69  
 FADE IN/OUT (Song) ..... 127  
 FADE IN/OUT (Style) ..... 46  
 Fade In/Out time ..... 127  
 FADE IN/OUT/HOLD TIME ..... 99  
 Fast forward ..... 128  
 Favorite ..... 103  
 File ..... 60  
 File Selection Display ..... 25, 62  
 File Selection Display Basic Operation ..... 61  
 File Selection Display Configuration ..... 60  
 File/Folder Operations ..... 62  
 FILTER ..... 82, 155  
 FINGERED ..... 98  
 FINGERED ON BASS ..... 98  
 FOLDER ..... 67  
 Folder ..... 60  
 Follow lights ..... 132  
 Foot Controller ..... 30  
 FOOTAGE ..... 94, 95  
 Footage ..... 95  
 Footswitch ..... 30  
 Format ..... 62  
 FREEZE ..... 123  
 FULL KEYBOARD ..... 98  
 Function display ..... 26

-For information on the panel controls, see "Panel Controls" on page 12.  
 -For information on the jacks and connectors located on the bottom of the instrument, see "Using Your Instrument with Other Devices" on page 180.  
 -For Internet-related terms, see "Glossary of Internet Terms" on page 179  
 - For information on the parameters in the tab displays, refer to the tab names in this index.

**G**

GM System Level 1 .....	191
GM System Level 2 .....	191
GROOVE .....	114
GS .....	191
Guide .....	131
Guide Lamp .....	38
GUIDE LAMP ON/OFF .....	131
GUIDE LAMP TIMING .....	132

**H**

HARMONY .....	93
HARMONY/ECHO .....	78
Headphone Hanger .....	18
Headphones .....	17
HELP .....	57
Home Page .....	174
Hz .....	76

**I**

ICON .....	66
Initialize .....	69
Initializing Internet Settings .....	178
Internet Direct Connection .....	166
Internet Settings .....	175

**K**

Karaoke .....	52
Karao-key .....	132
key cover .....	14
Keyboard Parts .....	73
KEYBOARD/PANEL .....	29, 55
KIRNBERGER .....	77

**L**

LAN .....	176
Language .....	18
Left .....	73
Left Hold .....	48
Left Pedal .....	29
Live! .....	72
LYRICS .....	148
Lyrics .....	53

**M**

Main Display .....	25, 59
MASTER TUNE .....	76
MEAN-TONE .....	77
MEDIA .....	62, 130, 187
Mega Voice (CVP-305) .....	72
MELODIC MINOR .....	119
Messages .....	57
MIC SETTING (CVP-305/303) .....	160
microphone (CVP-305/303) .....	52
MICROPHONE SETTING (CVP-305/303) .....	160
MIDI .....	188
MIDI Settings .....	192
MIDI Templates .....	192
MIXING CONSOLE .....	80

MONO/POLY .....	78
MULTI FINGER .....	98
Multi track recording .....	133
Music Finder .....	50
Music Rest .....	16

**N**

NAME .....	66
Natural! .....	72
Notation .....	37

**O**

One Touch Setting .....	49
One-Handed Practice .....	38
Organ Flutes .....	93
Organ Flutes! .....	72
Others .....	177
OTS Link .....	50
OTS Link Timing .....	101
OVERALL SETTING .....	161
OWNER .....	18, 20
Owner Name .....	20

**P**

PANEL PART .....	81
PARAMETER .....	117
Part .....	73
PASTE .....	64, 65
Pause .....	128
PEDAL .....	182
pedals .....	29
pedal polarity .....	182
percussion sounds .....	33
performance assistant technology .....	42
Phrase Mark .....	128
PHRASE MARK REPEAT .....	128
Pianist .....	97
PIANO .....	90
Piano Lock .....	28
Portamento .....	78
Portamento Time .....	90
Practice Function .....	131
PRESET .....	26
Pro .....	97
PROPERTY .....	187
Prot. 1 .....	64
Prot. 2 Edit .....	64
Prot. 2 Orig .....	64
Punch In/Out Recording .....	149
PURE MAJOR .....	77
PURE MINOR .....	77
PYTHAGOREAN .....	77

**Q**

QUANTIZE .....	116
Quick Recording .....	133
QUICK START .....	129

**R**

RANDOM .....	128
Realtime Recording .....	107

REC MODE .....	148
RECEIVE .....	195
Record (Song) .....	41, 133
Record (Style) .....	107
REGISTRATION MEMORY .....	121
REGISTRATION SEQUENCE .....	124
REPEAT MODE .....	35, 128
Repeat Playback .....	128
Repeat Playback Function .....	40
Rewind .....	128
Right 1 .....	73
Right 2 .....	73

## S

SAVE .....	63
Save (Music Finder) .....	105
SCALE TUNE .....	76
Score .....	37
Search (Music Finder Records) .....	102
Section Set .....	101
Session .....	97
Set the polarity of the pedal .....	182
SFX .....	72
Sheet Music Braces .....	17
SINGLE FINGER .....	98
SMF (Standard MIDI file) .....	191
Song .....	34
SONG CH 1-8/9-16 .....	81
Song channels .....	137
Sostenuto Pedal .....	29
SOUND .....	91
Sound Creator .....	89
sound effects .....	33
Speaker setting .....	18
SPLIT POINT .....	100
Step Recording .....	107, 133
Stop ACMP .....	101
Style .....	44
Style Assembly .....	107
Style Creator .....	107
Style File .....	191
STYLE PART .....	81
Style parts .....	137
STYLE SETTING/SPLIT POINT .....	100
Style Structure .....	107
Style Touch .....	101
Sweet! .....	72
Synchro Start (Song) .....	127
Synchro Start (Style) .....	46
Synchro Stop .....	47
Synchro Stop Window .....	101
SYS/EX. ....	148
SYSTEM .....	194
SYSTEM RESET .....	69

## T

TALK .....	56
TALK SETTING .....	164
Tap function .....	127
Top .....	128
TRANSMIT .....	194
Transpose .....	53, 55, 76
TUNE .....	82

## U

UP .....	61
USER .....	26

## V

Vibrato .....	92
VIDEO OUT (CVP-305) .....	53
Vocal CueTIME (CVP-305/303) .....	132
VOCAL HARMONY (CVP-305/303) .....	157
Vocal Harmony (CVP-305/303) .....	54
VOCAL HARMONY EDIT (CVP-305/303) .....	158, 159
VOCAL HARMONY TYPE (CVP-305/303) .....	157
Voice .....	28, 31, 72
VOICE EFFECT .....	78
Voice Program Change Number .....	196
VOICE SET .....	96
VOL/ATTACK .....	95
VOL/VOICE .....	82

## W

WERCKMEISTER .....	77
Wireless LAN .....	177

## X

XF .....	191
XG .....	191

-For information on the panel controls, see “Panel Controls” on page 12.

-For information on the jacks and connectors located on the bottom of the instrument, see “Using Your Instrument with Other Devices” on page 180.

-For Internet-related terms, see “Glossary of Internet Terms” on page 179

- For information on the parameters in the tab displays, refer to the tab names in this index.

The followings are the titles, credits and copyright notices for fifty seven (57) of the songs pre-installed in this instrument (CVP-305/303):

#### **Alfie**

Theme from the Paramount Picture ALFIE  
Words by Hal David  
Music by Burt Bacharach  
Copyright © 1966 (Renewed 1994) by Famous Music Corporation  
International Copyright Secured All Rights Reserved

#### **All Shook Up**

Words and Music by Otis Blackwell and Elvis Presley  
Copyright © 1957 by Shalimar Music Corporation  
Copyright Renewed and Assigned to Elvis Presley Music  
All Rights Administered by Cherry River Music Co. and Chrysalis Songs  
International Copyright Secured All Rights Reserved

#### **Beauty And The Beast**

from Walt Disney's BEAUTY AND THE BEAST  
Lyrics by Howard Ashman  
Music by Alan Menken  
© 1991 Walt Disney Music Company and Wonderland Music Company, Inc.  
All Rights Reserved Used by Permission

#### **Bésame Mucho (Kiss Me Much)**

Music and Spanish Words by Consuelo Velazquez  
English Words by Sunny Skylar  
Copyright © 1941, 1943 by Promotora Hispano Americana de Musica, S.A.  
Copyrights Renewed  
All Rights Administered by Peer International Corporation  
International Copyright Secured All Rights Reserved

#### **Blue Hawaii**

from the Paramount Picture WAIKIKI WEDDING  
Words and Music by Leo Robin and Ralph Rainger  
Copyright © 1936, 1937 (Renewed 1963, 1964) by Famous Music Corporation  
International Copyright Secured All Rights Reserved

#### **Blue Moon**

Words by Lorenz Hart  
Music by Richard Rodgers  
© 1934 (Renewed 1962) METRO-GOLDWYN-MAYER INC.  
All Rights Controlled by EMI ROBBINS CATALOG INC. (Publishing) and WARNER BROS. PUBLICATIONS U.S. INC. (Print)  
All Rights Reserved Used by Permission

#### **Brazil**

Words and Music by Ray Barroso  
English lyrics by S. K. Russell  
Copyright © 1941 by Peer International Corporation  
Copyright Renewed  
International Copyright Secured All Rights Reserved

#### **California Girls**

Words and Music by Brian Wilson and Mike Love  
Copyright © 1965 IRVING MUSIC, INC.  
Copyright Renewed  
All Rights Reserved Used by Permission

#### **Can You Feel The Love Tonight**

from Walt Disney Pictures' THE LION KING  
Music by Elton John  
Lyrics by Tim Rice  
© 1994 Wonderland Music Company, Inc.  
All Rights Reserved Used by Permission

#### **Can't Help Falling In Love**

from the Paramount Picture BLUE HAWAII  
Words and Music by George David Weiss, Hugo Peretti and Luigi Creatore  
Copyright © 1961 by Gladys Music, Inc.  
Copyright Renewed and Assigned to Gladys Music  
All Rights Administered by Cherry Lane Music Publishing Company, Inc. and Chrysalis Music  
International Copyright Secured All Rights Reserved

#### **Chim Chim Cher-ee**

from Walt Disney's MARY POPPINS  
Words and Music by Richard M. Sherman and Robert B. Sherman  
© 1963 Wonderland Music Company, Inc.  
Copyright Renewed  
All Rights Reserved Used by Permission

#### **Do-Re-Mi**

from THE SOUND OF MUSIC  
Lyrics by Oscar Hammerstein II  
Music by Richard Rodgers  
Copyright © 1959 by Richard Rodgers and Oscar Hammerstein II  
Copyright Renewed  
WILLIAMSON MUSIC owner of publication and allied rights throughout the world  
International Copyright Secured All Rights Reserved

#### **Don't Be Cruel (To A Heart That's True)**

Words and Music by Otis Blackwell and Elvis Presley  
Copyright © 1956 by Unart Music Corporation and Elvis Presley Music, Inc.  
Copyright Renewed and Assigned to Elvis Presley Music  
All Rights Administered by Cherry River Music Co. and Chrysalis Songs  
International Copyright Secured All Rights Reserved

#### **Edelweiss**

from THE SOUND OF MUSIC  
Lyrics by Oscar Hammerstein II  
Music by Richard Rodgers  
Copyright © 1959 by Richard Rodgers and Oscar Hammerstein II  
Copyright Renewed  
WILLIAMSON MUSIC owner of publication and allied rights throughout the world  
International Copyright Secured All Rights Reserved

#### **Fly Me To The Moon (In Other Words)**

featured in the Motion Picture ONCE AROUND  
Words and Music by Bart Howard  
TRO - © Copyright 1954 (Renewed) Hampshire House Publishing Corp., New York, NY  
International Copyright Secured  
All Rights Reserved Including Public Performance For Profit  
Used by Permission

#### **Hey Jude**

Words and Music by John Lennon and Paul McCartney  
Copyright © 1968 Sony/ATV Songs LLC  
Copyright Renewed  
All Rights Administered by Sony/ATV Music Publishing, 8 Music Square West, Nashville, TN 37203  
International Copyright Secured All Rights Reserved

#### **Hound Dog**

Words and Music by Jerry Leiber and Mike Stoller  
Copyright © 1956 by Elvis Presley Music, Inc. and Lion Publishing Co., Inc.  
Copyright Renewed, Assigned to Gladys Music and Universal - MCA Music Publishing, A Division of Universal Studios, Inc.  
All Rights Administered by Cherry Lane Music Publishing Company, Inc. and Chrysalis Music  
International Copyright Secured All Rights Reserved

#### **I Just Called To Say I Love You**

Words and Music by Stevie Wonder  
© 1984 JOBETE MUSIC CO., INC. and BLACK BULL MUSIC  
c/o EMI APRIL MUSIC INC.  
All Rights Reserved International Copyright Secured Used by Permission

#### **I Left My Heart In San Francisco**

Words by Douglass Cross  
Music by George Cory  
© 1954 (Renewed 1982) COLGEMS-EMI MUSIC INC.  
All Rights Reserved International Copyright Secured Used by Permission

**In The Mood**

By Joe Garland  
Copyright © 1939, 1960 Shapiro, Bernstein & Co., Inc., New York  
Copyright Renewed  
International Copyright Secured All Rights Reserved  
Used by Permission

**Isn't She Lovely**

Words and Music by Stevie Wonder  
© 1976 JOBETE MUSIC CO., INC. and BLACK BULL MUSIC  
c/o EMI APRIL MUSIC INC.  
All Rights Reserved International Copyright Secured Used by Permission

**Let It Be**

Words and Music by John Lennon and Paul McCartney  
Copyright © 1970 Sony/ATV Songs LLC  
Copyright Renewed  
All Rights Administered by Sony/ATV Music Publishing, 8 Music Square West, Nashville, TN 37203  
International Copyright Secured All Rights Reserved

**Let's Twist Again**

Words by Kal Mann  
Music by Dave Appell and Kal Mann  
Copyright © 1961 Kalmann Music, Inc.  
Copyright Renewed  
All Rights Controlled and Administered by Spirit Two Music, Inc. (ASCAP)  
International Copyright Secured All Rights Reserved

**Linus And Lucy**

By Vince Guaraldi  
Copyright © 1965 LEE MENDELSON FILM PRODUCTIONS, INC.  
Copyright Renewed  
International Copyright Secured All Rights Reserved

**Love Story**

Theme from the Paramount Picture LOVE STORY  
Music by Francis Lai  
Copyright © 1970, 1971 (Renewed 1998, 1999) by Famous Music Corporation  
International Copyright Secured All Rights Reserved

**Lullaby Of Birdland**

Words by George David Weiss  
Music by George Shearing  
© 1952, 1954 (Renewed 1980, 1982) EMI LONGITUDE MUSIC  
All Rights Reserved International Copyright Secured Used by Permission

**Michelle**

Words and Music by John Lennon and Paul McCartney  
Copyright © 1965 Sony/ATV Songs LLC  
Copyright Renewed  
All Rights Administered by Sony/ATV Music Publishing, 8 Music Square West, Nashville, TN 37203  
International Copyright Secured All Rights Reserved

**Mickey Mouse March**

from Walt Disney's THE MICKEY MOUSE CLUB  
Words and Music by Jimmie Dodd  
© 1955 Walt Disney Music Company  
Copyright Renewed  
All Rights Reserved Used by Permission

**Mission: Impossible Theme**

from the Paramount Television Series MISSION: IMPOSSIBLE  
By Lalo Schifrin  
Copyright © 1966, 1967 (Renewed 1994, 1995) by Bruin Music Company  
International Copyright Secured All Rights Reserved

**Mona Lisa**

from the Paramount Picture CAPTAIN CAREY, U.S.A.  
Words and Music by Jay Livingston and Ray Evans  
Copyright © 1949 (Renewed 1976) by Famous Music Corporation  
International Copyright Secured All Rights Reserved

**Moon River**

from the Paramount Picture BREAKFAST AT TIFFANY'S  
Words by Johnny Mercer  
Music by Henry Mancini  
Copyright © 1961 (Renewed 1989) by Famous Music Corporation  
International Copyright Secured All Rights Reserved

**Moonlight Serenade**

Words by Mitchell Parish  
Music by Glen Miller  
Copyright © 1939 (Renewed 1967) by ROBBINS MUSIC CORPORATION  
All Rights Controlled and Administered by EMI ROBBINS CATALOG INC.  
International Copyright Secured All Rights Reserved

**My Favorite Things**

from THE SOUND OF MUSIC  
Lyrics by Oscar Hammerstein II  
Music by Richard Rodgers  
Copyright © 1959 by Richard Rodgers and Oscar Hammerstein II  
Copyright Renewed  
WILLIAMSON MUSIC owner of publication and allied rights throughout the world  
International Copyright Secured All Rights Reserved

**My Way**

By Paul Anka, Jacques Revaux, Claude Francois and Giles Thibault  
© 1997 by Chrysalis Standards, Inc.  
Used by Permission. All Rights Reserved.

**The Nearness Of You**

from the Paramount Picture ROMANCE IN THE DARK  
Words by Ned Washington  
Music by Hoagy Carmichael  
Copyright © 1937, 1940 (Renewed 1964, 1967) by Famous Music Corporation  
International Copyright Secured All Rights Reserved

**Theme From "New York, New York"**

Music by John Kander  
Words by Fred Ebb  
© 1977 UNITED ARTISTS CORPORATION  
All Rights Controlled by EMI UNART CATALOG INC. (Publishing) and WARNER BROS. PUBLICATIONS U.S. INC. (Print)  
All Rights Reserved Used by Permission

**Ob-La-Di, Ob-La-Da**

Words and Music by John Lennon and Paul McCartney  
Copyright © 1968 Sony/ATV Songs LLC  
Copyright Renewed  
All Rights Administered by Sony/ATV Music Publishing, 8 Music Square West, Nashville, TN 37203  
International Copyright Secured All Rights Reserved

**Proud Mary**

Words and Music by J.C. Fogerty  
© 1968 (Renewed) JONDORA MUSIC  
All Rights Reserved Used by Permission

**Return To Sender**

Words and Music by Otis Blackwell and Winfield Scott  
Copyright © 1962 by Elvis Presley Music, Inc.  
Copyright Renewed and Assigned to Elvis Presley Music  
All Rights Administered by Cherry River Music Co. and Chrysalis Songs  
International Copyright Secured All Rights Reserved

**The Shoop Shoop Song (It's In His Kiss)**

Words and Music by Rudy Clark  
Copyright © 1963, 1964 by Trio Music Company, Inc. and Top Of The Charts  
Copyright Renewed  
All Rights for the United States Controlled and Administered by Trio Music Company, Inc.  
All Rights for the World excluding the United States Controlled and Administered by Trio Music Company, Inc. and Alley Music Corp.  
International Copyright Secured All Rights Reserved  
Used by Permission

**(Sittin' On) The Dock Of The Bay**

Words and Music by Steve Cropper and Otis Redding  
Copyright © 1968, 1975 IRVING MUSIC, INC.  
Copyright Renewed  
All Rights Reserved Used by Permission

**Smoke Gets In Your Eyes**

from ROBERTA  
Words by Otto Harbach  
Music by Jerome Kern  
© 1933 UNIVERSAL - POLYGRAM INTERNATIONAL PUBLISHING, INC.  
Copyright Renewed  
All Rights Reserved  
International Rights Secured. Not for broadcast transmission.  
DO NOT DUPLICATE. NOT FOR RENTAL.

WARNING: It is a violation of Federal Copyright Law to synchronize this Multimedia Disc with video tape or film, or to print the Composition(s) embodied on this Multimedia Disc in the form of standard music notation, without the express written permission of the copyright owner.

**Somewhere, My Love**

Lara's Theme from DOCTOR ZHIVAGO  
Lyric by Paul Francis Webster  
Music by Maurice Jarre  
Copyright © 1965, 1966 (Renewed 1993, 1994) Webster Music Co. and EMI Robbins Catalog Inc.  
International Copyright Secured All Rights Reserved

**Spanish Eyes**

Words by Charles Singleton and Eddie Snyder  
Music by Bert Kaempfert  
© 1965, 1966 (Renewed 1993, 1994) EDITION DOMA BERT KAEMPFERT  
All Rights for the world, excluding Germany, Austria and Switzerland, Controlled and Administered by SCREEN GEMS-EMI MUSIC INC.  
All Rights Reserved International Copyright Secured Used by Permission

**Speak Softly, Love (Love Theme)**

from the Paramount Picture THE GODFATHER  
Words by Larry Kusik  
Music by Nino Rota  
Copyright © 1972 (Renewed 2000) by Famous Music Corporation  
International Copyright Secured All Rights Reserved

**Stella By Starlight**

from the Paramount Picture THE UNINVITED  
Words by Ned Washington  
Music by Victor Young  
Copyright © 1946 (Renewed 1973, 1974) by Famous Music Corporation  
International Copyright Secured All Rights Reserved

**Take The "A" Train**

Words and Music by Billy Strayhorn  
Copyright © 1941; Renewed 1969 DreamWorks Songs (ASCAP) and Billy Strayhorn Songs, Inc. (ASCAP) for the U.S.A.  
Rights for DreamWorks Songs and Billy Strayhorn Songs, Inc. Administered by Cherry Lane Music Publishing Company, Inc.  
International Copyright Secured All Rights Reserved

**Tears In Heaven**

Words and Music by Eric Clapton and Will Jennings  
Copyright © 1992 by E.C. Music Ltd. and Blue Sky Rider Songs  
All Rights for E.C. Music Ltd. Administered by Unichappell Music Inc.  
All Rights for Blue Sky Rider Songs Administered by Irving Music, Inc.  
International Copyright Secured All Rights Reserved

**That Old Black Magic**

from the Paramount Picture STAR SPANGLED RHYTHM  
Words by Johnny Mercer  
Music by Harold Arlen  
Copyright © 1942 (Renewed 1969) by Famous Music Corporation  
International Copyright Secured All Rights Reserved

**That's Amore (That's Love)**

from the Paramount Picture THE CADDY  
Words by Jack Brooks  
Music by Harry Warren  
Copyright © 1953 (Renewed 1981) by Paramount Music Corporation and Four Jays Music  
International Copyright Secured All Rights Reserved

**Up Where We Belong**

from the Paramount Picture AN OFFICER AND A GENTLEMAN  
Words by Will Jennings  
Music by Buffy Sainte-Marie and Jack Nitzsche  
Copyright © 1982 by Famous Music Corporation and Ensign Music Corporation  
International Copyright Secured All Rights Reserved

**Waltz For Debby**

Lyric by Gene Lees  
Music by Bill Evans  
TRO - © Copyright 1964 (Renewed), 1965 (Renewed), 1966 (Renewed) Folkways Music Publishers, Inc., New York, NY  
International Copyright Secured  
All Rights Reserved Including Public Performance For Profit  
Used by Permission

**White Christmas**

from the Motion Picture Irving Berlin's HOLIDAY INN  
Words and Music by Irving Berlin  
© Copyright 1940, 1942 by Irving Berlin  
Copyright Renewed  
International Copyright Secured All Rights Reserved

**A Whole New World**

from Walt Disney's ALADDIN  
Music by Alan Menken  
Lyrics by Tim Rice  
© 1992 Wonderland Music Company, Inc. and Walt Disney Music Company  
All Rights Reserved Used by Permission

**Yesterday**

Words and Music by John Lennon and Paul McCartney  
Copyright © 1965 Sony/ATV Songs LLC  
Copyright Renewed  
All Rights Administered by Sony/ATV Music Publishing, 8 Music Square West, Nashville, TN 37203  
International Copyright Secured All Rights Reserved

**You Are The Sunshine Of My Life**

Words and Music by Stevie Wonder  
© 1972 (Renewed 2000) JOBETE MUSIC CO., INC. and BLACK BULL MUSIC  
c/o EMI APRIL MUSIC INC.  
All Rights Reserved International Copyright Secured Used by Permission

**You Sexy Thing**

Words and Music by E. Brown  
Copyright © 1975 by Finchley Music Corp.  
Administered in the USA and Canada by Music & Media International, Inc.  
Administered for the World excluding the USA and Canada by RAK Music Publishing Ltd.  
International Copyright Secured All Rights Reserved



# IMPORTANT SAFETY INSTRUCTIONS

## INFORMATION RELATING TO PERSONAL INJURY, ELECTRICAL SHOCK, AND FIRE HAZARD POSSIBILITIES HAS BEEN INCLUDED IN THIS LIST.

**WARNING-** When using any electrical or electronic product, basic precautions should always be followed. These precautions include, but are not limited to, the following:

- 1.** Read all Safety Instructions, Installation Instructions, Special Message Section items, and any Assembly Instructions found in this manual **BEFORE** making any connections, including connection to the main supply.
- 2.** Main Power Supply Verification: Yamaha products are manufactured specifically for the supply voltage in the area where they are to be sold. If you should move, or if any doubt exists about the supply voltage in your area, please contact your dealer for supply voltage verification and (if applicable) instructions. The required supply voltage is printed on the name plate. For name plate location, please refer to the graphic found in the Special Message Section of this manual.
- 3.** This product may be equipped with a polarized plug (one blade wider than the other). If you are unable to insert the plug into the outlet, turn the plug over and try again. If the problem persists, contact an electrician to have the obsolete outlet replaced. Do **NOT** defeat the safety purpose of the plug.
- 4.** Some electronic products utilize external power supplies or adapters. Do **NOT** connect this type of product to any power supply or adapter other than one described in the owners manual, on the name plate, or specifically recommended by Yamaha.
- 5.** **WARNING:** Do not place this product or any other objects on the power cord or place it in a position where anyone could walk on, trip over, or roll anything over power or connecting cords of any kind. The use of an extension cord is not recommended! If you must use an extension cord, the minimum wire size for a 25' cord (or less) is 18 AWG. **NOTE:** The smaller the AWG number, the larger the current handling capacity. For longer extension cords, consult a local electrician.
- 6.** Ventilation: Electronic products, unless specifically designed for enclosed installations, should be placed in locations that do not interfere with proper ventilation. If instructions for enclosed installations are not provided, it must be assumed that unobstructed ventilation is required.
- 7.** Temperature considerations: Electronic products should be installed in locations that do not significantly contribute to their operating temperature. Placement of this product close to heat sources such as; radiators, heat registers and other devices that produce heat should be avoided.
- 8.** This product was **NOT** designed for use in wet/damp locations and should not be used near water or exposed to rain. Examples of wet/damp locations are; near a swimming pool, spa, tub, sink, or wet basement.
- 9.** This product should be used only with the components supplied or; a cart, rack, or stand that is recommended by the manufacturer. If a cart, rack, or stand is used, please observe all safety markings and instructions that accompany the accessory product.
- 10.** The power supply cord (plug) should be disconnected from the outlet when electronic products are to be left unused for extended periods of time. Cords should also be disconnected when there is a high probability of lightning and/or electrical storm activity.
- 11.** Care should be taken that objects do not fall and liquids are not spilled into the enclosure through any openings that may exist.
- 12.** Electrical/electronic products should be serviced by a qualified service person when:
  - a. The power supply cord has been damaged; or
  - b. Objects have fallen, been inserted, or liquids have been spilled into the enclosure through openings; or
  - c. The product has been exposed to rain; or
  - d. The product does not operate, exhibits a marked change in performance; or
  - e. The product has been dropped, or the enclosure of the product has been damaged.
- 13.** Do not attempt to service this product beyond that described in the user-maintenance instructions. All other servicing should be referred to qualified service personnel.
- 14.** This product, either alone or in combination with an amplifier and headphones or speaker/s, may be capable of producing sound levels that could cause permanent hearing loss. **DO NOT** operate for a long period of time at a high volume level or at a level that is uncomfortable. If you experience any hearing loss or ringing in the ears, you should consult an audiologist. **IMPORTANT:** The louder the sound, the shorter the time period before damage occurs.
- 15.** Some Yamaha products may have benches and/or accessory mounting fixtures that are either supplied as a part of the product or as optional accessories. Some of these items are designed to be dealer assembled or installed. Please make sure that benches are stable and any optional fixtures (where applicable) are well secured **BEFORE** using. Benches supplied by Yamaha are designed for seating only. No other uses are recommended.

## PLEASE KEEP THIS MANUAL

## FCC INFORMATION (U.S.A.)

### 1. **IMPORTANT NOTICE: DO NOT MODIFY THIS UNIT!**

This product, when installed as indicated in the instructions contained in this manual, meets FCC requirements. Modifications not expressly approved by Yamaha may void your authority, granted by the FCC, to use the product.

2. **IMPORTANT:** When connecting this product to accessories and/or another product use only high quality shielded cables. Cable/s supplied with this product **MUST** be used. Follow all installation instructions. Failure to follow instructions could void your FCC authorization to use this product in the USA.
3. **NOTE:** This product has been tested and found to comply with the requirements listed in FCC Regulations, Part 15 for Class "B" digital devices. Compliance with these requirements provides a reasonable level of assurance that your use of this product in a residential environment will not result in harmful interference with other electronic devices. This equipment generates/uses radio frequencies and, if not installed and used according to the instructions found in the users manual, may cause interference harmful to the operation of

other electronic devices. Compliance with FCC regulations does not guarantee that interference will not occur in all installations. If this product is found to be the source of interference, which can be determined by turning the unit "OFF" and "ON", please try to eliminate the problem by using one of the following measures:

Relocate either this product or the device that is being affected by the interference.

Utilize power outlets that are on different branch (circuit breaker or fuse) circuits or install AC line filter/s.

In the case of radio or TV interference, relocate/reorient the antenna. If the antenna lead-in is 300 ohm ribbon lead, change the lead-in to co-axial type cable.

If these corrective measures do not produce satisfactory results, please contact the local retailer authorized to distribute this type of product. If you can not locate the appropriate retailer, please contact Yamaha Corporation of America, Electronic Service Division, 6600 Orangethorpe Ave, Buena Park, CA90620

The above statements apply **ONLY** to those products distributed by Yamaha Corporation of America or its subsidiaries.

\* This applies only to products distributed by YAMAHA CORPORATION OF AMERICA.

(class B)

### IMPORTANT NOTICE FOR THE UNITED KINGDOM

#### Connecting the Plug and Cord

**IMPORTANT.** The wires in this mains lead are coloured in accordance with the following code:

BLUE : NEUTRAL  
BROWN : LIVE

As the colours of the wires in the mains lead of this apparatus may not correspond with the coloured markings identifying the terminals in your plug proceed as follows:

The wire which is coloured BLUE must be connected to the terminal which is marked with the letter N or coloured BLACK.

The wire which is coloured BROWN must be connected to the terminal which is marked with the letter L or coloured RED.

Making sure that neither core is connected to the earth terminal of the three pin plug.

(2 wires)

- This applies only to products distributed by Yamaha-Kemble Music (U.K.) Ltd.

This product contains a high intensity lamp that contains a small amount of mercury. Disposal of this material may be regulated due to environmental considerations.

For disposal information in the United States, refer to the Electronic Industries Alliance web site:  
[www.eiae.org](http://www.eiae.org)

\* This applies only to products distributed by YAMAHA CORPORATION OF AMERICA.

(mercury)

**CAUTION:** TO PREVENT ELECTRIC SHOCK, MATCH WIDE BLADE OF PLUG TO WIDE SLOT, FULLY INSERT.

**ATTENTION:** POUR ÉVITER LES CHOCS ÉLECTRIQUES, INTRODUIRE LA LAME LA PLUS LARGE DE LA FICHE DANS LA BORNE CORRESPONDANTE DE LA PRISE ET POUSSER JUSQU'AU FOND.

(polarity)

- This applies only to products distributed by Yamaha Canada Music Ltd.
- Ceci ne s'applique qu'aux produits distribués par Yamaha Canada Musique Ltée.

For details of products, please contact your nearest Yamaha representative or the authorized distributor listed below.

Pour plus de détails sur les produits, veuillez-vous adresser à Yamaha ou au distributeur le plus proche de vous figurant dans la liste suivante.

Die Einzelheiten zu Produkten sind bei Ihrer unten aufgeführten Niederlassung und bei Yamaha Vertragshändlern in den jeweiligen Bestimmungsländern erhältlich.

Para detalles sobre productos, contacte su tienda Yamaha más cercana o el distribuidor autorizado que se lista debajo.

## NORTH AMERICA

### CANADA

**Yamaha Canada Music Ltd.**  
135 Milner Avenue, Scarborough, Ontario,  
M1S 3R1, Canada  
Tel: 416-298-1311

### U.S.A.

**Yamaha Corporation of America**  
6600 Orangethorpe Ave., Buena Park, Calif. 90620,  
U.S.A.  
Tel: 714-522-9011

## CENTRAL & SOUTH AMERICA

### MEXICO

**Yamaha de México S.A. de C.V.**  
Calz. Javier Rojo Gómez #1149,  
Col. Guadalupe del Moral  
C.P. 09300, México, D.F., México  
Tel: 55-5804-0600

### BRAZIL

**Yamaha Musical do Brasil Ltda.**  
Av. Reboucas 2636-Pinheiros CEP: 05402-400  
Sao Paulo-SP, Brasil  
Tel: 011-3085-1377

### ARGENTINA

**Yamaha Music Latin America, S.A.**  
**Sucursal de Argentina**  
Viamonte 1145 Piso2-B 1053,  
Buenos Aires, Argentina  
Tel: 1-4371-7021

### PANAMA AND OTHER LATIN AMERICAN COUNTRIES/ CARIBBEAN COUNTRIES

**Yamaha Music Latin America, S.A.**  
Torre Banco General, Piso 7, Urbanización Marbella,  
Calle 47 y Aquilino de la Guardia,  
Ciudad de Panamá, Panamá  
Tel: +507-269-5311

## EUROPE

### THE UNITED KINGDOM

**Yamaha-Kemble Music (U.K.) Ltd.**  
Sherbourne Drive, Tilbrook, Milton Keynes,  
MK7 8BL, England  
Tel: 01908-366700

### IRELAND

**Danfay Ltd.**  
61D, Sallynoggin Road, Dun Laoghaire, Co. Dublin  
Tel: 01-2859177

### GERMANY

**Yamaha Music Central Europe GmbH**  
Siemensstraße 22-34, 25462 Rellingen, Germany  
Tel: 04101-3030

### SWITZERLAND/LIECHTENSTEIN

**Yamaha Music Central Europe GmbH,**  
**Branch Switzerland**  
Seefeldstrasse 94, 8008 Zürich, Switzerland  
Tel: 01-383 3990

### AUSTRIA

**Yamaha Music Central Europe GmbH,**  
**Branch Austria**  
Schleiergasse 20, A-1100 Wien, Austria  
Tel: 01-60203900

### THE NETHERLANDS

**Yamaha Music Central Europe,**  
**Branch Nederland**  
Clarissenhof 5-b, 4133 AB Vianen, The Netherlands  
Tel: 0347-358 040

### BELGIUM/LUXEMBOURG

**Yamaha Music Central Europe GmbH,**  
**Branch Belgium**  
Rue de Geneve (Genevastraat) 10, 1140 - Brussels,  
Belgium  
Tel: 02-726 6032

### FRANCE

**Yamaha Musique France**  
BP 70-77312 Marne-la-Vallée Cedex 2, France  
Tel: 01-64-61-4000

### ITALY

**Yamaha Musica Italia S.P.A.**  
Viale Italia 88, 20020 Lainate (Milano), Italy  
Tel: 02-935-771

### SPAIN/PORTUGAL

**Yamaha-Hazen Música, S.A.**  
Ctra. de la Corona km. 17, 200, 28230  
Las Rozas (Madrid), Spain  
Tel: 91-639-8888

### GREECE

**Philippos Nakas S.A. The Music House**  
147 Skiathou Street, 112-55 Athens, Greece  
Tel: 01-228 2160

### SWEDEN

**Yamaha Scandinavia AB**  
J. A. Wettergrens Gata 1  
Box 30053  
S-400 43 Göteborg, Sweden  
Tel: 031 89 34 00

### DENMARK

**YS Copenhagen Liaison Office**  
Generatorvej 6A  
DK-2730 Herlev, Denmark  
Tel: 44 92 49 00

### FINLAND

**F-Musiikki Oy**  
Kluuvikatu 6, P.O. Box 260,  
SF-00101 Helsinki, Finland  
Tel: 09 618511

### NORWAY

**Norsk filial av Yamaha Scandinavia AB**  
Grini Næringspark 1  
N-1345 Østerås, Norway  
Tel: 67 16 77 70

### ICELAND

**Skifan HF**  
Skeifan 17 P.O. Box 8120  
IS-128 Reykjavik, Iceland  
Tel: 525 5000

### OTHER EUROPEAN COUNTRIES

**Yamaha Music Central Europe GmbH**  
Siemensstraße 22-34, 25462 Rellingen, Germany  
Tel: +49-4101-3030

## AFRICA

**Yamaha Corporation,**  
**Asia-Pacific Music Marketing Group**  
Nakazawa-cho 10-1, Hamamatsu, Japan 430-8650  
Tel: +81-53-460-2312

## MIDDLE EAST

### TURKEY/CYPRUS

**Yamaha Music Central Europe GmbH**  
Siemensstraße 22-34, 25462 Rellingen, Germany  
Tel: 04101-3030

### OTHER COUNTRIES

**Yamaha Music Gulf FZE**  
LB21-128 Jebel Ali Freezone  
P.O.Box 17328, Dubai, U.A.E.  
Tel: +971-4-881-5868

## ASIA

### THE PEOPLE'S REPUBLIC OF CHINA

**Yamaha Music & Electronics (China) Co., Ltd.**  
25/F., United Plaza, 1468 Nanjing Road (West),  
Jingan, Shanghai, China  
Tel: 021-6247-2211

### HONG KONG

**Tom Lee Music Co., Ltd.**  
11/F., Silvercord Tower 1, 30 Canton Road,  
Tsimshatsui, Kowloon, Hong Kong  
Tel: 2737-7688

### INDONESIA

**PT. Yamaha Music Indonesia (Distributor)**  
**PT. Nusantik**  
Gedung Yamaha Music Center, Jalan Jend. Gatot  
Subroto Kav. 4, Jakarta 12930, Indonesia  
Tel: 21-520-2577

### KOREA

**Yamaha Music Korea Ltd.**  
Tong-Yang Securities Bldg. 16F 23-8 Yoido-dong,  
Yongdungpo-ku, Seoul, Korea  
Tel: 02-3770-0660

### MALAYSIA

**Yamaha Music Malaysia, Sdn., Bhd.**  
Lot 8, Jalan Perbandaran, 47301 Kelana Jaya,  
Petaling Jaya, Selangor, Malaysia  
Tel: 3-78030900

### PHILIPPINES

**Yupangco Music Corporation**  
339 Gil J. Puyat Avenue, P.O. Box 885 MCPO,  
Makati, Metro Manila, Philippines  
Tel: 819-7551

### SINGAPORE

**Yamaha Music Asia Pte., Ltd.**  
#03-11 A-Z Building  
140 Paya Lebar Road, Singapore 409015  
Tel: 747-4374

### TAIWAN

**Yamaha KHS Music Co., Ltd.**  
3F, #6, Sec.2, Nan Jing E. Rd. Taipei.  
Taiwan 104, R.O.C.  
Tel: 02-2511-8688

### THAILAND

**Siam Music Yamaha Co., Ltd.**  
891/1 Siam Motors Building, 15-16 floor  
Rama 1 road, Wangmai, Pathumwan  
Bangkok 10330, Thailand  
Tel: 02-215-2626

### OTHER ASIAN COUNTRIES

**Yamaha Corporation,**  
**Asia-Pacific Music Marketing Group**  
Nakazawa-cho 10-1, Hamamatsu, Japan 430-8650  
Tel: +81-53-460-2317

## OCEANIA

### AUSTRALIA

**Yamaha Music Australia Pty. Ltd.**  
Level 1, 99 Queensbridge Street, Southbank,  
Victoria 3006, Australia  
Tel: 3-9693-5111

### NEW ZEALAND

**Music Houses of N.Z. Ltd.**  
146/148 Captain Springs Road, Te Papapa,  
Auckland, New Zealand  
Tel: 9-634-0099

### COUNTRIES AND TRUST TERRITORIES IN PACIFIC OCEAN

**Yamaha Corporation,**  
**Asia-Pacific Music Marketing Group**  
Nakazawa-cho 10-1, Hamamatsu, Japan 430-8650  
Tel: +81-53-460-2312



**Clavinova Web site (English only)**

<http://www.yamahaclavinova.com/>

**Yamaha Manual Library**

<http://www2.yamaha.co.jp/manual/english/>