

# YAMAHA

THE OFFICIAL PUBLICATION OF THE YAMAHA USERS GROUP

## RX5



MARCH 1987

 **YAMAHA®**

**Editor**  
Tom Darter

**Operations**  
Sibyl Darter

**Editorial Board**  
Bob Frye  
Bill Hinely  
Mark Koenig  
Jim Smerdel

**Cover Photograph**  
Jim Hagopian

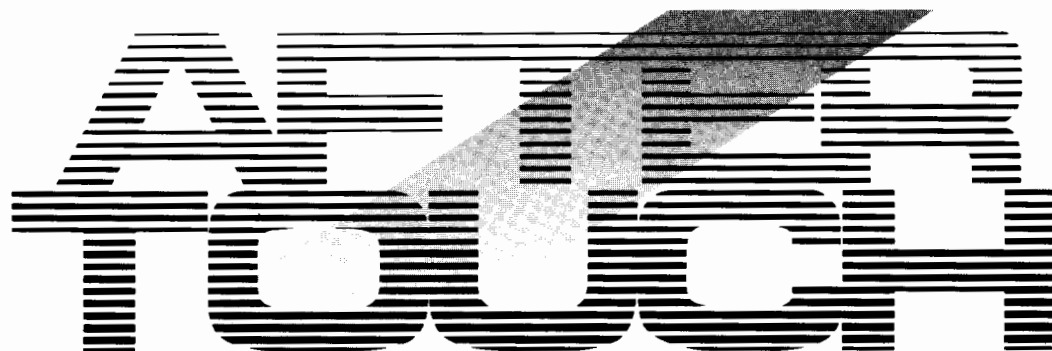

March 1987

Volume, 3, Number 3  
Issue #18

- 4 ENTRANCE**  
A new DX9 voice created by Eldon J. Cheramie.
- 5 MIX ECHO**  
A new DX9 voice created by Eldon J. Cheramie.
- 6 ANALOG STRINGS 1**  
A new DX9 voice created by Dawn Livingston.
- 7 STARLIGHT SPARKS**  
A new DX9 voice created by Peter Van der Zee.
- 8 QX5**  
Part two of a detailed, two-part guide to creating music with the QX5 digital sequence recorder. By Scott Plunkett.
- 10 RX5**  
An introduction to Yamaha's new digital rhythm programmer.  
By Tom Darter.
- 17 Dark Voice**  
A new TX81Z Performance setup created by Michael A. Huisman.
- 18 Brs'n'Wind**  
A new TX81Z Performance setup created by Michael A. Huisman.
- 19 DX Music Sessions**  
A new educational booklet and cassette tape for use with DX100 and DX27 synthesizers.

AFTERTOUCHE is published monthly. Third class postage paid at Long Prairie, MN and additional points of entry.  
**SUBSCRIPTIONS:** Free. Address subscription correspondence to AFTERTOUCHE, P.O. Box 2338, Northridge, CA 91323-2338. **POSTMASTER:** Send form 3579 to P.O. Box 2338, Northridge, CA 91323-2338.

©1987 Yamaha International Corporation. No part of this publication may be reproduced, stored in a retrieval system, or transmitted in any form or by any means, electronically, mechanically, photocopying, recording, or otherwise, without the prior written permission of Yamaha International Corporation.



# From The Editor

**A**FTERTOUCHE MARCHES ON! In this issue, we take a close look at yet another new Yamaha product, the RX5 digital rhythm programmer. You will also find part 2 of our in-depth look at the new QX5 digital sequence recorder. And, as promised, 4-operator patches: From AfterTouch readers, four new patches for the DX9, plus some special new voices for the TX81Z FM digital tone generator (which was the cover subject of the February 1987 issue of AfterTouch).

Also, we want to thank the thousands of readers who participated in the first AfterTouch/Yamaha Reader Survey. Your response was most gratifying. All of you who sent in a completed questionnaire will soon be receiving a Yamaha T-shirt. We will announce the winner of the Grand Prize (a complete YCAM System) in the next issue.

Finally, it is time yet again to reprint some important information about AfterTouch subscriptions, AfterTouch back issues, and Yamaha product literature. Longtime AfterTouch readers may be very familiar with the procedures regarding all of these items, but we still get many questions on these topics every month from newer readers. I want to make sure that all of you know exactly how to get the service you want as quickly as possible, so here goes:

**Warranty Cards & AfterTouch:** We have received a number of letters from Yamaha users complaining that they expected an AfterTouch subscription because they recently purchased a Yamaha product and sent in a warranty card, but still haven't received an issue. It is true that our initial (1985) mailing was developed from a

warranty card list, but no subscriptions were sent to those names—just a sample mailing of the first three issues. In order to receive a free subscription, you need to send us your request on the attached postcard below. And remember, don't combine your subscription request with a request for back issues: Send the two separately.

**Back Issues:** If a request for back issues is combined with a subscription request or other material, chances are it will not be fulfilled. All requests for AfterTouch subscriptions must go to our Mailing List input service. After the addresses are entered, the letters are normally kept on file, in keeping with various postal regulations. To be absolutely sure that you receive any available back issues that you want, make back issue request separately, and include the indication "ATTN: Back Issues" on the envelope. Please do not send back issue requests on the attached subscription postcard.

**Product Literature:** All requests for specific product literature must go directly to Yamaha [Yamaha International Corp., P.O. Box 6600, Buena Park, CA 90622]. We at AfterTouch are happy to receive specific questions concerning the use of Yamaha professional music products, and we will answer as many of them as we can in the Questions column; however, requests for general product information must be sent directly to Yamaha.

We are very happy to offer AfterTouch as a free informational service. In order to make sure that we can serve your needs (and continue to offer these various services free), we must ask you to help us by sending different requests in different envelopes. Thanks. —TD

**AFTER-TOUCH** is a monthly informational publication from Yamaha

## Receive AfterTouch Free Every Month!

**Y**OU CAN RECEIVE AFTERTOUCHE for an entire year, absolutely free, just by asking. If you are not already on our mailing list and would like to be, fill out the attached postcard. Be sure to sign the card (a postal regulation); it lets us know that you *really* want to receive AfterTouch.

After you have filled in the relevant information, put a stamp on the postcard and mail it to us. When we receive the card, we'll put you on our permanent mailing list, and you will receive twelve issues of AfterTouch absolutely free! There is absolutely no obligation, and no other strings are attached.

(By the way, if you received *this* issue in the mail, you are already on our permanent mailing list, so you don't need to send in another card.)

Also, don't limit yourself to just sending in your address: Let us know what you want to read, and what *you* have to offer (see page 19 for details). We look forward to your input.

To receive **AFTER-TOUCH** every month, absolutely free, just put your name and address on the enclosed card and mail it to us.

# DX9

**ENTRANCE.**  
A New DX9  
Voice By Eldon  
J. Cheramie.

These DX9 voices can also be loaded into all of Yamaha's 6-operator FM digital synthesizers and tone generators (such as the DX7, DX5, TX7, TX216, TX816, TF1, DX1, and DX7 11 FD/D), simply by finding an appropriate algorithm and using only 4 of the 6 operators.

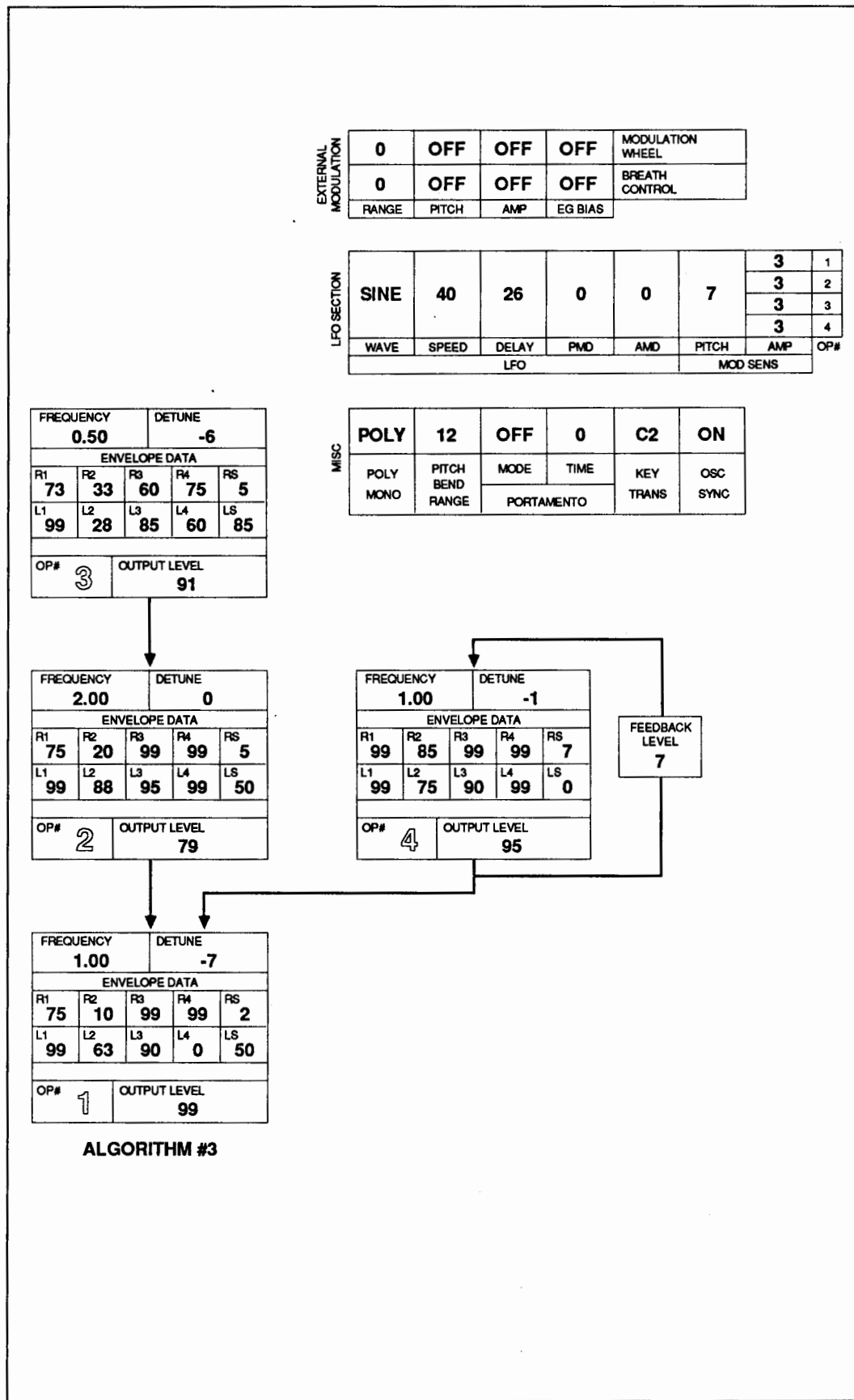

# DX9

MIX ECHO.  
A New DX9  
Voice By Eldon  
J. Chermie

POLY	12	OFF	0	C2	ON
POLY MONO	PITCH BEND RANGE	MODE	TIME	KEY TRANS	OSC SYNC

MSC

0	OFF	OFF	OFF	OFF	OFF
0	OFF	OFF	OFF	EG BIAS	
RANGE	PITCH	AMP			

EXTERNAL MODULATION

S/H	50	0	0	37	3	0	1
						3	2
						3	3
						3	4
WAVE	SPEED	DELAY	PWD	AMD	PITCH	AMP	OP#

LFO SECTION

FREQUENCY	4.00	DETUNE	+2
ENVELOPE DATA			
R1	95	R2	90
R3	90	R4	32
RS	0	L1	99
L2	99	L3	99
L4	0	LS	0
OP#	4	OUTPUT LEVEL 82	

FEEDBACK LEVEL	5
----------------	---

FREQUENCY	8.00	DETUNE	0
ENVELOPE DATA			
R1	34	R2	99
R3	99	R4	65
RS	0	L1	99
L2	99	L3	99
L4	0	LS	0
OP#	1	OUTPUT LEVEL 95	

FREQUENCY	2.00	DETUNE	0
ENVELOPE DATA			
R1	25	R2	99
R3	99	R4	60
RS	0	L1	99
L2	99	L3	99
L4	0	LS	0
OP#	2	OUTPUT LEVEL 99	

FREQUENCY	4.00	DETUNE	+7
ENVELOPE DATA			
R1	99	R2	41
R3	40	R4	32
RS	0	L1	99
L2	99	L3	95
L4	0	LS	0
OP#	3	OUTPUT LEVEL 96	

ALGORITHM #6

# DX9

## ANALOG STRINGS 1. A New DX9 Voice By Dawn Livingston.

Notes:

Engage Mod wheel slightly for "chorusing" effect.

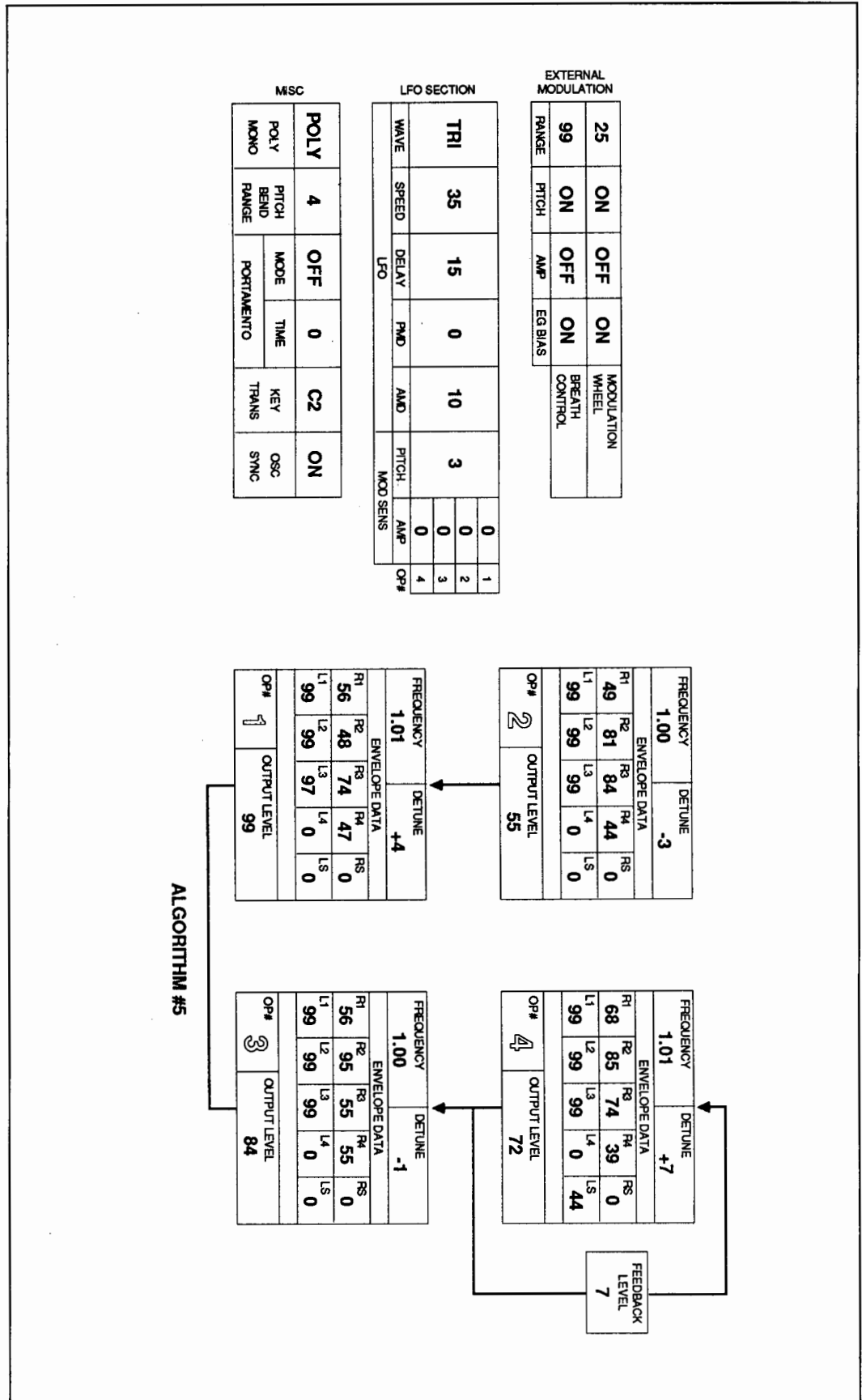

# DX9

STARLIGHT SPARKS. A  
New DX9  
Voice By Peter  
Van der Zee

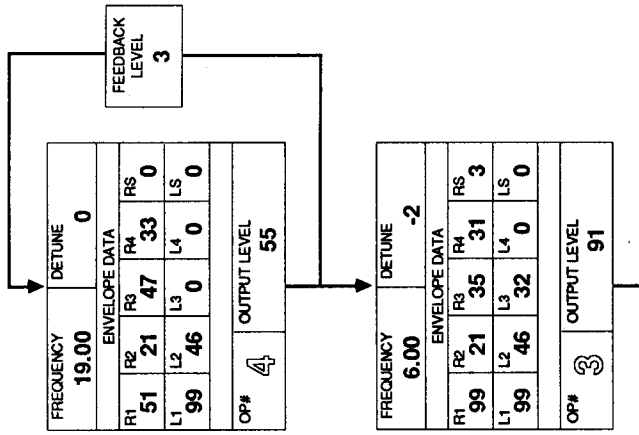

ALGORITHM #5

EXTERNAL MODULATION		MODULATION WHEEL	
0	OFF	OFF	OFF
99	ON	OFF	OFF
RANGE	PITCH	AMP	EG BIAS

LFO SECTION				MOD SENS	
SINE	WAVE	SPEED	DELAY	PMD	AMP
	23	35	19	60	1
	0	0	0	0	0
	0	0	0	0	0
					OP#

MSC		PORTAMENTO		OSC SYNC	
POLY	PITCH BEND RANGE	MODE	TIME	KEY TRANS	OSC SYNC
	12	OFF	0		
POLY MONO				C3	ON

# QX5

## A Detailed Guide To Creating Music With The QX5 Digital Sequence Recorder, Part 2. By Scott Plunkett.

THE YAMAHA QX5 Digital Sequence Recorder is a sophisticated MIDI sequencer that offers a wide variety of composing and arranging options. In Part 1 of this article (in the February 1987 issue of *AfterTouch*), we explored some of the important features of the unit, and discussed one possible approach to configuring tracks and organizing your musical work. In this month's installment (Part 2), we will look at some alternative ways to organize our compositions using tracks and macros, and will also take a close look at a few of the QX5's most powerful features. (For a brief descriptive overview of the QX5, see the introductory article on the QX5 in the December 1986 issue of *AfterTouch*.)

### Alternative Track Configurations

The approach outlined last month is only one possible way of configuring tracks when you are working with the QX5. Since each track is capable of containing data from all 16 MIDI channels, you can configure them in an almost limitless number of ways. There are three main approaches to track use: 1) Each track represents an instrument in a composition (the track layout from last month's installment illustrates this method); 2) Each track represents a part in a song; and 3) Each track represents a complete song.

Some musicians find it convenient to put different parts of a song on different tracks. This is similar to the macro recording technique used last month to build up the drum track. But rather than put the individual sections of the song on different macros, as described last month, you put them on different tracks. This method can be useful when you have a short musical idea that you want to arrange and work on before you have decided on a song structure. You may want to work on a 16 bar "groove," adding the bass, drum, and keyboard parts to see if it will work better as a verse or as a chorus. When you are finished, you can put this part on Track 8 and begin working on another section of the song. Using this approach, the track arrangement will eventually look something like this:

Track 1	blank
Track 2	blank
Track 3	intro
Track 4	verse 1

Track 5	chorus 1 & chorus 2
Track 6	verse 2
Track 7	bridge
Track 8	final chorus

While this method of writing can be convenient, it can also waste a tremendous amount of memory. If you have a number of repeating parts, consider putting them in macros. As always, try using a combination of tracks and macros to get the best mix of convenience and efficiency.

If you want to use the QX5 in live performance, you can put complete songs on each track. This makes it possible to go from song to song by turning tracks on and off. As you select each song you must also enter the proper tempo. You can avoid having to do too much tempo changing, though, by using the three Tempo Memories to set the most commonly used tempos before each performance.

The only potential problem is that memory use is critical when you are putting entire songs on each track. Try to avoid including too many songs with dense arrangements. Make extensive use of macros, and use the Remove (Measure Edit) and Thin Out (Track Edit) commands whenever possible to take out unnecessary data.

If you need the QX5 to play more than eight songs (1 for each track) during a performance, you will need to load the new songs into memory at some point. You can tape load from cassette, but since this can take fairly long if lots of data is involved, there will need to be a short break in the action while the QX5 is loading. A much faster and more reliable solution is to use a computer or special disk drive to load the sequences as MIDI System Exclusive bulk data. Devices like the Yamaha MDF1 MIDI Data Filer allow you to load new songs more efficiently. The MDF1 uses a 2.8" Quick Disk to store MIDI System Exclusive bulk data from any MIDI device. With the MDF1 you can load songs quickly into the QX5 (individually or in groups).

### Auto Locate

In last month's installment, we discussed Punch In Recording. The Auto Locate function can help you further automate this process. As mentioned last time, the actual punch-in and punch-out points may be specified as any measure in the song. These measures are indicated



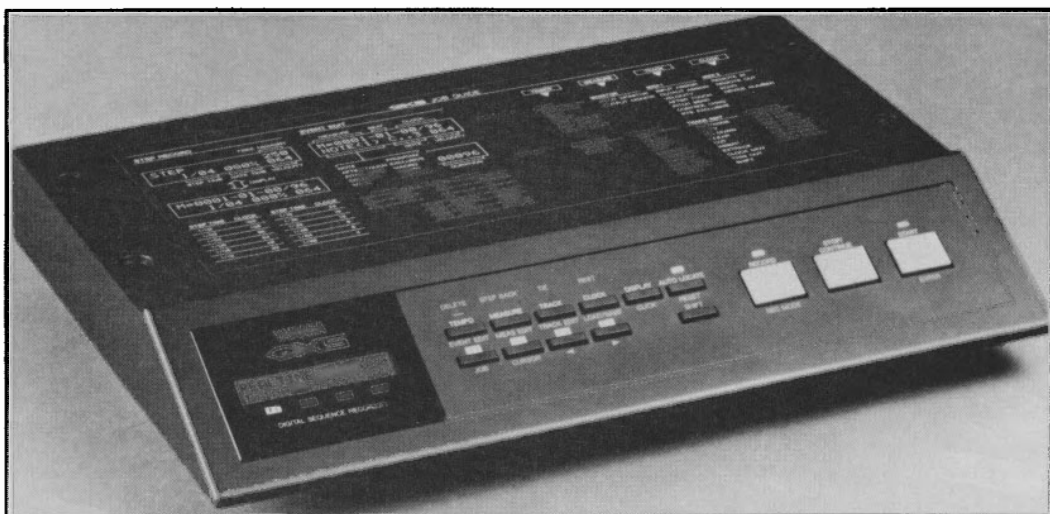

QX5 digital sequence recorder.

by F3 and F4 in the LCD display. You can also specify a measure before the actual punch-in point from which playback will begin. This "pre-roll" measure is represented by F2 in the LCD display.

Switch the Auto Locate function on, call the Punch Record mode, and press Start to initiate recording. Playback will begin from the F2 measure, and recording will begin at the F3 measure. Recording will stop at the punch-out point (the F4 measure). Auto Locate will also work with the Realtime Record mode!

### Event Edit

One of the most powerful features of the QX5 is Event Edit. In this mode you can change almost any part of the recorded MIDI data. Certain types of data—macro calls or relative tempo marks—can only be inserted in Event Edit. Once you get acquainted with the musical possibilities that Event Edit offers, you will find it invaluable.

Make sure you have recorded something on Track 1, and enter Event Edit by pressing the Tempo/Event Edit button while holding down Shift. (This puts you in the Search mode of Event Edit.) In the Search mode, you can move backward or forward in the track using the left and right buttons (F3 and F4).

For each event, you will see three numbers—separated by dashes—on the top line of the LCD. The first number indicates the current measure, the second number tells you the beat within the measure, and the third number is the clock number. There are 96 clocks for each quarter-note. Measure marks also appear at the

beginning of each measure, so that you always know where you are. If you need to hear the notes, you can press Start/Enter, and the QX5 will play each note as it is displayed. This allows you to step through the track and locate any notes you might want to change or delete.

Once you have found a note you want to change, press the Job button (F1). A cursor will appear over the M in the upper left corner of the LCD, indicating that you have entered the Change mode of Event Edit. This is where you actually alter the data.

The first thing you are able to edit when you enter the Change mode is the location of the note. Use the left and right buttons (F3 and F4) to move the event backwards or forwards to any position in the track. This is particularly useful when you want to change the time feel of a note slightly within the track. If you played the note a little too much on top of the beat, you can move it back by about 5 clocks and give it a more relaxed feel.

When you press the Cursor button (F2), the cursor will move down to the event type. There are 10 types of events that can be changed. When the cursor is on the event type you can select any of the 10. For example, if you want to insert a macro call on the same clock as your Note On command, you can use the left and right buttons (F3 and F4) to select MACRO. You can then move the cursor (using the cursor/F2 button), enter the proper macro number, and insert it into the track.

As you scroll through the 10 event types, notice that the editing options on the bottom right of the display are different for each type.

*Continued on page 20*

# RX5

An Introduction To  
Yamaha's  
New Digital  
Rhythm Programmer. By  
Tom Darter.

*RX5 digital rhythm  
programmer.*

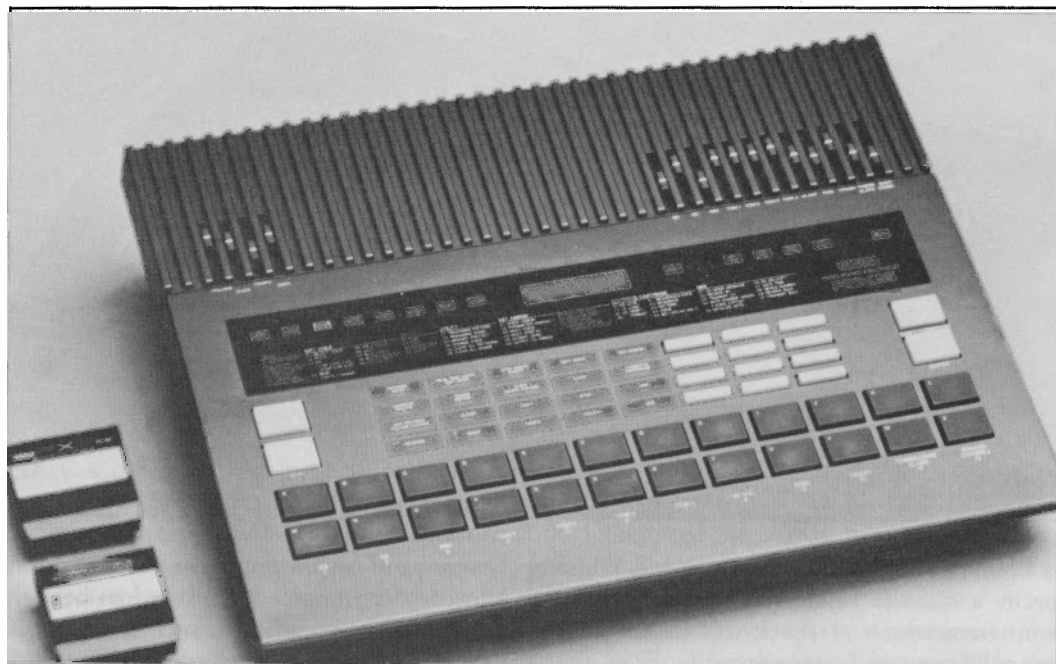

**W**ELCOME TO THE FUTURE! Or, rather, welcome to the world of Yamaha's newest digital rhythm programmer, the RX5. As many of you may have noticed, 1987 has seen the introduction of a significant number of new professional musical products from Yamaha.

Each new product represents a technological step forward. Obviously, though, some new instruments embody a greater leap forward than others. The DX7 II FD/D digital FM synthesizer represents a major advance—in terms of both sound quality and performance versatility—over the original DX7. However, if the DX7 II FD represents a major advance, the RX5 represents much more—something on the order of a trip to a new planet.

This is especially obvious if the features of the new RX5 are compared to those of its predecessor, the RX11. The RX11 provided easy access to a number of percussion sounds, but offered nothing in the way of sound shaping. The new RX5 offers both higher-quality sampled drum sounds and the ability to reshape (edit) those sounds on a number of levels.

More importantly, the RX5 is equipped with an impressive MIDI implementation. The RX11 could be “played” by an external keyboard via MIDI, and this MIDI connection allowed the RX11 to respond to MIDI velocity. However, none of this MIDI/keyboard performance could be stored in the RX11's internal memory. The new RX5 both responds to and

records input from a MIDI keyboard. In other words, with the RX5 it is possible to program rhythm sequences from an external MIDI keyboard, complete with velocity (or pitch) shadings.

## Sound Overview

When dealing with a new planet, it is most important to understand the basic layout. The RX5 offers access to 64 different percussion sounds: 24 sounds stored in the instrument's internal memory, 28 sounds stored in the plug-in ROM Data Waveform cartridge, and 12 more sounds available via the Copy function.

These 64 sounds can be assigned to any of the 24 instrument buttons on the RX5's front panel. The 24 instrument buttons (in pairs) correspond to a total of 12 output channels, which can be accessed via the 12 output jacks on the back panel. If the stereo outputs are used instead, the stereo location of each one of the 12 output channels is fixed (based on the setup shown in the accompanying diagram).

The RX5 is capable of 12-note polyphony, which means that it can output one sound from each of its output channels simultaneously. And, while two voices assigned to the same output channel cannot sound at the same time, all 64 voices can be included as part of any programmed pattern. Also, since it is possible to assign any voice to any one of the output channels, it is possible to create patterns in which

INSTRUMENT KEYS	A	B	C	D	E	F	G	H	I	J	K	L	
	M	N	O	P	Q	R	S	T	U	V	W	X	
INTERNAL VOICES	BD 1 BD 2	SD 1 SD 2	RIM 1 RIM 2	E Tom 1 Tom 1	E Tom 2 Tom 2	E Tom 3 Tom 3	E Tom 4 Tom 4	HH clos HH open	Edge Cup	China Crash	Tambrn Claps	Shaker Cowbel	
CARTRIDGE VOICES	BD 3 Timprn	SD 3 FM prc 1	Cga HMT DX mimb	Cga Hop TimblH	Cga LO Timbl L	Bgo HI FM prc 2	Bgo LO FM prc 3	Ago HI Cstnt	Ago LO Whstl DX clav	GlsCsh Gun DX orch	Hey Wao Ooo	Cuca E bass H E bass L	
RAM	Position Voice:	Cp1 BD 1	Cp2 SD 1	Cp3 RIM 1	Cp4 Tom 1	Cp5 Tom 2	Cp6 Tom 3	Cp7 Tom 4	Cp8 HH clos	Cp9 Cup	Cp10 Crash	Cp11 Claps	Cp12 Cowbel

almost any group of voices can sound at the same time (up to the limit of twelve).

The RX5's front panel has 12 sliders, for controlling the output levels of the 12 channels in the stereo mix. If you connect some of the output channels directly to your mixer (via the individual output jacks), you can remove those channels from the stereo mix by setting the front panel sliders all the way down. The channels' outputs will still appear at full level at the output of the individual output jacks.

### The RX5 Memory Layout

When the RX5 is turned on, the various memories (Internal, ROM, and Copy) are called up into the internal Play/Edit memory. There are a total of 64 memory locations in the Play/Edit memory, which correspond to the following: the 24 internal voice memories, the 28 ROM voice memories, and the 12 Copy voice memories.

When you first take the instrument out of its box, the 12 Copy voice locations will contain copies of the first 12 of the 24 Internal voices (see the accompanying diagram). These Copy locations can be used to store edited versions of some of the original voices. Also, they can be used to store copies of the original voices. This function can have a number of uses: You may want to have two copies of the

same cymbal voice on different output channels, so that you can (for instance) overlap the sounds for a more natural ride cymbal feel. Or, you may want to copy a pitched voice to a number of channels, so that you can create chords played by the same instrument sound. (Remember that each voice, since it is a single, sampled sound, is monophonic.) Using the functions available in Key Assign mode, it is possible to assign any of the 64 voices to any of the 12 output channels, and to any of the 24 instrument keys.

In its Sequence memory, the RX5 can store up to 100 patterns (numbered 00-99), which can be combined into 20 songs (numbered 00-19). Beyond this, songs can be combined into up to 3 Chains (numbered 0-2).

Each pattern can consist of up to 99 bars. The basic beat for any pattern can range from half-notes (xx/2) to thirty-second-notes (xx/32), and the number of beats for each bar of the pattern can range from 1 to 99. Each song can consist of up to 999 segments, each one of which can consist of a pattern, a repeat, a volume change, or a tempo change. Finally, each chain can consist of up to 90 segments, each one of which is a song.

### Pattern Writing

Basic pattern writing on the RX5 is very

*This chart shows the factory preset output channel assignments for all 64 voices available on the RX5.*

*This chart shows the stereo position assigned to each of the RX5's 12 output channels.*

INSTRUMENT KEYS	A	B	C	D	E	F	G	H	I	J	K	L
	M	N	O	P	Q	R	S	T	U	V	W	X
OUTPUT CHANNELS	1	2	3	4	5	6	7	8	9	10	11	12
STEREO POSITIONS	8	9	9	12	10	6	4	13	3	11	5	8

straightforward, as it has been on all of the RX Series of instruments. Once you determine the time signature and bar length of the pattern, you simply enter Real Time Write mode, press the START button, and begin. Using the instrument keys, you can enter notes from any of the 24 voices assigned to the keys. The precise time location of the notes will be determined by the Quantize value, and the volume level of each note will be determined by each voice's volume level setting.

For each instrument sound, it is possible to assign two different accent levels. This makes it possible to program patterns that involve at least three different sound levels for each instrument voice. The two accent levels are accessed whenever an instrument key is struck while one of the Accent Level buttons (1 or 2) is pressed.

Also, three different layouts for the 24 instrument keys can be pre-programmed and stored (via Key Assign Job #07), so that various voice combinations can be called up quickly for use in the Pattern Write mode.

If you want to use the reversed sound of a voice as part of a pattern, simply press the REVERSE button. The REVERSE light will come on, and any instrument key you play while the RX5 is in this mode will play in reverse. This effect is memorized as part of the pattern, and

does not effect the basic voices or instrument keys.

If you want to shorten the duration of any given note in a pattern—if, for instance, you want to create a “choke” effect with any of the cymbal voices—you can engage the damp function by pressing the DAMP button. The DAMP light will come on; now, whenever you press an instrument key, it will have the effect of stopping the sound of that voice (within the time restrictions set by the Quantize function).

An important note: The DAMP function only operates on notes already recorded into a pattern—if you press the DAMP key and simply try to play the instrument keys, you will get no response. Don't think that the RX5 has died; just disengage the DAMP function by pressing the DAMP key again, and everything will be as it was.

If you do not want to write patterns in real time, you can use the Step Write mode. In this case, you move through a pattern one step at a time (with the size of the steps being determined by the Quantize value), and do not have to worry about your manual dexterity. If you want to enter a complex pattern with exact timing, you may want to use the Step Write mode.

## Key Assign Mode

When writing patterns using the RX5's front panel, you will obviously be using the 24 instrument pads. Therefore, much of the work of writing patterns (both in real time and in step time) will involve interaction between the Pattern Write mode and the Key Assign mode (since this is where the status of the 24 instrument keys is determined). Fortunately, it is possible with the RX5 to move into Key Assign mode while in Real Time Write mode, so that you can judge your new voice choices (or Key Assign edits) in the context of the pattern you are writing.

Using Key Assign Job #01, you can change the voice assignments for any of the 24 instrument keys. This makes it possible to call up different instrument voices for use in any pattern.

More importantly, you can use Key Assign Job #02 (Parameter Assign) to alter a number of aspects of the sound of any voice assigned to an instrument key. For each instrument key, you can adjust the following parameters:

- pitch
- level

The 28 voices available on the ROM Waveform Data Cartridge that comes with the RX5.

1: SD 3	Snare Drum
2: BD 3	Bass Drum
3: CgaHMT	Conga (High Muted)
4: CgaHOP	Conga (High Open)
5: CgaLO	Conga (Low)
6: BgoHI	Bongo (High)
7: BgoLO	Bongo (Low)
8: TimbIH	Timbale (High)
9: TimbIL	Timbale (Low)
10: AgoHI	Agogo (High)
11: AgoLO	Agogo (Low)
12: Cuica	Cuica
13: Cstnt	Castanet
14: Whstl	Whistle
15: Timpn	Timpani
16: GlcCsh	Glass Crash effect
17: Gun	Gunshot effect
18: FMprc1	Synth-percussion (high)
19: FMprc2	Synth-percussion (medium)
20: FMprc3	Synth-percussion (low)
21: EbassH	Electric Bass Gtr (high)
22: EbassL	Electric Bass Gtr (low)
23: DXorch	Synth-orchestra
24: DXmrb	Synth-marimba
25: DXclav	Synth-clavinet
26: Hey	Vocal Sound
27: Wao	Vocal Sound
28: Ooo	Vocal Sound

- attack
- decay

Each of these sound edits is stored as part of the pattern memory, and does not alter the basic voice.

Whenever you move into Key Assign mode from Real Time Write mode, the Record function is disabled, but the pattern you are working on will continue to play, so you can determine your next voice addition relative to the sounds you have already entered. Once you decide on your next move, you just have to press the Real Time Write key again, and you are back in Real Time Write mode. It is therefore possible to try out various edits to a basic sound in the context of the pattern; once you have made your choice, re-enter the Real Time Write mode by pressing the appropriate button, and begin entering notes again.

Also, if you want to enter a voice part with changing pitches, it is possible to assign one voice to the entire top row of instrument keys, using the Multi Voice function (Key Assign Job #03). Once a voice is assigned to the top row of instrument keys, you can assign a graduated set of values for pitch, level, attack, or decay over the total range of 12 keys. In addition, you can make other minute alterations to the parameters of each key, using the Multi Step function (Key Assign Job #04). Of course, a similar effect can be achieved using a MIDI connection to a velocity-sensitive keyboard (which will be explained in more detail below).

### Pattern Editing

In the Pattern Edit mode, it is possible to move through a pattern note by note, and edit a number of important musical values for each event in the pattern. Once you enter the Edit Pattern mode, you can step through all of the events in a pattern; or, you can select a specific instrument voice, and step through only the notes that involve that voice.

For any note event in a pattern, you can edit the following parameters:

- pitch
- level
- attack
- decay
- reverse on/off

Notice that, although most of these parameters

correspond to those available in the Key Assign Parameter function (Key Assign Job #02), in this mode they alter the specific note only, and not the Voice that is playing the note or the instrument key to which the voice is assigned. They are therefore independent of the parameters set using Key Assign Job #02 or Edit Voice Jobs #02, #03, and #04.

It is also possible to change any voice in a pattern to another voice, using Utility Job #04 (Change Voice).

### Edit Voice Mode

If you want to transform the RX5's basic sounds beyond the edit capabilities offered by the Key Assign parameter change functions, you can perform much more extensive voice alterations in the Edit Voice mode. Using this mode, you can create entirely new sounds.

Any voice that is assigned to an instrument key can be called into the Edit Voice mode (using Edit Voice Job #01). Once you have picked the voice you want to edit, you can change the following parameters of the sound:

- pitch
- envelope
- pitch bend
- level
- loop on/off

Let's take a closer look at each one of these edit parameters:

**Pitch** (Voice Edit Job #02): This Job allows you to adjust the pitch level of the voice over a total range of five octaves (from minus two octaves to plus three octaves). Pitch adjustments can be made in increments of 10 cents (equal to  $\frac{1}{10}$  of a semitone).

**Envelope** (Voice Edit Job #03): Although the Key Assign mode allows you to adjust the Attack and Decay values for the RX5's voices, this Job in Edit Voice mode gives you much more control for precise envelope shaping, since it allows you to adjust up to six different parameters of the voice's envelope: Attack Rate, Decay 1 Rate, Decay 1 Level, Decay 2 Rate, Release Rate, and Gate Time (see the accompanying diagram).

Initially, each voice will display values that correspond to its own natural envelope. As you change the envelope values, you will notice that the shape of the sound can be altered quite dramatically.

*Continued*



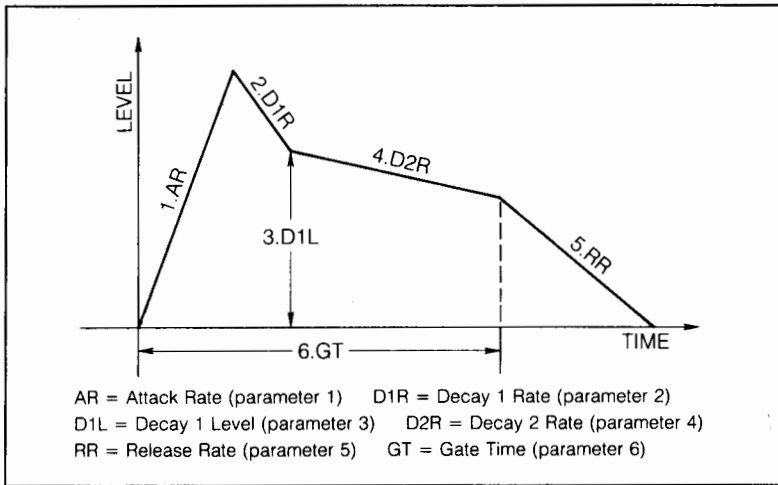

Voice Edit parameters for the RX5's envelope generator.

One of the most important parameters for editing the envelope is the Gate Time. This determines the overall length of the envelope—excluding the Release Rate. The initial Gate Time setting for all of the original voices is 6500 milliseconds (6.5 seconds), which is also the maximum value for the Gate Time. The overall shape for the initial envelope is therefore determined completely by the settings of the Attack Rate, Decay 1 Rate, Decay 1 Level, and Decay 2 Rate. If you want to take advantage of the Release Rate parameter, you must shorten the Gate Time or extend the Decay Rate values.

Also, note that the original sound can only last as long as the information provided by the basic sample. If you want to extend the duration of the voice, you must turn the Loop function on (Voice Edit Job #06).

**Pitch Bend** (Edit Voice Job #04): This Job allows you to introduce a pitch bend into the sound of the voice. Pitch is raised or lowered in increments of 1 cent (equal to  $\frac{1}{100}$  of a semitone). The Range setting sets the final pitch to which the note is bent (starting from the original pitch), while the Rate setting

Voice Edit parameters for the RX5's pitch bend.

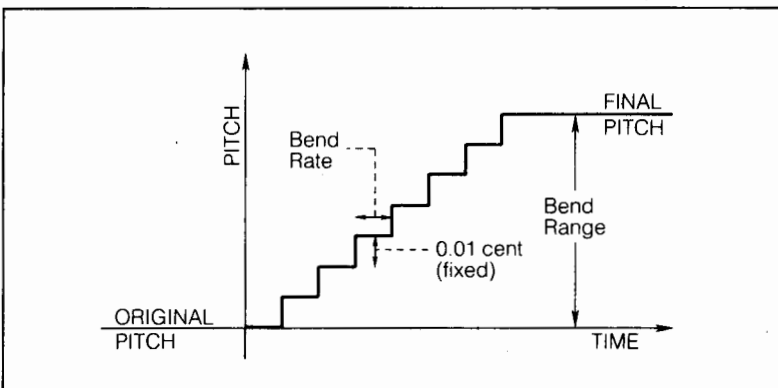

affects the time value for the pitch bend (see the accompanying diagram). The Pitch Bend Range can be as much as 60 semitones up or down. The Pitch Bend Rate settings are 00-60, with higher numbers creating a more rapid pitch bend. The Rate setting must be above 00, or there will be no pitch bend effect.

**Level** (Edit Voice Job #05): Like the Level parameter in Key Assign mode, this Job allows you to adjust the output volume of the voice, over a range of 00-31. At the 00 setting, the voice is turned off.

**Loop On/Off** (Edit Voice Job #06): If you plan to expand the overall duration of the voice, you must turn the Loop function on in order to give the RX5 increased sound data to deal with. The sample sound is expanded by repeating (looping) the tail end of the sample with decreasing sound level. This operation is used initially to create some of the longer voice sounds (such as the cymbals).

Once you have created an edited Voice, you can save it using Edit Voice Job #07 (Store Voice). This function actually stores the new, edited voice in the RX5's Play/Edit memory in place of the original voice. Remember, though, that the original voice still exists in the unit's permanent ROM memory. To restore the original voice, simply use Voice Edit Job #08 (Initialize Voice). This will bring the original voice back into the Play/Edit memory, in place of the edited voice.

## MIDI Functions

Like the earlier units in the RX family of rhythm programmers, the RX5 can be set up to respond to input from a MIDI keyboard; and, if the keyboard is velocity-sensitive, the sounds that you trigger will vary in volume according to how hard to play your MIDI controller.

The accompanying chart shows the MIDI note numbers that are assigned to the 64 voices in the RX5 when it is shipped from the factory. As you can see, all 64 of the RX5 voices can be played simultaneously from a MIDI keyboard. Also, if you compare the RX5's MIDI note number assignments to those of the earlier RX units, you will see that the RX5 note assignments are compatible. (For a chart showing the MIDI note assignments of the earlier units, see the RX Series article in the September 1986 issue of *AfterTouch*). This means that RX11 patterns recorded into a MIDI sequencer can be

played by the RX5 with no problems.

However, it is not necessary to use a MIDI sequencer to record patterns when playing the RX5 from a velocity-sensitive MIDI keyboard. This is because the RX5 can record the performance from a MIDI keyboard, complete with velocity shadings, directly into its internal pattern memory.

There are actually two different ways in which the RX5 will respond to MIDI note numbers: The Note Number Assign mode (described above), and the Tunable Note mode. With the Tunable Note mode, it is possible to use an RX5 instrument voice as a sound source for a MIDI keyboard. The selected voice is playable over a full 5-octave range, and the keyboard performance will be stored in the RX5's pattern memory, following the pitch changes you perform on the keyboard. This makes it easy to record bass lines and other instrument parts into the RX5 using its pitched instrument voices.

In Tunable Note mode, the RX5 also responds to MIDI Program Changes—and the 64 program numbers of (for instance) the DX7 II FD/D correspond exactly to the 64 instrument voices of the RX5. In other words, it is possible to program a pattern completely from an external MIDI Keyboard: Once you set the RX5 going in Real Time Pattern Write mode, you can call up any of the voices (one at a time) from the MIDI Keyboard using the Program Change keys.

In addition to all of these MIDI keyboard-related functions, the RX5 offers two other new features. Using the E.G. Velocity function (MIDI Job #07), it is possible to affect the envelope parameters of the RX5's voices by MIDI velocity. When the keyboard is played with slower velocities, the attack will be slower and the decay will be shorter. As the keyboard is played with increasing velocity, the attack becomes quicker and the decay becomes longer.

Also, if the DAMP button is engaged while the RX5 is being played from a MIDI keyboard, the RX5 will respond to Note Off messages from the keyboard as well as to Note On messages. In other words, the Gate Time of the RX5's voices can be controlled directly by how long a key is held down on the keyboard. All of this information (from both the E.G. Velocity function and the Gate Time/DAMP function) is recorded by the RX5 into its internal pattern memory.

Both the Note number Assign and the Tun-

*BD 2	44 (G#1)	*BD 1	45 (A1)
*SD 2	49 (C#2)	*SD 1	52 (E2)
RIM 2	46 (A#1)	*RIM 1	51 (D#2)
E.TOM 1	43 (G1)	*TOM 1	53 (F2)
E.TOM 2	42 (F#1)	*TOM 2	50 (D2)
E.TOM 3	41 (F1)	*TOM 3	48 (C2)
E.TOM 4	40 (E1)	*TOM 4	47 (B1)
*HH OPEN	59 (B2)	*HH CLOSED	57 (A2)
RIDE (EDGE)	63 (D#3)	*RIDE (CUP)	62 (D3)
CHINESE	61 (C#3)	*CRASH	60 (D3)
TAMBOURINE	58 (A#2)	*CLAPS	54 (F#2)
*SHAKER	56 (G#2)	*COWBELL	55 (G2)

COPIED VOICES Cp01 — Cp12: NOTES 24 — 35.  
CARTRIDGE VOICES 1 — 28: NOTES 65 — 92.

able Note functions are programmed using MIDI Job #04. Before these MIDI functions can work, however, the Channel Message receive function must be turned on (using MIDI Job #01), and the MIDI Receive channel(s) must be set (using MIDI Job #02). The voices in a programmed pattern will also output MIDI note numbers—these numbers will be the same as those programmed in the Note Number Assign function—and these MIDI note outputs can be assigned to their own MIDI channel (using MIDI Job #03).

### Data Storage

When the RX5 is turned off, all of the basic information used by the machine is retained in memory (thanks to the small battery inside, which has a life of approximately 10 years). This information includes all Voice data, all Sequence data (Patterns, Songs, and Chains), and all basic Key assignment and MIDI assignment data.

Even so, there are many reasons why you may want to take advantage of the unit's many other options for data storage: For example, you may want to create and record more patterns or songs than the basic memory will allow; or you may want to experiment with a number of different Voice edits; or you may simply want to have a backup memory just in case—you can never be too careful when it comes to maintaining copies of your musical work. The RX5 offers a number of alternative methods for data storage.

In addition to the ROM Cartridge Port (for plugging in the Waveform Data Cartridge), the RX5 also has a RAM Cartridge Port, which can be used for plugging in a RAM4 cartridge for

*This chart shows the original MIDI note numbers assigned to the RX5's voices when the instrument is shipped from the factory.*

data storage. The RAM cartridge can be used to store all Voice data, all Sequence (Pattern, Song, and Chain) data, all Voice and Sequence data, or single pattern data.

There is also a cassette interface port, which allows you to connect the RX5 to a cassette tape recorder for data storage (using the standard Yamaha cassette interface cable). In addition to the Voice data, Sequence (Pattern, Song, and Chain) data, and single Pattern data mentioned above, the cassette interface can also be used to store the instrument's Set-up data, which consists of the following elements:

- The three sets of Key data stored in the RX5 (via Key Assign Job #07)
- The Accent levels of all 64 voices
- The MIDI Transmit channels of all 64 voices
- The instrument's MIDI Receive channel
- The MIDI Notes assigned to all 64 voices

Note that none of this information can be stored onto the RAM4 cartridge.

Since the RX5 can also initiate a MIDI Bulk data dump, it is possible to store its Sequence memory via MIDI as System Exclusive data. In other words, the RX5's Sequence memory can be stored on disks, using a MIDI data recorder such as the Yamaha MDF1 MIDI Data Filer. (For a description of the MDF1's basic features, see the article in the January 1987 issue of *AfterTouch*.)

One unfortunate fact for owners of the DX7 II FD: Even though the DX7 II FD's disk drive can be used as a MIDI data recorder, the size of each file is limited by the DX7's internal memory buffer, which is approximately 20K bytes. Since the size of the RX5's Sequence memory exceeds this limit, the DX7 II FD cannot be used to store data from the RX5.

## Sync Modes

The RX5 is equipped with four different methods of controlling the "Clock Rate" (the speed of playback or recording). There are four sync options (which are selected via the Sync Mode):

- Internal Sync (the RX5 runs according to its Internal clock)
- MIDI Sync (the RX5 is controlled by another MIDI device)
- Tape Sync (the RX5 is controlled by an FSK sync signal recorded on tape)

- External Sync (the RX5 is controlled by another non-MIDI device)

The Internal Sync setting is the normal operating mode of the RX5. The playback speed of Patterns, Songs, and Chains, and the Real Time Pattern writing speed are controlled by the RX5's internal clock, the speed of which is set by the unit's internal tempo functions. The Internal Sync setting is also used when the RX5 is used to control other MIDI devices (the MIDI clock signal is transmitted via the MIDI OUT port) or non-MIDI devices (the sync signal is transmitted via the EXT. CLOCK OUT terminal).

The MIDI Sync setting is used when the RX5 is to be controlled by another MIDI device, from MIDI data received via the MIDI IN port. In addition to the tempo functions, Start and Stop commands can be initiated from the master MIDI unit. The RX5 also responds to MIDI Song Position Pointer when controlled from another MIDI instrument or synchronization device.

The Tape Sync setting lets you use an FSK Tape Sync signal to start, stop, and control the speed of playback and Real Time Pattern writing. This signal, which incorporates a pre-selected tempo, can be recorded onto tape from the RX5 (or from another MIDI device that is capable of transmitting a Tape Sync signal, such as the QX5). The tape Sync signal is transmitted and received via the RX5's CASSETTE terminal.

Finally, the External Sync setting allows you to control the RX5 using a gate-type clock or trigger signal. This control signal is fed to the RX5 via the EXT. CLOCK IN terminal.

• • • •

As you can see, the RX5 offers a great deal of flexibility for the creation of new rhythm programs, at a list price of \$1,195.00. Although the RX5 does not permit user sampling, its extensive voice editing features make it possible to create a vast library of new sounds. In addition, the extensive MIDI capabilities of the unit make it possible to use a velocity-sensitive MIDI keyboard as a controller, giving you access to realtime control of volume or pitch for the creation of subtle rhythm patterns. In future issues of *AfterTouch*, we will explore some of the RX5's features in greater detail, and will offer hints on how to use these features to their fullest potential.





# TX81Z

Dark Voice. A  
New TX81Z  
Performance  
Setup By  
Michael A.  
Huisman.

name: Dark Voice		1: MaleVoices	5:
assign mode	NORM	2: MaleVoices	6:
micro tune select	OCT.	3:	7:
effect select	OFF	4:	8:

inst. number	1	2	3	4	5	6	7	8
number of notes	4	4	0	0	0	0	0	0
voice number	I28	I28	A29	A29	A29	A29	A29	A29
receive ch.	1	1	1	1	1	1	1	1
key limit /L	C-2	C-2	C-2	C-2	C-2	C-2	C-2	C-2
key limit /H	G 8	G 8	G 8	G 8	G 8	G 8	G 8	G 8

detune	-4	+4	-1	+2	+0	-2	+1	-1
note shift	+0	+0	+0	+0	+0	+0	+0	+0
volume	95	95	90	90	90	90	90	90
out assign	L	R	LR	LR	LR	LR	LR	LR
lfo select	1	2	VIB	1	1	1	1	1
micro tune	OFF	OFF	ON	ON	ON	ON	ON	ON

OPERATOR	op1	op2	op3	op4
on/off	ON	ON	ON	ON
out level	95	60	59	50
freq. type	RTO	RTO	RTO	RTO
fix range	255	255	255	255
freq. course	4	5	0	28
freq. fine	8	1	4	1
detune	+0	-3	+3	+0
osc wave				

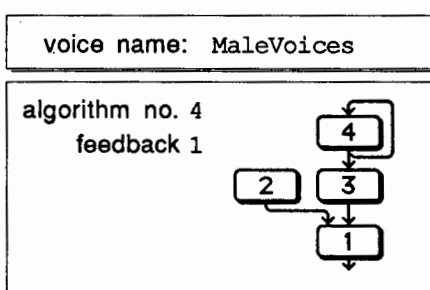

ENVELOPES				
attack rate	14	11	15	31
decay 1 rate	0	2	2	0
decay 1 level	15	15	15	15
decay 2 rate	1	3	4	0
release rate	6	1	1	4
eg shift	0	0	0	0

LFO			
waveform	TRI	sync	ON
speed	26	delay	0
amp mod depth	1	sens	
pitch mod depth	5	sens	6

SCALING				
rate	0	0	0	0
level	8	13	35	44
on/off	OFF	OFF	OFF	OFF
eg bias	0	0	0	0
key vel	3	0	0	0

FUNCTION			
mode	POLY	middle C	F2
portamento	OFF	rev rate	0
porta time	0	pb range	0
vol	99	pitch	0
pitch	0	amp	0
amp	0	eg bias	0
pitch	50	p bias	+0
amp	0		

# TX81Z

**Brs'n'Wind. A  
NEW TX81Z  
Performance  
Setup By  
Michael A.  
Huisman.**

name: Brs'n'Wind		1: Tpt&Woodwd	5:
assign mode	NORM	2: Tpt&Woodwd	6:
micro tune select	OCT.	3:	7:
effect select	OFF	4:	8:

inst. number	1	2	3	4	5	6	7	8
number of notes	4	4	0	0	0	0	0	0
voice number	I29	I29	I01	I01	I01	I01	I01	I01
receive ch.	1	1	1	1	1	1	1	1
key limit /L	C-2	C-2	C-2	C-2	C-2	C-2	C-2	C-2
key limit /H	G 8	G 8	G 8	G 8	G 8	G 8	G 8	G 8

detune	-2	+2	+7	+7	+7	+7	+7	+7
note shift	+0	+0	+0	+0	+0	+0	+0	+0
volume	99	99	90	90	90	90	90	90
out assign	L	R	LR	LR	LR	LR	LR	LR
lfo select	1	2	1	1	1	1	1	1
micro tune	OFF	OFF	OFF	OFF	OFF	OFF	OFF	OFF

OPERATOR	op1	op2	op3	op4
on/off	ON	ON	ON	ON
out level	96	79	99	77
freq. type	RTO	RTO	RTO	RTO
fix range	32K	255	255	4K
freq. course	4	4	5	5
freq. fine	8	8	1	1
detune	-3	-3	+3	+3
osc wave				

ENVELOPES				
attack rate	10	7	17	31
decay 1 rate	31	31	31	31
decay 1 level	15	15	15	15
decay 2 rate	0	2	0	2
release rate	4	5	7	5
eg shift	0	0	0	0

SCALING				
rate	1	0	1	0
level	12	39	0	27
on/off	OFF	OFF	OFF	ON
eg bias	0	0	0	0
key vel	1	3	1	2

voice name: Tpt&Woodwd

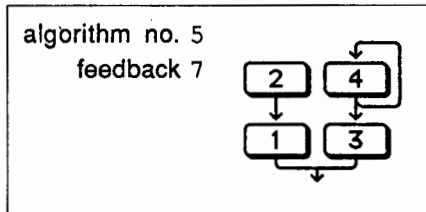

LFO			
waveform	TRI	sync	OFF
speed	31	delay	14
amp mod depth	0	sens	
pitch mod depth	28	sens	3

FUNCTION			
mode	POLY	middle C	F2
portamento	OFF	rev rate	0
porta time	0	pb range	4
vol	40	pitch	0
pitch	0	amp	0
amp	0	eg bias	0
pitch	50	p bias	+0
amp	0		



# DX Music Sessions

**H**AL LEONARD PUBLISHING has put together a very useful educational package for users of Yamaha DX100 and DX27 synthesizers. Called "DX Music Sessions," the material consists of a 32-page booklet and a two-sided cassette tape.

The package is intended to teach novice musicians basic music theory, while at the same time helping them to learn both basic synthesizer theory and a number of contemporary pop tunes. The cassette tape offers a combination of "learn through listening" and "play along" techniques. All information on the tape is backed up by material in the booklet, and everything is presented in a straightforward, easy-to-live-with manner.

During the course of the program, the player is introduced to a number of basic musicianship concepts, and is also given many

helpful hints relative to the use of the DX100 and DX27 synthesizers. Although the program covers a great deal of basic music theory, the presentation is never dry—every music concept presented is related to a practical application, so that the learning process is both well grounded and fun.

Users of the DX Music Sessions program are invited to learn while playing along with recordings of a number of popular songs (both classic and current, including the following: "Hound Dog," "Twist And Shout," "Like A Virgin," "Time After Time," "Dynamite," "Stray Cat Strut," "If You Love Somebody Set Them Free," and "You Know I Love You ... Don't You?")

The DX Music Session package is available through the Yamaha dealer network, at a list price of \$12.95.

**A New Educational Booklet And Cassette Tape For Use With DX100 And DX27 Synthesizers.**

**L**ET US HEAR FROM YOU! We want AfterTouch to be an information network for all users of Yamaha professional musical products, so please join in. We're looking for many different kinds of material.

Have you created an incredible patch for the DX7, the DX100, or any of the other members of the Yamaha FM digital synthesizer family? How about a program for the CX5M music computer or a great pattern for the RX11? Send in your patches, programs, and patterns. If we use your material, we'll give you full credit plus \$25.00 for each item used.

Have you discovered a trick that increases the musical flexibility of one of the Yamaha AfterTouch products? Send it in to our "FinalTouch" column. If we use your hot tip, you'll receive full credit plus a check for \$25.00.

Have you developed a new approach to one of the Yamaha AfterTouch instruments, or have you discovered an important secret regarding their use? Put it on paper and send it to us. Don't worry about your writing style—just get the information down. If we decide to use your material as a full article in AfterTouch, we'll write it up, put your name on it, and send you a check for \$100.00. (An AfterTouch article always covers at least one magazine page—which translates to at least four double-spaced pages of typescript.)

By the way, we cannot assume liability for the safe return of unused ideas, patches, or manuscripts. We will only be able to return unused material if you enclose a self-addressed, stamped envelope with your submission.

If you just have a question regarding the use of Yamaha professional musical products, send it along too, and we'll do our best to answer it in the pages of AfterTouch. (We regret that we won't be able to answer questions through the mail, but we will use all of your questions to guide us in our choice of future topics.)

Finally, if you just want to get something off your chest, or if you'd like to establish direct contact with other Yamaha AfterTouch product users, send in something to our letters column, "Touch Response." We'll do our best to print names, addresses, and phone numbers of all those who are interested in starting up regional users groups.

AfterTouch is your publication. Let us hear from you!

Write To:  
**AFTER-TOUCH,**  
P.O. Box 2338,  
Northridge, CA  
91323-2338.

# QX5

*Continued from page 9*

The next time you move the cursor, you can edit the MIDI channel assignment of the event. An event can be assigned to any of the 16 MIDI channels.

After setting the channel, you can alter the note data by moving the cursor again. In the case of Note On data you can change three parameters: 1) Which note is played; 2) Note On Velocity; and 3) Note Gate Time. The first number tells you that a C4 was played. If you want to move this note down an octave, press the left button (F3) until you see C3 in the LCD. Press the cursor button (F2) again, and you will be able to change the Note On Velocity. A higher number corresponds to a faster velocity.

The data for Note Gate Time (duration) isn't visible in the LCD until you move the cursor again. The duration of the note is displayed as a number of clocks. For instance, if the gate time is 00048, the note is an eighth-note. (As mentioned above, the QX5's resolution is 96 clocks per quarter-note.)

Remember that each of the 10 event types has a different data format. When you are editing controller events, you won't change note numbers, velocities, and gate times. Instead, you change the controller number (which controller) and the current controller value (the amount of modulation or breath control, for instance).

Depending on the kind of event you are editing, the data ranges will also be different. If you're editing a tempo change, the data is expressed as a percentage of the original tempo, with a range from 25% to 398%. If you're making a macro call, the range is 1 to 32.

After you have finished editing an event, you have four options:

- 1) You can insert the new event into the track. This puts the new event in without changing anything else.
- 2) You can use Replace to put the edited version of the event in place of the original version.
- 3) You can use Delete to erase the event entirely.
- 4) If you change your mind, you can go back to the Search mode (press Job again) and leave the track as it was. This erases the edit.

.....

In the last two issues we've discussed a few of the ways you can organize your work on the QX5. The purpose of outlining these various approaches has been to show you methods that you may not have tried before, so that you can see if they will be useful to you. They represent only some of the possibilities. The best feature of the QX5 is its versatility. It doesn't force you to work in any particular way—you can decide which methods are best for your work, and change and adapt them as you progress.

The best approach to learning the QX5 is to read the manual, then experiment with the features and get to know what they can do. You don't have to know every detail of every feature—you just have to be aware of what is musically possible.

The important thing is that you worry about creating the music first, and worry about operating the machine second.