

Technics

DIGITAL ENSEMBLE

SX-PR604/M
SX-PR804/M

Operating Instructions





Before connecting, operating or adjusting this product, please read these instructions completely. Please keep this manual for future reference.

 **PRINTED WITH SOY INK**
This manual was printed with soy based ink.

Caution for AC Mains Lead

(For United Kingdom)
(For the type as shown in figures A and B)

For your safety, please read the following text care-fully.

This appliance is supplied with a moulded three pin mains plug for your safety and convenience. A 5-ampere fuse is fitted in this plug. Should the fuse need to be replaced please ensure that the replacement fuse has a rating of 5-ampere and that it is approved by ASTA or BSI to BS1362. Check for the ASTA mark  or the BSI mark  on the body of the fuse.

If the plug contains a removable fuse cover you must ensure that it is refitted when the fuse is replaced. If you lose the fuse cover the plug must not be used until a replacement cover is obtained. A replacement fuse cover can be purchased from your local dealer.

CAUTION!

IF THE FITTED MOULDED PLUNG IS UNSUITABLE FOR THE SOCKET OUTLET IN YOUR HOME THEN THE FUSE SHOULD BE RE-MOVED AND THE PLUG CUT OFF AND DIS-POSED OF SAFELY. THERE IS A DANGER OF SEVERE ELECTRICAL SHOCK IF THE CUT OFF PLUG IS INSERTED INTO ANY 13-AMPRERE SOCKET.

If a new plug is to be fitted please observe the wiring code as stated below. If in any doubt please consult a qualified electrician.

IMPORTANT

The wires in this mains lead are coloured in accordance with the following code:

Blue: Neutral, Brown: Live.

As these colours may not correspond with the coloured markings identifying the terminals in your plug, proceed as follows:

The wire which is coloured Blue must be connected to the terminal which is marked with the letter N or coloured Black or Blue.

The wire which is coloured Brown must be connected to the terminal which is marked with the letter L or coloured Brown or Red.

WARNING: DO NOT CONNECT EITHER WIRE TO THE EARTH TERMINAL WHICH IS MARKED WITH THE LETTER E, BY THE EARTH SYMBOL \perp OR COLOURED GREEN OR GREEN/ YELLOW.

**THIS PLUG IS NOT WATERPROOF
—KEEP DRY.**

Before use

Remove the connector cover.

How to replace the fuse

The location of the fuse differ according to the type of AC mains plug (figures A and B). Confirm the AC mains plug fitted and follow the instructions below. Illustrations may differ from actual AC mains plug.

1. Open the fuse cover with a screwdriver.

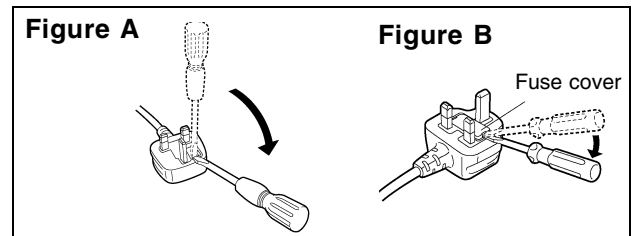

2. Replace the fuse and close or attach the fuse cover.

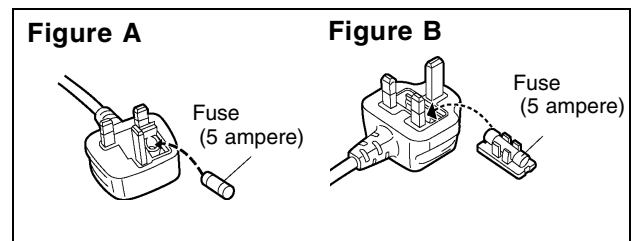

For United Kingdom and Republic of Ireland

shop@ **Panasonic**

www.panasonic.co.uk (for UK customers only)

- Order accessory and consumable items for your product with ease and confidence by telephoning our Customer Care Centre Mon-Friday 9:00am-5:30pm. (Excluding public holidays.)
- Or go on line through our Internet Accessory ordering application.
- Most major credit and debit cards accepted.
- All enquiries transactions and distribution facilities are provided directly by Panasonic UK Ltd.
- It couldn't be simpler!

Customer Care Centre

For UK customers: 08705 357357 For Republic of Ireland customers: 01 289 8333

Technical Support

For UK customers: 0870 1 505610

This Technical Support Hot Line number is for Panasonic PC software related products only.

For Republic of Ireland, please use the Customer Care Centre number listed above for all enquiries.

For all other product related enquiries, please use the Customer Care Centre numbers listed above.

WARNING:

TO REDUCE THE RISK OF FIRE, ELECTRIC SHOCK OR PRODUCT DAMAGE, DO NOT EXPOSE THIS APPARATUS TO RAIN, MOISTURE, DRIPPING OR SPLASHING AND THAT NO OBJECTS FILLED WITH LIQUIDS, SUCH AS VASES, SHALL BE PLACED ON THE APPARATUS.

THE FOLLOWING APPLIES ONLY
IN THE U.S.A. AND CANADA



CAUTION
RISK OF ELECTRIC SHOCK
DO NOT OPEN



CAUTION: TO REDUCE THE RISK OF ELECTRIC SHOCK, DO NOT REMOVE SCREWS. NO USER-SERVICEABLE PARTS INSIDE. REFER SERVICING TO QUALIFIED SERVICE PERSONNEL.



The lightning flash with arrowhead symbol, within an equilateral triangle, is intended to alert the user to the presence of uninsulated "dangerous voltage" within the product's enclosure that may be of sufficient magnitude to constitute a risk of electric shock to persons.



The exclamation point within an equilateral triangle is intended to alert the user to the presence of important operating and maintenance (servicing) instructions in the literature accompanying the appliance.

(for U.S.A. and Canada)

CAUTION:

TO PREVENT ELECTRIC SHOCK MATCH WIDE BLADE OF PLUG TO WIDE SLOT, FULLY INSERT.

THE FOLLOWING APPLIES ONLY IN THE U.S.A.

Notice:

This product has a fluorescent lamp that contains a small amount of mercury. It also contains lead in some components. Disposal of these materials may be regulated in your community due to environmental considerations. For disposal or recycling information please contact your local authorities, or the Electronics Industries Alliance: <<http://www.eiae.org>>

CAUTION:

This equipment has been tested and found to comply with the limits for a Class B digital device, pursuant to Part 15 of the FCC Rules. These limits are designed to provide reasonable protection against harmful interference in a residential installation. This equipment generates, uses and can radiate radio frequency energy and, if not installed and used in accordance with the instructions, may cause harmful interference to radio communications. However, there is no guarantee that interference will not occur in a particular installation. If this equipment does cause harmful interference to radio or television reception, which can be determined by turning the equipment off and on, the user is encouraged to try to correct the interference by one or more of the following measures:

- Reorient or relocate the receiving antenna.
- Increase the separation between the equipment and receiver.
- Connect the equipment into an outlet on a circuit different from that to which the receiver is connected.
- Consult the dealer or an experienced radio/TV technician for help.

FCC Warning:

To assure continued FCC emission limit compliance, use only the provided power supply cord and the shielded interface cable when connecting this device to the computer.

Also, any unauthorized changes or modifications to this equipment would void the user's authority to operate this device.

This device complies with Part 15 of the FCC Rules. Operation is subject to the following two conditions: (1) This device may not cause harmful interference, and (2) this device must accept any interference received, including interference that may cause undesired operation.

Responsible Party:

Matshshita Electric Corporation of America
One Panasonic Way
Secaucus, NJ, 07094 USA
Telephone No.: 1-800-211-7262

The model number and serial number are found underneath the keyboard.

Please note the model and serial numbers in the space provided below and retain this sheet as a permanent record of your purchase to aid identification in the event of theft.

MODEL NUMBER _____

SERIAL NUMBER _____

(Except for U.S.A. and Canada)

THIS UNIT IS INTENDED FOR USE IN TROPICAL CLIMATES.
DENNA ENHET ÄR AVSEDD FÖR ANVÄNDNING PÅ PLATSER MED TROPISKT KLIMAT.
TÄMÄ LAITE ON TARKOITETTU KÄYTETTÄVÄKSI TROOPPISESSA ILMASTOSSA.
DETTE APPARATET ER BEREGNET TIL BRUK UNDER TROPISKE KLIMAFORHOLD.

AVISO:

PARA REDUCIR EL RIESGO DE INCENDIOS, DESCARGAS ELÉCTRICAS O DAÑOS EN ESTE APARATO, NO LO EXPONGA A LA LLUVIA, HUMEDAD, GOTEO NI SALPICADURAS, Y NO COLOQUE ENCIMA DE ÉL OBJETOS QUE CONTENGAN LÍQUIDOS COMO, POR EJEMPLO, FLOREROS.

VAROITUS:

TULIPALO-, SÄHKÖISKUVAARAN TAI TUOTETTA KOHTAAVAN MUUN VAHINGON VÄHENTÄMISEKSI EI LAITETTA SAA ALTISTAA SATEELLE, KOSTEUELLE, VESIPISAROILLE TAI ROISKEELLE, EIKÄ NESTETTÄ SISÄLTÄVIÄ ESINEITÄ, KUTEN ESIMERKIKSI MALJAKOITA, SAA ASETTAA LAITTEEN PÄÄLLE.

ADVARSEL:

FOR Å REDUSERE FAREN FOR BRANN, ELEKTRISK STØT ELLER SKADER PÅ PRODUKTET, MÅ DETTE APPARATET IKKE UTSETTES FOR REGN, FUKTIGHET, VANNDRÅPER ELLER VANNSPRUT. DET MÅ HELLER IKKE PLASSERES GJENSTANDER FYLT MED VANN, SLIK SOM BLOMSTERVASER, OPPÅ APPARATET.

OSTRZEŻENIE:

ABY OGRANICZYĆ NIEBEZPIECZEŃSTWO POŻARU, PORAŻENIA PRĄDEM LUB USZKODZENIA URZĄDZENIA, NIE NALEŻY WYSTAWIAĆ URZĄDZENIA NA DZIAŁANIE DESZCZU, WILGOCI, KAPANIE LUB ZACHLAPANIE; PONADTO NA URZĄDZENIU NIE NALEŻY USTAWIAĆ ŻADNYCH NACZYŃ ZAWIERAJĄCYCH PŁYNY, TAKICH JAK WAZONY.

ATTENZIONE:

PER RIDURRE IL RISCHIO D'INCENDIO, SCOSSE ELETTRICHE O DANNI ALL'UNITÀ, NON ESPORLA ALLA PIOGGIA, UMIDITÀ, GOCCIOLAMENTI O SPRUZZI E NON METTERVI SOPRA ALCUN OGGETTO CONTENENTE LIQUIDI, COME UN VASO DI FIORI.

VARNING:

FÖR ATT MINSKA RISKEN FÖR ELDSVÅDA, ELEKTRISKA STÖTAR OCH SKADOR PÅ PRODUKTEN FÅR DEN INTE UTSÄTTAS FÖR REGN, FUKTIGHET, VATTENDROPPAR ELLER VATTENSTÄNK, OCH INGA FÖREMÅL SOM ÄR FYLLDA MED VÄTSKA, SÅ SOM VASER, BÖR PLACERAS PÅ APPARATEN.

WAARSCHUWING:

TENEINDE HET GEVAAR VOOR BRAND, ELEKTRISCHE SCHOK OF PRODUCTBESCHADIGING TE VERMINDEREN, MAG DIT APPARAAT NIET WORDEN BLOOTGESTELD AAN REGEN, VOCHT, EN DRUPPELEND OF SPATTEND WATER, EN MOGEN ER GEEN VOORWERPEN MET WATER OF ANDERE VLOEISTOFFEN ERIN, ZOALS BLOEMENVAZEN, OP HET APPARAAT WORDEN GEZET.

ADVARSEL:

FOR AT MINDSKE RISIKOEN FOR BRAND, ELEKTRISK STØD ELLER SKADER PÅ PRODUKTET, MÅ DETTE APPARAT IKKE UDSÆTTES FOR REGN, FUGT, VANDDRYP OG VANDSTÆNK, OG DER MÅ IKKE ANBRINGES BEHOLDERE INDEHOLDENDE VÆSKE, SOM FOR EKSEMPEL VASER, OVENPÅ APPARATET.

AVISO:

PARA REDUZIR O RISCO DE INCÊNDIO, CHOQUE ELÉCTRICO OU AVARIAS, NÃO EXPONHA O APARELHO À CHUVA, HUMIDADE, PINGOS OU SALPICOS NEM COLOQUE EM CIMA DELE OBJECTOS COM LÍQUIDOS COMO, POR EXEMPLO, UM JARRO.

CAUTION!

- DO NOT INSTALL, OR PLACE THIS UNIT, IN A BOOK-CASE, BUILT-IN CABINET OR IN ANOTHER CONFINED SPACE. ENSURE THE UNIT IS WELL VENTILATED. TO PREVENT RISK OF ELECTRIC SHOCK OR FIRE HAZARD DUE TO OVERHEATING, ENSURE THAT CURTAINS AND ANY OTHER MATERIALS DO NOT OBSTRUCT THE VENTILATION VENTS.
- DO NOT OBSTRUCT THE UNIT'S VENTILATION OPENINGS WITH NEWSPAPERS, TABLECLOTHS, CURTAINS, AND SIMILAR ITEMS.
- DO NOT PLACE SOURCES OF NAKED FLAMES, SUCH AS LIGHTED CANDLES, ON THE UNIT.
- DISPOSE OF BATTERIES IN AN ENVIRONMENTALLY FRIENDLY MANNER.

¡ADVERTENCIA!

- PARA MANTENER BIEN VENTILADA ESTA UNIDAD, NO LA INSTALE NI PONGA EN UN ESTANTE DE LIBROS, MUEBLE EMPOTRADO U OTRO ESPACIO DE DIMENSIONES REDUCIDAS. ASEGÚRESE QUE CORTINAS Y OTROS MATERIALES NO OBSTRUYAN LAS CONDICIONES DE VENTILACIÓN PARA PREVENIR EL RIESGO DE SACUDIDAS ELÉCTRICAS O INCENDIOS DEBIDOS AL RECALENTAMIENTO.
- NO OBSTRUYA LAS ABERTURAS DE VENTILACIÓN DE LA UNIDAD CON PERIÓDICOS, MANTELES, CORTINAS U OBJETOS SIMILARES.
- NO COLOQUE OBJETOS CON LLAMA DESCUBIERTA, UNA VELA POR EJEMPLO, ENCIMA DE LA UNIDAD.
- TIRE LAS PILAS DE FORMA QUE NO CONTAMINE EL MEDIO AMBIENTE.

VAROITUS!

- ÄLÄ ASENNATA TAI LAITTA TÄTÄ LAITETTA KABINETTITYYPPISEEN KIRJAKAAPPIIN TAI MUUHUN SULJETTUUN TILAAN, JOTTA TUULETUS ONNISTUISI. VARMISTA, ETTÄ VERHO TAI MIKÄÄN MUU MATERIAALI EI HUONONNA TUULETUSTA, JOTTA VÄLTETTÄISIIN YLIKUUMENEMISESTA JOHTUVA SÄHKÖISKU- TAI TULIPALOVAARA.
- ÄLÄ PEITÄ LAITTEEN TUULETUSAUKKOJA SANOMALEHDELLÄ, PÖYTÄLIINALLA, VERHOLLA TAI MUULLA VASTAAVALLA ESINEELLÄ.
- ÄLÄ ASETA PALAVAA KYNTTILÄÄ TAI MUUTA AVOTULEN LÄHDETTÄ LAITTEEN PÄÄLLE.
- HÄVITÄ PARISTOT LUONTOA VAHINGOITTAMATTOMALLA TAVALLA.

ADVARSEL!

- APPARATET MÅ IKKE Plasseres i en bokhylle, et innebygget kabinet eller et annet lukket sted hvor ventilasjonsforholdene er utilstrekkelige. Sørg for at gardiner eller lignende ikke forverrer ventilasjonsforholdene, så risiko for elektrisk sjokk eller brann forårsaket av overheting unngås.
- APPARATETS VENTILASJONSÅPNINGER MÅ IKKE DEKKES TIL MED AVISER, BORDDUKER, GARDINER OG LIGNENDE.
- Plasser ikke åpen ild, slik som levende lys, oppå apparatet.
- Brukte batterier må kasseres uten fare for miljøet.

UWAGA!

- NINIEJSZEGO URZĄDZENIA NIE NALEŻY INSTALOWAĆ LUB UMIESZCZAĆ W SZAFCE NA KSIĄŻKI, ZABUDOWANEJ SZAFCE LUB INNEJ OGRANICZONEJ PRZESTRZENI, W CELU ZAPEWNIENIA DOBREJ WENTYLACJI. NALEŻY SIĘ UPEWNIĆ, ŻE ZASŁONY I INNE MATERIAŁY NIE ZASŁANIAJĄ OTWORÓW WENTYLACYJNYCH TAK, ABY ZAPOBIEC RYZYKU PORĄŻENIA PRĄDEM LUB POŻARU W WYNIKU PRZEGRZANIA.
- NIE ZASŁANIAJ OTWORÓW WENTYLACYJNYCH URZĄDZENIA GAZETAMI, OBRUSAMI, ZASŁONAMI I PODÓBNYMI PRZEDMIOTAMI.
- NIE UMIESZCZAJ NA URZĄDZENIU ŹRÓDEŁ OTWARTEGO OGNIA, TAKICH JAK ZAPALONE ŚWIECE.
- POZBYWAJ SIĘ ZUŻYTYCH BATERII W SPOSÓB NIE ZAGRAŻAJĄCY ŚRODOWISKU NATURALNEMU.

ATTENZIONE!

- PER MANTENERE UNA BUONA VENTILAZIONE, NON INSTALLARE O SISTEMARE QUESTA UNITÀ IN UNO SCAFFALE DEI LIBRI, ARMADIETTO INCORPORATO OD ALTRO SPAZIO RISTRETTO. PER PREVENIRE I RISCHI DI SCOSSE O INCENDIO DOVUTI A SURRISCALDAMENTO, ACCERTARSI CHE TENDE OD ALTRO MATERIALE NON OSTRUISCANO LE CONDIZIONI DI VENTILAZIONE.
- NON OSTRUIRE LE APERTURE DI VENTILAZIONE DELL'UNITÀ CON GIORNALI, TOVAGLIE, TENDE ED ALTRI OGGETTI SIMILI.
- NON METTERE SULL'UNITÀ SORGENTI DI FIAMME NUDE, COME CANDELE ACCESE.
- DISFARSI DELLE PILE RISPETTANDO L'AMBIENTE.

VARNING!

- FÖR ATT APPARATEN SKA FÅ GOD VENTILATION, INSTALLERA ELLER PLACERA DEN INTE I EN BOKHYLLA, ETT INBYGGT SKÅP ELLER I ANDRA BEGRÄNSADE UTRYMMEN. FÖR ATT FÖREBYGGA RISK FÖR ELSTÖTAR OCH BRAND PÅ GRUND AV ÖVERHETNING, KONTROLLERA ATT GARDINER ELLER ANDRA FÖREMÅL INTE FÖRHINDRAR APPARATENS VENTILERING.
- SE TILL ATT ENHETENS VENTILATIONSÖPPNINGAR INTE ÄR FÖRTÄPPTA AV TIDNINGAR, BORDSDUKAR, GARDINER ELLER LIKNANDE FÖREMÅL.
- STÄLL INGA FÖREMÅL MED ÖPPEN LÅGA, SÅ SOM ETT TÄNT STEARINLJUS, OVANPÅ ENHETEN.
- GÖR DIG AV MED BATTERIER PÅ ETT MILJÖVÄNLIGT SÄTT.

WAARSCHUWING!

- OM EEN GOEDE VENTILATIE TE VERZEKEREN, DIT APPARAAT NIET IN EEN BOEKENKAST, EEN INGEBOUWDE KAST OF EEN ANDERE GESLOTEN RUIMTE INSTALLEREN OF GEBRUIKEN. ZORG ERVOOR DAT DE VENTILATIEWEGEN NIET DOOR GORDIJNEN OF ANDERE MATERIALEN WORDEN AFGESLOTEN, OM GEVAAR VOOR ELEKTRISCHE SCHOK OF BRAND TEN GEVOLGE VAN OVERVERHITTING TE VOORKOMEN.
- ZORG DAT DE VENTILATIE-OPENINGEN VAN HET APPARAAT NIET GEBLOKKEERD WORDEN DOOR KRANTEN, TAFELKLEEDJES, GORDIJNEN, OF IETS DERGELIJKS.
- ZET GEEN OPEN VUUR, ZOALS BRANDENDE KAARSEN, OP HET APPARAAT.
- DOE LEGE BATTERIEN WEG OP EEN MILIEUVRIENDELIJKE MANIER.

BEMÆRK:

- PLACÉR APPARATET PÅ ET GODT VENTILERET STED. LAD VÆRE MED AT STILLE DET I ET SKAB ELLER ET ANDET LILLE, LUKKET RUM. PAS PÅ, AT GARDINER ELLER LIGNENDE IKKE DÆKKER VENTILATIONSÅBNINGERNE. HVIS APPARATET OVEROPHEDES, ER DER RISIKO FOR ELEKTRISK STØD ELLER BRAND.
- TILDÆK IKKE APPARATETS VENTILATIONSÅBNINGER MED AVISER, DUGE, GARDINER OG LIGNENDE TING.
- ANBRING IKKE KILDER TIL ÅBEN ILD, SOM FOR EKSEMPEL TÆNDE STEARINLYS, OVENPÅ APPARATET.
- BORTSKAF BATTERIER PÅ EN MILJØMÆSSIG FORSVARLIG MÅDE.

AVISO!

- NÃO INSTALE OU COLOQUE ESTE APARELHO DENTRO DE UMA ESTANTE, ARMÁRIO EMBUTIDO OU QUALQUER OUTRO ESPAÇO FECHADO. VERIFIQUE SE EXISTE UMA BOA VENTILAÇÃO PARA O APARELHO. PARA EVITAR O RISCO DE CHOQUE ELÉCTRICO OU INCÊNDIO PROVOCADO POR SOBREAQUECIMENTO, CERTIFIQUE-SE DE QUE AS ABERTURAS DE VENTILAÇÃO NÃO ESTÃO TAPADAS COM AS CORTINAS OU QUALQUER OUTRO MATERIAL.
- NÃO TAPE AS RANHURAS DE VENTILAÇÃO COM JORNAIS, TOALHAS, CORTINADOS OU OBJECTOS SEMELHANTES.
- NÃO COLOQUE OBJECTOS COM CHAMAS, COMO VELAS ACESAS, EM CIMA DO APARELHO.
- DEITE FORA AS PILHAS RESPEITANDO AS REGRAS DE DEFESA DO AMBIENTE.

只限於台灣

緊急處理方法

為防止使用者及其他人之危害及生命財產的損失，如有發生異常時，請立即拔出電源綫插頭並停止使用。

進口商名稱、地址及電話
松下資訊科技股份有限公司
台灣台北市信義路5段2號5~6樓
TEL : 886-2-2725-9100

IMPORTANT SAFETY INSTRUCTIONS

Read these operating instructions carefully before using the unit. Follow the safety instructions on the unit and the safety precautions listed below. Keep these operating instructions handy for future reference.

Safety

- 1. Power Source**—Connect the unit to a power source of the type described in these instructions or as marked on the unit.
- 2. Polarization**—The unit is equipped with a polarized power plug where one blade is wider than the other. This safety feature ensures that the plug fits into your household AC outlet only one way. If the plug doesn't fit one way, try reversing it. If the plug still doesn't fit, contact an electrician to replace the obsolete outlet. Do not attempt to defeat the safety purpose of the plug.
- 3. Power Cord protection**—Route the AC power supply cord so that it will not be walked on or pinched by items placed on or against it. Never take hold of the plug or cord with wet hands. Always grasp the plug body firmly when connecting and disconnecting it.
- 4. Overloading**—When connecting the AC power supply cord, be careful not to overload the household AC outlet, extension cord, or outlet from any other device as this can result in fire or electric shock.
- 5. Nonuse periods**—Turn the unit off when it is not in use. Unplug the unit from the household AC outlet if it is not to be used for a long time. Unplug the unit during lightning storms.
- 6. Attachments and accessories**—Use only the attachments and accessories recommended in these operating instructions.

Installation

Placement

- 1. Ventilation**—Situate the unit so that it receives proper ventilation. Do not install in a confined space such as a bookcase or cabinet. Allow at least 10 cm (4 inches) clearance from the rear of the unit. To prevent the risk of electric shock or fire due to overheating ensure curtains and other materials do not obstruct the unit's ventilation.
- 2. Foreign material**—Ensure objects and liquids do not get into the unit. Avoid exposing the unit to excessive smoke, dust, mechanical vibration, and shock.
- 3. Magnetism**—Situate the unit away from equipment and devices that generate strong magnetic fields.
- 4. Stacking**—Do not place heavy objects on top of this unit.
- 5. Surface**—Place the unit on a flat, level surface.

- 6. Carts and stands**—Use the unit only with carts and stands recommended by the manufacturer. Move carts with care. Sudden stops, excessive force, and uneven surfaces can cause carts to overturn.



- 7. Wall and ceiling mounting**—Do not mount the unit on walls or ceilings unless specified in the instructions.

Environment

- 1. Water and moisture**—Do not use the unit near water, such as near a bathtub or swimming pool. Avoid damp basements.
- 2. Heat**—Situate the unit away from heat sources, such as radiators. Do not situate where temperatures fall below 5°C (41°F) or rise above 35°C (95°F).

Maintenance

(See page 7 for details.)

Unplug the unit from the household AC outlet before cleaning.
Clean with a damp cloth.
Do not use abrasive pads, scouring powders, or solvents.

Service

- 1. Damage Requiring Service**—The unit should be serviced by qualified service personnel if:
 - (a) The AC power supply cord or the plug has been damaged; or
 - (b) Objects or liquids have gotten into the unit; or
 - (c) The unit has been exposed to rain; or
 - (d) The unit does not operate normally or exhibits a marked change in performance; or
 - (e) The unit has been dropped or the cabinet damaged.
- 2. Servicing**—Do not attempt to service the unit beyond that described in these operating instructions. Refer all other servicing to authorized servicing personnel.
- 3. Replacement parts**—When parts need replacing ensure the servicer uses parts specified by the manufacturer or parts that have the same characteristics as the original parts. Unauthorized substitutes may result in fire, electric shock, or other hazards.
- 4. Safety check**—After repairs or service, ask the servicer to perform safety checks to confirm that the unit is in proper working condition.

Cautions for safest use of this unit

Installation location

1. A well-ventilated place.
Take care not to use this unit in a place where it will not receive sufficient ventilation, and not to permit the ventilation holes to be covered by curtains, or any similar materials.
2. Place away from direct sunlight and excessive heat from heating equipment.
3. A place where humidity, vibration and dust are minimized.

Power source

1. Be sure the line voltage selector is in accordance with local voltage in your area before connecting the plug to the socket.
2. DC power cannot be used.

Handling the power cord

1. Never touch the power cord, or its plug, with wet hands.
2. Don't pull the power cord.

Metal items inside the unit may result in electric shock or damage.

Do not permit metal articles to get inside the unit.

Be especially careful with regard to this point if children are near this unit. They should be warned never to try to put anything inside.

If, nevertheless, some such article does get inside, disconnect the power cord plug from the electrical outlet, and contact the store where the unit was purchased.

If water gets into the unit

Disconnect the power cord plug from the electrical outlet, and contact the store where it was purchased.

As a precaution, it is suggested that flower vases and other containers which hold liquids not be placed on the top of this unit.

If operation seems abnormal

Immediately turn off the power, disconnect the power cord plug from the electrical outlet, and contact the store where it was purchased.

Discontinue using the unit at once. Failure to do so may result in additional damage or some other unexpected damage or accident.

- Because the power source is located inside the unit, it is normal for the cabinet to become warm.

A word about the power cord

If the power cord is scarred, is partially cut or broken, or has a bad contact, it may cause a fire or serious electrical shock if used. NEVER use a damaged power cord for any appliance. Moreover, the power cord should never be forcibly bent.

Don't touch the inside parts of this unit.

Some places inside this unit have high voltage potential. Never try to remove the top or back panels of this unit, or to touch inside parts by hand or with tools.

Contact someone who is qualified in order to inspect the inside, or to replace a fuse, if such becomes necessary. Never attempt to do these things yourself.

Maintenance

The following suggestions will assist you in keeping the unit in top condition.

- Be sure to switch the instrument off after use, and do not switch the unit on and off in quick succession, as this places an undue load on the electronic components.
- To keep the luster of the surface and buttons, simply use a clean, damp cloth; polish with a soft, dry cloth. Polish may be used but do not use thinners or petro-chemical-based polishes.
- A wax-based polish may be used on the cabinet, although you will find that rubbing with a soft cloth will suffice.

This product may receive radio interference caused by mobile telephones during use. If such interference is apparent, please increase separation between the product and the mobile telephone.

SVENSK: Det kan inträffa att den här produkten under användningen tar emot radiostörningar, orsakade av mobiltelefoner. Öka avståndet mellan produkten och mobiltelefonen om störningarna är uppenbara.

**SERVICE MUST BE CARRIED OUT BY DEALER
OR OTHER QUALIFIED PERSON**

Contents

Cautions for safest use of this unit	7
Controls and functions (PR604)	10
Controls and functions (PR804)	12

BASIC FUNCTIONS

Getting started	14
Playing the piano	15
Progressive Pianist	16
See and listen to the demonstration	17
Select a sound	18
Select the registration for a music style (PIANO STYLIST)	19
Automatic panel settings (ONE TOUCH PLAY)	20
Record your performance (SEQUENCER)	22
Store your panel settings (PANEL MEMORY)	24
Save data on a floppy disk	25
Load rhythm data from a Technics pattern disk (COMPOSER LOAD)	27
Play back commercial song disks (DIRECT PLAY)	28
Theatre Sonic (PR804)	29
Remote Controller (PR804)	30

PRACTICAL APPLICATIONS

About the display	31
Favorites	33
Part I Sounds and effects	34
Selecting sounds	34
Overview of sounds and effects	34
Assigning parts to the keyboard	36
Pedals	38
Touch Sensitivity	39
Effects	39
Mic Reverb & Effect	41
Transpose	42
Techni-chord	43
Part II Playing the rhythm	44
Selecting rhythms	44
Overview of rhythm performance	44
Playing the rhythm	46
Auto Play Chord	47
Fade In/Fade Out	51
Sound Arranger	52
One Touch Play	52
Piano Stylist	53
Music Style Arranger	54
Panel Memory	55
Part III Piano Performance Pads (PR804)	57
Playing phrases	57
Copying phrases	58
Compile	59
Record a phrase	59
Part IV Sequencer	61
Outline of the Sequencer	61
Slide Show	63
Sequencer parts	64
Easy Record	65
Realtime Record	65
Sequencer Play	67
Naming	69
Panel Write	69
Song Select	70
Punch Record	70
Step Record	71
Track Assign	76
Quantize	77
Song Clear	77
Track Clear	78
Note Edit	78
Drum Edit	79
Copy and paste the recorded data	80
Changing the note position etc. of the recorded data	82
Part V Composer	85
Outline of the Composer	85
Simple recording method	86

Create a completely new rhythm	86
Chord Modify Change	88
Part Setting	89
Playback	89
Step Record	90
Measure Edit	91
Pattern Copy	92
Part VI Disk Drive	94
Outline of the Disk Drive function	94
Outline of the procedure	95
Loading data	96
Direct Play	98
Song Medley	99
Saving data	99
Disk management	102
Set the automatic display when a disk is inserted	102
Part VII Sound	103
Outline of the Sound	103
Part Setting	103
Mixer	105
Master Tuning	107
Key Scaling	107
Sound Load Option	108
APC Reverb Setting	108
Part VIII Reverb & Effect	109
Outline of the Reverb & Effect	109
Tone Control	109
Part IX Sound Edit	110
Outline of the Sound Edit	110
Easy Edit	111
Tone Edit	111
Pitch Edit	113
Filter Edit	114
Amplitude Edit	116
LFO (cyclic modulation) Edit	117
Effect Edit	118
Controller Edit	118
Store the new sound	119
Part X Control	120
Outline of Control functions	120
Pedal Setting	121
Part XI Customize	122
Outline of Customize functions	122
Display Time Out	123
Data Protection	123
MIDI Setting Load Option	124
Video Out Mode Setting (PR804)	124
Theatre Sonic Speaker Mode (PR804)	125
Part XII MIDI	126
What is MIDI?	126
Outline of MIDI functions	127
Part Setting	128
Control Messages	129
Realtime Messages	129
Common Setting	130
Mode Setting	131
Input/output Setting	131
MIDI Presets	132
Program Change MIDI Out	133
Panel Memory Output	133
Computer Connection	134
Initialize	135
Connections	136
Assembly (PR604)	137
Assembly (PR804)	138
Symptoms which appear to be signs of trouble	139
Error messages	141
Index	142
Specifications	144

■ **Supplied accessories**

Please check the supplied accessories.



Music stand
 AC cord

CD-ROM
 **Remote Controller,
Batteries (PR804)**

Controls and functions (PR604)

AUTO PLAY CHORD

Add an automatic accompaniment to your selected rhythm.
(Refer to page 47.)

PIANO STYLIST

You can choose to have all the settings of this instrument automatically set. (Refer to page 53.)

PROGRESSIVE PIANIST

Your piano offers a fun method of learning to play piano.
(Refer to page 16.)

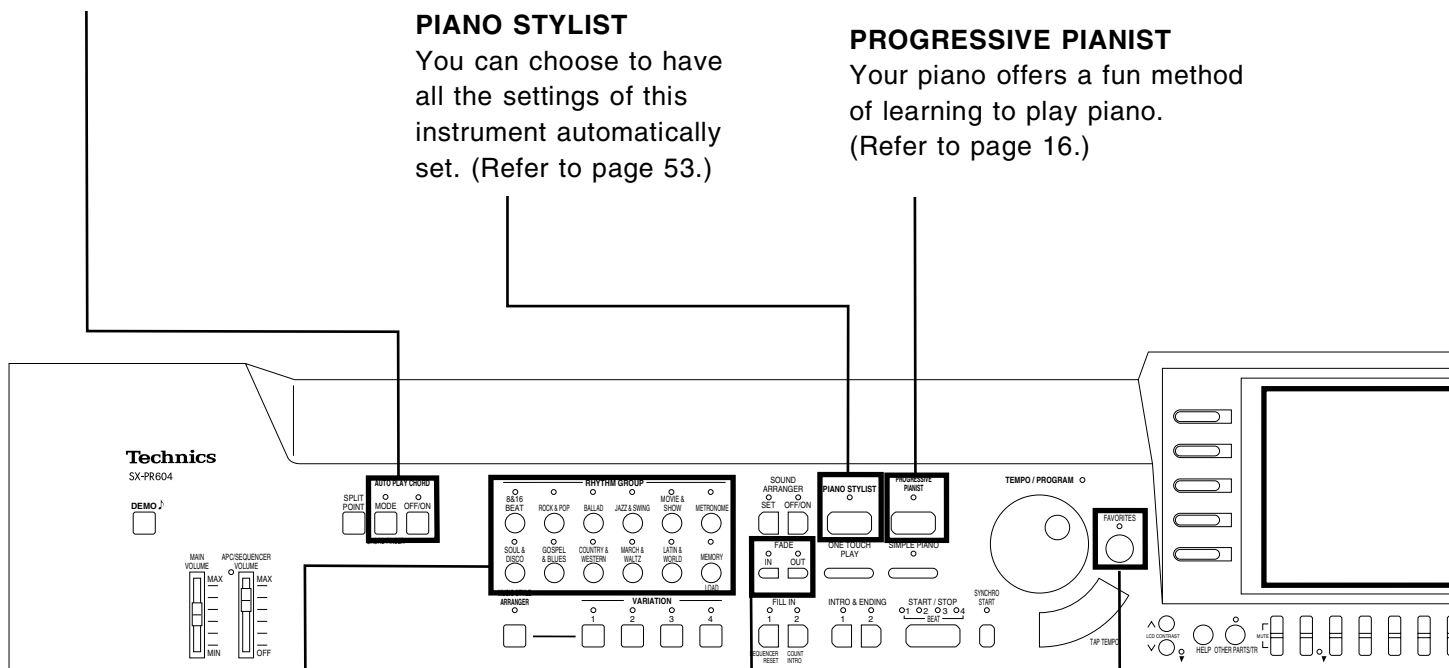

RHYTHM GROUP

Various rhythm patterns are available for each rhythm group.
(Refer to page 44.)

FADE IN/OUT

Begin your song with a slowly increasing volume, or end it by having the sound slowly fade away.
(Refer to page 51.)

FAVORITES

Fashion a customized display in which all your favorite sounds, rhythms and styles are assembled.
(Refer to page 33.)

■ Tuning

Unlike an acoustic piano, your PR Series Digital Ensemble never needs tuning. The pitch of this instrument can be adjusted for when playing along with other instruments. (Refer to page 107.)

■ About the backup memory

The settings and memories are maintained for approximately 80 minutes after the power to this instrument is turned off. If you wish to keep the memory contents, before you turn off the instrument, use the SAVE procedure to store the desired data on a disk for recall at a later time.

- The backup memory does not function until the power has been on for about 10 minutes.
- When you quit the operating mode, a REMINDER display may appear to remind you to save the data.

DISPLAY

Displays performance information, function settings and other messages. (Refer to page 31.)

- Use the **LCD CONTRAST** buttons to adjust the display so that it is easy to read.

TRANPOSE

Raise or lower the key of the entire keyboard. (Refer to page 42.)

SOUND GROUP

Various sounds are available for each sound group. (Refer to page 34.)

EFFECT

Add various effects to the sounds. (Refer to page 39.)

SEQUENCER

Record and play back your performance. (Refer to page 61.)

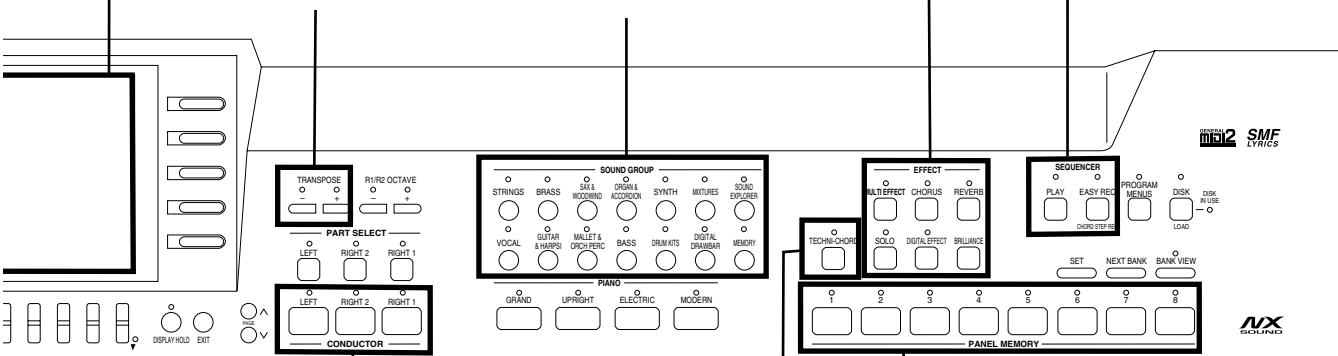

CONDUCTOR

Assign a different sound to each part, then assign the desired parts to sections of the keyboard. (Refer to page 36.)

TECHNI-CHORD

Block chords are automatically added to the melody. (Refer to page 43.)

PANEL MEMORY

Store the panel settings, then recall them instantaneously just by pressing a button or two. (Refer to page 55.)

Controls and functions (PR804)

AUTO PLAY CHORD

Add an automatic accompaniment to your selected rhythm.

(Refer to page 47.)

PIANO PERFORMANCE PADS

Add various phrases to your performance with the pad buttons. (Refer to page 57.)

RHYTHM GROUP

Various rhythm patterns are available for each rhythm group.

(Refer to page 44.)

PIANO STYLIST

You can choose to have all the settings of this instrument automatically set. (Refer to page 53.)

PROGRESSIVE PIANIST

Your piano offers a fun method of learning to play piano. (Refer to page 16.)

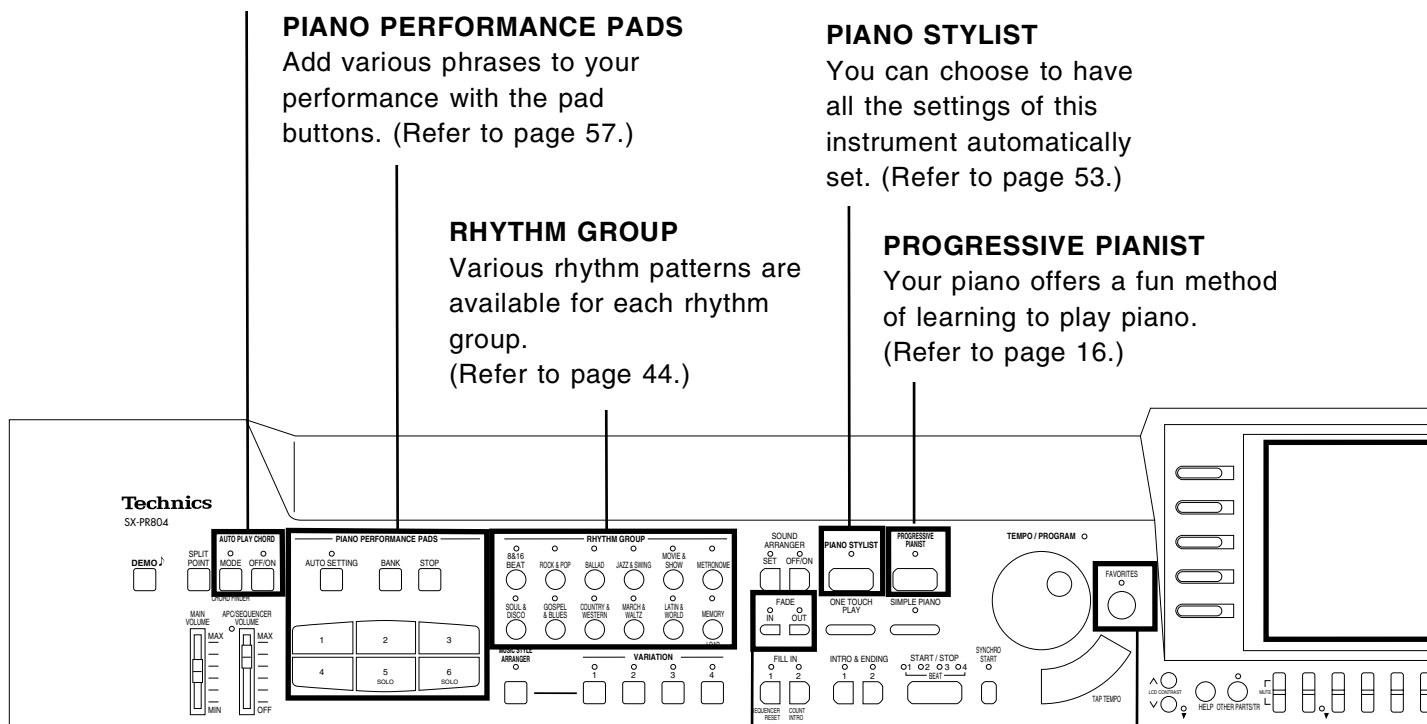

FADE IN/OUT

Begin your song with a slowly increasing volume, or end it by having the sound slowly fade away.

(Refer to page 51.)

FAVORITES

Fashion a customized display in which all your favorite sounds, rhythms and styles are assembled. (Refer to page 33.)

■ Tuning

Unlike an acoustic piano, your PR Series Digital Ensemble never needs tuning.

The pitch of this instrument can be adjusted for when playing along with other instruments. (Refer to page 107.)

■ About the backup memory

The settings and memories are maintained for approximately 80 minutes after the power to this instrument is turned off. If you wish to keep the memory contents, before you turn off the instrument, use the SAVE procedure to store the desired data on a disk for recall at a later time.

- The backup memory does not function until the power has been on for about 10 minutes.
- When you quit the operating mode, a REMINDER display may appear to remind you to save the data.

DISPLAY

Displays performance information, function settings and other messages.
(Refer to page 31.)

- Use the **LCD CONTRAST** buttons to adjust the display so that it is easy to read.

TRANPOSE

Raise or lower the key of the entire keyboard.
(Refer to page 42.)

SOUND GROUP

Various sounds are available for each sound group. (Refer to page 34.)

EFFECT

Add various effects to the sounds. (Refer to page 39.)

SEQUENCER

Record and play back your performance.
(Refer to page 61.)

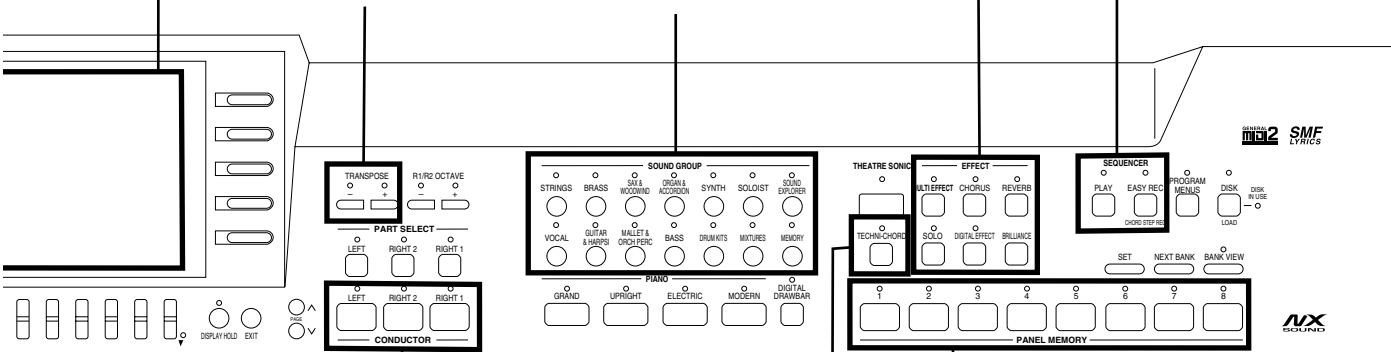

CONDUCTOR

Assign a different sound to each part, then assign the desired parts to sections of the keyboard.
(Refer to page 36.)

TECHNI-CHORD

Block chords are automatically added to the melody.
(Refer to page 43.)

PANEL MEMORY

Store the panel settings, then recall them instantaneously just by pressing a button or two. (Refer to page 55.)

Getting started

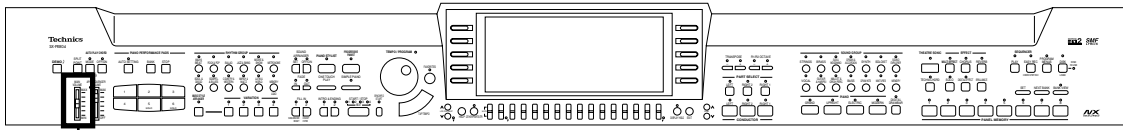

(PR804)

1 Plug the power cord into an outlet.

2 Press the **POWER** button to turn it on.

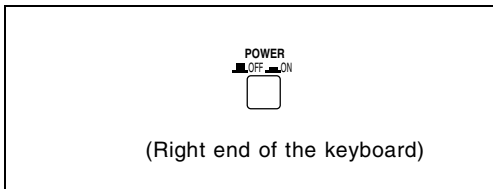

- The power indicator in the left front of the body is lit.

3 Touch any note on the keyboard.

- Your piano features Touch Response. You control the volume by playing the keys harder or softer.

4 Set the **MAIN VOLUME** to an appropriate level with the sliding control.

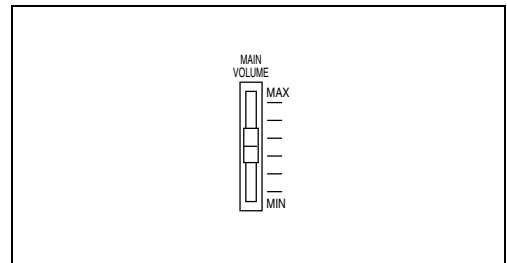

Keyboard cover

Open and close the cover slowly.

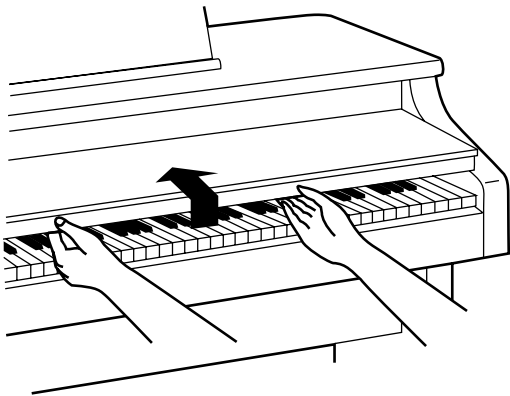

Music Stand

PR604: Insert the music stand and fix it.

PR804: Set the music desk at desired position and insert it.

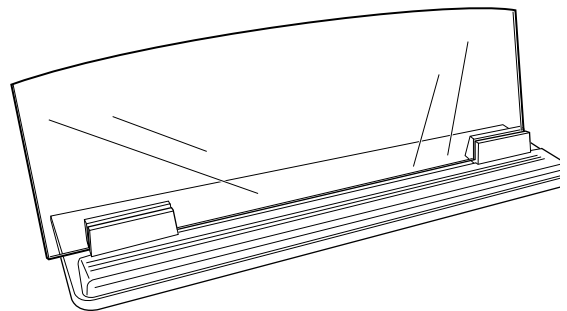

Playing the piano

Your piano is equipped with various fine functions which make it an extremely versatile instrument. But it should be remembered that it is first of all a fine piano. Select one of the piano sounds and enjoy its excellent quality.

When you activate the **SIMPLE PIANO** feature, the entire keyboard is instantly transformed into a piano, regardless of the current instrument settings.

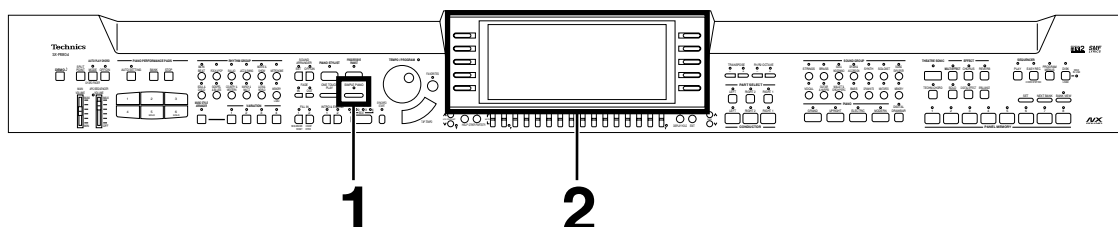

1 Press the **SIMPLE PIANO** button to turn it on.

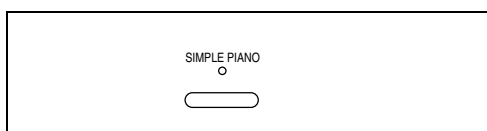

- The indicator lights.
- The display changes to the SIMPLE PIANO display.

2 Select the desired type of piano sound.



- The sounds and effects are automatically set.
- COMPLETED!" is shown on the display, and then the normal display reappears.

3 Play anywhere on the keyboard.

- This procedure will cancel the current settings for sounds and effects, etc. Therefore, if you wish to later recall the current settings, be sure to store them in the **PANEL MEMORY** (page 55) or save them to a disk (page 99) before beginning this procedure.

Progressive Pianist

Your piano offers a fun method of learning to play piano. Start one of the 100 etudes incorporated in this piano, read the music in the display, listen to the gentle accompaniment for your own and, have a good practice!

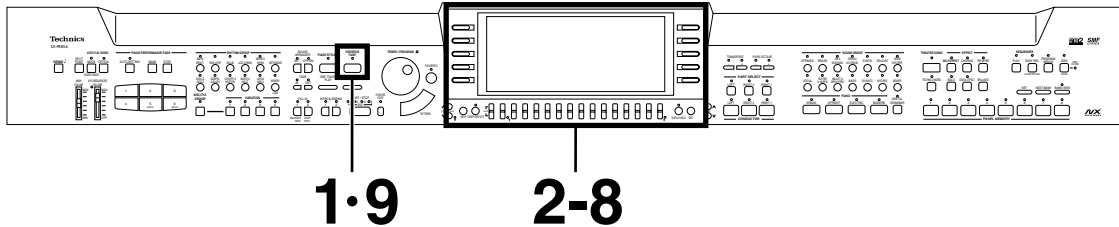

- 1** | Press the **PROGRESSIVE PIANIST** button.

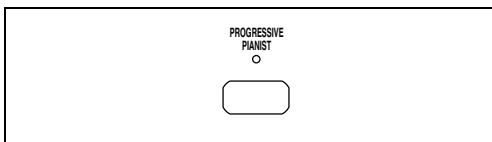

- 2** | Select the goal of the practice.



- 3** | Use the **SONG** \wedge and \vee buttons to select a preferred song.



- 4** | Press the **LISTEN** button.

- 5** | Press the **START/STOP** button on the control panel and listen to the model interpretation while watching the music on the display.

- Press the **START/STOP** button to stop the model performance. Press it again to continue the interpretation from the point at which it was interrupted.

- 6** | When you have finished listening, press the appropriate button to access the next step.

- In the Practice Makes Perfect/Musical Discovery mode, press the **PLAY (STEP2)** button, and for the Grand Performer/Pianist Mode Session mode, follow the step number to continue your practice.

- 7** | Press the **RESET** button.

- 8** | Press the **START/STOP** button to start the exercise. Play the keyboard and follow the music exactly.

- To redo your exercise from the beginning, press the **START/STOP** button to stop the music and press the **RESET** button. You can also use the **MEAS** button to start from a desired position.
- If the tempo of the accompaniment is too fast, press the **SLOW 1** button in the **ONE TOUCH TEMPO** section. If it is still too fast, press the **SLOW 2** button. (You can also use the **TEMPO/PROGRAM** dial to adjust the tempo.)
- The music pages shown on the display turn automatically. If you wish to turn them manually, set **TURN PAGE** to **MANUAL** and you can press the **PAGE** button to change the display (upper; previous page, lower; next page). In this case, you can also turn the page by depressing the left pedal.
- To play a different song while the performance is stopped, press the **EXIT** button, and then repeat the above procedure from step 2.

- 9** | To exit this feature, press the **PROGRESSIVE PIANIST** button again.

See and listen to the demonstration

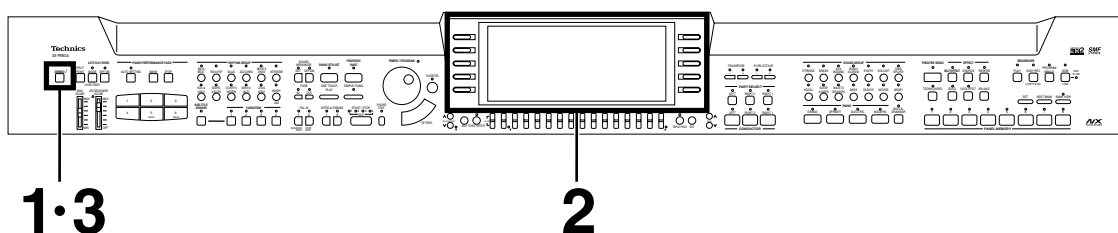

1 | Press the **DEMO** button.

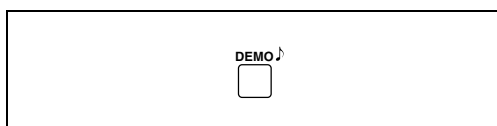

3 | When you are finished listening to the demonstration tunes, press the **DEMO** button again.

2 | Use the buttons to the left and right the display to select the demonstration tune you wish to see and listen to.

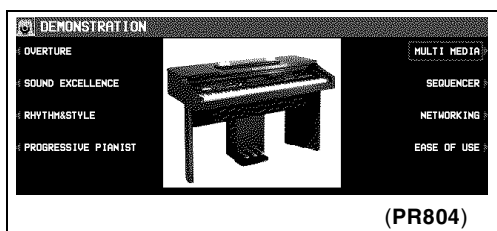

- The demonstration performance and display corresponding to your selection will begin.
- To end the demonstration before it has finished, press the **START/STOP** button.

■ Slide Show

The Slide Show function displays the images which change in concordance with the music progression. Enjoy, with the DEMO songs, a variety of the images which switch automatically according to each image of the music.

- You can set images for the Slide Show for your own music. (See page 63.)

- If you press and hold the **DEMO** button for a few seconds, or if you press first the **DEMO** button and then the **START/STOP** button, all the internal demo tunes are demonstrated in order in a medley performance. The medley performance continues until the **START/STOP** button or the **DEMO** button is pressed again.

- Some of the buttons do not function during the DEMO mode.

Select a sound

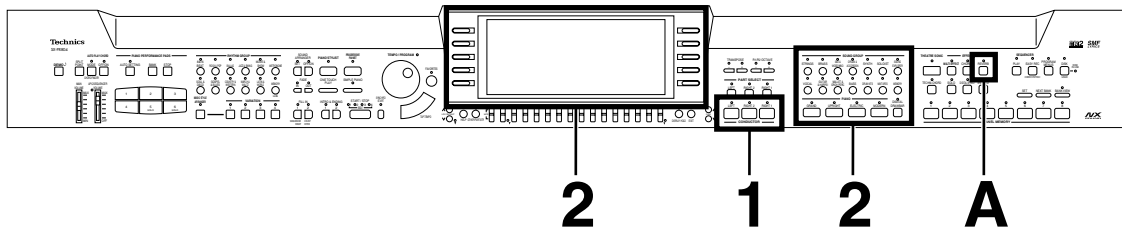

1 In the **CONDUCTOR** section on the panel, press the **RIGHT 1** button to turn it on.

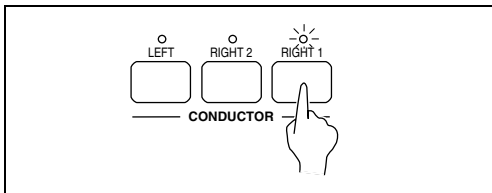

Add reverbation.

A Press the **REVERB** button to turn it on.

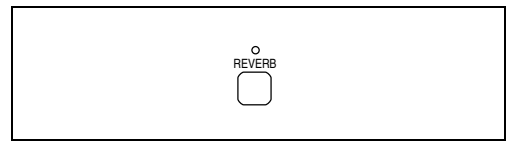

2 In the **SOUND GROUP** or **PIANO** section, press one of the sound buttons.

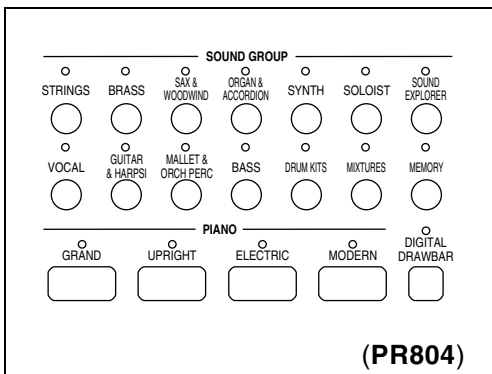

3 Select a sound from the list of sounds shown on the display.

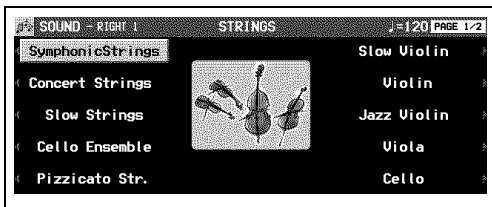

- For most of the buttons, the list of sounds is contained on two or more screen “pages.” To see a different part of the list, press either **PAGE** button.

4 Play the keyboard.

Select the registration for a music style (PIANO STYLIST)

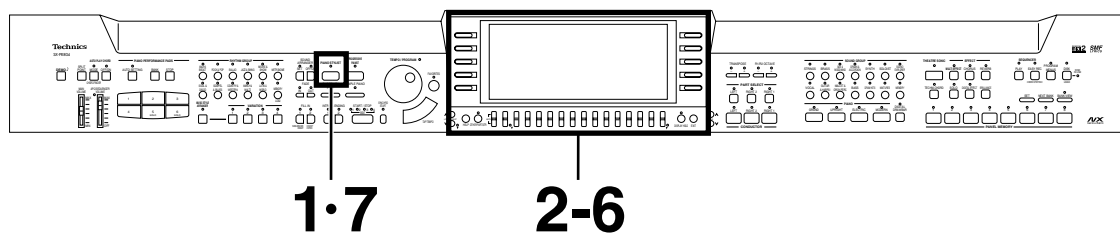

1 Press the **PIANO STYLIST** button to turn it on.

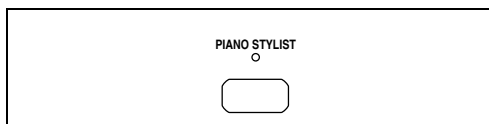

2 Press the **PIANO STYLES** button.

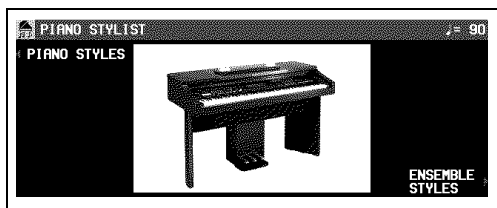

3 Use the **ARRANGE MODE** button to select the desired type of arrangement.

- Select the type you wish to play (PIANO SOLO/PIANO & COMBO /PIANO & ENSEMBLE).



4 Use the **SELECT MODE** button to specify how you wish to select a style.
GENRE: Select a style by musical genre.
ERA: Select a style by era.
ALPHABET: Select a style from an alphabetical list.

5 Use the **GENRE/ERA/ALPHABET** button to select a group. Use the **STYLE** button to select a style.

- In the above example, GENRE was selected.
- If the list covers more than one screen "page," the MORE button is shown on the display. Use the MORE button to switch between screen pages.
- The **AUTO PLAY CHORD** and **SYNCHRO START** turn on, and the sounds, effects, rhythm, tempo, volume balance, etc. which are best suited for the selected music style are automatically selected.

6 Play the keyboard.

- When you specify a chord on the left area of the keyboard, the automatic accompaniment immediately begins to play.
- You can use the **TEMPO/PROGRAM** dial to adjust the tempo.

7 When you are finished selecting the style, turn the **PIANO STYLIST** button off.

Automatic panel settings

(ONE TOUCH PLAY)

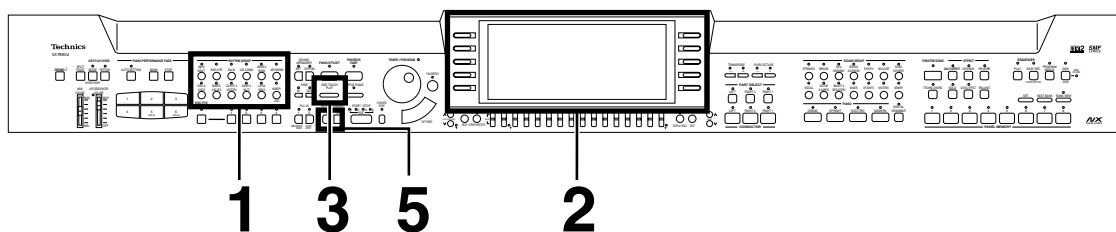

- 1** In the **RHYTHM GROUP** section, press the button for a desired rhythm.

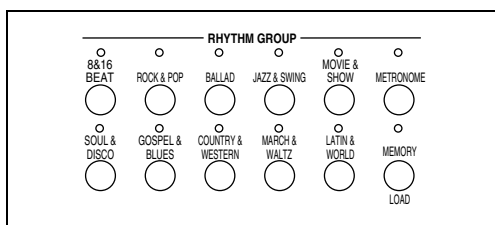

- 5** At the end of your performance, press the **INTRO & ENDING 1** or **2** button.

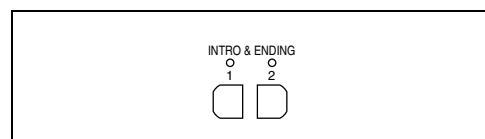

- An ending pattern is played, after which the automatic accompaniment stops.
- If the **START/STOP** button is pressed, the accompaniment stops immediately.

- 2** Select a rhythm from the list of rhythms on the display.

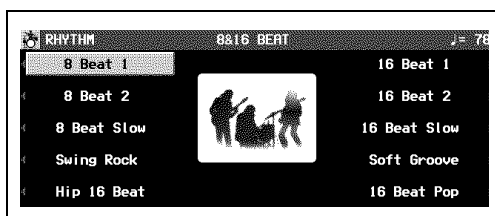

- 3** Press and hold the **ONE TOUCH PLAY** button for a few seconds.

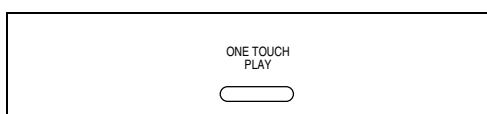

- The sound, effects and tempo suitable for the selected rhythm are automatically selected. The tempo can be adjusted with the **TEMPO/PROGRAM** dial.

- 4** Use your left hand to play the chords and your right hand to play the melody.
- Pressing a key on the left area of the keyboard will cause the automatic rhythm pattern to start playing (synchro start).

Two staves of music in C major. The first staff contains a melody: C4, E4, G4, F4, E4, D4, C4. The second staff contains a bass line: C3, E3, G3, F3, E3, D3, C3. Chord symbols C, F, G7, and C are placed above the notes in each measure.

Diagram illustrating the one-finger chord fingerings for C, G7, and F on a piano keyboard. The C chord is shown with the thumb on C4. The G7 chord is shown with the thumb on G3 and the index finger on B3. The F chord is shown with the thumb on F3.

- In this example you played chords by pressing the keys for the "root notes" (ONE FINGER chords). But you can also specify the chord by playing all the notes in the chord. (Refer to page 47.)
- You can insert a fill-in pattern while the preset rhythm pattern is playing by pressing either the **FILL IN 1** or **FILL IN 2** button.

Record your performance (SEQUENCER)

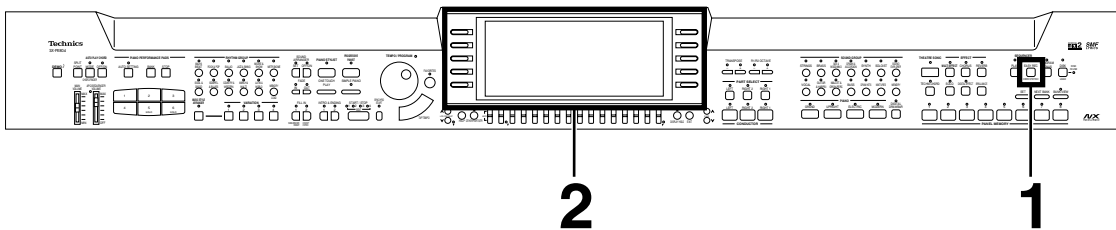

Sonatina

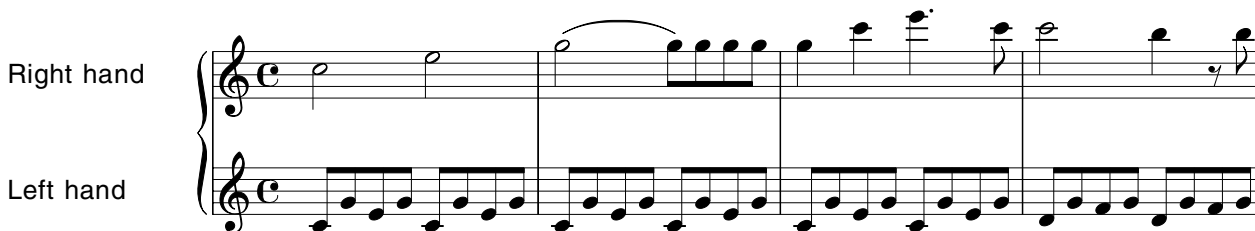

1 In the **SEQUENCER** section, press the **EASY REC** button to turn it on.

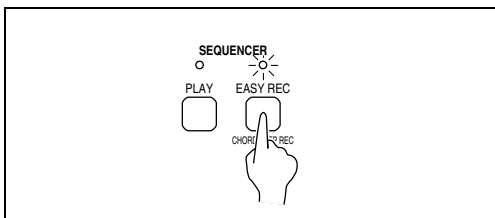

2 Press the **OK** button.

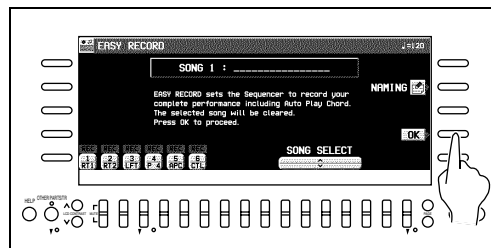

- The display changes to the **REALTIME RECORD** display.

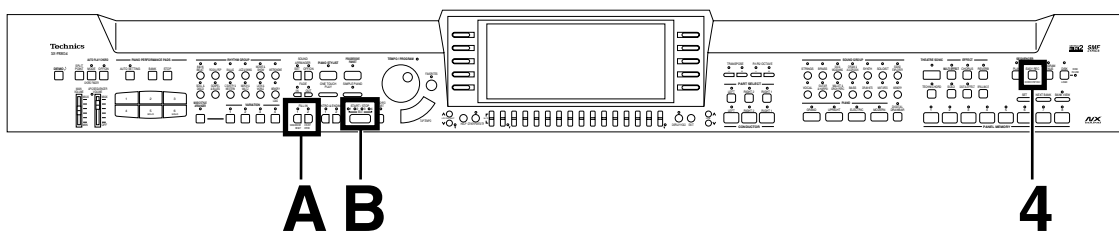

3 | Play the song on the keyboard.

4 | When you have finished playing, press the **EASY REC** button again to turn it off.

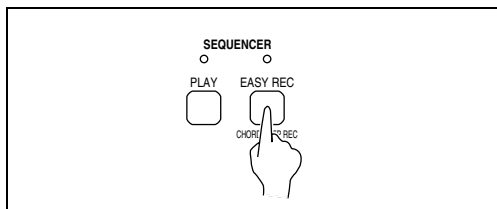

- The **PLAY** button in the **SEQUENCER** section turns on.

Playing back your recorded performance

A | Press the **SEQUENCER RESET (FILL IN 1)** button.

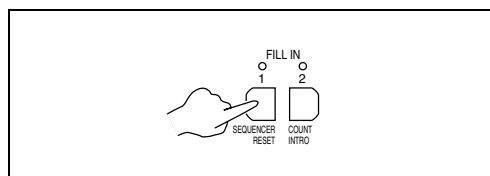

B | Press the **START/STOP** button.

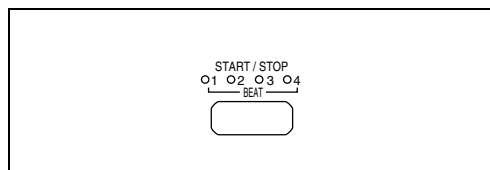

- Your performance is played back just as you recorded it.
- When you are finished playing back your performance, press the **PLAY** button in the **SEQUENCER** section to turn it off.

Store your panel settings (PANEL MEMORY)

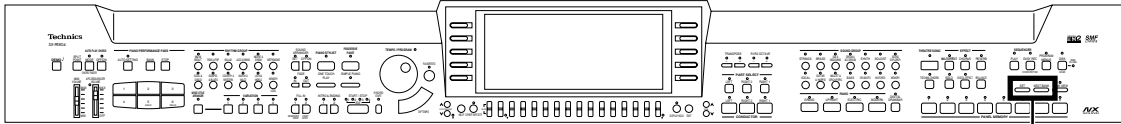

2·3

1 Set up the desired panel settings (sounds, volumes, etc.)

2 Use the **NEXT BANK** button to select a bank (A, B, C).

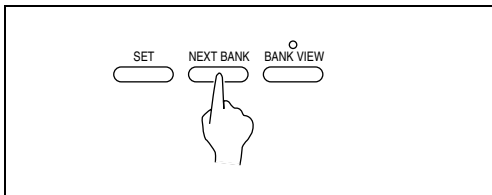

- The bank names are shown on the display.

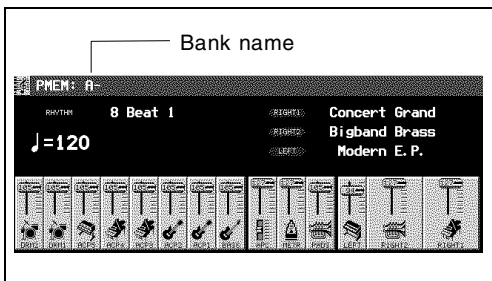

3 With the **SET** button held down, press one of the numbered buttons of the **PANEL MEMORY** (1 to 8).

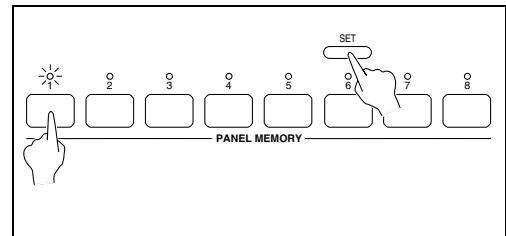

- The current panel settings are now stored in the specified bank and number. When you select the same bank and number again, the stored panel settings are recalled.

Save data on a floppy disk

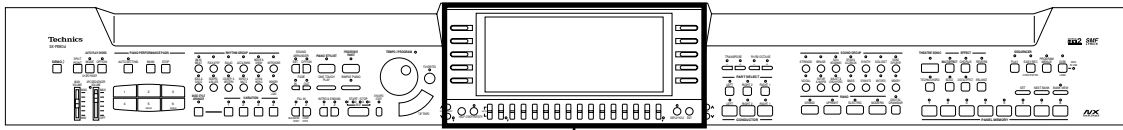

2-5

1 Insert a disk you wish to save to into the Disk Drive slot. Push it all the way in until you hear a click.

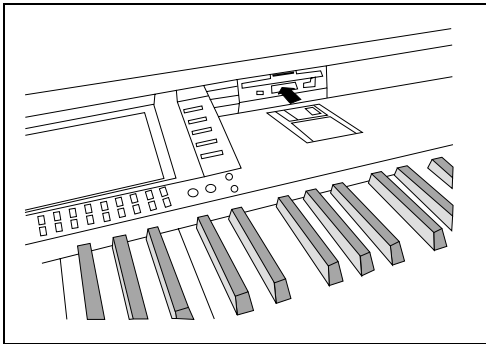

2 On the DISK MENU display, select **SAVE**.

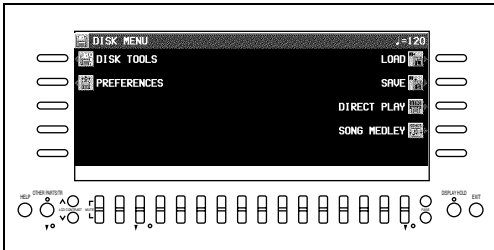

- If you attempt to use the SAVE procedure when an unformatted disk is inserted into the Disk Drive slot, the FORMAT display appears. Follow the instructions on the display to format the disk. (Formatting the disk will clear any data which is currently stored on the disk.)

3 Select **TECHNICS FORMAT**.

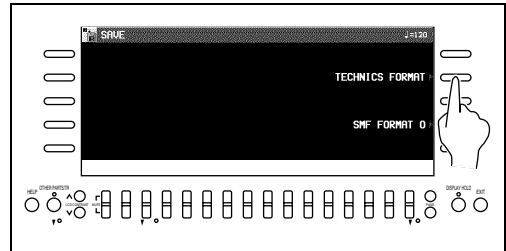

4 Specify a file number to save to.

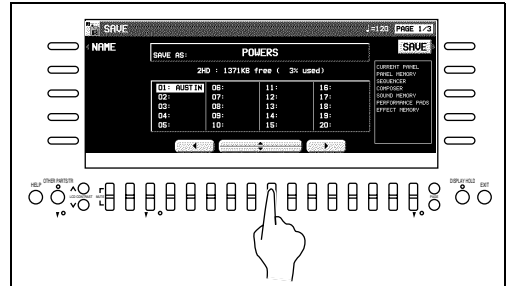

5 Press the **SAVE** button.

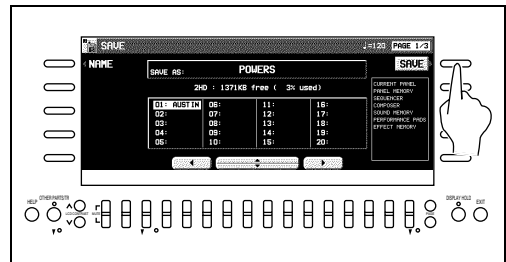

- The performance data of the song recorded in the **SEQUENCER** is saved on the floppy disk.

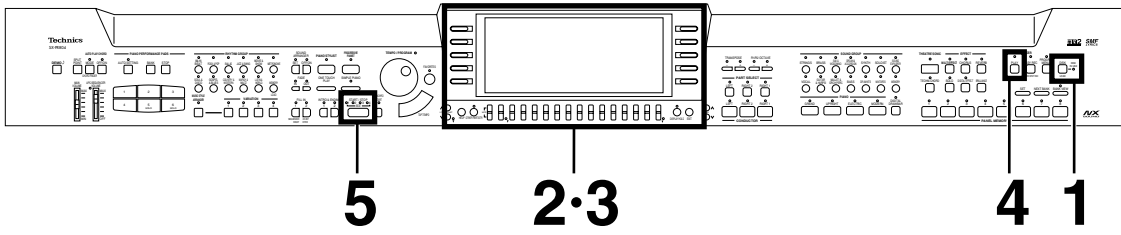

Recall data from a floppy disk

1 Press and hold the **DISK** button for a few seconds.

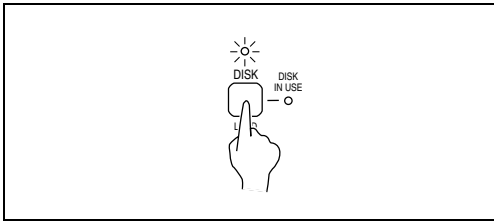

2 Select the file you wish to load.

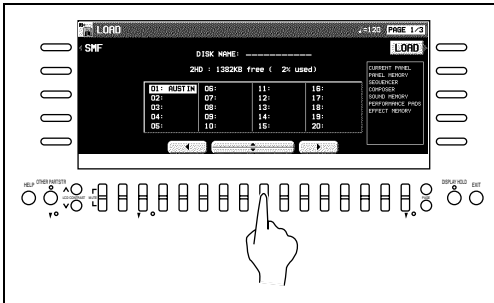

3 Press the **LOAD** button.
 • The data is copied to the internal memory of this instrument.

4 Press the **PLAY** button in the **SEQUENCER** section to turn it on.

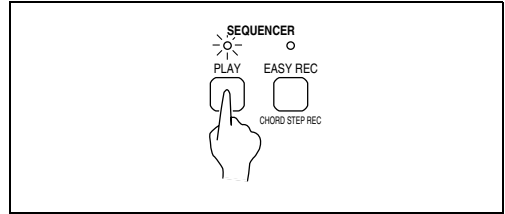

5 Press the **START/STOP** button.

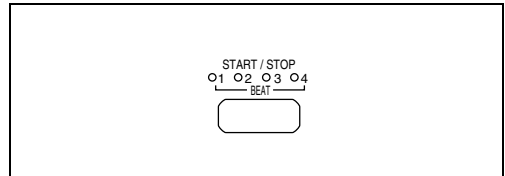

• The recalled song is played back.

■ The following data can be saved/loaded:

PERFORMANCE	CURRENT PANEL (The current panel settings)
	PANEL MEMORY
	SEQUENCER
	COMPOSER (MEMORY contents)
	SOUND MEMORY
	EFFECT MEMORY
BACKUP	PADS (USER memories of the PIANO PERFORMANCE PADS) (PR804)
	MIDI (USER memory of the MIDI PRESETS)
	FAVORITES

• For detailed information, refer to page 94.

Load rhythm data from a Technics pattern disk (COMPOSER LOAD)

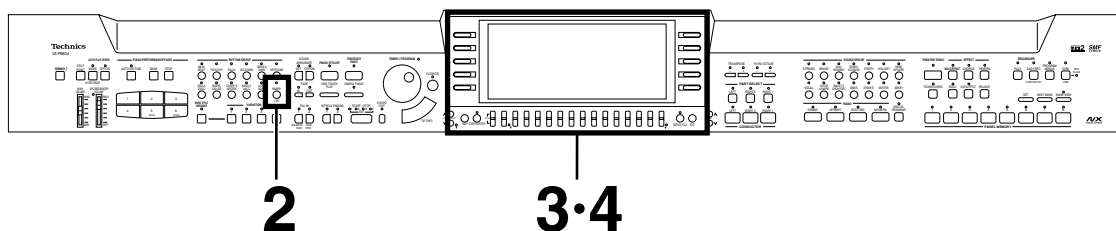

1 Insert a commercially sold Technics pattern disk into the Disk Drive slot.

2 In the **RHYTHM GROUP** section, press and hold the **LOAD (MEMORY)** button for a few seconds.

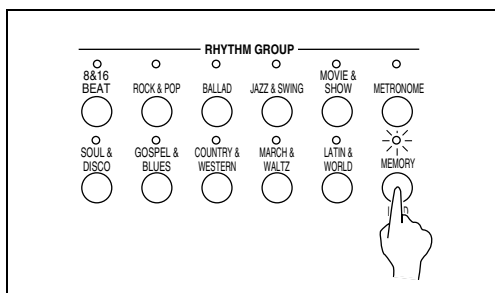

4 Press the **LOAD** button.

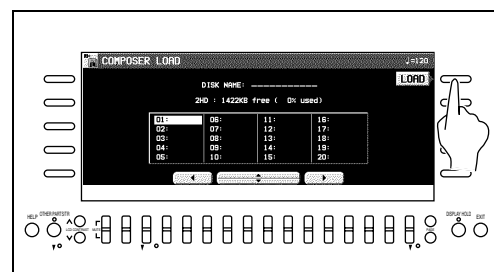

• Rhythm data is loaded to the **COMPOSER** memory (**MEMORY**). You can use the rhythms during your performance, just like the preset rhythms.

3 Select the name of the pattern to load.

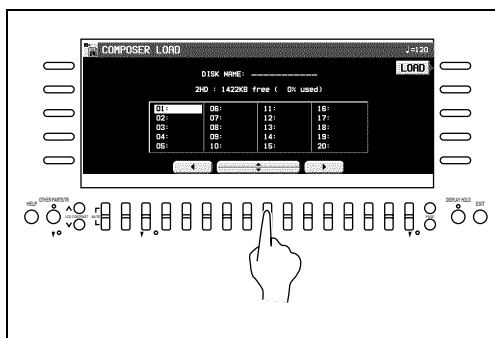

Play back commercial song disks (DIRECT PLAY)

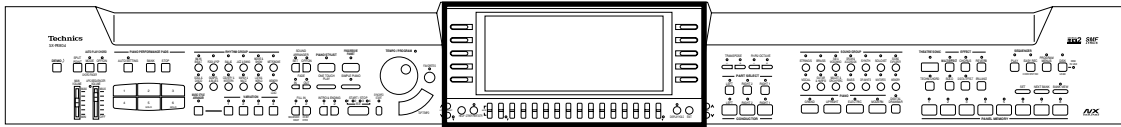

2-4

1 Insert the song disk into the Disk Drive slot.

4 Press the START button.
• The selected song is played back.

2 On the DISK MENU display, select DIRECT PLAY.

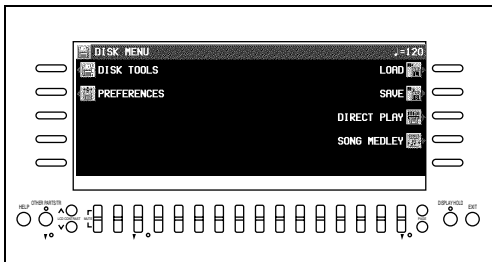

3 Use the buttons below the display to select a song.

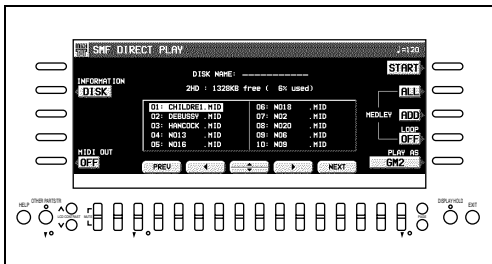

• For SMF songs, use the PLAY AS button to specify a sound arrangement mode.

• DIRECT PLAY is possible from the following disks:

Standard MIDI File
Standard MIDI File with Lyrics
DISK ORCHESTRA COLLECTION™ (DOC)
PianoDisc™

* All product and company names are trademarks or registered trademarks of their respective owners.

* DISK ORCHESTRA COLLECTION is a trademark of the YAMAHA Corporation.

Theatre Sonic (PR804)

The **THEATRE SONIC** feature creates a special sound field to give stereoscopic effects to the instrument sound. This effect can be enhanced by adding external rear speakers.

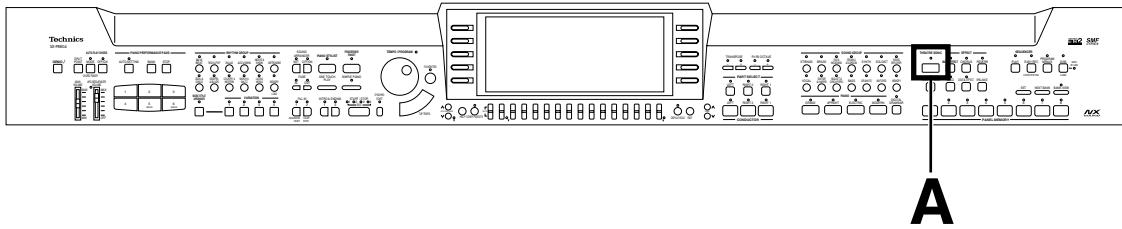

■ Sound-field schema

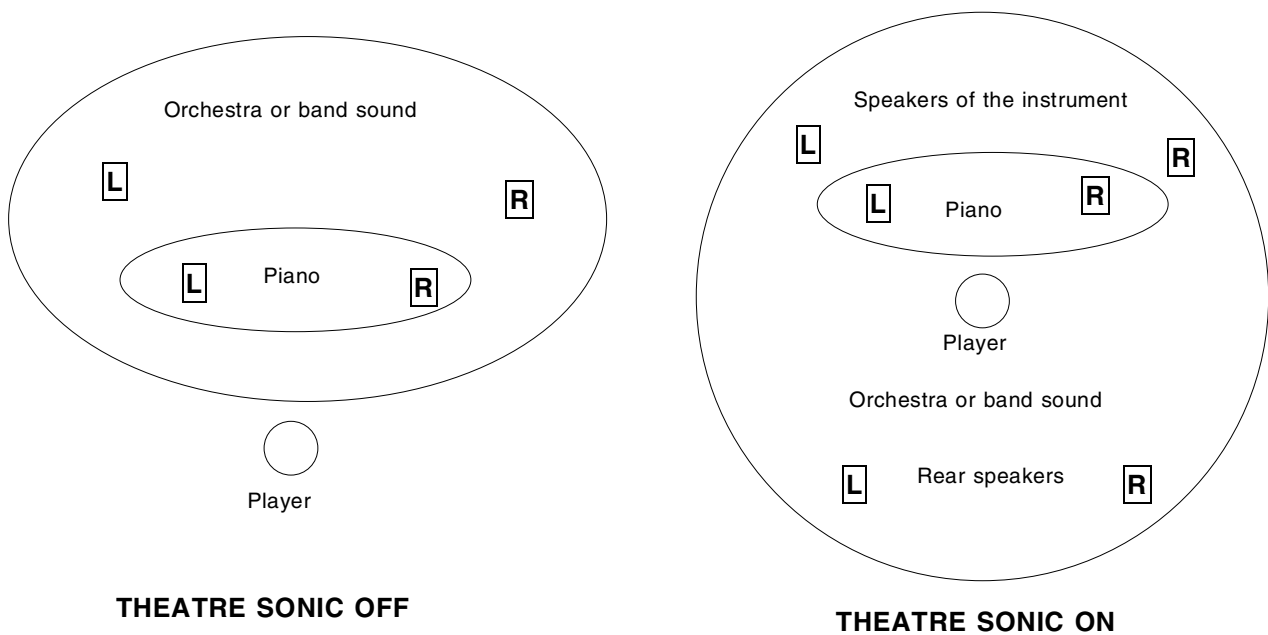

A Press the **THEATRE SONIC** button to turn it on.

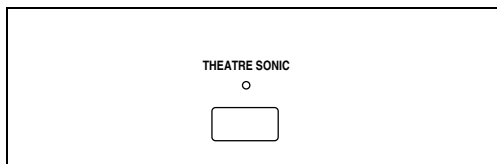

- The effect is applied.
- Even if rear speakers are not connected, a virtual 4-channel effect is applied.

- For connection of external rear speakers, refer to page 136.
- Change the mode according to the presence of the rear speakers (refer to page 125).
- The effect can be set to on or off for each part (refer to page 108).

Remote Controller (PR804)

You can use the included wireless remote control to adjust the MAIN VOLUME, activate DIRECT PLAY (page 98), and activate SEQUENCER playback (page 67).

- To operate **DIRECT PLAY** with the remote controller, the normal playback display must be present with the disk inserted, and for the **SEQUENCER** playback, the instrument must be in the stand-by mode for playing back.

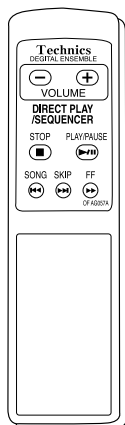

■ Battery installation

- Before insertion, make sure the battery polarity is as indicated.
- Do not use old batteries together with new ones.
- Remove the batteries from the battery compartment and store separately when the instrument is not to be used for a long time.

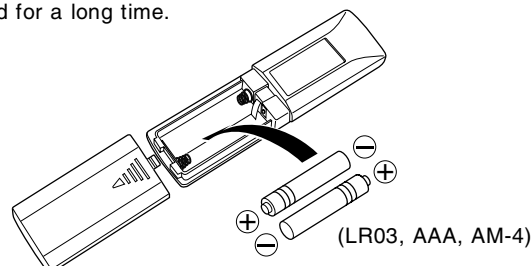

Button functions

VOLUME

Adjust the total volume level.

- You can adjust the volume level within the value set by the **MAIN VOLUME** control of the instrument.
- The volume level adjusted with the remote controller is reset when the instrument power is turned off.

<DIRECT PLAY/SEQUENCER>

PLAY/PAUSE

Play back or stop the performance temporarily.

FF

Fast forward (for DIRECT PLAY only)

SONG SKIP

Skip the current song (for DIRECT PLAY only)

STOP

Stop the performance.

Correct use of the remote controller

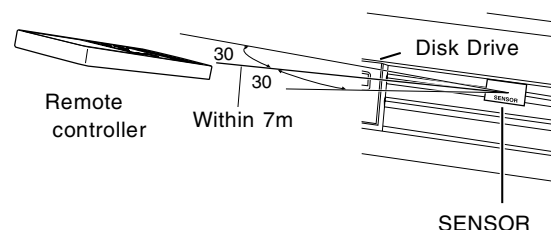

- No object should be present between the remote control and the SENSOR.
- Avoid exposing the SENSOR to sources of strong radiation such as direct sunlight or fluorescent lamps.
- Keep the surfaces of the SENSOR and the emitter of the controller clean.

CAUTION:

- Do not disassemble or modify.
- Do not place any heavy object on top of the remote controller.
- Do not expose to direct sunlight for long periods of time.
- Do not spill any liquid.

About the display

A large-size display, easy to operate with excellent readability, is used for displaying various information such as the names of the selected sounds and rhythms etc. and when setting the functions. Let's take a look.

- The display illustrations shown in this User's Manual are examples for the sake of clarification; the actual displays on your instrument may differ from the illustrations.

Normal display (HOME PAGE)

This is the kind of information you see on the display during a normal performance.

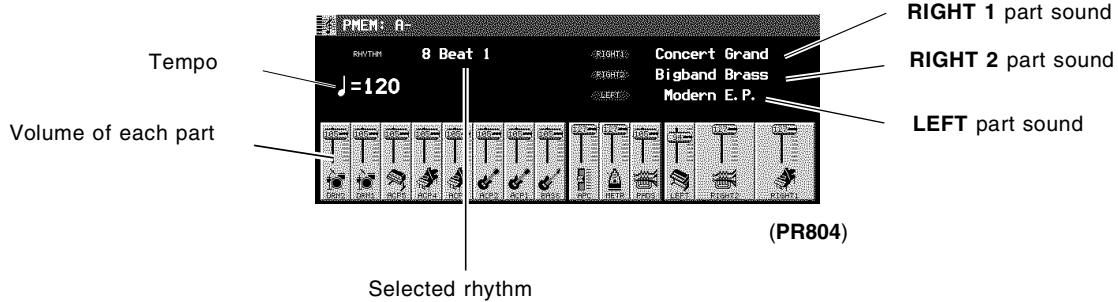

Volume balance

At the bottom half of the normal display, the volume balance of each part is represented in a fader illustration and by a number (0 to 127). You can use the balance buttons below the display to adjust the volumes.

<Performance parts>

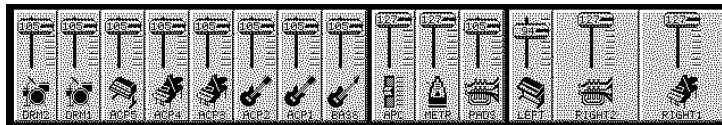

RT: RIGHT APC: AUTO PLAY CHORD PADS: PIANO PERFORMANCE PADS (PR804)
METR: METRONOME

When setting the volume balance, press the upper button to increase the volume and the lower button to decrease it.

- Hold a button down to scroll the volume quickly.

■ MUTE

To mute a part, press both the corresponding upper and lower buttons at the same time.

- The volume display for a muted part is shown as "MUTE".
- Pressing either balance button for a muted part will cancel the mute function.

■ OTHER PARTS/TR button

If you press the **OTHER PARTS/TR** button, the display changes to show the volumes of PART (PT) 1–16. You can then adjust the volumes of these parts. These parts are active when playing back a song disk or when this instrument is connected to external MIDI equipment and is used as a multi-timbre sound generator.

- When there are other parts or tracks to access, the **OTHER PARTS/TR** indicator is lit.

PAGE

When there are additional parts to the current display, a page number indication, for example PAGE1/2, appears in the upper right corner of the screen. For example, 1/2 indicates that there are two pages of the display, and the current page is page 1. In this case, you can use the upper and lower **PAGE** buttons, to the right of the balance buttons, to view different "pages" of the display.



- Press the upper button to view the next page of the display, and the lower button to view the previous page of the display.
- On the last page of the display, pressing the upper button returns to the first page. And conversely, on the first page of the display, pressing the lower button will skip to the last page.

Menu display

The **PROGRAM MENUS** button controls multiple functions. Press the button to access its menu display.



■ Example of menu display: PROGRAM MENUS

Select a function from the menu display by pressing the corresponding button to the left or right of the display indicated by the ◀ and ▶ arrows.



(PR804)

- In this manual, the steps describing how to select a function from a menu display are generally abbreviated as follows, for example: "On the PROGRAM MENUS display, select SOUND."

Setting display

When you select an item from the menu display, the setting display for the item is shown. The buttons to the right, left and/or directly below the display are used to select and adjust the settings.

■ Example of setting display: MASTER TUNING

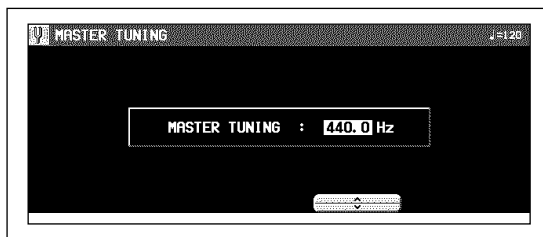

⇒ Press the button corresponding to the ^ or v button on the display to change the value.

- In this manual, this procedure is written as follows: "Use the ^ and v buttons to adjust the pitch."

TEMPO/PROGRAM

If the **TEMPO/PROGRAM** indicator is lit while you are using the display to adjust the setting, it indicates that this dial can be used to quickly change the displayed value or setting.

TEMPO / PROGRAM ◦

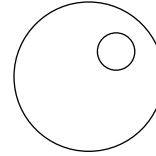

- The setting which can be adjusted is highlighted on the display.

EXIT

While the setting display is shown, press this button to go back to the previous display.

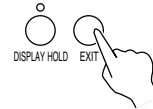

DISPLAY HOLD

Press this button to turn it on when you wish to maintain the current display. You can keep a display which is normally automatically canceled, for example, or even during a performance, you can monitor information which is not shown on the normal display.



- The indicator for this button may flash if the current display is one which is normally automatically canceled.
- If the **PROGRAM MENUS** button, for example, is pressed, the **DISPLAY HOLD** mode is canceled.

CONTRAST

Use the **LCD CONTRAST** buttons to adjust the readability of the display.



(Left of the display)

HELP

You can find an explanation of each button's function on the display.

1. Press the **HELP** button.



- The following display appears.



2. Use the buttons below the display to select a language.

3. Press the OK button.

4. Press a button on the panel whose explanation you wish to read.

- An explanation of the button's function is shown on the display.

5. Press the **HELP** button again to exit the help mode.

- Attention display messages and error messages are also shown in the selected language.

- The appearance of the display on your instrument may be different from the illustrated display in this manual depending on the region in which your instrument was purchased and the selected display language.

Favorites

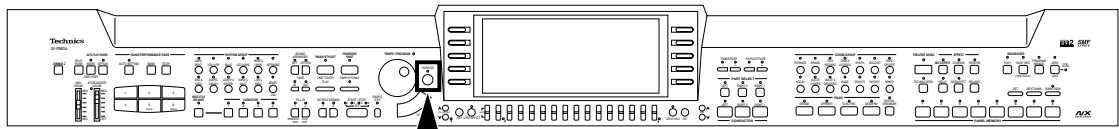

(PR804)

You can record a special display of your favorite sounds and rhythms, styles.

1. Select the sounds, rhythm and styles you wish to record.

- Use the **PIANO STYLIST** feature to select the style. (Refer to page 53.)

2. Press the **FAVORITES** button.



- The display looks similar to the following.

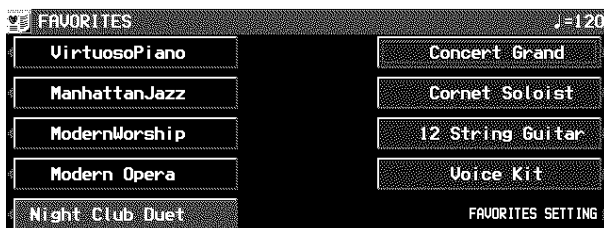

3. Press the **FAVORITES SETTING** button.

- The display looks similar to the following.

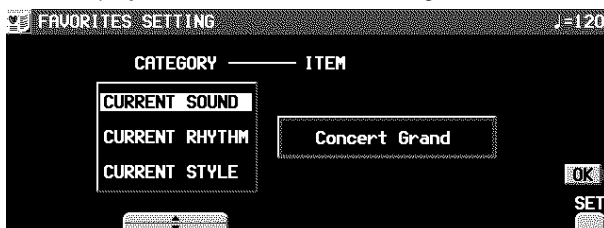

4. Use the **CATEGORY** ▲ and ▼ buttons to select the desired item (**CURRENT SOUND/RHYTHM/STYLE**).

- The selected sound/rhythm/style are shown in the **ITEM** column.

5. While pressing the **SET** button, specify where you wish to paste (put) the item.

- While the **SET** button is depressed, the display appears as shown below. Use the buttons to the left and right of the display to specify where you wish to paste the item.

6. Repeat steps 3 to 5 to create the display you want.

- There are nine settable items on the display.
- To record a sound or rhythm other than that selected in step 1, while the **FAVORITES** display is shown use the panel buttons to select the desired sound or rhythm. (The corresponding selection window is superimposed on the display.)
- To record a style other than that selected in step 1, after the other recording procedures are completed and the **OK** button is pressed, repeat the procedure from step 1.

7. Press the **OK** button.

- Your customized display is stored.

■ Recall a FAVORITES display

1. Press the **FAVORITES** button.

2. Use the buttons to the left and right of the display to specify the **ITEM** you wish to recall.

Part I Sounds and effects

Overview of sounds and effects

The following is an overview of the sound parts of this instrument.

NX SOUND

NX SOUND is the Technics original sound generator format which evokes realtime performance quality and expressive power, and dramatically expands the number of sounds and effects generated. This format includes GM2 (General MIDI Level 2), and make various controls possible when data is created and reproduced by computer.

- For information about GM2, refer to page 95.
- Equipment with the logo shown below is compatible with NX SOUND song data.



Part

This instrument is mainly organized into the following parts.

RIGHT 1, RIGHT 2, LEFT:

These are the parts the performer plays on the keyboard.

- These are independent from the playback parts. For example one can to perform on the keyboard while playing back a song disk with 16-part standard MIDI files (SMF).

PART1 to 16:

SMF song disk playback parts, or parts for MIDI receive.

ACCOMP1 to 5, BASS, DRUMS 1, 2:

Parts for the automatic accompaniment.

PADS:

Parts for the **PIANO PERFORMANCE PADS (PR804)**

METRONOME:

The part for the **METRONOME** sounds.

Selecting sounds

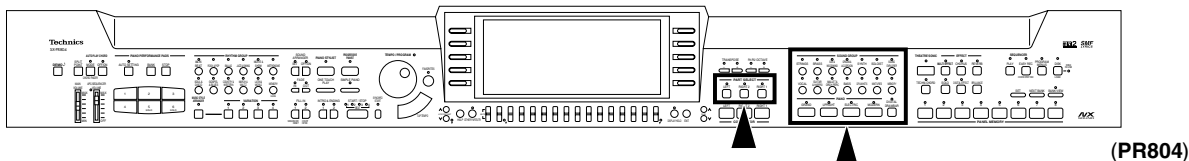

Select the sounds for the three parts you can play on the keyboard—**RIGHT 1, RIGHT 2** and **LEFT**. After first selecting a part and a **SOUND GROUP**, choose the desired sound from the display.

Select a sound

1. In the **PART SELECT** section, choose **RIGHT 1, RIGHT 2** or **LEFT**.

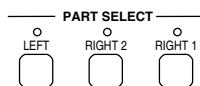

- The **CONDUCTOR** buttons are used to specify which part is heard. (Refer to page 36.)
- For the **RIGHT 1** and **RIGHT 2** parts, when a **CONDUCTOR** button is selected, the corresponding **PART SELECT** button is also activated.

2. Select a sound group.

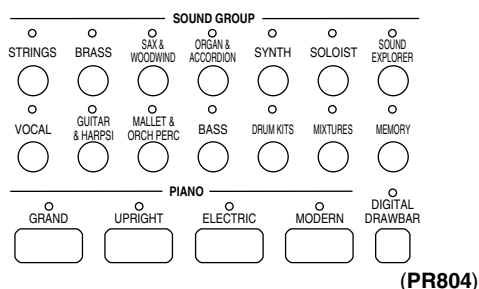

- The sounds in **DRUM KITS** are percussion sounds that you play by striking the keyboard keys.
- **MEMORY** is reserved for storing sounds you modify. (Refer to page 119.)

3. Select the desired sound from the list on the display.

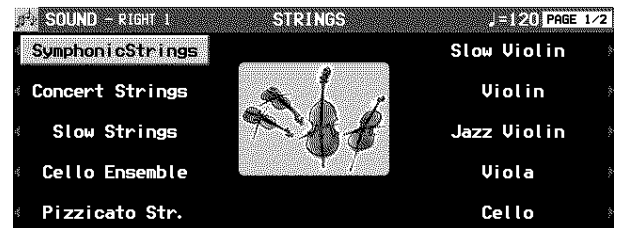

- You can use the **PAGE** buttons to view a different part of the list (except for a portion of the **PIANO** group).
- The sound you select is memorized for the part you selected in step 1.
- The sound display may differ depending on the effect settings.

4. Play the keyboard.

SOUND EXPLORER

This is a convenient feature for finding the sound you want from the many available sounds.

1. In the **PART SELECT** section, select a part.
2. Press the **SOUND EXPLORER** button to turn it on.



- Use the buttons to the left and right of the display to select the sound.



3. Use the \wedge and \vee buttons to select a **GROUP** of sound.

4. Use the buttons on both side of the display to select the sound.

- The list of sounds is contained on several screen “pages.” Use the **PAGE** buttons to see a different part of the sound list.
- The numerical value that is displayed for each sound is the MIDI [BANK MSB, LSB]-PROGRAM CHANGE number.
- GM2 sounds are selected from the GM2 EXTEND or GM2 DRUM KITS group.

■ ALPHABET

Press the **CATEGORY** button to show the sound names in alphabetical order.

- Press the **ALPHABET** button to return to the **CATEGORY** display.

DIGITAL DRAWBAR

You can play organ sounds while controlling the drawbars on the display.

1. In the **PART SELECT** section, select a part.
2. Press the **DIGITAL DRAWBAR** button to turn it on.
 - The display looks similar to the following.

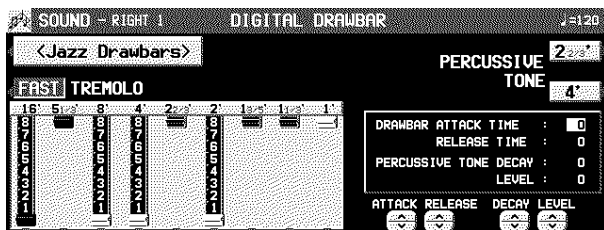

3. Use the balance buttons below the display to adjust the volume of each drawbar.

- The volume of each drawbar is illustrated on the display and changes when you press the corresponding balance buttons to adjust the volume.
- The **DIGITAL DRAWBAR** can not be selected for the **COMPOSER**, **SOUND ARRANGER** or **PIANO PERFORMANCE PADS (PR804)**.

■ Change the sound type

⇒ Use the **<Jazz Drawbars>** / **<Rock Drawbars>** button to select the type of sound.

■ PERCUSSIVE TONE

PERCUSSIVE TONE adds a tone with a fast initial attack to the drawbar sounds. You can select two pitch levels of attack tones.

⇒ Use the **PERCUSSIVE TONE 2 2/3'** and **4'** buttons to turn the respective tone on or off.

■ TREMOLO

Tremolo is a rapid oscillation in volume, like the effect of a rotating speaker. The tremolo speed can be changed while you are playing.

⇒ Use the **TREMOLO** button to switch between the **SLOW** and **FAST** rotating speeds.

- The tremolo setting is effective for each part in common.
- You can also use the **DIGITAL EFFECT** button to switch between **SLOW** and **FAST**.
- The tremolo does not work when the **MULTI EFFECT** button is on.

■ Other settings

DRAWBAR ATTACK TIME:

Select **ATTACK TIME**, and use the \wedge and \vee buttons to adjust the time it takes for the drawbar sound to sound after a key is played.

DRAWBAR RELEASE TIME:

Select **RELEASE TIME**, and use the \wedge and \vee buttons to adjust the time it takes for the drawbar sound to die out after the keys are released.

PERCUSSIVE TONE DECAY:

Select **DECAY**, and use the \wedge and \vee buttons to adjust the time it takes for the percussive tone to die out.

PERCUSSIVE TONE LEVEL:

Select **LEVEL**, and use the \wedge and \vee buttons to adjust the volume of the percussive tone.

- The above settings are effective for all the parts in common.

About foot marks

The foot indication on each balance button (for example 8') refers to the pitch of a rank of pipes in a pipe organ. If 8' is used as the standard (the pitch as played on the keyboard), a 16' rank pitch will be one octave below the 8' rank pitch, and a 4' rank pitch one octave above.

When the middle C key is pressed, the sounds of the different pitch ranks are as follows.

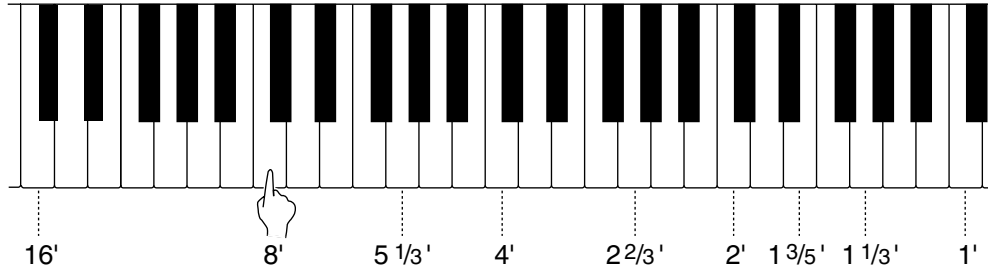

Assigning parts to the keyboard

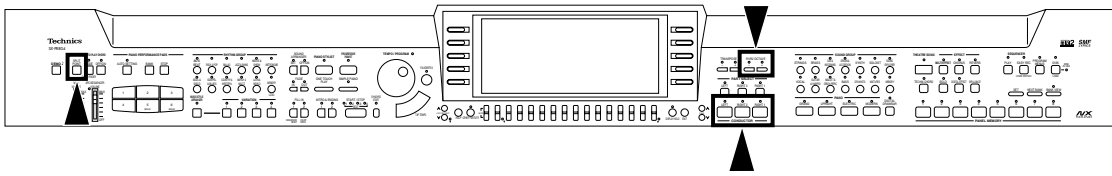

The **CONDUCTOR** buttons are used to assign the parts (**RIGHT 1**, **RIGHT 2**, **LEFT**) to the keyboard in many different ways.

CONDUCTOR

CONDUCTOR settings	How sounds are assigned to the keyboard
	All keys produce the RIGHT 1 sound. <div style="border: 1px solid black; padding: 10px; text-align: center; width: fit-content; margin: 0 auto;">RIGHT 1</div>
	All keys produce the RIGHT 2 sound. <div style="border: 1px solid black; padding: 10px; text-align: center; width: fit-content; margin: 0 auto;">RIGHT 2</div>
	All keys produce both the RIGHT 1 sound and the RIGHT 2 sound. <div style="border: 1px solid black; padding: 10px; text-align: center; width: fit-content; margin: 0 auto;">RIGHT 1 + RIGHT 2</div>
	The left keys produce the LEFT sound and the right keys produce the RIGHT 1 sound and the RIGHT 2 sound. <div style="display: flex; justify-content: space-around; border: 1px solid black; padding: 10px;"> <div style="border: 1px solid black; padding: 5px; text-align: center;">LEFT</div> <div style="border: 1px solid black; padding: 5px; text-align: center;">RIGHT 1 + RIGHT 2</div> </div>
	The left keys produce the LEFT sound and the right keys produce the RIGHT 1 sound. <div style="display: flex; justify-content: space-around; border: 1px solid black; padding: 10px;"> <div style="border: 1px solid black; padding: 5px; text-align: center;">LEFT</div> <div style="border: 1px solid black; padding: 5px; text-align: center;">RIGHT 1</div> </div>
	The left keys produce the LEFT sound and the right keys produce the RIGHT 2 sound. <div style="display: flex; justify-content: space-around; border: 1px solid black; padding: 10px;"> <div style="border: 1px solid black; padding: 5px; text-align: center;">LEFT</div> <div style="border: 1px solid black; padding: 5px; text-align: center;">RIGHT 2</div> </div>

- The volume for each part can be adjusted independently. (Refer to page 31.)
- The following conditions are in effect when the **AUTO PLAY CHORD** is used.
 BASIC, ADVANCED mode: You cannot assign sounds to all the keys.
 PIANIST mode: The keyboard cannot be split.

SPLIT

You can split the keyboard into right and left sections (**SPLIT**), and assign a different sound to each section.

1. Press the **LEFT** button in the **CONDUCTOR** to turn it on.

- If the **LEFT** part does not turn on, then turn off the **AUTO PLAY CHORD**, or select any mode except **PIANIST**.

2. Use the **SPLIT POINT** button to define the point that divides the left and right keyboard sections.

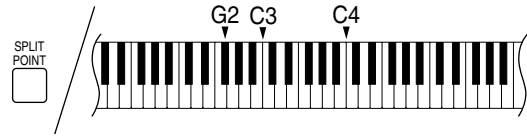

- Each time the **SPLIT POINT** button is pressed, the indication moves to the next split point in the following order: G2 → C3 → C4 → customized split point (all indicators off) (see below).

■ Customized split point

Use the following procedure if you wish to store a split point at a location other than G2, C3 or C4.

1. Press and hold the **SPLIT POINT** button for a few seconds.



- The following display appears.

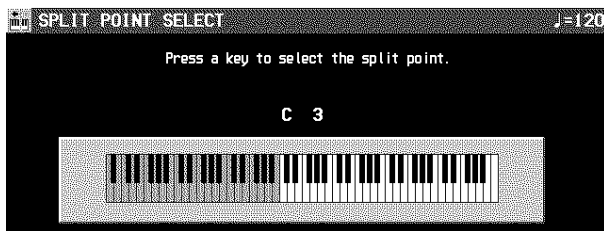

2. Press a key on the keyboard to specify the desired split point.

- A split point is set at the location of the pressed key, and is indicated on the keyboard illustration on the display.
- The key at the split point is the lowest note of the right keyboard section.
- After a few seconds, the display exits the setting mode.
- Whenever the keyboard is split, you can select your customized split point by pressing the **SPLIT POINT** button until none of the split point indicators is lit. In this case, the customized split point is indicated on the display.

RIGHT 1/RIGHT 2 OCTAVE

During your performance you can quickly change the octave of the **RIGHT 1** and **RIGHT 2** parts. Use this convenient function to expand the octave range of the keyboard, especially during a split-keyboard performance.

⇒ Use the **R1/R2 OCTAVE** buttons (+ and –) to change the octave.



- Press the + button to raise the pitch and the – button to lower the pitch (–2 to +2).
- The display looks similar to the following.



- You can also use the ^ and v buttons on the R 1/R 2 OCTAVE display to change the octave.
- The display returns to the previous display after a few seconds.
- A lit + or – indicator shows that the octave has been changed.
- To cancel the octave change, press both buttons at the same time.

- The note pitches (NOTE NUMBER) recorded in the **SEQUENCER** and during MIDI transmission are also affected by this octave setting. However, it does not affect **SEQUENCER** playback or received MIDI data.

Pedals

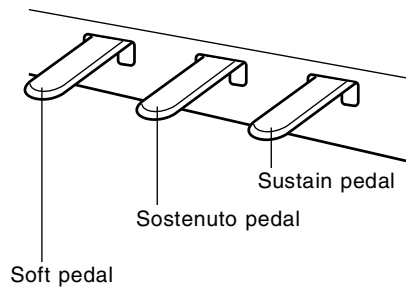

■ Sustain pedal

When a key is released while this pedal is depressed, the sound is sustained so that it lingers and slowly fades out.

- This effect does not work for the sounds in the **DRUM KITS** group.
- This effect does not work for some sounds.
- The length of the sustain can be set for each part. (Refer to page 104.)
- **PR804**: This pedal is an eight-stage pedal, and the length of the sustain is controlled by the degree to which the pedal is depressed.

■ Sostenuto pedal

If this pedal is pressed while the keys are pressed, the sustain effect is applied to those notes only. If the pedal is pressed first and the keys are then pressed, the sustain effect does not work for those notes.

- For continuous-type sounds, such as **ORGAN**, the notes sound as long as the pedal is pressed.
- You can select a different function to control with this pedal. (Refer to page 121.)

■ Soft pedal

When this pedal is depressed, the sound is softer and the volume is slightly lower.

- You can select a different function to control with this pedal. (Refer to page 121.)

String resonance

String resonance is the sound heard in an acoustic piano when the struck strings produce a sympathetic resonance of the other unstruck strings. For the **GRAND PIANO** and **UPRIGHT PIANO** sounds, string resonance is produced as long as the sustain pedal is depressed. The amount of string resonance can be adjusted.

1. Press and hold the **GRAND** button for about 3 seconds.



- **STRING RESONANCE DEPTH** is shown on the display.

2. Use the \wedge and \vee buttons to adjust the amount of resonance (0 to 99).



- The higher the number, the greater the amount of resonance.
- When set to 0, there is no string resonance.

Touch Sensitivity

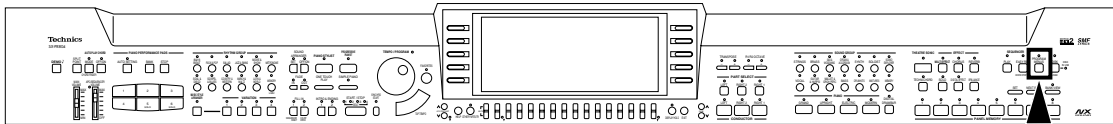

Adjust keyboard touch response.

1. Press the **PROGRAM MENUS** button to turn it on.

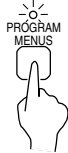

- The display looks similar to the following.



2. Select **TOUCH SENSITIVITY**.

- The display looks similar to the following.

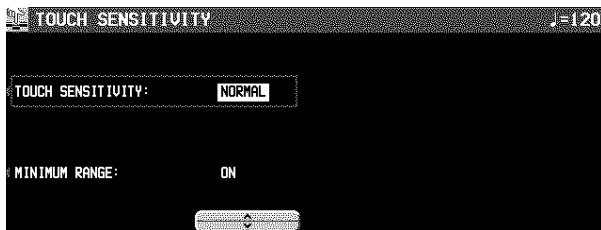

3. Use the buttons to the left of the display to select the function you wish to set. Use the ▲ and ▼ buttons to adjust the setting.

TOUCH SENSITIVITY: This is the keyboard touch response setting.

- Select from HEAVY 3, HEAVY 2, HEAVY 1, NORMAL and LIGHT.

MINIMUM RANGE: Specify whether or not the keyboard keys function when the keys are pressed very softly (ON/OFF).

- When set to ON, the keys do not function when they are pressed very softly, as in an acoustic piano. When set to OFF, the keys function even when they are pressed very softly.

4. When you have finished adjusting the settings, press the **PROGRAM MENUS** button again.

Effects

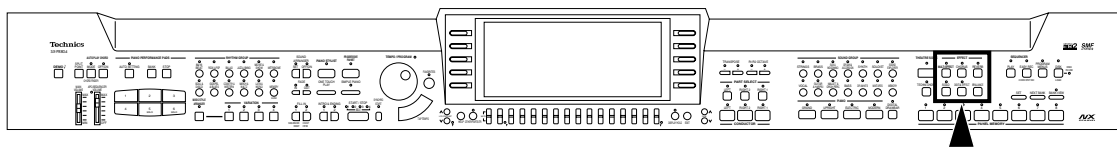

You can achieve even fuller and stirring sounds by adding various effects for each part.

- To enable the best effects for each sound, the **DIGITAL EFFECT** may switch on or off automatically depending on the **MULTI EFFECT** setting.

MULTI EFFECT

The **MULTI EFFECT** works like a studio effects processor, providing effects such as CHORUS, PHASER, DELAY and DISTORTION. This effect can be set for each part.

1. In the **CONDUCTOR** or **PART SELECT** section, turn on the part to which this effect will be applied.

2. Press the **MULTI EFFECT** button to turn it on.



■ Type and parameter settings

1. Press and hold the **MULTI EFFECT** button for a few seconds.

- The display changes to the following.



- Use the ▲ and ▼ buttons to select an effect group.
 - The EFFECT MEMORY is for edited effects (see below).
- Use the buttons to the right of the display to select the type.
 - If the types comprise more than one display “page,” use the PAGE buttons to switch pages.
 - If you press the VARI button to turn it ON, the effect variation is selected.
 - This display can also be accessed from the REVERB & EFFECT MENU display. (Refer to page 109.)

■ EFFECT EDIT

The effects can be edited and then stored in a memory.

- Select an effect type to use as a base.
 - The display changes to the following.

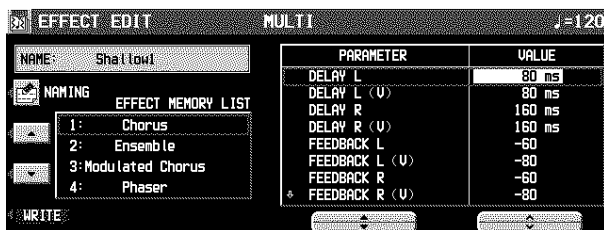

- Use the PARAMETER ▲ and ▼ buttons to select the parameter.
 - The parameters vary depending on the effect type selected as the base.
 - (V) indicates a parameter for the VARIATION.
- Use the VALUE ^ and v buttons to adjust the setting.
- Press the EFFECT NAMING button and assign a name to the effect, if necessary.
 - Refer to page 55 for details about the NAMING procedure.
- Use the EFFECT MEMORY LIST ▲ and ▼ buttons to specify the location in which to store the edited effect.
- Press the WRITE button.

DIGITAL EFFECT

DIGITAL EFFECT gives the sound richness and enhances your performance. This effect can be set for each part.

- Select the sound to which the effect will be applied.
- Press the **DIGITAL EFFECT** button to turn it on.



- The on or off status of the **DIGITAL EFFECT** is preset for each sound.
- This effect may not work for some sounds.
- If a **DRAWBAR** sound is not selected for a performance part, and if the **MULTI EFFECT** is off for all parts, the nuance of this effect in the **RIGHT 1** part and other parts will differ.

CHORUS

Add breadth to the sound. This effect can be set for each part.

- Select the sound to which the effect will be applied.
- Press the **CHORUS** button to turn it on.



- The on or off status of the **CHORUS** is preset for each sound.

■ Type and parameter settings

- Press and hold the **CHORUS** button for a few seconds.
 - The display looks similar to the following.

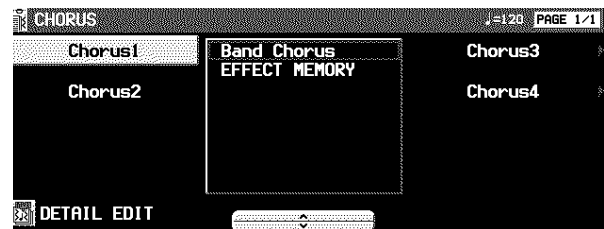

- Use the ▲ and ▼ buttons to select an effect group.
 - The EFFECT MEMORY is for edited effects (see below).
- Use the buttons to the right of the display to select the type.
 - If the types comprise more than one display “page,” use the PAGE buttons to switch pages.
 - This display can also be accessed from the REVERB & EFFECT display. (Refer to page 109.)

■ EFFECT EDIT

Your edited effect can be stored in a memory for later recall.

- The procedure is the same as for **MULTI EFFECT**.

REVERB

REVERB applies a reverberation effect to the sound. This effect is applied to all the parts in common.

⇒ Press the **REVERB** button to turn it on.



- This effect does not work for the **METRONOME**.

■ Type and parameter settings

1. Press and hold the **REVERB** button for a few seconds.

- The display changes to the following.

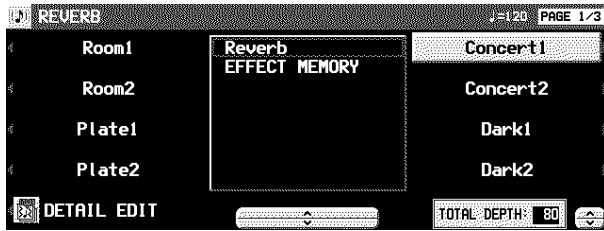

2. Use the **▲** and **▼** buttons to select an effect group.

- The EFFECT MEMORY is for edited effects (see below).

3. Use the buttons to the right of the display to select the type.

- If the types comprise more than one display “page,” use the **PAGE** buttons to switch pages.

4. Use the **TOTAL DEPTH** **^** and **v** buttons to set the depth of the effect.

- This display can also be accessed from the REVERB & EFFECT display. (Refer to page 109.)

■ EFFECT EDIT

Your edited effect can be stored in a memory for later recall.

- The procedure is the same as for **MULTI EFFECT**.

SOLO

Each part can be set to monophonic sound.

1. Select a part.

2. Press the **SOLO** button to turn it on.



- The sound of that part will be monophonic.
- This feature does not work for the **DRUM KITS** sounds.
- When two **CONDUCTOR** parts, one with the **SOLO** turned on and one with the **SOLO** turned off, are mixed, then only the highest pitch of the played chord plays in the sound for which the **SOLO** is turned on.
- In the initialized condition, the **SOLO** is automatically turned on or off depending on the sound you select.

BRILLIANCE

The brightness of the sound can be set for each performance part.

1. Press the **BRILLIANCE** button.



- The display looks similar to the following.



2. Use the **PART** **^** and **v** buttons to select a part.

3. Use the buttons to the left of the display to select the level of brightness.

- For some sounds, the brightness does not change.
- The display returns to the previous display a few seconds after you have changed the setting.

Mic Reverb & Effect

These settings apply when a microphone is connected to the **MIC** input terminal and, for example, you wish to add a reverb effect to the microphone input.

1. Press the **PROGRAM MENUS** button to turn it on.



- The display looks similar to the following.



2. Select **REVERB & EFFECT**.

3. Select **MIC REVERB & EFFECT**.

- The display looks similar to the following.



(continued on the next page)

4. Use the buttons to the left of the display to select an item you wish to set (MIC REVERB SETTING/MIC EFFECT SETTING).

5. Use the PARAMETER ▲ and ▼ buttons to select the function, and use the VALUE ^ and v buttons to change the setting.

MIC REVERB (separate reverb for mic input)
TYPE:

Type of reverb (ROOM/KARAOKE/STAGE/CAVE)

REVERB TIME:
The time it takes for the reverb sound to die out

VOLUME:
Reverb volume

MIC EFFECT
(separate effect for microphone input)
TYPE: Effect type setting

CHORUS:
The effect of several people singing.

FLANGER:
A unique tone applied to the voice gives it a rap music flavor.

PHASER:
A different tone from FLANGER.

DELAY 1:

Alpine echo.

DELAY 2:

An echo with broadened left and right voices.

EXCITER:

The voice is modulated for dramatic effect.

TALKING CAT:

A loud or soft voice produces the sound of a cat meowing.

RING MODULATOR:

Space alien voice.

PITCH SHIFTER 1:

The effect of a two-voice chorus.

PITCH SHIFTER 2:

The voice repeats while changing pitch.

VOICE CHANGER 1:

Shrill female voice.

VOICE CHANGER 2:

Supernatural male voice.

- The parameters differ depending on the TYPE.

6. Use the MIC REV and MIC EFF buttons to the right of the display to set the corresponding effect to ON or OFF.

- For connecting a microphone, refer to page 136.
- Use the **MIC VOLUME** dial to adjust the microphone volume.

Transpose

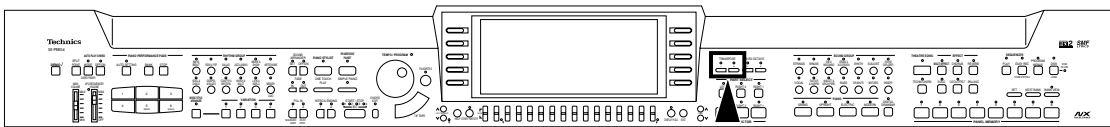

The **TRANPOSE** buttons are used to change the key of the entire instrument in semi-tone steps across an entire octave. Suppose you learn to play a song—in the key of C, for example—and decide you want to sing it, only to find that it's either too high or too low for your voice. Your choice is to either learn the song all over again in a different key, or to use the **TRANPOSE** feature.

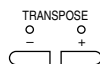

⇒ Adjust the key with the + and – buttons.

- The key is changed in half-tone increments up to plus or minus one octave.
- If the two buttons are pressed at the same time, the key returns to C.
- When the **TRANPOSE** function is active, the transposed key is shown on the display, and the + or – indicator is lit.



Actual key

<<Example: transposed to D>>

Played keys



C major



Notes that sound



D major

Techni-chord

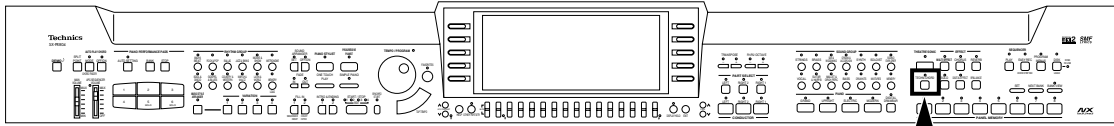

TECHNI-CHORD turns your single note melodies into full chords and offers you a choice of different types from a simple duet which adds one harmony note to your melody note, to big band reeds which adds four harmony notes to your melody note. If **TECHNI-CHORD** is part of a **ONE TOUCH PLAY** or **PIANO STYLIST** registration, a suitable **TECHNI-CHORD** type will be selected automatically.

Example:

Left hand (chord)

Right hand (melody)



1. Split the keyboard into left and right sections.
2. Press the **TECHNI-CHORD** button to turn it on.



3. Play the keyboard.

- The melody you play with your right hand is automatically played in chords which are based on the chords you play with your left hand.
- This feature does not work for a part for which **SOLO** is set to on.
- This feature is very effective when used with the **AUTO PLAY CHORD**.

ORCHESTRATOR

You can specify which part is used for the harmony tones. Your **TECHNI-CHORD** performance is enhanced by selecting harmony sounds different from the sounds you play and the sounds produced by the automatic accompaniment.

⇒ Use the \wedge and \vee buttons to select the part for the harmony notes.

- If **CONDUCTOR** is selected, the harmony notes are produced in the sounds of the part which is currently selected in the **CONDUCTOR (RIGHT 1, RIGHT 2)**. In other words, the harmony notes are produced in the same sound as the melody notes. If both **RIGHT 1** and **RIGHT 2** are on, the harmony notes are produced in the sound of the **RIGHT 1** part.
- In the case of **EASY RECORD** (see page 65), when set to **CONDUCTOR** or a part other than **PART 4**, the **TECHNI-CHORD** sound is not recorded; so when you use **EASY RECORD**, please set to one or the other.

Type setting

1. Press and hold the **TECHNI-CHORD** button for a few seconds.
- The display looks similar to the following.

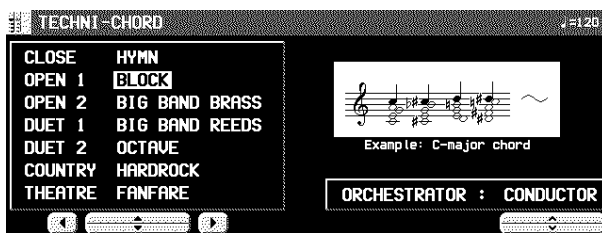

2. Use the \blacktriangleleft , \blacktriangle , \blacktriangledown , \blacktriangleright buttons to select the harmony style.
- When the **OCTAVE**, **HARD ROCK** or **FANFARE** style is selected, the **TECHNI-CHORD** functions even when the keyboard is not split.

Part II Playing the rhythm

Overview of rhythm performance

An explanation follows of the terms related to this instrument's rhythm performance.

Rhythm and accompaniment pattern

Each rhythm is comprised of not only a **DRUMS** pattern, but also of accompaniment patterns called **BASS** and **AC-COMP**. The combination of all of these is the rhythm.

- The accompaniment pattern sounds when you perform using the **AUTO PLAY CHORD (APC)**. (Refer to page 47.)

Rhythm and Style

One rhythm of this instrument is comprised of four **VARIATION** patterns, and for each one the optimum sounds and effects are set.

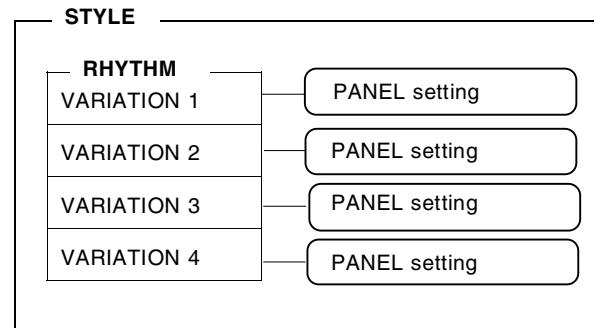

Selecting rhythms

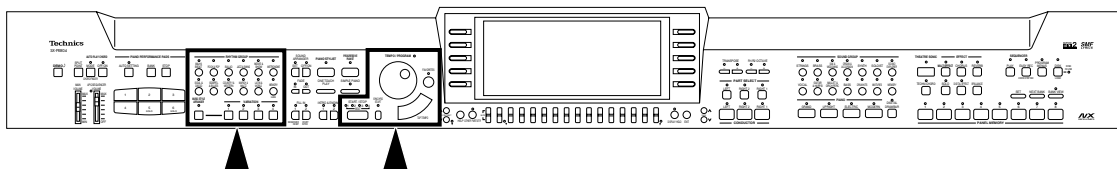

Many exciting rhythms are stored in the memory of this instrument. First select one of the rhythm groups and then choose the desired rhythm.

Select a rhythm

1. In the **RHYTHM GROUP** section, select a rhythm group.

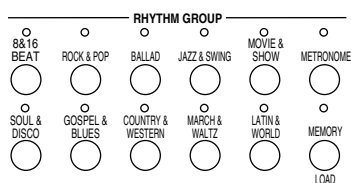

- For information about the **METRONOME**, see the following section.
- **MEMORY** is the group in which you store the rhythms you create with the **COMPOSER**. (Refer to page 85.)

2. Select the desired rhythm from the list on the display.



- A list of rhythms available for each rhythm group can be found in the separate **REFERENCE GUIDE** provided.
- If there is more than one page to the display, use the **PAGE** buttons to move from one screen page to another.
- Because the "Classic Ballad" rhythm of the **BALLAD** group does not have a drum part, no sound is produced if you play this rhythm without the **AUTO PLAY CHORD**.

■ VARIATION

There are four variations available for each rhythm. Use the **VARIATION** buttons to select the desired variation.

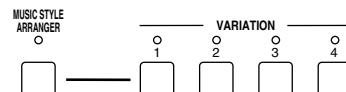

- Confirm that the **MUSIC STYLE ARRANGER** button is off. (If it is on, press it once to turn it off.)
- The nuance of the pattern differs with each variation number.
- You can change to a different variation while the rhythm is playing.

METRONOME

1. In the **RHYTHM GROUP** section, select **METRONOME**.

- The following display appears.

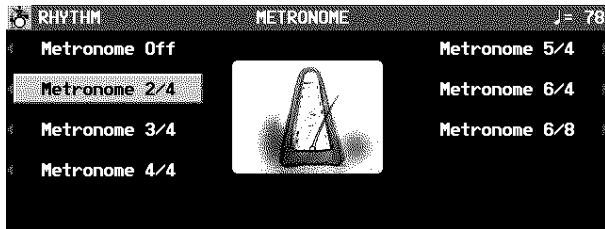

2. Select the time signature for the metronome.

- Select "Metronome Off" if you do not wish the first beat of the measure to be accented.
- Press the **START/STOP** button to start the metronome.

Start the rhythm

There are two ways to start the rhythm.

Normal start

- Select a rhythm.
- Press the **START/STOP** button to turn it on.

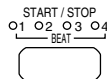

- The selected rhythm pattern immediately begins to play.
- You can stop the rhythm by pressing the **START/STOP** button again to turn it off.
- The **BEAT** indicators above the **START/STOP** button light to indicate the beat. On the first beat of the measure, the red indicator lights. On the second and succeeding beats of the measure, the green indicators light in order.

Synchronized start

With the synchronized start feature, the rhythm pattern starts when you play a key on the keyboard.

- Select a rhythm.
- Press the **SYNCHRO START** button to turn it on.



3. Play a key to the left of the keyboard split point.

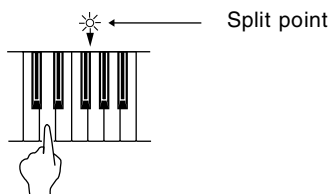

- The rhythm pattern begins to play.
- You can use the synchronized start feature even when the keyboard is not divided into left and right sections. To start the rhythm, press a key to the left of the specified split point.

Adjust the tempo

The tempo of the rhythm pattern is adjusted with the **TEMPO/PROGRAM** dial.

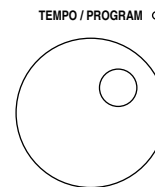

- The tempo is shown on the display as a numerical value (♩ = 40 to 300).
- When the **TEMPO/PROGRAM** indicator is lit, the **TEMPO/PROGRAM** dial cannot be used to adjust the tempo.
- To adjust the tempo during playback, refer to page 68.

TAP TEMPO

You can set the tempo of the rhythm by tapping this button few times with your finger at the tempo you wish to play.

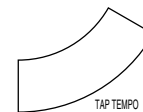

- The tempo at which the button is tapped is detected, and the tempo automatically changes correspondingly.

Playing the rhythm

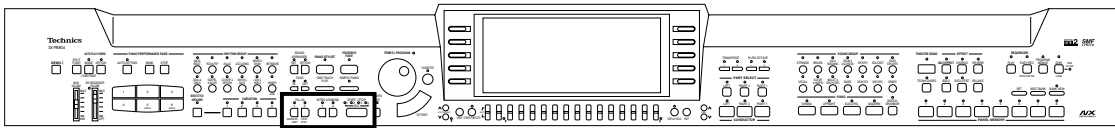

Intro, fill-in and ending patterns fitting each different rhythm pattern are permanently recorded in your instrument, thus allowing a versatile rhythm performance.

- These patterns are not available for the **METRONOME**.

INTRO

Begin the rhythm performance with an intro pattern.

1. Press the **INTRO & ENDING 1** or **INTRO & ENDING 2** button to turn it on.



2. Press the **START/STOP** button to start the rhythm.

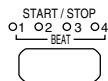

- An intro pattern is played, after which the normal rhythm pattern begins.

COUNT INTRO

You can begin the rhythm performance with a spoken one-measure count.

1. Press the **COUNT INTRO (FILL IN 2)** button to turn it on.

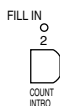

2. Press the **START/STOP** button to start the rhythm.

- A spoken one-measure count is played, after which the normal rhythm pattern begins.

■ Mode setting

You can select the mode for the count sound.

1. Press the **MODE** button in the **AUTO PLAY CHORD** section to turn it on.

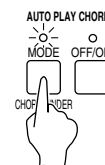

- The display looks similar to the following.



2. Use the **COUNT INTRO** button to select a mode.

- VOICE: A spoken count (initialized setting).
- CLICK: A clicking sound for the count.

FILL IN

You can insert a fill-in pattern any time during the rhythm performance. Choose from two different fill-in patterns.

1. Select a rhythm and press the **START/STOP** button.
2. Press the **FILL IN 1** or **FILL IN 2** button.

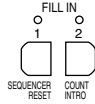

- A fill-in pattern is heard immediately for the remainder of the measure.
- When a **FILL IN** button is pressed on the last beat of the measure, the fill-in pattern continues to the end of the following measure.

ENDING

Finish the rhythm performance with an ending pattern.

1. Select a rhythm and press the **START/STOP** button.
2. Press the **INTRO & ENDING 1** or **INTRO & ENDING 2** button to turn it on.

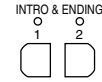

- An ending pattern is produced, and then the rhythm performance stops.
- If you accidentally press the **INTRO & ENDING** button in the middle of the tune, you can press the **FILL IN 1** or **FILL IN 2** button. The ending pattern stops, and a fill-in pattern is produced, after which the normal rhythm performance continues.

Auto Play Chord

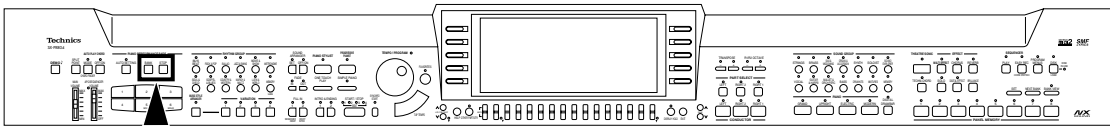

Simply by playing a chord on the keyboard, the **AUTO PLAY CHORD** function automatically plays an accompaniment pattern which matches perfectly the selected rhythm. With a real accompaniment as a background, you can concentrate on playing the melody.

How the AUTO PLAY CHORD works

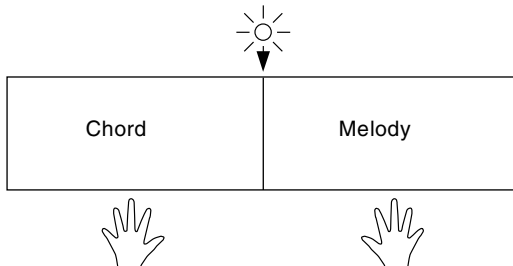

When an **AUTO PLAY CHORD** mode is selected, an automatic accompaniment which matches the rhythm you have chosen is played in the chord which you specify with your left hand. The melody is played with your right hand.

- The accompaniment pattern of the **AUTO PLAY CHORD** is composed of 8 parts: **DRUMS 1, 2, BASS, ACCOMP 1-5**.
- The volume of each part can be adjusted with the buttons below the display. (Refer to page 31.)

How to play chords

There are four different ways to specify chords on the keyboard.

■ BASIC mode

For beginning players, a left-hand chord can be specified with just one finger. You can either press one key on the left keyboard section to specify the root note (one-finger), or play all the notes of the chord (fingered).

- The **LEFT** button in the **CONDUCTOR** turns off. You can turn it on and the **LEFT** part will be heard, but when the **LEFT HOLD** function is OFF, only the <Fingered> method can be used to specify chords. (Refer to page 49.)
- When the rhythm is on, even if the keys are released, the accompaniment continues to play in the specified chord until you specify another chord.

<One-finger>

Press a key in the left keyboard section to specify the root note. The major chord corresponding to this root note is automatically played in an accompaniment pattern.

- When three or more keys of a chord are pressed, it is recognized as a <fingered> chord.

Example: C chord

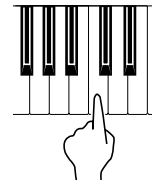

Minor, seventh and minor seventh chords are also easily produced.

minor chord	seventh chord	minor seventh chord
Play the root note plus a black key to the left of it.	Play the root note plus a white key to the left of it.	Play the root note plus a black key and a white key to the left of it.
Example: Cm 	Example: C7 	Example: Cm7

<Fingered>

Specify the chord by playing all the notes in the chord. When you play chords this way, the **AUTO PLAY CHORD** recognizes more chord types, and thus the scope of your performance expression is expanded.



- Play chords by pressing at least three keys.
- If the **CHORD FINDER** procedure is used, you can see the types of chords that can be specified and the keys you press to play them. (Refer to page 50.)

■ **ADVANCED 1 mode**

In this mode, the chord is specified by playing it (fingered) on the left part of the keyboard. Chords which the **AUTO PLAY CHORD** does not recognize are ignored.

- The keyboard automatically divides into left and right playing sections.
- The sound selected for the left section of the keyboard is produced, but you can mute this part. (Refer to page 31.)
- Play chords by pressing at least three keys.
- If the **CHORD FINDER** procedure is used, you can see the types of chords that can be specified and the keys you press to play them. (Refer to page 50.)
- When the rhythm is on, even if the keys are released, the accompaniment continues to play in the specified chord until you specify another chord.

■ **ADVANCED 2 mode**

Chords are specified in the same manner as for <Fingered> chords in the **BASIC** mode. However, if the **AUTO PLAY CHORD** does not recognize the chord, the automatic accompaniment is based on the pitches of some of the pressed keys.

■ **PIANIST mode**

In the **PIANIST** mode, the entire keyboard can be used to specify chords for the automatic accompaniment. This mode is used to add an automatic accompaniment to the performance on a standard piano.

- The keyboard does not split.
- Chords can be specified (fingered) anywhere on the keyboard.
- Chords are specified in the same manner as for the **ADVANCED 1** mode, and the types of chords are also the same.

<APC HOLD>

During a performance in the **PIANIST** mode, for example, if you press the pedal to which the **APC HOLD** function is assigned, the currently specified chord is maintained, allowing you to focus your performance on a solo melody.

- The accompaniment continues in the same chord as long as the pedal is depressed, and it does not change even if other chords are played.
- To change the pedal assignment, refer to page 121.

How to use the AUTO PLAY CHORD

- Select the desired rhythm and sound(s), and set the tempo.
 - Do not select **METRONOME**.
- Press the **AUTO PLAY CHORD's OFF/ON** button to turn it on.

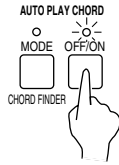

- Press the **AUTO PLAY CHORD's MODE** button to turn it on.
 - The display looks similar to the following.

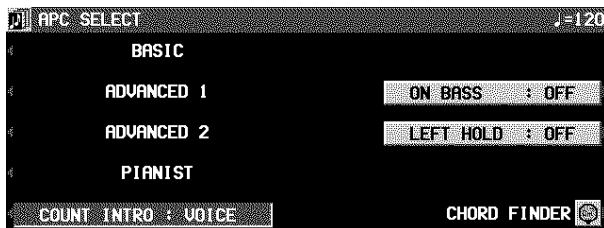

- Select an **AUTO PLAY CHORD** mode.
 - After a few seconds, the display returns to the previous display.
 - If the **BASIC** or an **ADVANCED** mode was selected, the keyboard automatically splits into right and left sections.

■ ON BASS

If the **ON BASS** button is **ON**, the **BASS** part is produced in the key of the lowest note of the played chord, thus making it possible to play chords such as C on G (excluding <one-finger> chords).

- For example, with the **ON BASS** button on, if you play a C chord by pressing the keys G, C and E, the **BASS** part is produced in the key of G.

- Press the **START/STOP** button to begin the rhythm.
 - You can start the rhythm by playing a key on the keyboard. (Refer to page 45.)

LEFT HOLD

This setting determines how the **LEFT** part sounds when the **LEFT** button in the **CONDUCTOR** is on during a performance with the **BASIC** or **ADVANCED 1, 2** mode.

- Press the **AUTO PLAY CHORD's MODE** button to turn it on.
 - The display changes to the following.



- Use the **LEFT HOLD: ON/OFF** button to set the mode to on or off.

- Specify a chord.
 - If the **BASIC** or **ADVANCED** mode was selected, specify the chord on the keyboard section to the left of the split point.

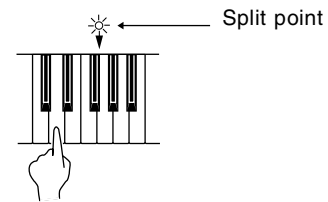

- An accompaniment pattern in the specified chord is automatically played. Play the melody with your right hand.

Example of how to play a **BASIC <One-Finger>** accompaniment

Play the melody with your right hand.

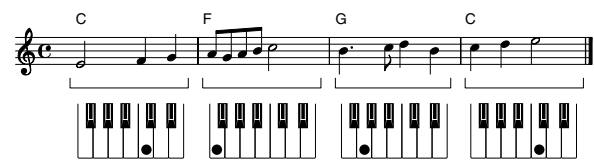

Left hand

- When you use **FILL IN**, **INTRO** and **ENDING**, the automatic accompaniment is also used in these patterns.
- You can set the mode which determines how the **LEFT** part sounds during an **AUTO PLAY CHORD** performance. (Refer to the following section on "LEFT HOLD".)
- In the initialized condition, when the rhythm is off, if an **AUTO PLAY CHORD** mode is on and a chord is specified, the specified root note (R. **BASS** part) and chord notes (**CHORD** part) are produced. The volumes of these notes can be adjusted. (Refer to page 31.)

- To stop the automatic accompaniment, press the **START/STOP** button.
 - If you wish the automatic accompaniment to begin and end the performance, set the **OFF/ON** button to off.

OFF:

The **LEFT** part sounds from the pressed chord keys.

- When **BASIC** is selected, the **LEFT** part turns off. The **LEFT** part sounds if you turn it on, but <one-finger> chords cannot be specified.

ON:

Specifying <one-finger> chords in the **BASIC** mode produces the full chords; otherwise the **LEFT** part notes are those of the pressed chord keys.

- When **BASIC** is selected the **LEFT** part turns off, but it will sound if you turn it on.
- Touch response does not function for the **LEFT** part.
- When the mode is set to **ON**, during a rhythm performance, the **LEFT** part continues to play even when the keys are released.

APC VOLUME

To adjust the volume balance between the automatic accompaniment and the parts you play manually on the keyboard, the volume of all the automatic accompaniment parts can be lowered as one.

⇒ Use the **APC/SEQUENCER VOLUME** slide control to adjust the volume.



- Use this control to lower the automatic accompaniment volume when it is too loud relative to your manual performance.
- At the **MAX** position, the volumes of the automatic accompaniment parts correspond to their current settings; at the **OFF** position, the volume is 0. The volume should normally be set to **MAX**.
- The set values are shown in the APC column of the volume balance display. (Refer to page 31.)
- The volume can be adjusted for each part. (Refer to page 31.)
- When the position of the slide control coincides with the actual volume, the indicator is lit. When the volume is changed by of the **PANEL MEMORY** or **SEQUENCER** playback, the actual volume differs from that indicated by the position of the slide control. In this case, the indicator is not lit.
- The volume of the **PIANO PERFORMANCE PADS** part does not change. (**PR804**)
- During **SEQUENCER** playback or disk **DIRECT PLAY**, operation of this slide control affects the total volume of all the playback parts.

CHORD FINDER

The **CHORD FINDER** can help, for example, when you do not know which keys to press to specify a given chord. When you input the chord name, the **CHORD FINDER** shows you which keys to press and even lets you hear the notes that make up.

1. Press the **AUTO PLAY CHORD's MODE** button to turn it on.

- The display changes to the following.

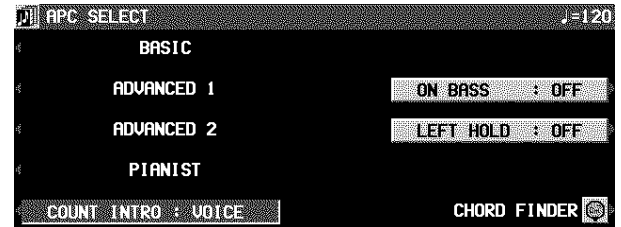

2. Select **CHORD FINDER**.

- The display changes to the following.

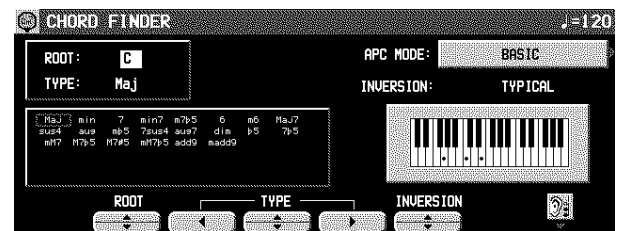

3. Use the **APC MODE** button to select the automatic accompaniment mode you will use to specify chords (**BASIC**, **ADVANCED1**).

- When storing chords with the **SEQUENCER**, this button is not shown (**MODE** is fixed at **BASIC**).
- In the list column are shown the chords which can be specified in each mode.

4. Use the **ROOT** buttons to select the root note of the chord. Use the **TYPE** buttons to select the type of chord.

- A typical way to finger the specified chord (**TYPICAL**) is illustrated on a keyboard diagram.
- Each time the **INV.** button is pressed, different **INVERSION** fingerings are illustrated in order. (If there is no **INVERSION** fingering for the specified chord, this button is not shown on the display.)
- When the button with a picture of an ear is pressed, the notes of the illustrated chord sound.

5. To exit the **CHORD FINDER** procedure, press the **EXIT** button.



- You can also access this display by pressing and holding the **CHORD FINDER (MODE)** button for a few seconds.

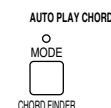

Fade In/Fade Out

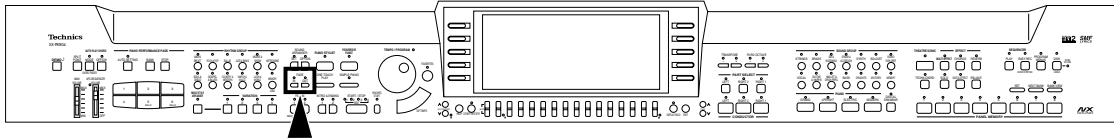

Add interest to your performance by starting a part with a fade-in or ending it with a fade-out.

FADE IN

At the beginning of the song, the volume of each part rises slowly.

1. Set up the panel settings for your performance.
2. Turn on the **FADE IN** button.

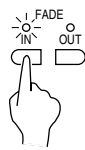

- The indicator flashes. In this condition, the volumes for all parts change to 0 and no sound is produced from this instrument until the **FADE IN** is turned off or until step 3 is executed.
3. Play the keyboard or press the **START/STOP** button.
 - The volume slowly builds to its preset level.
 - For the fade-in effect for a rhythm part or when playing back a **SEQUENCER** performance, turn on the **FADE IN** button before pressing the **START/STOP** button.
 - At the end of the fade-in, the **FADE IN** indicator goes out.
 - During the fade-in, the **IN** indicator is lit, and FADE IN is shown on the normal display.

FADE OUT

At the end of the song, the volume of each part gradually fades to nothing.

1. Start the performance.
2. Turn on the **FADE OUT** button at the point you want the fade-out to start.

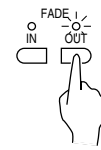

- The volumes of all the parts slowly fade to 0.
- The indicator flashes to show that fade-out is completed, and then goes out. The volumes for all parts return to their specified settings.
- If you wish to interrupt the fade-out, press the **FADE OUT** button to turn it off.

The volume balance buttons do not work while the FADE IN or FADE OUT indication is shown on the display.

FADE SETTING

Adjust the settings for the FADE IN and FADE OUT.

1. Press and hold the **FADE IN** or **FADE OUT** button for a few seconds.



- The display looks similar to the following.

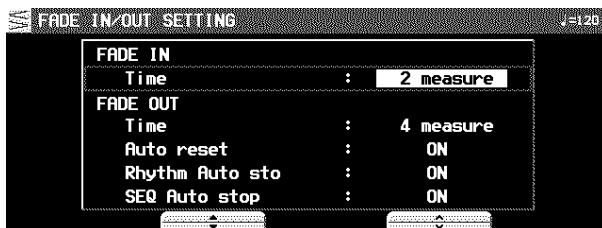

2. Use the **▲** and **▼** buttons to select the item. Use the **∧** and **∨** buttons to change the setting.

FADE IN

TIME:

Specify the time elapsed between 0 volume to the set volume (1 measure to 16 measure).

FADE OUT

TIME:

Specify the time elapsed between the set volume and 0 volume (1 measure to 16 measure).

AUTO RESET:

Specify whether the volume of each part automatically returns to its specified setting (ON, OFF).

RHYTHM AUTO STOP:

Specify whether the rhythm turns off after fade-out is completed (ON, OFF).

SEQ AUTO STOP:

Specify whether the **SEQUENCER** playback automatically stops after fade-out is completed (ON, OFF).

- The display returns to the previous display a few seconds after you have changed the settings.
- You can also access this display from the CONTROL MENU display. (Refer to page 120.)

Sound Arranger

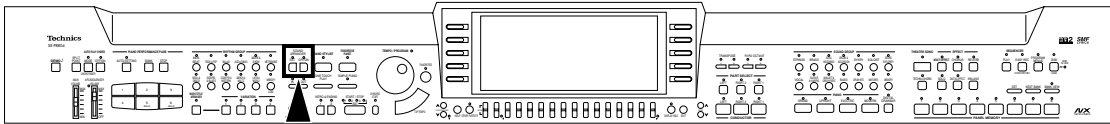

The **SOUND ARRANGER** feature lets you select other sounds for the **AUTO PLAY CHORD** parts of each rhythm.

1. Select the rhythm whose sound you wish to change.
 - Do not select the **METRONOME** or the **MEMORY** button.
2. In the **SOUND ARRANGER** section, press the **SET** button to turn it on.
5. Repeat steps 3 and 4 for the other parts as desired.
6. When you have finished selecting the sounds, press the **SET** button.



- The display looks similar to the following.

PART	SOUND	DIGITAL EFF
DRUMS1	Pop Kit Tc	---
DRUMS2	Standard Kit1	---
BASS	Funky E. Bass	OFF
ACCOMP1	Funk Mute Guitar	OFF
ACCOMP2	Mute Guitar	OFF
ACCOMP3	Bright Piano	OFF
ACCOMP4	Analog Syn. Brass	OFF
ACCOMP5	SymphonicStrings	OFF

3. Use the **▲** and **▼** buttons to select the part whose sound you wish to change.
4. Select the desired sound.
 - The **DIGITAL EFFECT** on/off status can also be specified (except for **DRUMS** part).
 - For the **DRUMS** part, select sounds from the **DRUM KITS** group.
 - Sounds from the **DIGITAL DRAWBAR** groups cannot be selected for the **ACCOMP** and **BASS** parts.
 - The sound and on/off status of the **DIGITAL EFFECT** are shown on the display.

Playing back the sounds

1. In the **SOUND ARRANGER** section, press the **OFF/OFF** button to turn it on.

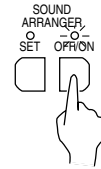

2. Start the rhythm (automatic accompaniment).
 - When the **OFF/OFF** button is off, the factory-preset sounds are produced.
 - This setting can be set separately for each rhythm.
 - If you wish to modify the settings you specified, while the **OFF/OFF** button is on, press the **SET** button to turn it on.

One Touch Play

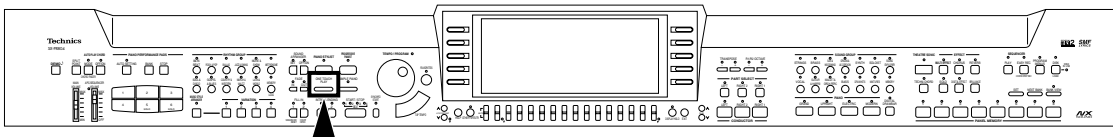

ONE TOUCH PLAY automatically sets a suggested combination of sounds and an appropriate tempo for your chosen rhythm style.

1. Select a rhythm pattern.
 - Do not select the **METRONOME** or the **MEMORY** button.
2. Press and hold the **ONE TOUCH PLAY** button for a few seconds.
 - During setting, the style name is shown on the display.
3. Play the keyboard.
 - The **AUTO PLAY CHORD** and the **SYNCHRO START** are automatically turned on, and the sounds and effects, volume balances, tempo etc. that are ideal for your selected rhythm are automatically set.
 - When you specify a chord, the automatic rhythm begins to play immediately.



Piano Stylist

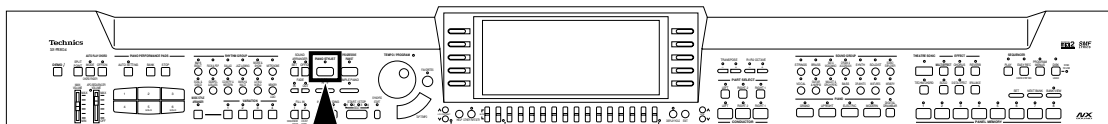

This feature automatically launches the appropriate instrument settings when you select the style of the arrangement you wish to play in. By using this feature, you can easily achieve a performance like that of a first-rate pianist.

PIANO STYLES

Select a suitable style for your performance based principally on the piano sound.

1. Press the **PIANO STYLIST** button to turn it on.



- The display looks similar to the following.

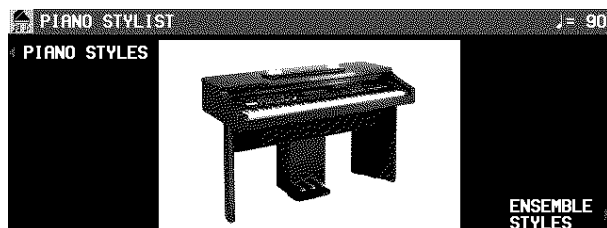

2. Press the **PIANO STYLES** button.

- The display looks similar to the following.



3. Use the **ARRANGE MODE** button to select the desired type of arrangement.

- Select the type you wish to play (PIANO SOLO/PIANO & COMBO/PIANO & ENSEMBLE).

4. Use the **SELECT MODE** button to specify how you wish to select a style.

GENRE: Select a style by musical genre.

ERA: Select a style by era.

ALPHABET: Select a style from an alphabetical list.

5. Use the **GENRE/ERA/ALPHABET** button below the display to select a group. Use the **STYLE** button to select a style.

- In the above example, GENRE was selected.
- If the list covers more than one screen "page," the MORE button is shown on the display. Use the MORE button to switch between screen pages.

- The **AUTO PLAY CHORD** and **SYNCHRO START** turn on, and the sounds, effects, rhythm, tempo, volume balance, etc. which are best suited for the selected music style are automatically selected.

6. Play the keyboard.

- When you specify a chord on the left area of the keyboard, the automatic accompaniment begins to play.
- You can use the **TEMPO/PROGRAM** dial to adjust the tempo.

7. When you are finished selecting the style, turn the **PIANO STYLIST** button off.

ENSEMBLE STYLES

Select a style suitable for an ensemble performance that uses the many sounds and rhythms incorporated in this instrument.

1. On the PIANO STYLIST display, press the **ENSEMBLE STYLES** button.

- The display looks similar to the following.



2. Use the **GROUP** button to select a style group.

- These are the same as the groups for the RHYTHM GROUP button.

3. Use the **RHYTHM** button to select a rhythm, and the **STYLE** button to select a style.

- The **AUTO PLAY CHORD** and **SYNCHRO START** turn on, and the sounds, effects, rhythm, tempo, volume balance etc. which are best suited for the selected music style are automatically selected.

4. Play the keyboard.

- When you specify a chord on the left area of the keyboard, the automatic accompaniment immediately begins to play.
- You can use the **TEMPO/PROGRAM** dial to adjust the tempo.

5. When you are finished selecting the style, turn the **PIANO STYLIST** button off.

Music Style Arranger

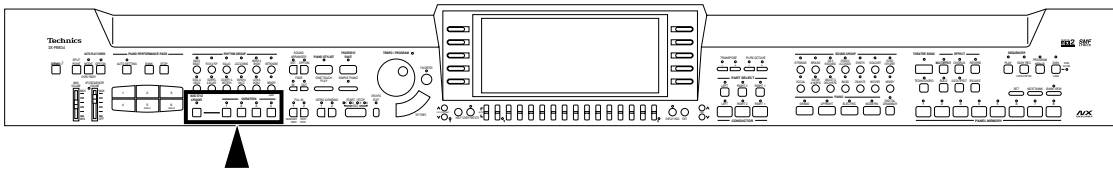

The **MUSIC STYLE ARRANGER** helps you to make professional registration changes during your performance. Select between four contrasting registrations at the push of a button, or let your instrument change the registration automatically for you when you use **FILL IN 1** or **2**. The **MUSIC STYLE ARRANGER** will also alter the accompaniment in character with the registration change creating a polished sounding arrangement.

How to use the MUSIC STYLE ARRANGER

1. Select a rhythm pattern.
 - Do not select the **METRONOME** or the **MEMORY** button.
2. Press the **MUSIC STYLE ARRANGER** button to turn it on.



3. Use the **VARIATION** buttons to select a style (1 to 4).

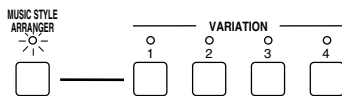

- The nuance of the pattern differs with each number.
- The panel settings (including the tempo) change according to the selected rhythm and music style. The **AUTO PLAY CHORD** and the **SYNCHRO START** button are automatically turned on. When a key on the left section of the keyboard is pressed, the automatic rhythm begins to play immediately.
- During your performance, the style can be changed, but the tempo does not change.

■ MUSIC STYLE ARRANGER mode

You can define which panel settings change by pressing a **FILL IN** button when the **MUSIC STYLE ARRANGER** is used.

1. Press and hold the **MUSIC STYLE ARRANGER** button for a few seconds.
 - The display changes to the following.

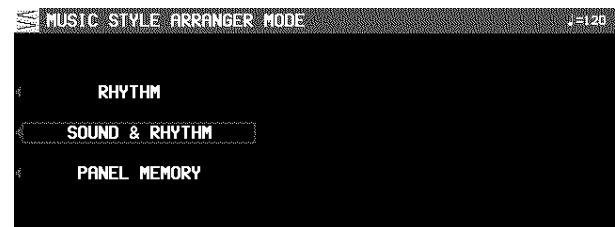

2. Select the mode.

RHYTHM: Only the rhythm changes.

SOUND & RHYTHM: The sound, effects, rhythms, etc. change.

PANEL MEMORY: The **PANEL MEMORY** number (**BANK A: 1 to 4**) changes. You can store your desired panel settings in the **PANEL MEMORY** beforehand and switch from one to another quickly.

- After a few seconds, the display exits the setting mode.
- You can also access this setting display from the **CONTROL MENU** display. (Refer to page 120.)

How to change the music style during your performance

⇒ While you are playing the keyboard with the **MUSIC STYLE ARRANGER** on, press the **FILL IN 1** or **FILL IN 2** button.

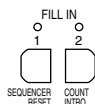

- Each time the **FILL IN 1** button is pressed, the **FILL IN 1** pattern plays, and then the music style changes in the **4 → 3 → 2 → 1** order. And each time the **FILL IN 2** button is pressed, the **FILL IN 2** pattern plays, and then the style changes in the **1 → 2 → 3 → 4** order.

Panel Memory

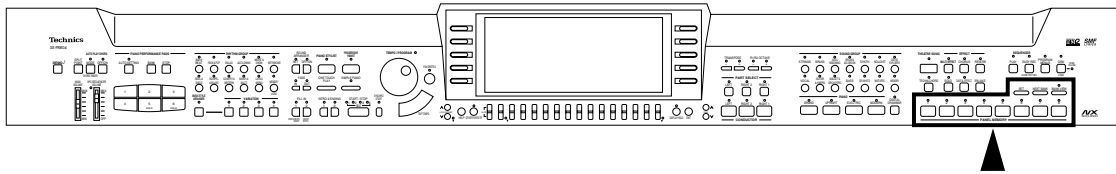

PANEL MEMORY stores all the current panel settings so you can recall them at the push of a button.

How to store the panel settings

Store up to 24 panel settings (3 banks x 8 memories). By storing all the panel settings you use for a song in the same bank, for example, you can switch from one panel setup to the next in a flash.

1. Set up the desired panel settings (sounds, volumes, etc.)
2. Press the **BANK VIEW** button to turn it on.

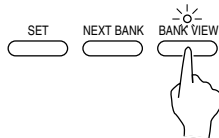

- The BANK SELECT display appears.

3. Use the buttons to the left of the display to select the desired bank (A, B, C).
4. With the **SET** button held down, press one of the numbered buttons of the **PANEL MEMORY** (1 to 8).

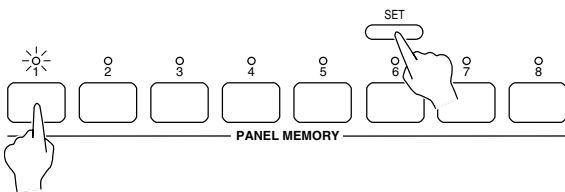

- The panel settings are now stored in the specified bank and number.

■ BANK VIEW

After selecting a bank, you can use the **PAGE** buttons to go to the PAGE2 BANK VIEW page and confirm the memory names of that bank's 8 memories.



- You can use the BANK ^ and v buttons to view other banks.
- You can also access this display by pressing and holding any of the **PANEL MEMORY** number buttons (1 to 8) for a few seconds.

Assign a name to the bank/memory

You can assign names to the banks and memories.

1. Select a bank or memory.
2. Use the **PAGE** buttons to go to the PAGE2/2 BANK VIEW page on the display.
3. Press the BANK NAMING button to assign a name to the bank, or the MEMORY NAMING button for the memory.
 - The display looks similar to the following.



4. Assign a name.
 - Press the ABC button to enter alphabetical characters. While the SHIFT button is pressed, upper case letters are entered.
 - Press the 123 button to enter numbers, etc. While the SHIFT button is pressed, you can enter symbols.
 - Press the POSITION button to move the cursor.
 - You can also use the **TEMPO/PROGRAM** dial to select the characters.
 - Press the INS button to enter a space at the cursor position.
 - Press the DEL button to erase the character at the cursor position.
 - Press the CLR button to erase the entire name.
 - Press the →← button to center the name.
5. When you have finished assigning the name, press the OK button.

Recall the panel setup

1. Press the **BANK VIEW** button to turn it on.
Select a bank.
 2. Press the desired **PANEL MEMORY** number button (1 to 8).
 - The panel setup changes to the one stored in the specified memory.
 - You can then change the sound settings, etc. manually; however, the contents of the memory remain unchanged until you store them again.
 - The "Control Preset" bank of the **PIANO PERFORMANCE PADS (PR804)**, the soft pedal, or the sostenuto pedal can also be used to change from one **PANEL MEMORY** setup to another.
- The currently selected bank, memory number and memory name are shown in the top line on the normal display.

■ NEXT BANK

You can press the **NEXT BANK** button to switch to the next bank. This allows you to change banks without exiting the normal display.

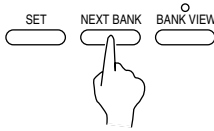

- Each time the **NEXT BANK** button is pressed, the bank changes in order from A to B to C. Following bank C, the bank changes to A.
- The panel settings change when a **PANEL MEMORY** number button (1 to 8) is pressed.

PANEL MEMORY mode

You can define which panel settings are recalled when the **PANEL MEMORY** is used.

1. Press and hold the **SET** button for a few seconds.
 - The display changes to the following.

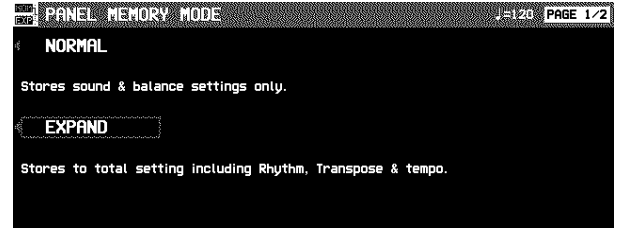

2. Select the mode.

NORMAL:

The sounds and volume balance, and **CONDUCTOR** status are stored.

EXPAND:

All the instrument's settings are stored, including the rhythm (except for **SOUND ARRANGER** on/off status), **TRANSPOSE**, tempo, etc.

- After a few seconds, the display exits the setting mode.

■ EXPAND MODE FILTER

You can specify which data is stored in the EXPAND mode.

1. Use the **PAGE** buttons to access the PAGE 2/2 EXPAND MODE FILTER display.
 - The display looks similar to the following.

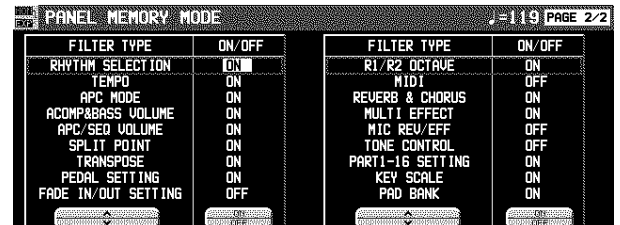

2. Use the **▲** and **▼** buttons to select the item.
3. Use the **ON** and **OFF** buttons to store the on or off status for the selected item.

Part III Piano Performance Pads (PR804)

Playing phrases

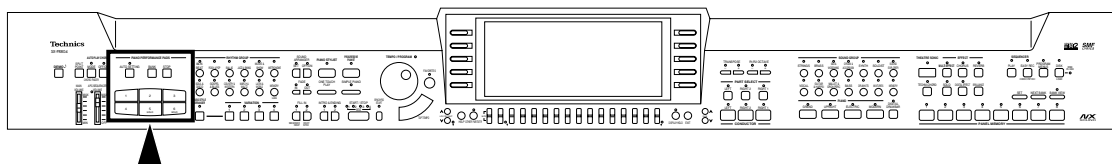

During your performance, you can insert a short recorded phrase or effect sounds by pressing a pad button. A different group of phrases is recorded in each bank.

1. Press the **BANK** button.

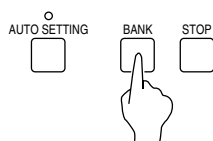

2. Select the desired bank from the display.

- The list of banks consists of three screen pages. Use the **PAGE** buttons to move from one screen page to another.

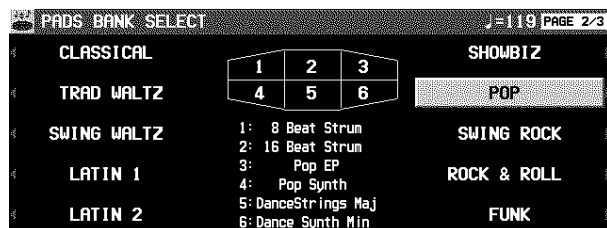

- “User Bank” 1, 2 and 3 are for storing your original phrases.
- “Compile Bank” 1 and 2 are for assigning phrases as you desire.
- Various functions are assigned to each pad button in “Control Preset”.

- ROTARY SLOW/FAST
- PANEL MEMORY BANK INCREMENT
- GLIDE
- PANEL MEMORY DECREMENT
- PANEL MEMORY BANK DECREMENT
- PANEL MEMORY INCREMENT

- For more information about these functions, please see to page 121.
- When using the “Control Preset” bank, set the **AUTO SETTING** button to OFF. When using the **PANEL MEMORY**, turn off the PAD BANK of the EXPAND MODE FILTER.
- The display returns to the previous display after a few seconds.

3. Press a pad button (1 to 6).

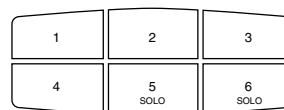

- A different phrase is assigned to each pad button.
- Information about the phrase, such as its name and the measure number, is shown in the normal display.
- The volume can be adjusted on the normal display.
- The selected phrase is played in the current tempo.
- To stop the phrase before it has ended, press the **STOP** button.
- Some phrases continue to play until the **STOP** button is pressed (the LOOP indication appears).
- During a rhythm performance, some phrases may play in time with the measure count.
- When the automatic accompaniment is on, the phrase is played in the specified chord.

SOLO

Pad buttons **5** and **6** (**SOLO**) are phrases with chord progressions. Just by pressing one of these pad buttons, the phrase changes following a chord progression that is typical for the music genre of that bank.

- Use with the automatic accompaniment during your performance.
- Pad button **5** accesses a major chord type progression, and pad button **6** a minor chord type progression.
- A table showing the chord progression for each bank can be found in the separate REFERENCE GUIDE provided.

AUTO SETTING

When this button is set to on, the bank automatically changes according to the automatic setting functions in the **PIANO STYLIST**, the **ONE TOUCH PLAY** and the **MUSIC STYLE ARRANGER**. When it is set to off, the bank does not automatically change according to these functions.



Copying phrases

You can copy the desired data, as phrases, from the **SEQUENCER** to each pad memory of a “User Bank”.

- Chord data is also copied to pad buttons 5 and 6 (**SOLO**).

PHRASE COPY

Copy a phrase from one pad to another.

1. Press the **PROGRAM MENUS** button to turn it on.



- The display looks similar to the following.



2. Select **PIANO PERFORMANCE PADS**.

- The display looks similar to the following.



3. Select **PHRASE COPY**.

- The display looks similar to the following.

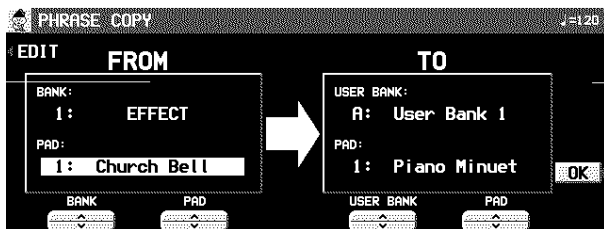

4. Select the pad you wish to copy from.

- Use the buttons on the FROM side to set the desired settings.

BANK: Bank name
PAD: Pad number (1 to 6)

5. Select the pad you wish to copy to.

- Use the buttons on the TO side to set the desired settings.
- USER BANK: Bank name (USER A, B, C)
PAD: Pad number (1 to 6)
- Only a **SOLO** phrase can be copied to the **SOLO** pads (5 and 6).

6. Press the **OK** button.

7. Press the **PROGRAM MENUS** button to turn it off.

- If you wish to modify a portion of the copied phrase, press the **EDIT** button to change to the recording display.

SEQ TO PAD COPY

1. Record a phrase in the **SEQUENCER**, or load data from a disk.

- After this procedure, please do not change the song number.
- For details about **SEQUENCER** operation, refer to page 61.
- For information about loading data, refer to page 96.

2. Press the **PROGRAM MENUS** button to turn it on.

3. Select **PIANO PERFORM PADS**.

4. Select **SEQ TO PAD COPY**.

- The display looks similar to the following.

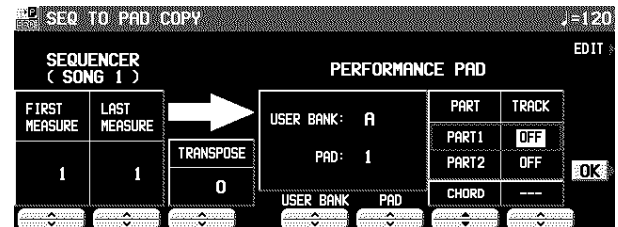

5. Select the measures of **SEQUENCER** data you wish to copy from.

- On the **SEQUENCER** side, use the \wedge and \vee buttons to make the corresponding settings.

FIRST MEAS: The first measure of the phrase you wish to copy.

LAST MEAS: The last measure of the phrase you wish to copy.

TRANPOSE: The setting to transpose the chords when they are copied.

- The maximum that can be copied is 16 measures.
- When copying to pad button 5 or 6, the chord track is automatically displayed, and the chord data is also copied. However, when chord data from step record input does not exist, the measures are blank. In this case, PART 2 cannot be used.
- If you wish to convert the chords during playback, set **TRANPOSE** to the key of C and then copy the phrase.

6. Select the pad button you wish to copy to.

- On the **PERFORMANCE PAD** side, use the \wedge and \vee buttons to make the corresponding settings.

USER BANK: The name of the bank (A/B/C).

PAD: Pad button number (1 to 6).

PART: The part to copy to.

7. Use the **TRACK** \wedge and \vee buttons to select the **SEQUENCER** track number to copy from.

- If there is **CHORD** data, it is automatically selected.

8. Press the **OK** button.

- A confirmation display appears. Press the **YES** button if you wish to copy the phrase, or press the **NO** button to cancel the procedure.

9. When you have completed the procedure, press the **PROGRAM MENUS** button to turn it off.

Compile

You can assign desired phrases from different banks in “Compile Bank” 1 and 2.

1. Press the **PROGRAM MENUS** button to turn it on.



- The display looks similar to the following.



2. Select **PIANO PERFORMANCE PADS**.

- The display looks similar to the following.



3. Select **COMPILE SET**.

- The display looks similar to the following.

PADS	BANK	PHRASE
PAD1	4: ROCK & ROLL	1: Rock Piano
PAD2	4: ROCK & ROLL	1: Rock Piano
PAD3	4: ROCK & ROLL	1: Rock Piano
PAD4	4: ROCK & ROLL	1: Rock Piano
PAD5	4: ROCK & ROLL	1: Rock Piano
PAD6	4: ROCK & ROLL	1: Rock Piano

- You can press the **NAMING** button and assign a name to the bank.

4. Press the **BANK** button to select a bank (Compile Bank: 1/2).

5. Use the **PADS** ▲ and ▼ buttons to select the pad to which to assign the phrase.

6. Use the **BANK** and **PHRASE** ^ and v buttons to select the desired bank and phrase you wish to assign.

- The “Control” bank cannot be selected.

7. Repeat steps 5 and 6 to assign phrases to the other pad buttons.

8. When you have finished assigning the phrases, turn off the **PROGRAM MENUS** button.

Record a phrase

“User Bank” A, B and C are reserved for storing your original phrases.

1. Press the **PROGRAM MENUS** button to turn it on.

- The display looks similar to the following.



2. Select **PIANO PERFORMANCE PADS**.

- The display looks similar to the following.



3. Use the buttons to the left of the display to select a **RECORDING BANK**.

- The display changes to the **RECORD PAD** display.
- You can press the **BANK NAMING** button and assign a name to the bank.
- If the **BANK CLR** button is pressed, all the data in the bank is cleared (a confirmation display appears).

4. Use the buttons below the display to select the pad number to record.

- The display changes to the **PAD RECORDING** display.
- You can press the **PAD NAMING** button and assign a name to the bank.
- To clear all the current data in the selected pad, press the **CLEAR THE PAD** button, and then press the **YES** button on the confirmation display.

5. Use the **MEAS** ^ and v buttons specify the number of measures in the phrase. Use the **TIME SIGNATURE** ^ and v buttons to specify the time signature of the phrase.

- This step is possible only if the **CLEAR THE PAD** procedure was executed.

(continued on the next page)

6. Press the OK button.

- For details about KEY SETTING, refer to page 87.
- For details about CHORD MODIFY CHANGE, refer to page 88.

7. Select the part to record to.

- Press the button for PART 1 or PART 2.
- Recording begins as soon as the pad is selected.
- Two parts can be recorded (PAD 1–4).
- The display looks similar to the following.

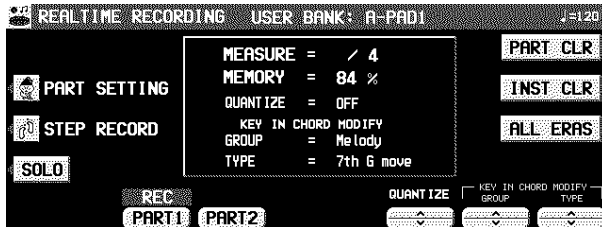

- Refer to page 89 for detailed information about PART SETTING.

8. Proceed to record.

- The recording procedure is the same as for the **COMPOSER**. (Refer to page 85.)
- When played back by the **AUTO PLAY CHORD**, the recorded phrase will be played in the specified chord.
- In the PLAY SETTING, if LOOP is set to OFF, LOOP recording is not possible.

PLAY SETTING

Select a playback mode.

1. On the PAD RECORDING display, press the PLAY SETTING button.

- The display looks similar to the following.

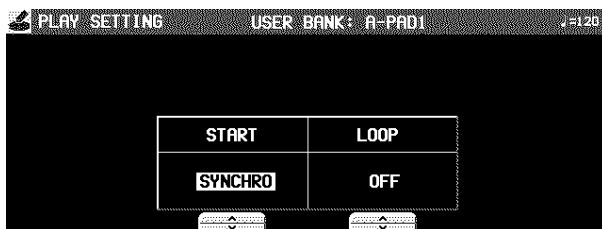

2. Use the START ^ and v buttons to select a playback mode.

SYNCHRO:

During a rhythm performance, the phrase playback begins in time with the beat.

INSTANT:

The phrase starts to play immediately when the pad button is pressed, regardless of the rhythm.

3. Use the LOOP ^ and v buttons to enable or disable loop playback.

ON:

Once the pad button is pressed, the phrase is played back repeatedly until the STOP button is pressed.

OFF:

The phrase is played back only once.

CHORD STEP RECORD

A chord progression can be stored in PAD 5 and PAD 6.

1. On the REALTIME RECORDING display, press the CHORD STEP REC button.

- The display looks similar to the following.

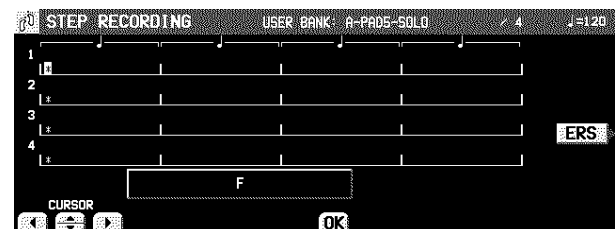

2. Use the CURSOR buttons to move the cursor to the position you wish to input.

- The cursor moves in 1/8-note increments.

3. Input the chord by playing it on the keyboard.

- The chord name is shown.
- Use the keys to the left of the specified keyboard split point (except for **PIANIST** mode).

4. Press the OK button.

5. Repeat steps 2 to 4 to store the rest of the chord progression.

- To delete a chord which has been input, move the cursor to the specific chord and press the ERS button.

Part IV Sequencer

Outline of the Sequencer

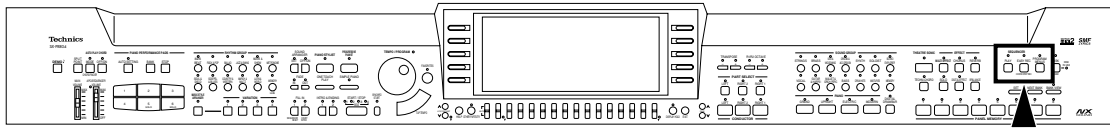

A sequencer records your performance in a similar way to a tape recorder. This instrument's **SEQUENCER** allows you to record up to 10 performances in a variety of ways. You may want to record your entire performance in one go (especially if you are using **AUTO PLAY CHORD** to provide the accompaniment), or to build up a complex arrangement with several different parts playing together, like an orchestral score. This instrument's **SEQUENCER** has 16 tracks. This means that you can record 16 different parts. However, you don't have to use all 16 tracks. For some uses you may only need to use one or two tracks. This instrument's **SEQUENCER** enables you to edit your recorded performance. Unlike a tape recorder you can change the sound or the tempo during playback, or correct wrong notes or timing errors.

SEQUENCER features

■ You can change the tempo without changing the pitch

When you record your performance at a slow tempo and play it back at a faster tempo, the pitch stays the same.

■ Consistent sound

Your performance is reproduced by a sound module as it reads digital data. So, unlike a recorded tape, the sound never deteriorates no matter how many times you play back your performance.

■ Edit your recorded performance

Comprehensive editing functions allow you to modify your recorded performance. Data can easily be erased, corrected or copied, providing an especially convenient tool for creating your original tunes.

■ Instant search

A recorded tape has to be rewound, but digital action means you can return to the beginning of your performance, or find any measure, instantly.

■ Save your performances on disks

All the data of your recorded performances can be stored on disks. The built-in Disk Drive also allows you to play commercially sold disks on your own Keyboard.

- Features and operation of the built-in Disk Drive are explained in Part VI: Disk Drive (page 94).

Popular features

■ Simplified recording method

EASY RECORD is a feature that allows you to bypass the more complex recording procedures so you can record and play back your performance quickly and easily.

- You can also record an accompaniment from the **AUTO PLAY CHORD**.

■ Create a one-man ensemble

Use the **REALTIME RECORD** function to record your performance in up to 16 tracks and create your own orchestra or band.

■ Store individual data to create your song

For repeating patterns or those especially complicated phrases, the **STEP RECORD** feature is convenient for recording the notes one-by-one.

- This method can be used to store both the chord progression for the automatic accompaniment and the rhythm changes.

Memory capacity

Up to 10 songs can be stored in the **SEQUENCER**. Expressed in terms of notes, the total number of notes which can be stored in all the **SEQUENCER** songs and tracks is about 40,000. The remaining memory available for recording is shown on the display as a percentage (MEMORY= %).

- When "Memory full!" appears on the display, no more data can be stored in the **SEQUENCER**.
- The recorded contents can be saved on a disk for recall at a later time. (Refer to page 99.)

SEQUENCER menu

The configuration of the **SEQUENCER** setting display is as follows.

1. Press the **PROGRAM MENUS** button to turn it on.



- The display looks similar to the following.



2. Select **SEQUENCER**.

- The display looks similar to the following.



- The **SONG** ^ and v buttons are used to select a song.
- You can press the **NAMING** button and assign a name to the song. (Refer to page 69.)
- You can press the **PANEL WRITE** button to store the current settings of the instrument at the beginning of the song. (Refer to page 69.)

(continued on the next page)

3. Select RECORD & EDIT, COPY & PASTE or RANGE EDIT, and follow the corresponding procedure.

<RECORD & EDIT>



<COPY & PASTE>



<RANGE EDIT>



Summary of the SEQUENCER menu items

RECORD & EDIT

These functions are recording and editing operations used for creating a new performance.

REALTIME RECORD (page 65)

Record each part of your performance just as you play it on the keyboard.

PUNCH RECORD (page 70)

Correct a selected portion of your recorded performance.

STEP RECORD (page 71)

Store the sounds note-by-note on the display.

- You can also store the chord or rhythm progression for the **AUTO PLAY CHORD**.

TRACK ASSIGN (page 76)

Assign parts to tracks.

QUANTIZE (page 77)

Correct the timing of your performance.

SONG SELECT (page 70)

Select a song.

SONG CLEAR (page 70)

Erase all the recorded data of a song.

TRACK CLEAR (page 78)

Erase the contents of a specific track.

NOTE EDIT (page 78)

Store and correct performance (NOTE) data on a piano roll display.

DRUM EDIT (page 79)

Store and correct DRUMS part data on a special display.

COPY & PASTE

Copy recording data and paste it to the desired location.

TRACK COPY (page 80)

Copy data of specific tracks.

SONG COPY (page 80)

Copy data of specific songs.

TRACK MERGE (page 80)

Merge the recorded contents of two tracks and store in a third track.

TRACK CLEAR (page 78)

Erase the contents of a specific track.

SONG CLEAR (page 70)

Erase all the recorded data of a song.

MEASURE COPY (page 81)

Copy the contents of specific measures.

MEASURE ERASE (page 81)

Erase the contents of specific measures.

MEASURE DELETE (page 81)

Delete specific measures from the performance.

MEASURE INSERT (page 82)

Insert additional measures in the performance.

APC TO SMF CONVERT (page 82)

With this function, the automatic accompaniment performance data that is recorded collectively in the APC/CHORD/RHYTHM/CONTROL part is distributed among separate tracks.

RANGE EDIT

Change the note position etc. in the recorded data.

QUANTIZE (page 77)

Correct the timing of your performance.

VELOCITY CHANGE (page 83)

Modify the recorded velocity (how hard the keyboard was played) of performance data.

NOTE CHANGE (page 83)

Change the pitch of specific notes.

TRANSPOSE (page 83)

Change the key of the performance data.

ADVANCE/DELAY (page 84)

Speed up or delay the sound production of performance data.

About the measure count

The measure count on the display corresponds to the time signature of the selected rhythm. However, if rhythm data is stored in the RHYTHM part and that part is played back, the measure count on the display corresponds to the stored rhythm data. (Refer to page 75.)

- If you wish to use a time signature not available in the preset rhythms, use the **COMPOSER** to create a new time signature. (Refer to page 86.)

Slide Show

This instrument can show various images which change automatically corresponding to the music progression just like the **DEMO** performance. Using the Slide Show function, you can create a multi-media show of images synchronizing with the sound.

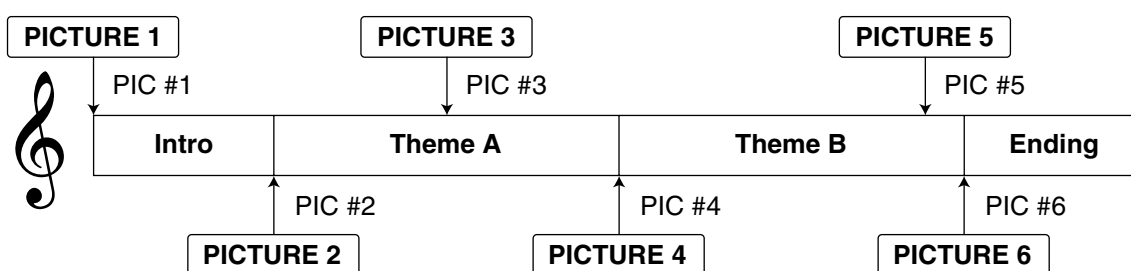
Schematic**Set the images**

To set the images, proceed as follows.

1. Record a song in the SEQUENCER. (See pages 65 to 67.)
2. Specify the points (PIC) at which the image must be changed on the STEP RECORD (CONTROL) display. (See page 73.)
3. Replay the song.
 - The selected image is displayed in whole screen at the specified point (PIC). The image continues to be shown until the next PIC point comes.
 - Images will be displayed on either the normal display or the SEQUENCER PLAY display.
 - **PR804**: You can output the displayed images to an external monitor such as a TV set. (See page 136.)

Load your original images

Besides a variety of preset images of the instrument, you can use your original images on your PC, etc.

1. Save the image data to a disk.
 - The instrument can read .BMP and .JPG formats (not compatible with all data with those extensions).
2. Insert the disk into the DISK DRIVE. (See page 96.)
3. Load the data using the STEP RECORD display.

MEMO

- This instrument is compatible with images sized 640 x 240 pixels. Even though an image sized up to 640 x 480 pixels can be read, the data will be cut out to 640 x 240 pixels when loading.
- Depending on the size, it may not be possible to load the image.
- After the PICTURE LOAD display appears, no sound is produced on the instrument.
- **PR604**: The display consists of a monochrome, 4-gradation screen. It is recommend that you remake the images beforehand to adapt for the screen capacity using a graphic application, etc, in your computer.

Sequencer parts

The following summary explains what is stored in each **SEQUENCER** part.

Part name [name on display]	Used for	Recorded contents
RIGHT1 [RT1] RIGHT2 [RT2] LEFT [LFT] PART1 [P 1] – PART9 [P 9] PART11 [P 11] – PART16 [P16]	Recording the performance of each part (REALTIME/STEP)	<ul style="list-style-type: none"> • Sound and volume settings • PART EXPRESSION • Contents of sound and effect settings that can be set on the MIXER display (Refer to page 105.) • PITCH BEND, MODULATION data • Pedal operation
DRUMS [DRM] (PART 10)	Recording the drums performance with the DRUM KITS group sounds (REALTIME/STEP)	<ul style="list-style-type: none"> • Sound and volume settings • PART EXPRESSION • Contents of sound and effect settings that can be set on the MIXER display (Refer to page 105.)
CONTROL [CTL]	Recording changes in the panel button status (REALTIME/STEP)	<ul style="list-style-type: none"> • Rhythm setting and selection changes • REVERB on/off • AUTO PLAY CHORD status, volume balance • MUSIC STYLE ARRANGER status • FILL IN 1, 2, INTRO & ENDING 1, 2 on • PANEL MEMORY selection changes • TRANSPOSE status • TECHNI-CHORD status • START/STOP on/off • TEMPO setting • CONDUCTOR status • PIANO PERFORMANCE PADS setting (PR804) • FADE IN/OUT operation • APC/SEQUENCER VOLUME settings. • TOTAL EXPRESSION • Images for SLIDE SHOW (PIC) (STEP)
AUTO PLAY CHORD [APC]	Recording chords for the AUTO PLAY CHORD (REALTIME)	<ul style="list-style-type: none"> • Chord progression • AUTO PLAY CHORD status, volume balance • START/STOP on/off • FILL IN 1, 2, INTRO & ENDING 1, 2 on
CHORD [CHD]	Recording chord progression for the AUTO PLAY CHORD (STEP)	<ul style="list-style-type: none"> • Chord progression • FILL IN 1, 2, INTRO & ENDING 1, 2 on
RHYTHM [RHY]	Settings related to rhythm (STEP)	<ul style="list-style-type: none"> • Rhythm settings and selection changes • FILL IN 1, 2, INTRO & ENDING 1, 2 on • START/STOP on/off • TEMPO setting

- You can use the TRACK ASSIGN function to assign parts to tracks as you wish. (Refer to page 76.)
- Those items above which are not operations available with this instrument can be recorded only from MIDI input.

Easy Record

Suppose you are playing your instrument and you wish to record and play back your performance to hear how it sounds. You can bypass the set-up procedures of the full-scale sequencer and begin recording quickly and easily.

- Note that by executing **EASY REC**, the original data in the selected song number is erased.

Recording procedure

1. Press the **EASY REC** button to turn it on.

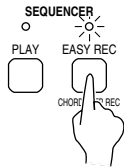

- The display changes to the following.

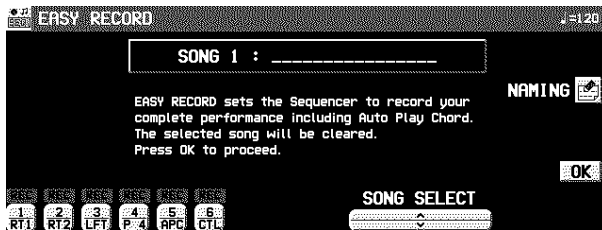

2. Use the **SONG** ^ and v buttons to select the song number in which to record (1 to 10).

- If you press the **NAMING** button, you can assign a name to your song. (Refer to page 69.)

3. Set the desired sounds, effects, rhythms, etc.

4. Press the **OK** button.

- The display changes to the **REALTIME RECORD** display.

5. Play the keyboard.

- Recording begins as soon as you start the rhythm or play the keyboard.
- For a performance using rhythm, be sure to press the **START/STOP** button or the **ENDING** button to end your performance.

6. When you have finished recording, press the **EASY REC** button to turn it off.

- The **PLAY** button turns on.

Playback

1. Press the **SEQUENCER RESET (FILL IN 1)** button.

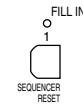

2. Press the **START/STOP** button.

- Your recorded performance is played back automatically.
- When you are finished playing back your performance, press the **SEQUENCER PLAY** button to turn it off.

Realtime Record

With **REALTIME RECORD**, your performance is recorded with the timing exactly as you played it on the keyboard. Use this mode to record your performance in up to 16 tracks and create your own orchestra or band.

Recording procedure

1. Press the **PROGRAM MENUS** button to turn it on.

- The display changes to the following.



2. Select **SEQUENCER**.

- The display looks similar to the following.



- When you press the **PANEL WRITE** button, the **PANEL WRITE** display appears. To store the currently active settings, such as the sounds, at the beginning of the song, press the **OK** button.

3. Use the **SONG** ^ and v buttons to select a song number in which to record. (The song number is shown on the display.)

4. Select **RECORD & EDIT**.

- The display looks similar to the following.



5. Select **REALTIME RECORD**.

- The display looks similar to the following.

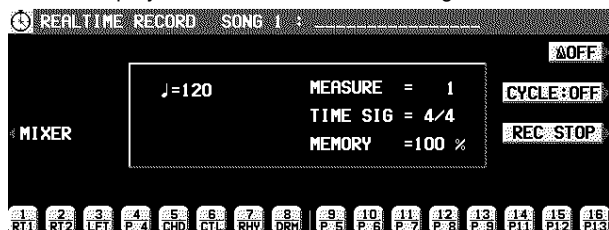

6. Use the buttons below the display to turn on the “REC” indication above the track numbers you are going to record.

- While you are recording, you can play back tracks which are already recorded. Press the corresponding balance buttons to display “PLAY” above the track number you wish to have played back.
- You can record multiple parts at the same time if the corresponding **RIGHT 1**, **RIGHT 2** and **LEFT** part buttons in the **CONDUCTOR** are ON. Parts other than these can only be recording one at a time.
- To record **AUTO PLAY CHORD (APC)** parts, turn on the **AUTO PLAY CHORD's OFF/ON** button. In this case, press the **START/STOP** button when beginning recording.
- If CHD is selected, it changes to APC.
- The track for the RHYTHM (RHY) part can be selected for recording only when STEP RECORD is active.

7. Set the sounds, effects, volumes, etc. for the parts you are going to record.

- If you press the MIXER button, you can use the MIXER display to visually adjust the settings for each track.
- The LOCAL CONTROL ON/OFF setting on the MIXER display is used to specify whether the part assigned to that track sounds when it is played on the keyboard during recording. For the LOCAL CONTROL ON/OFF during playback, use the TRACK ASSIGN display to adjust the settings. (Refer to page 76.)
- If you are recording GM2 song data, select from the GM2 group in the **SOUND EXPLORER**.
- The panel settings which are active at the beginning of recording are stored.

8. Use the **TEMPO/PROGRAM** to adjust the recording tempo.

- The tempo is shown on the display as $\text{♩} =$.
- If you wish to record the tempo setting and tempo changes, store them in the control (CTL) part, or use the step record to store them in the rhythm (RHY) part.

9. Turn the metronome on or off as desired with the ON/OFF button at the upper right of the display.

- The metronome selection alternates between ON and OFF each time the button is pressed.
- When set to ON, the metronome volume setting display is momentarily shown.
- The metronome sound is not recorded.

10. Play the keyboard.

- Recording begins.
- You can also press the **START/STOP** button to start the rhythm and begin recording.
- If the metronome is on, when you press the **START/STOP** button, a two-measure count plays, after which recording automatically begins. In this case, the rhythm does not start. Recording does not start until the two-measure count is completed.
- The recording status is continuously updated on the display:

MEASURE= indicates the current measure.

TIME SIG.= indicates the current time signature.

MEMORY= indicates the remaining memory (%) available for recording.

- If you wish to redo the recording, press the REC STOP button and then record again. To change the sounds and effects, etc. please set them again.
- If you make a mistake in recording, you can correct a specific portion of your performance without having to redo the whole part. (Refer to page 70.)

11. When you have finished recording, press the REC STOP button on the display, or turn off the **PROGRAM MENUS** button.

- When the **PROGRAM MENUS** button is turned off or the REC STOP button is pressed, the ending command (END) is recorded. Note that, as long as the ending command is not recorded, blank recording continues even if you stop playing.
- The **SEQUENCER PLAY** button turns on.

■ Multi-track recording

Use the following procedure to record one track while listening to the track or tracks already recorded.

1. Follow the procedure to record the first track, and press the REC STOP button at the end of the recording.

- The indication for the track just recorded changes from “REC” to “PLAY”.

2. Turn on the “REC” indication for the track you wish to record next, and select the sounds and effects, etc.

3. Press the **START/STOP** button and begin recording.

- Tracks for which “PLAY” is shown are played back, and you can record in time with this.

4. Press the REC STOP button at the end of the recording.

5. Repeat steps 2 to 4 for other tracks, as desired.

6. When multi-track recording is finished, turn off the **PROGRAM MENUS** button.

- If you wish to store part settings that you modified after recording as beginning song data, press the MIXER button and follow the PANEL WRITE procedure. (Refer to page 69.)
- To record rhythm **START/STOP** data in a multi-track recording, input the data in the CONTROL or RHYTHM part of the STEP RECORD. (Refer to page 71.)

CYCLE RECORD

This mode allows you to have specified recording measures continuously repeated. Thus you can record measures by adding notes during any cycle.

1. On the **REALTIME RECORD** display, specify “REC” for a track number you are going to record, and “PLAY” for track numbers you wish to have played back.
2. Press the **CYCLE: OFF** button.
 - The display looks similar to the following.

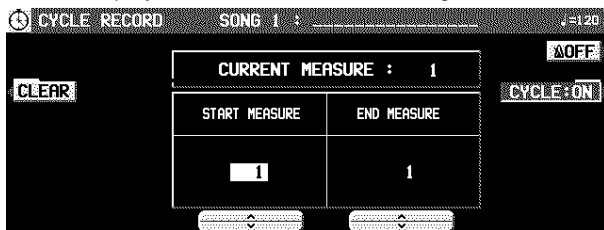

3. Use the **START MEASURE** \wedge and \vee buttons to specify the beginning measure number.
4. Use the **END MEASURE** \wedge and \vee buttons to specify the ending measure number.
 - The measure in which the **END** command has been stored can also be specified.

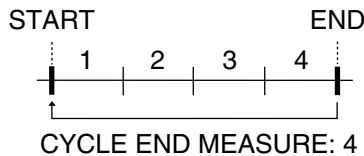

5. Press the **START/STOP** button.
 - If the metronome is on, cycle recording of the specified measures begins after a two-measure count.
 - Recording does not start even when the keyboard is played.
6. Play the keyboard.
 - The specified measures are repeated, during which time you can record by adding notes little by little at the correct timing (over-dubbing).
 - If you wish to erase all the performance data from the specified measures, press the **CLEAR** button.
 - If the **CYCLE: ON** button is pressed, it changes to **OFF**. This button does not function during recording.
 - To return to the **REALTIME RECORD** display, press the **EXIT** button.
 - Cycle record can also be started from the **REALTIME RECORD** display whenever the **CYCLE: ON** indication is shown.
7. When you have finished recording, press the **REC STOP** button on the display, or turn off the **PROGRAM MENUS** button.

Sequencer Play

Play back your recorded performance.

1. Press the **SEQUENCER PLAY** button to turn it on.

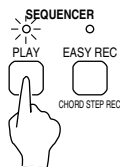

- The display looks similar to the following.

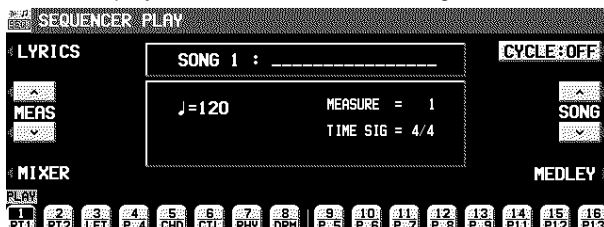

2. Use the **SONG** button to select the song number you wish to play back.
3. Use the balance buttons below the display to show “PLAY” above the track numbers you wish to have played back.
 - Highlighted track numbers indicate tracks that are already recorded. Only highlighted track numbers can be selected for playback.

- You can select two or more tracks to play back at one time.

4. Press the **SEQUENCER RESET (FILL IN 1)** button.
 - The **SEQUENCER** returns to the beginning of the song and the beginning panel settings are recalled.
5. To begin playback from a measure other than measure 1, press the **MEAS** button, and then use the **MEAS** \wedge and \vee buttons to specify the beginning measure.
 - “MEASURE=” indicates the current measure number.
6. Press the **START/STOP** button.
 - The recorded performance is played back from the specified measure.
 - When playback is begun from a measure in which an **INTRO**, **COUNT INTRO**, **FILL IN** or **ENDING** is recorded, the corresponding function does not work.
 - You can press the **MIXER** button and modify the settings for each part.
7. To stop playback, press the **START/STOP** button.
 - If the **START/STOP** button is pressed again, playback will continue from the point it was interrupted.

- When you are finished playing back your performance, press the **SEQUENCER PLAY** button to turn it off.

If a rhythm progression has been recorded in the RHYTHM (RHY) part, the MEASURE display used in the STEP RECORD and EDIT displays conforms to the time signature data stored in the RHYTHM part.

Adjusting the playback tempo

Even with a song having recorded tempo data, you can use **TEMPO/PROGRAM** or **TAP TEMPO** to adjust the tempo to your liking.

- When the tempo is changed, all the tempo data of that song is automatically changed by the same ratio. Accordingly, even in song data in which tempo change data is stored, a single adjustment of the tempo produces a natural-sounding playback.
- To return to the original tempo, while the song is stopped press the **SEQUENCER RESET** button (the tempo data is necessary at the beginning of the CONTROL track). Note that the tempo change is also canceled when you switch to another song or load a new song.
- The adjusted tempo is canceled when you begin the recording procedure and the original tempo data will be recorded.

CYCLE PLAY

You can have specified measures played back repeatedly.

- On the SEQUENCER PLAY display, specify "PLAY" for track numbers you wish to have played back.

- Press the CYCLE button.

- The display looks similar to the following.

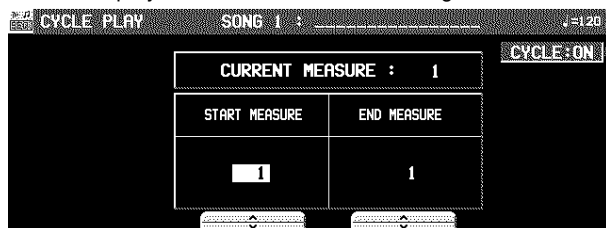

- Use the START MEASURE \wedge and \vee buttons to specify the beginning measure number.

- Use the END MEASURE \wedge and \vee buttons to specify the ending measure number.

- The measure in which the END command has been stored can also be specified.

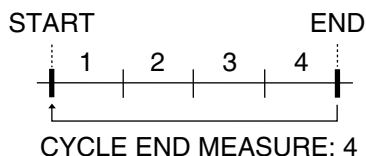

- Press the **START/STOP** button.

- Cycle playback of the specified measures begins.
- Normally the rhythm pattern is not played back.

- To stop cycle playback, press the **START/STOP** button again.

- During playback stop, if the **SEQUENCER RESET (FILL IN 1)** button is pressed, the **SEQUENCER** returns to the measure number specified in step 3. If the **SEQUENCER RESET** button is pressed again, the **SEQUENCER** returns to measure 1.
- If you press the CYCLE button to turn it OFF, cycle playback is not possible.
- To return to the SEQUENCER PLAY display, press the **EXIT** button.
- Cycle playback can also be specified on the SEQUENCER PLAY display whenever the CYCLE: ON indication is shown.

MEDLEY

Multiple recorded songs can be played back in a medley.

- On the SEQUENCER PLAY display, press the MEDLEY button.

- The display looks similar to the following.

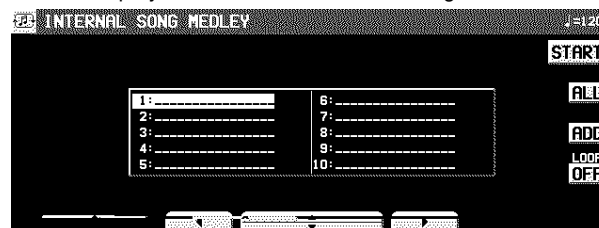

- Specify the order of songs in the medley.

- If ALL is pressed, all the files are selected, and the songs are played back in order in a medley. If ALL is pressed again, the files are deselected.
- You can use the buttons below the display to select a song to add to the song list, then press the ADD button to add it to the list. Repeat these steps to create your own list of songs to have played back. A M01, M02 etc. next to the file name indicates its order in the list.
- You can delete a marked file from the medley song list by selecting it and pressing the ADD button.
- Use the LOOP button to specify ON or OFF for repeat playback of the medley.

- Press the **START** button.

- During medley playback, you can use the SKIP button to skip to the next song.

SEQUENCER VOLUME

When playing the keyboard along with a recorded performance, you can adjust the total volume of all the playback parts as one.

⇒ Use the **APC/SEQUENCER VOLUME** slide control to adjust the volume.

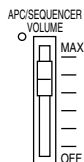

- Use this control to lower the volume of the recorded playback parts when it is too loud relative to the volume of your manual performance.
- The volume of all sounds other than your manual performance—including **PIANO PERFORMANCE PADS (PR804)**, MIDI input, etc.—is lowered.

- At the **MAX** position, the volume of the playback parts correspond to their current settings; at the **OFF** position, the volume is 0.
- The volume can be adjusted for each part. (Refer to page 31.)
- Except during **SEQUENCER** playback or **DIRECT PLAY** of a disk, this slide control adjusts the total volume of all the automatic accompaniment parts.
- During **SEQUENCER** recording, the volume is automatically at its maximum regardless of the position of the slide control. During playback, however, lowering the slide control from the **MAX** position will lower the volume from its recorded level. For this reason, the slide control should normally be left in the **MAX** position.

Naming

Here is the way to assign a name to your recorded song.

1. On the SEQ MENU display use the SONG \wedge and \vee buttons to select a song.

2. Press the NAMING button.

- The display looks similar to the following.



3. Assign a name to the song.

- Press the ABC button to enter alphabetical characters. While the SHIFT button is pressed, upper case letters are entered.
- Press the 123 button to enter numbers, etc. While the SHIFT button is pressed, you can enter symbols.
- Press the POSITION button to move the cursor.
- You can also use the **TEMPO/PROGRAM** dial to select the characters.
- Press the INS button to enter a space at the cursor position.
- Press the DEL button to erase the character at the cursor position.
- Press the CLR button to erase the entire name.
- Press the $\rightarrow\leftarrow$ button to center the name.

4. Press the OK button.

Panel Write

You can change the panel status which is in effect at the beginning of the song. These are the settings which are recalled when the **SEQUENCER RESET** button is pressed.

1. On the SEQ MENU display, use the SONG \wedge and \vee buttons to select the song number. Then select **PANEL WRITE**.

- The display looks similar to the following.

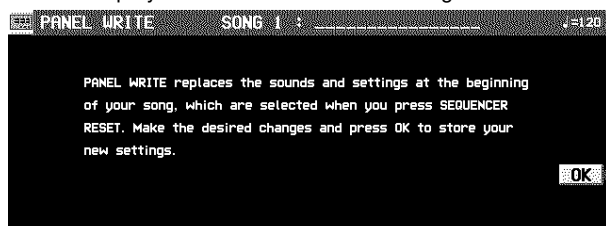

2. Use the panel buttons to change to the desired panel settings.

3. Press the OK button.

- "COMPLETED!" is shown on the display.
- **PANEL WRITE** is automatically activated at the when you start to record.
- For rhythm data, the data in the RHYTHM part has priority.

Song Select

You can select a desired song from the list of recorded songs.

1. On the SEQ MENU display, select RECORD & EDIT.
2. On the RECORD & EDIT display, select SONG SELECT.
 - The display looks similar to the following.

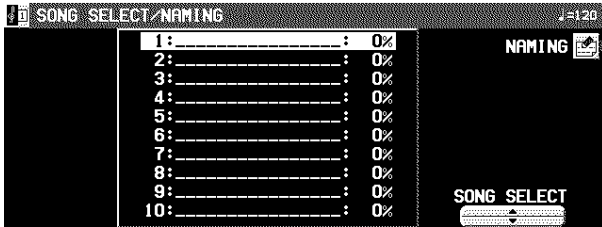

3. Use the SONG SELECT ▲ and ▼ buttons to select a song.
 - The total amount of memory used for the current song is shown as a percentage (%) to the right of the song name.
 - If the NAMING button is pressed, the NAMING display appears.
 - To optimize memory, songs you do not wish to preserve should be deleted. (Refer to page 77.)

Punch Record

If you make a playing error during REALTIME RECORD or would like to change the recording for some other reason, you can use the punch recording feature to correct a selected portion of the performance without having to redo the whole part.

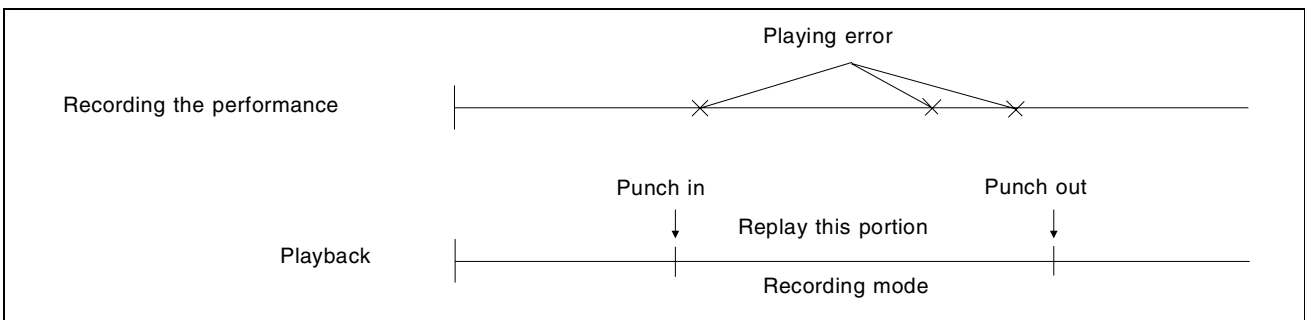

1. On the SEQ MENU display, use the SONG SELECT ▲ and ▼ buttons to select the song number. Then select RECORD & EDIT.
2. On the RECORD & EDIT display, select PUNCH RECORD.
 - The display looks similar to the following.



3. Select the track which contains the portion you want to correct.
 - You cannot select a track in which no data is stored.
 - On the display "REC" indicates tracks which are being recorded, and "PLAY" indicates tracks which are being played back.
4. Use the MEAS ▲ and ▼ buttons to specify the beginning measure of playback.
 - "MEASURE=" indicates the current measure number.
5. Press the **START/STOP** button to begin playback of the specified track.

6. During playback, press the PUNCH IN button at the point you want to begin recording.
 - Recording begins as soon as the PUNCH IN button is pressed. Begin playing at this point.
 - The REC indication changes to the PUNCH indication.
 - The PUNCH IN button switches to the REC STOP button.
7. Press the REC STOP button at the point you want to stop recording.
 - Punch recording stops immediately.
 - You can also begin punch-in recording by playing the keyboard.
 - You can specify the punch-in/punch-out points with the pedal. (Refer to page 121.)

■ AUTO PUNCH RECORD

You can also set the punch-in and punch-out points beforehand, so that recording automatically begins and ends at the specified points.

1. On the PUNCH RECORD display, press the **AUTO: OFF** button.
 - If REC is not shown for any track, the button does not turn ON.
 - The display looks similar to the following.

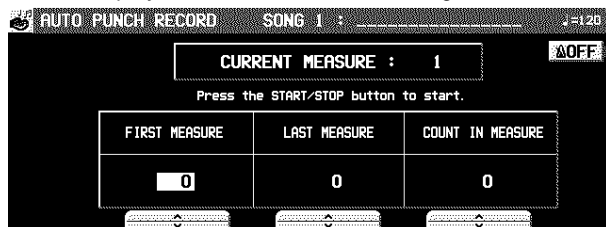

2. Use the **FIRST MEASURE** \wedge and \vee buttons to specify the number of the punch-in measure.
3. Use the **LAST MEASURE** \wedge and \vee buttons to specify the number of the punch-out measure.
 - The number of the LAST measure must be higher than the number of the FIRST measure.
 - The specified measure is recorded.
4. Use the **COUNT IN MEASURE** \wedge and \vee buttons to specify the number of lead-in measures you wish to have played back before the punch-in measure.
 - Set the metronome to on or off with the **ON** or **OFF** button.

5. Press the **EXIT** button.

- The display changes to the PUNCH RECORD display.

6. Press the **START/STOP** button.

- Playback begins from the measure indicated by **CURRENT MEASURE** on the display.
- Pertinent information, such as the **FIRST MEASURE**, is shown in the upper section of the display.

7. Correct the performance.

- The mode changes automatically to the recording mode at the specified **FIRST** measure. Begin playing at this point. The mode automatically changes back to the playback mode at the specified **LAST** measure.
- To discontinue punch recording in the middle, press the **CANCEL** button. In this case, the recorded contents up to that point are erased.

Step Record

STEP RECORD is simply a method of making a tune by storing the sounds note-by-note on the display. Instead of playing the keyboard directly as in the **REALTIME RECORD** mode, you can take your time to input each single note. This is an especially effective method for storing complicated passages that are difficult to play or when the exact timing of a part is critical.

Recording procedure

Record the keyboard performance and panel changes.

1. On the **SEQ MENU** display, use the **SONG** \wedge and \vee buttons to select the song number. Then select **RECORD & EDIT**.
2. On the **RECORD & EDIT** display, select **STEP RECORD**.

- The display changes to the **PART SELECT** display.



3. Use the balance buttons below the display to specify the track for the part you are going to record (only one track can be selected at a time).

- The display changes to the **STEP RECORD** input display similar to the following.



- If you selected the track to which the **CHORD** part has been assigned, the display changes to the **STEP RECORD: CHORD** display. (Refer to page 74.)
- If you selected the track to which the **RHYTHM** part has been assigned, the display changes to the **STEP RECORD: RHYTHM** display. (Refer to page 75.)
- If you selected the track to which the **CONTROL** part has been assigned, the display changes to the **STEP RECORD: CONTROL** display.

4. Use the **MEAS** \blacktriangle and \blacktriangledown buttons to select the measure.

- This step is not necessary if you are recording from measure 1 of a blank track.

5. Use the CURSOR ◀ and ▶ buttons to move the cursor to the note position (dot) you are going to store.

- Each dot represents one-eighth of a quarter-note (a thirty-second note).
- When storing triplets, it may not be possible to match the timing exactly with the 1/32-note steps. However, if you select triplet-type notes for the note length (LENGTH) in step 6 below, the timing is automatically corrected.

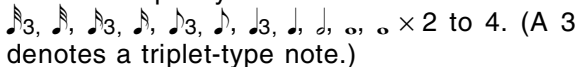
6. Use the left REC NOTE LENGTH ^ and v buttons to specify the note value. Select from  × 2 to 4. (A 3 denotes a triplet-type note.)

- For note values other than these, use the center REC NOTE LENGTH buttons to specify the note value to be added to that which you specified with the left buttons.

Example: To record a dotted quarter-note (♩.)



7. Use the right REC NOTE LENGTH ^ and v buttons to specify the actual length of the produced sound for the desired legato or staccato effect.

TENU (tenuto): Sound is produced for 95% of the note length.
 NORM (normal): 80%
 STAC (staccato): 50%
 CUTT (cutting): 25%

8. Specify the pitch and velocity of the note by playing the keyboard.

- The dot on the display where the note is stored changes to a * mark.
- When recording chords, you can store multiple notes at one position.
- Any panel setting changes—for example changes in the sound selection, button operation, etc.—are recorded at the cursor position.
- When the **TEMPO/PROGRAM** dial is operated, the input value is indicated on the display. Confirm that this is the correct value and press the YES button to record the value or the NO button to cancel it.

BAL:

To specify the volume at the cursor position, after pressing the BAL button, use the VALUE buttons to set the volume (0 to 127).

ERS:

If you make a mistake, move the cursor to the error, and after displaying the data you wish to erase, press the ERS button.

REST:

To store a rest, after specifying the note LENGTH, press the REST button.

- Positions at which nothing is stored are read as rests.

9. Repeat steps 5 through 8 to continue storing notes.

- To input data on another track, press the button for the desired track and repeat the procedure from step 2.

10. When you have finished recording, press the **PROGRAM MENUS** button to turn it off.

■ Storing control data

Various control data can be stored at the cursor position.

1. On the STEP RECORD: MELODY display, press the CTL button.

2. Use the CTL ^ and v buttons to select the control data you wish to insert.

- Select from PAN, KEY SHIFT (COARSE TUNE), TUNING (FINE TUNE), BEND SENS.

3. Use the VALUE ^ and v buttons to adjust the numerical value of the setting.

4. Press YES button.

■ Correcting the data

1. In the STEP RECORD mode, specify the track you wish to correct.

2. Use the MEAS buttons to go to the measure you wish to modify. Use the CURSOR buttons to move the cursor to the point (*) you wish to edit.

- The data stored at that point is shown on the display.
- When multiple data is stored at one point, different data is displayed in order each time a CURSOR button is pressed. When a chord is recorded, a different note in the chord is displayed each time a CURSOR button is pressed.

3. Correct the data.

There are three types of data:

Performance data

NOTE data (note pitch) and VEL data (how hard the key was played) and LEN data (1 = 1/96 of a quarter note [♩]) are displayed. Use the relevant buttons to correct the data as desired.

Sound data

The name of the sound is displayed. Change the sound as desired (the sound setting display is interposed on the current display).

Control data

The name of the function is displayed. Change the data as desired.

- Press the ERS button to erase the data which is displayed.
- You can also correct data which was stored in the REAL-TIME RECORD mode.
- Performance (NOTE) data can be recorded or edited on a piano roll display. (Refer to page 78.)

Assigning the images

Assign images to the selected point (PIC) of a song.

1. Use the SONG SELECT \wedge and \vee of the SEQUENCER MENU display to select a song number to which the images will be assigned, and select RECORD & EDIT.
2. Select STEP RECORD on the RECORD & EDIT display.
3. Use the balance buttons below the display to select CONTROL TRACK (CTL).
 - The display looks similar to the following.

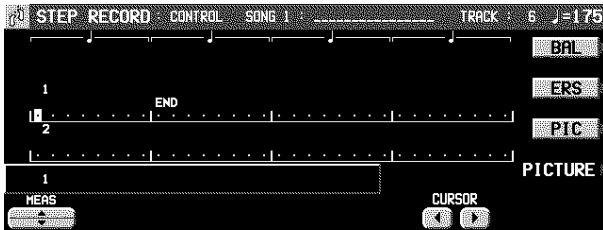

4. Use the MEAS \wedge and \vee buttons to specify the measure to assign.
5. Use the CURSOR buttons to move the cursor (reversed box) to the point you are going to assign an image.
 - Each point represents one-eighth of a quarter note (a thirty-second note).
6. Press the PIC button.
 - The display looks similar to the following.

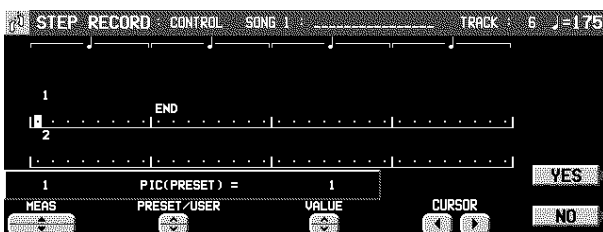

7. Use the PRESET/USER button to select one.

PRESET:
preset images

USER:
your original images loaded beforehand
8. Use the VALUE button to select the image number.
9. Press the YES button.
 - The image of the specified number is assigned to that point (PIC).
10. Repeat the steps 4 to 9 to continue assigning.
11. When you have finished assigning, press the **PROGRAM MENUS** button to turn it off.
 - When you play back the song, the images appear on the display and change automatically corresponding to the music progression (Slide Show).

- The moment where the images are displayed may be retarded slightly from the specified point. If this is too excessive, adjust the point so that it occurs slightly sooner.
- When two assigned points are too close, the result may not be favorable. It is recommended that the interval between two points should not be less than two beats for a $\text{♩}=120$ tempo music for example.
- The preset images are not compatible with other models.

PICTURE LIST

On the step 3 display, if you press the PICTURE button, a list of USER image data will be displayed.

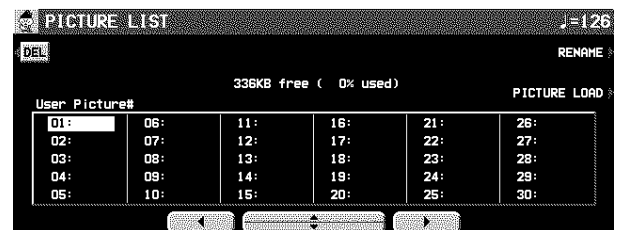

- Press the RENAME button to rename the image data name.
- Press the DEL button to delete selected image data.

Loading your original images

1. Save the image data to a disk using your PC. etc.
2. Insert the disk with saved data into the DISK DRIVE. (See page 96.)
3. On the CONTROL display of the STEP RECORD, press the PICTURE button.
4. On the PICTURE LIST display, press the PICTURE LOAD button.
 - The display looks similar to the following.



5. Select the image data file to be loaded.
 - When you select a image sized over 640 x 240 pixels, press the TRIMMING button to select the type of data cutting out.
6. Use the USER PICTURE \wedge and \vee buttons to specify the image number to which the image data will be loaded.
7. Press the LOAD button.
 - The image is loaded and "COMPLETED!" is shown on the display.

Store a chord progression

Store the chord progression for the **AUTO PLAY CHORD** in the track for the CHORD part. Then, when the **AUTO PLAY CHORD** is used during playback, even if you do not specify the chords with your left hand, the chords change automatically.

- The chord length is specified with the **CHORD STEP RECORD** keys on the keyboard.

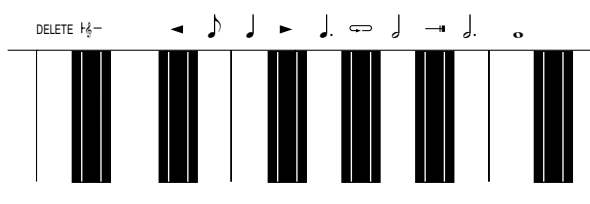

Note value keys

- Whole note
- ◡ Dotted half-note
- ◡ Half-note
- ◡ Dotted quarter-note
- ◡ Quarter-note
- ◡ Eighth-note

Reset key
 Press to begin storing from the beginning.

Correction keys

- ◀ Move back one step.
- ▶ Move forward one step.

Repeat key
 Press to end the chord-storing procedure and to specify automatic repeat playback of the stored progression.

End key
 Press after the whole chord progression has been stored.

DELETE key
DELETE Press to erase data.

- To erase all the data from the current track, while pressing the **DELETE** key, press the End key ().

■ Example of storing a chord progression

Measure 1	2	3	4
C	C	Am F	D7 G7
○	○	◡ ◡	◡ ◡

1. On the SEQ MENU display, use the SONG \wedge and \vee buttons to select the song number. Then select RECORD & EDIT.
2. On the RECORD & EDIT display, select STEP RECORD.
 - The display changes to the PART SELECT display.
3. Using the balance buttons below the display, select the track to which the CHORD (CHD/ APC) part has been assigned.
 - The display changes to the STEP RECORD: CHORD input display similar to the following.
 - This display can also be accessed by pressing and holding the **CHORD STEP REC (EASY REC)** button for a few seconds.

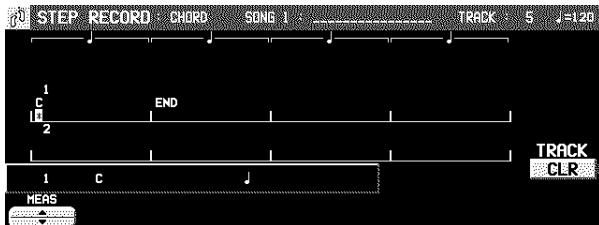

4. Store the chords.

<Measure 1, measure 2>

⇒ While playing a C chord with your left hand, press the ○ key one time with your right hand.

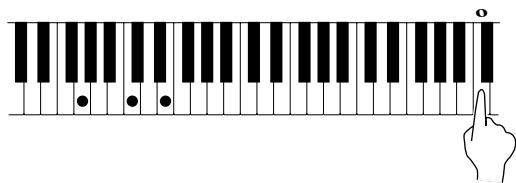

- A “beep” tone indicates that the chord has been successfully stored.
- The dot on the display where the chord is stored changes to a * mark and the cursor automatically moves forward, in accordance with the specified note value, to the next unrecorded position. The chord name is shown on the display.

<Measure 3>

(1) While playing an Am chord, press the ◡ key one time.

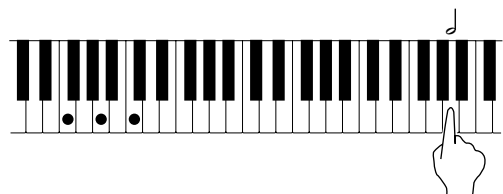

(2) While playing an F chord, press the ◡ key one time.

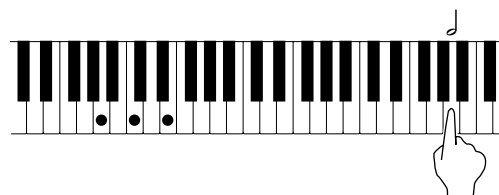

<Measure 4>

- (1) While playing a D7 chord, press the \downarrow key one time.
- (2) While playing a G7 chord, press the \downarrow key one time.
 - You can press the **INTRO & ENDING** button or a **FILL IN** button on the panel to store the desired pattern at the cursor position. (An **INTRO** or **COUNT INTRO** can be stored only at the beginning.)
 - Store a rest by pressing a note value key without specifying a chord.

5. At the end of the chord progression, press the End key (—H).
 - This instrument exits the recording mode.
 - During playback, playback of the recorded chord progression stops at this point. For automatic repeat playback of the chord progression, press the Repeat key (↶↷) instead of the End key (—H).
 - When you play back the track for the CHORD part, the chords of the automatic accompaniment change in accordance with the stored chord progression.
 - Chords can also be specified with <one finger>.
 - If the ON BASS button is on, chords such as “C on G” can also be specified (except in the ONE FINGER mode).
 - The **CHORD FINDER** feature, which shows you how to finger a specified chord, is available. (Refer to page 50.)

■ Correct the recorded chord progression

1. Follow the procedure to select the STEP RECORD: CHORD display.
 2. Use the MEAS buttons to go to the measure you wish to modify. Use the ◀ and ▶ Correction keys to move the cursor to the point (*) you wish to edit.
 - The lengths of rests are indicated by the respective rest value × its multiplier.
- Example:
- ♩..... 1-beat rest (quarter rest)
 - ♪..... 1/2-beat rest (eighth rest)
 - ♩ × 1 + ♪ 1-1/2-beat rest (dotted quarter rest)
 - ♩ × 10..... 10-beat rest
- To go to the end of the chord progression, while pressing the Reset key (|♩—), press the ◀ key.

3. Correct the chord data.

Chord data

- When the chord name is displayed at the cursor position, you can press the **DELETE** key to erase the data and then store a new chord.
- If you do not erase the displayed data before entering new chord data, the new data is inserted at this point, and the displayed data is merely shifted by the note value of the new chord.
 - Rests can also be erased. Each time the **DELETE** key is pressed, the rest is erased in units of $\frac{1}{2} \times 1$. The ♪ rest is erased last.
 - If you wish to cancel the REPEAT, enter an END command.

Control data

The name of the stored function (INTRO, FILL, etc.) is displayed. You can press the **DELETE** key to erase the data which is displayed.

■ TRACK CLEAR

- To erase all data from the current track, press the CLR button, and then press the YES button on the confirmation display.
- If you wish to cancel the clear procedure, press the NO button.

Store a rhythm progression

Changes in the rhythm selection and tempo, as well as the intro, fill-ins and the ending, can be stored by measures with the step recording method.

1. On the SEQ MENU display, use the SONG ^ and v buttons to select the song number. Then select RECORD & EDIT.
2. On the RECORD & EDIT display, select STEP RECORD.
 - The display changes to the PART SELECT display.
3. Using the balance buttons below the display, select the track to which the RHYTHM (RHY) part has been assigned.
 - The display changes to the STEP RECORD: RHYTHM input display similar to the following.

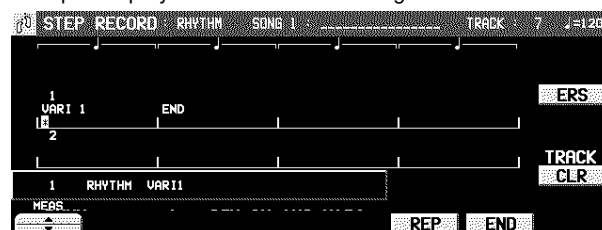

4. Use the MEAS ▲ and ▼ buttons to go to the measure you wish to record.
5. Store the rhythm data.
 - Data which can be stored:
 - START/STOP**
Changes in the rhythm selection
 - COUNT INTRO, INTRO, FILL IN, ENDING**
Tempo changes
 - Be sure to store the **START/STOP** data in the measure in which the rhythm starts or stops.
 - If you are storing a **COUNT INTRO** or **INTRO**, store this data before the **START/STOP** data.
 - If the tempo is changed, the display changes to the confirmation display. After specifying the desired tempo, Press the YES button to store the specified tempo, or press the NO button to cancel the new tempo value.
6. Repeat steps 4 and 5 to continue storing the rhythm progression.
7. At the end of the rhythm progression, press the END button.
 - If the REP button is pressed instead of the END button, during playback the recorded rhythm progression is repeated.
 - This instrument exits the recording mode.

■ Correct the recorded rhythm progression

1. Follow the procedure to select the STEP RECORD: RHYTHM display.
2. Use the MEAS buttons to go to the measure you wish to modify. (The * is highlighted.)
3. Correct the rhythm data.
 - Press the ERS button to erase data at the cursor position.
 - If you wish to cancel the REPEAT, enter an END command.
 - If you select a rhythm with a different time signature, the time signature of all subsequent measures will also change.
 - If data has already been recorded in other tracks, you cannot select a rhythm with a different time signature.

■ TRACK CLEAR

- To erase all data from the current track, press the CLR button, and then press the YES button on the confirmation display.
- If you wish to cancel the clear procedure, press the NO button.

Track Assign

Each **SEQUENCER** part is already assigned to a track number. However, you can use the TRACK ASSIGN function to assign parts to tracks as you wish.

1. On the SEQ MENU display, use the SONG \wedge and \vee buttons to select the song number. Then select RECORD & EDIT.
2. On the RECORD & EDIT display, select TRACK ASSIGN.
 - The display looks similar to the following.

TRACK ASSIGN	LOCAL CONT.	MIDI OUT	TRACK ASSIGN	LOCAL CONT.	MIDI OUT
TR 1	RIGHT1	ON	TR 9	PART 5	ON
TR 2	RIGHT2	ON	TR10	PART 6	ON
TR 3	LEFT	ON	TR11	PART 7	ON
TR 4	PART 4	ON	TR12	PART 8	ON
TR 5	CHORD	---	TR13	PART 9	ON
TR 6	CONTROL	ON	TR14	PART 11	ON
TR 7	RHYTHM	ON	TR15	PART 12	ON
TR 8	DRUMS	ON	TR16	PART 13	ON

3. Use the TR \blacktriangle and \blacktriangledown buttons to select the track.
4. Use the TRACK ASSIGN \wedge and \vee buttons to select the part for the specified track.
 - When a part other than the CONTROL, APC, CHORD or RHYTHM part is assigned, the track assign procedure is completed at this point.
 - Either the CHORD part or APC part can be assigned to a track, but not both.
 - The CONTROL, APC, CHORD and RHYTHM parts cannot be assigned to more than one track.
 - You can use the ON and OFF buttons for LOCAL CONT. to specify whether or not the sound of the part assigned to this track is generated. Because no sound is generated for this instrument's parts assigned to tracks set to OFF through this procedure, use this setting to generate sound from an external sound source through the MIDI connectors.
 - You can use the MIDI OUT ON and OFF buttons to specify whether or not the data of the part assigned to this track is sent as MIDI data. When set to OFF, the data is not sent, even if MIDI equipment is connected.
5. When assigning the CONTROL, APC, CHORD or RHYTHM part, press the OK button.

■ TRACK ASSIGN PRESET

A preset track assignment can be selected.

1. On the TRACK ASSIGN display, press the PRESET button.
 - The display looks similar to the following.



2. Use the SONG \wedge and \vee buttons to select the song number for which the preset track assignment will be effective.
 - If ALL SONGS is selected, the track assignment is effective for all the songs.
3. Select the track assign mode.
 - INITIAL:
Factory-preset settings.
 - TECHNICS MULTI RECORDING:
The optimum track assignment for multiplex recording.
 - GM MULTI RECORDING:
The optimum track assignment for creating GENERAL MIDI data.
4. Press the OK button.
 - "COMPLETED!" is shown on the display and the selected track assign mode is enabled.
 - You can confirm the track assignment settings on the TRACK ASSIGN display.

Quantize

The QUANTIZE function can correct the timing of your performance after it has been recorded. If the rhythm is slightly out of sync or inexact, it will automatically be corrected to the specified quantize level.

1. On the SEQ MENU display, select RECORD & EDIT.

2. On the RECORD & EDIT display, select QUANTIZE.

- The display looks similar to the following.

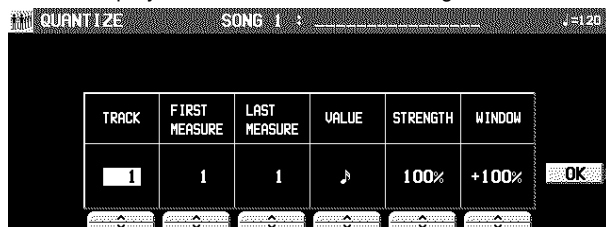

Rhythm as written in the score



Timing of actual performance



Quantized performance



3. Use the TRACK ^ and v buttons to specify the track number.

- You cannot select the track for the CONTROL, RHYTHM or CHORD part.
- If ALL is selected, all the tracks are quantized.

4. Use the FIRST MEASURE ^ and v buttons to specify the start point (measure number).

5. Use the LAST MEASURE ^ and v buttons to specify the end point (measure number).

6. Use the VALUE ^ and v buttons to specify the quantize level.

- Select from ♩, ♪, ♫, ♮, ♯, ♭, ♭♭, ♯♯.

(A 3 denotes a triplet-type note.)

7. Use the STRENGTH ^ and v buttons to select the amount of quantize (%).

- 100% is a convenient setting. When set to 100%, the performance data is quantized exactly to the level specified for the VALUE ("just"). For example, at 50%, the data is quantized to a point that is half that of the just level. By this setting, you can attain an effect that is very slightly off-beat from the rhythm.

8. Use the WINDOW ^ and v buttons to specify the range (%) affected by the quantize setting.

- With the increment set to 100 for the VALUE, at a + setting, data close to the just point is corrected, and at a - setting, data far from the just point is corrected. For example, if set to -30% the quantize function affects data far from the just point, and if set to +30% the quantize function affects data close to the just point. +100% is usually a convenient setting.
- The +100% setting and the -100% setting are the same.

Example: When VALUE is set to ♩

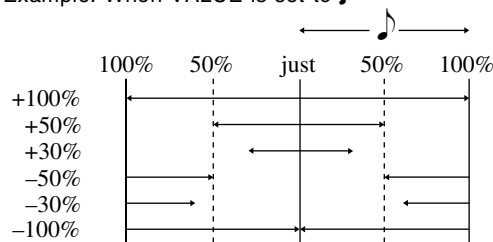

9. Press the OK button.

- The confirmation display appears. Press the YES button to execute the function, or press the NO button to cancel the function.

Song Clear

Erase the recorded contents of all tracks.

1. On the SEQ MENU display, select RECORD & EDIT.

2. On the RECORD & EDIT display, select SONG CLEAR.

- The display looks similar to the following.



3. Use the SONG No./ALL ^ and v buttons to specify the number of the song to erase.

- The data size (KB) and the total amount of **SEQUENCER** memory or current song memory used is shown as a percentage (%) to the right of the song name.
- If ALL SONGS is selected, all the songs recorded in the **SEQUENCER** will be erased.

4. Press the OK button.

- The confirmation display appears. Press the YES button to execute the function, or press the NO button to cancel the function.
- If the YES button is pressed, "COMPLETED!" appears on the display, the specified songs are erased.

Track Clear

Erase the contents of a specific track.

1. On the SEQ MENU display, select RECORD & EDIT.
2. On the RECORD & EDIT display, select TRACK CLEAR.
 - The display looks similar to the following.



3. Use the balance buttons to select the track or tracks you wish to clear.
 - A "CLR" mark is shown for the selected tracks.

4. Press the OK button.
 - The confirmation display appears. Press the YES button to execute the function, or press the NO button to cancel the function.
 - If the YES button is pressed, the specified tracks are erased.

Note Edit

You can edit performance (NOTE) data on a piano roll display. This differs from the normal STEP RECORD edit procedure, and is a convenient way to check the data for each note.

- Data other than NOTE data cannot be corrected or recorded. To correct or record other types of data, use the STEP RECORD display. (Refer to page 71.)

1. On the SEQ MENU display, select RECORD & EDIT.
2. On the RECORD & EDIT display, select NOTE EDIT.
3. On the PART SELECT display, select a track.
 - The CHORD, RHYTHM and CONTROL tracks cannot be selected.
 - The display looks similar to the following.

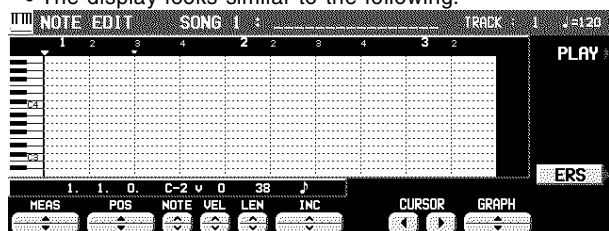

4. Use the MEAS ▲ and ▼ buttons to select the measure you wish to edit.
5. Use the CURSOR ◀ and ▶ buttons to move the cursor (▼) to the point you wish to edit.
 - Recorded performance (NOTE) data is shown as horizontal bars. Data selected for editing is highlighted.
 - You can use the INC ▲ and ▼ buttons to change the increment of cursor movement. The resolution can be set at 1/96. However, if NOTE data is present between increments, the cursor will stop.
 - Use the POS ▲ and ▼ buttons to change the value. Example: 10.2.48 indicates a point in measure 10, beat 2, point 48 (one point is 1/96 of a quarter note [♪]).
 - ▬ is shown at the point where the END command is stored.

6. Select the data to edit (it changes to a highlighted horizontal bar). Edit the data.
 - Use the POS ▲ and ▼ buttons to move the cursor, the NOTE ▲ and ▼ buttons to change the note number, the VEL ▲ and ▼ buttons to change the velocity (how hard the keys are played), and the LEN ▲ and ▼ buttons to change the note length (1 = 1/96 of a quarter note [♪]).
 - Use the GRAPH ▲ and ▼ buttons to view a higher or lower section of the keyboard (in one-octave steps).
 - If the ERS button is pressed, the selected NOTE data is erased.

7. Repeat steps 4 to 6 to continue editing.

■ Inserting note data

You can also store note data on this display.

1. Specify the point where the new note data will be stored.
2. Use the LEN ▲ and ▼ buttons to specify the note length.
 - Examples of note lengths (♪ = 96)
 - 91: tenuto (95%)
 - 76: normal (80%)
 - 48: staccato (50%)
 - 24: cutting (25%)
3. Play a key on the keyboard to specify the note pitch (NOTE NUMBER) and velocity (how hard the key is played).
4. Repeat steps 1 to 3 to input more note data.

■ CYCLE PLAY

You can aurally check the data you are editing by accessing the CYCLE PLAY display from the NOTE EDIT display.

- If you wish other tracks to be played back, they should be selected beforehand on the SEQUENCER PLAY display. (Refer to page 67.)

1. On the NOTE EDIT display, press the PLAY button.

- The display looks similar to the following.

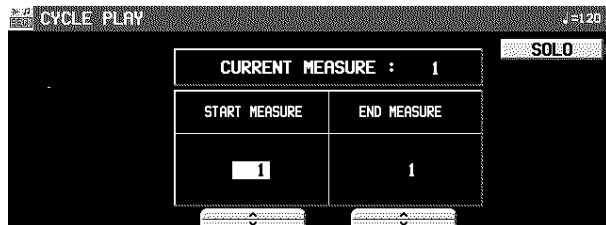

2. Use the START MEASURE \wedge and \vee buttons to select the beginning playback measure.

3. Use the END MEASURE \wedge and \vee buttons to select the last playback measure.

4. Press the **START/STOP** button.

- Cycle playback of the specified measures begins.
- If the SOLO button is turned on, playback changes to that of the recording track only. If it is turned off, all the tracks specified on the SEQUENCER PLAY display are played back.

5. To stop cycle playback, press the **START/STOP** button again.

- During playback stop, if the **SEQUENCER RESET (FILL IN 1)** button is pressed, the **SEQUENCER** returns to the measure number specified in step 2. If the **SEQUENCER RESET** button is pressed again, the **SEQUENCER** returns to measure 1.

Drum Edit

The DRUMS part can be edited on a specialized display. This differs from the normal STEP RECORD edit procedure, and is a convenient way to check the data for each note.

1. On the SEQ MENU display, select RECORD & EDIT.

2. On the RECORD & EDIT display, select DRUM EDIT.

3. On the PART SELECT display, select the track for the DRUMS part.

- The CHORD, RHYTHM and CONTROL tracks cannot be selected.
- The display looks similar to the following.

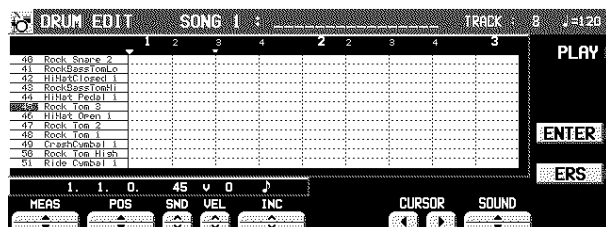

4. Use the SOUND \blacktriangle and \blacktriangledown buttons to select the percussion instrument you wish to edit.

- The number to the left of the instrument name is its MIDI NOTE NUMBER in the Technics arrangement.
- If sounds other than percussion instrument sounds are assigned, they are not displayed.

5. Use the MEAS \blacktriangle and \blacktriangledown buttons to select the measure you wish to edit.

6. Use the CURSOR \blacktriangleleft and \blacktriangleright buttons to move the cursor (\blacktriangledown) to the point you wish to edit.

- Recorded performance data is shown as vertical bars. Data selected for editing is highlighted.
- You can use the INC \wedge and \vee buttons to change the increment of cursor movement. The resolution can be set at $\downarrow/96$. However, if NOTE data is present between increments, the cursor will stop.

- Use the POS \wedge and \vee buttons to change the value. Example: 10.2.48 indicates a point in measure 10, beat 2, point 48 (one point is 1/96 of a quarter note [\downarrow]).
- \blacktriangledown is shown at the point where the END command is stored.

7. Select the data to edit (it changes to a long bar). Edit the data.

- Use the POS \blacktriangle and \blacktriangledown buttons to move the cursor, the SND \wedge and \vee buttons to change the percussion instrument sound, and the VEL \wedge and \vee buttons to change the velocity (how hard the keys are played).
- If the ERS button is pressed, the selected NOTE data is erased.

8. Repeat steps 2 to 5 to continue editing.

■ Inserting DRUMS data

You can also store DRUMS data on this display.

1. Specify the point where the new note data will be stored.

2. Use the VEL \wedge and \vee buttons to specify the velocity (how hard the key is played).

3. Press the ENTER button to store the data.

- Instead of the ENTER button, you can store data (including velocity data) by playing the keyboard. In this case, the instrument is that specified on the display, regardless of which key is played.

4. Repeat steps 1 to 3 to input more DRUMS data.

■ CYCLE PLAY

You can aurally check the data you are editing by accessing the CYCLE PLAY display from the DRUM EDIT display.

- The procedure is the same as for NOTE EDIT.
- If you wish other tracks to be played back, they should be selected beforehand on the SEQUENCER PLAY display. (Refer to page 67.)

Copy and paste the recorded data

You can copy and paste specific portions of the recorded data.

Select the function

1. On the SEQ MENU display, use the SONG \wedge and \vee buttons to select the number of the song. Then select COPY & PASTE.

- The display looks similar to the following.



2. On the COPY & PASTE display, select a function.

3. Perform the editing procedures. (See below.)

- During the editing procedure, if the indicator for the **TEMPO/PROGRAM** is lit, you can use the **TEMPO/PROGRAM** for the editing function.

SONG COPY

Copy all the recording data of a song to a specific song memory.

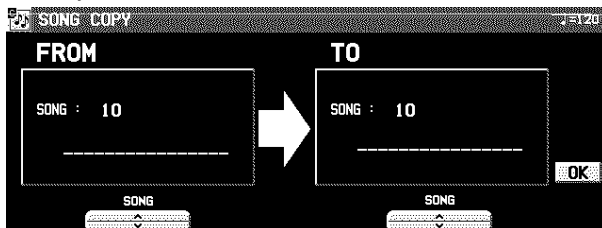

1. On the FROM side, use the \wedge and \vee buttons to select the song number you wish to copy from.

2. On the TO side, use the \wedge and \vee buttons to select the song number to copy to.

3. Press the OK button.

- The confirmation display appears. Press the YES button to execute the function, or press the NO button to cancel the function.

TRACK COPY

Copy the recorded data from specific tracks of a song.

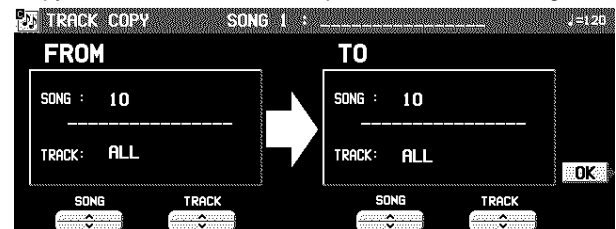

1. Specify the track you wish to copy from.

- On the FROM side, use the SONG \wedge and \vee buttons and TRACK \wedge and \vee buttons to specify a track.
- If ALL is selected, all the tracks of the specified song number will be copied.

2. Specify the track you wish to copy to (TO side).

3. Press the OK button.

- The confirmation display appears. Press the YES button to execute the function, or press the NO button to cancel the function.

- The track assignment settings are also copied. Note that in some cases, the CONTROL, RHYTHM and CHORD part data in the destination tracks may be lost.

TRACK MERGE

Merge the recorded contents of two tracks (source tracks) and store the merged contents in a third track (destination track).

- When the TRACK MERGE function is executed, the data is erased from the two source tracks.



1. Select the two source tracks (FROM).

- On the FROM side, use the TRACK \wedge and \vee buttons to select the two source tracks.
- You cannot select the track to which the CONTROL, RHYTHM or CHORD part has been assigned.
- If the part assigned to the left source track ("left" meaning its position on the TRACK MERGE display) is different from the part assigned to the right source track, when the parts are merged in the destination track, the new track is assigned the same part as the left track.

2. Select the destination track (TO).

- Use the TRACK \wedge and \vee buttons to the right of the display to specify the track number.

3. Press the OK button.

- The confirmation display appears. Press the YES button to execute the function, or press the NO button to cancel the function.

MEASURE COPY

Copy recorded data of specified measures to a specified point.

- On the destination track, the new data replaces the current measure contents.

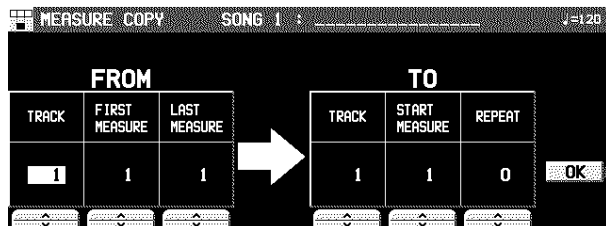

1. Specify the measures you wish to copy from the source track (FROM).

- On the FROM side, specify the settings with the corresponding buttons.

TRACK: Specify the track number you wish to copy the measures from.

- You cannot select the track for the RHYTHM part or CHORD part in which a repeat command has been stored.
- If ALL is selected, the specified measures are copied to all tracks at the same time.

FIRST MEAS: Specify the first measure to copy.

LAST MEAS: Specify the last measure to copy.

2. Specify where you wish to copy the selected measures to.

- On the TO side, specify the settings with the corresponding buttons.

TRACK: Specify the track number you wish to copy to.

- Measures in a track for the CONTROL, RHYTHM or CHORD part can be copied only to the same track.

START MEAS: Specify the start point to copy the selected measures to.

REPEAT: Specify the number of times the selected measures are to be repeated.

3. Press the OK button.

- The confirmation display appears. Press the YES button to execute the function, or press the NO button to cancel the function.
- Note that if the END command is included in the source data, it is also copied. Any data following the END command is not copied.

MEASURE DELETE

Delete specified measures from a track.

- The length of the performance accordingly decreases by the number of deleted measures.

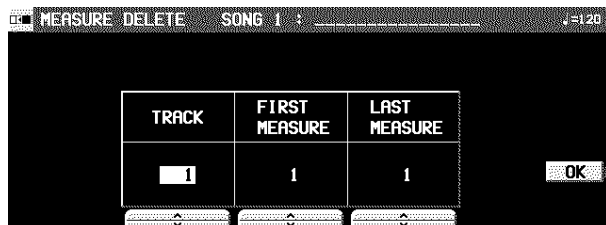

1. Use the TRACK ^ and v buttons to select the track from which measures are to be deleted.

- This function does not work for the CHORD or RHYTHM track in which the repeat function has been stored.
- If ALL is selected, the specified measures are deleted from all the tracks at one time.

MEASURE ERASE

Erase the recorded contents of specific measures. You can also specify which type of data is to be erased.

- Note that only the contents of the measures are erased, not the measures themselves; the length of the performance remains the same.

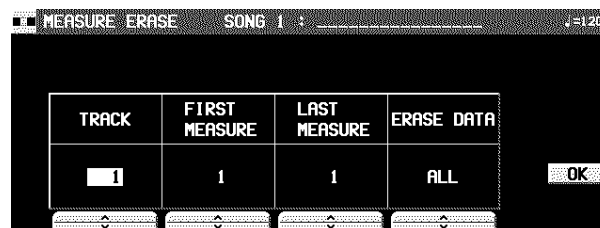

1. Use the TRACK ^ and v buttons to specify the track number.

- This function does not work for the RHYTHM part or CHORD part in which a repeat command has been stored.
- If ALL is selected, data is erased from the specified measures of all the tracks at one time.

2. Use the FIRST MEASURE ^ and v buttons to specify the start point (measure number).

3. Use the LAST MEASURE ^ and v buttons to specify the end point (measure number).

4. Use the ERASE DATA ^ and v buttons to specify the type of data to be erased.

ALL: All data is erased.

NOTE: Only note data is erased.

CONTROL: Only control data (volume, effect and other panel settings as well as selection changes) is erased.

5. Press the OK button.

- The confirmation display appears. Press the YES button to execute the function, or press the NO button to cancel the function.

2. Use the FIRST MEASURE ^ and v buttons, to specify the first measure to delete.

3. Use the LAST MEASURE ^ and v buttons to specify the last measure to delete.

4. Press the OK button.

- The confirmation display appears. Press the YES button to execute the function, or press the NO button to cancel the function.

MEASURE INSERT

Insert specified measures at a specified point.

- The length of the performance accordingly increases by the number of inserted measures.

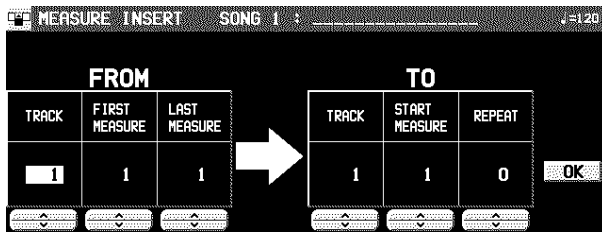

1. Specify the measures you wish to copy from the source track.

- On the FROM side, specify the settings with the corresponding buttons.

TRACK: Specify the track number you wish to copy the measures from.

- This function does not work for the CHORD or RHYTHM track in which the repeat function has been stored.
- If ALL is selected, the measures are inserted in all tracks at the same time.

FIRST MEAS: Specify the first measure to copy.

LAST MEAS: Specify the last measure to copy.

2. Specify where you wish to insert the selected measures.

- On the TO side, specify the settings with the corresponding buttons.

TRACK: Specify the track number.

- Measures from the CHORD, RHYTHM or CONTROL track can only be inserted in the same track.

START MEAS: Specify the start point to insert the selected measures.

REPEAT: Specify the number of times the selected measures are to be repeated.

3. Press the OK button.

- The confirmation display appears. Press the YES button to execute the function, or press the NO button to cancel the function.
- Note that if the END command is included in the source data, it is also inserted. Any data following the END command is not inserted.

APC TO SMF CONVERT

When a sequence is recorded using **AUTO PLAY CHORD**, the **SEQUENCER** data just contains a chord sequence on one track. APC TO SMF CONVERT creates a sequencer file in which the APC/CHORD/RHYTHM/CONTROL parts and **PIANO PERFORMANCE PADS (PR804)** phrases are each recorded on a separate track, allowing you to save the sequence in standard MIDI File format for playback on other instruments.

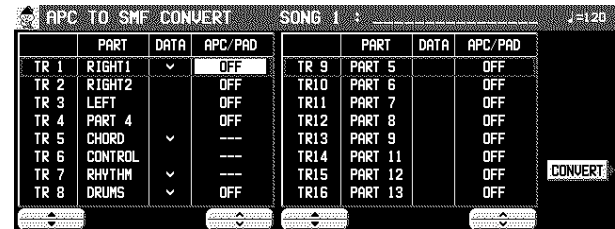

1. Use the TR ▲ and ▼ buttons to select the track you wish to convert.

- In the PART column, the part name currently assigned is shown.
- In the DATA column, a check mark (✓) indicates a track in which data is stored.
- Tracks in which RHYTHM, CONTROL, APC and CHORD parts are stored cannot be selected (--- is shown).

2. Use the APC/PAD ^ and v buttons to select the parts you wish to convert.

- Parts that are set to OFF will not be converted.

3. Press the CONVERT button.

- Note that after the conversion, the automatic accompaniment part data is cleared; if necessary, save this data beforehand.
- A confirmation display appears.

4. Press EXECUTE to continue with the conversion, or press the CANCEL button if you wish to discontinue.

- After the EXECUTE button is pressed, the conversion begins. Conversion takes the same length of time as playback.
- If you wish to discontinue the conversion process midway, press the ABORT button.

Changing the note position etc. of the recorded data

You can change the note pitch and position etc. of recorded data.

Select the function

1. On the SEQ MENU display, use the SONG ^ and v buttons to select the number of the song. Then select RANGE EDIT.

- The display looks similar to the following.

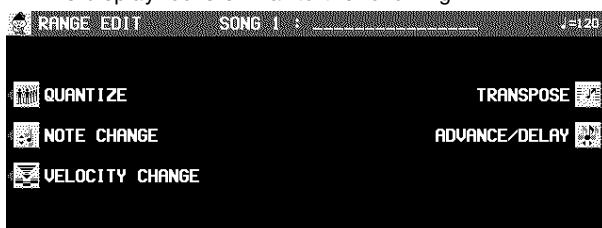

2. On the RANGE EDIT display, select a function.

3. Perform the editing procedures. (See below.)

- During the editing procedure, if the indicator for the **TEMPO/PROGRAM** is lit, you can use the **TEMPO/PROGRAM** for the editing function.

VELOCITY CHANGE

Modify the recorded velocity in specific measures of specific tracks.

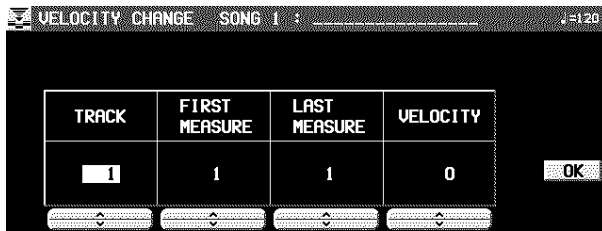

- Use the TRACK \wedge and \vee buttons to select the track you wish to edit.
 - You cannot select the track for the CONTROL, RHYTHM or CHORD part.
 - If ALL is selected, all tracks will be edited.
- Use the FIRST MEASURE \wedge and \vee buttons to specify the start point (measure number) of the velocity change.
- Use the LAST MEASURE \wedge and \vee buttons to specify the end point (measure number) of the velocity change.
- Use the VELOCITY \wedge and \vee buttons to specify the change in velocity.
 - The value you select will be added to or deleted from the current velocity.
- Press the OK button.
 - The confirmation display appears. Press the YES button to execute the function, or press the NO button to cancel the function.

TRANPOSE

Change of key of specific measures of specific tracks.

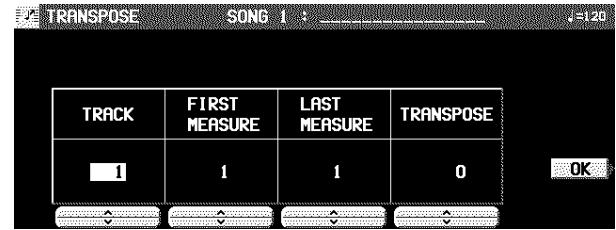

- Use the TRACK \wedge and \vee buttons to select the track you wish to edit.
 - You cannot select the track for the CONTROL, RHYTHM or CHORD part.
 - If ALL is selected, all tracks will be edited.
- Use the FIRST MEASURE \wedge and \vee buttons to specify the start point (measure number) of the transpose.
- Use the LAST MEASURE \wedge and \vee buttons to specify the end point (measure number) of the transpose.
- Use the TRANPOSE \wedge and \vee buttons to specify the change in pitch.
 - Increments are in semitones. A value of 12 is one octave. A - value lowers the pitch, and a + value raises it.
- Press the OK button.
 - The confirmation display appears. Press the YES button to execute the function, or press the NO button to cancel the function.

NOTE CHANGE

Change of pitch of specified notes.



- Use the TRACK \wedge and \vee buttons to select the track you wish to edit.
 - You cannot select the track for the CONTROL, RHYTHM or CHORD part.
 - If ALL is selected, all tracks will be edited.
- Use the FIRST MEASURE \wedge and \vee buttons to specify the start point (measure number) of the note change.
- Use the LAST MEASURE \wedge and \vee buttons to specify the end point (measure number) of the note change.
- Use the TARGET NOTE \wedge and \vee buttons to specify the pitch of the note you wish to change.
 - The number next to the note name is its note number.

- Use the CHANGE TO \wedge and \vee buttons to specify the pitch you wish to change to.
- Press the OK button.
 - The confirmation display appears. Press the YES button to execute the function, or press the NO button to cancel the function.

ADVANCE/DELAY

Speed up or delay the sound production of specified performance data.

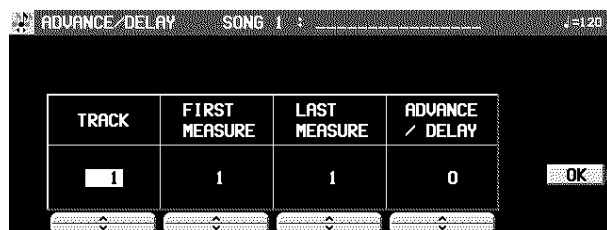

- Use the TRACK \wedge and \vee buttons to select the track you wish to edit.
 - You cannot select the track for the CONTROL, RHYTHM or CHORD part.
 - If ALL is selected, all tracks will be edited.
- Use the FIRST MEASURE \wedge and \vee buttons to specify the start point (measure number) of the change.
- Use the LAST MEASURE \wedge and \vee buttons to specify the end point (measure number) of the change.
- Use the ADVANCE/DELAY \wedge and \vee buttons to accelerate or delay the timing of the sound production (-96 to +96).
 - A + value causes the notes to sound later, and a - value causes the notes to sound earlier.
- Press the OK button.
 - The confirmation display appears. Press the YES button to execute the function, or press the NO button to cancel the function.

Part V Composer

Outline of the Composer

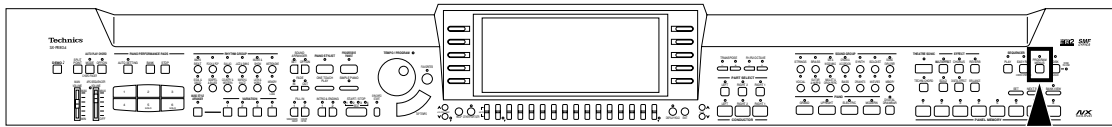

The **COMPOSER** enables you to create your own accompaniment patterns. A pattern is comprised of 8 parts: **DRUMS 1, 2, BASS** and **ACCOMP1-5** parts. These parts would form the backing of a song.

Rhythm components which can be stored

Different **INTRO 1, 2, VARIATION 1 to 4, ENDING 1, 2** patterns can be created for each **MEMORY (A, B, C)**.

- Each **VARIATION** is made of a **PATTERN, FILL 1** and **FILL 2**.
- A **Maj (major)** and **Min (minor)** pattern is available for each of the **INTRO** and **ENDING 1** and **2**.

INTRO	VARI 1	VARI 2	VARI 3	VARI 4	ENDING
1 Maj	PATTERN	PATTERN	PATTERN	PATTERN	1 Maj
1 Min	FILL IN 1	FILL IN 1	FILL IN 1	FILL IN 1	1 Min
2 Maj	FILL IN 2	FILL IN 2	FILL IN 2	FILL IN 2	2 Maj
2 Min					2 Min

- The patterns in the table above can be created for each **MEMORY (A, B, C)**.

Memory capacity

Expressed in terms of notes, the total number of notes which can be stored in all the **COMPOSER** memories is about 13,000. The remaining memory available for recording is shown on the recording display as a percentage (%).

- When "Memory full!" appears on the display no more data can be stored in the **COMPOSER**.

■ MEMORY

Because the contents of the **MEMORY** are erased after about 80 minutes after the power is turned off, you should save the data on floppy disks if you wish to keep it. (Refer to page 99.)

COMPOSER menu

1. Press the **PROGRAM MENUS** button to turn it on.

- The display looks similar to the following.



2. Select **COMPOSER**.

- The display looks similar to the following.



Summary of the COMPOSER menu items

RECORDING MEMORY-A

Create a memory in the **MEMORY A** bank.

RECORDING MEMORY-B

Create a memory in the **MEMORY B** bank.

RECORDING MEMORY-C

Create a memory in the **MEMORY C** bank.

PATTERN COPY (page 92)

Copy a rhythm/**COMPOSER** pattern into a memory.

SEQ TO COMPOSER COPY (page 93)

Copy recorded data in the **SEQUENCER** to the **COMPOSER**.

LOAD SINGLE COMPOSER

Recall the desired **COMPOSER** data from data saved on a disk. This procedure is the same as when **COMPOSER** is selected for **SINGLE LOAD**. (Refer to page 96.)

Three ways to record in the COMPOSER

There are three ways to create and record a rhythm.

Simple recording method

Use EASY COMPOSER to quickly create a unique rhythm just by selecting a pattern for each part.

Create a completely new rhythm

Compose all the parts of a completely new rhythm from scratch.

- You can use either realtime recording or step record for any part of the recording.

Pattern Copy (page 92)

Copy a preset rhythm or **SEQUENCER** data to a **COMPOSER** memory, edit it as you like, and then store it as a new rhythm.

Simple recording method

With EASY COMPOSER you can easily create a unique rhythm pattern by selecting a different style for each part of the rhythm.

- On the COMPOSER MENU display, select EASY COMPOSER.

- The display looks similar to the following.

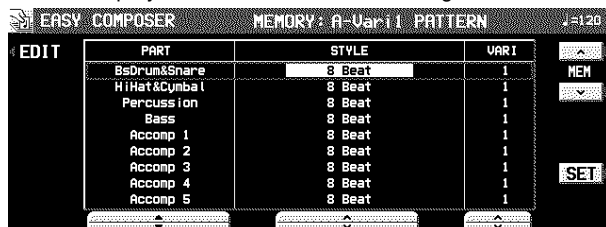

- Use the MEM \wedge and \vee buttons to select the memory in which to record your rhythm.

- Select from A-vari 1 to 4, B-vari 1 to 4 and C-vari 1 to 4.

- Use the PART \blacktriangle and \blacktriangledown buttons to select the part.

- In the EASY COMPOSER, the new rhythm pattern is divided into 9 parts, to each of which a style and variation is assigned.

- Use the STYLE \wedge and \vee buttons to select a style.

- Use the VARI \wedge and \vee buttons to select the variation number.

- The number of variations differs depending on the selected style.
- A part which is set to OFF does not sound. Note that the "BsDrum&Snare" part cannot be set to OFF.

- Repeat steps 3 to 5 to select styles for the other parts.

- Press the SET button.

- The rhythm pattern is played back.
- If you are not satisfied with the rhythm pattern, repeat steps 3 to 7.
- If you wish to correct the sounds or phrases in your rhythm pattern, press the EDIT button. The display changes to the recording display.

- For playback, refer to page 89.

Create a completely new rhythm

Clear the memories and compose a completely new rhythm from scratch.

- You can also use this method when copying a pattern from a preset rhythm or the **SEQUENCER**.

Prepare to record

- On the COMPOSER MENU display, select a memory in which to record (RECORDING MEMORY A, B, or C).

- The display looks similar to the following.



- Use the buttons below the display to select the pattern you want to create.

- If the MEM CLR button is pressed, all the current contents of the MEMORY are erased (a confirmation display appears).

- You can press the NAMING button and assign a name to the MEMORY.



- To assign a name to each VARIATION, press the VARI button and select a number.

3. On the RECORD MEMORY display, press the OK button.

- The display looks similar to the following.

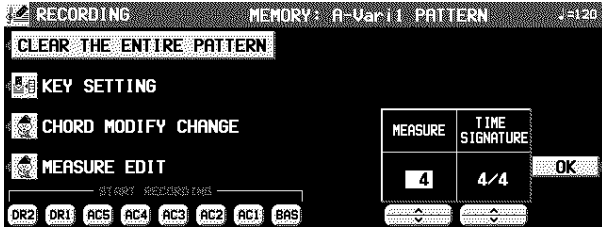

4. Press the CLEAR THE ENTIRE PATTERN button.

- The display looks similar to the following.

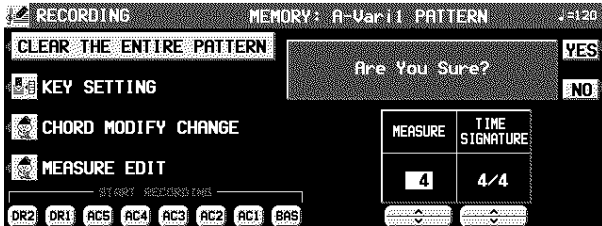

5. Press the YES button.

- All the data for the selected pattern is erased.

KEY SETTING

Set the key and chord in which you wish the recorded pattern to be played. If the recorded performance is played in a key or chord different from this setting, the automatic accompaniment will not be able to distinguish the correct chord.

1. On the RECORDING display press the KEY SETTING button.

- The display looks similar to the following.

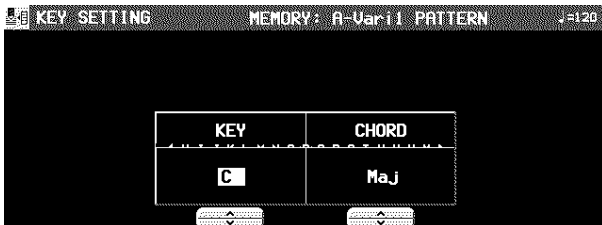

2. Use the KEY ^ and v buttons to set the key. Use the CHORD ^ and v buttons to set the chord type (Maj/Min).

3. When you have finished making the settings, press the EXIT button.

6. Use the MEASURE ^ and v buttons to specify the number of measures in your new rhythm pattern (1 to 16).

7. Use the TIME SIGNATURE ^ and v buttons to specify the meter of the pattern (1/4 to 8/4).

- When the settings for the MEASURE and TIME SIGNATURE of the INTRO or ENDING patterns are changed, the Maj and Min settings change at the same time.

8. Press the OK button.

Recording procedure

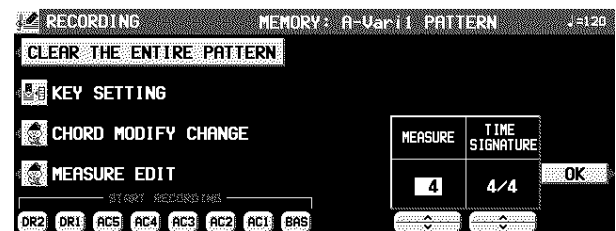

1. In the START RECORDING area on the display, select the rhythm part you want to record first.

BAS: BASS
AC1-5: ACCOMP 1-5
DR1, 2: DRUMS 1, 2

- The metronome sound starts and the display looks similar to the following.

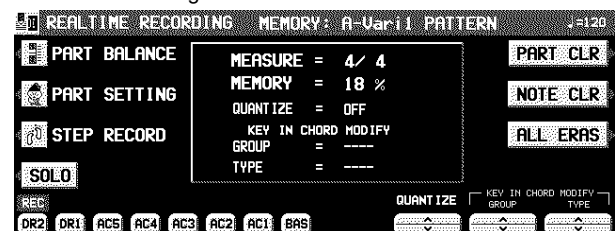

2. Adjust the tempo.

- The tempo is shown on the display as ♩ =.
- The tempo can be freely adjusted when you play back the rhythm pattern, so record at the tempo which is easiest for you to play.

3. Select the sound.

- For the DRUMS part, only sounds from the DRUM KITS sound group can be selected.
- For the ACCOMP and BASS parts, select sounds from groups other than the DIGITAL DRAWBAR sound groups.

(continued on the next page)

4. Record the part.



- The specified number of measures are repeatedly played back, during which time any newly played notes are added to those already recorded. The current measure number is shown on the display as "MEASURE=".
- Record the performance in C major for correct chord progressions during playback. Follow the KEY SETTING procedure if you wish to record the performance in a different scale.
- The sustain pedal operation or PITCH BEND and MODULATION effects when MIDI data is received are also recorded (except for the **DRUMS** part).

■ Button functions

PART BALANCE:

Adjust the volume of each part on the PART BALANCE display. (These settings are not recorded.)

- The METRONOME volume setting can be adjusted on the PAGE 2/2 display.

PART SETTING:

You can make detailed settings for each part. (Refer to page 89.)

STEP RECORD:

Change to the STEP RECORD mode. (Refer to page 90.)

PART CLR:

Erase all recorded contents of the currently selected part.

NOTE CLR:

Data is erased one note or one percussion instrument (DRUMS part) sound at a time.

- Hold and press this button, and press the keyboard key that corresponds to the note or percussion instrument (DRUMS part) sound you wish to erase.

ALL ERAS:

The performance recorded in the selected part is erased for as long as this button is pressed.

QUANTIZE:

Smooth out any unevenness in the timing of your performance.

- Before recording, select the note value for the desired quantize level. (The quantize level is shown on the display as QTZ=.)

SOLO:

Mute all parts except the part which is currently being recorded.

- A MUTE mark is shown for the other parts on the display.
- To turn off the SOLO function, press this button again.

KEY IN CHORD MODIFY (except for INTRO, ENDING, DRUMS):

Use the GROUP and TYPE \wedge and \vee buttons to select the type of pattern progression.

- This setting is for the sound that is going to be recorded from this time.

5. Use the buttons below the display to switch to a different recording part, and proceed to record each part in turn.

6. When you have finished recording the rhythm, turn off the **PROGRAM MENUS** button.

Chord Modify Change

For data that has already been recorded, you can select the type of pattern progression for the bass and accomp parts.

- This function cannot be used for the INTRO and ENDING patterns.

1. On the RECORDING display, press the CHORD MODIFY CHANGE button.

- The display looks similar to the following.

CHORD MODIFY CHANGE			
PART	GROUP	CHORD MODIFY TYPE	FUNCTION
BASS	Melody	Basic	KEEP
ACCOMP1	Melody	In 7th G+B \triangleright	KEEP
ACCOMP2	Melody	In 7th G+B \triangleright	KEEP
ACCOMP3	Melody	In 7th G+B \triangleright	KEEP
ACCOMP4	Melody	In 7th G+B \triangleright	KEEP
ACCOMP5	Melody	In 7th G+B \triangleright	KEEP

2. Use the PART \blacktriangle and \blacktriangledown buttons to select the part you wish to set.

3. Use the GROUP and MODIFY TYPE \wedge and \vee buttons to select the corresponding progression type.

- If a progression type for which the note name is displayed (in C key) was selected for the chord group, played notes which are not displayed are changed to notes which are displayed.

4. Use the FUNCTION \wedge and \vee buttons to enable or disable the function.

KEEP: No change.

CHANGE: The change is enabled.

5. When you have finished making the settings for each part, press the OK button.

6. Press the **EXIT** button.

Part Setting

You can make detailed settings for each part.

- On the **REALTIME RECORDING** display, press the **PART SETTING** button.
 - The settings comprise three pages of the display. Use the **PAGE** buttons to switch pages.
- Use the **PART ▲** and **▼** buttons to select a part.
- Use the **∧** and **∨** buttons to set the corresponding item.

<PAGE 1>

PART	PITCH POINT	SOUND	DIGI EFF	BALANCE	PAN	BEND RANGE
DRUM1	--	Standard Kit1	---	-15	---	12
DRUM2	--	Standard Kit1	---	-15	---	12
BASS	Eb	Jazz E. Bass	(SOUND)	-18	CENTER	12
ACCOMP1	Ab	Folk Guitar	(SOUND)	-61	LEFT 25	12
ACCOMP2	Ab	Folk Guitar	(SOUND)	-39	RIGHT 25	12
ACCOMP3	Ab	Ac. Gtr. Harmonics	(SOUND)	-35	CENTER	12
ACCOMP4	Ab	Bossa Guitar	(SOUND)	-27	CENTER	12
ACCOMP5	Ab	Piano	(SOUND)	0	CENTER	12

PITCH POINT:

The pitch at which the pattern progression sound is lowered by one octave.

- When the root note of the specified chord is higher than the set pitch point, the pitch of that part is automatically lowered by one octave, thus avoiding an unnaturally high accompaniment pitch.
- This is effective only for the part for which the Melody group was selected in **CHORD MODIFY CHANGE**.

SOUND:

Use the panel buttons to select the sound.

DIGI EFF:

Set the **DIGITAL EFFECT** to on or off.

- (SOUND) is the initialized setting of the sound.

BALANCE:

Adjust the volume balance.

PAN:

Adjust the stereo balance of each part (LEFT 64 – CENTER – RIGHT 63).

- At “LEFT 64”, the sound is all the way to the left, at “RIGHT 63” all the way to the right. The center point is CENTER.

BEND RANGE:

Adjust the range of pitch change when PITCH BEND data is received (0 to 12).

<PAGE 2>

PART	EQ-Hi Fc	EQ-Hi Gain(dB)	EQ-Low Fc	EQ-Low Gain(dB)	REV	CHO
DRUM1	10kHz	+0.5	100Hz	+0.0	44	0
DRUM2	10kHz	+0.0	100Hz	+0.0	78	0
BASS	10kHz	+0.0	100Hz	-4.0	0	0
ACCOMP1	10kHz	-0.5	100Hz	+0.0	32	58
ACCOMP2	10kHz	+4.5	100Hz	-4.5	61	52
ACCOMP3	10kHz	+0.0	100Hz	+0.0	55	35
ACCOMP4	10kHz	+0.0	100Hz	+0.0	55	50
ACCOMP5	10kHz	+0.0	100Hz	+0.0	0	0

EQ-Hi:

Sound correction in the high range.

- Use the **FC ▲** and **▼** buttons to adjust the standard frequency. Use the **GAIN ▲** and **▼** buttons to set the ratio of change.

EQ-Low:

Sound correction in the low range.

- Use the **FC ▲** and **▼** buttons to adjust the standard frequency. Use the **GAIN ▲** and **▼** buttons to set the ratio of change.

REV:

Depth of the **REVERB** (0 to 127).

CHO:

Depth of the **CHORUS** (0 to 127).

Playback

- In the **RHYTHM GROUP** section, press the **MEMORY** button.

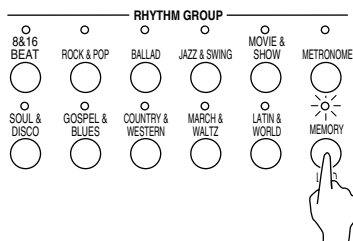

- The display looks similar to the following.

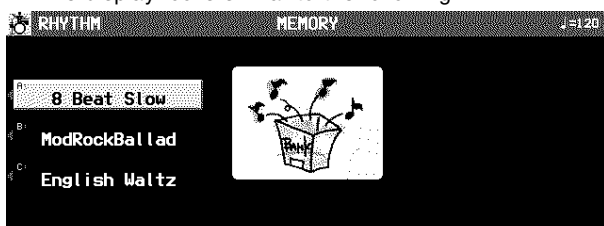

- Select the desired memory (A/B/C).

- Use the **VARIATION** buttons to select a variation.

- Press the **START/STOP** button.

- The **DRUMS** part begins to play back.
- The **BASS** and **ACCOMP** parts are played back when you use the **AUTO PLAY CHORD**.

Step Record

Use STEP RECORD to store the notes one-by-one on the display. This is a convenient way to store complicated patterns that are difficult to play.

Recording procedure

1. While you are recording, press the STEP RECORD button.

- The display changes to the STEP RECORD display similar to the following.

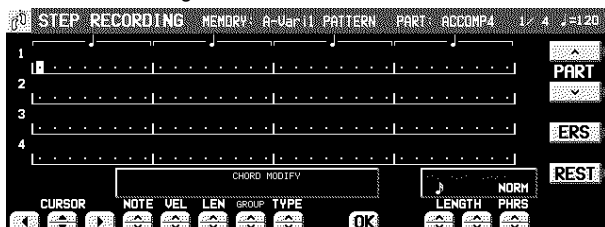

2. Use the CURSOR buttons to move the cursor to the note position you are going to store.

- Each dot represents one-eighth of a quarter-note (a thirty-second note).
- When storing triplets, it may not be possible to match the timing exactly with the 1/32-note steps. However, if you select triplet-type notes for the note length (LENGTH) in step 4 below, the timing is automatically corrected.

3. Use the left LENGTH buttons to specify the note value you are going to store next. Select from $\frac{3}{8}$, $\frac{2}{8}$, $\frac{3}{16}$, $\frac{2}{16}$, $\frac{3}{32}$, $\frac{2}{32}$, $\frac{3}{64}$, $\frac{2}{64}$, \circ , $\circ \times 2$ to 4. (A 3 denotes a triplet-type note.)

- For note values other than these, use the right LENGTH buttons to specify the note value to be added to that which you specified with the left buttons.

Example: To record a dotted quarter-note (♩.)



4. Use the PHRS \wedge and \vee buttons to specify the actual length of the produced sound for the desired legato or staccato effect.

TENU (tenuto):	Sound is produced for 95% of the note length.
NORM (normal):	80%
STAC (staccato):	50%
CUTT (cutting):	25%

5. Specify the pitch and velocity of the note by playing the keyboard.

- The dot on the display where the note is stored changes to a * mark.
- When recording chords, you can store multiple notes at one position.

REST:

To store a rest, after specifying the note LENGTH, press the REST button.

- Positions at which nothing is stored are read as rests.

ERS:

If you make a mistake, move the cursor to the error, and after displaying the data you wish to erase, press the ERS button.

6. Repeat steps 2 through 5 to continue storing notes.

- To record a different part, use the PART \wedge and \vee buttons to select another part.
- PAGE 1/2: The NOTE, VEL(OCITY), LEN(GTH), CHORD MODIFY and CONTROL can be revised later. Move the cursor to select the data you wish to revise, correct the value, and then press the OK button.
- You can easily switch between the REALTIME mode and the STEP mode any time during recording. To return to the realtime recording display during the STEP RECORD mode, press the EXIT button.

Measure Edit

You can edit the recorded data one measure at a time.

Select the function you wish to edit.

1. During recording, press the MEASURE EDIT button.

- The display looks similar to the following.



2. Select the function.

3. Follow the procedure to edit the function (see below).

- Only the contents of the same pattern can be edited.

MEASURE COPY

Copy recorded data of specified measures to a specified point.

- On the destination track, the new data replaces the current measure contents.

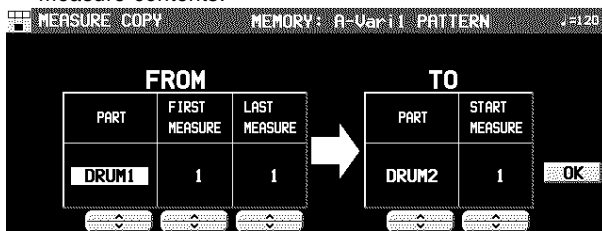

1. Specify the measures you wish to copy from the source track (FROM).

- On the FROM side, specify the settings with the corresponding buttons.

PART:

Select the part to copy from. (If ALL is selected, all parts are copied.)

FIRST MEASURE:

Specify the first measure to copy.

LAST MEASURE:

Specify the last measure to copy.

2. Specify where you wish to copy the selected measures to.

- On the TO side, specify the settings with the corresponding buttons.

PART:

Select the part to copy to.

START MEASURE:

Specify the start point to copy the selected measures to.

3. Press the OK button.

- The confirmation display appears. Press the YES button to execute the function, or press the NO button to cancel the function.
- If the FROM and TO parts are the same and the FROM and TO measures overlap, copy is not possible.

MEASURE ERASE

Erase the recorded contents of specific measures.

- Note that only the contents of the measures are erased, not the measures themselves; the length of the performance remains the same.

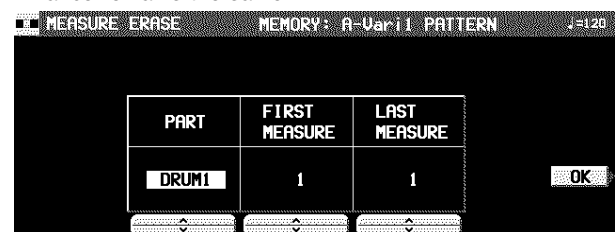

1. Use the PART ^ and v buttons to specify the part.

- If ALL is selected, data is erased from the specified measures of all the parts at one time.

2. Use the FIRST MEASURE ^ and v buttons to specify the start point (measure number).

3. Use the LAST MEASURE ^ and v buttons to specify the end point (measure number).

4. Press the OK button.

- The confirmation display appears. Press the YES button to execute the function, or press the NO button to cancel the function.

MEASURE DELETE

Delete specified measures from all parts at once.

- The length of the performance accordingly decreases by the number of deleted measures.

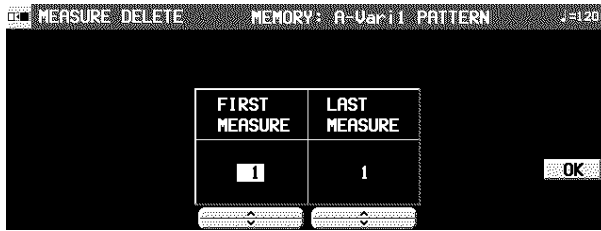

- Use the FIRST MEASURE \wedge and \vee buttons, to specify the first measure to delete.
- Use the LAST MEASURE \wedge and \vee buttons to specify the last measure to delete.
 - One measure is the smallest unit that can be deleted.
- Press the OK button.
 - The confirmation display appears. Press the YES button to execute the function, or press the NO button to cancel the function.
 - When the INTRO or ENDING measures are deleted, the Maj and Min data are erased at the same time.

MEASURE INSERT

Insert blank measures at a specified point.

- The length of the performance accordingly increases by the number of inserted measures.

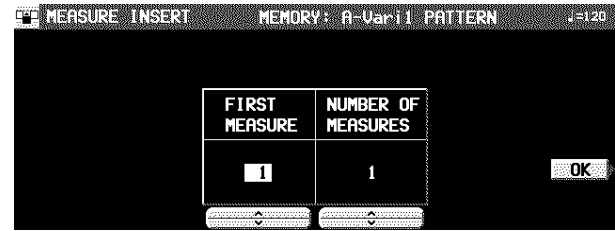

- Use the FIRST MEASURE button to select the point (measure) where the measures are to be inserted.
- Use the NUMBER OF MEASURE button to select the number of blank measures to insert.
 - No more than 16 measures total can be inserted.
- Press the OK button.
 - The confirmation display appears. Press the YES button to execute the function, or press the NO button to cancel the function.
 - The Maj or Min data is inserted in the INTRO and ENDING at the same time.

Pattern Copy

Use this function to copy a pattern from a rhythm or from **SEQUENCER** data.

PATTERN COPY

Copy a rhythm to the **COMPOSER**.

- You can also copy a pattern from the **MEMORY**.

- On the **COMPOSER MENU** display, select **PATTERN COPY**.
 - The display looks similar to the following.

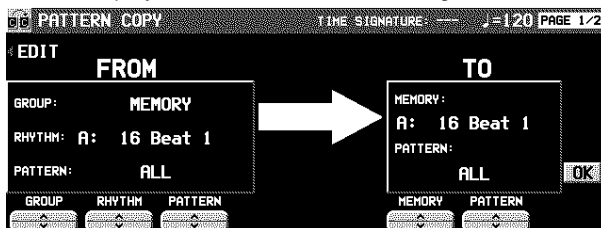

- Select the pattern you wish to copy.
 - In the FROM box, specify the settings with the corresponding buttons.
- | | |
|----------|--------------|
| GROUP: | Group name |
| RHYTHM: | Rhythm name |
| PATTERN: | Pattern name |
- If ALL is selected, all the patterns are copied.

- Select the memory you wish to copy to.
 - In the TO box, specify the settings with the corresponding buttons.
- | | |
|----------|-------------------------|
| MEMORY: | Memory name (A, B or C) |
| PATTERN: | Pattern name |
- If ALL is selected, all the patterns are copied.

- Press the OK button.
 - When copying has been successfully completed, "COMPLETED!" appears on the display.

- If you wish to use the **COMPOSER** functions to edit the copied data, press the EDIT button, and follow the procedure to record a pattern.

■ Copying one part at a time.

- Use the **PAGE** \wedge and \vee buttons to select **PAGE 2/2**.
 - The display looks similar to the following.

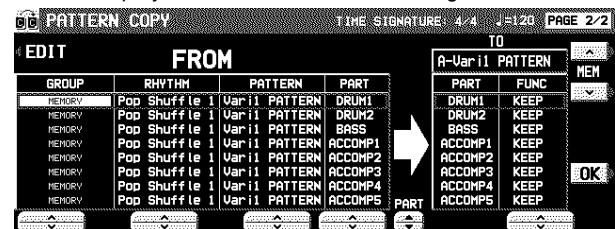

- Use the **MEM** \wedge and \vee buttons to specify the pattern to copy to.
- Use the **PART** \blacktriangle and \blacktriangledown buttons to specify the part you wish to copy to.

4. On the FROM side, use the buttons to specify the part to copy from.
 - For the DRUM part you can specify the DRUMS 1 or 2 part; for other parts you can specify a part other than a DRUMS part.
5. On the TO side, use the FUNC \wedge and \vee buttons to specify for each part whether or not to copy the data.

KEEP:
Part data is not copied.

CLEAR:
Part data is erased.

COPY:
Part data is copied.
6. Press the OK button.

SEQ TO COMPOSER COPY

Data from the **SEQUENCER** can be copied to a **COMPOSER** memory. For example, you can use a rhythm pattern on a song disk as the automatic accompaniment for your own performance.

1. Play back the song you wish to copy from **SEQUENCER** to confirm the tracks, the measures and the time signature you wish to copy.
2. Follow the procedure in “Prepare to record” to prepare the **COMPOSER** memory you will be copying to. (Refer to page 86.)
 - Be sure that time signature setting in the **SEQUENCER** data you are copying from and the time signature in the **COMPOSER** memory you are copying to are the same, or the data will not be copied successfully.
3. On the COMPOSER MENU display, select SEQ TO COMPOSER COPY.
 - The display looks similar to the following.

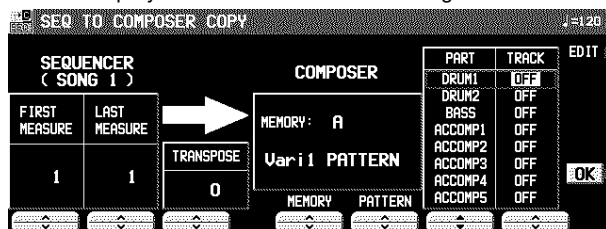

4. Use the FIRST MEASURE \wedge and \vee buttons to specify the number of the first measure to copy.
5. Use the LAST MEASURE \wedge and \vee buttons to specify the number of the last measure to copy.
6. Use the TRANPOSE \wedge and \vee buttons to change the key of the copied measures (–24 to +24).
 - Units are in semitones.
7. Use the MEMORY \wedge and \vee buttons to specify the **COMPOSER** memory to copy to.
8. Use the PATTERN \wedge and \vee buttons to specify the pattern to copy to.

9. For each **COMPOSER** part, specify the **SEQUENCER** track from which to copy data.
 - Use the PART \blacktriangle and \blacktriangledown buttons to specify the part name, and the TRACK \wedge and \vee buttons to specify the track number.
 - Parts which are set to OFF are blank.

10. Press the OK button.
 - “COMPLETED!” is shown on the display.
 - If you wish to use the **COMPOSER** function to edit the copied data, press the EDIT button, and follow the procedure to record a pattern.
 - In the case of INTRO or ENDING, if a measure contains a Maj or Min command, it is reproduced in the other pattern as well.

Part VI Disk Drive

Outline of the Disk Drive function

The Disk Drive enables you to store recorded and stored data from this instrument's memories on disks, as well as play commercial recorded disks on this instrument.

Internal memory and Floppy Disk Drive

The storable internal memory of this instrument as well as the backup time are limited. However, the Disk Drive maximizes your control of data management by allowing you to store (SAVE) this instrument's data on disks, and then to recall (LOAD) it at any time.

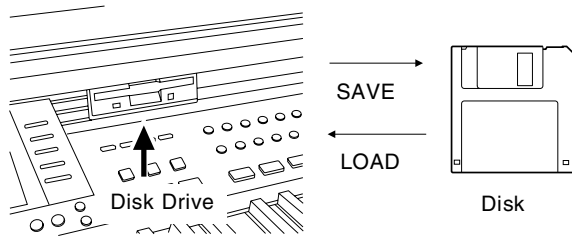

■ The following data can be saved/loaded:

PERFORMANCE

CURRENT PANEL (The current panel settings)
PANEL MEMORY*
SEQUENCER
COMPOSER* (MEMORY contents)
SOUND MEMORY*
EFFECT MEMORY*
PADS (USER memories of the PIANO PERFORMANCE PADS) (PR804)

BACKUP

MIDI (USER memory of the MIDI PRESETS)
FAVORITES

- When creating or saving song data, it is recommended that you use the performance data in the PERFORMANCE group.
- Instead of using MIDI & FAVORITES as frequently loaded and saved data, it is recommended that you save it with other data as this instrument's backup data.
- A * mark indicates that data can be loaded to and from a specific memory (SINGLE LOAD).
- The **SEQUENCER** contents can be saved in one-song increments (SEQUENCER SONG SAVE).
- Please use 2HD disks to load/save BACKUP data.

Main parts of the Floppy Disk Drive

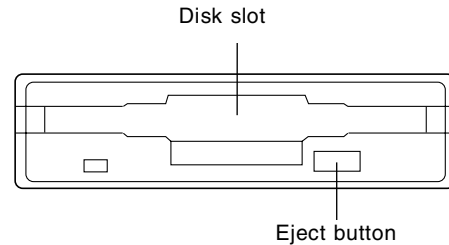

Eject button

⇒ Press to remove the disk from the Disk Drive.

- You can use 3.5 inch 2DD (720 KB) or 2HD (1.44 MB) disks; however, 2HD disks formatted as 2DD cannot be used.

Using commercial song disks

Not only disks recorded on this instrument, but also data from commercial song disks can be read on this instrument.

- This instrument accepts the following file formats:

TECHNICS File format
Standard MIDI File format

■ Loading Technics File format disks

Using Technics file format disks allows you load new SOUND EDIT, rhythm & accompaniments, **PANEL MEMORY**, **PADS** and Song data into your instrument to expand its potential even further.

■ About Standard MIDI Files

"Standard MIDI File" (SMF) is a standardized data format which makes it possible for music data to be exchanged among different sequencers. Data stored in this format on sequencers of different models can be played back on this instrument, and vice versa. Note, however, that Standard MIDI Files ensure the compatibility of data such as NOTE data (keyboard performance data), VELOCITY (how hard the keyboard is played), PROGRAM NUMBER data (voice number data), etc. Because it does not guarantee 100% faithful reproduction of recorded music which is replete with such data, it may be necessary for you to adjust the settings to your satisfaction.

- Only files with the ".MID" extension can be loaded.
- Standard MIDI File FORMAT 1 can be loaded, but not saved.
- This instrument's **SEQUENCER** data can be saved to a disk in Standard MIDI File (FORMAT 0) and can be used by other equipment.

Playback of commercial song disks

DIRECT PLAY lets you enjoy playing commercially sold song disks directly from a disk. It's fast because you don't have to load the disk data into your instrument's memory.

- DIRECT PLAY is possible from the following disks:

Standard MIDI File
Standard MIDI File with Lyrics
DISK ORCHESTRA COLLECTION™ (DOC)
PianoDisc™

* All product and company names are trademarks or registered trademarks of their respective owners.
 * DISK ORCHESTRA COLLECTION is a trademark of the YAMAHA Corporation.

■ SMF with LYRICS

SMF with LYRICS is a format in which character information that is included with the MIDI data, such as karaoke lyrics, can be displayed. This instrument supports this format, making it possible to view the lyrics on the display while a performance is played back.



■ GENERAL MIDI LEVEL 2 (GM2)

This instrument complies with GENERAL MIDI (GM) LEVEL 2 standards. GM LEVEL 2 is a uniform world standard for MIDI sound generators that improves on existing GM standards, in order to realize an enhanced performance expression. Sound generators of this class can reproduce virtually the identical conditions that were in effect at the time of recording.

Equipment which conforms to GENERAL MIDI LEVEL 2 standards is indicated by the following logo.



- This instrument also conforms to GENERAL MIDI playback.



Outline of the procedure

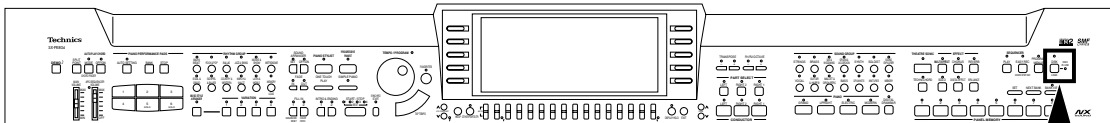

1. Insert the disk into the Disk Drive slot. Push it all the way in until you hear a click.
 - On this instrument, if the normal display is active, it automatically changes to the DISK MENU display when a disk is inserted into the Disk Drive (initialized settings). The PREFERENCES menu is used to specify which display is shown when a disk is inserted.
2. Select a menu on the DISK MENU display.
 - If the DISK MENU display does not appear, turn on the DISK button.
3. Follow the procedure for the function (see below).
 - When function is being set, if the TEMPO/PROGRAM indicator is lit, the TEMPO/PROGRAM is available for setting the current function.
4. When you have finished setting the functions, turn off the DISK button.



■ DISK IN USE



This indicator lights when data is being loaded or saved.
 • To prevent data loss, do not eject the disk or turn off the power while this indicator is lit.

■ About the menu



- LOAD (page 96)
Load data from a disk into this instrument's memory.
- SAVE (page 99)
Save data from this instrument's memory to a disk.
- DIRECT PLAY (page 98)
Direct playback of SMF etc. commercial song disks and medley playback.
- SONG MEDLEY (page 99)
Medley playback of songs in the floppy disk (Technics format).
- DISK TOOLS (page 102)
Disk management procedures, such as disk format.
- PREFERENCES (page 102)
The display screen settings during disk save.

Loading data

Recall (load) the data from the disk to this instrument's memories.

- Note that the load procedure causes any data which is currently stored in the relevant memories to be erased.

LOAD

Load data that saved to a disk into this instrument's memory.

1. Insert the disk with the stored data into the Disk Drive. Push it all the way in until you hear a click.

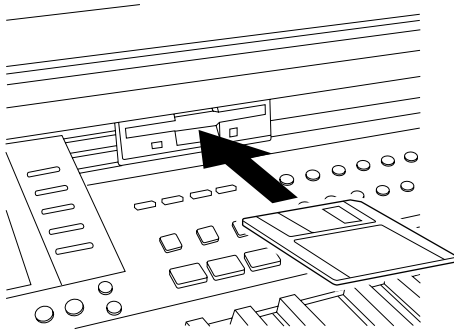

2. On the DISK MENU display, select LOAD.
 - The display looks similar to the following.



- If there are only SMF files on the disk, the display automatically changes to the SMF LOAD display.
3. Use the buttons below the display to select the file (Technics file) you wish to load.
 - If there are SMF files on the disk and you wish to load an SMF file, press the SMF button. (Refer to page 97.)
 4. Press the LOAD button.
 - The LOAD operation begins.
 - When the operation has been successfully completed, "COMPLETED!" is shown on the display.
 - If song data was loaded, you can press the **START/STOP** button to begin playback when the **SEQUENCER PLAY** display is active.
 - You can also access the LOAD display by pressing the **DISK** button for a few seconds.

LOAD OPTION

Specify the kind of data you wish to load from the disk to your instrument.

1. Use the **PAGE** buttons to access the PAGE 2/3 LOAD OPTION display.
 - The display looks similar to the following.

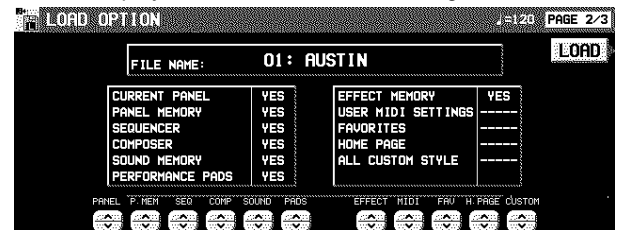

2. Use the buttons below the display to specify the types of data you wish to load (YES/NO).
 - - - - - indicates that this type of data has not been saved.
 - This setting is canceled when you quit the LOAD display or when another file is selected.

3. Press the LOAD button.
 - The LOAD operation begins.

SINGLE LOAD

You can specify which data to load from a disk into a specific **PANEL MEMORY**, **COMPOSER (MEMORY)**, **SOUND MEMORY**, **EFFECT MEMORY** or **SEQUENCER** (when SONG SAVE was executed) memory.

1. Use the **PAGE** buttons to access the PAGE 3/3 SINGLE LOAD display.
 - The display looks similar to the following.

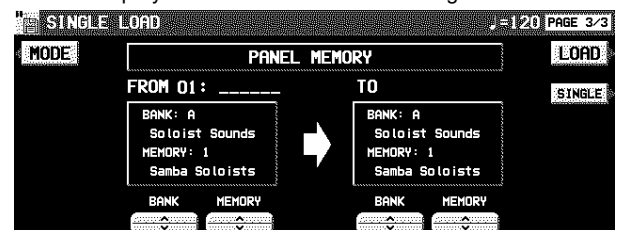

2. Use the **MODE** button to select the data you wish to load.
3. Use the **BANK/SINGLE** button to select the load increment (except for **SEQUENCER**).
 - BANK: Load one bank at a time.
 - SINGLE: Load the smallest data increment.
4. Follow the appropriate procedure to load the specified data.
 - Specify the data source (left side), and the data destination (this instrument's memory location) for TO.

■ **SMF LOAD**

Load data which was saved in the “Standard MIDI File” (SMF) format.

1. On the LOAD (PAGE 1/3) display, press the SMF button.
 - The display looks similar to the following.



- For disks which contain SMF files only, this display appears automatically when LOAD is selected on the DISK MENU display.

2. Use the buttons below the display to select the filename you wish to load.

- If the number of files is 10 or more, you can use the PREV and NEXT buttons to go back or advance 10 files at a time.
- If you press the TECH button, the display changes to the LOAD display for Technics files.
- You can use the INFO button to switch the displayed data.
DISK: Disk name
SONG: Song name

3. Use the TO SONG button to select the number to load to (this instrument’s **SEQUENCER** song number).

- Songs to load are specified one at a time.
- The song name to load to is shown below the TO SONG button.

4. Use the LOAD AS button to specify the load method.

Select from the following.

GM/GM2 → GM2:

Activate the GM2 initialized settings, and load GM/GM2 data.

NX → NX:

Active the NX SOUND settings, and load NX data.

GM/GM2 → NX:

Activate the NX SOUND initialized settings, and load GM/GM2 data.

PREV. TEC → NX:

Activate the NX SOUND initialized settings, and load SMF data that was saved in the TECHNICS mode on a previous model. (The volume balance and octave settings may differ from the saved settings.)

- If you select the setting which is different from that in which the song was stored, the sounds, octaves, and arrangement of percussion instrument sounds, etc. will be different.

5. Press the LOAD button.

- The LOAD operation begins.
- When the operation has been successfully completed, “COMPLETED!” is shown on the display.
- If you press the **START/STOP** button, playback of the loaded data begins.
- During the LOAD operation, data that cannot be processed by this instrument is ignored.

■ **COMPOSER LOAD**

Load **COMPOSER** data only from a disk.

1. In the **RHYTHM GROUP** section, press and hold the **LOAD (MEMORY)** button for a few seconds.

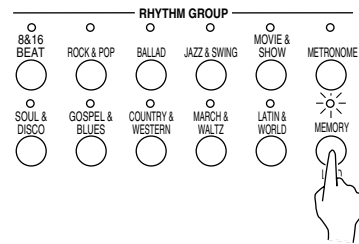

- The display looks similar to the following.



2. Select the name of the file you wish to load.

3. Press the LOAD button.

- Data is loaded to this instrument’s **COMPOSER** memory (**MEMORY**).

■ **About LOAD AS**

<->GM2>

The SMF data you load is played back in PARTS 1-16, allowing you to play the **RIGHT 1**, **RIGHT 2** and **LEFT** parts on the keyboard in time with the recording.

- Your keyboard performance is not output as MIDI data. If you wish your keyboard performance to be output as MIDI data, select <PR → Ext. Sequencer> in MIDI PRE-SETS. (Refer to page 132.)

<->NX>

The SMF data you load is played back matching the part settings and MIDI settings that were in effect when the data was saved.

- SMF data that was saved on models that are not NX-compatible is played back in parts **RIGHT 1**, **RIGHT 2**, **LEFT**, and PART 4-16.

Direct Play

You can enjoy immediate playback of “Standard MIDI File” (SMF), “Disk Orchestra Collection” (DOC) and “PianoDisc” disks—all without loading the song data.

1. Insert the disk with the stored data into the Disk Drive.

2. On the DISK MENU display, select DIRECT PLAY.

- The display looks similar to the following.

<Example: SMF>

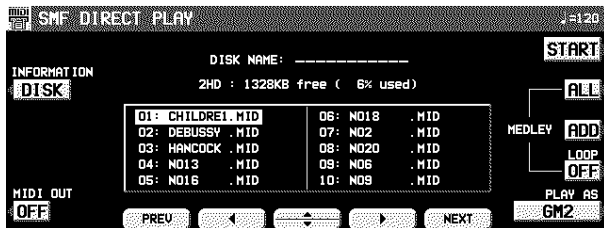

3. Use the buttons below the display to select the song you wish to have played.

- If the number of files is 10 or more, you can use the PREV and NEXT buttons to go back or advance 10 files at a time.

■ Adjusting the playback tempo

Even with a song having recorded tempo data, you can use **TEMPO/PROGRAM** or **TAP TEMPO** to adjust the tempo to your liking.

- When the tempo is changed, all the tempo data of that song is automatically changed by the same ratio. Accordingly, even in song data in which tempo change data is stored, a single adjustment of the tempo produces a natural-sounding playback.

■ The display during playback

<Example: SMF>

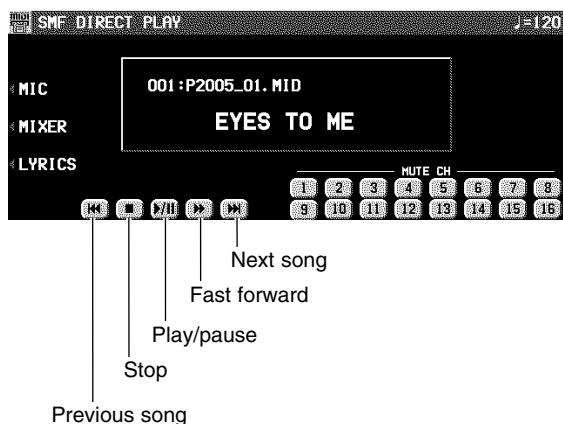

- During playback, the buttons below the display are used for player functions such as fast forward, pause, etc.
- During playback, if you press the MIXER button you can change the settings for each part.
- If you press the MIC button during playback, the display changes to the MIC REVERB & EFFECT setting display.
- For SMF disks:
 - For “SMF with LYRICS” disks, by pressing the LYRICS button, the lyrics are shown on the display.
 - For a “minus one” performance, use the MUTE CH buttons to select the channel you wish to mute. Following this,

- For SMF files, use the PLAY AS button to specify a sound arrangement mode.
 - GM2: GM2 LEVEL 2
 - NX: NX SOUND
 - PREV. TEC: Data from Technics instruments not having NX SOUND capability.
- For SMF files, you can use the INFO button to switch the displayed data.
 - DISK: Disk name
 - SONG: Song name
- For SMF files, use the MIDI OUT button to specify whether or not MIDI data is output during playback (ON/OFF). (This cannot be changed during playback.)

4. Press the START button.

- The selected song is played back.
- You can also start playback of the song by pressing the **START/STOP** button on the panel.

you can play a keyboard performance on the channel which was last set to MUTE.

- For DOC disks:
 - You can use the PART 1, PART 2 and ORCH (other accompaniment parts) buttons to set the respective parts to ON or OFF. You can play the parts set to OFF on the keyboard.
- For PIANO DISC playback:
 - You can use the PART 1 and ORCH (other accompaniment parts) buttons to set the respective parts to ON or OFF. You can play the parts set to OFF on the keyboard.

■ MEDLEY PLAY

With DIRECT PLAY, songs saved on a disk can be played back continuously in a medley.

1. On the DIRECT PLAY display, set the MEDLEY settings.

- If ALL is pressed, all the files are selected, and the songs are played back in order in a medley. If ALL is pressed again, the files are deselected.
- You can use the buttons below the display to select a song to add to the song list, then press the ADD button to add it to the list. Repeat these steps to create your own list of songs to have played back. A M01, M02 etc. next to the file name indicates its order in the list.
- If the number of files is 10 or more, you can use the PREV and NEXT buttons to go back or advance 10 files at a time.
- You can delete a marked file from the medley song list by selecting it and pressing the ADD button.
- Use the LOOP button to specify ON or OFF for repeat playback of the medley.

2. Press the START button.

- Medley playback begins.
- During medley playback, you can use the SKIP button to skip to the next song.

Song Medley

Songs saved from the **SEQUENCER** to a disk (disk data) in the **TECHNICS FORMAT** can be played back in a medley.

1. On the **DISK MENU** display, select **SONG MEDLEY** from the display.

- The display looks similar to the following.



2. Select the order of files in the medley.

- If **ALL** is pressed, all the files are selected, and the songs are played back in numerical in a medley.
- You can select a file and song, then press the **ADD** button to add it to the song list. Repeat these steps to create your own list of songs to have played back. A M01, M02 etc. next to the file name indicates its order in the list.
- You can delete a marked file from the medley song list by selecting it and pressing the **ADD** button.
- Use the **LOOP** button to specify **ON** or **OFF** for repeat playback of the medley.
- You can use the **MODE** button to select the medley mode.
 - 10 SNGS:
Songs 1 to 10 from each file are played in a medley.
 - 1 SONG:
Only song 1 from each file is played back in a medley.

3. Press the **START** button.

- Medley playback begins.
- During the performance, the display changes to the playback display.
- During a medley performance, if you press the **MIXER** button you can change the settings for each part.
- During a medley performance, you can use the **SKIP** button to skip to the next song.
- If the disk contains **SMF** or other files, but no **TECHNICS FORMAT** file, the display changes to the **DIRECT PLAY** display.

Saving data

The recorded data and panel settings of this instrument can be saved on a disk.

Disks

You can use 3.5 inch **2DD** (720KB) or **2HD** (1.44MB) disks.

- How to distinguish the two disk types:

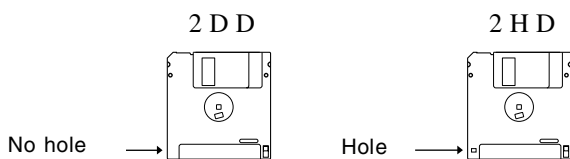

- Although **2HD** disks can hold more data and are convenient for quick loading and saving, some models may be able to read only **2DD** disks. Therefore, you may not be able to use your **2HD** disk data with other musical instrument models.
- When saving data to the disk, the write-protect tab must be closed.

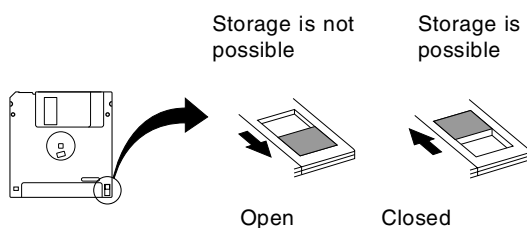

■ FORMAT

Disks which are used for the first time with this instrument have to be formatted through the following procedure. When an unformatted disk is inserted into the Disk Drive slot and you attempt to execute the save or load procedure, the **DISK FORMAT** display appears. Follow the instructions shown to format the disk.

- Note that this procedure clears any data which is currently stored on the disk.

1. Select the type of format (**2DD** or **2HD**).

- Be sure to select the type which is the same as your disk type.
- If the type is automatically detected, the display changes directly to the following display, without showing the type select display.
- The display looks similar to the following.



- If you wish to select the type again, use the **PAGE** button to access the **PAGE 2/2** display.

2. Press the YES button to format the disk, or press the NO button to cancel the format.

- When the YES button is pressed, disk format begins. After about 1–2 minutes, formatting is completed and DISK NAMING display is shown.

3. Use the buttons below the display to assign a name.

- Use the POSITION buttons to highlight the character position in the name box. Use the ABC...123 buttons to select the alphanumeric character. Repeat these steps to type the whole name.
- Press the INS button to enter a space at the cursor position.
- Press the DEL button to erase the character at the cursor position.
- Press the CLR button to erase the entire name.
- Press the →← button to center the name.

4. Press the OK button.

- The FORMAT display can also be accessed from the DISK TOOLS menu when, for example, you wish to reformat a disk. (Refer to page 102.)

SAVE

1. Insert a formatted disk into the Disk Drive slot. Push it all the way in until you hear a click.

- A disk which is used with this instrument for the first time must first be formatted.

2. On the DISK MENU display, select SAVE.

- The display looks similar to the following.



3. Select the type of data save you want.

TECHNICS FORMAT:

Save this instrument's data in the Technics File format.

SMF FORMAT 0:

Save the **SEQUENCER** data in the "Standard MIDI File" format (FORMAT 0).

TECHNICS FORMAT

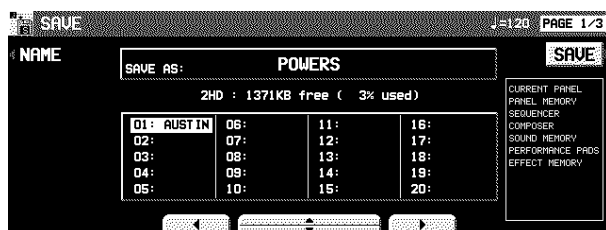

1. Use the buttons below the display to specify the file number you wish to save to.

- The types of data that can be saved are shown in a frame on the right side of the display. If you press the SAVE button, all the indicated data is saved. Ordinarily PERFORMANCE data is selected, but you can use the SAVE OPTION to select specific data to save.

2. If you wish to assign a name to the file, press the NAME button.

- The display looks similar to the following.

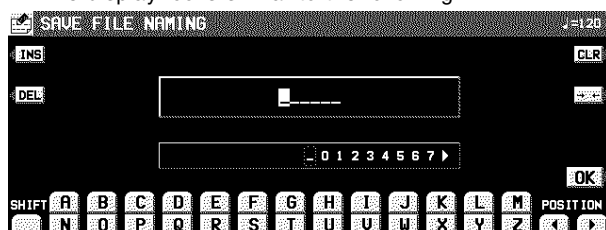

3. Use the buttons below the display to assign a name.

- Press the ABC button to enter alphabetical characters. While the SHIFT button is pressed, upper case letters are entered.
- Press the 123 button to enter numbers, etc. While the SHIFT button is pressed, you can enter symbols.
- Press the POSITION button to move the cursor.
- You can also use the **TEMPO/PROGRAM** dial to select the characters.
- Press the INS button to enter a space at the cursor position.
- Press the DEL button to erase the character at the cursor position.
- Press the CLR button to erase the entire name.
- Press the →← button to center the name.

4. Press the OK button.

- The display returns to the SAVE display.

5. Press the SAVE button.

- The SAVE operation begins.
- If you attempt to save data to a file number in which data is currently saved, the display changes to the confirmation display. Press the YES button to continue the SAVE procedure, or press the NO button if you wish to cancel it.

<SAVE OPTION>

Specify the kind of data you wish to save to the disk. To maximize effective use of disk memory or to minimize the save time, select only the type of data you wish to save.

1. Use the **PAGE** buttons to access the 2/3 SAVE OPTION display.

- The display looks similar to the following.



2. Use the buttons below the display to specify the types of data you wish to save (YES/NO).

- For PANEL MEMORY, select from NO/1 BANK/ALL. If you save data with 1 BANK selected, only BANK 1 data is saved.
- Press the PERFORM button to select all the performance data, or press the BACKUP button to select all the back up data at once.
- If the ALL OFF button is pressed, all the settings change to NO.

3. Press the SAVE button.

- The SAVE operation begins.

<SEQUENCER SONG SAVE>

You can specify a single song in the **SEQUENCER** to save to the disk.

1. Use the **PAGE** buttons to access the 3/3 SEQUENCER SONG SAVE display.

- The display looks similar to the following.

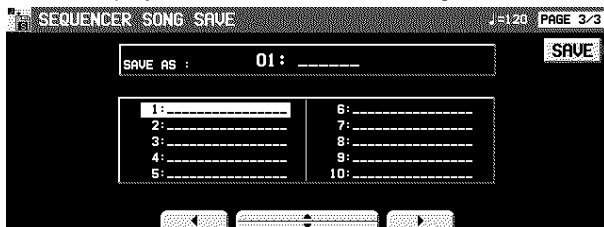

2. Use the buttons below the display to select the song number you wish to save.

3. Press the SAVE button.

- The SAVE operation begins.

If there is no point assignment in the **SEQUENCER** song you are trying to save even though your original images have been loaded, when the SAVE button is pressed, a display appears asking whether or not the image data is to be saved.

■ **SMF FORMAT 0**

This instrument's **SEQUENCER** data can be saved in the "Standard MIDI File" format (FORMAT 0) for use on other instruments.

- What you can save in the SMF format (FORMAT 0) is ordinary performance data, such as note data. Data such as chord and rhythm data, **COMPOSER** data, etc. is not saved. If you wish to also save this special Technics data, save the data in the Technics File format.
- If you use the APC TO SMF CONVERT function of the **SEQUENCER**, you can convert the patterns of the automatic accompaniment, etc. in their respective tracks.

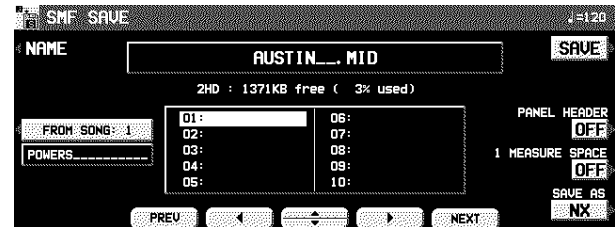

1. Use the buttons below the display to select the song number you wish to save to.

- If the number of files is 10 or more, you can use the PREV and NEXT buttons to go back or advance 10 files at a time.

2. If you wish to assign a name to the file, press the NAME button.

3. Use the buttons below the display to assign a name.

4. Press the OK button.

- The display returns to the SAVE display.

5. Use the FROM SONG buttons to select the **SEQUENCER** song number you wish to save.

- The song name to save from is shown below the FROM SONG button.

6. Use the PANEL HEADER buttons to specify ON or OFF.

- ON: The sound and volume settings for each part are saved as data at the beginning of the file.
- OFF: This data is not saved.

7. Use the 1 MEASURE SPACE buttons to select ON or OFF.

- ON: A one-measure space is added to the beginning of the file.
- OFF: No space is added.

- When there is various data other than performance data stored at the beginning of a file, the start of playback may be delayed. This can be avoided by set the 1 MEASURE SPACE to ON, thereby inserting a space at the beginning of the performance.
- If it seems the data you saved with the 1 MEASURE SPACE set to OFF is not played back properly, try saving it again with it set to ON.
- When set to ON, a space is added each time a file is saved. Therefore, if you have already saved a file once with the 1 MEASURE SPACE set to ON, please set it to OFF each time the file is subsequently saved.

- Use the SAVE AS button to select the sound generator mode (GM/GM2/NX).
 - If the data created on this instrument was saved in the GM/GM2 mode, the sounds etc. may change. If saving data in the GM/GM2 mode, be sure to select sounds from the **SOUND EXPLORER** sound groups when you create data.
 - GM: GM BASIC and Standard Kit
 - GM2: GM2 EXTEND and GM2 DRUM KITS

- Press the SAVE button.
 - The SAVE operation begins.
 - When the operation has been successfully completed, "COMPLETED!" is shown on the display.
 - If you attempt to save data to a file number in which data is currently saved, the display changes to the confirmation display. Press the YES button to continue the SAVE procedure, or press the NO button if you wish to cancel it.

Disk management

Various disk management procedures, such as file erase, file copy, and disk format, are available from the DISK TOOLS menu.

DISK TOOLS

- Insert the disk into the Disk Drive slot.
- On the DISK MENU display, select DISK TOOLS from the display.
 - The display looks similar to the following.



- Select a function and follow the procedure to execute it.
 - Use the buttons below the display to select a file.
 - You can press the SMF/TECH button to change to the display for procedures related to SMF/TECH files.
 - Use the buttons to the left and right of the display to access the corresponding setting display.

RENAME: Assign a name to a file.

DEL: Delete a file.

FORMAT: Reformat the disk.

COPY (TECH): Copy a file.

MOVE (TECH): Replace a file.

INFO (DISK/SONG) (SMF files only): Select whether to display the disk data or the song names.

Set the automatic display when a disk is inserted

When a disk is inserted in the Disk Drive, the display automatically changes to a disk-procedure display. Follow this procedure to customize the automatic display.

PREFERENCES

- On the DISK MENU display, select PREFERENCES.
 - The display looks similar to the following.



- Use the buttons to the left of the display to select the item, and the ^ and v buttons to change the setting.

DISK INSERT OPTION:

The display automatically changes to a disk-procedure display when a disk is inserted in the Disk Drive (OFF, DISK MENU, LOAD, DIRECT PLAY, SONG MEDLEY).

- During playback, recording or changing the settings, the displays unrelated to the settings made here do not change.

FILE TYPE PRIORITY:

Specify the desired priority ranking of displayed files when several types of files are recorded on one disk (TECHNICS/SMF).

- Press the OK button.

Part VII Sound

Outline of the Sound

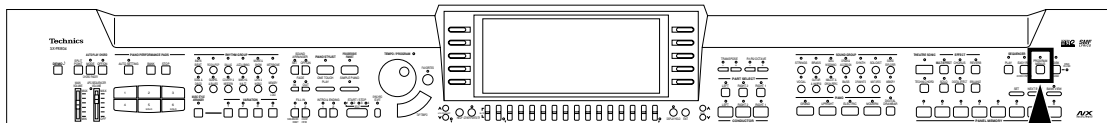

The SOUND mode is used for making fine adjustments to the functions related to sound, such as tone, and tuning.

1. Press the **PROGRAM MENUS** button to turn it on.

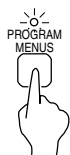

- The display looks similar to the following.



2. Select **SOUND**.

- The display looks similar to the following.



3. Select the desired menu. (PR804)

4. Follow the procedures on the corresponding menu display.

- When the **TEMPO/PROGRAM** indicator is lit, it indicates that the **TEMPO/PROGRAM** is available for setting the current function.

Summary of the SOUND menu items

- PART SETTING** (page 103)
Set the various sound attributes for each part.
- MIXER** (page 105)
Use the MIXER display to visually adjust the major settings of each part.
- MASTER TUNING** (page 107)
Select the type of tuning for the instrument.
- KEY SCALING** (page 107)
Select the type of scaling (tuning).
- TECHNI-CHORD**
Select the **TECHNI-CHORD** harmony style. (Refer to page 43.)
- SOUND LOAD OPTION** (page 108)
Specify whether the various data accompanying a sound, such as effects, are used when the sound is recalled.
- APC REVERB SETTING** (page 108)
Adjust the degree of **REVERB** for each automatic accompaniment part.
- THEATRE SONIC PART SETTING (PR804)** (page 108)
Set the **THEATRE SONIC** effect to on or off for each part.

5. When you have finished setting the functions, press the **PROGRAM MENUS** button to turn it off.

A word about parts

The organization of the sound parts is as follows.

Normal parts (16 parts):

RIGHT 1, RIGHT 2, LEFT, PART 1 to 16

- It is suggested that PART 10 be used for the DRUMS part.

AUTO PLAY CHORD (automatic accompaniment) parts:

ACCOMP 1-5, BASS, DRUMS 1, 2, CHORD, R.BASS.

PIANO PERFORMANCE PADS part (PR804):
PADS

Part Setting

Set the various sound attributes for each part.

Selecting an attribute

1. On the SOUND MENU display, select **PART SETTING**.

2. Use the **PART SELECT** ^ and v buttons to select the part.

3. Use the buttons below the display to adjust each attribute (explained in detail following).

- If necessary, assign a sound to the selected part at this time.

- The settings display is comprised of 5 pages. Use the **PAGE** buttons to switch pages.
- When you have completed adjustment of an attribute, use the buttons along the bottom of the display to select the next attribute you wish to adjust.

4. When you have completed adjusting all of the settings for one part, select another part and repeat the adjustment procedure as desired.

- The settings and effects of the PAN, EFFECT etc. may differ depending on the sound.

<PAGE 1>



SOUND:

Use the SOUND \wedge and \vee buttons to select a sound.

- The buttons on the control panel may also be used to select a sound.

VOLUME:

Use the VOLUME \wedge and \vee buttons to adjust the volume (0 to 127).

PAN:

Use the PAN \wedge and \vee buttons to adjust the stereo balance (L64–CENTER(CTR)–R63).

- At L64, the sound is completely to the left, at R63 completely to the right. At CENTER, the sound is at the center. The display indicates the selected position.
- Even at the same numerical value, the stereo balance may differ slightly depending on the sound.

SUSTAIN:

Use the \wedge and \vee buttons to adjust the length of the sustain (1–8). Use the ON/OFF buttons to enable or disable the sustain effect, when the sustain pedal is depressed.

GLIDE PEDAL:

Use the GLIDE ON/OFF buttons to enable or disable the glide effect, if it has been assigned to the pedal.

- For pedal settings, refer to page 121.

KEY SHIFT:

Use the KEY \wedge and \vee buttons to specify the amount of key shift (–24 to +24).

- A value of 1 means a shift of one semi-tone. To raise (or lower) the pitch one octave, set the value to +12 (or –12).
- The \vee button is used to lower the pitch, and the \wedge button to raise the pitch.

TUNING:

Use the TUN \wedge and \vee buttons to adjust the fine tuning (–128 to +127).

- The \vee button is used to lower the pitch, and the \wedge button to raise the pitch.

ORIGINAL TUNING:

Use the ORIG. ON/OFF button to enable or disable the tuning for each sound.

- For details about ORIGINAL TUNING, refer to page 107.

<PAGE 2>

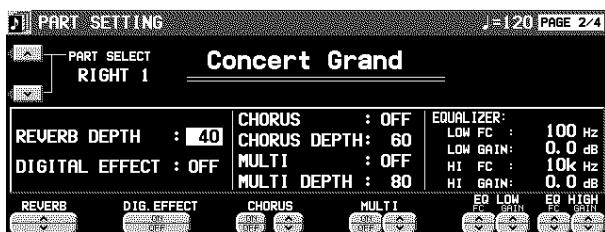

REVERB:

Use the REVERB \wedge and \vee buttons to adjust the depth of the **REVERB** (0 to 127).

DIGITAL EFFECT:

Use the DIG. EFFECT ON/OFF buttons to set the **DIGITAL EFFECT** to on or off.

CHORUS:

Use the ON/OFF button to set the **CHORUS** to on or off. Use the \wedge and \vee buttons to adjust the depth of the effect (0 to 127).

MULTI:

Use the ON/OFF button to set the **MULTI EFFECT** to on or off. Use the \wedge and \vee buttons to adjust the depth of the effect (0 to 127).

EQ LOW:

Use the FC, GAIN \wedge and \vee buttons to adjust the sound quality in the lower range.

EQ HI:

Use the FC, GAIN \wedge and \vee buttons to adjust the sound quality in the upper range.

<PAGE 3>



FILTER RESONANCE:

Use the RESO \wedge and \vee buttons to adjust the amount of resonance (0 to 127).

BRIGHTNESS:

Use the BRIGHTNESS \wedge and \vee buttons to adjust the brightness of the sound (0 to 127).

ATTACK TIME:

Use the ATTACK \wedge and \vee buttons to specify the attack time (0 to 127).

DECAY TIME:

Use the DECAY \wedge and \vee buttons to specify the decay time (0 to 127).

RELEASE TIME:

Use the RELEASE \wedge and \vee buttons to specify the release time (0 to 127).

VIBRATO RATE:

Use the RATE \wedge and \vee buttons to specify the vibrato speed (0 to 127).

VIBRATO DEPTH:

Use the DEPTH \wedge and \vee buttons to specify the vibrato depth (0 to 127).

VIBRATO DELAY:

Use the DELAY \wedge and \vee buttons to specify the time interval from when the keys are played until the vibrato starts (0 to 127).

- The center value is 64 (± 0).

<PAGE 4>

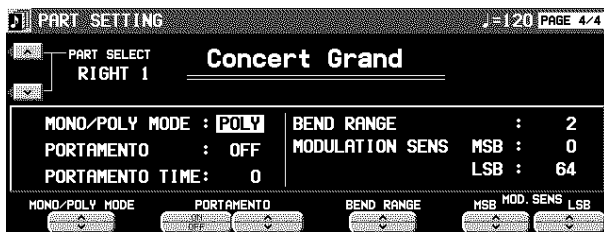
**MONO/POLY MODE:**

Use the MONO/POLY MODE \wedge and \vee buttons to select the output mode.

PORTAMENTO:

Use the ON/OFF buttons to enable or disable the portamento function. (Portamento is a continuous gliding movement from one tone to another.)

- Use the \wedge and \vee buttons to specify the portamento time.
- PORTAMENTO does not function for the POLY MODE.

BEND RANGE:

Use the BEND RANGE \wedge and \vee buttons to specify the PITCH BEND range (0 to 12). Increments are in semi-tones.

The higher the number, the greater the change in pitch when PITCH BEND data is received as MIDI data.

MODULATION SENSITIVITY:

Use the MOD. SENS \wedge and \vee buttons to adjust the sensitivity of the MODULATION (when MIDI data is received).

- Use the MSB \wedge and \vee buttons (half-tone increments) and the LSB \wedge and \vee buttons to adjust the setting.

Mixer

Use the MIXER display to visually adjust the major settings of each part. Use this display to make broad, general changes to the settings.

1. On the SOUND MENU display, select MIXER.

- The MIXER display consists of 5 pages. Use the **PAGE** buttons to switch among the pages.
- Each time the **OTHER PARTS/TR** button is pressed, the part that is displayed changes.

2. Adjust each parameter.

<PAGE 1/5>

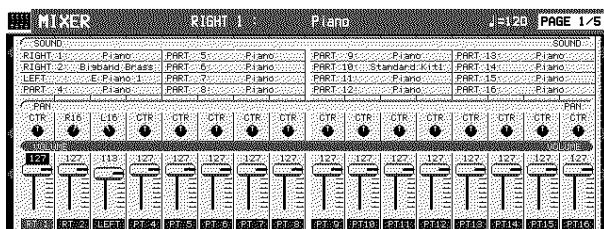
**SOUND:**

Select SOUND. Use the buttons below the display to set the sound for the corresponding part.

- The buttons in the panel can also be used to select the sound.

PAN:

Select PAN. Use the buttons below the display to adjust the stereo balance of the corresponding part (L64–CTR–R63).

VOLUME:

Select VOLUME. Use the buttons below the display to adjust the volume of the corresponding part (0 to 127).

- To mute a part, press both the corresponding balance buttons as the same time. To cancel the mute, press either balance button for the part.

<PAGE 2/5>

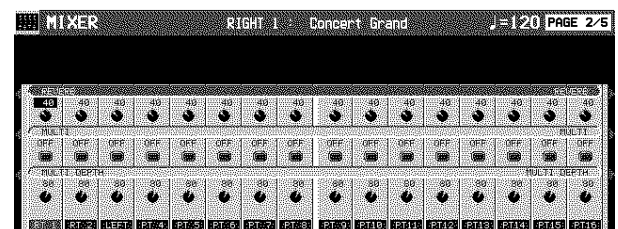
**REVERB:**

Select REVERB. Use the buttons below the display to set the level of the **REVERB** for the corresponding part (0 to 127).

MULTI:

Select MULTI. Use the buttons below the display to set the **MULTI EFFECT** to ON or OFF for each part.

MULTI DEPTH:

Select MULTI DEPTH. Use the buttons below the display to adjust the depth of the **MULTI EFFECT** for the corresponding part (0 to 127).

<PAGE 3/5>

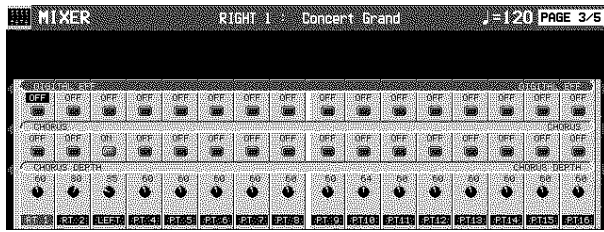

DIGITAL EFFECT:

Select DIGITAL EFF. Use the buttons below the display to set the **DIGITAL EFFECT** to ON or OFF for the corresponding part.

CHORUS:

Select CHORUS. Use the buttons below the display to set the **CHORUS** to ON or OFF for each part.

CHORUS DEPTH:

Select CHORUS DEPTH. Use the buttons below the display to set the depth of the **CHORUS** for the corresponding part (0 to 127).

<PAGE 4/5>

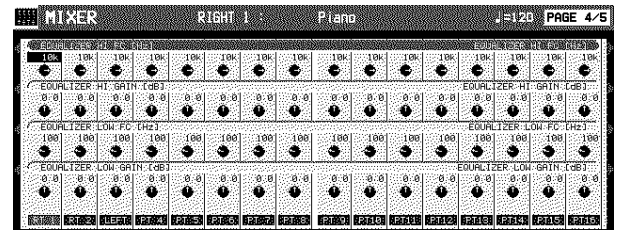

EQUALIZER HIGH:

Sound quality correction in the high range. Select **EQUALIZER HI FC**; use the buttons below the display to set the standard frequency. Select **EQUALIZER HI GAIN**; use the buttons below the display to set the ratio of change.

EQUALIZER LOW:

Sound quality correction in the low range. Select **EQUALIZER LOW FC**; use the buttons below the display to set the standard frequency. Select **EQUALIZER LOW GAIN**; use the buttons below the display to set the ratio of change.

<PAGE 5/5>

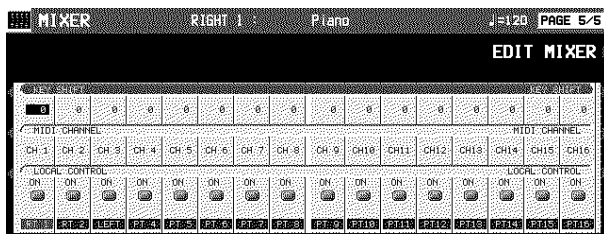

KEY SHIFT:

Select KEY SHIFT. Use the buttons below the display to adjust the shift width of the output pitch of each part (in semitone increments; -24 to +24).

MIDI CHANNEL:

Select MIDI CHANNEL. Use the balance buttons below the display to set the MIDI channel for each part (CH1-CH16).

- Information about MIDI channels can be found on page 128.

LOCAL CONTROL:

Select LOCAL CONTROL. Use the balance buttons below the display to turn LOCAL CONTROL ON or OFF for each part.

- Even at the same numerical value, the PAN and effects may differ depending on the sound.
- For some parts, such as the automatic accompaniment parts, the items that can be adjusted are limited.

■ EDIT MIXER

If you press the EDIT MIXER button on the PAGE 5/5 display, the display changes the setting display to modify the sounds.

<PAGE 1>

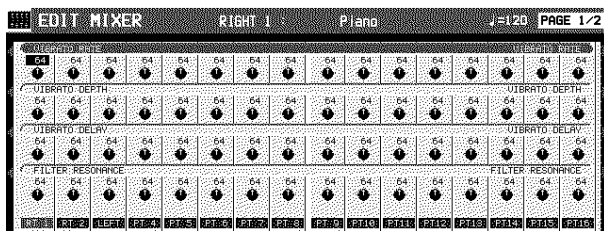

VIBRATO RATE:

Select VIBRATO RATE. Use the buttons below the display to adjust the vibrato speed for each part (0 to 127).

VIBRATO DEPTH:

Select VIBRATO DEPTH. Use the buttons below the display to adjust the vibrato depth for each part (0 to 127).

VIBRATO DELAY:

Select VIBRATO DELAY. Use the buttons below the display to specify the time interval from when the keys are played until the vibrato starts for each part (0 to 127).

FILTER RESONANCE:

Select FILTER RESONANCE. Use the buttons below the display to set the amount of resonance applied to each part (0 to 127).

<PAGE 2>

BRIGHTNESS:

Select BRIGHTNESS. Use the buttons below the display to set the amount of brightness applied to each part (0 to 127).

ATTACK TIME:

Select ATTACK TIME. Use the buttons below the display to set the sound attack time for each part (0 to 127).

DECAY TIME:

Select DECAY TIME. Use the buttons below the display to set the sound decay time for each part (0 to 127).

RELEASE TIME: Select RELEASE TIME. Use the buttons below the display to set the release time for each part (0 to 127).

Master Tuning

This setting is used to fine-tune the pitch of the entire instrument. This is convenient when this instrument is played with other instruments or with a recorded performance.

1. On the SOUND MENU display, select MASTER TUNING.

- The display changes to the following.



2. Use the \wedge and \vee buttons to adjust the pitch.

- Pressing the \wedge and \vee buttons at the same time will reset the tuning to the standard 440.0 Hz.

Key Scaling

For each part you can change the tuning of each key within a one-octave range. In addition to equal temperament tuning, you can perform in other types of scales, for example Arabic tuning.

1. On the SOUND MENU display, select KEY SCALING.

- The display looks similar to the following.

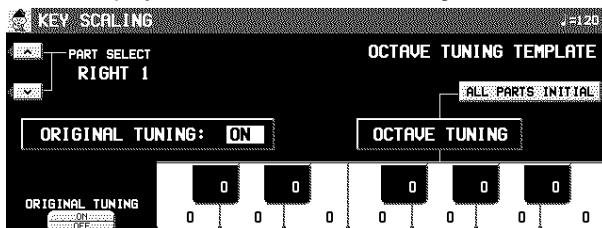

2. Press the OCTAVE TUNING TEMPLATE button.

- The display looks similar to the following.

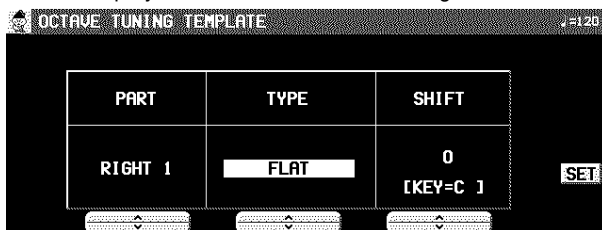

3. Use the PART \wedge and \vee buttons to select the part to set.

- If ALL is selected, all the parts are set at once.

4. Use the TYPE \wedge and \vee buttons to select the type of tuning.

- Select from FLAT, WERCKMEISTER, KIRNBERGER, ARABIC 1 to 5, SLENDRO, and PELOG.

5. Use the SHIFT \wedge and \vee buttons to select the key to perform in.

6. Repeat steps 3 to 6 for each part, as necessary.

7. Press the SET button.

- The OCTAVE TUNING for the specified type and key is automatically set.

■ Settings for each key.

On the KEY SCALING display, you can adjust the tuning for each key.

Use the buttons below the display to adjust the tuning for each key.

- The pitch can be raised or lowered by a maximum of one half-tone.
- You can use the PART SELECT \wedge and \vee buttons to switch the part.
- Use the ALL PARTS INITIAL button to return all parts to the flat tuning.

■ ORIGINAL tuning

Each instrument of each sound has its own original tuning data. This setting affects the tuning curve that spans the entire keyboard. So, for example, the acoustic piano-type sounds duplicate those of a real piano, in that the high notes are tuned slightly higher and the low notes slightly lower. You can specify for each part whether this original tuning is enabled or not.

1. Use the PART SELECT \wedge and \vee buttons to select a part.

2. Use the ORIGINAL TUNING ON/OFF button to select ON or OFF.

Sound Load Option

The data for each individual sound is set with the most suitable effect settings, etc., but in some cases when switching from one sound to another and these settings are recalled, the setup is not the way you want it. By using the SOUND LOAD OPTION, you can adjust the settings so that specific data is not recalled.

1. On the SOUND MENU display, select SOUND LOAD OPTION.

- The display looks similar to the following.

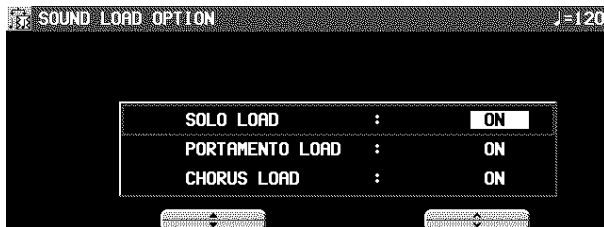

2. Use the ▲ and ▼ buttons to select an item. Use the ^ and v button to set the filter to ON or OFF.

APC Reverb Setting

Although an appropriate REVERB is applied for the automatic accompaniment parts depending on the rhythms by default, you can adjust the REVERB level for each part.

1. On the SOUND MENU display, select APC REVERB SETTING.

- The display looks similar to the following.

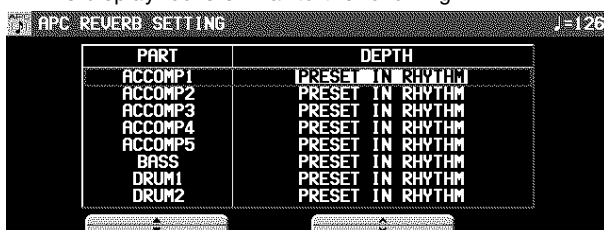

2. Use the PART ▲ and ▼ buttons to select the part, the DEPTH ^ and v buttons to set the value (PRESET IN RHYTHM, 0 – 127).
 - PRESET IN RHYTHM is an optimal preset value for each rhythm for use with the APC Reverb Setting.

Theatre Sonic Part Setting (PR804)

The THEATRE SONIC effect can be set to on or off for each part.

1. On the SOUND MENU display, select THEATRE SONIC PART SETTING.

- The display looks similar to the following.

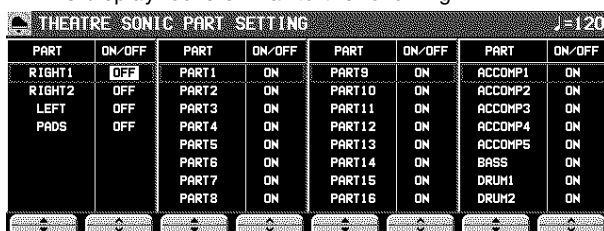

2. Use the PART ▲ and ▼ buttons to select the part, the ^ and v buttons to set the value (ON/OFF).

Part VIII Reverb & Effect

Outline of the Reverb & Effect

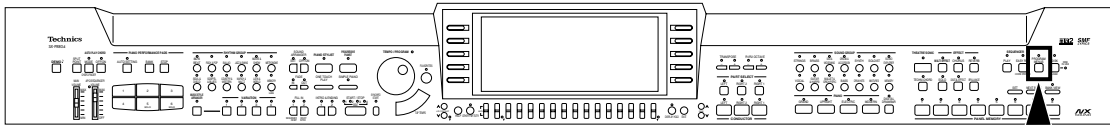

In the REVERB & EFFECT mode, you can make detailed settings related to this instrument's effects.

1. Press the **PROGRAM MENUS** button to turn it on.



- The display looks similar to the following.



2. Select REVERB & EFFECT.

- The display looks similar to the following.



3. Select the desired menu.
4. Follow the procedures on the corresponding menu display.
 - When the **TEMPO/PROGRAM** indicator is lit, it indicates that the **TEMPO/PROGRAM** is available for setting the current function.
5. When you have finished setting the functions, press the **PROGRAM MENUS** button to turn it off.

Summary of the REVERB & EFFECT menu items

TONE CONTROL

Settings for the entire instrument's final output sound quality.

REVERB:

REVERB type and detailed settings (page 41)

CHORUS:

CHORUS type and detailed settings (page 40)

MULTI:

MULTI type and detailed settings (page 39)

MIC REVERB & EFFECT:

Settings for the effects that are applied to MIC. (page 41)

SOUND LOAD OPTION

Specify whether the various data accompanying a sound, such as effects, are used when the sound is recalled. (page 108)

MIXER

Use the MIXER display to visually adjust the major settings of each part. (page 105)

Tone Control

Quality compensation for the sounds of this entire instrument (final output).

1. On the REVERB & EFFECT display, select **TONE CONTROL**.

- The display looks similar to the following.

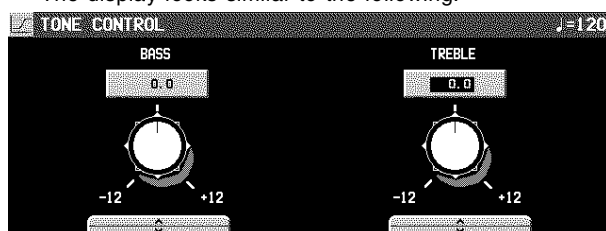

2. Use the **BASS** and **TREBLE** \wedge and \vee buttons to adjust the sound quality to your liking.

- If the **BASS** or **TREBLE** is set too high, depending on the selected sound, the sound may be distorted. In this case, lower the setting or lower the **MAIN VOLUME** setting.

Part IX Sound Edit

Outline of the Sound Edit



SOUND EDIT enables you to create your own new sound by altering one of the this instrument's preset sounds. Your new sound can be stored in one of the sound memory locations. SOUND EDIT has two methods of use. You can edit in detail using functions more commonly associated with a synthesizer, or you can use EASY EDIT which allows you to change some basic parameters on one page.

1. Select a sound to edit.
 2. Turn on the **PROGRAM MENUS** button.
- To record the **DIGITAL DRAWBAR** settings, first adjust the settings, then enter the SOUND EDIT mode, press the WRITE button and follow the procedure on the display.



- The display looks similar to the following.



3. Select SOUND EDIT.

- The display looks similar to the following.



4. Select the desired menu and follow the procedures on the corresponding setting display.

- To check the sound of a single tone, press the SOLO button to highlight the SOLO indication. Only the currently selected tone sounds when a key is played.
- When the **TEMPO/PROGRAM** indicator is lit, it indicates that the **TEMPO/PROGRAM** is available for setting the current function.

5. When the sound is just the way you like it, on the SOUND EDIT MENU display press the WRITE button to store your new sound.

- Press the EDITED (or ORIGINAL) button to switch between the modified sound (EDITED) and the original sound (ORIGINAL). This allows you to compare the edited sound to the original sound as you are modifying it.
- When DRUM KIT sounds are selected and the SOUND EDIT is activated, the setting display looks different from that for other sounds, but the basic operation is the same. (To specify the percussion instrument you wish to edit, use the ^ and v buttons to select the sound name, or alternatively, while pressing the keyboard key for the corresponding sound, press the NOTE SELECT button.)

Summary of the SOUND EDIT menu items

EASY EDIT (page 111)

The most often used edit functions—such as brightness and attack speed—are assembled on one display for easy sound modification.

TONE (page 111)

Modify the tones which make up the sound.

PITCH (page 113)

Adjust the settings related to the pitch.

FILTER (page 114)

Adjust the amount of frequency cut in specific frequency ranges.

AMPLITUDE (page 116)

Volume settings.

LFO (page 117)

Cyclic modulation settings.

EFFECT (page 118)

Settings related to the various effects applied to the sound.

CONTROLLER (page 118)

Specify how wheel operation etc. affects the sound.

Easy Edit

The most commonly used edit functions are consolidated on one display, providing convenient and quick editing operation.

1. On the SOUND EDIT menu display, select EASY EDIT.

- The display changes to the following.

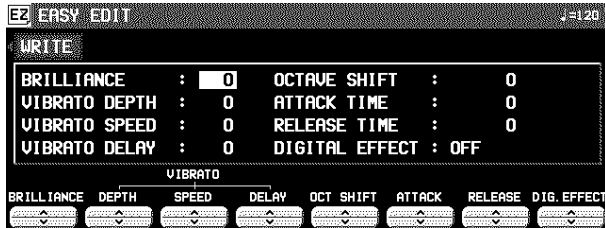

2 Use the buttons below the display to specify the value of the attribute.

- An effect may remain unchanged when EASY EDIT is used to set the value, if another EDIT function was first used to set the value to its upper or lower limit.

3. Press the WRITE button to store your new sound.

- Storing your new sound is explained on page 119.
- If a sound is stored in the EASY EDIT mode, and is later selected in the EASY EDIT mode, the displayed value of an attribute may be different from the value when it was stored. The sound itself, however, is exactly as it was stored.

Easy Edit items

- BRILLIANCE:**
Adjust the brightness of the sound.
- VIBRATO DEPTH:**
Set vibrato depth.
- VIBRATO SPEED:**
Set vibrato speed.
- VIBRATO DELAY:**
Set time delay between key played and vibrato start.
- OCT SHIFT:**
Shift the octave range.
- ATTACK:**
Adjust attack time.
- RELEASE:**
Adjust time of sound fade-out after key is released.
- DIG.EFFECT:**
Select type of effect. (Refer to page 118.)

Tone Edit

Modify the separate tones which comprise the sound.

About tones

A sound may be made up of at most four tones.

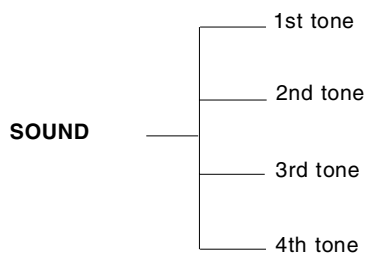

- A special process is used to produce real-sounding piano type tones. For this reason, some edit procedures for piano sounds, FILTER or AMPLITUDE for example, may differ from those for other sounds.

TONE SELECT

1. On the SOUND EDIT menu, select TONE.

- The display looks similar to the following.

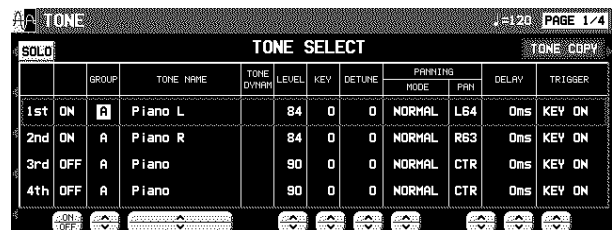

2. Use the buttons to the left of the display to select the tone you wish to edit (1st, 2nd, 3rd, 4th).

- Use the ON/OFF buttons to select ON or OFF.

3. Select a sound for the tone.

- Use the GROUP ^ and v buttons to select the group, and the TONE NAME ^ and v buttons to select the sound.
- A "*" mark in the TONE DYNAM column indicates that a TONE DYNAMICS change was made to the sound.

4. Use the LEVEL ^ and v buttons to adjust the volume.

5. Use the KEY ^ and v buttons to set the pitch of the output sound.

6. Use the DETUNE \wedge and \vee buttons for fine adjustment of the pitch deviation.
7. Use the PANNING \wedge and \vee buttons to adjust the stereo balance.
 - PAN: CTR is the center point. At L64, the sound is all the way to the left, at R63 all the way to the right.
 - If STEREO R or STEREO L is selected for the MODE, the balance is fixed (cannot be moved).
8. Use the DELAY \wedge and \vee buttons to adjust the delay time of the sound.
 - The higher the number, the longer the delay before sound output.
9. Use the TRIGGER \wedge and \vee buttons to select a trigger mode.

KEY ON:

The normal mode, in which sound is emitted when the key is played.

KEY OFF:

Sound is emitted when the key is released (like muted strings, for example).

LEGATO:

Sound is emitted only when the key is played legato.

NON LEG:

Sound is not emitted when the key is played legato.

PEDAL:

The sound is produced only while the **SUSTAIN** button is on.

CHORD:

The sound is emphasized when chords are played (like the cutting sound of a guitar, for example).

■ TONE COPY

You can copy the tone of a particular sound to a specified tone in the sound you are editing.

1. On the 1/4 display, press the TONE COPY button.
2. Use the FROM \wedge and \vee buttons to select the tone to copy from.
 - Use the OPTION \wedge and \vee buttons to select the item you wish to copy.
3. Use the TO \wedge and \vee buttons to select the tone you wish to copy to.
4. Press the OK button.
 - Tone copy is executed.

KEY LAYER

Adjust the relation of tone output to keyboard location.

1. Use the **PAGE** buttons to view the 2/4 display.
 - The display looks similar to the following.

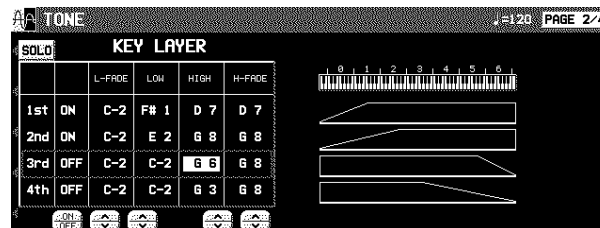

2. Use the buttons to the left of the display to select a tone (1st, 2nd, 3rd or 4th).
3. Use the L-FADE \wedge and \vee buttons and the LOW \wedge and \vee buttons to define the area of the lower range of tone output.
 - By entering different values for the L-FADE and LOW settings, you can define a sloping volume increase to the peak output volume which corresponds to the note pitch.
4. Use the HIGH \wedge and \vee buttons and the H-FADE \wedge and \vee buttons to define the area of the higher range of tone output.
 - By entering different values for the H-FADE and HIGH settings, you can define a sloping volume decrease from the peak output which corresponds to the note pitch.
 - By overlapping the L-FADE and H-FADE curves of each different tone, you can achieve a cross-fade effect, where the sound gradually changes in relation to pitch.
5. Repeat steps 2 to 4 for the other tones, as desired.

VELOCITY LAYER

Adjust these settings to regulate the tone output relative to the velocity.

- Use the **PAGE** buttons to view the 3/4 display.
 - The display looks similar to the following.

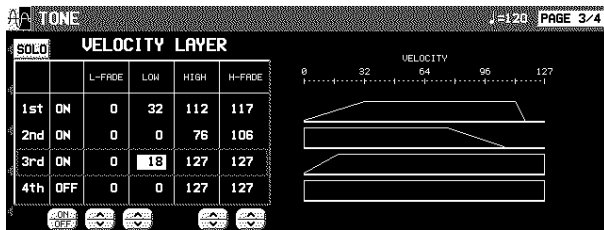

- Use the buttons to the left of the display to select a tone (1st, 2nd, 3rd or 4th).
- Use the L-FADE \wedge and \vee buttons and the LOW \wedge and \vee buttons to define the *pp* sound output area for the lower range.
- Use the HIGH \wedge and \vee buttons and the H-FADE \wedge and \vee buttons to define the *ff* sound output area for the higher range.
 - By overlapping the L-FADE and H-FADE curves of each different tone, you can change the way the tone sounds relative to how hard or softly the keyboard is played.
- Repeat steps 2 to 4 for the other tones, as desired.

TONE DYNAMICS

You can adjust the settings so that a different sound (tone) is output for each tone depending on the velocity (how hard the keys are played).

- Use the **PAGE** buttons to view the 4/4 display.
 - The display looks similar to the following.



- Use the buttons to the left of the display to select a tone.
- Use the \blacktriangle and \blacktriangledown buttons to select the column for the function you wish to adjust.
- Select the tone waveform.
 - Use the GROUP \wedge and \vee buttons to select the sound group. Use the TONE WAVEFORM \wedge and \vee buttons to select the waveform.
- Use the LEVEL ADJUST \wedge and \vee buttons to adjust the volume. Use the FILTER ADJUST \wedge and \vee buttons to set the sound.
- Use the VELOCITY \wedge and \vee buttons to specify the velocity range.
 - When the upper limit of a waveform is set to 127, no more waveforms can be added.
- Repeat steps 3 to 6 to edit the other waveforms, as desired.
- Repeat steps 2 to 7 for the other tones, as desired.

Pitch Edit

Adjust the settings related to the pitch of the sound.

KEY SHIFT & DETUNE

- On the SOUND EDIT menu display, select **PITCH**.
 - The display looks similar to the following.

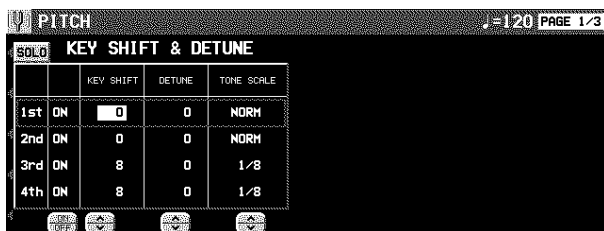

- Use the buttons to the left of the display to select a tone (1st, 2nd, 3rd or 4th).
- Use the KEY SHIFT \wedge and \vee buttons to specify the output pitch.
 - Units are in semitones.

- Use the DETUNE \wedge and \vee buttons to fine-adjust the pitch.
 - Slight differences in the DETUNE values between the tones add fullness to the sound.
- Use the TONE SCALE \wedge and \vee buttons to select the type of scale (NORM, 1/2, 1/4, 1/8, 1/16, 1/32, 1/64, FIX).
 - NORM is the normal scale type. For example, when 1/2 is selected, a difference in pitch between one key and the adjacent key becomes half the normal pitch difference. When FIX is selected, the pitch is the same regardless of which key is played.
- Repeat steps 2 to 5 for the other tones, as desired.

PITCH ENVELOPE

Specify how the pitch changes over time, from the time the key is played to the time the sound dies out.

- Use the **PAGE** buttons to view the 2/3 display.
 - The display looks similar to the following.

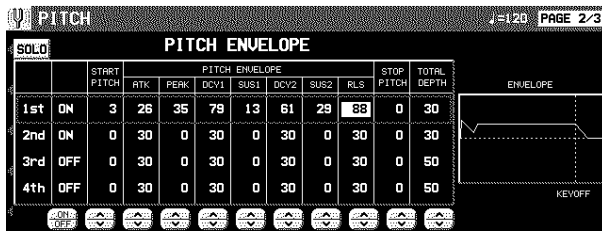

- Use the buttons to the left of the display to select a tone.
- Adjust the settings for the pitch change envelope.
 - Use the buttons below the display to set the corresponding values. The envelope is created on the display as you input the settings.
 - Use the TOTAL DEPTH \wedge and \vee buttons to specify the maximum level.
 - Use the START PITCH \wedge and \vee buttons to set the start point. Use the STOP PITCH \wedge and \vee buttons to set the stop point.
- Repeat steps 2 and 3 for the other tones, as desired.

PITCH ENVELOPE TOUCH & KEY FOLLOW

Specify how the pitch envelope changes in relation to note pitch.

- Use the **PAGE** buttons to view the 3/3 display.

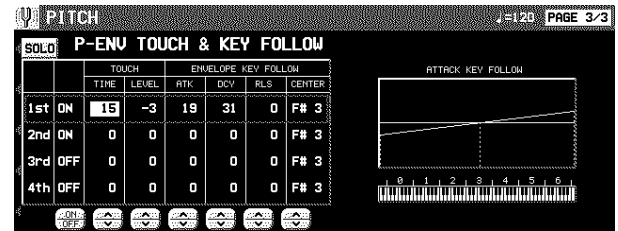

- Use the buttons to the left of the display to select a tone.
- Use the TOUCH \wedge and \vee buttons to change the respective touch settings.
 - Use the TIME \wedge and \vee buttons to specify the time change depending on touch. Use the LEVEL \wedge and \vee buttons to specify the pitch change level depending on touch.
 - At a - setting, the softer the keys are pressed, the greater the change. At a + setting, the harder the keys are pressed, the greater the change.
- Change the key follow settings for the ATTACK (ATK), DECAY (DCY) and RELEASE (RLS).
 - Use the \wedge and \vee buttons corresponding to the ENVELOPE KEY FOLLOW attributes to adjust the settings. Use the CENTER \wedge and \vee buttons to select the center of the bend direction.

Filter Edit

Make major changes to the sound by eliminating specific frequency ranges.

FILTER & EQUALIZER

- On the SOUND EDIT menu, select FILTER.
 - The display looks similar to the following.

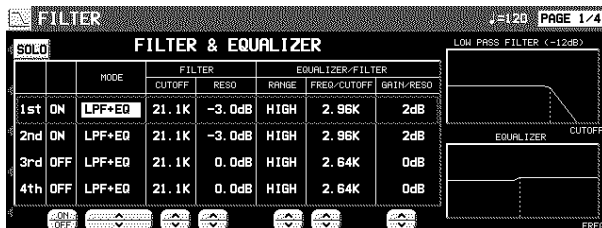

- Use the buttons to the left of the display to select a tone.
- Use the MODE button to select the filter mode.

LPF(6)+EQ (low-pass filter + equalizer)
 Signals higher than the cut-off frequency are cut. Normal sounds are softened.

HPF(6)+EQ (high-pass filter + equalizer)
 Signals lower than the cut-off frequency are cut. Normal sounds are sharpened.

- LPF24** (low-pass filter 24)
 A stronger low-pass filter than LPF+EQ.
 - HPF24** (high-pass filter 24)
 A stronger high-pass filter than HPF+EQ.
 - BPF** (band-pass filter)
 Cuts off signals that are not within in the area between the two specified CUTOFF frequencies.
 - For this mode, adjust the settings on the EQUALIZER/FILTER side as well.
 - THRU**
 No filter effect is applied.
- Use the CUTOFF \wedge and \vee buttons to set the frequency range which is cut by the filter.
 - Use the RESO \wedge and \vee buttons to specify the resonance value (dB).
 - Resonance is effect which adds character to the sound by emphasizing the harmonic components of frequencies close to the cut-off frequency.

<Equalizer>

For LPF(6)+EQ/HPF(6)+EQ filters, the sound quality can be modified by the EQUALIZER.

RANGE

Select the setting range (HIGH or LOW).

FREQ

Set the standard frequency.

GAIN

Set the level increase or decrease from the value set for FREQ (dB).

6. Repeat steps 2 to 5 for each tone, as desired.

TOUCH & KEY FOLLOW

Adjust how the filter is applied relative to touch and pitch.

1. Use the **PAGE** buttons to view the 2/4 display.
 - The display looks similar to the following.

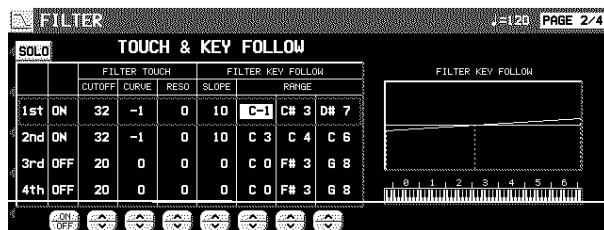

2. Use the buttons to the left of the display to select a tone.
3. Use the FILTER TOUCH \wedge and \vee buttons to modify how the respective filters are applied relative to key touch.
 - Use the CUT OFF \wedge and \vee buttons to specify the amount of change in the cut-off frequency. Use the CURVE \wedge and \vee buttons to specify the curve of change. Use the RESO \wedge and \vee buttons to specify the degree of change in the resonance value.
4. Use the FILTER KEY FOLLOW \wedge and \vee buttons to modify how the respective filters are applied relative to note pitch.
 - Use the SLOPE \wedge and \vee buttons to adjust the bend slope. Use the RANGE \wedge and \vee buttons to specify the pitch range.
5. Repeat steps 2 to 4 for the other tones, as desired.

FILTER ENVELOPE

Specify how the filter changes over time, from the time the key is played to the time the sound dies out.

1. Use the **PAGE** buttons view the 3/4 display.
 - The display looks similar to the following.

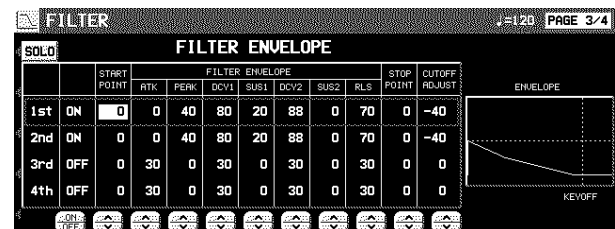

2. Use the buttons to the left of the display to select a tone.
3. Use the FILTER ENVELOPE \wedge and \vee buttons to modify the respective filter envelopes.
 - Use the buttons below the display to adjust the respective settings.
 - You can use the CUTOFF ADJUST buttons to set the total upper and lower settings, the START POINT buttons to set the start point, and the STOP POINT buttons to set the stop point.
4. Repeat steps 2 and 3 for the other tones, as desired.

FILTER ENVELOPE TOUCH & KEY FOLLOW

Specify how the filter envelope (curve) changes relative to touch or note pitch.

- Use the **PAGE** buttons to view the 4/4 display.
 - The display looks similar to the following.

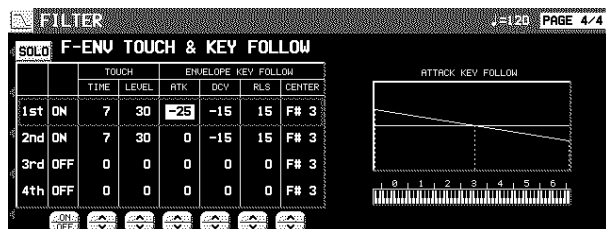

- Use the buttons to the left of the display to select a tone.

- Use the **TOUCH** \wedge and \vee buttons to modify how the respective filter envelopes change relative to touch.
 - Use the **TIME** \wedge and \vee buttons to specify the time change, and the **LEVEL** \wedge and \vee buttons to specify the level, relative to touch.
 - At a $-$ setting, the softer the keys are played, the greater the change. At a $+$ setting, the harder the keys are played, the greater the change.

- Use the **ENVELOPE KEY FOLLOW** \wedge and \vee buttons to modify how the respective filter envelopes change relative to note pitch.
 - Adjust the respective slopes for attack (ATK), decay (DCY) and release (RLS). Use the **CENTER** \wedge and \vee buttons to specify the center of the bend slope by note name.

- Use the **ENVELOPE KEY FOLLOW** \wedge and \vee buttons to modify how the respective filter envelopes change relative to note pitch.
 - Adjust the respective slopes for attack (ATK), decay (DCY) and release (RLS). Use the **CENTER** \wedge and \vee buttons to specify the center of the bend slope by note name.

Amplitude Edit

Adjust the settings related to the volume of the sound.

LEVEL

- On the **SOUND EDIT** menu, select **AMPLITUDE**.
 - The display looks similar to the following.

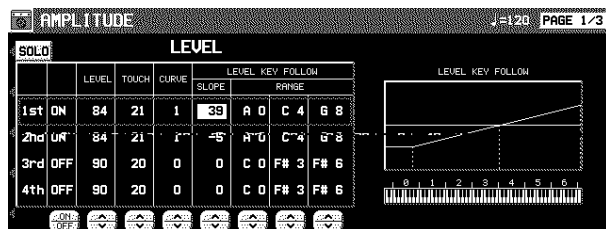

- Use the buttons to the left of the display to select a tone.

- Use the **LEVEL** \wedge and \vee buttons to select the volume.

- Use the **TOUCH** \wedge and \vee buttons to set the amount of volume change in relation to how hard the keyboard is played.
 - At a $-$ value, the softer the keyboard is played, the louder the sound. At a $+$ value, the harder the keyboard is played, the louder the sound.

- Use the **CURVE** \wedge and \vee buttons to select the type of volume curve depending on touch.

- Use the **LEVEL KEY FOLLOW** \wedge and \vee buttons to change the respective key follow settings.
 - Use the **SLOPE** \wedge and \vee buttons to adjust the bend slope. Use the **RANGE** \wedge and \vee buttons to specify the pitch range by note name.

- Use the **LEVEL KEY FOLLOW** \wedge and \vee buttons to change the respective key follow settings.
 - Use the **SLOPE** \wedge and \vee buttons to adjust the bend slope. Use the **RANGE** \wedge and \vee buttons to specify the pitch range by note name.

- Use the **SLOPE** \wedge and \vee buttons to adjust the bend slope. Use the **RANGE** \wedge and \vee buttons to specify the pitch range by note name.

- Repeat steps 2 to 6 for the other tones, as desired.

ENVELOPE

Specify how the volume changes over time, from the time the key is played to the time the sound dies out.

- Use the **PAGE** buttons to view the 2/3 display.
 - The display looks similar to the following.

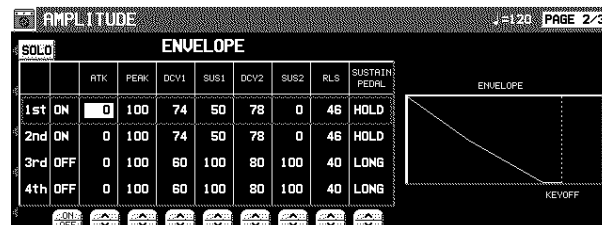

- Use the buttons to the left of the display to select a tone.

- Adjust the settings for the volume envelope.
 - Use the buttons below the display to set the corresponding values. The envelope is created on the display as you input the settings.
 - Use the **SUSTAIN PEDAL** \wedge and \vee buttons to select the type of sustain.

- Use the buttons below the display to set the corresponding values. The envelope is created on the display as you input the settings.
- Use the **SUSTAIN PEDAL** \wedge and \vee buttons to select the type of sustain.

LONG:

Extend the release time of the sound.

HOLD:

Maintain the key-pressed condition.

- Repeat steps 2 and 3 for the other tones, as desired.

ENVELOPE TOUCH & KEY FOLLOW

Specify how the volume changes relative to touch or note pitch over time.

1. Use the **PAGE** buttons to view the 3/3 display.

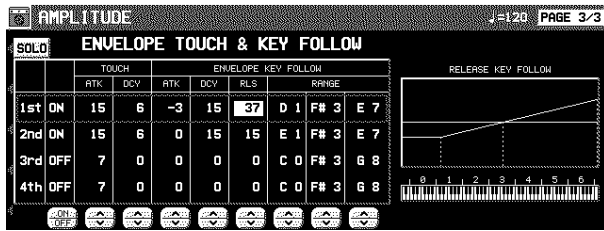

2. Use the buttons to the left of the display to select a tone.

3. Use the TOUCH \wedge and \vee buttons to change the touch settings.

- Use the ATK \wedge and \vee buttons to specify the ATTACK time change depending on touch. Use the DCY \wedge and \vee buttons to specify the DECAY time change depending on touch.
- At a - setting, the softer the keys are pressed, the greater the change. At a + setting, the harder the keys are pressed, the greater the change.

4. Change the key follow settings for the ATTACK, DECAY and RELEASE.

- Use the \wedge and \vee buttons corresponding to the ENVELOPE KEY FOLLOW attributes to adjust the settings. Use the RANGE buttons to specify the keyboard range.

LFO Edit

LFO can be applied to the pitch, amplitude, filter and/or pan to produce a cyclic modulation of the sound.

- Twelve LFO groups can be used.

LFO

1. On the SOUND EDIT MENU display, select LFO.

- The display looks similar to the following.

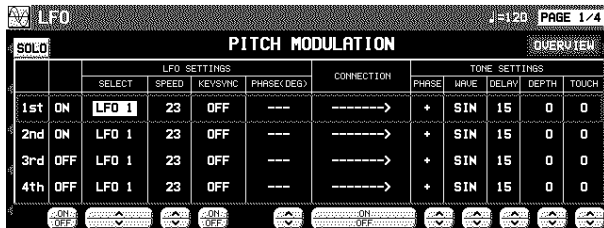

2. Use the **PAGE** buttons to select the respective characteristics.

- PAGE 1/4: PITCH (vibrato effect)
- PAGE 2/4: AMP (tremolo effect)
- PAGE 3/4: FILTER (wah-wah effect)
- PAGE 4/4: PAN (auto pan effect)

3. Use the buttons to the left of the display to select a tone.

4. Use the LFO SETTINGS \wedge and \vee buttons to adjust the respective assigned LFO's.

- LFO which share the same number on other displays are also changed with this adjustment.

SELECT

Select the assigned LFO number (1 to 12)

SPEED

Adjust the modulation speed.

KEYSYNC

When playing more than one note, specify whether the LFO starts or not each time a key is pressed (ON/OFF).

- When KEYSYNC is set to ON: if, while playing one note, you play a second note, the LFO is applied to the second note as well.

PHASE

Degree of phase change.

5. Use the CONNECTION ON/OFF buttons to specify whether or not the LFO is applied to the tone.

- An arrow mark indicates that the LFO is applied.

6. Use the TONE SETTINGS \wedge and \vee buttons to adjust the respective parameters.

PHASE

Phase

- A + indicates normal phase, and a - indicates an inverted phase.

WAVE

Modulate the waveform.

- SIN: Sine wave
- TRI: Triangle wave
- SQR: Square wave
- SAW: Saw tooth wave

DELAY

Delay time is the time elapsed from when the keyboard key is pressed until the modulation begins.

DEPTH

Modulation depth

TOUCH

Degree of modulation change in relation to touch

7. Repeat steps 2 to 6 for the other tones, as desired.

- You can press the OVERVIEW button to confirm the status of each LFO setting.

Effect Edit

These are settings related to the various effects applied to your edited sound.

EFFECT

1. On the SOUND EDIT menu display, select EFFECT.

- The display looks similar to the following.

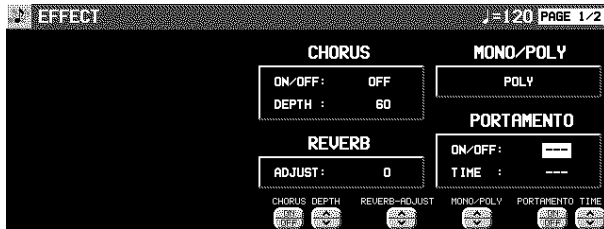

2. Use the respective CHORUS ^ and v buttons to specify how the CHORUS is applied.
3. Use the REVERB ADJUST ^ and v buttons to specify how the REVERB is applied.
4. Use the MONO/POLY ^ and v buttons to select the sound output mode.
5. MONO: Use the PORTAMENTO ON/OFF buttons set portamento to on or off. Use the TIME ^ and v buttons to set the portamento time.

DIGITAL EFFECT

1. Use the PAGE buttons to view the 2/2 display.
 - The display looks similar to the following.
 - The display for the effect type which is best-suited for the sound currently being edited is selected.

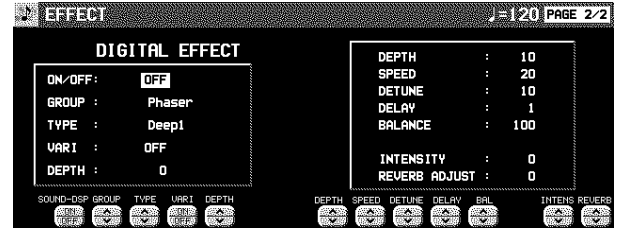

2. Use the TYPE ^ and v buttons to select the type of effect.

<ON/OFF button>

Specify whether the DIGITAL EFFECT button turns on or off when the sound is selected. When set to ON, the DIGITAL EFFECT button turns on automatically when the sound is selected.

<STEREO/MONO button>

Select stereo (STEREO) or monaural (MONO) output of the effect.

3. Use the buttons along the bottom of the display to select the attribute you wish to adjust.

- When the type is changed, the parameters revert to the factory defaults.

Controller Edit

Specify how operation of the controllers, such as the wheels, etc., affects the sound.

- These settings are effective when the instrument receives controller data.

CONTROLLER

1. On the SOUND EDIT menu display, select CONTROLLER.

- The display looks similar to the following.

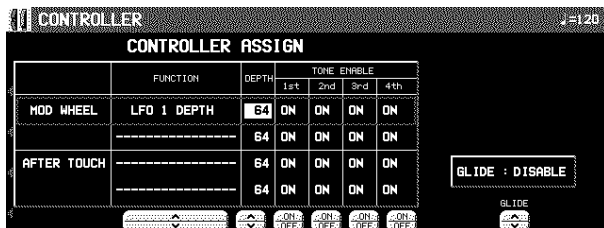

2. Use the buttons to the left of the display to select a controller.

- Two functions can be assigned to each controller.

3. Use the FUNCTION ^ and v buttons to select a function for the controller.

4. Use the DEPTH ^ and v buttons to set the depth of the function applied by the controller.

5. Use the TONE ENABLE ON/OFF ^ and v buttons to set the controller to on or off for each tone.

- When set to INV, the effect is applied inversely.

6. Repeat steps 2 to 5 for the other controllers, as desired.

7. Use the GLIDE ^ and v buttons to select whether or not the glide effect is active.

ENABLE:

The glide effect is enabled.

DISABLE:

The glide effect is disabled.

Store the new sound

The **MEMORY** button in the **SOUND GROUP** section accesses memory banks reserved for the sounds you create with the **SOUND EDIT**. You can store up to 40 original sounds then select the sounds just like the other sounds in the **SOUND GROUP**.

Procedure

- When you have edited the sound to just the way you like it, on the **SOUND EDIT** menu display press the **WRITE** button.
 - The display changes to the **MEMORY WRITE** display.

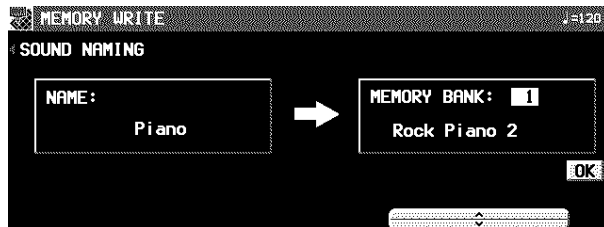

- To assign a name to your new sound, press the **SOUND NAMING** button.
 - If you do not assign a name to your sound, the name becomes the same as the original sound from which you started. In this case, skip to step 5.
 - The display changes to the **SOUND NAMING** display.



- Use the buttons below the display to assign a name.
 - Press the **ABC** button to enter alphabetical characters. While the **SHIFT** button is pressed, upper case letters are entered.
 - Press the **123** button to enter numbers, etc. While the **SHIFT** button is pressed, you can enter symbols.
 - Press the **POSITION** button to move the cursor.
 - You can also use the **TEMPO/PROGRAM** dial to select the characters.
 - Press the **INS** button to enter a space at the cursor position.
 - Press the **DEL** button to erase the character at the cursor position.
 - Press the **CLR** button to erase the entire name.
 - Press the **→←** button to center the name.
- When you have finished typing the name, press the **OK** button.
 - The display returns to the **MEMORY WRITE** display.
- Use the **^** and **v** buttons to select the **MEMORY** number in which to store the new sound (1–40).
- Press the **OK** button.
 - The new sound is stored, and "COMPLETED!" is shown on the display.
 - The **SOUND EDIT** mode is turned off.
- The stored sound memories can be saved on a disk for recall at a later time. (Refer to page 99.)

Select a new sound

You can select your original sound just like the other sounds in the **SOUND GROUP**.

- In the **SOUND GROUP** section, press the **MEMORY** button.

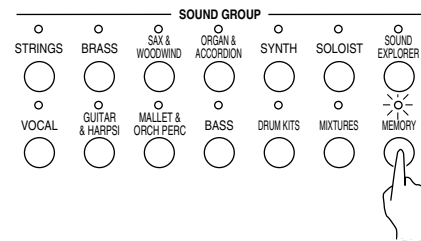

- The list of sounds is shown on the display.
- Select the desired sound from the list on the display.

Part X Control

Outline of Control functions



Various settings related to the operation of this instrument are adjusted with the CONTROL functions.

1. Press the **PROGRAM MENU** button to turn it on.



• The display looks similar to the following.



2. Select **CONTROL**.

• The display looks similar to the following.



3. Select a function.

INITIAL

Return the settings and memories to the factory-preset status. (Refer to page 135.)

PEDAL SETTING (page 121)

Various functions can be assigned to the soft and sostenuto pedals.

FADE IN/OUT SETTING

Settings related to the **FADE IN/FADE OUT**. (Refer to page 51.)

PANEL MEMORY MODE

Define which panel settings are stored when the **PANEL MEMORY** is used. (Refer to page 56.)

MUSIC STYLE ARRANGER MODE

Define which panel settings change by pressing a **FILL IN** button when the **MUSIC STYLE ARRANGER** is used. (Refer to page 54.)

4. Follow the procedure to adjust the settings.

• While you are adjusting the settings, when the **TEMPO/PROGRAM** indicator is lit, it indicates that the dial is available for setting the current function.

5. When you have finished setting the functions, press the **PROGRAM MENU** button to turn it off.

Pedal Setting

By assigning one of the many programmable functions to each of the soft and sostenuto pedals, you can then control the function during your performance just by pressing the pedal.

1. On the CONTROL MENU display, select PEDAL SETTING.

- The display looks similar to the following.

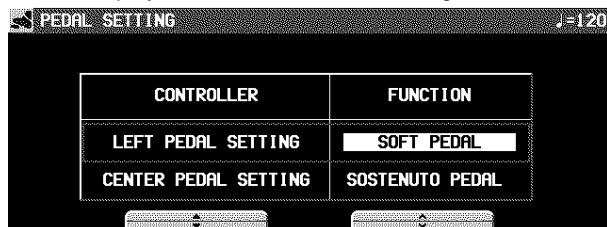

2. Use the ▲ and ▼ buttons to select a pedal, and the ^ and v buttons to select its function.

OFF:

No function is assigned.

SOFT PEDAL:

Soft pedal on/off

SOSTENUTO PEDAL:

Sostenuto pedal on/off

P. MEM INCREMENT:

Increment the **PANEL MEMORY** number selection by 1.

P. MEM DECREMENT:

Decrement the **PANEL MEMORY** number selection by 1.

P. MEM BANK INC.:

Change to the next **PANEL MEMORY** bank in order.

P. MEM BANK DEC.:

Change to the previous **PANEL MEMORY** bank in order.

PANEL MEMORY 1 to 8:

The specified **PANEL MEMORY** number is turned on.

P. MEM INC.+DEC.:

Press the switch to increment the **PANEL MEMORY** number selection by one; release the switch to return to the previous number.

START/STOP:

START/STOP button on/off

FILL IN 1:

FILL IN 1 button on

FILL IN 2:

FILL IN 2 button on

INTRO & ENDING 1:

INTRO & ENDING 1 button on

INTRO & ENDING 2:

INTRO & ENDING 2 button on

GLIDE:

Glide on/off (The glide effect “bends” the pitch down by about one semitone.)

- This effect does not work for some sounds.

TECHNI-CHORD:

TECHNI-CHORD button on/off

DIGITAL EFFECT:

DIGITAL EFFECT button on/off

MULTI EFFECT:

MULTI EFFECT button on/off

ROTARY SLOW/FAST:

TREMOLO SLOW/FAST of the **DIGITAL DRAWBAR**

MIC REVERB:

MIC REVERB on/off

MIC EFFECT:

MIC EFFECT on/off

PUNCH RECORD:

Punch in/punch out (Refer to page 70.)

APC HOLD:

Memorize the chord specified for the automatic accompaniment.

FADE IN:

FADE IN button on/off

FADE OUT:

FADE OUT button on/off

PAD 1 to 6 (**PR804**):

Specified **PIANO PERFORMANCE PADS** on

TAP TEMPO:

TAP TEMPO button on

- If the PEDAL SETTING function in the DATA PROTECTION menu is set to OFF, the setting contents may change during song playback, etc. If you do not wish the setting contents to change, set PEDAL SETTING to ON. (Refer to page 123.)
- In the **PROGRESSIVE PIANIST** mode, if you set TURN PAGE to MANUAL, the LEFT PEDAL functions to turn the display page.

Part XI Customize

Outline of Customize functions

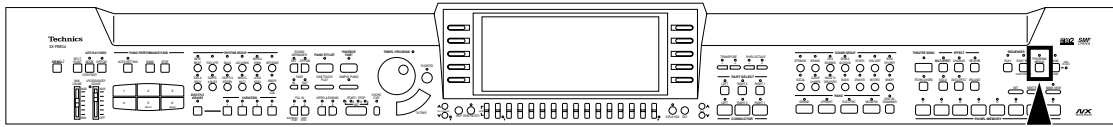

Many of this instrument's settings can be customized for maximum playing convenience and ease.

1. Press the **PROGRAM MENU** button to turn it on.

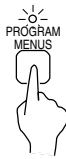

- The display looks similar to the following.



2. Select **CUSTOMIZE**.

- The display looks similar to the following.



(PR804)

3. Select a function.

FAVORITES SETTING

FAVORITES display settings (page 33)

DISPLAY TIME OUT (page 123)

Adjust settings related to the screen display.

DATA PROTECTION (page 123)

Specify when you don't want the data to change in cases where it normally does, for instance during disk load and when automatic settings are made, etc.

MIDI SETTING LOAD OPTION (page 124)

Specify how MIDI data is handled when data is loaded from a disk.

LANGUAGE SETTING

Select your preferred language for the displayed messages.

- The display is different, but the operation is the same as for **HELP** (page 32).

DISK PREFERENCES

Automatic display when a floppy disk is inserted (page 102).

VIDEO OUT MODE SETTING (PR804) (page 124)

Change the output mode for the **VIDEO OUT** terminal.

THEATRE SONIC SPEAKER MODE (PR804) (page 125)

Specify a mode when **THEATRE SONIC** is set to ON.

4. Follow the procedure to adjust the settings.

- While you are adjusting the settings, when the **TEMPO/PROGRAM** indicator is lit, it indicates that the **TEMPO/PROGRAM** is available for setting the current function.

5. When you have finished setting the functions, press the **PROGRAM MENU** button to turn it off.

Display Time Out

Numerous message displays and setting displays conveniently guide you through the operation steps of this instrument. Once you become familiar with the operation of your instrument, however, you may wish to shorten or even suspend the display time of the message displays.

1. On the CUSTOMIZE MENU display, select **DISPLAY TIME OUT**.

- The display looks similar to the following.

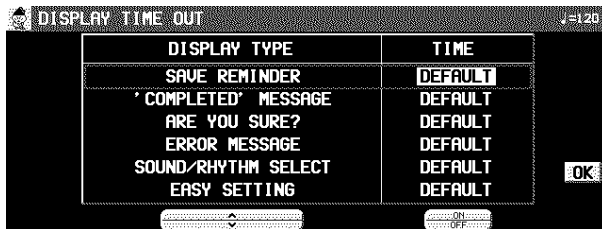

2. Use the DISPLAY TYPE ▲ and ▼ buttons to select the function.

SAVE REMINDER:

Reminder display (OFF, DEFAULT, HOLD, 1 to 10 sec)

'COMPLETED' MESSAGE:

Operation successfully completed (OFF, DEFAULT, HOLD, 1 to 10 sec)

ARE YOU SURE?:

Display requires user action for confirmation (OFF, DEFAULT, HOLD)

ERROR MESSAGE:

Error notification display (DEFAULT, HOLD, 1 to 10 sec)

SOUND/RHYTHM SELECT:

Sound/rhythm and **PIANO PERFORMANCE PADS (PR804)** BANK selection display (DEFAULT, HOLD, 1 to 10 sec)

EASY SETTING:

Display time when the setting display was accessed pressing and holding a panel button (DEFAULT, HOLD, 1 to 10 sec)

- When set the OFF, the display will not appear.
- When set to DEFAULT, the display time returns to the initialized setting.
- You can specify 1 to 10 seconds for the display time.
- When set to HOLD, the **DISPLAY HOLD** automatically turns on.

3. Use the TIME ^ and v buttons to change the setting.

4. Press the OK button.

- Some messages may be displayed even if they are set to OFF.

Data Protection

Data which you don't want to change but which is normally overwritten during disk load, song change, or the automatic setting functions, etc. can be protected from accidental overwriting.

1. In the CUSTOMIZE MENU display, select **DATA PROTECTION**.

- The display looks similar to the following.

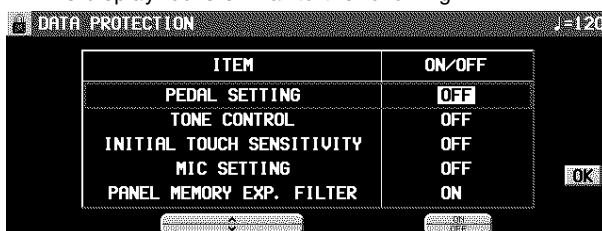

2. Use the ITEM ^ and v buttons to select an item.

3. Use the ON/OFF button to select ON or OFF.

ON: The data is protected and will not be changed.
OFF: The data is not retained.

4. Repeat steps 2 and 3 for each item.

5. Press the OK button.

MIDI Setting Load Option

Specify how MIDI data is handled when data is loaded from a disk.

1. On the CUSTOMIZE MENU display, select MIDI SETTING LOAD OPTION.

- The display looks similar to the following.

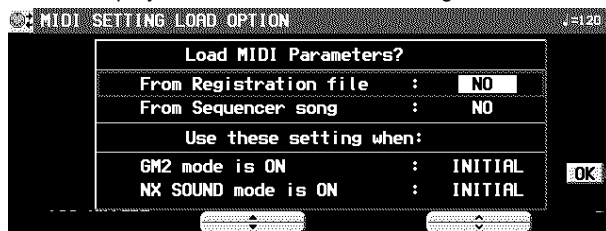

2. Use the ▲ and ▼ buttons to select an item.

■ Load MIDI Parameters?

From Registration file:

- Specify whether MIDI data is also loaded when panel data is loaded (NO/YES).

From Sequencer Song:

Specify whether MIDI data is loaded or changed when **SEQUENCER** data is loaded or when the SONG is changed by the **SEQUENCER SONG SELECT**, **SONG COPY** or **TRACK ASSIGN** (NO/YES).

- The MIDI settings are always stored at the start of each recorded **SEQUENCER SONG** and when **PANEL WRITE** is executed. In the initialized state, the MIDI settings are not loaded even when the SONG is changed. However, changing this setting to YES will cause the stored MIDI settings to also load in these cases.

■ Use these settings when:

GM2 mode ON:

Specify how the MIDI settings of this instrument are affected when GM2 is on.

- Select from INITIAL, (initialized settings), PRESET (MIDI PRESETS), and KEEP (the settings do not change).

NX SOUND mode ON:

Specify how the MIDI settings of this instrument are affected when NX SOUND is ON.

- Select from INITIAL, (initialized settings), PRESET (MIDI PRESETS), and KEEP (the settings do not change).

3. Use the ^ and v buttons to change the setting.

4. Press the OK button.

Video Out Mode Setting (PR804)

Select the output mode for the **VIDEO OUT** terminal when viewing display images, such as SLIDE SHOW or lyrics, on your external video monitor or TV.

1. On the CUSTOMIZE MENU display, select VIDEO OUT MODE SETTING.

- The display looks similar to the following.

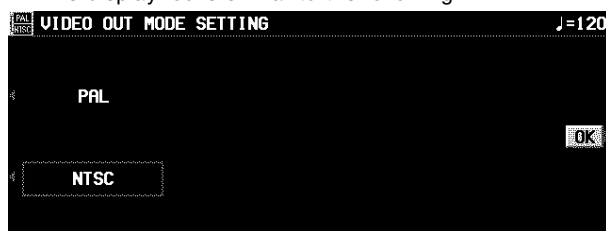

2. Select PAL or NTSC.

- This setting is kept even after the power is turned off.

Theatre Sonic Speaker Mode (PR804)

Specify whether the THEATRE SONIC effect is to be created using only speakers of the instrument or using external rear speakers as well.

1. On the CUSTOMIZE MENU display, select THEATRE SONIC SPEAKER MODE.

- The display looks similar to the following.

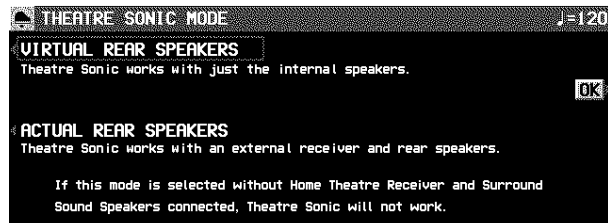

2. Select a mode.

VIRTUAL REAR SPEAKERS:

The effect is created using only internal speakers.

ACTUAL REAR SPEAKERS

The effect is created using external rear speakers as well.

- Do not select this mode when no external speakers are connected.

3. Press the OK button.

- For connection of external rear speakers, refer to page 136.

Part XII MIDI

What is MIDI?

MIDI (Musical Instrument Digital Interface) is the international standard for digital communication of electronic musical instrument data. This means that any equipment which has a MIDI terminal—such as electronic musical instruments and personal computers—can easily exchange digital data with other MIDI equipment without resorting to complicated conversions or connections.

MIDI terminals

(On the rear panel)

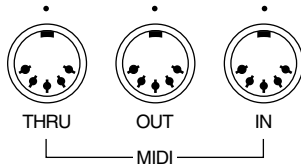

IN:

The terminal by which this instrument receives data from other equipment.

OUT:

The terminal that transmits data from this instrument to other equipment.

THRU:

The terminal that transfers data from the **IN** terminal directly.

- For these connections, use a commercially available MIDI cable.

Connection examples

■ To generate sound from a connected instrument by playing this instrument

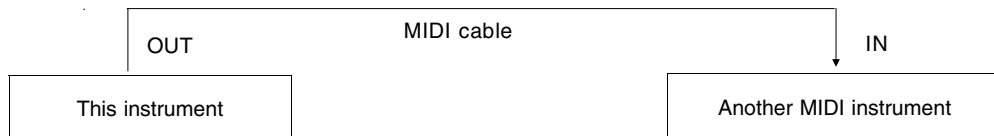

■ To generate sound from this instrument by operating a connected instrument

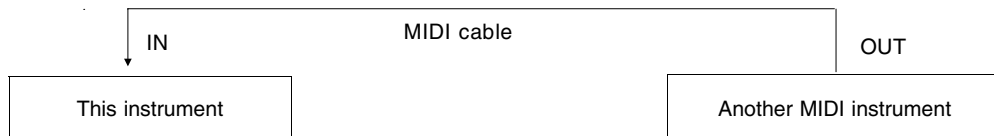

■ To connect with a MIDI sequencer

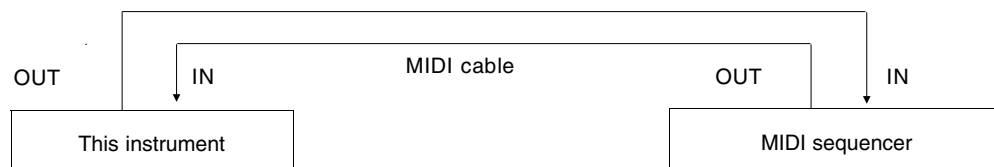

MIDI channels

Many different kinds of performance data are sent using just one MIDI cable. This is possible because MIDI signals are sent and received through 16 different “basic channels” (numbered 1 to 16). In order for the exchange of data to take place, the channels on the transmission side must match the channels on the receiving side. This characteristic also makes it possible to link multiple sound generators and to control each by matching specific channels.

The following kinds of data can be transmitted/received.

■ NOTE data

This is the most basic kind of MIDI data which is exchanged, and is used to specify which keys are played and how hard they are played.

NOTE NUMBER: Number specifying which key is played.

NOTE ON: Specifies that a key is played.

NOTE OFF: Specifies that a key is released.

VELOCITY: Specifies how hard a key is struck.

- MIDI notes are assigned numbers from 0 to 127, with middle C (C3) as 60. Note pitches are in semitone increments, with the higher numbers assigned to the higher pitches.

■ PROGRAM CHANGE

This is sound change data. When a different sound is selected on the transmitting instrument, the sound on the receiving instrument also changes.

■ CONTROL CHANGE

These are volume, sustain, effect, etc. data used to enhance performance expression. Each function is distinguished by its control number, and the function which can be changed by the control differs depending on the instrument.

■ EXCLUSIVE data

This is data that is specific to this instrument, and data for the GENERAL MIDI LEVEL 2 mode setting.

Outline of MIDI functions

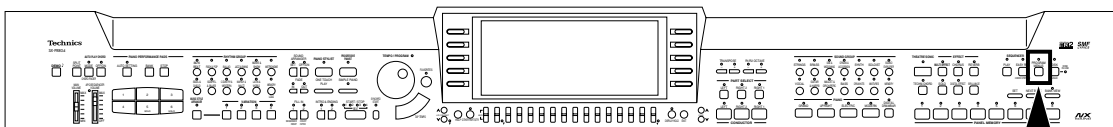

1. Press the **PROGRAM MENUS** button to turn it on.

- The display looks similar to the following.



2. Select MIDI.

- The display looks similar to the following.

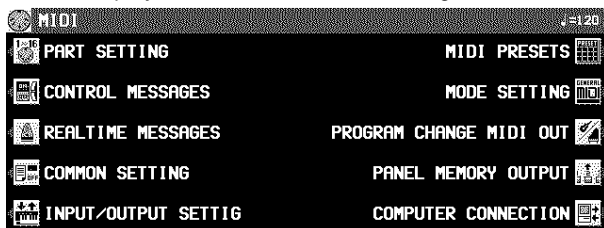

3. Select a function.

4. Follow the procedure to adjust the settings.

- While you are adjusting the settings, when the **TEMPO/PROGRAM** indicator is lit, it indicates that the **TEMPO/PROGRAM** is available for setting the current function.

5. When you have finished setting the functions, press the **PROGRAM MENUS** button to turn it off.

Summary of the MIDI menu items

PART SETTING (page 128)

Set the MIDI CHANNEL, OCTAVE and LOCAL CONTROL settings for each part.

CONTROL MESSAGES (page 129)

Enable or disable the exchange of various CONTROL data.

REALTIME MESSAGES (page 129)

Enable or disable the exchange of REALTIME COMMANDS, and select the CLOCK mode.

COMMON SETTING (page 130)

Set the functions which are common to all parts.

INPUT/OUTPUT SETTING (page 131)

Settings which determine how various performance data is treated during data transmission and reception.

MIDI PRESETS (page 132)

Establish the optimum settings depending on how this instrument is connected to other equipment.

- You can save the settings you specify yourself.

MODE SETTING (page 131)

NX SOUND and GM LEVEL 2 ON setting

PROGRAM CHANGE MIDI OUT (page 133)

Settings for transmitting the desired PROGRAM CHANGE data on the specified MIDI channel.

PANEL MEMORY OUTPUT (page 133)

Settings that affect the transmission data when the **PANEL MEMORY** buttons are operated.

COMPUTER CONNECTION (page 134)

Mode settings related to the flow of MIDI signals when this instrument is connected to a personal computer.

Part Setting

Follow this procedure to set the functions which can be set for each part: MIDI CHANNELS, the OCTAVE data to NOTE data during transmission, and LOCAL CONTROL (whether or not the sound generator of this instrument is active during transmission).

1. On the MIDI MENU display, select PART SETTING.

- The display looks similar to the following.

PART	CHANNEL	OCTAVE	LOCAL
RIGHT1	1	0	ON
RIGHT2	2	0	ON
LEFT	3	0	ON
CONTROL	OFF	---	---
CHORD	OFF	0	ON

2. Use the PART ▲ and ▼ buttons to select a part.

- The list of parts covers 4 pages. Use the **OTHER PARTS/TR** button or **PAGE** button to view different parts.

3. Use the CHANNEL ^ and v buttons to select a MIDI CHANNEL for the part (OFF, 1 to 16).

- A part which has been set to OFF cannot be used to transmit or receive MIDI data.
- The initialized settings are as follows:

RIGHT 1	1
RIGHT 2	2
LEFT	3
PART 1	OFF
PART 2	OFF
PART 3	OFF
PART 4	4
PART 5	5
PART 6	6
PART 7	7
PART 8	8
PART 9	9
PART 10	10
PART 11	11
PART 12	12
PART 13	13
PART 14	14
PART 15	15
PART 16	16
CONTROL	OFF
ACCOMP 1 – 5	OFF
BASS	OFF
DRUMS 1 – 2	OFF
CHORD	OFF

4. Use the OCTAVE ^ and v buttons to set the octave shift value (–3 to 3).

- Octave shift is set for transmitted data only; however the transmitted and received octave shifts are linked. For example, if the transmitted octave shift is set to 1, the received octave shift is automatically set to –1.

5. Use the LOCAL ON and OFF buttons to enable or disable this instrument's sound generator.

- When set to ON, the performance from this instrument is transmitted as MIDI data and also sounds from this instrument. When set to OFF, the performance from this instrument is transmitted as MIDI data but does not sound from this instrument.

6. Repeat steps 2 to 5 for each part as desired.

Control Messages

Enable or disable the exchange of various control data.

1. On the MIDI MENU display, select CONTROL MESSAGES.

- The display looks similar to the following.
- The CONTROL MESSAGES display consists of 3 pages. Use the **PAGE** buttons to switch between pages.

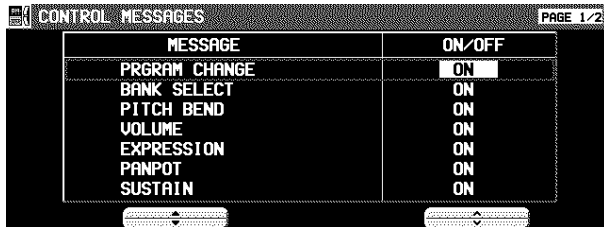

2. Use the MESSAGE ▲ and ▼ buttons to select the control message.

3. Use the OFF/ON buttons to specify on or off for the control message.

ON: Data for the control operation is exchanged.

OFF: Data for the control operation is not exchanged.

- The BANK SELECT setting is effective only when PRG. CHANGE is set to ON.
- The EFFECT & REVERB setting controls the **DIGITAL EFFECT, CHORUS, MULTI EFFECT** and **REVERB** on/off.
- RPN is the general term for KEY SHIFT, TUNING, PITCH BEND RANGE and MODULATION SENSITIVITY.

4. Repeat steps 1 and 2 for each control as desired.

Realtime Messages

Enable or disable the exchange of **START/STOP** data (REALTIME COMMANDS), and select the CLOCK mode.

1. On the MIDI MENU display, select REALTIME MESSAGES.

- The display looks similar to the following.



2. Use the buttons on the left side of the display to select a function.

3. Use the ▲ and ▼ buttons to change the setting.

REALTIME COMMANDS

ON: Rhythm and **SEQUENCER** start/ stop, continue, and song position pointer data can be transmitted/received.

OFF: This data cannot be transmitted/received.

CLOCK

INTERNAL: This instrument's internal clock is used to control the performance. The clock of the connected equipment is disabled.

MIDI: The clock of the connected equipment is used to control the performance. This instrument's clock is disabled. (The tempo is displayed as “♪ = - - -.”)

- The CLOCK is set to INTERNAL when the power to this instrument is turned on.

4. Repeat steps 2 and 3 for the other function if desired.

Common Setting

Set the functions which are common to all parts.

1. On the MIDI MENU display, select COMMON SETTING.

- The display looks similar to the following.

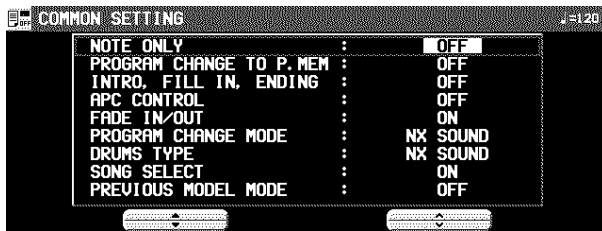

2. Use ▲ and ▼ buttons to select the item.

NOTE ONLY:

Of the performance data, specify whether or not only note data is exchanged.

PROGRAM CHANGE TO P. MEM:

Enable or disable the exchange of program change numbers for the **RIGHT 1** part by operation of the **PANEL MEMORY** buttons.

- For this setting, the **PANEL MEMORY 1** to **8** program change numbers correspond to the bank numbers as follows:

BANK A = 0 to 7

BANK B = 8 to 15 ...

INTRO, FILL-IN, ENDING:

Enable or disable the exchange of intro, fill-in and ending data.

APC CONTROL:

Enable the exchange of data for the on/off status of the **AUTO PLAY CHORD** modes.

FADE IN/OUT:

Specify whether or not FADE IN/OUT data is exchanged.

PROGRAM CHANGE MODE

NX SOUND:

Program change numbers are standardized among NX SOUND Technics models which are set to this mode. The program change number assigned to a given sound on one model is assigned to the same sound on all models which are set to the same mode.

PREV. TECH:

Program change numbers are standardized among non-NX SOUND Technics models which are set to this mode. The program change number assigned to a given sound on one model is assigned to the same sound on all models which are set to the same mode.

MAP R:

GS basic sounds are transmitted and received as GS program change numbers.

MAP Y:

XG basic sounds are transmitted and received as XG program change numbers.

* GS is a trademark of Roland Corporation. XG is a trademark of Yamaha Corporation.

DRUMS TYPE

NX SOUND:

Keyboard percussion instrument sounds correspond to the same key note numbers for connected NX SOUND Technics models that are set to this type.

PREV. TECH:

Keyboard percussion instrument sounds correspond to the same key note numbers for connected non-NX SOUND Technics models that are set to this type.

SONG SELECT

ON: Song number data can be exchanged.

OFF: Song number data cannot be exchanged.

PREVIOUS MODEL MODE

ON: INTRO, FILL IN, ENDING and APC CONTROL, FADE IN/OUT data are converted to CONTROL CHANGE data for previous models* and then transmitted.

OFF: The above settings are not converted.

* "Previous models" include all Technics instrument models except for:

KN7000/6500/6000

PR604/804/603/703/903/1000

3. Use ^ and v buttons to change the setting.

4. Repeat steps 2 and 3 for the other settings as desired.

Mode Setting

Initialize the settings for when the NX SOUND or GM LEVEL 2 mode is ON.

1. On the MIDI MENU display, select MODE SETTING.

- The display looks similar to the following.



2. Select the mode.

- There are two modes for GM LEVEL 2 depending on the parts to use.
- The confirmation display appears. Press the YES button to execute the function, or press the NO button to cancel the function.
- When using an external sequencer in GM LEVEL 2, select <Ext. Sequencer> in the MIDI PRESETS options.

Input/output Setting

Make the settings which determine how various performance data is treated during data transmission and reception.

1. On the MIDI MENU display, select INPUT/OUTPUT SETTING.

- The display looks similar to the following.

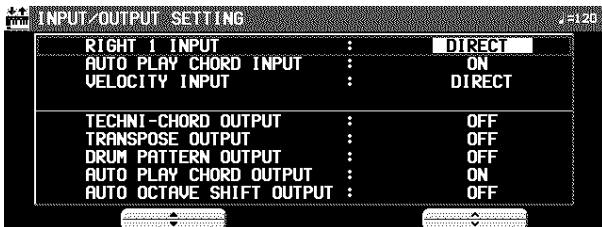

2. Use the ▲ and ▼ buttons to select the item.

RIGHT 1 INPUT

CONDUCTOR:

When data for the **RIGHT 1** part is received, the **CONDUCTOR** determines which part it is used for.

DIRECT:

When data for the **RIGHT 1** part is received, it is treated as **RIGHT 1** data, and performance data for all parts is received on their respective basic channels.

AUTO PLAY CHORD INPUT

ON: Input data for the **ACCOMP**, **BASS**, **DRUMS** and **CHORD** parts is received.

OFF: Data for the above parts is not received.

- MIDI channels should be assigned to the above parts before exchanging data.

VELOCITY INPUT

DIRECT:

The **VELOCITY** value of received NOTE ON data is treated as is.

OFFSET:

The **VELOCITY** value of received NOTE ON data is offset (-50 to 50).

- Select **VELOCITY OFFSET VALUE**. Use the ▲ and ▼ buttons to change the value.
- All the values are offset from the current value by the fixed amount.

- The upper (127) and lower (1) limits cannot be exceeded.

FIX:

The **VELOCITY** value of all received NOTE ON data is set to a fixed value. (1 to 127)

- Select **VELOCITY FIXED VALUE**. Use the ▲ and ▼ buttons to change the value.

TECHNI-CHORD OUTPUT

ON: Keyboard notes generated by the **TECHNI-CHORD** function are also transmitted.

OFF: Only key note data of the pressed keys is transmitted.

TRANSPOSE OUTPUT

ON: The note data of the transposed notes is transmitted.

OFF: The note data of the played keys is transmitted.

DRUM PATTERN OUTPUT

ON: Data from the **DRUMS** part is transmitted.

OFF: Data from the **DRUMS** part is not transmitted.

AUTO PLAY CHORD OUTPUT

ON: The data for the **ACCOMP**, **BASS** and **CHORD** parts is transmitted.

OFF: The data for the above parts is not transmitted.

- MIDI channels should be assigned to the above parts before exchanging data.

AUTO OCTAVE SHIFT OUTPUT

ON: If the octave has been automatically changed, the data of the transposed notes is transmitted, depending on the sound.

OFF: The note data of the played keys is transmitted.

3. Use the ▲ and ▼ buttons to select the setting.

4. Repeat steps 2 and 3 for each item as desired.

MIDI Presets

Establish the optimum settings depending on how this Keyboard is connected to other equipment, and on whether this Keyboard is used as the master or the slave.

1. On the MIDI MENU display, select MIDI PRESETS.

- The display looks similar to the following.

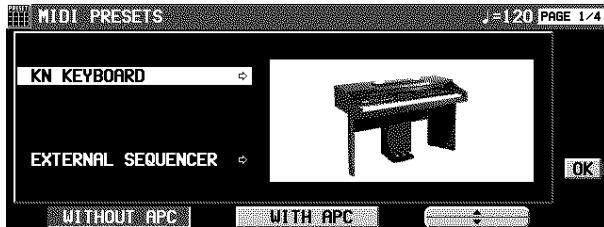

2. Use the ▲ and ▼ buttons to select the connection setup.

- The PAGE 1/4 display shows connection setups with this instrument as the SLAVE. And the PAGE 2/4 display shows connection setups with this instrument as the MASTER.
- The MASTER is the instrument used to transmit data, and the SLAVE is the instrument used to receive the data.
- Use the buttons below the display to select WITHOUT APC (the **AUTO PLAY CHORD** is not used) or WITH APC (the performance includes **AUTO PLAY CHORD**).

3. Press the OK button.

- When the settings have been successfully stored, "COMPLETED!" appears on the display.

Notice

When an instrument such as an organ or accordion with separate or divided keyboards dedicated to melody and chords is used as the master instrument, if this instrument's split point is set to a note below the lowest note of the melody keyboard of the master instrument, it is possible to produce melody notes on multiple parts by this instrument's **CONDUCTOR** settings.

- Assign the RIGHT 1 channel as the CHANNEL for the melody keyboard. Assign the CHORD channel (or if you also wish the played note to be produced, CHORD + LEFT) as the CHANNEL for the chord keyboard.
- You will also have to specify CONDUCTOR as the RIGHT 1 INPUT for the INPUT/OUTPUT SETTING.

■ Storing user settings

After you change the MIDI settings, you can store your customized settings in USER preset memory.

1. Adjust the various MIDI settings.
2. Go to PAGE 4/4 of the MIDI PRESETS display.

- The display looks similar to the following.



3. Use the WITH SPLIT POINT? button to specify whether or not to also store the keyboard split point (YES/NO).

4. Press the WRITE button.

■ Recalling the USER settings

1. Go to PAGE 3/4 of the MIDI PRESETS display.



2. Press the OK button.

Program Change MIDI Out

Use this function to immediately transmit specific PROGRAM CHANGE and BANK SELECT data from this display on a specified MIDI channel.

1. On the MIDI MENU display, select PROGRAM CHANGE MIDI OUT.

- The display looks similar to the following.

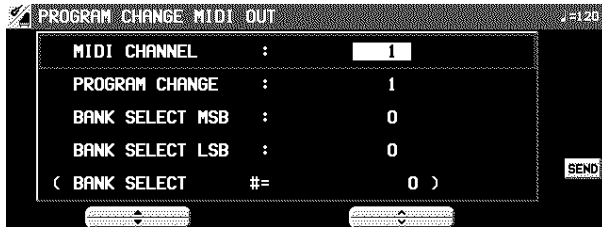

2. Use the ▲ and ▼ buttons to select a function.

MIDI CHANNEL:

The MIDI channel to transmit to (1 to 16).

PROGRAM CHANGE:

Specify the PROGRAM CHANGE number to transmit (1 to 128).

BANK SELECT MSB:

Specify the BANK SELECT MSB to transmit (0 to 127).

BANK SELECT LSB:

Specify the BANK SELECT LSB to transmit (OFF, 0 to 127).

- When set to OFF, neither the LSB nor the MSB are transmitted.

3. Use the ^ and v buttons to change the setting.

4. Press the SEND button.

- The specified data is transmitted.
- The data is unconditionally transmitted regardless of the other settings.

Panel Memory Output

These are settings affect the transmission data when the **PANEL MEMORY** buttons are operated.

1. On the MIDI MENU display, select PANEL MEMORY OUTPUT.

- The display looks similar to the following.

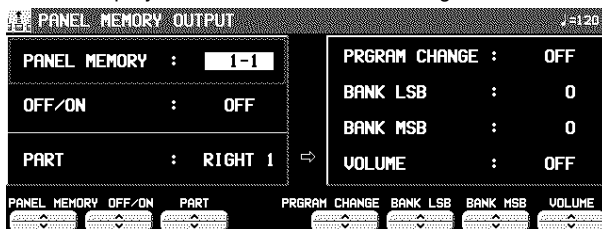

2. Use the P.MEM ^ and v buttons to select a **PANEL MEMORY** number.

3. Use the OFF/ON ^ and v buttons to specify whether the data in the selected **PANEL MEMORY** number is transmitted or not.

4. Use the PART ^ and v buttons to select a part (RIGHT 1, RIGHT 2 or LEFT).

5. Use the P. CNG ^ and v buttons to specify a program change number (0 to 127, or OFF).

6. Use the BANK LSB ^ and v buttons to specify a BANK LSB (0 to 127).

7. Use the BANK MSB ^ and v buttons to specify a BANK MSB (0 to 127).

8. Use the VOL ^ and v buttons to specify the volume (0 to 127, or OFF).

9. Repeat steps 4 to 7 for each part, as necessary.

10. Repeat steps 3 to 9 for each **PANEL MEMORY** number, as necessary.

Computer Connection

These settings are used to select the mode related to MIDI signal flow when a personal computer is connected to the **USB** terminal of this instrument.

- When connecting to a personal computer, install the USB driver on the included CD-ROM to the computer first. (Refer to the separate manual for more information.)

1. Turn off the power to this instrument.
2. Connect a personal computer to the **USB** terminal on the rear of this instrument.
3. Turn on the power to this instrument.
4. On the MIDI MENU display, select **COMPUTER CONNECTION**.
 - The display looks similar to the following.

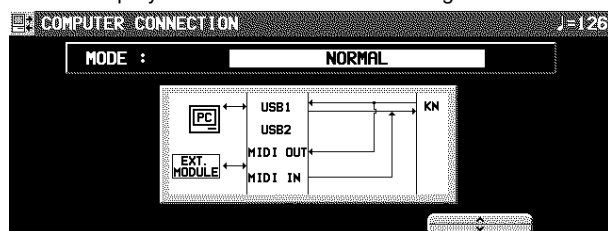

5. Use the \wedge and \vee buttons to select a mode.

NORMAL:

Ordinary mode

PC as master:

The mode which is appropriate for data transmission

PR as master:

The mode when this instrument is used as the master keyboard.

PR as slave:

The mode when this instrument is used as a slave instrument.

INTERFACE:

The mode when this instrument is used as a connecting device between a PC with only USB terminals and an instrument with only MIDI terminals.

Initialize

This instrument has many settable functions and storable memories. However, you can return the settings and memory to the factory-preset status.

INITIAL

1. Press the **PROGRAM MENU** button to turn it on.

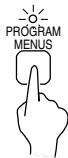

- The display changes to the following.



2. Select **CONTROL**. (PR804)

- The display looks similar to the following.



3. Select **INITIAL**.

- This display changes to the following.

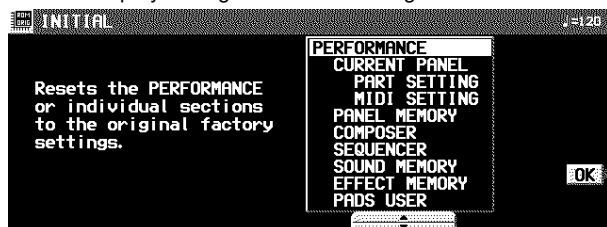

(PR804)

4. Use the **▲** and **▼** buttons to select the desired type of initialization.

- **PERFORMANCE** includes all the items which are listed below it.

5. Press the **OK** button.

- The display changes to the confirmation display. Press the **YES** button if you wish to execute the initialization. Press the **NO** button if you wish to cancel the procedure.

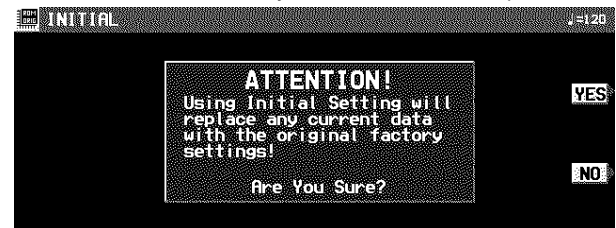

- Initialization begins. When initialization is completed, "COMPLETED!" is shown on the display and this instrument returns to the normal performance mode.

- The **MIDI** & **FAVORITES** are not initialized by this procedure.

You can also reset all the **PERFORMANCE** items with the following procedure:

Turn off the power to this instrument once. Then, while pressing the three lower left buttons in the **RHYTHM GROUP** section (**SOUL & DISCO**, **GOSPEL & BLUES** and **COUNTRY & WESTERN**) at the same time, turn the power on again.

Power on settings

When the **POWER** button of this instrument is turned on, the settings below are automatically set to those suitable for piano performance.

Sound	GRAND PIANO (CONCERT)
CONDUCTOR	RIGHT 1
TRANSPOSE	C
R1/R2 OCTAVE	Off
SYNCHRO START	Off
AUTO PLAY CHORD	Off
All PART SETTING items for the RIGHT 1 part	Appropriate values
PEDAL SETTING	Left: SOFT Center: SOSTENUTO

- When you turn the power on, you can recall all the settings which were in effect at the time you turned the instrument off: while depressing the sustain (right) pedal, turn on the power.

Connections

(on the rear panel)

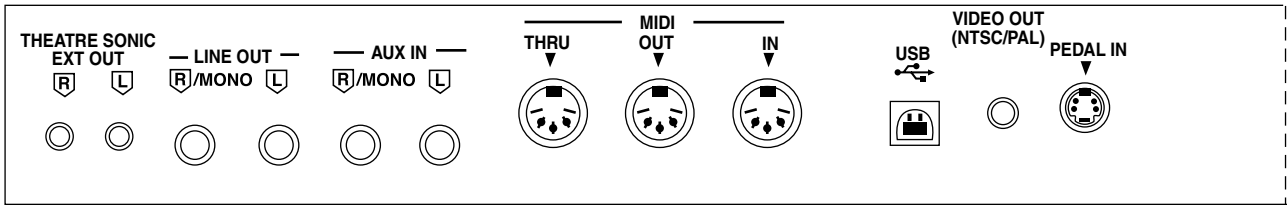

(PR804)

THEATRE SONIC EXT OUT (PR804)

External rear speakers for the THEATRE SONIC effect can be connected to these terminals. (Refer to page 124.)

AUX IN (input level 0.5 Vrms, 6 k Ω)

Other instruments such as a sound generator can be connected to this terminal, and the sound will be output from this instrument's speakers. To receive monaural sound, connect the other instrument to the **R/MONO** terminal. (Do not connect the **L** terminal.)

LINE OUT (output level 1.5 Vrms, 600 Ω)

By connecting an external high-power amplifier, the sound can be reproduced at a high volume. To output monaural sound, connect the external equipment to the **R/MONO** terminal. (Do not connect the **L** terminal.)

MIDI

These terminals are for connection to another MIDI instrument. (Refer to page 126.)

USB

This terminal allows connection to a personal computer with a USB cable (commercially available type AB cable). Used with the applications on the included CD-ROM, you can record this instrument's audio sound or manage the instrument data with your PC.

• Applications

Audio Recorder:

Application for Recording this instrument's sounds and for saving recorded digital audio files in WAV, WMA (Windows Audio Format) and MP3 formats.

Song Manager:

Application for managing this instrument's data on your PC by means of a USB cable.

VIDEO OUT (PR804)

The display images or lyrics when playing songs, and the image of the normal display are output through this terminal.

- The output mode (**NTSC/PAL**) can be selected. (See page 124.)

(beneath the left end of keyboard)

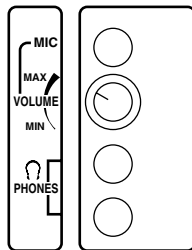

PHONES \times 2

Headphones can be connected to this instrument.

- When headphones are plugged into this jack, the speakers of this instrument are disabled.

MIC

A microphone can be connected to this instrument and the sound output through the speakers. Use the **VOLUME** control to adjust the volume.

- Effects such as reverb can be applied to the microphone input. (Refer to page 41.)

Assembly (PR604)



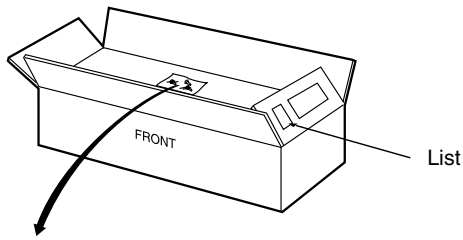

Follow the steps below to assemble your Technics piano. Make sure you are using the correct parts and that they are in the correct direction.

- At least 2 people are required for assembly.
- To disassemble the piano, reverse the procedure.

1. Remove the packing and take the parts out of the carton. Confirm that all the parts on the printed list are present.



2. The following parts are in the screw kit.

	Brass-colored screw 4
	Black screw (A) 6
	Black screw (B) 4
	Clamp 3

3. Affix the right and left side planks to the pedal box.

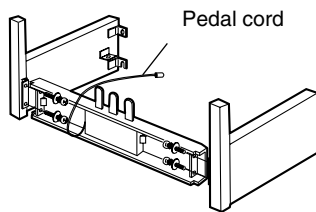

- (1) Use the 4 brass-colored screws to secure the planks.
- (2) Loosen the pedal cord, stowed on the inner side of the pedal box, and extend it.

4. Affix the rear panel.

- Use 2 black screws (A) and 4 black screws (B) to affix the rear panel.

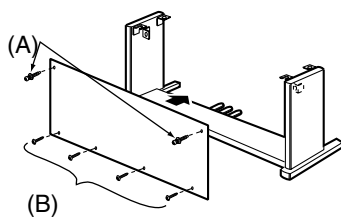

5. Place the piano body on the stand.

WARNING:
Avoid pinching your fingers.

Note 1
Holding the piano body at least 10 cm in from the edge, place it on the stand so that it does not fall off.

Note 2
If the piano body is placed too far to the right or left, or to the front or back, it will become unstable.

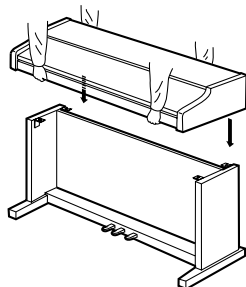

6. Secure the piano body to the stand.

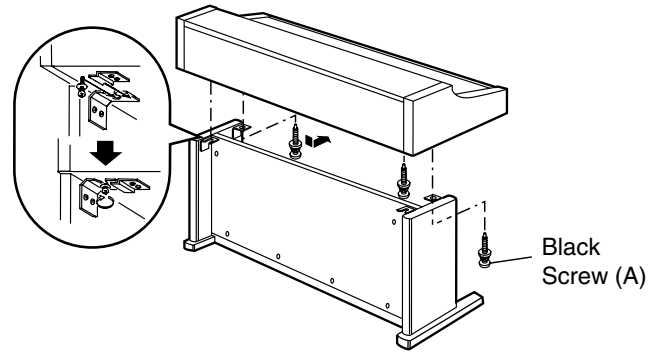

- (1) Insert 2 screws in the 2 rear screw holes on the underside of the piano body, and turn each screw 5 or 6 times. Push the piano body forward so that the screws are fully inserted in the cutout of the metal piece on either side plank. (This enables you to easily position the piano body on the stand.)
- (2) Adjust the piano body so that the right and left sides project evenly over the stand.

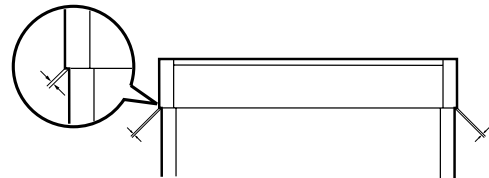

- (3) Positioning the piano body on the stand, confirm that the 4 screws can easily be inserted.
- (4) Tighten the 4 screws securely.

7. Connect the pedal cord and power cord to the terminals.

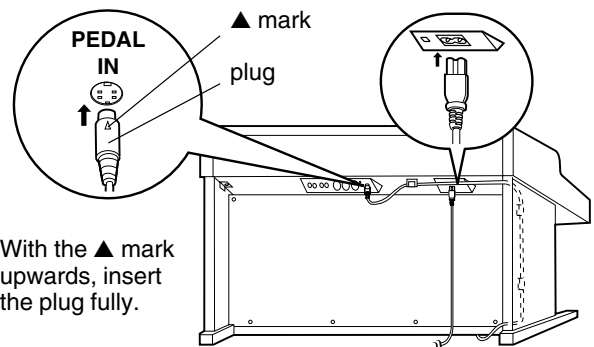

- (1) Plug the pedal cord and power cord into the terminals on the rear of the piano.
- (2) Remove the backing from the clamps and affix them as shown in the figure. Secure the pedal cord to the clamps.

Confirm: After assembling, check these points.

- Are any parts left over?
→ Check the assembly procedure again.
- Does the piano rattle when it is rocked?
→ Make sure all the screws are securely tightened.
- Is the power cord firmly inserted?
→ Check again.
- Is the plug of the pedal cord inserted as far into the connector terminal as it will go?
→ If it is not completely inserted, the sustain and other pedal functions may not work.

■ When the piano has been moved or transported, retighten the screws securely.

Assembly (PR804)



Follow the steps below to assemble your Technics piano. Make sure you are using the correct parts and that they are in the correct direction.

- At least 2 people are required for assembly.
- To disassemble the piano, reverse the procedure.

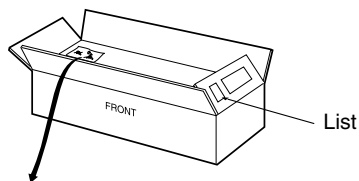
1. Remove the packing and take the parts out of the carton. Confirm that all the parts on the printed list are present.



2. The following parts are in the screw kit.

-  Black screws (long) 2
-  Black screws (short) 12
-  Black screws (slim) 2

3. Affix the pedal box to the speaker box.

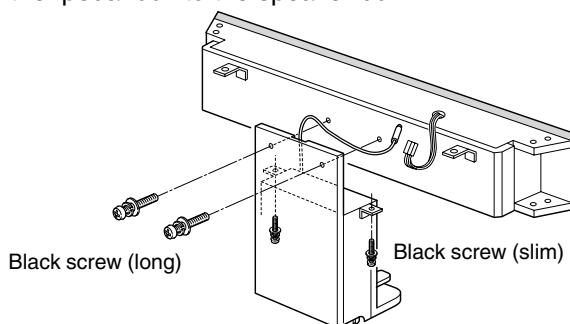

4. Affix the right and left side panels to the speaker box.

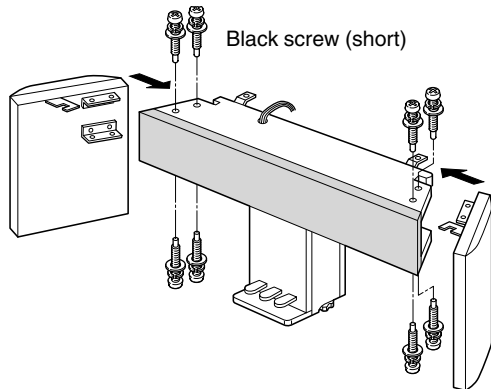

5. Place the piano body to the stand.

WARNING:
Avoid pinching your fingers.

Note 1
Holding the piano body at least 10 cm in from the edge, place it on the stand so that it does not fall off.

Note 2
If the piano body is placed too far to the right or left, or to the front or back, it will become unstable.

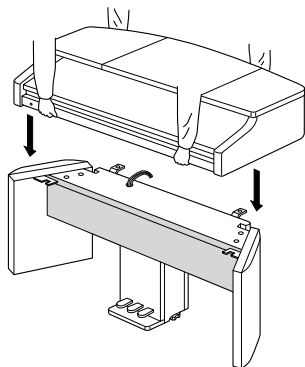

6. Secure the piano body to the stand.

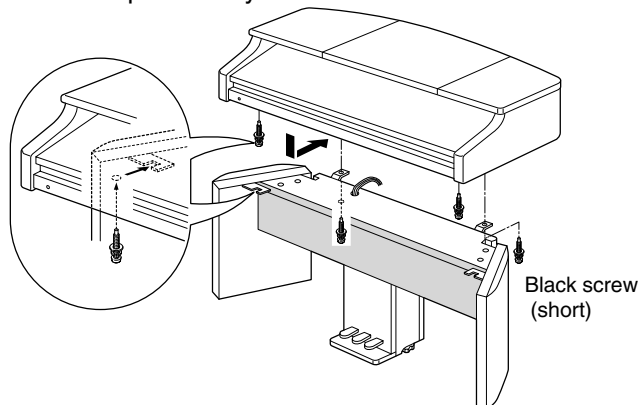

- (1) Insert 2 screws in the left and right screw holes on the front underside of the piano body, and turn each screw for 5 or 6 revolutions to fix them temporarily. Set the piano body so that the screws hitch over the side panels, and slide the piano body to fix its position.
- (2) Once the position is fixed, tighten the screws securely to fasten the piano body.

7. Connect the pedal cord, power cord and speaker cord to the terminals.

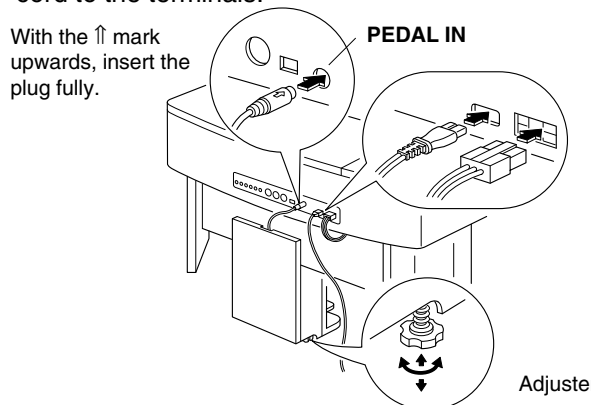

- (1) Plug the pedal chord, power cord and speaker cord into the terminals on the rear of the piano.
- (2) When the piano is in place, turn the adjuster to stabilize the pedal box.

Confirm: After assembling, check these points.

- Are any parts left over?
→ Check the assembly procedure again.
 - Does the piano rattle when it is rocked?
→ Make sure all the screws are securely tightened.
 - Are the speaker cord and power cord firmly inserted?
→ Check again.
 - Is the plug of the pedal cord inserted as far into the connector terminal as it will go?
→ If it is not completely inserted, the sustain and other pedal functions may not work.
 - Does the pedal box move when the pedals are pressed?
→ Turn the adjuster to stabilize the pedal box.
- When the piano has been moved or transported, retighten the screws securely.

Symptoms which appear to be signs of trouble

The following changes in performance may occur in the Technics Keyboard but do not indicate trouble.

	Phenomenon	Remedy
Sounds and effects	The buttons, keys, etc. malfunction.	<ul style="list-style-type: none"> • Turn off the POWER button once, then turn it on again. If this procedure is not successful, turn off the POWER button once. Then, while pressing the three lower left buttons in the RHYTHM GROUP section (SOUL & DISCO, GOSPEL & BLUES, COUNTRY & WESTERN) at the same time, turn the POWER button on again. (Note that, in this case, all programmable settings, functions and memories return to their factory-preset status.)
	No sound is produced when the keys are pressed.	<ul style="list-style-type: none"> • The MAIN VOLUME is at the minimum setting. Adjust the volume with the MAIN VOLUME control. • The volumes for the selected parts are set to the minimum levels. Use the balance buttons to set the volumes of the relevant parts to appropriate levels. (Refer to page 31.) • The part is muted. (Refer to page 31.) • The LOCAL CONTROL for a part performed on the keyboard is set to OFF. Set the LOCAL CONTROL to ON. (Refer to page 128.)
	Only percussive instrument sounds are produced when the keyboard is played.	<ul style="list-style-type: none"> • In the SOUND GROUP section, the DRUM KITS button is on.
	The volume is very low when the keyboard is played.	<ul style="list-style-type: none"> • The volume setting in the SEQUENCER contents is very low. Follow the INITIAL procedure to reset the settings. (Refer to page 135.)
	The sound you hear is different from the sound you selected.	<ul style="list-style-type: none"> • This sometimes occurs when you play back SEQUENCER or COMPOSER data which was created on a different model, or when MIDI data is received from a connected instrument. Select the desired sounds again.
	The sustain does not work even when the sustain pedal is depressed.	<ul style="list-style-type: none"> • The sustain pedal is not connected. Connect the pedal cord firmly to the PEDAL IN terminal on the back of the instrument.
	The sostenuto pedal and soft pedal do not operate properly. For example, when the soft pedal is depressed, the rhythm starts or a fill-in is played.	<ul style="list-style-type: none"> • Different functions can be programmed in these pedals. You can return the pedals to their original functions by turning off the instrument once, or by using the PEDAL SETTING mode. (Refer to page 120.)
Rhythm	The rhythm does not start.	<ul style="list-style-type: none"> • The DRUMS volume is set to the minimum level. Use the balance buttons to set the DRUMS volume to an appropriate level. • A SEQUENCER PLAY button is on. When you are not playing back the SEQUENCER performance, turn off the SEQUENCER PLAY button. • CLOCK is set to MIDI. Set CLOCK to INTERNAL. (Refer to page 129.)
AUTO PLAY CHORD	No sound is produced for the automatic accompaniment, or only the sounds of some parts are produced.	<ul style="list-style-type: none"> • An ACCOMP part does not sound if its corresponding volume is set to the minimum level. Use the respective balance buttons to set the ACCOMP 1–5 volumes to appropriate levels.
SEQUENCER	Storage is not possible.	<ul style="list-style-type: none"> • The remaining memory capacity of the SEQUENCER is 0. Follow the SONG CLEAR or TRACK CLEAR procedure to erase the memory. (Refer to pages 77, 78.)
	The playback measure indication is different from when the performance was recorded.	<ul style="list-style-type: none"> • The number of measures corresponds to the time signature of the rhythm selected at the start of recording. To change the rhythm in the middle of the song, record the rhythm change in the RHYTHM part. (Refer to page 75.)

Phenomenon		Remedy
COMPOSER	Storage is not possible.	<ul style="list-style-type: none"> The remaining memory capacity of the COMPOSER is 0.
	Setting the time signature and number of measures is not possible.	<ul style="list-style-type: none"> The time signature and number of measures cannot be changed for a pattern which is currently recorded in the COMPOSER. If you wish to change the time signature and/or measure data, first follow the procedure to clear the memory. (Refer to page 86.)
	The playback timing of the rhythm pattern is different from the timing with which it was recorded.	<ul style="list-style-type: none"> The QUANTIZE function was on when the pattern was recorded and the timing was automatically corrected. Set the quantize level to a smaller note unit or to OFF when recording. (Refer to page 88.)
Disk Drive	The Disk Drive produces a noise during recording or playback.	<ul style="list-style-type: none"> This occurs when the Disk Drive is reading a disk. It does not indicate a problem.
	When the procedure to load from a disk is performed, the contents of the keyboard memory are erased.	<ul style="list-style-type: none"> When performing the load operation from a disk, this instrument's memory changes to that of the data loaded from the disk. If you wish to preserve a song which is stored in this instrument's memory, save it on a disk before performing the load procedure. (Refer to page 99.)
MIDI	Data cannot be exchanged through MIDI terminals.	<ul style="list-style-type: none"> Match the channels on the transmitting side and the receiving side. (Refer to page 127.)
	The sound quavers or is distorted.	<ul style="list-style-type: none"> When the USB terminal or both the MIDI IN and OUT terminals are connected to a computer, depending on the computer software the received data may be sent back to the instrument just as it is. Because of this the sound generated from the keys and the sound generated from the returned data are both produced, causing undesirable effects, such as the sounds canceling each other out, for example. In this case, either change the software settings to prevent received data from being returned, or set the MIDI LOCAL CONTROL to off.
Other	Noise from a radio or TV can be heard.	<ul style="list-style-type: none"> This sometimes occurs when electrical equipment such as a radio or TV is used near the instrument. Try moving such electrical equipment further away from the instrument. The sound may be coming from a nearby broadcast station or amateur radio station. If the sound is bothersome, consult your dealer or service center.
	The cabinet becomes warm during use.	<ul style="list-style-type: none"> This instrument has a built-in power source that heats the cabinet to some degree. This is not an indication of trouble.

Error messages

No.	Contents
00	The data on the disk that you are using is for a different product.
01	An error has occurred while the disk was loading. Please try again!
02	There is no disk in the Disk Drive.
03	The file that you tried to load is empty.
05	An error has occurred while the disk was saving. Please try again!
06	The disk that you are using is write protected. Please remove the write protection and try again.
07	The disk that you are using is full. Please use another disk.
08	An error has occurred while the disk was formatting. The disk that you are using may be faulty. Please try formatting another disk.
10	The data is already copy protected.
15	The song you are trying to save is empty.
16	This STANDARD MIDI FILE is incompatible with this instrument and cannot be loaded.
17	This is not a STANDARD MIDI FILE.
18	The timebase (PPQ resolution) that you tried to load is not 24/48/96/192/288/384 PPQ.
20	A problem has occurred with your SEQUENCER Data. This might be due to a damaged or faulty disk.
21	Memory full
22	It is necessary to press REC STOP to complete this procedure.
23	It is impossible to change the time signature because it has already been set in the existing tracks.
24	A rhythm track already exists. It is impossible to assign two tracks to rhythm.
25	It is only possible to change the velocity on a melody track.
26	It is only possible to merge melody tracks. Tracks such as rhythm, chord and control cannot be merged.
27	It is only possible to copy melody tracks. Tracks such as rhythm, chord and control cannot be copied.
28	This song is too long to be saved as a MIDI file.
29	The MIDI file that you have tried to load exceeds the memory capacity of this instrument and cannot be played. The SEQUENCER memory has been cleared.
30	It is not possible to change the time signature or measure length of a COMPOSER pattern after it has been recorded. If you want to proceed, you must first clear the entire COMPOSER pattern.

No.	Contents
31	The time signature of the pattern from which you are copying is different from the COMPOSER memory that you are using. Either: Change the time signature of the COMPOSER memory or: Copy from a pattern that has the same time signature
32	Memory full
33	Select a Track before setting parameters for AUTO PUNCH RECORD.
43	The file that you are trying to load was saved on a previous model. It is only possible to load using the "PERFORMANCE" option.
44	It is impossible to edit a Drum Kit. Please select a different sound from any group except Keyboard Percussion.
46	It is only possible to insert MELODY Tracks. Tracks such as RHYTHM, CHORD and CONTROL cannot be inserted.
47	This procedure is not possible with a composer pattern or the metronome. Please select a preset rhythm pattern.
54	It is not possible to record using preset banks, compile banks, or control banks. Please select one of the user banks.
55	Special tracks such as CHORD (APC), RHY and CTL exist in the song from which you are copying and are incompatible with the destination song because it is in the GM mode.
56	AUTO PUNCH recording has been unsuccessful because SEQUENCER operation was interrupted before the PUNCH OUT measure was reached.
58	The song that you have tried to load exceeds this instrument's available memory and cannot be loaded. The selected song memory has been cleared.
62	The computer connection is not active because the computer port switch is set to MIDI. Please turn the power off, set the switch to the desired setting and turn the power back on.
64	Please select the Panel Memory that you want to name.
65	It is not possible to use the CHORD FINDER in this mode. Please select CHORD FINDER from HOME page or CHORD STEP RECORD page.
66	SOLO pads are special pads which include Chord information. Please use SOLO pads when the rhythm and accompaniment is playing.
67	There are no APC or CHORD tracks. Select and APC track or CHORD track, and try again.
68	It is not possible to record directly into the SOLO pads. Record on the SEQUENCER and Copy the melody and chord information into a SOLO pad.
69	It is not possible to delete all measures.
70	It is not possible to insert over 16 measures in a PATTERN.
71	It is not possible to set the start measure to the measures you set to copy.

Index

A

ADVANCED	47
APC CONTROL (MIDI)	130
APC/SEQUENCER VOLUME	50, 69
AUTO PLAY CHORD	47
AUTO PLAY CHORD INPUT (MIDI)	131
AUTO PLAY CHORD OUTPUT (MIDI)	131
AUTO SETTING (PR804)	57
AUX IN	136

B

BACKUP	94
Backup memory (PR604)	10
Backup memory (PR804)	12
BANK (PR804)	57
BANK VIEW	55
BASIC	47
BEAT	45
BEND RANGE	104
BRILLIANCE	41

C

CHORD FINDER	50
CHORD STEP RECORD	74
CHORUS	40
CLOCK (MIDI)	129
COMMON SETTING (MIDI)	130
COMPOSER	85
COMPUTER CONNECTION	134
CONDUCTOR	36
Connections	136
CONTRAST	31
CONTROL	120
CONTROL MESSAGES (MIDI)	129
COUNT INTRO	46
CUSTOMIZE	122

D

DEMO	17
DIGITAL DRAWBAR	35
DIGITAL EFFECT	40
DIRECT PLAY	98
Disk Drive	94
DISK	95
Display	31
DISPLAY TIME OUT	123
DISPLAY HOLD	32
DRUM PATTERN OUTPUT (MIDI)	131
DRUMS TYPE (MIDI)	130

E

EASY REC	65
Error messages	141
EXIT	32

F

FADE IN/OUT	51
FAVORITES	33
FILL IN	47
FINGERED	47

FLOPPY DISK FORMAT	99
--------------------	----

G

GENERAL MIDI LEVEL 2	95
GLIDE	121

H

Headphones	136
HELP	33

I

INITIAL	135
INPUT/OUTPUT SETTING (MIDI)	131
INTRO & ENDING	46

K

KEY SCALING	107
KEY SHIFT	103

L

LANGUAGE SETTING	122
LEFT HOLD	49
LINE OUT	136
LOAD	96
LOCAL (MIDI)	128

M

MAIN VOLUME	14
MASTER TUNING	107
MEASURE COPY	81
MEASURE ERASE	81
MEMORY, RHYTHM GROUP	89
MEMORY, SOUND GROUP	119
METRONOME	45
MIC	136
MIDI	126
MIDI PRESETS	132
MIDI SETTING LOAD OPTION	124
MIXER	105
MODE SETTING	131
MODULATION	118
MULTI EFFECT	39
Music stand	14
MUSIC STYLE ARRANGER	54
MUTE	31

N

NOTE EDIT	78
NOTE ONLY (MIDI)	130

O

ON BASS	48
ONE FINGER	47
ONE TOUCH PLAY	52
OTHER PARTS/TR	31

P

PAGE	32
PAN	104
PANEL MEMORY	55
PANEL MEMORY OUTPUT (MIDI)	131

PART SELECT	34
PART SETTING (SOUND)	103
PART SETTING (MIDI)	127
PATTERN COPY	92
Pedal	38
PEDAL SETTING	121
PERFORMANCE	94
PIANIST	47
PIANO STYLIST	53
PIANO PERFORMANCE PADS (PR804)	57
PROGRAM CHANGE MODE (MIDI)	130
PROGRESSIVE PIANIST	16
PUNCH RECORD	70

Q

QUANTIZE, COMPOSER	88
QUANTIZE, SEQUENCER	77

R

REALTIME COMMANDS (MIDI)	128
REALTIME RECORD	65
REVERB	41
RHYTHM GROUP	44
RIGHT 1 INPUT (MIDI)	131
RIGHT 1/RIGHT 2 OCTAVE	37

S

SAVE	99
SET	55
SEQUENCER	61
SEQUENCER PLAY	67
SEQUENCER RESET	67
SEQUENCER SONG SAVE	101
SIMPLE PIANO	15
SINGLE LOAD	96
SMF LOAD	97
SMF SAVE	101
SOLO	41
SONG CLEAR	77
SONG SELECT	70
SOUND	103
SOUND ARRANGER	52
SOUND EXPLORER	35
SOUND EDIT	110
SOUND GROUP	34
Specifications	144
SPLIT POINT	37
Standard MIDI File	95
START/STOP	45
STEP RECORD	71
STEP RECORD: CHORD	74
STEP RECORD: RHYTHM	75
STOP (PR804)	57
SUSTAIN	103
SYNCHRO START	45

T

TAP TEMPO	45
TECHNI-CHORD	43
TEMPO	45
TEMPO/PROGRAM	45
THEATRE SONIC (PR804)	29
TONE CONTROL	109
TOUCH SENSITIVITY	39

TRACK ASSIGN	76
TRACK CLEAR	78
TRACK MERGE	80
TRANSPOSE	42
Troubleshooting	139

U

USB	136
-----	-----

V

VARIATION	44
VELOCITY CHANGE	83
Volume balance	31

Specifications

		SX-PR604/M	SX-PR804/M
KEYBOARD		88 KEYS	
SOUND GENERATOR		PCM	
MAX. POLYPHONY		64 NOTES	128 NOTES
SOUNDS	NUMBER OF SOUNDS	1039 SOUNDS (1005 SOUNDS + 2 ORGAN DRAWBARS + 32 DRUM KITS)	1123 SOUNDS (1082 SOUNDS + 2 ORGAN DRAWBARS + 39 DRUM KITS)
	PIANO GROUP	GRAND, UPRIGHT, ELECTRIC, MODERN	
	SOUND GROUP	GUITAR & HARPSI, STRINGS, BRASS, VOCAL, SAX & WOODWIND, ORGAN & ACCORDION, SYNTH, MALLET & ORCH PERC, BASS, DRUM KITS, SOUND EXPLORER, MIXTURES, DIGITAL DRAWBAR	GUITAR & HARPSI, STRINGS, BRASS, VOCAL, SAX & WOODWIND, ORGAN & ACCORDION, SYNTH, MALLET & ORCH PERC, BASS, DRUM KITS, SOUND EXPLORER, MIXTURES, SOLOIST, DIGITAL DRAWBAR
PIANIST SONG			<input type="radio"/>
SIMPLE PIANO			<input type="radio"/>
FAVORITES			<input type="radio"/>
PEDAL		SUSTAIN, SOSTENUTO, SOFT	
THEATRE SONIC		—	<input type="radio"/>
EFFECT		DIGITAL EFFECT, MULTI EFFECT, BRILLIANCE, REVERB, CHORUS, SOLO	
PART SELECT		RIGHT1, RIGHT2, LEFT	
TRANSCOPE		±12 NOTES	
RHYTHMS	NUMBER OF RHYTHMS	160 RHYTHMS × 4 VARIATIONS	
	RHYTHM GROUP	8 & 16 BEAT, JAZZ COMBO, COUNTRY & WESTERN, BALLAD, LATIN & WORLD, SOUL & DISCO, GOSPEL & BLUES, BIG BAND & SWING, MARCH & WALTZ, BALLROOM & SHOW TIME	
METRONOME			<input type="radio"/>
CONTROLS		MAIN VOLUME, APC/SEQUENCER VOLUME, BALANCE, MUTE, CONDUCTOR, START/STOP, INTRO & ENDING 1, INTRO & ENDING 2, FILL IN 1, FILL IN 2, COUNT INTRO, SYNCHRO START, TEMPO/PROGRAM, TAP TEMPO, FADE IN/OUT, SPLIT POINT, R1/R2 OCTAVE	
PIANO PERFORMANCE PADS		—	20 BANKS × 6 PADS WITH SOLO (USER BANK × 3, COMPILER BANKS × 2, CONTROL PRESET × 1) STOP, AUTO SETTING
AUTO PLAY CHORD		MODE: BASIC, ADVANCED 1, ADVANCED 2, PIANIST ON BASS, CHORD FINDER, LEFT HOLD	
MUSIC STYLE ARRANGER			<input type="radio"/>
SOUND ARRANGER			<input type="radio"/>
PIANO STYLIST			<input type="radio"/>
ONE TOUCH PLAY			<input type="radio"/>
TECHNI-CHORD			<input type="radio"/>
PANEL MEMORY		3 BANKS × 8, SET, NEXT BANK, BANK VIEW	
SEQUENCER		16 TRACKS RESOLUTION: 1/96 PER BEAT STORAGE CAPACITY: APPROX. 40000 NOTES (10 SONGS MAX.) INPUT MODES: EASY RECORD, REALTIME RECORD, STEP RECORD FUNCTIONS: RECORD & EDIT, COPY & PASTE, RANGE EDIT	
COMPOSER		5 PARTS: BASS, ACCOMP 1–5, DRUMS 1, 2 STORAGE CAPACITY: APPROX. 13000 NOTES INPUT MODES: REALTIME RECORD, STEP RECORD FUNCTIONS: PATTERN COPY, SEQ TO COMPOSER COPY, LOAD SINGLE COMPOSER MEMORY: 3 BANKS	
DISK DRIVE		3.5 inch DISK DRIVE for 2HD (1.44 MB), 2DD (720 KB) LOAD, SAVE, DIRECT PLAY, SONG MEDLEY, DISK TOOLS, PREFERENCES	
SOUND SETTING		PART SETTING, MIXER, MASTAR TUNING, KEY SCALING, APC REVERB SETTING, TECHNI-CHORD, SOUND EDIT	

	SX-PR604/M	SX-PR804/M
REVERB & EFFECT	TONE CONTROL, REVERB, CHORUS, MULTI, SOUND LOAD OPTION, MIXER	
CUSTOMIZE	DISPLAY TIMEOUT, DATA PROTECTION, FAVORITES SETTING, MIDI SETTING LOAD OPTION, LANGUAGE SETTING, DISK PREFERENCE	DISPLAY TIMEOUT, DATA PROTECTION, FAVORITES SETTING, MIDI SETTING LOAD OPTION, LANGUAGE SETTING, DISK PREFERENCE, VIDEO OUT MODE SETTING, THEATRE SONIC SPEAKER MODE
CONTROL	INITIAL, PEDAL SETTING, PANEL MEMORY MODE, MUSIC STYLE ARRANGER MODE, FADE IN/OUT SETTING	
DISPLAY	LCD: PAGE, CONTRAST, EXIT, DISPLAY HOLD	
HELP	○	
DEMO	○	
TERMINALS	PHONES × 2, LINE OUT (R/MONO,L), AUX IN (R/MONO,L), USB, MIDI (IN, OUT, THRU), PEDAL IN	PHONES × 2, LINE OUT (R/MONO,L), AUX IN (R/MONO,L), USB, MIDI (IN, OUT, THRU), PEDAL IN, THEATRE SONIC EXT OUT (R,L), VIDEO OUT
MIC INPUT	○ (MIC REVERB & EFFECT)	
OUTPUT	120W (60W × 2)	
SPEAKERS	16 cm × 2, 6.5 cm × 2	16 cm × 2, 6.5 cm × 2, MONITOR SPEAKER × 2
POWER REQUIREMENT	95 W 125W (NORTH AMERICA, MEXICO, EUROPE, AUSTRALIA AND NEW ZEALAND)	
	AC120/220/230–240V 50/60 Hz AC120V 60 Hz (NORTH AMERICA AND MEXICO) AC230-240V 50/60 Hz (EUROPE, AUSTRALIA AND NEW ZEALAND)	
DIMENSIONS (W × H × D)	140.6 cm × 106 cm × 65.2 cm (55-11/32" × 41-23/32" × 25-21/32")	139.7 cm × 107.7 cm × 67.5cm (55" × 42-13/32" × 26-9/16")
NET WEIGHT	59 kg (130.1 lbs.)	90 kg (198.4 lbs)
ACCESSORIES	AC CORD, MUSIC STAND, CD-ROM (AUDIO RECORDER, SONG MANAGER, USB DRIVER, PROGRESSIVE PIANIST MUSIC SCORE)	AC CORD, MUSIC STAND, CD-ROM (AUDIO RECORDER, SONG MANAGER, USB DRIVER, PROGRESSIVE PIANIST MUSIC SCORE), REMOTE CONTROL, BATTERIES

- Design and specifications are subject to change without notice.
- In some markets, some models may not be available.

(For U.S.A.)

PANASONIC CONSUMER ELECTRONICS COMPANY,
DIVISION OF MATSUSHITA ELECTRIC CORPORATION OF AMERICA
One Panasonic Way, Secaucus, New Jersey 07094

PANASONIC SALES COMPANY, DIVISION OF MATSUSHITA ELECTRIC
OF PUERTO RICO, INC.,
Ave. 65 de Infantería, Km. 9.5
San Gabriel Industrial Park, Carolina, Puerto Rico 00985

Panasonic/Technics Musical Instrument Products Limited Warranty

Limited Warranty Coverage

If your product does not work properly because of a defect in materials or workmanship, Panasonic Consumer Electronics Company or Panasonic Sales Company (collectively referred to as "the warrantor") will, for the length of the period indicated on the chart below, which starts with the date of original purchase ("warranty period"), at its option either (a) repair your product with new or refurbished parts, or (b) replace it with a new or a refurbished product. The decision to repair or replace will be made by the warrantor.

Product	Parts	Labor	Service
Technics Organs, Digital Pianos, Digital Ensemble Series, Tone Cabinets, Panasonic Digital Pianos	Three (3) Years	One (1) Year	In-Home or Carry-In
Technics Keyboards	One (1) Year	One (1) Year	In-Home or Carry-In
Panasonic Keyboards, Synthesizers, Sound Modules, Expansion Boards, Disk Drives, Drum Percussion Units, MIDI Orchestra, Key Board Amplifiers, Foot Pedals, Foot Controllers, Personal Music PA Systems	One (1) Year	One (1) Year	Carry-In or Mail-In

During the "Labor" warranty period there will be no charge for labor. During the "Parts" warranty period, there will be no charge for parts. You must carry-in or mail-in your product or arrange for in-home service, as applicable, during the warranty period. If non-rechargeable batteries are included, they are not warranted. This warranty only applies to products purchased and serviced in the United States or Puerto Rico. This warranty is extended only to the original purchaser of a new product which was not sold "as is". A purchase receipt or other proof of the original purchase date is required for warranty service.

Carry-In, Mail-In or In-Home Service

For Carry-In, Mail-In or In-Home Service (as applicable) in the United States call 1-800-211-PANA(7262) or visit Panasonic Web Site: <http://www.panasonic.com>
For assistance in Puerto Rico call Panasonic Sales Company (787)-750-4300 or fax (787)-768-2910.

In-Home service, if applicable, requires clear, complete and easy access to the product by the authorized servicer and does not include removal or re-installation of an installed product. It is possible that certain in-home repairs will not be completed in-home, but will require that the product, or parts of the product, be removed for shop diagnosis and/or repair and then returned.

Limited Warranty Limits And Exclusions

This warranty ONLY COVERS failures due to defects in materials or workmanship, and DOES NOT COVER normal wear and tear or cosmetic damage. The warranty ALSO DOES NOT COVER damages which occurred in shipment, or failures which are caused by products not supplied by the warrantor, or failures which result from accidents, misuse, abuse, neglect, mishandling, misapplication, alteration, faulty installation, set-up adjustments, misadjustment of consumer controls, improper maintenance, power line surge, lightning damage, modification, rental use of the product, service by anyone other than a Factory Servicenter or other Authorized Servicer, or damage that is attributable to acts of God.

THERE ARE NO EXPRESS WARRANTIES EXCEPT AS LISTED UNDER "LIMITED WARRANTY COVERAGE". THE WARRANTOR IS NOT LIABLE FOR INCIDENTAL OR CONSEQUENTIAL DAMAGES RESULTING FROM THE USE OF THIS PRODUCT, OR ARISING OUT OF ANY BREACH OF THIS WARRANTY, INCLUDING WITHOUT LIMITATION, LOSS OF GOODWILL, PROFITS OR REVENUE, LOSS OF USE OF THIS PRODUCT OR ANY ASSOCIATED EQUIPMENT, COST OF SUBSTITUTE EQUIPMENT, DOWNTIME COSTS, OR CLAIMS OF ANY PARTY DEALING WITH BUYER FOR SUCH DAMAGES. (As examples, this excludes damages for lost time, cost of having someone remove or re-install an installed unit if applicable, travel to and from the servicer, loss of media, data or other memory content. The items listed are not exclusive, but are for illustration only.) **ALL EXPRESS AND IMPLIED WARRANTIES, INCLUDING THE WARRANTY OF MERCHANTABILITY, ARE LIMITED TO THE PERIOD OF THE LIMITED WARRANTY.**

Some states do not allow the exclusion or limitation of incidental or consequential damages, or limitations on how long an implied warranty lasts, so the exclusions may not apply to you.

This warranty gives you specific legal rights and you may also have other rights which vary from state to state. If a problem with this product develops during or after the warranty period, you may contact your dealer or Servicenter. If the problem is not handled to your satisfaction, then write to the warrantor's Consumer Affairs Department at the addresses listed for the warrantor.

PARTS AND SERVICE (INCLUDING COST OF AN IN-HOME SERVICE CALL IF APPLICABLE) WHICH ARE NOT COVERED BY THIS LIMITED WARRANTY ARE YOUR RESPONSIBILITY.

Customer Services Directory

**For Product Information, Operating Assistance, Literature Request, Dealer Locations, and all Customer Service inquiries please contact:
1-800-211-PANA (7262), Monday–Friday 9 am–9 pm; Saturday–Sunday 9 am–7pm, EST.**

**Web site: <http://www.panasonic.com>
You can purchase parts, accessories or locate your nearest servicenter by visiting our Web Site.**

Accessory Purchases:

**1-800-332-5368 (Customer Orders Only)
Panasonic Services Company 20421 84th Avenue South, Kent, WA 98032
(6 am to 5 pm Monday–Friday; 6 am to 10:30 am Saturday; PST)
(Visa, MasterCard, Discover Card, American Express, Check)**

**Service in Puerto Rico
Matsushita Electric of Puerto Rico, Inc. Panasonic Sales Company/Factory Servicenter:
Ave. 65 de Infantería, Km. 9.5, San Gabriel Industrial Park, Carolina, Puerto Rico 00985
Phone (787) 750-4300 Fax (787) 768-2910**

Matsushita Electric Industrial Co., Ltd.

Web Site: <http://www.panasonic.co.jp/global/>

ENGLISH

Printed in Japan

QQTG0665
Se0402S0