

V-Synth GT

Owner's Manual

Roland®



Thank you, and congratulations on your choice of the Roland V-Synth GT.

Before using this unit, carefully read the sections entitled: "IMPORTANT SAFETY INSTRUCTIONS" (p. 4), "USING THE UNIT SAFELY" (p. 5), and "IMPORTANT NOTES" (p. 7). These sections provide important information concerning the proper operation of the unit. Additionally, in order to feel assured that you have gained a good grasp of every feature provided by your new unit, Quick Start, Owner's manual, and Driver Installation Guide should be read in its entirety. These manuals should be saved and kept on hand as a convenient reference.

The explanations in this manual include illustrations that depict what should typically be shown by the display. Note, however, that your unit may incorporate a newer, enhanced version of the system (e.g., includes newer sounds), so what you actually see in the display may not always match what appears in the manual.

Copyright © 2007 ROLAND CORPORATION
All rights reserved. No part of this publication may be reproduced in any form without the written permission of ROLAND CORPORATION.

WARNING: To reduce the risk of fire or electric shock, do not expose this apparatus to rain or moisture.

 CAUTION RISK OF ELECTRIC SHOCK DO NOT OPEN	
ATTENTION: RISQUE DE CHOC ELECTRIQUE NE PAS OUVRIR	
CAUTION: TO REDUCE THE RISK OF ELECTRIC SHOCK, DO NOT REMOVE COVER (OR BACK). NO USER-SERVICEABLE PARTS INSIDE. REFER SERVICING TO QUALIFIED SERVICE PERSONNEL.	



The lightning flash with arrowhead symbol, within an equilateral triangle, is intended to alert the user to the presence of uninsulated "dangerous voltage" within the product's enclosure that may be of sufficient magnitude to constitute a risk of electric shock to persons.



The exclamation point within an equilateral triangle is intended to alert the user to the presence of important operating and maintenance (servicing) instructions in the literature accompanying the product.

INSTRUCTIONS PERTAINING TO A RISK OF FIRE, ELECTRIC SHOCK, OR INJURY TO PERSONS.

IMPORTANT SAFETY INSTRUCTIONS

SAVE THESE INSTRUCTIONS

WARNING - When using electric products, basic precautions should always be followed, including the following:

1. Read these instructions.
2. Keep these instructions.
3. Heed all warnings.
4. Follow all instructions.
5. Do not use this apparatus near water.
6. Clean only with a dry cloth.
7. Do not block any of the ventilation openings. Install in accordance with the manufacturers instructions.
8. Do not install near any heat sources such as radiators, heat registers, stoves, or other apparatus (including amplifiers) that produce heat.
9. Do not defeat the safety purpose of the polarized or grounding-type plug. A polarized plug has two blades with one wider than the other. A grounding type plug has two blades and a third grounding prong. The wide blade or the third prong are provided for your safety. If the provided plug does not fit into your outlet, consult an electrician for replacement of the obsolete outlet.
10. Protect the power cord from being walked on or pinched particularly at plugs, convenience receptacles, and the point where they exit from the apparatus.
11. Only use attachments/accessories specified by the manufacturer.
12. Use only with the cart, stand, tripod, bracket, or table specified by the manufacturer, or sold with the apparatus. When a cart is used, use caution when moving the cart/apparatus combination to avoid injury from tip-over.
13. Unplug this apparatus during lightning storms or when unused for long periods of time.
14. Refer all servicing to qualified service personnel. Servicing is required when the apparatus has been damaged in any way, such as power-supply cord or plug is damaged, liquid has been spilled or objects have fallen into the apparatus, the apparatus has been exposed to rain or moisture, does not operate normally, or has been dropped.



For the U.K.

WARNING: THIS APPARATUS MUST BE EARTHED

IMPORTANT: THE WIRES IN THIS MAINS LEAD ARE COLOURED IN ACCORDANCE WITH THE FOLLOWING CODE.
GREEN-AND-YELLOW: EARTH, BLUE: NEUTRAL, BROWN: LIVE

As the colours of the wires in the mains lead of this apparatus may not correspond with the coloured markings identifying the terminals in your plug, proceed as follows:

The wire which is coloured GREEN-AND-YELLOW must be connected to the terminal in the plug which is marked by the letter E or by the safety earth symbol  or coloured GREEN or GREEN-AND-YELLOW.



The wire which is coloured BLUE must be connected to the terminal which is marked with the letter N or coloured BLACK.

The wire which is coloured BROWN must be connected to the terminal which is marked with the letter L or coloured RED.



USING THE UNIT SAFELY

INSTRUCTIONS FOR THE PREVENTION OF FIRE, ELECTRIC SHOCK, OR INJURY TO PERSONS

About ⚠ WARNING and ⚠ CAUTION Notices







 WARNING	Used for instructions intended to alert the user to the risk of death or severe injury should the unit be used improperly.
 CAUTION	Used for instructions intended to alert the user to the risk of injury or material damage should the unit be used improperly. * Material damage refers to damage or other adverse effects caused with respect to the home and all its furnishings, as well to domestic animals or pets.

About the Symbols







	The ⚠ symbol alerts the user to important instructions or warnings. The specific meaning of the symbol is determined by the design contained within the triangle. In the case of the symbol at left, it is used for general cautions, warnings, or alerts to danger.
	The ⊘ symbol alerts the user to items that must never be carried out (are forbidden). The specific thing that must not be done is indicated by the design contained within the circle. In the case of the symbol at left, it means that the unit must never be disassembled.
	The ⚡ symbol alerts the user to things that must be carried out. The specific thing that must be done is indicated by the design contained within the circle. In the case of the symbol at left, it means that the power-cord plug must be unplugged from the outlet.

ALWAYS OBSERVE THE FOLLOWING







WARNING

- Before using this unit, make sure to read the instructions below, and the Owner's Manual. 
- Connect mains plug of this model to a mains socket outlet with a protective earthing connection. 
- Do not open or perform any internal modifications on the unit. 
- Do not attempt to repair the unit, or replace parts within it (except when this manual provides specific instructions directing you to do so). Refer all servicing to your retailer, the nearest Roland Service Center, or an authorized Roland distributor, as listed on the "Information" page. 
- Never use or store the unit in places that are:
 - Subject to temperature extremes (e.g., direct sunlight in an enclosed vehicle, near a heating duct, on top of heat-generating equipment); or are 
 - Damp (e.g., baths, washrooms, on wet floors); or are 
 - Humid; or are
 - Exposed to rain; or are
 - Dusty; or are
 - Subject to high levels of vibration.
- This unit should be used only with keyboard stand KS-12 that is recommended by Roland. 











WARNING

- When using the unit with a stand recommended by Roland, the stand must be carefully placed so it is level and sure to remain stable. If not using a rack or stand, you still need to make sure that any location you choose for placing the unit provides a level surface that will properly support the unit, and keep it from wobbling. 
- The unit should be connected to a power supply only of the type described in the operating instructions, or as marked on the rear side of unit. 
- Use only the attached power-supply cord. Also, the supplied power cord must not be used with any other device. 
- Do not excessively twist or bend the power cord, nor place heavy objects on it. Doing so can damage the cord, producing severed elements and short circuits. Damaged cords are fire and shock hazards! 
- This unit, either alone or in combination with an amplifier and headphones or speakers, may be capable of producing sound levels that could cause permanent hearing loss. Do not operate for a long period of time at a high volume level, or at a level that is uncomfortable. If you experience any hearing loss or ringing in the ears, you should immediately stop using the unit, and consult an audiologist. 
- Do not allow any objects (e.g., flammable material, coins, pins); or liquids of any kind (water, soft drinks, etc.) to penetrate the unit. 

WARNING

- Immediately turn the power off, remove the power cord from the outlet, and request servicing by your retailer, the nearest Roland Service Center, or an authorized Roland distributor, as listed on the "Information" page when:
 - The power-supply cord, or the plug has been damaged; or
 - If smoke or unusual odor occurs
 - Objects have fallen into, or liquid has been spilled onto the unit; or
 - The unit has been exposed to rain (or otherwise has become wet); or
 - The unit does not appear to operate normally or exhibits a marked change in performance.
- In households with small children, an adult should provide supervision until the child is capable of following all the rules essential for the safe operation of the unit. 
- Protect the unit from strong impact. (Do not drop it!) 
- Do not force the unit's power-supply cord to share an outlet with an unreasonable number of other devices. Be especially careful when using extension cords—the total power used by all devices you have connected to the extension cord's outlet must never exceed the power rating (watts/amperes) for the extension cord. Excessive loads can cause the insulation on the cord to heat up and eventually melt through. 
- Before using the unit in a foreign country, consult with your retailer, the nearest Roland Service Center, or an authorized Roland distributor, as listed on the "Information" page. 
- DO NOT play a CD-ROM disc on a conventional audio CD player. The resulting sound may be of a level that could cause permanent hearing loss. Damage to speakers or other system components may result. 
- Do not put anything that contains water (e.g., flower vases) on this unit. Also, avoid the use of insecticides, perfumes, alcohol, nail polish, spray cans, etc., near the unit. Swiftly wipe away any liquid that spills on the unit using a dry, soft cloth. 

CAUTION

- The unit should be located so that its location or position does not interfere with its proper ventilation. 
- This unit for use only with Roland keyboard stand KS-12. Use with other stands is capable of resulting in instability causing possible injury. 
- Always grasp only the plug on the power-supply cord when plugging into, or unplugging from, an outlet or this unit. 
- At regular intervals, you should unplug the power plug and clean it by using a dry cloth to wipe all dust and other accumulations away from its prongs. Also, disconnect the power plug from the power outlet whenever the unit is to remain unused for an extended period of time. Any accumulation of dust between the power plug and the power outlet can result in poor insulation and lead to fire. 
- Try to prevent cords and cables from becoming entangled. Also, all cords and cables should be placed so they are out of the reach of children. 
- Never climb on top of, nor place heavy objects on the unit. 
- Never handle the power cord or its plugs with wet hands when plugging into, or unplugging from, an outlet or this unit. 
- Before moving the unit, disconnect the power plug from the outlet, and pull out all cords from external devices. 
- Before cleaning the unit, turn off the power and unplug the power cord from the outlet. 
- Whenever you suspect the possibility of lightning in your area, pull the plug on the power cord out of the outlet. 
- Always turn the phantom power off when connecting any device other than condenser microphones that require phantom power. You risk causing damage if you mistakenly supply phantom power to dynamic microphones, audio playback devices, or other devices that don't require such power. Be sure to check the specifications of any microphone you intend to use by referring to the manual that came with it. 

(This instrument's phantom power: 48 V DC, 10 mA Max)

IMPORTANT NOTES

In addition to the items listed under “IMPORTANT SAFETY INSTRUCTIONS” and “USING THE UNIT SAFELY” on pages 4–6, please read and observe the following:

Power Supply

- Do not connect this unit to same electrical outlet that is being used by an electrical appliance that is controlled by an inverter (such as a refrigerator, washing machine, microwave oven, or air conditioner), or that contains a motor. Depending on the way in which the electrical appliance is used, power supply noise may cause this unit to malfunction or may produce audible noise. If it is not practical to use a separate electrical outlet, connect a power supply noise filter between this unit and the electrical outlet.
- Before connecting this unit to other devices, turn off the power to all units. This will help prevent malfunctions and/or damage to speakers or other devices.
- Although the LCD and LEDs are switched off when the POWER switch is switched off, this does not mean that the unit has been completely disconnected from the source of power. If you need to turn off the power completely, first turn off the POWER switch, then unplug the power cord from the power outlet. For this reason, the outlet into which you choose to connect the power cord’s plug should be one that is within easy reach and readily accessible.

Placement

- Using the unit near power amplifiers (or other equipment containing large power transformers) may induce hum. To alleviate the problem, change the orientation of this unit; or move it farther away from the source of interference.
- This device may interfere with radio and television reception. Do not use this device in the vicinity of such receivers.
- Noise may be produced if wireless communications devices, such as cell phones, are operated in the vicinity of this unit. Such noise could occur when receiving or initiating a call, or while conversing. Should you experience such problems, you should relocate such wireless devices so they are at a greater distance from this unit, or switch them off.
- Do not expose the unit to direct sunlight, place it near devices that radiate heat, leave it inside an enclosed vehicle, or otherwise subject it to temperature extremes. Excessive heat can deform or discolor the unit.
- When moved from one location to another where the temperature and/or humidity is very different, water droplets (condensation) may form inside the unit. Damage or malfunction may result if you attempt to use the unit in this condition. Therefore, before using the unit, you must allow it to stand for several hours, until the condensation has completely evaporated.
- Do not allow objects to remain on top of the keyboard. This can be the cause of malfunction, such as keys ceasing to produce sound.
- Depending on the material and temperature of the surface on which you place the unit, its rubber feet may discolor or mar the surface. You can place a piece of felt or cloth under the rubber feet to prevent this from happening. If you do so, please make sure that the unit will not slip or move accidentally.

Maintenance

- For everyday cleaning wipe the unit with a soft, dry cloth or one that has been slightly dampened with water. To remove stubborn dirt, use a cloth impregnated with a mild, non-abrasive detergent. Afterwards, be sure to wipe the unit thoroughly with a soft, dry cloth.
- Never use benzine, thinners, alcohol or solvents of any kind, to avoid the possibility of discoloration and/or deformation.

Repairs and Data

- Please be aware that all data contained in the unit’s memory may be lost when the unit is sent for repairs. Important data should always be backed up on a USB memory, or written down on paper (when possible). During repairs, due care is taken to avoid the loss of data. However, in certain cases (such as when circuitry related to memory itself is out of order), we regret that it may not be possible to restore the data, and Roland assumes no liability concerning such loss of data.

Additional Precautions

- Please be aware that the contents of memory can be irretrievably lost as a result of a malfunction, or the improper operation of the unit. To protect yourself against the risk of losing important data, we recommend that you periodically save a backup copy of important data you have stored in the unit’s memory on a USB memory.
- Unfortunately, it may be impossible to restore the contents of data that was stored in the unit’s memory or on a USB memory once it has been lost. Roland Corporation assumes no liability concerning such loss of data.
- Use a reasonable amount of care when using the unit’s buttons, sliders, or other controls; and when using its jacks and connectors. Rough handling can lead to malfunctions.
- Never strike or apply strong pressure to the display.
- A small amount of noise may be heard from the display during normal operation.
- When connecting / disconnecting all cables, grasp the connector itself—never pull on the cable. This way you will avoid causing shorts, or damage to the cable’s internal elements.
- A small amount of heat will radiate from the unit during normal operation.
- To avoid disturbing your neighbors, try to keep the unit’s volume at reasonable levels. You may prefer to use headphones, so you do not need to be concerned about those around you (especially when it is late at night).
- When you need to transport the unit, package it in the box (including padding) that came in, if possible. Otherwise, you will need to use equivalent packaging materials.
- Use only the specified expression pedal (EV series; sold separately). By connecting any other expression pedals, you risk causing malfunction and/or damage to the unit.

- Some connection cables contain resistors. Do not use cables that incorporate resistors for connecting to this unit. The use of such cables can cause the sound level to be extremely low, or impossible to hear. For information on cable specifications, contact the manufacturer of the cable.
- The usable range of D Beam controller will become extremely small when used under strong direct sunlight. Please be aware of this when using the D Beam controller outside.
- The sensitivity of the D Beam controller will change depending on the amount of light in the vicinity of the unit. If it does not function as you expect, adjust the sensitivity as appropriate for the brightness of your location.
- In order to provide high-quality images, the V-Synth GT uses a TFT liquid crystal display. Please be aware that due to the characteristics of a TFT liquid crystal display, there may be pixels that fail to light or pixels that remain lit, but these are not considered to be malfunctions or defects.
- Due to the characteristics of a TFT liquid crystal display, leaving the same screen displayed for an extended period of time may cause the image to be burned into the screen. To avoid burn-in, we recommend that you use the screen saver function (p. 229).

Before Using USB Memory

Using USB Memory

- USB memories are constructed using precision components; handle the cards carefully, paying particular note to the following.
 - To prevent damage to the cards from static electricity, be sure to discharge any static electricity from your own body before handling the USB memory.
 - Do not touch or allow metal to come into contact with the contact portion of the USB memory.
 - Do not bend, drop, or subject USB memories to strong shock or vibration.
 - Do not keep USB memories in direct sunlight, in closed vehicles, or other such locations (storage temperature: -20 to 80° C: M-UF128).
 - Do not allow USB memories to become wet.
 - Do not disassemble or modify the USB memories.
- Please use Roland M-UF128 as the USB memory device. Some commercially available USB memory (2 GB or lower capacity) may be usable, but Roland cannot guarantee operation or compatibility for individual models. This is due to the fact that manufacturers may change the internal circuit design or specifications without notice even for identical models of USB memory.
 - * The model names of the USB memory devices offered within the Roland product lineup are subject to change. For the most recent information, please visit the Roland website.
 - * As a safeguard against data loss, we recommend that you copy the contents of USB memory to your computer as a backup.

Handling CD-ROMs

- Avoid touching or scratching the shiny underside (encoded surface) of the disc. Damaged or dirty CD-ROM discs may not be read properly. Keep your discs clean using a commercially available CD cleaner.

Copyright

- Recording, duplication, distribution, sale, lease, performance, or broadcast of copyrighted material (musical works, visual works, broadcasts, live performances, etc.) belonging to a third party in part or in whole without the permission of the copyright owner is forbidden by law.
- This product can be used to record or duplicate audio or visual material without being limited by certain technological copy-protection measures. This is due to the fact that this product is intended to be used for the purpose of producing original music or video material, and is therefore designed so that material that does not infringe copyrights belonging to others (for example, your own original works) can be recorded or duplicated freely.
- Do not use this unit for purposes that could infringe on a copyright held by a third party. We assume no responsibility whatsoever with regard to any infringements of third-party copyrights arising through your use of this unit.

* MatrixQuest™ 2007 TEPCO UQUEST, LTD. All rights reserved.  The V-Synth GT's USB functionality uses MatrixQuest middleware technology from TEPCO UQUEST, LTD.

* Microsoft and Windows are registered trademarks of Microsoft Corporation.

* Windows® is known officially as: "Microsoft® Windows® operating system."

Contents

IMPORTANT SAFETY INSTRUCTIONS	4
USING THE UNIT SAFELY	5
IMPORTANT NOTES	7
How to Use the Documentation	15
Main Features	16
Getting Ready	17
Connecting an Amp and Speaker System	17
Turning On the Power	18
Panel Descriptions	20
Front Panel	20
Rear Panel.....	24
Overview of the V-Synth GT	26
How the V-Synth GT Is Organized	26
Basic Structure	26
Polyphony	27
About Structures	28
Structure Type	28
Section	29
About Memory	30
Memory Structure	30
About VariPhrase	32
Basic Operation of the V-Synth GT	33
Basic Operations in the Touch Panel	33
Moving the Cursor.....	33
Editing a Value	34
Common Icons in the Touch Panel	36
Using the Map Function	37
The V-Synth GT's Four Modes	38

Patch Mode (Playing in Patch Mode)	39
About the Patch Play Screen	39
Selecting a Patch	40
Selecting Patches from the List	41
Selecting Favorite Patches (Patch Palette)	42
Applying Various Effects to the Sound	43
Varying the Velocity or Aftertouch	43
Pitch Bend/Modulation Lever	43
Transpose (Transposing the Keyboard in Semitone Steps)	44
Octave Shift (Transposing the Keyboard in Octave Units)	45
Applying an Effect by Touching Your Finger to the Pad (Time Trip Pad)	46
Applying an Effect by Passing Your Hand Over the D Beam	48
Using the E1–E8 Knobs	49
Using the Assignable Controllers	50
Arpeggiator	51
Playing Arpeggios	51
Holding an Arpeggio	51
V-LINK (Synchronizing Music and Video While You Play the V-Synth GT)	52
Enter V-LINK Mode	53
V-LINK Functions that the V-Synth GT Can Control and MIDI Messages	53
Patch Mode (Editing a Patch)	54
Creating a Patch	54
Selecting a Tone	55
Selecting a Tone from a List	57
Patch Menu	58
Patch Write (Saving Patches)	58
Patch Name (Naming a Patch)	59
Patch Category (Assigning the Category of a Patch)	60
Patch Init (Initializing the Patch Settings)	62
Patch Common (Settings Shared by the Entire Patch)	63
Editing the Patch Common Parameters	63
Common (Settings Used by the Entire System)	65
General	65
Time Trip Pad	66
D Beam	67
S1/S2 Switch	67
Key Range	68
Arpeggio	69
Arpeggio Pattern Edit (Creating an Original Arpeggio Pattern)	71
Effects (Setting Effects for a Patch)	76
Routing	76
Tone-FX	78
Chorus	78
Reverb	79

Patch Mode (Editing a Tone)	80
Creating a Tone	80
Tone Menu	81
Tone Write (Saving Tones)	81
Tone Name (Naming a Tone)	82
Tone Category (Assigning the Category of a Tone).....	83
Tone Init (Initializing the Tone Settings).....	84
Editing a Tone (Pro Edit)	85
Com (Settings Common to the Entire Tone)	86
Structure.....	86
Keyboard.....	87
Bender/Octave.....	90
Matrix Control	91
Tune	94
OSC1/OSC2 (Oscillator 1/2)	95
OSC Type	95
OSC Type (Analog OSC)	96
OSC Type (PCM OSC)	99
OSC Type (External In)	101
Pitch (common to Analog and PCM)	102
Pulse Width (Analog).....	103
Fat (Analog)	104
Detune (Analog, when using Sub OSC)	105
SS Detune (Analog, when SUPER-SAW is selected).....	106
Mix (Analog, when SUPER-SAW is selected).....	107
Harmonics (Analog, when FBACK-OSC is selected).....	108
FBK Amount (Analog, when FBACK-OSC is selected).....	109
X-Mod (Analog, when X-MOD-OSC is selected)	110
Time (PCM)	111
Formant (PCM).....	112
OSC TVA (common to Analog and PCM)	113
LFO (common to Analog and PCM)	114
MOD	115
MOD Type	115
COSM1/COSM2	117
COSM Type	117
LFO	118
TVA	119
TVA	119
LFO	120

AP Syn (AP-Synthesis).....	124
Phrase Model	125
Pitch	126
Modify (when Phrase Model is "Violin")	127
Modify (when Phrase Model is "Erhu").....	128
Modify (when Phrase Model is "Sax").....	129
Modify (when Phrase Model is "Flute")	130
Modify (when Phrase Model is "Multifade").....	131
Advanced (when Phrase Model is "Violin")	132
Advanced (when Phrase Model is "Erhu")	133
Advanced (when Phrase Model is "Sax")	134
Advanced (when Phrase Model is "Flute")	135
Advanced (when Phrase Model is "Multifade")	136
Control 1	137
Control 2	138
Tone-FX (Tone Effect).....	139
Routing	139
Tone-FX.....	141
Chorus.....	141
Reverb	141
Using Steps to Vary the Sound (Multi Step Modulator).....	142
Multi Step Modulator	144
Vocal Designer	146
How Vocal Designer is Structured.....	147
Using Vocal Designer	148
Vocal Designer	150
Mic Settings.....	151
Mic Type.....	151
EQ	152
Noise Sup	153
Comp	154
Vocoder	155
Editing a Tone (SOUND SHAPER II)	158
COSM.....	160
AP-Synthesis	161
Effects.....	162
Sample Mode	163
Sampling.....	163
Sample Name (Naming a Sample).....	168
Sample Copy (Copying a Sample)	169
Sample Move (Moving a Sample)	170
Sample Exchange (Exchanging a Sample).....	171
Sample Delete (Deleting a Sample).....	172
Resampling.....	173

Sampling General (Setup Settings)	174
Sampling Pre-Effect (Pre-Effect Settings).....	175
Metronome (Metronome Settings)	176
Template Name (Naming a Template)	177
Editing a Sample.....	178
Common Procedure for Editing	178
Editing the Specified Region of the Sample.....	182
Loop Region Settings	185
Original Tempo Setting	186
Encode (Converting the Sample to V-Synth GT Data).....	187
Selecting the Encoding Type	188
Automatically Detecting Events.....	189
Deleting and Adding Events	190
Saving a Sample.....	191
Checking Sample Information	192
System Mode (Settings Common to All Modes)	193
How to Make the System Function Settings	193
System Menu	194
System Write (Saving the System Settings).....	194
System Init (Initializing the System Settings).....	195
Common (Settings Common to the Entire System).....	196
Master	196
EQ	197
MIDI	198
USB MIDI	199
Audio Input	200
Audio Output.....	201
USB Audio	202
Controller (Controller-related Settings)	203
Keyboard.....	203
Time Trip Pad	204
D-Beam.....	205
C1/C2 Knob.....	206
S1/S2 Switch	206
Pedal.....	207
V-LINK Settings.....	208
Tx.....	208
Time Trip Pad	209
D Beam.....	210
C1/C2 Knob.....	211
Bender.....	212
Info (Viewing Various Information).....	213
Version (Checking the Version)	213
Features (Checking the Functions).....	213

Utility Mode	214
Project (Project-related Settings).....	215
Load Project (Loading a Project into the V-Synth GT)	215
Save Project (Saving a Project).....	217
Convert Project (Convert a Project)	219
USB Storage (Exchanging Files with Your Computer)	221
Windows Users.....	221
Mac Users.....	223
Examples of Using Storage Function	225
Beep (Beep Tone Settings)	227
E1–E8 Knobs (E1–E8 knob Settings)	228
Screen Saver	229
Wallpaper (Changing the Wallpaper)	230
Import (Importing an Image as Wallpaper)	230
Calibration (Adjusting the Controllers).....	231
Adjusting the Positional Accuracy of the Touch Panel.....	231
Adjusting the Positional Accuracy of the Time Trip Pad.....	232
Adjusting the Sensitivity of the D Beam Controller.....	233
Format (Initializing Internal Memory or USB Memory)	234
Factory Reset (Reset to Default Factory Settings).....	235
MIDI Implementation Chart	236
Specifications	237
Index	239

How to Use the Documentation

The V-Synth GT documentation is organized as follows. Refer to the printed documentation or CD-ROM as appropriate for your needs.

Quick Start

“Quick Start” provides easily understandable, step-by-step explanations that the first-time user will need to know in order to play the V-Synth GT. To get a quick understanding of the overall functionality provided by the V-Synth GT, please be sure to read this.

Owner’s Manual

This is the manual you’re reading.

It explains all of the V-Synth GT’s functionality. After you’ve read “Quick Start” to get an overall picture of the V-Synth GT, read this manual when you need to find out more about individual functions.

Driver Installation Guide

This explains how to install the driver that is required for connecting the V-Synth GT to your computer.

CD-ROM

Lists of the COSM effects and other effects built into the V-Synth GT are provided in PDF format in the “Effects List” on the included CD-ROM. Refer to these lists as needed.

Conventions used in this manual

In order to describe operations as clearly as possible, this manual uses the following conventions.

Text or graphics enclosed in square brackets [] indicates a button or knob on the panel. For example, [MODE] indicates the MODE button, and [▲], [▼], [◀], and [▶] indicate the cursor buttons.

Text or graphics enclosed in angle brackets < > indicates an item in the screen (touch panel) that you can operate with your fingertip. We use the word “touch” to indicate that you are to place your fingertip on the touch panel.

References such as (p.***) indicate a relevant page to which you can refer.

Symbols appearing at the beginning of a paragraph have the following meaning.

- NOTE** indicates a note. Please be sure to read this.
- MEMO** indicates a memo. Read this as needed.
- TIP** indicates a helpful hint. Read this as needed.
- cf.** indicates a reference to a related page. Read this as needed.

NOTE The screens shown in this manual are based on the factory settings, but please be aware that there may be some differences from the product that is actually shipped.

NOTE Please be aware that the patch names and so on in the screens shown in this manual may differ from the factory settings.

Main Features

The V-Synth GT is a professional synthesizer that brings together Roland's revolutionary technologies. A variety of sound generators, including the latest AP-Synthesis, unique controllers, and a sophisticated user interface are joined in this amazing instrument. For any genre or style, the V-Synth GT gives you musically expressive power of an entirely different dimension than any previous instrument, with highly usable and playable sounds that are available nowhere else.

Sound creation power driven by dual-core technology

- The sound generator engine is now dual-core, delivering approximately twice as much simultaneous sound control as the previous model of V-Synth. Two tones (Upper and Lower) can be combined, letting you use V-Synth sounds created with VariPhrase or COSM together with Vocal Designer or the newly developed AP-Synthesis to play two different types of sounds together.

AP-Synthesis enables a new dimension of performance expression

- The V-Synth GT features a newly developed sound generation technology, AP-Synthesis (Articulative Phrase Synthesis). By modeling and storing the way in which individual acoustic instruments respond to being played, this technology goes beyond merely generating "sound," and is able to re-create the nuances and behavior that are distinctive to a particular instrument.
- Variations that are possible only for a synthesizer are also provided as AP-Synthesis modeling types. This makes it possible for you to select truly unique models—for example, you could use violin performance techniques to play an analog lead synth sound. These sounds can be processed through COSM or layered with a VariPhrase sound to create new sounds that are not limited to the simulation of existing instruments.

Vocal Designer function that's highly integrated with the synth sound generator

- Since its debut, Vocal Designer has continued to astound the music scene with its amazing human vocal emulation. Until now, this has been limited to use on its own in the V-Synth series, but on the V-Synth GT you can use it simultaneously with V-Synth sounds that use VariPhrase or modeling OSC, as well as with AP-Synthesis. You can create performances that have never been heard before, such as a complex pad that interweaves VariPhrase and arpeggios, wrapped in a spacey vocal ensemble.
- The microphone input section provides a combo jack, which accommodates either a 1/4" phone plug or an XLR connector (phantom power is supplied), making it easy to connect a variety of microphones.

A powerful user interface that's easier to use than ever

- The V-Synth GT features a new, high-resolution TFT color LCD. This LCD can display a wide range of colors and offers a broad viewing angle. Not only is it a delight to view, but it also delivers a great leap in discernibility when you're editing sounds. Of course, the LCD is a touch panel, so you can directly access an item you want to manipulate. The eight knobs located below the LCD are directly linked with the parameters shown in the screen, allowing intuitive control.
- Frequently used controllers have also been rethought. For example, we've speeded up operation by unifying the jog dial and cursor buttons into a single unit. The arrangement of the realtime controllers has also been refined. The V-Synth's distinctive Time Trip pad, the twin D Beam, and assignable controller knobs have been brought together in one location, letting you access each controller quickly for even more aggressive realtime performance.

New USB connector for backup media portability

- The USB functionality has also been upgraded on the V-Synth GT. A USB MEMORY connector is provided, allowing USB memory to be directly connected for data storage. USB 2.0 support means quick saving or loading of audio files or patch data, and easy data transfer with your computer. In addition to the USB-MIDI interface functionality provided by the previous model, there's also the capability to transfer files via USB, and even realtime transmission and reception of audio via the USB-Audio functionality that was a popular feature of the V-Synth XT. These capabilities allow powerful inter-operation with your computer and DAW software.

Getting Ready

Connecting an Amp and Speaker System

Since the V-Synth GT contains no amplifier or speakers, you'll need to connect it to audio equipment such as a keyboard amplifier, monitor speaker system or home stereo, or use headphones to hear its sound.

NOTE To prevent malfunction and/or damage to speakers or other devices, always turn down the volume, and turn off the power on all devices before making any connections.

NOTE When connection cables with resistors are used, the volume level of equipment connected to the INPUT jacks may be low. If this happens, use connection cables that do not contain resistors.

1. Before hooking anything up, make sure that the power on all of your gear is turned OFF.
2. Connect the V-Synth GT to your amp/speaker system as shown in the diagram.

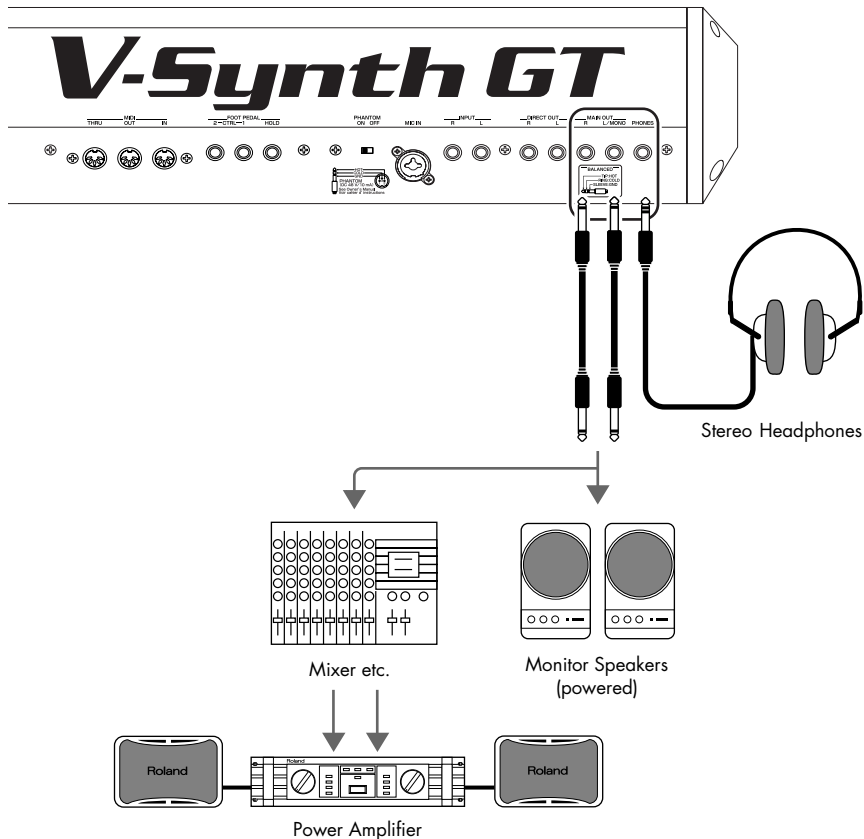

Use audio cables to connect audio equipment such as an amp or speakers. If you're using headphones, plug them into the PHONES jack.

NOTE Audio cables are not included with the V-Synth GT. You'll need to provide them.

TIP In order to fully experience the V-Synth GT's sound, we recommend using a stereo amp/speaker system. If you're using a mono system, however, make your connections to the V-Synth GT's MAIN OUT jack L/MONO.

Turning On the Power

Once you've made connections correctly (see preceding page), turn on the power using the following procedure. Powering up your equipment in the wrong order may cause malfunctions or speaker damage.

NOTE Be careful not to set your listening volume too high to avoid damage to your amp/speaker system or your hearing.

NOTE To ensure proper operation of the pitch bend lever, make sure not to touch the lever when turning the V-Synth GT's power on.

1. Before turning on the V-Synth GT's power, consider these two questions:

- Are all peripheral devices connected correctly?
- Have the volume controls of the V-Synth GT and all connected audio devices been turned to their lowest settings?



Do not touch!

2. Turn on the POWER ON switch located on the rear panel of the V-Synth GT.

POWER ON

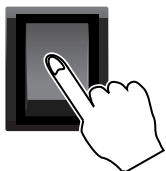

ON



OFF



* This unit is equipped with a protection circuit. A brief interval (a few seconds) after power up is required before the unit will operate normally.

3. Turn on the power for any connected amplifiers or speakers.

4. Wait for the V-Synth GT to start up. When it has started up normally, a screen like the following will appear.



5. Adjust the volume appropriately.

While playing the keyboard to produce sound, adjust the volume of the V-Synth GT and of the connected audio equipment.

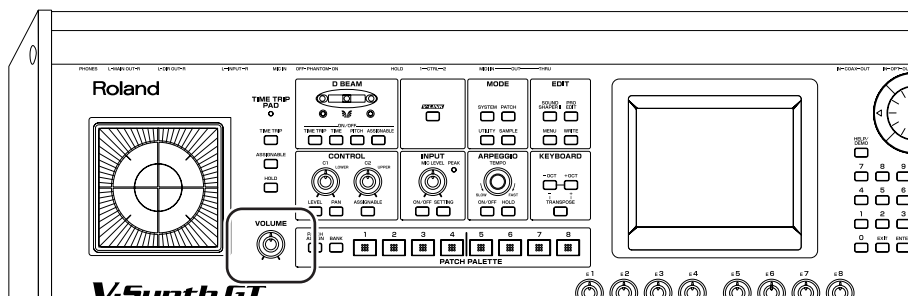

Turning Off the Power

1. Before you turn off the power, consider these two questions:

- Have the volume controls of the V-Synth GT and all connected audio devices been turned to their lowest settings?
- Have you saved your V-Synth GT sounds or other data you've created?

2. Turn off the power for all connected audio devices.

3. Turn off the POWER switch located on the rear panel of the V-Synth GT.

* If you need to turn off the power completely, first turn off the POWER switch, then unplug the power cord from the power outlet. Refer to "Power Supply" (p. 7).

Panel Descriptions

Front Panel

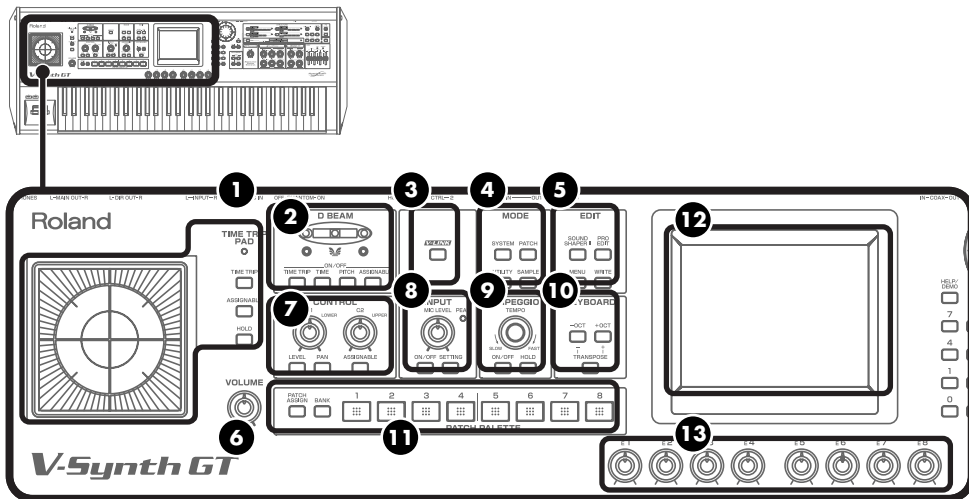

1 TIME TRIP PAD

By touching the pad surface with your finger you can apply a variety of effects to the sound. (p. 46)

Indicator	This will light when you touch the Time Trip Pad.
[TIME TRIP]	Switches to the Time Trip effect.
[ASSIGNABLE]	Switches to the effect that is specified for each tone.
[HOLD]	Switches hold on/off for the effect controlled by the Time Trip pad.

2 D BEAM

You can apply a variety of effects to sounds simply by moving your hand. (p. 48)

Indicators (L, R)	If the D Beam controller is on, these will light when you move your hand over the controller.
--------------------------	---

ON/OFF (TIME TRIP, TIME, PITCH, ASSIGNABLE)

Switches the D Beam controller on/off. The effect to be controlled can be selected by pressing the relevant button.

[TIME TRIP]	Applies the Time Trip effect.
[TIME]	Applies the Time Control effect.
[PITCH]	Applies the Pitch Control effect.
[ASSIGNABLE]	Applies the effect that is specified for each sound.

3 V-LINK

Enables or disables control of an externally connected V-LINK device. (p. 52)

4 MODE

These buttons switch between modes of the V-Synth GT.

[SYSTEM]	Switches to System mode (p. 193).
[PATCH]	Opens the Patch mode Patch Play screen (p. 39).
[UTILITY]	Switches to Utility mode (p. 214).
[SAMPLE]	Switches to Sample mode (p. 163).

5 EDIT

Use these buttons when you want to edit a patch or tone.

[SOUND SHAPER II]	Opens the Sound Shaper II screen (p. 158).
[PRO EDIT]	Opens the Pro Edit screen (p. 85).
[MENU]	Opens the menu.
[WRITE]	Saves the edited content in internal memory or USB memory.

6 VOLUME

Adjusts the overall volume that is output from the rear panel MAIN OUT jacks and PHONES jack. (p. 18)

7 ASSIGNABLE CONTROL

You can assign a variety of parameters and functions to the two knobs ([C1], [C2]), and use them to modify the sound in realtime. (p. 50)

[LEVEL]	Adjust the volume of the upper tone and lower tone.
[PAN]	Adjust the stereo position (panning) of the upper tone and lower tone.
[ASSIGNABLE]	Switches to the effect that is specified for each tone.

8 INPUT

PEAK Indicator	This will light when the input volume is too high.
[MIC LEVEL]	Adjusts the volume of the signal input through the INPUT jacks on the rear panel. (p. 148)
[ON/OFF]	Switches the mic input on/off.
[SETTING]	Opens the Audio Input Settings screen (p. 200).

9 ARPEGGIO

Here you can control the arpeggiator.

[TEMPO]	Adjusts the V-Synth GT's tempo.
[ON/OFF]	Switches the Arpeggiator on/off.
[HOLD]	Switches the Arpeggiator hold on/off.

10 KEYBOARD

Here you can change the pitch range of the keyboard.

[-OCT], [+OCT]	These buttons adjust the pitch of the keyboard in octave steps. (p. 45)
[TRANPOSE]	Specifies transposing the keyboard in semitone steps. (p. 44) Pressing [-OCT] or [+OCT] while holding down this button allows you to set the desired amount of transposition.

11 PATCH PALETTE

Here you can register and recall your favorite patches.

[PATCH ASSIGN]	If you hold down this button and press PATCH PALETTE [1]–[8], the currently selected patch will be registered as a favorite patch (p. 42).
[BANK]	You can change the Patch Palette bank by holding down this button and pressing PATCH PALETTE [1]–[8].
[1]–[8]	These buttons let you select/register your favorite patches.

12 Display

This displays information regarding the operation you are performing.

13 E1–E8 knobs

These knobs adjust the on-screen parameters in real time (p. 35).

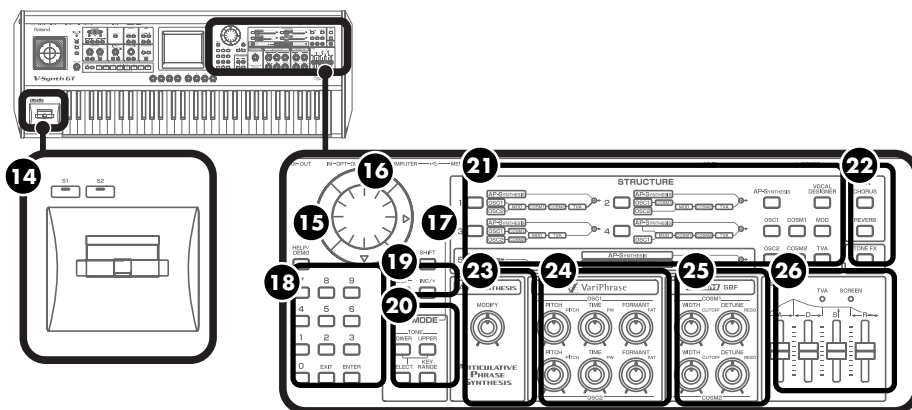

14 Pitch Bend/Modulation Lever

This allows you to control pitch bend or apply vibrato. (p. 43)

[S1] [S2]

These will apply the effect specified by AP-Synthesis. With the default settings, they switch the violin sound between tremolo or pizzicato.

15 HELP/DEMO

This opens the help browser, in which you can view the help screens (p. 36).

16 VALUE Dial

This is used to modify values. If you hold down [SHIFT] as you turn the VALUE dial, the value will change in greater increments. (p. 34)

[▲], [▼], [◀], [▶] (Cursor Buttons)

Moves the cursor location up/down/left/right. (p. 33)

17 [SHIFT]

This button is used in conjunction with other buttons to execute various functions.

[SHIFT] + [STRUCTURE 1-5]	Opens the Structure screen.
[SHIFT] + [AP-Synthesis]	Opens the AP-Synthesis screen.
[SHIFT] + [Vocal Designer]	Opens the Vocal Designer screen.
[SHIFT] + [OSC1]	Opens the OSC1 screen.
[SHIFT] + [OSC2]	Opens the OSC2 screen.
[SHIFT] + [COSM1]	Opens the COSM1 screen.
[SHIFT] + [COSM2]	Opens the COSM2 screen.
[SHIFT] + [MOD]	Opens the MOD screen.

[SHIFT] + [TVA]	Opens the TVA screen.
[SHIFT] + [CHO]	Opens the Chorus screen.
[SHIFT] + [REV]	Opens the Reverb screen.
[SHIFT] + [TFX]	Opens the Tone-FX screen.
[SHIFT] + [ARPEGGIO ON/OFF]	Opens the Arpeggio screen.
[SHIFT] + [ARPEGGIO HOLD]	Opens the Arpeggio Pattern Edit screen.

18 Numeric Keys

You can select a patch by using the numeric keys. Enter a number and press [ENTER] to finalize your choice. In addition to selecting patches, the numeric keys can also be used for numeric input such as selecting tones, effects, or waveforms (p. 34).

[EXIT]

Return to the previous screen, or close the currently open window. In some screens, this causes the currently executing function to be aborted.

[ENTER]

Use this to finalize a value or execute an operation.

19 [DEC/-], [INC/+]

These are used to modify values. If you keep on holding down one button while pressing the other, the value change accelerates. If you press one of these buttons while holding down [SHIFT], the value will change in bigger increments. (p. 34)

20 KEY MODE

TONE [LOWER] TONE [UPPER]	If [SELECT] is unlit: These switch the upper tone and lower tone on/off. If both are off, there will be no sound. If [SELECT] is lit: These select the upper tone or lower tone. You cannot select both simultaneously.
SELECT	Switches the function of the TONE LOWER/UPPER buttons.
KEY RANGE	Opens the Key Range screen, where you can make settings for the keyboard (p. 68).

21 STRUCTURE

Here you can turn each sound-producing element (section) on or off.

[1], [2], [3], [4], [5]	Switches the structure type (the way in which the sections are connected).
[AP-SYNTHESIS], [VOCAL DESIGNER], [OSC1], [OSC2], [MOD], [COSM1], [COSM2], [TVA]	These buttons switch the corresponding section on/off.

22 FX (EFFECTS)

Here you can switch the onboard effects (Tone effects, chorus, reverb) on/off. When an effect is on, the indicator for its button will light.

[TONE FX]	Switches tone effects on and off.
[CHORUS]	Switches chorus on and off.
[REVERB]	Switches reverb on and off.

23 AP-SYNTHESIS MODIFY knob

This lets you modify the sound of AP-Synthesis. You can specify the parameter that will be modified (p. 124).

24 OSC1, OSC2

Here you can adjust the oscillator section. These knobs are active if the oscillator is on (indicator lit). The result of adjusting these knob will depend on the oscillator type that is selected.

[PITCH]	This modifies the pitch.	
[TIME]/[PW]	TIME	This modifies the time.
	PW	This modifies the pulse width.
[FORMANT]/[FAT]	FORMANT	This modifies the formant.
	FAT	Adjusts the fatness of the sound when using an analog oscillator.

25 COSM1, COSM2

Here you can adjust the COSM sections. These knobs are active when COSM is on (indicator lit). The result of adjusting these knobs will depend on the COSM type that is selected.

[WIDTH]/[CUTOFF]	WIDTH	Adjusts the width when SBF (Side Band Filter) is selected.
	CUTOFF	If a filter-type COSM is selected, this adjusts the cutoff frequency.
* If any other type is selected, this adjusts the parameter assigned to the type.		
[DETUNE]/[RESO]	DETUNE	Adjusts the detune when SBF (Side Band Filter) is selected.
	RESO	If a filter-type COSM is selected, this adjusts the resonance.
* If any other type is selected, this adjusts the parameter assigned to the type.		

26 ENV

Here you can adjust the TVA section (p. 35).

- **When the ENV section's TVA indicator is on (lit)**

[A]	This modifies the Attack Time.
[D]	This modifies the Decay Time.
[S]	This modifies the Sustain Level.
[R]	This modifies the Release Time.

- **When the ENV section's SCREEN indicator is on (lit)**

The ADSR sliders shown in the display can be operated directly.

Rear Panel

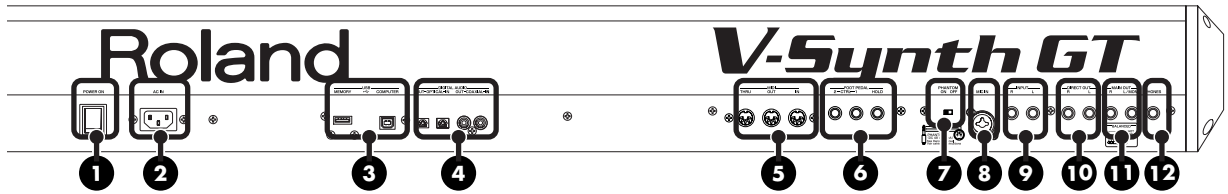

1 POWER Switch

This switch turns the power on/off.

2 AC Inlet

Connect the included power cord to this inlet.

3 USB Connectors

These are USB connectors. They allow the V-Synth GT to be connected to your computer to transfer files (p. 221) or to transmit and receive MIDI and audio data.

MEMORY	You can connect a USB memory device to this connector, and load files from the USB memory device into the V-Synth GT.
COMPUTER	Use a USB cable to connect this to your computer. Both MIDI and audio data can be transferred via this connection.

- * In order to use the USB MIDI and audio functionality, you'll need to install the USB driver in your computer as described in the separate "Driver Installation Guide."
- * Never insert or remove a USB memory while this unit's power is on. Doing so may corrupt the unit's data or the data on the USB memory.
- * Carefully insert the USB memory all the way in—until it is firmly in place.

4 DIGITAL AUDIO Connectors

OPTICAL IN/ OUT COAXIAL IN/OUT	These connectors input/output a digital audio signal (stereo). The output signal is identical to the signal that is output from the MAIN OUT jacks.
---	---

5 MIDI Connectors

IN	These connectors can be connected to other MIDI devices to receive and transmit MIDI messages.
OUT	
THRU	

6 FOOT PEDAL Jacks

CTRL 1, CTRL 2	You can connect optional expression pedals (EV series) to these jacks. By assigning a desired function to a pedal, you can use it to select or modify sound or perform various other control.
HOLD	An optional pedal switch (DP series) can be connected to this jack for use as a hold pedal.

- * Use only the specified expression pedal (EV series; sold separately). By connecting any other expression pedals, you risk causing malfunction and/or damage to the unit.

7 PHANTOM Switch

This switch turns the phantom power on/off for the XLR type connector of the MIC IN jack.

- * Always turn the phantom power off when connecting any device other than condenser microphones that require phantom power. You risk causing damage if you mistakenly supply phantom power to dynamic microphones, audio playback devices, or other devices that don't require such power. Be sure to check the specifications of any microphone you intend to use by referring to the manual that came with it. (This instrument's phantom power: 48 V DC, 10 mA Max)
- * It will take some time for the phantom power voltage to drop after you turn the switch off.

8 MIC IN Jack

This is a mic jack for analog audio signal input. It accommodates either XLR type or phone type plugs. XLR type connections can provide 48 V phantom power, allowing you to connect condenser mics that require phantom power. In this case, turn the PHANTOM switch to "ON."

* This instrument is equipped with balanced (XLR/TRS) type jack. Wiring diagrams for this jack are shown below. Make connections after first checking the wiring diagrams of other equipment you intend to connect.

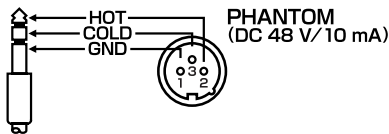

9 INPUT Jacks

L	An external audio source such as a CD player can be connected to these jacks for sampling or external input.
R	

* When connection cables with resistors are used, the volume level of equipment connected to the INPUT jacks may be low. If this happens, use connection cables that do not contain resistors.

10 DIRECT OUT Jacks

L	These jacks output the sound for which the effect routing (p. 139) output assignment is "DIR." You can connect to these jacks when using an external effects processor or other device.
R	

11 MAIN OUT Jacks

L/MONO	These jacks output the audio signal to the connected mixer/amplifier system in stereo. For mono output, use the L jack (p. 17). These also feature balanced output.
R	

12 PHONES Jack

This is the jack for connecting headphones (sold separately).

Overview of the V-Synth GT

How the V-Synth GT Is Organized

Basic Structure

Broadly speaking, the V-Synth GT consists of a controller section and a sound generator section.

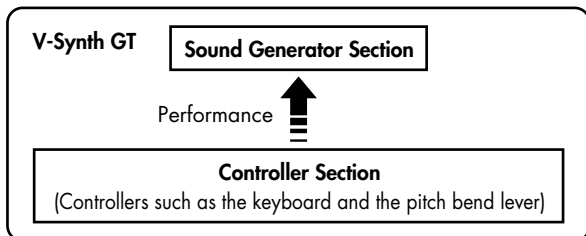

Sound Generator Section

The units of sound that you play on the V-Synth GT are called "patches." A patch consists of two tones, upper and lower. For more about patches and tones, refer to "How Patches and Tones are related" in the Quick Start manual.

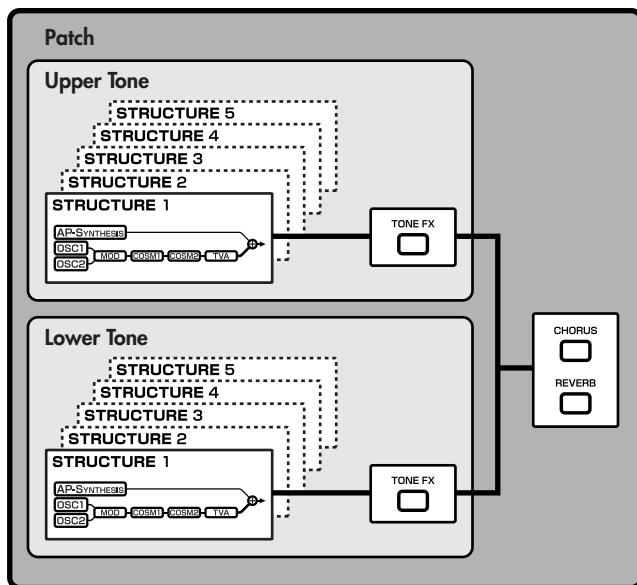

Controller Section

The controller section consists of the keyboard, pitch bend/modulation lever, time trip pad, D Beam controller, C1/C2 knobs, E1–E8 knobs, S1/S2 buttons, arpeggiator, and pedals connected to the rear panel. When you manipulate these controllers, they send performance data to the sound generator section, causing the V-Synth GT to create sound.

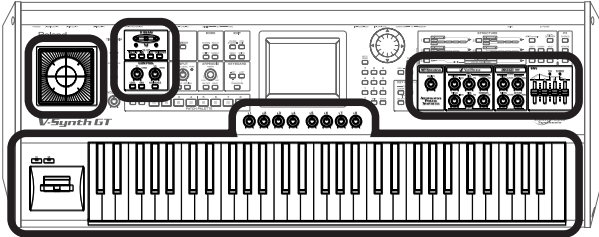

Controller Section
(Controllers such as the keyboard and the pitch bend lever)

Polyphony

The maximum polyphony of the V-Synth GT depends on the OSC and COSM types used by the patch.

MEMO Changing the effect type or switching effects on/off does not affect the available polyphony.

About Structures

The V-Synth GT's upper tone and lower tone consist of eight elements (**sections**) that create the sound.

The way in which these sections are combined is called the **structure type**.

To create a tone for the V-Synth GT, you need to start by specifying the structure type. Then, you can edit the parameters of each section.

Structure Type

You can choose one of five structure types, as follows.

Structure type		Explanation
1		<p>This is the most typical structure.</p> <p>Different sounds produced by OSC1 and OSC2 can be mixed by MOD, processed through COSM1 using an SBF (Side Band Filter) or other process to modify the tonal character, and the tone adjusted by the TVF selected for COSM2.</p> <p>The sound of the V-Synth GT's new AP-Synthesis can be mixed into the final result.</p>
2		<p>This structure connects OSC1 and OSC2 asymmetrically, and is a good choice when you want to use a modulation type other than "MIX" as the modulator. You can use OSC1 and COSM1 to create the basics of the sound, use the OSC2 sound and the MOD selection to add variety, and select TVF for COSM2 to adjust the tone.</p> <p>The sound of the V-Synth GT's new AP-Synthesis can be mixed into the final result.</p>
3		<p>This structure pairs OSC1 with COSM1 and OSC2 with COSM2. For example, you can use the Time Trip pad or other controller to morph between the sound created by OSC1 and COSM1 and the sound created by OSC2 and COSM2.</p> <p>The sound of the V-Synth GT's new AP-Synthesis can be mixed into the final sound.</p>
4		<p>Unlike types 1–3, this structure lets you apply MOD effects to AP-Synthesis sounds.</p>
5		<p>If you select this structure, you'll be able to perform using Vocal Designer.</p> <p>The sound of the V-Synth GT's new AP-Synthesis can be mixed into the final sound.</p>

MEMO To select a structure type, press STRUCTURE [1]–[5].
 You can also select the structure type in the screen (p. 37).

Section

There are eight sections, as follows.

Section name	Explanation
OSC1, OSC2	These sections produce the sound. You can select internal preset waves or waves you've sampled, or use analog-modeled waves generated by calculations. You can also use external audio input.
MOD	In this section, the two audio signals are mixed and modulated.
COSM1, COSM2	In these sections you can apply a variety of effects such as filtering. This is similar to effect processing, but while a conventional effect processes the final mixed sound, COSM applies the effect to each individual note.
TVA	This section creates time-varying changes in volume, or panning effects.
AP-SYNTHESIS	This section generates sound. By selecting an instrumental waveform, then applying a phrase model that models the unique expression and behavior of a particular instrument, you can create natural as well as innovative sounds.
VOCAL DESIGNER	This section lets you use Vocal Designer. You can input sound via the mic connector, and perform using it.

MEMO

After you've selected a structure type, you can turn the various section buttons on/off to disable sections you're not using.
You can also turn sections on/off from within the display (p. 37).

NOTE

AP-Synthesis and Vocal Designer can only be turned on for the upper or the lower tone, not for both.

About Memory

Memory Structure

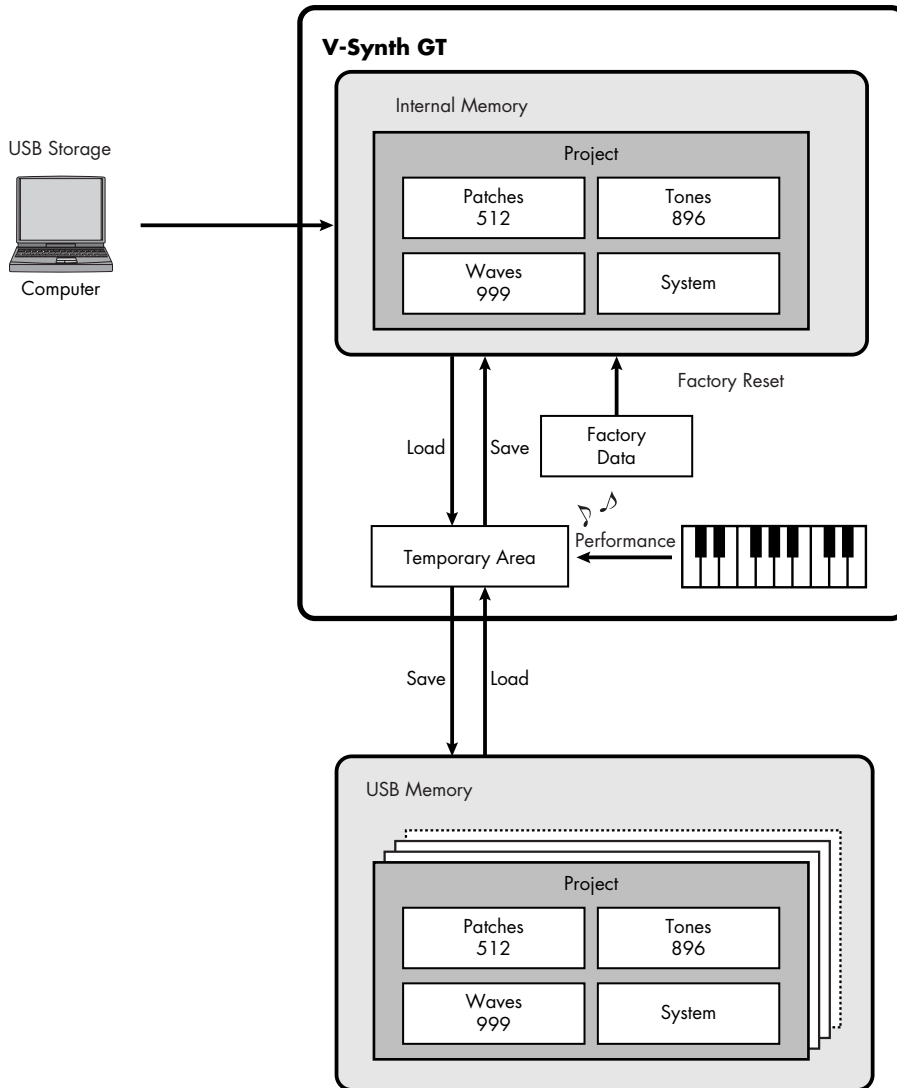

Project

The largest unit of memory used by the V-Synth GT is the project. A project contains up to 512 patches, up to 896 tones, up to 999 waves, and various system settings.

The V-Synth GT uses one project at a time.

Internal Memory

The V-Synth GT has internal memory that stores a project. When the V-Synth GT is shipped from the factory, this memory already contains patch and wave data, but you are free to overwrite any of this. You can always restore the memory to the factory-set contents (Factory Reset, p. 235).

Temporary Area

When you switch on the V-Synth GT's power or load a project, the project data is located in an area of memory called the temporary area.

Operations such as sampling or patch editing will affect the data in the temporary area.

If you simply turn off the power, the edited sample data or patch data will be lost; you must be sure to save it (using SAVE/WRITE) if you want to keep it.

USB Memory

Internal memory can hold only one project, but you can use commercially available USB memory to store additional projects.

USB Storage

If you connect the V-Synth GT to your computer via a USB cable, projects, patches, tones, and wave data in the V-Synth GT's internal memory can be saved (backed up) to the hard disk or other media on your computer (p. 221).

In addition, wave data created on the V-Synth GT can also be used by software running on your computer, or wave data created by your computer software can be used on the V-Synth GT.

Sampling Memory

The amount of memory you can use for sampling will depend on the state of the project that is currently loaded into the temporary area. With the factory-set project, there is approximately 69 seconds (stereo) / 138 seconds (monaural) of sampling memory. If you delete the factory-set waves, you will be able to use a maximum of approximately 380 seconds (stereo) / 760 seconds (monaural) of sampling memory. However since a maximum of approximately 290 seconds (stereo) / 580 seconds (monaural) can be saved in internal memory, you will need to use a commercially available USB memory if you want to store more samples than this.

* The above values are for when the sample is encoded using the "LITE" type (p. 188).

MEMO The factory-set waves can be restored using the Factory Reset operation (p. 235) even if they have been erased.

Factory Data

The factory data is an area of memory that stores the state of internal memory when the V-Synth GT is shipped from the factory. If you've erased the factory-set patch or wave data from internal memory, but decide that you would like to use it again, you can execute the Factory Reset procedure to bring this data back.

About VariPhrase

What is VariPhrase?

VariPhrase has the following advantages:

- 1. Capable of changing the pitch, rate of time expansion/compression and voice characteristics (formant) on a real-time basis.**
- 2. Allows easy synchronization to tempo and pitch.**
- 3. A single sample covers an extended range of keys compared to conventional digital samplers.**
- 4. Retains sound quality, while implementing the above three advantages.**

VariPhrase overcomes many problems that conventional samplers and digital recorders have with audio phrases. Typical issues with Digital Samplers and Digital recorders

- Changing tempo affects Pitch.
- Changing the pitch of phrases affects tempo and formant of the sound.
- Limited control of audio phrases. You cannot adjust a partial section of a sound in real-time.
- Most samplers require multiple samples over limited key ranges for realistic playback of a sound.
- Samples of the same tempo must be available for performing chords, otherwise the notes of the chord will be out of sync.
- Pitch or tempo changes on Digital samplers tends to degrade audio quality.

VariPhrase solves all of these problems.

 For more about VariPhrase, refer to "What is VariPhrase?" in Quick Start.

Basic Operation of the V-Synth GT

Basic Operations in the Touch Panel

The V-Synth GT features a touch screen. The touch screen lets you perform a variety of operations by lightly touching the screen.

- * The touch screen responds to a light touch. Pressing the touch screen with too much force, or with a hard object, may damage it. Be careful not to apply excessive force, and touch it only with your finger.

cf. Enabling/Disabling the Beep Tone (p. 227)

Moving the Cursor

A single screen or window displays multiple parameters or items for selection. To edit a parameter's value, move the cursor to the value. The cursor is a black rectangle, and the parameter value or item you select with the cursor is highlighted (displayed in inverted colors).



Cursor Buttons

Press [▲], [▼], [◀], or [▶] (the cursor buttons) to move the cursor.

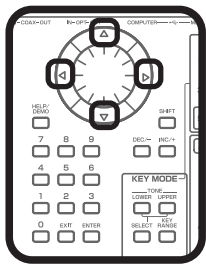

Touch Screen

Directly touch a parameter value to move the cursor.



Editing a Value

To edit a value, you can use the VALUE dial, [INC/+] [DEC/-], or drag on the touch screen.

- In each V-Synth GT screen, you can select a value using the cursor as described earlier, and modify its value.
- Each parameter has its own range of possible values. You cannot set any value smaller than the minimum value or greater than the maximum value.

VALUE Dial

Turning the VALUE dial clockwise increases the value, and turning it counterclockwise decreases its value. Hold down [SHIFT] as you move the VALUE dial to increase value increments to make large value changes more quickly.

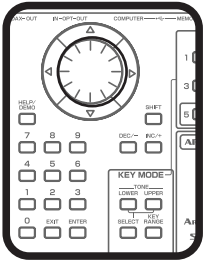

[INC/+] and [DEC/-]

Press [INC/+] to increase the selected value, and [DEC/-] to decrease it. Keep the button pressed for continuous adjustment. For faster value increases, keep [INC/+] pressed down and press [DEC/-]. To decrease values quickly, keep [DEC/-] pressed down and press [INC/+].

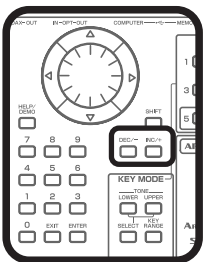

Touch Screen

Touch a parameter value, and drag your finger up/down or left/right. Dragging upward or to the right increases the value, and dragging downward or to the left decreases the value.

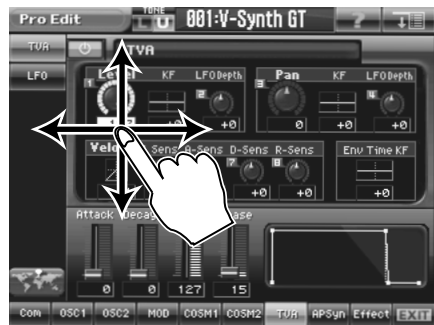

Numeric Keys

You can select a patch by using the numeric keys. Enter a number and press [ENTER] to finalize your choice. In addition to selecting patches, the numeric keys can also be used for numeric input such as selecting tones, effects, or waveforms.

Here's how to enter a numeric value in a value box.

- [0]–[9] buttons: Enter numerals.
- [ENTER] button: Finalizes the value you entered.
- [EXIT] button: Cancels the value you entered.

NOTE For some parameters, it may not be possible to enter a value correctly using the numeric keys.

E1-E8 Knobs

If the small numbers 1-8 are shown in the display, you can use the E1-E8 knobs to control the corresponding parameters.

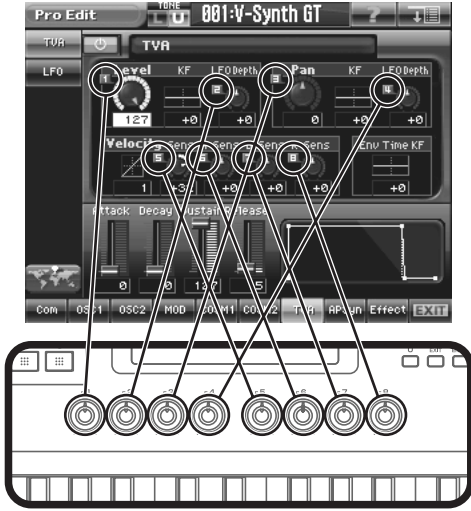

Envelope Sliders

- When the ENV section's TVA indicator is on (lit)

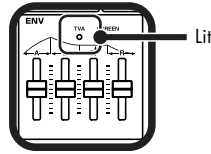

You can use the envelope sliders to edit the ADSR values of the TVA section (p. 119).

[A]	This modifies the Attack Time.
[D]	This modifies the Decay Time.
[S]	This modifies the Sustain Level.
[R]	This modifies the Release Time.

- When the ENV section's SCREEN indicator is on (lit)

The ADSR sliders shown in the display can be operated directly.

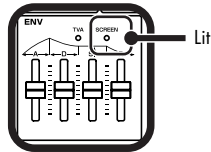

Common Icons in the Touch Panel

The V-Synth GT's touch panel contains certain icons that perform common operations regardless of the scene. In many cases you can also use the panel buttons to perform these operations, but it's worth knowing about these icons, since they allow you to complete an operation from within the touch panel.

Search



When you touch this icon, a new window will open, displaying a choice of values (such as a patch list or tone list) that are available in that situation. To select a value, you can turn the VALUE dial, use the [INC/+] [DEC/-] keys, or directly touch an item in the touch panel.

ON/OFF



This turns a function on/off. When you touch this icon to turn it on, the button will light green.

HELP



If this icon is lit green, you can touch the icon to open the Help window. This window will display a simple explanation of the function or procedure.

EXIT



When you touch this icon you will return to the previous screen. You can also return by pressing the V-Synth GT's [EXIT] button.

MAP



Since the V-Synth GT gives you a wide range of sound-creating elements, you may lose track of the section you're currently editing. If so, you can press this button to open the V-Synth GT Map window, which will show you the currently selected structure and the section you're editing.

MENU



Opens the pulldown menu.

Using the Map Function

Since the V-Synth GT lets you edit many different aspects of the sound, you may lose track of what you're currently editing in a patch or tone.

If so, you can use the Map function to open the V-Synth GT Map window, which will show you the currently selected structure, and the section you're editing within that structure.

From this screen you can also change the structure, or turn various functions on/off, so there's no danger of becoming lost in an enormous number of parameters.

1. Touch <MAP>.

The V-Synth GT Map window will appear.



2. This shows the overall structure and the section you're currently editing.

Section being edited
and selected parameter

Switch on/off and jump

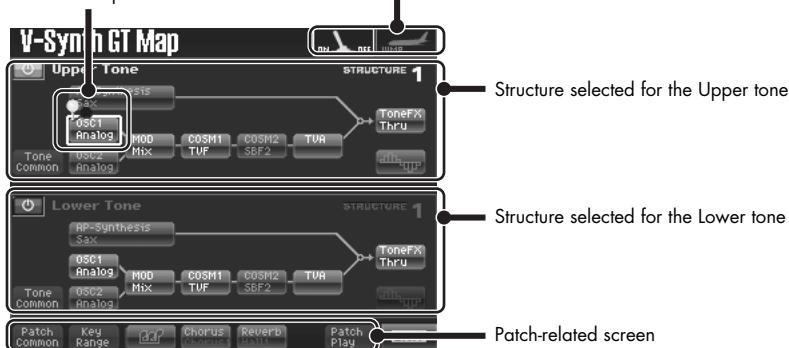

The icon that indicates each section will show the parameter that is selected.

When is selected:

You can touch the icon in the panel to turn that section on/off.

When is selected:

You can touch the icon in the panel to jump directly to the corresponding parameter setting screen.

The V-Synth GT's Four Modes

The V-Synth GT provides a large number of functions, which are organized into four operating modes: **Patch mode**, **Sample mode**, **System mode**, and **Utility mode**.

Patch Mode (p. 39)



When you press [PATCH], you'll be in Patch mode. In this mode you can play patches from the keyboard, and edit patch settings.

System Mode (p. 193)



When you press [SYSTEM], you'll be in System mode. Here you can make settings that affect the V-Synth GT's operating environment, such as tuning and how MIDI messages will be received.

Sample Mode (p. 163)

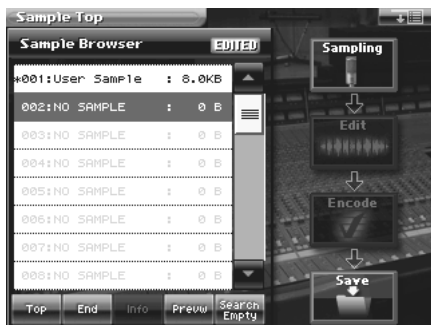

When you press [SAMPLE], you'll be in Sample mode. In this mode you can sample waves that can be used as the basis of sound creation, or edit waves you've sampled.

Utility Mode (p. 214)



When you press [UTILITY], you'll be in Utility mode. Here you can make various settings for the V-Synth GT.

Patch Mode (Playing in Patch Mode)

About the Patch Play Screen

When you press [PATCH], you'll be in Patch mode, and the Patch Play screen will appear.

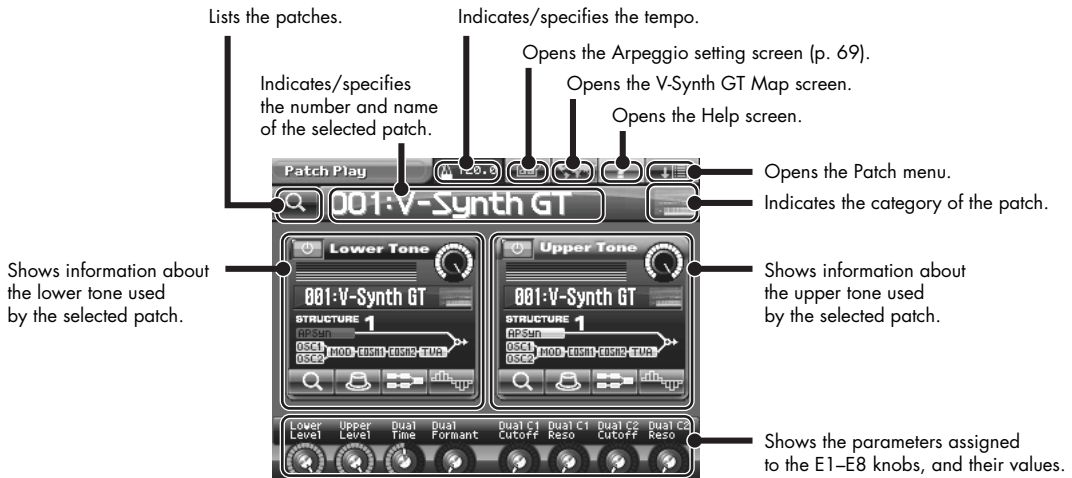

A patch consists of two tones, and you can use the following portions of the screen to control each tone.

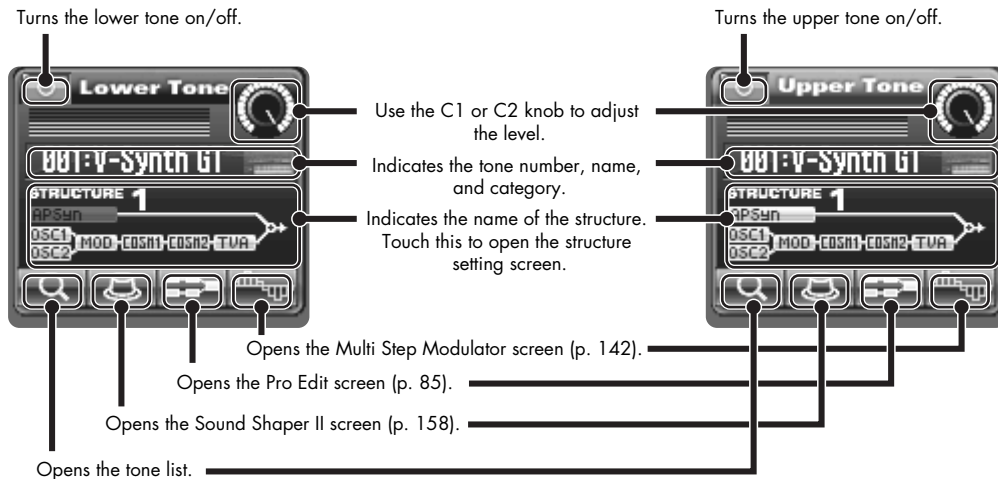

Selecting a Patch

1. Press [PATCH] to access the Patch Play screen.



Search Button

2. Move the cursor to the patch number, either by using the cursor buttons or by touching the patch number indication (the patch name field will light).
3. Select a patch number.

You can use any of the following methods to specify the patch number.

- Turn the VALUE dial
- Press [INC/+] or [DEC/-]
- Drag on the touch panel
- Use the numeric keys to directly enter a patch number (p. 34)
For example, if you want to select patch number 123, consecutively press numeric keys [1], [2], and [3], and then press [ENTER] to finalize your selection.

cf. → “Selecting Patches from the List” (p. 41)
“Selecting Favorite Patches (Patch Palette)” (p. 42)

Selecting Patches from the List

You can display a list of patches and select a patch from that list.

1. In the upper left of the screen, touch the search button.

The Patch List window appears.



Keyword Search Area

Category Search Area

2. Select a patch from the list.

Either turn the VALUE dial or use [INC/+] [DEC/-] to select a patch. You can also select a patch by touching it on the display.

TIP If you select a patch in the list and play the keyboard, the selected patch will sound. This is a useful way to audition the sound of a patch.

TIP By turning the [E8] knob you can scroll the list rapidly.

3. Touch <OK>.

The patch is selected and the Patch List window closes.

Selecting Patches by Category

Touch the <Category Search Area> to open the Category Search palette. Here you can view only the patches of the category you specify, allowing you to quickly find the patch you want.

To return to viewing all patches, touch <X>.

Selecting Patches by Keyword

Touch the <Keyword Search Area> to open the virtual keyboard. When you type a keyword and touch <ok>, only the patches that include the specified keyword will be displayed, allowing you to quickly find the patch you want.

To return to viewing all patches, touch <X>.

Selecting Favorite Patches (Patch Palette)

Favorite patches you use frequently can be registered in the Patch Palette. This allows you to quickly select favorite patches that are stored in the V-Synth GT.

cf. For details on registering a patch in the patch palette, refer to “**Registering a Favorite Patch (Patch Palette)**” (p. 42).

1. Press [PATCH] to access the Patch Play screen.
2. Press PATCH PALETTE [1]–[8] to select a patch.

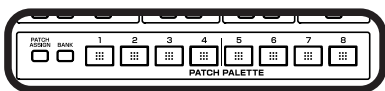

3. If you want to switch patch palette banks, hold down [BANK] and press PATCH PALETTE [1]–[8].
When you press [BANK], the indicator of the button for the currently selected bank number (PATCH PALETTE [1]–[8]) will blink.

Registering a Favorite Patch (Patch Palette)

You can bring together your favorite and most frequently used patches in one place by registering them into the patch palette. By using this function you can rapidly select favorite patches from internal memory. You can register a total of 64 sounds (8 sounds x 8 banks) as favorite sounds.

cf. For details on how to select patches that are registered in the patch palette, refer to “**Selecting Favorite Patches (Patch Palette)**” (p. 42).

1. Access the Patch Play screen, and select the patch that you wish to register (p. 40).
2. Hold down [BANK] and press a PATCH PALETTE [1]–[8] to select the bank in which you wish to register the sound.
When you press [BANK], the indicator of the currently selected bank button (NUMBER [1]–[8]) will blink.
3. Hold down [PATCH ASSIGN] and press a PATCH PALETTE [1]–[8] to select the button at which you wish to register the sound.
When the display indicates “Registration Completed!,” registration has been completed.

Applying Various Effects to the Sound

Varying the Velocity or Aftertouch

The force with which you play the keyboard, or the “velocity” with which you play, can affect the volume or timbre of a sound. Aftertouch—downward pressure you apply to a key after playing a note—can also affect the sound.

Pitch Bend/Modulation Lever

While playing the keyboard, move the lever to the left to lower the pitch of the currently selected patch, or to the right to raise its pitch. This is known as **pitch bend**. You can also apply vibrato and so on by gently pushing the lever away from you. This is known as **modulation**. For AP-Synthesis, this lever will apply the effect that is assigned. If you push the lever away from you and at the same time move it to the right or left, you can apply both effects at once.

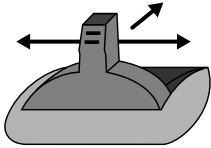

Transpose (Transposing the Keyboard in Semitone Steps)

Transpose changes keyboard pitch in units of semitones.

This function is useful when you play transposed instruments such as trumpet or clarinet following a printed score.

1. While holding down [TRANSPPOSE], press [+OCT] or [-OCT] to transpose the keyboard.

Pressing [+OCT] once while holding down [TRANSPPOSE] will raise the keyboard one semitone.

Pressing [-OCT] once while holding down [TRANSPPOSE] will lower the keyboard one semitone.

2. To turn off Transpose, press [TRANSPPOSE] once again so that its indicator goes off.

The Transpose setting you make will be maintained.

NOTE There is a single Transpose setting (Setup parameter) for the entire V-Synth GT. The changed setting will be remembered even if you switch patches.

Octave Shift (Transposing the Keyboard in Octave Units)

The Octave Shift function transposes the pitch of the keyboard in 1 octave units (-3– +3 octaves). For playing a bass part more easily using your right hand, transpose the keyboard down by 1 or 2 octaves.

1. Press [+OCT] or [-OCT] and its indicator will light.

Pressing [+OCT] once will raise the keyboard 1 octave.

Pressing [-OCT] once will lower the keyboard 1 octave.

NOTE There is a single Octave Shift setting (Setup parameter) for the entire V-Synth GT. The changed setting will be remembered even if you switch patches.

2. To cancel Octave Shift, continue pressing the opposite button until the indicator goes out.

Applying an Effect by Touching Your Finger to the Pad (Time Trip Pad)

You can apply a variety of effects by touching your fingertip to the Time Trip pad located at the left side of the V-Synth GT's panel.

What is the Time Trip Function?

One of the advantages of VariPhrase (p. 32) is that the playback location and speed of the wave can be changed in real time. The Time Trip function takes advantage of this ability to manually control the playback location and speed of the wave. In patches that use VariPhrase, switch the Time Trip Pad function to "TIME TRIP" to use this function. While playing the keyboard, touch the Time Trip pad and the currently sounding wave will stop at the current playback location. Then as you move your finger from that point in a circle, the wave playback will advance in the direction of conventional playback (clockwise), or the reverse (counterclockwise). Unlike "scratching" on a turntable, this lets you control the playback without affecting the pitch, so you can play the sound at the pitch you specify from the keyboard.

You can use the D Beam controller to produce similar results.

NOTE The Time Trip pad will have an effect if PCM is selected as the oscillator (OSC1/OSC2) (p. 95) and the "Time Trip Sw (Time Trip Switch)" (p. 99) is on.

1. Press [PATCH] to access the Patch Play screen.
2. Choose the function that you want to control from the Time Trip pad, and press the TIME TRIP PAD button for that function.

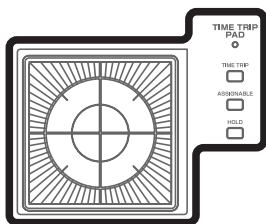

[TIME TRIP]	Applies the Time Trip effect.
[ASSIGNABLE]	Applies the effect that is specified by each tone. If [ASSIGNABLE] is on, the effect is applied via matrix control. This means that matrix control settings must be made separately. Set the matrix control Source to "PAD-X" or "PAD-Y," and specify the parameter to be controlled in Destination. For details on these settings, refer to "Matrix Control" (p. 91). By setting matrix control Source to "TRIP-R," you can apply the Time Trip effect and the matrix control effect simultaneously. In this case, turn [TIME TRIP] on.

3. While you play the keyboard to produce sound, place your fingertip on the Time Trip pad and move your finger in the following way.

If [TIME TRIP] is on

The effect will be applied when you move your finger in a circle on the Time Trip pad.

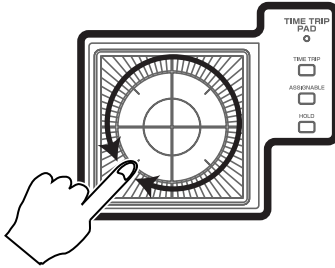

If you are using matrix control as well, the effect will be applied when you move your finger from the circumference of the Time Trip pad toward the center.

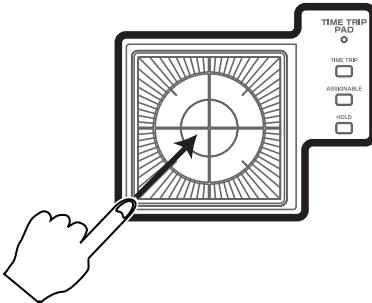

If [ASSIGNABLE] is on

The effect will be applied when you move your finger up/down/left/right on the Time Trip pad.

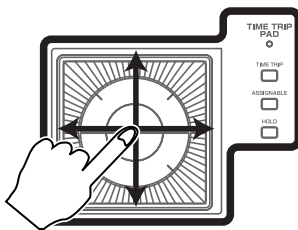

TIP

- By pressing TIME TRIP PAD [HOLD], you can cause the effect to be held even after you take your finger off the Time Trip pad.
- The Time Trip Pad settings are saved with each patch. This means that you can create patches that contain Time Trip Pad settings you like.

Applying an Effect by Passing Your Hand Over the D Beam

The D Beam controller can be used simply by waving your hand over it. It can be used to apply various effects, depending on the function that is assigned to it. You can also create effects in which the sound changes instantaneously, in a way that would not be possible by operating a knob or the bender lever.

1. Press [PATCH] to access the Patch Play screen.
2. Choose the function that you want to control from the D Beam controller, and press the D BEAM button for that function to turn on the D Beam controller.

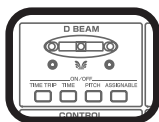

[TIME TRIP]	Applies the Time Trip effect (p. 46).
[TIME]	Applies the time control effect.
[PITCH]	Applies the pitch control effect.
[ASSIGNABLE]	Applies the effect that is specified by each tone. By turning [ASSIGNABLE] on, you can apply the effect that is specified by each patch. In this case, however, unlike the other three functions, simply pressing the button to turn it on will not apply an effect. You will also need to make matrix control settings. Set the matrix control Source to "BEAM-L" or "BEAM-R," and specify the parameter to be controlled in Destination. For details on these settings, refer to "Matrix Control" (p. 91).

3. While playing the keyboard to produce sound, place your hand over the D Beam, and slowly move it up and down.
Effects will be applied to the sound according to the button you pressed in step 2.
4. To turn off the D Beam controller, once again press the button that you pressed in step 2, so its indicator goes out.



- The D Beam controller settings are saved with each patch. This means that you can create patches that contain D Beam settings you like.
- By assigning a MIDI controller number to the D Beam controller, you can use the D Beam to control an external MIDI device that is connected. For details, refer to "1–4 Assign L, R (D Beam 1–4 Assign L, R)" (p. 205).

The usable range of the D Beam controller

The following diagram shows the usable range of the D Beam controller. Waving your hand outside this range will produce no effect.

The D BEAM indicator will light when the D Beam controller is responding. The D BEAM indicator will not light if you are outside the valid range of the D Beam controller.

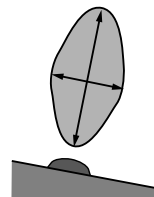

The usable range of the D Beam controller will become extremely small when used under strong direct sunlight. Please be aware of this when using the D Beam controller outside.

Using the E1–E8 Knobs

You can modify the sound in real time by turning the E1–E8 knobs to control the functions assigned to the knobs.

1. Press [PATCH] to access the Patch Play screen.
2. While playing the keyboard to produce sound, turn the E1–E8 knobs.

When you turn a knob, the sound will change according to the function that is assigned to that knob. You can check what function is assigned to a particular knob by viewing the eight knobs shown in the screen.

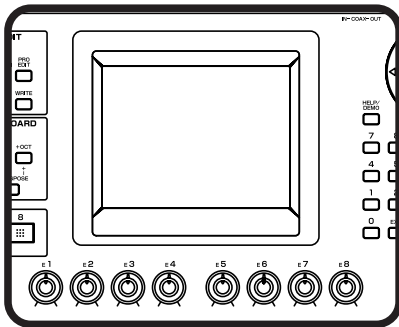

TIP You can use the Utility menu to edit the assignments that the E1–E8 knobs will perform in the Patch Play screen (p. 228).

Using the Assignable Controllers

You can turn the ASSIGNABLE CONTROL knobs to modify the sound in real time.

The assignable controllers use matrix control to apply effects to the sound. This means that you will need to make matrix control settings separately. Set the matrix control Source to “KNOB1” or “KNOB2,” and specify the parameter to be controlled in Destination. For details on this setting, refer to “**Matrix Control**” (p. 91).

1. Press [PATCH] to access the Patch Play screen.

2. Press [ASSIGNABLE].

TIP If you press [LEVEL] or [PAN], the knobs will adjust the level or pan of the upper and lower tones.

3. While playing the keyboard to produce sound, turn the ASSIGNABLE CONTROL knobs ([C1], [C2]).

The sound will change according to the function assigned to each knob.

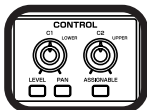

TIP By assigning MIDI controller numbers to the assignable controllers, you can turn [C1] or [C2] to control an external MIDI device that is connected. For details, refer to “**C1/C2 Knob**” (p. 206).

Arpeggiator

Playing Arpeggios

The V-Synth GT comes with an arpeggiator that can play arpeggios automatically. Once you turn on the arpeggiator, the keys you press will automatically be played as an arpeggio.

- 1. Press [PATCH] to access the Patch Play screen.**
- 2. Press ARPEGGIO [ON/OFF] to make the indicator light.**
The arpeggiator is turned on.
- 3. Play the keyboard.**
The V-Synth GT arpeggiates what you've played.
- 4. To adjust the tempo of the arpeggio, turn ARPEGGIO [TEMPO].**
Turning the knob toward the right will speed up the tempo, and turning it toward the left will slow down the tempo.
- 5. To finish playing arpeggios, press ARPEGGIO [ON/OFF] again so the indicator turns off.**

Holding an Arpeggio

By using the following procedure, you can produce arpeggios even without continuing to press the keyboard.

- 1. Press ARPEGGIO [ON/OFF] to turn the Arpeggiator on.**
- 2. Press ARPEGGIO [HOLD] to make the indicator light.**
- 3. Play the keyboard.**
- 4. If you play a different chord or notes while the arpeggio is being held, the arpeggio will change accordingly.**
- 5. To cancel Arpeggio Hold, press ARPEGGIO [HOLD] again.**

When Using a Hold Pedal

If you play an arpeggio while pressing the hold pedal, the arpeggio will continue to be played even if you release the keyboard.

- 1. Connect an optional pedal switch (DP series) to the HOLD PEDAL jack.**
- 2. Press ARPEGGIO [ON/OFF] to turn the Arpeggiator on.**
- 3. Play the keyboard while pressing the hold pedal.**
- 4. If you play a different chord or notes while the arpeggio is being held, the arpeggio will change accordingly.**

V-LINK (Synchronizing Music and Video While You Play the V-Synth GT)

The V-Synth GT lets you use the pitch bend/modulation lever, Time Trip pad, D Beam controller, and C1/C2 knobs to control an externally connected video device that supports V-LINK. This means that your performance on the V-Synth can control not only sound but also images, producing sound and video effects that are linked to your playing.

V-LINK (**V-LINK**) is a function that allows music and images to be performed together. By using MIDI to connect two or more V-LINK compatible devices, you can easily enjoy performing a wide range of visual effects that are linked to the expressive elements of a music performance.

Example Connections

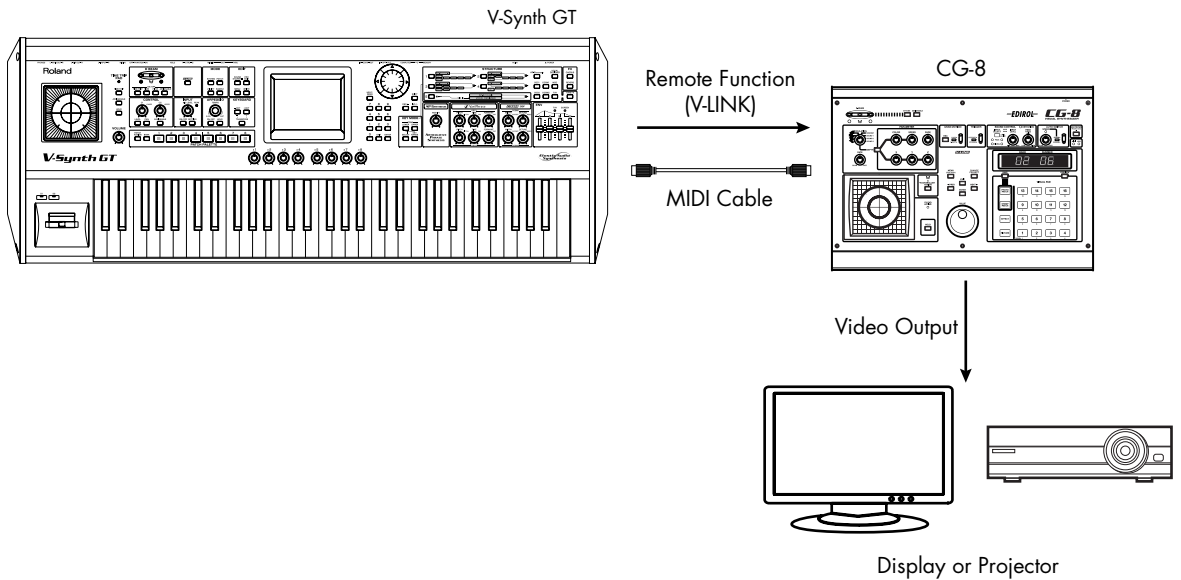

Enter V-LINK Mode

1. Press [V-LINK] so the indicator lights.

V-Synth GT will enter V-LINK mode.



For details on how to assign V-LINK functions to the controllers, refer to “V-LINK Settings” (p. 208).

2. To exit V-LINK mode, press [V-LINK] once again so the indicator goes out.

V-LINK Functions that the V-Synth GT Can Control and MIDI Messages

You can assign the following functions to the V-Synth GT’s controllers to control a V-LINK compatible video device.

V-LINK function	Transmitted MIDI message
Playback Speed	CC 10 (Panpot)
Dissolve Time (amount time the video clips overlap)	CC 5 (Portamento Time)
Audio Level (Volume of audio playback)	CC 7 (Volume)
Color Cb (color-difference signal)	CC 72 (Release)
Color Cr (color-difference signal)	CC 71 (Resonance)
Brightness	CC 74 (Cutoff)
VFX1 (Visual Effects 1)	CC 1 (Modulation)
VFX2 (Visual Effects 2)	CC 91 (Reverb)
VFX3 (Visual Effects 3)	CC 94 (Celeste)
VFX4 (Visual Effects 4)	CC 95 (Phaser)
Output Fade	CC 73 (Attack)
T Bar	CC 11 (Expression)
Dual Stream	CC 64 (Hold 1)
Time Trip	CC 92 (Tremolo) CC 93 (Chorus)
Palette1–8 (Selecting a palette)	CC 0 (Bank Select): 00H–07H
Clip1–8 (Selecting a video clip)	Program Change: 00H–07H

Patch Mode (Editing a Patch)

With the V-Synth GT, you have total control over a wide variety of settings. This chapter explains the procedures used in creating patches, and the functions of the patch parameters.

Creating a Patch

1. Access the Patch Play screen, and select the patch that you want to edit (p. 40).



If you want to create all your patches from the ground up, rather than the patches that have already been prepared, carry out the Initialize operation (p. 62).

2. Select the tones that you want to use for the upper tone and lower tone (p. 55).
3. Apply effects (chorus and reverb) (p. 76).
4. Save the patch (p. 58).



When you carry out a save, any data previously stored at the save destination will be overwritten and lost.

Selecting a Tone

Specifying the Upper Tone and Lower Tone

A patch consists of an upper tone and a lower tone. When selecting a tone, you must first specify which one you're selecting—upper or lower.

1. Press [PATCH] to access the Patch Play screen.
2. Touch <Lower Tone> or <Upper Tone> to select the tone you want to specify.
Alternatively, press [SELECT] so it's lit, then press [TONE LOWER]/[TONE UPPER].

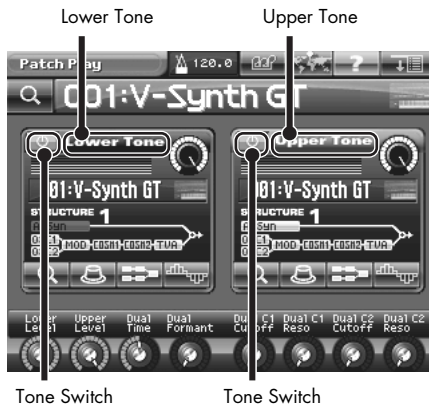

If you don't want the lower or upper tone to be sounded, touch the tone switch to turn it off. Alternatively, press [SELECT] so it's not lit, then press [TONE LOWER]/[TONE UPPER] to turn off a tone.

Selecting a Tone

Once you've specified either the upper or lower tone, you can select the tone.

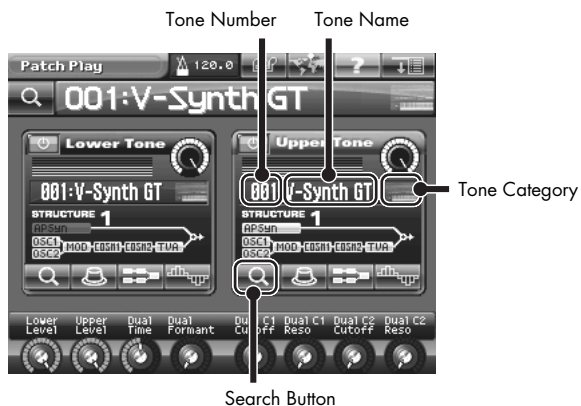

1. Move the cursor to the tone number, either by pressing the cursor buttons, or by touching the tone number indication.

2. Select the desired tone number.

You can use any of the following methods to select a tone number.

- Turn the VALUE dial
- Press [INC/+] or [DEC/-]
- Drag your fingertip on the touch panel
- Use the numeric keys to directly enter a tone number (p. 34)

For example, if you want to select tone number 123, consecutively press numeric keys [1], [2], and [3], and then press [ENTER] to confirm your selection.

Selecting a Tone from a List

You can view a list of tones and select a tone from the list.

1. Touch the search button.

The Upper (or Lower) Tone List window will appear.



2. Choose a tone from the list.

Either turn the VALUE dial or use [INC/+] [DEC/-] to choose a tone. You can also choose a tone by directly touching it in the touch panel.

TIP By turning the [E8] knob you can scroll the list rapidly.

3. Touch <OK>.

The tone will be selected and the Upper (or Lower) Tone List window will close.

Selecting Tones by Category

Touch the <Category Search Area> to open the Category Search palette. Here you can view only the tones of the category you specify, allowing you to quickly find the tone you want.

To return to viewing all tones, touch <X>.

Selecting Tones by Keyword

Touch the <Keyword Search Area> to open the virtual keyboard. When you type a keyword and touch <ok>, only the tones that include the specified keyword will be displayed, allowing you to quickly find the tone you want.

To return to viewing all tones, touch <X>.

Patch Menu

Patch Write (Saving Patches)

Changes you make to sound settings are temporary, and will be lost if you turn off the power or select another sound. If you want to keep the modified sound, you must save it in the internal (internal memory).

When you modify the settings of a patch, the Patch Play screen will indicate “*.” Once you save the patch into internal memory, the “*” indication goes away.

NOTE When you perform the save procedure, the data that previously occupied the save destination will be lost. However, the factory setting data can be recovered by performing the Factory Reset (p. 235).

1. **Make sure that the patch you wish to save is selected.**
2. **Touch <MENU> in the upper right of the screen.**
A pulldown menu appears.



3. **In the pulldown menu, touch <Patch Write>.**
The Patch Write window appears.



4. **Turn the VALUE dial to specify the save-destination patch.**
 - If you touch "Write Upper Tone" or "Write Lower Tone" to add a check mark, the tone(s) used in the patch will also be saved.
 - When you touch <Search>, the Patch Write Number List window will appear, allowing you to select the save-destination patch from the list.
5. **Touch <OK> to execute the Save operation.**

Patch Name (Naming a Patch)

Assign a new name to the patch before you save it. You can assign a name of up to twelve characters to the patch.

1. **Make sure that the patch that you want to name is selected.**
2. **Touch <MENU> in the upper right of the screen.**
A pulldown menu appears.



3. **In the pulldown menu, touch <Patch Name>.**
The Patch Name window appears.



4. **Touch the on-screen alphabetic or numeric keys to enter the new name in the text box.**
The on-screen keys have the following functions.

< << >> >	Move the cursor in the text box to the desired input location.
<shift>	Turn this on when you want to input uppercase letters or symbols.
<clear all>	Erases all characters in the text box.
<back space>	Deletes the character that precedes the cursor location.
<delete>	Deletes the character at the cursor location.

5. **When you have finished inputting, touch <OK> to finalize the patch name.**

If you want to return to the original unedited name, touch <EXIT>.

- * You will lose your edited patch settings if you switch to another patch or turn off the power. If you want to keep a patch whose settings you have edited, then perform the Save operation (p. 58).
- * You can also assign a category to each patch (p. 60).

Patch Category (Assigning the Category of a Patch)

If you assign a category to your patches, you'll be able to search for them by category in the Patch List window.

MEMO If no category is assigned to a patch, its category name will be "No Assign."

1. Make sure that the patch that you want to category is selected.
2. Touch <MENU> in the upper right of the screen.
A pulldown menu appears.



3. In the pulldown menu, touch <Patch Category>.
The Patch Category window appears.



4. Select a category from the list.**Patch Category List**

Category	Contents
No Assign	No Assign
Synth	Synth
Lead	Lead
Pad, Strings	Pad/Strings
Vox, Choir	Voice/Choir
Piano, Keyboards	Piano/Keyboards
Bass, Guitar	Bass/Guitar
Winds	Winds
Bell, Mallet, Hit	Bell/Mallet/Hit
Melodic Sequence	Melodic (i.e., pitched) sequences
Rhythmic Sequence	Rhythmic (i.e., non-pitched) sequences
Arpeggio	Arpeggio
FX, Noise, Ambient	Effect/Noise/Ambient
Ethnic	Ethnic
Drum, Perc	Drum/Percussion
Combination, Others	Combinations using zones (p. 88)/other

5. Touch <OK> to finalize the category.

- * You will lose your edited patch settings if you switch to another patch or turn off the power. If you want to keep a patch whose settings you have edited, then perform the Save operation (p. 58).

Patch Init (Initializing the Patch Settings)

“Initialize” means to return the settings of the currently selected patch to a standard set of values.

NOTE The Initialize operation will affect only the currently selected patch; the patches that are stored in internal memory and temporary area will not be affected. If you wish to restore all of the V-Synth GT's settings to their factory values, perform a Factory Reset (p. 235).

1. Access the Patch Play screen, and select the patch that you wish to initialize (p. 40).
2. Touch <MENU> in the upper right of the screen.
A pulldown menu appears.



3. In the pulldown menu, touch <Patch Init>.
A window like the following appears.



4. If you also want to initialize the tones used in the patch, check the boxes for the tone(s) you want to initialize.
5. Touch <OK>.
The initialization will be carried out.

Patch Common (Settings Shared by the Entire Patch)

Here we'll explain the parameters that are used in common by the entire patch (**Patch Common parameters**).

Editing the Patch Common Parameters

1. Press [PATCH] to access the Patch Play screen.
2. Touch <MENU> in the upper right of the screen.
A pulldown menu appears.



3. In the pulldown menu, touch <Patch Common>.
The Patch Common screen appears.



4. The parameters are organized into several editing groups. Touch one of the buttons at the bottom of the screen to select the edit group containing the parameters you want to set.
5. Touch one of the tabs in the left of the screen to select the desired editing screen.

6. In each screen, touch the touch panel to edit the parameters.

Move the cursor to the value box of the parameter you want to edit, and use any of the following methods to edit it.

- Turn the VALUE dial
- Press [INC/+] or [DEC/-]
- Drag your fingertip on the touch panel

7. Repeat steps 4–6 to edit the patch common parameters.

NOTE Changes you make by editing the patch common parameters are temporary, and will be lost if you turn off the power. If you want to keep the changes you made, you must save them to the V-Synth GT's internal memory (p. 58).

Common (Settings Used by the Entire System)

General



In this screen you can turn the upper/lower tones on/off, change each tone, and adjust the level and pan.

Parameter	Value	Description
Patch Level	0–127	Specifies the volume of the patch.
Patch Coarse Tune	-48– +48	Adjusts the pitch of the patch's sound up or down in semitone steps (+/-4 octaves).
Lower Level	0–127	Specifies the volume of the lower tone.
Lower Pan	L64–0–63R	Specifies the panning of the lower tone. "L64" is far left, "0" is center, and "63R" is far right.
Upper Level	0–127	Specifies the volume of the upper tone.
Upper Pan	L64–0–63R	Specifies the panning of the upper tone. "L64" is far left, "0" is center, and "63R" is far right.

Time Trip Pad



Parameter	Value	Description
Pad Mode (Time Trip Pad Mode)	Time Trip	Applies the Time Trip effect (p. 46).
	Assignable	Applies the effect that is specified by each tone.
Hold Switch (Time Trip Pad Hold Switch)	OFF, ON	Specifies whether the current value will be maintained (ON) when you remove your finger from the Time Trip pad, or not maintained (OFF).

cf. ➤ For details on settings for the Time Trip effect, refer to “**Matrix Control**” (p. 91) and “**Time Trip Pad**” (p. 204).

D Beam



Parameter	Value	Description
D Beam (D Beam Mode)	OFF	The D Beam controller will not be used.
	Time Trip	The D Beam controller will control the Time Trip effect (p. 46).
	Time	The D Beam controller will control the Time Control effect.
	Pitch	The D Beam controller will control the Pitch Control effect.
	Assignable	The D Beam controller will control the effect specified for each tone. <div style="text-align: center;">  </div> For details on how to specify the effect that will be controlled when "Assignable" is selected, refer to "Matrix Control" (p. 91).

S1/S2 Switch



Parameter	Value	Description
S1/S2 Switch Setting	Latch	The on/off status will alternate each time you press [S1] [S2].
	Momentary	The status will be on only while you hold down [S1] [S2].

Key Range

Here you can specify the zones of the keyboard in which the upper and lower tones are to be sounded.

You can also specify how the two tones will be played.

You can access this screen not only from the Patch Common screen, but also directly by touching <Key Range> in the Patch Menu.

From this screen you can turn the lower and upper tones on/off and make other changes for the tones.

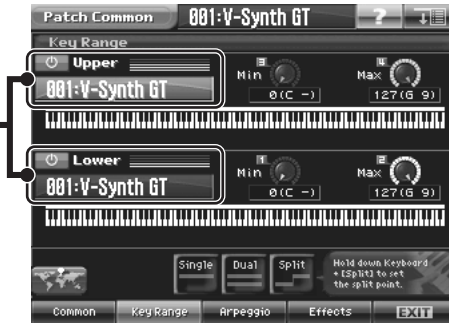

Parameter	Value	Description
Key Range Upper/Lower		
Min	C-1-G9	Specify the lowest keys of the ranges within which the upper tone or lower tone will be sounded.
Max	C-1-G9	Specify the highest keys of the ranges within which the upper tone or lower tone will be sounded.
Single Sw (Single Switch)		Only the upper tone will play across the entire keyboard.
Dual Sw (Dual Switch)		The upper tone and lower tone will both play across the entire keyboard.
Split Sw (Split Switch)		The upper tone and lower tone will be split and will sound in separate zones of the keyboard. If you hold down a note of the keyboard and touch Split Sw, the keyboard will be split at that note. If you touch Split Sw without holding down a note, the keyboard will be split at C4.

Arpeggio

In addition to accessing this screen from the Patch Common screen, you can access it directly by touching <Arpeggio> in the Patch Menu.



Parameter	Value	Description
Arpeggio Switch	OFF, ON	Switches the Arpeggiator on/off.
Patch Tempo	20.0–250.0	Specifies the tempo of an arpeggio. When Clock Source parameter (p. 198) is set to "INTERNAL," this setting value is effective.
Hold (Arpeggio Hold Switch)	OFF, ON	Switches between Hold On/Hold Off for the Arpeggiator performance.
Destination	Lower Upper Upper & Lower	Arpeggios will be played only for the lower tone. Arpeggios will be played only for the upper tone. Arpeggios will be played for both the upper and lower tones.
Motif (Arpeggio Motif)	UP DOWN UP&DOWN RANDOM NOTE ORDER RHYTHM PHRASE AUTO	Notes you press will be sounded, beginning from low to high. Notes you press will be sounded, from high to low. Notes you press will be sounded, from low to high, and then back down from high to low. Notes you press will be sounded, in random order. Notes you press will be sounded in the order in which you pressed them. By pressing the notes in the appropriate order you can produce melody lines. Up to 128 notes will be remembered. Unlike a conventional arpeggio, the notes that you specified when inputting the pattern will always sound. The keys that you press while performing will not affect the result; the specified pattern will play regardless of the pitch of the keys you play. Pressing a single key will sound the phrase based on the pitch of that key. If multiple keys are pressed, the last-pressed key will be valid. The timing at which the keys are sounded is assigned automatically, starting at the lowest key that you pressed.
Pattern Edit		Press this when you want to create an original arpeggio pattern.  For details on creating an arpeggio pattern, refer to "Arpeggio Pattern Edit (Creating an Original Arpeggio Pattern)" (p. 71).

Patch Mode (Editing a Patch)

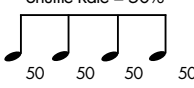
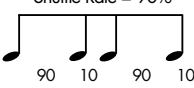
Parameter	Value	Description
Shuffle Rate (Arpeggio Shuffle Rate)	0–100%	<p>This setting lets you modify the note timing to create shuffle rhythms. With a setting of “50%” the notes will be spaced evenly. As the value is increased, the note timing will have more of a “dotted” (shuffle) feel.</p> <div style="display: flex; justify-content: space-around; align-items: center;"> <div style="text-align: center;"> <p>Shuffle Rate = 50%</p>  </div> <div style="text-align: center;"> <p>Shuffle Rate = 90%</p>  </div> </div>
Shuffle Resolution (Arpeggio Shuffle Resolution)	16TH, 8TH	Specifies the timing resolution in terms of a note value. The note value can be specified as either an 16th note or a eighth note.
Octave Range (Arpeggio Octave Range)	-3– +3	Sets the key range in octaves over which arpeggio will take place. If you want the arpeggio to sound using only the notes that you actually play, set this parameter to “0.” To have the arpeggio sound using the notes you play and notes 1 octave higher, set this parameter to “+1.” A setting of “-1” will make the arpeggio sound using the notes you play and notes 1 octave lower.
Keyboard Velocity (Arpeggio Keyboard Velocity)	REAL, 1–127	Specifies the loudness of the notes that you play. If you want the velocity value of each note to depend on how strongly you play the keyboard, set this parameter to “REAL.” If you want each note to have a fixed velocity regardless of how strongly you play the keyboard, set this parameter to the desired value (1–127).
Arpeggio Duration	0–100%	Modifies the length of the notes.

Arpeggio Pattern Edit (Creating an Original Arpeggio Pattern)

You can create your own arpeggio pattern that specifies how an arpeggio will be sounded. This gives you even more interesting ways to use arpeggios.

An arpeggio pattern is a set of data that can be up to 32 steps (horizontally) x 16 lines (vertically).



An arpeggio pattern can be saved for an individual patch as part of the patch settings. This means that you can create a patch designed specifically for that arpeggio pattern.

About the Pattern Edit Window

1. Access the Arpeggio screen (p. 69).
2. Touch <Edit>.



The Pattern Edit window will appear.

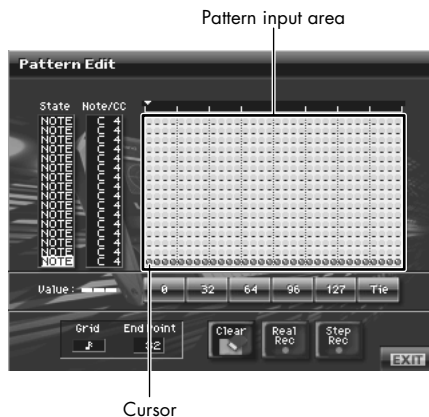

State	Specifies the status of each line. NOTE: Note pitch CTRL: Control change
Note/CC (Note/Control Change)	Specifies the note number or control change number assigned to each line. If Status is "NOTE," this will be a note number (C-1-G9). If Status is "CTRL," this will be a control change number (0-127).

Patch Mode (Editing a Patch)

Pattern Input Area	This area is where you input or edit notes or control changes. The symbols have the following meaning: ●: Note =: Tie ○: Control change
Value	Shows the velocity of the note or the value of the control change selected in the pattern input area.
0, 32, 64, 96, 127, Tie/Clr	<p>When inputting notes: When you touch one of these buttons, a note with the velocity shown on that button will be input at the cursor location within the pattern input area. When you touch <Tie>, a tie will be input at the cursor location.</p> <p>When inputting control changes: A control change with the value shown on that button will be input at the cursor location within the pattern input area. When you touch <Clr>, the selected control change will be erased.</p> <p>When you are editing, these buttons modify the velocity of the note that is selected in the pattern input area, or the value of the control change.</p> <p>TIP You can also input the note velocity or control change value by using the VALUE dial or [INC/+] [DEC/-].</p>
Grid	Specifies the note value that will correspond to “one step” of the arpeggio pattern. ♩ (Quarter note), ♪ (Eighth note), ♪. (Dotted eighth note), ♩ (Sixteenth note), ♪. (Dotted sixteenth note), ♪ (Thirty-second note)
End Point	Specifies the pattern length as a number of steps (1–32).
Clear	Erases the pattern data (p. 75).
Real Rec (Realtime Recording)	Uses realtime recording to create a pattern (p. 73).
Step Rec (Step Recording)	Uses step recording to create a pattern (p. 74).

Creating a Pattern by Playing in Real Time (Real Rec)

This method lets you create a pattern in a way similar to realtime recording on a sequencer. Your playing on the V-Synth GT's keyboard and your controller operations will be recorded "as is."

1. Specify the Grid and End Point of the arpeggio pattern that you will be creating.

Move the cursor to each value box and set the value.

2. Touch <Real Rec>.

The V-Synth GT will be in realtime-input standby mode, and the metronome will sound a guide rhythm.

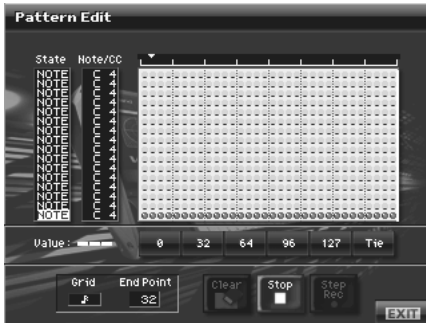

3. If you want to adjust the tempo, turn ARPEGGIO [TEMPO].

Turn the knob toward the right to make the tempo faster, or toward the left to make it slower.

4. In time with the guide rhythm sounded by the metronome, play the V-Synth GT's keyboard and operate the controllers.

You can repeatedly record over the pattern length (number of steps) you specified in step 1. On each pass, you can add new notes and control changes to build up the pattern.

NOTE The notes (specified pitches) and control changes in a single pattern cannot exceed a total of 16. All further (seventeenth and later) notes having a new pitch or control changes will not be recorded.

5. When you are finished with realtime input, touch <Stop>.

The metronome guide will stop sounding.

6. Press ARPEGGIO [ON/OFF] to turn on the arpeggiator, and play the keyboard to hear your realtime-recorded pattern.

Creating a Pattern by Inputting One Step at a Time (Step Rec)

This method lets you create a pattern in a way similar to step-recording on a sequencer. You can record notes and control changes by inputting them one by one.

1. Specify the End Point of the arpeggio pattern that you want to create.

Move the cursor to the End Point value box and make the setting.

2. Touch <Step Rec>.

The V-Synth GT will be in step-input standby mode.

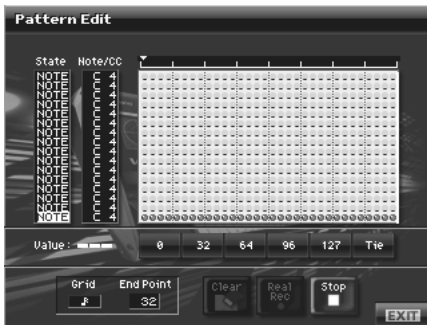

3. Play the V-Synth GT's keyboard or operate a controller to input the first step.

You can repeatedly record over the pattern length (number of steps) you specified in step 1. On each pass, you can add new notes and control changes to build up the pattern.

- TIP**
- To input a tie, hold down the key of the note that you want to tie and press [►]. You will advance as many steps as the number of times you press [►].
 - Step input records the strength (velocity) with which you press the key, and this will be reflected in the level or dynamics of the arpeggiated notes.
 - Control changes will be input with the value that was in effect when you pressed [►].

- NOTE**
- The notes (specified pitches) and control changes in a single pattern cannot exceed a total maximum of 16. A newly pitched note or a control change that would exceed this total will not be recorded.
 - Be aware that if you input another note while still holding down the key for the previously input note, these notes will be input as a chord located at the same step.

4. When you are finished with step input, touch <Stop>.

5. Press ARPEGGIO [ON/OFF] to turn on the arpeggiator, and play the keyboard to hear your step-recorded pattern.

Erasing a Pattern (Clear)

Here's how to erase data from the pattern. You can erase a specific line or the entire pattern.

1. To specify a line that you want to erase, move the cursor to that line.
2. Touch <Clear>.

A window like the following will appear.



3. To erase a line of data, touch <LINE CLEAR>. To erase the entire pattern, touch <ALL CLEAR>. If you decide you don't want to clear anything, touch <CANCEL>.

Effects (Setting Effects for a Patch)

The V-Synth GT provides three high-quality effects: Tone-FX (tone effect), Chorus, and Reverb. The tone effect can be applied to each tone individually, and the amount of signal sent to chorus and to reverb can be specified individually for each tone.

You can also access the effects screen by touching <Effect> in the Patch Menu, as well as from the Patch Common screen.

Routing

Each effect block is displayed as if it were a small rack-mounted unit. You can turn each effect on/off to freely specify the connection path (signal routing).

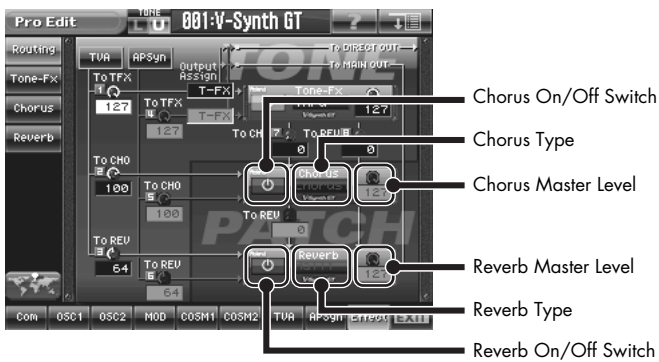

Parameter	Value	Description
TVA Tone-FX Send (TVA Tone-FX Send Level)	0-127	These parameters can be set for each tone. For details, refer to "Tone-FX (Tone Effect)" (p. 139).
TVA CHO Send (TVA Chorus Send Level)	0-127	
TVA REV Send (TVA Reverb Send Level)	0-127	
TVA Output Assign	T-FX MAIN DIR	
AP Syn Tone-FX Send (AP Syn Tone-FX Send Level)	0-127	
AP Syn CHO Send (AP Syn Chorus Send Level)	0-127	
AP Syn REV Send (AP Syn Reverb Send Level)	0-127	
AP Syn Output Assign	T-FX MAIN DIR	
Tone-FX (Tone-FX On/Off Switch)	OFF, ON	
Tone-FX Type	00 (Thru)-41	
Tone-FX Master Level	0-127	
Tone-FX To CHO (Tone-FX Chorus Send Level)	0-127	
Tone FX-To REV (Tone-FX Reverb Send Level)	0-127	
CHO (Chorus On/Off Switch)	OFF, ON	
CHO Type (Chorus Type)	00 (Off)-08	Touching this will take you to the Chorus screen (p. 78), where you can choose one of eight types of chorus. For details on each type of chorus, refer to "COSM_EffectsList(E).pdf" in the "EFFECTS LIST" folder on the included CD-ROM.
CHO Master Level (Chorus Master Level)	0-127	Adjusts the volume of the sound that has passed through chorus.
CHO To REV (Chorus Reverb Send Level)	0-127	Adjusts the amount of reverb for the sound that passes through chorus. If you don't want to add the Reverb effect, set it to "0."
REV (Reverb On/Off Switch)	OFF, ON	Switches reverb on and off.
REV Type (Reverb Type)	00 (Off)-13	Touching this will take you to the Reverb screen (p. 79), where you can choose one of 13 types of reverb. For details on each type of reverb, refer to "COSM_EffectsList(E).pdf" in the "EFFECTS LIST" folder on the included CD-ROM.
REV Master Level (Reverb Master Level)	0-127	Adjusts the volume of the sound that has passed through reverb.

Tone-FX

This is an effect that can be applied to each tone individually.
For details, refer to **"Tone-FX (Tone Effect)"** (p. 139).

Chorus

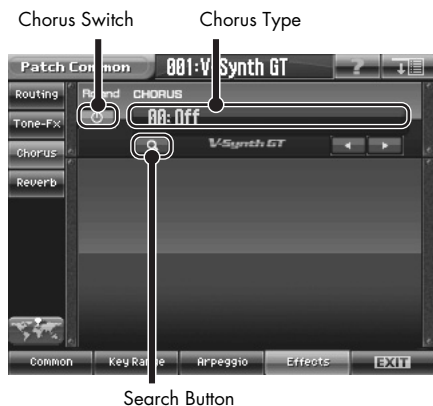

Parameter	Value	Description
Chorus Switch	OFF, ON	Switches the Chorus on/off.
CHO Type (Chorus Type)	00 (Off)–08	<p>You can choose one of eight types of chorus. In this editing screen you can select the chorus type and edit the parameters for that type. For details on each type of chorus, refer to "COSM_EffectsList(E).pdf" in the "EFFECTS LIST" folder on the included CD-ROM.</p> <p>MEMO</p> <p>When you touch <Search>, the Chorus Type List window will appear, allowing you to select the chorus from the list.</p>

Reverb

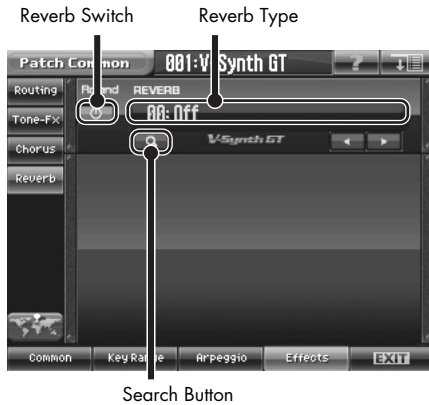

Parameter	Value	Description
Reverb Switch	OFF, ON	Switches the Reverb on/off.
REV Type (Reverb Type)	00 (Off)-13	<p>You can choose one of 13 types of reverb. In this editing screen you can select the reverb type and edit the parameters for that type. For details on each type of reverb, refer to "COSM_EffectsList(E).pdf" in the "EFFECTS LIST" folder on the included CD-ROM.</p> <p>MEMO</p> <p>When you touch <Search>, the Reverb Type List window will appear, allowing you to select the reverb from the list.</p>

Patch Mode (Editing a Tone)

A patch consists of a combination of two tones. This chapter will explain how to edit these tones, and what the tone parameters do.

Creating a Tone

Broadly speaking, there are two ways to create a tone.

Using a template to create a patch intuitively (Sound Shaper II)

By using the Sound Shaper II function, you can select a group and template that is close to the sound you want, and then simply turn the knobs to edit the important aspects of the sound, just like a professional sound designer (p. 158).

Creating a patch from scratch (Pro Edit)

Based on the tones the V-Synth GT provides, you can combine eight elements (sections) and edit the parameters of each section to create new sounds (p. 85).

Four Tips for Editing Tones

- **Select a tone that is similar to the sound you wish to create.**

It's hard to create a new sound that's exactly what you want if you just select a tone and modify its parameters at random. It makes sense to start with a tone whose sound is related to what you have in mind.

- **Check the Structure setting.**

The structure type is an important parameter which determines how the eight sections are combined. Before you actually begin editing, you should understand how the sections are related to each other (p. 28).

- **Decide which section(s) you will use.**

When creating a tone, it is very important to decide which section(s) you will use. In the Edit screen of each section, use the on/off switch to specify whether that section will be used (on) or not used (off). You can also use the on/off buttons located in the STRUCTURE section of the V-Synth GT's panel.

- **Turn Effects off.**

Since the V-Synth GT effects have such a profound impact on its sounds, turn them off to listen to the sound itself so you can better evaluate the changes you're making. Since you will hear the original sound of the tone itself when the effects are turned off, the results of your modifications will be easier to hear. Actually, sometimes just changing effects settings can give you the sound you want.

1. **Access the Patch Play screen, and select the tone whose settings you wish to modify (p. 55).**



If you want to create all your tones from the ground up, rather than the tones that have already been prepared, carry out the Initialize operation (p. 84).

2. **Use Sound Shaper II (p. 158) or ProEdit (p. 85) to edit the tone.**

3. **Apply a tone effect (p. 139).**

4. **Save the tone (p. 81).**



When you save the tone, any data previously stored at the save destination will be overwritten and lost.

Tone Menu

Tone Write (Saving Tones)

Changes you make to sound settings are temporary, and will be lost if you turn off the power or select another sound. If you want to keep the modified sound, you must save it in the internal (internal memory). When you modify the settings of a tone, the Patch Play screen will indicate “*.” Once you save the patch into internal memory, the “*” indication goes away.

NOTE When you perform the save procedure, the data that previously occupied the save destination will be lost. However, the factory setting data can be recovered by performing the Factory Reset (p. 235).

1. Make sure that the tone you wish to save is selected.
2. Touch <MENU> in the upper right of the screen.
A pulldown menu appears.



3. In the pulldown menu, touch <Tone Write>.
The Tone Write window appears.



4. Turn the VALUE dial to specify the save-destination tone.
 - When you touch <Search>, the Tone Write Number List window will appear, allowing you to select the save-destination tone from the list.
5. Touch <OK> to execute the Save operation.

Tone Name (Naming a Tone)

Before you save the tone, here's how to give it a new name. You can assign a name of up to twelve characters to a tone.

1. **Make sure that the tone that you want to name is selected.**
2. **Touch <MENU> in the upper right of the screen.**
A pulldown menu appears.



3. **In the pulldown menu, touch <Tone Name>.**
The Tone Name window appears.



4. **Touch the on-screen alphabetic or numeric keys to enter the new name in the text box.**
The on-screen keys have the following functions.

< << >> >	Move the cursor in the text box to the desired input location.
<shift>	Turn this on when you want to input uppercase letters or symbols.
<clear all>	Erases all characters in the text box.
<back space>	Deletes the character that precedes the cursor location.
<delete>	Deletes the character at the cursor location.

5. **When you have finished inputting, touch <OK> to finalize the tone name.**
If you want to return to the original unedited name, touch <EXIT>.

- * You will lose your edited tone settings if you switch to another tone or turn off the power. If you want to keep a tone whose settings you have edited, then perform the Save operation (p. 81).
- * You can also assign a category to the tone (p. 83).

Tone Category (Assigning the Category of a Tone)

If you assign a category to your tones, you'll be able to search for them by category in the Tone List window.

MEMO If no category is assigned to a tone, its category name will be "No Assign."

1. Make sure that the tone that you want to category is selected.
2. Touch <MENU> in the upper right of the screen.
A pulldown menu appears.
3. In the pulldown menu, touch <Tone Category>.
The Tone Category window appears.



4. Select a category from the list.

Tone Category List

Category	Contents
No Assign	No Assign
Synth	Synth
Lead	Lead
Pad, Strings	Pad/Strings
Vox, Choir	Voice/Choir
Piano, Keyboards	Piano/Keyboards
Bass, Guitar	Bass/Guitar
Winds	Winds
Bell, Mallet, Hit	Bell/Mallet/Hit
Melodic Sequence	Melodic (i.e., pitched) sequences
Rhythmic Sequence	Rhythmic (i.e., non-pitched) sequences
Arpeggio	Arpeggio
FX, Noise, Ambient	Effect/Noise/Ambient
Ethnic	Ethnic
Drum, Perc	Drum/Percussion
Combination, Others	Combinations using zones (p. 88)/other

5. Touch <OK> to finalize the category.

* You will lose your edited tone settings if you switch to another tone or turn off the power. If you want to keep a tone whose settings you have edited, then perform the Save operation (p. 81).

Tone Init (Initializing the Tone Settings)

“Initialize” means to return the settings of the currently selected tone to a standard set of values.

NOTE The Initialize operation will affect only the currently selected tone; the tones that are stored in internal memory and temporary area will not be affected. If you wish to restore all of the V-Synth GT's settings to their factory values, perform a Factory Reset (p. 235).

1. Select the tone that you wish to initialize.
2. Touch <MENU> in the upper right of the screen.
A pulldown menu appears.



3. In the pulldown menu, touch <Tone Init>.
A window like the following appears.



4. Touch <OK>.
The initialization will be carried out.

Editing a Tone (Pro Edit)

“Pro Edit” lets you individually edit all of a tone’s parameters, allowing you to perform detailed and professional tone editing.

1. In the Patch Play screen, select the tone that you want to edit.



2. Touch <PRO EDIT>.

The Pro Edit window will appear.

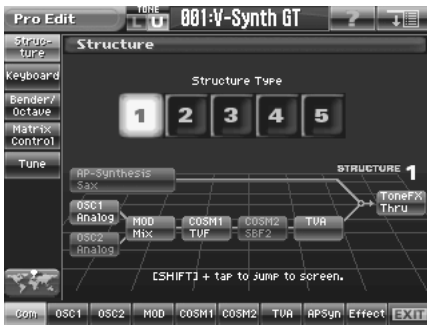

After you’ve selected a structure, edit the parameters of each section to create the sound.

3. Save the tone you’ve created. (p. 81)

Com (Settings Common to the Entire Tone)

Structure

Select the type of structure.



The icons that indicate each section show the parameter that is selected for each. You can turn each section on/off by pressing the V-Synth GT's buttons or by touching these icons. By holding down [SHIFT] and touching an icon, you can jump directly to the editing screen for that parameter.

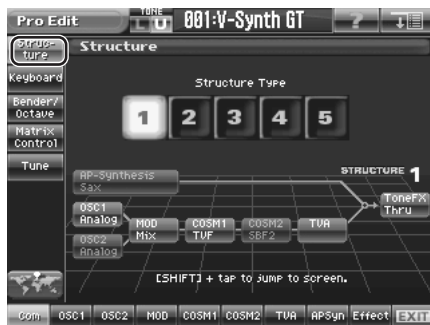

Parameter	Value	Description
Structure Type	1	This is the most conventional structure. Different sounds from OSC1 and OSC2 are mixed by MOD, processed by COSM1 to create the tonal character (e.g., using SBF (Side Band Filter)), and then processed by COSM2 to adjust the tone (e.g., using TVF). The sound of the V-Synth GT's new AP-Synthesis function can be mixed into the final result.
	2	This structure connects OSC1 and OSC2 asymmetrically. This is effective when using a modulation that has the modulator set to anything other than "MIX." Typically, you will use OSC1 and COSM1 to create the basic sound, then select the OSC2 sound and MOD settings to add variation, and finally select TVF in COSM2 to adjust the tone. The sound of the V-Synth GT's new AP-Synthesis function can be mixed into the final result.
	3	In this structure, OSC1 is paired with COSM1, and OSC2 is paired with COSM2. You can use a controller such as the Time Trip Pad to morph between the sound created by OSC1 and COSM1 and the sound created by OSC2 and COSM2. The sound of the V-Synth GT's new AP-Synthesis function can be mixed into the final result.
	4	Unlike types 1–3, this lets you apply effects such as MOD to AP-Synthesis sounds as well. MEMO If you want to apply an effect such as MOD to the sound of AP-Synthesis, turn the OSC2 switch ON.
	5	If you select this structure, you'll be able to perform using Vocal Designer. For details on using Vocal Designer, refer to "Vocal Designer" (p. 146). The sound of the V-Synth GT's new AP-Synthesis function can be mixed into the final result.

Keyboard



Parameter	Value	Description
Keyboard		
Mono/Poly	Mono (Monophonic)	Only the last-played note will sound. The monophonic setting is effective when playing a solo instrument patch such as sax or flute.
	Poly (Polyphonic)	Two or more notes can be played simultaneously.
Legato (Legato Switch)	OFF, ON	Legato is valid when the Mono/Poly parameter is set to monophonic. This setting specifies whether the Legato function will be used (ON) or not (OFF). TIP With the Legato Switch parameter "ON," pressing a key while continuing to press a previous key causes the note to change pitch to the pitch of the most recently pressed key, sounding all the while. This creates a smooth transition between notes, which is effective when you wish to simulate the hammering-on and pulling-off techniques used by a guitarist.
Portamento		
Portamento (Portamento Switch)	OFF, ON	Specifies whether the portamento effect will be applied (ON) or not (OFF). TIP
Mode (Portamento Mode)	NORMAL	Portamento will always be applied.
	LEGATO	Portamento will be applied only when you play legato (i.e., when you press the next key before releasing the previous key).
Type (Portamento Type)	RATE	The time it takes will depend on the distance between the two pitches.
	TIME	The time it takes will be constant, regardless of how far apart in pitch the notes are.
Time (Portamento Time)	0-127	When portamento is used, this specifies the time over which the pitch will change. Higher settings will cause the pitch change to the next note to take more time.
Time Velo Sens (Portamento Time Velocity Sensitivity)	-63- +63	This allows keyboard dynamics to affect the portamento Time. If you want portamento Time to be speeded up for strongly played notes, set this parameter to a positive (+) value. If you want it to be slowed down, set this to a negative (-) value.
Zone		Refer to "Zone Settings (Zone)" (p. 88)

NOTE Mono/Poly, Legato, and Portamento have no effect on AP-Synthesis.

Zone Settings (Zone)

On the V-Synth GT, the keyboard range is divided into up to 16 areas for each tone, allowing a different sound to be played in each area. Each of these areas in the keyboard range is called a "zone."

MEMO

The following tone settings are applied in common to each of the individual sounds that are divided by zone.

- Common group settings (except for Structure Type)
- Effect group settings for the Tone-FX type, and effect settings

NOTE

You can select a different structure for each zone, but if you select structure 5, all zones will be set to structure 5.

NOTE

AP-Synthesis does not support Zones.

Splitting the Keyboard to Play Different Sounds (Split)

A patch that contains settings to play different patches in each keyboard zone is called a **split tone**. Here's how to create a split tone.

1. In the Zone area of the Keyboard screen (p. 87), touch <Edit>.

The Tone Zone window appears.

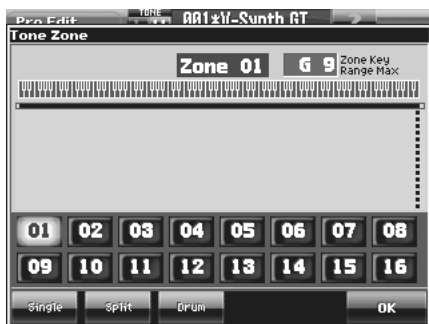

2. In the lower part of the screen, touch <Split>.

A window like the following appears.

Range of notes that will sound for the specified zone



Zone number

3. Touch <01>.

Zone 01 will be selected, and the top note number of zone 01 will be displayed in the upper right of the screen.

4. Specify the split point between zones 01 and 02. Either turn the VALUE dial or use [INC/+] [DEC/-] to specify the note number.



If you want to divide the keyboard into three zones, lower the top note of zone 02, and specify the split point between zones 02 and 03. By lowering the top note of the highest zone in this way, you can add more zones. You can specify a maximum of sixteen zones.

5. Touch <OK>.

The zones will be established, and you will return to the Pro Edit screen.

6. In this state, zone 01 is selected. Specify the sound that you want to play in zone 01.

7. After you have specified the sound that you want to play in zone 01, next specify the sound for zone 02.

8. Specify the sound that you want to play in zone 02.

In this way you can create a patch that plays different sounds on either side of the split point you specified in step 4.



Each zone works just like a single tone. You can create the sound for a zone from scratch in the same way as for a tone, as described in the procedure "Editing a Tone (Pro Edit)" (p. 85).

9. To save the patch you created, perform the Write operation (p. 81).

Editing a Tone (Pro Edit)

Com

OSC1/2

MOD

COSM1/2

TVA

AP Syn

Effects

Bender/Octave



Parameter	Value	Description
Bender		
Pitch Bend Range Down	0–48	Specifies the degree of pitch change in semitones when the Pitch Bend lever is all the way left. For example if this is set to “48” and you move the pitch bend lever all the way to the left, the pitch will fall 4 octaves.
Pitch Bend Range Up	0–48	Specifies the degree of pitch change in semitones when the Pitch Bend lever is all the way right. For example, if this parameter is set to “12,” the pitch will rise one octave when the pitch bend lever is moved to the right-most position.
Octave Shift		
Octave Shift	-3– +3	Adjusts the pitch of the tone’s sound up or down in units of an octave (+/-3 octaves).

Matrix Control

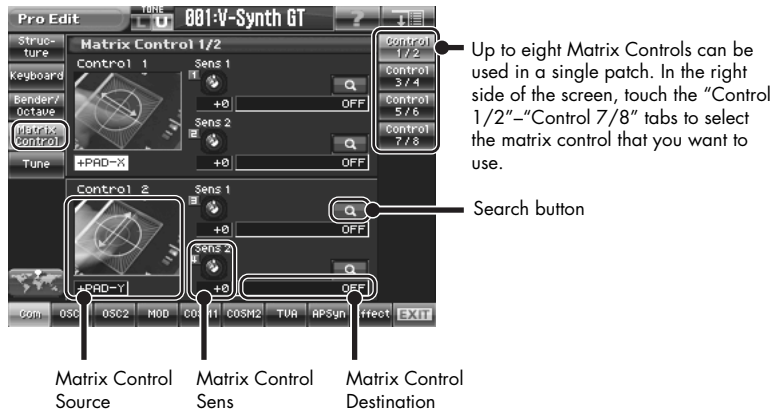

Matrix Control

Ordinarily, if you wanted to change tone parameters using an external MIDI device, you would need to send System Exclusive messages—MIDI messages designed exclusively for the V-Synth GT. However, System Exclusive messages tend to be complicated, and the amount of data that needs to be transmitted can get quite large.

For that reason, a number of the more typical of the V-Synth GT's tone parameters have been designed so they accept the use of Control Change (or other) MIDI messages for the purpose of making changes in their values. This provides you with a variety of means of changing the way tones are played. For example, you can use the Pitch Bend lever to change the LFO cycle rate, or use the keyboard's touch to open and close a filter.

The function which allows you use MIDI messages to make these changes in realtime to the tone parameters is called the Matrix Control.

To use the Matrix Control, specify which MIDI message (Source parameter) will be used to control which parameter (Destination parameter), and how greatly (Sens parameter).

Parameter	Value	Description
Source 1, 2 (Matrix Control Source 1, 2) Sets the MIDI message used to change the patch parameter with the Matrix Control.	OFF	Matrix control will not be used.
	CC01–31, 33–95	Controller numbers 1–31, 33–95
	BEND	Pitch Bend
	AFT	Aftertouch
	+PAD-X	Time Trip pad (horizontal direction from the center)
	+PAD-Y	Time Trip pad (vertical direction from the center)
	PAD-X	Time Trip pad (horizontal direction)
	PAD-Y	Time Trip pad (vertical direction)
	TRIP-R	Time Trip pad (center from the circumference)
	BEAM-L	D Beam controller (left)
	BEAM-R	D Beam controller (right)
	KNOB1	Assignable Controller ([C1])
	KNOB2	Assignable Controller ([C2])
	VELO	Velocity (pressure you press a key with)
KEYF	Note Number	
Sens 1, 2 (Matrix Control Sens 1, 2)	-63– +63	Sets the amount of the Matrix Control's effect that is applied. If you wish to modify the selected parameter in a positive (+) direction – i.e., a higher value, toward the right, or faster etc. – from its current setting, select a positive (+) value. If you wish to modify the selected parameter in a negative (-) direction – i.e., a lower value, toward the left, or slower etc. – from its current setting, select a negative (-) value. When both positive and negative are selected, the changes are greater as the value increases. Set it to "0" if you don't want this effect.
Destination 1, 2 (Matrix Control Destination 1, 2) Specifies the parameters that will be controlled by the matrix controllers. When not controlling parameters with the Matrix Control, set this to "OFF." Up to two parameters can be specified for each Matrix Control, and controlled simultaneously. For details on each parameter, refer to the corresponding reference page.	OSC1/2-PITCH	Oscillator Pitch (p. 97, p. 99, p. 102)
	OSC1/2-TIME/PW	Time/Pulse Width (p. 97, p. 103)
	OSC1/2-FORMA/FAT	Formant/Fat (p. 97, p. 100, p. 104, p. 112)
	OSC1/2-LVL	Level (p. 113)
	OSC1/2-PENV-ATK	Pitch Envelope Attack Time (p. 121)
	OSC1/2-PENV-DCY	Pitch Envelope Decay Time (p. 121)
	OSC1/2-PENV-REL	Pitch Envelope Release Time (p. 121)
	OSC1/2-TENV-ATK	Time Envelope Attack Time (p. 121)
	OSC1/2-TENV-DCY	Time Envelope Decay Time (p. 121)
	OSC1/2-TENV-REL	Time Envelope Release Time (p. 121)
	OSC1/2-FENV-ATK	Formant Envelope Attack Time (p. 121)
	OSC1/2-FENV-DCY	Formant Envelope Decay Time (p. 121)
	OSC1/2-FENV-REL	Formant Envelope Release Time (p. 121)
	OSC1/2-AENV-ATK	Oscillator TVA Envelope Attack Time (p. 121)
	OSC1/2-AENV-DCY	Oscillator TVA Envelope Decay Time (p. 121)
	OSC1/2-AENV-REL	Oscillator TVA Envelope Release Time (p. 121)
	OSC1/2-LFO-RATE	Oscillator LFO Rate (p. 122)
	OSC1/2-LFO-PCH	Oscillator Pitch LFO Depth (p. 102)
	OSC1/2-LFO-TM/PW	Time/Pulse Width LFO Depth (p. 103)
	OSC1/2-LFO-FR/FT	Formant/Fat LFO Depth (p. 104, p. 112)
	OSC1/2-LFO-LVL	Oscillator Level LFO Depth (p. 113)
	CSM1/2-PRM1	Refer to "COSM_EffectsList(E).pdf" in the "EFFECTS LIST" folder on the included CD-ROM.
	CSM1/2-PRM2	Refer to "COSM_EffectsList(E).pdf" in the "EFFECTS LIST" folder on the included CD-ROM.
	CSM1/2-ENV1-ATK	COSM Envelope Attack Time (p. 121)
	CSM1/2-ENV1-DCY	COSM Envelope Decay Time (p. 121)
	CSM1/2-ENV1-REL	COSM Envelope Release Time (p. 121)

Parameter	Value	Description
	CSM1/2-ENV2-ATK	COSM Envelope Attack Time (p. 121)
	CSM1/2-ENV2-DCY	COSM Envelope Decay Time (p. 121)
	CSM1/2-ENV2-REL	COSM Envelope Release Time (p. 121)
	CSM1/2-LFO-RATE	COSM LFO Rate (p. 122)
	CSM1/2-LFO-PRM1	Refer to "COSM_EffectsList(E).pdf" in the "EFFECTS LIST" folder on the included CD-ROM.
	CSM1/2-LFO-PRM2	Refer to "COSM_EffectsList(E).pdf" in the "EFFECTS LIST" folder on the included CD-ROM.
	TVA-LVL	Level (p. 119)
	TVA-ENV-ATK	TVA Envelope Attack Time (p. 121)
	TVA-ENV-DCY	TVA Envelope Decay Time (p. 121)
	TVA-ENV-REL	TVA Envelope Release Time (p. 121)
	TVA-LFO-RATE	TVA LFO Rate (p. 122)
	TVA-LFO-LVL	Level LFO Depth (p. 119)
	TVA-LFO-PAN	Pan LFO Depth (p. 119)
	TONE-FX-SEND	Tone-FX Send Level (p. 139)
	CHO-SEND	Chorus Send Level (p. 139)
	REV-SEND	Reverb Send Level (p. 139)
	T-FX-PRM 1-3	Refer to "COSM_EffectsList(E).pdf" in the "EFFECTS LIST" folder on the included CD-ROM.
	TVA-PAN	Pan (p. 119)



When you touch <Search>, the Matrix Control Dest List window will appear, allowing you to select the Matrix Control Destination from the list.

Tune



Parameter	Value	Description
Tone Coarse Tune	-48– +48	Adjusts the pitch of the tone's sound up or down in semitone steps (+/-4 octaves).
Tone Fine Tune	-50– +50	Adjusts the pitch of the tone's sound up or down in 1-cent steps (+/-50 cents). MEMO One cent is 1/100th of a semitone.
Scale Tune (Tone Scale Tune Switch)	OFF, ON	Turn this on when you wish to use a tuning scale other than equal temperament. The V-Synth allows you to play the keyboard using temperaments other than equal temperament. The pitch is specified in one-cent units relative to the equal tempered pitch. MEMO One-cent is 1/100th of a semitone. MEMO The selected scale applies to MIDI messages received from an external MIDI device.
Scale Tune C-B (Tone Scale Tune C-B)	-100– +100	Makes scale tune settings.

MEMO

- Equal Temperament**
 This tuning divides the octave into 12 equal parts, and is the most widely used method of temperament used in Western music. The V-Synth employs equal temperament when the Scale Tune Switch is set to "OFF."
- Just Temperament (Tonic of C)**
 Compared with equal temperament, the principle triads sound pure in this tuning. However, this effect is achieved only in one key, and the triads will become ambiguous if you transpose.
- Arabian Scale**
 In this scale, E and B are a quarter note lower and C#, F# and G# are a quarter-note higher compared to equal temperament. The intervals between G and B, C and E, F and G#, Bb and C#, and Eb and F# have a natural third—the interval between a major third and a minor third. On the V-Synth, you can use Arabian temperament in the three keys of G, C and F.

<Example>

Note name	Equal temperament	Just Temperament (tonic C)	Arabian Scale
C	0	0	-6
C#	0	-8	+45
D	0	+4	-2
Eb	0	+16	-12
E	0	-14	-51
F	0	-2	-8
F#	0	-10	+43
G	0	+2	-4
G#	0	+14	+47
A	0	-16	0
Bb	0	+14	-10
B	0	-12	-49

OSC1/OSC2 (Oscillator 1/2)

The “**oscillator**” is the section that specifies the basic wave that the V-Synth GT will play, and modifies this wave in various ways. Each tone can contain up to two oscillators.

Parameter	Value	Description
Oscillator Switch	OFF, ON	Switches the oscillator on/off.

OSC Type

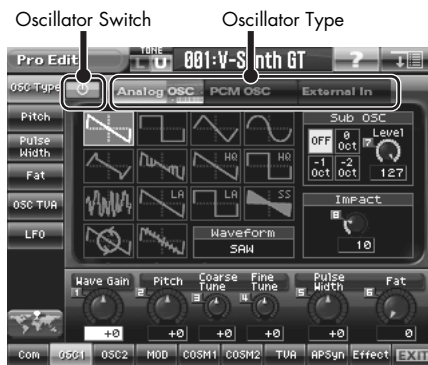

Parameter	Value	Description
Oscillator Type	Analog OSC	Analog Oscillator
	PCM OSC	PCM Oscillator
	External In	External Input Oscillator A signal applied to the rear panel's INPUT jacks can be used as an oscillator. This means that you can use the keyboard to play the signal that's being input from an external source. (You'll hear the sound only while you are playing the keyboard.)
	NOTE	You can't use an audio signal that's received via digital input (DIGITAL IN) (p. 200).

OSC Type (Analog OSC)



Parameter	Value	Description
Waveform (Analog Oscillator Waveform) Selects the wave upon which the sound is to be based when using an analog oscillator.	SAW: Sawtooth wave	This contains numerous harmonics. It can be used as the basis for most instrumental sounds. It is particularly suitable for brass instruments and string instruments (such as violin or piano).
	SQUARE: Square wave	This contains a rich array of odd-numbered harmonics. It is suitable as the basic sound material for woodwinds and percussion instruments (such as clarinet or xylophone).
	TRIANGLE: Triangle wave	This contains relatively fewer harmonics. It is suitable as the material for woodwind sounds (such as recorder or flute).
	SINE: Sine wave	This is the simplest waveform. It contains no harmonics at all, and sounds like whistling.
	RAMP: Ramp wave	This is a trapezoidal waveform that is similar to a pulse wave.
	JUNO: Modulated sawtooth wave	This is a modified sawtooth wave found on Roland's αJUNO synthesizer. It has a brighter sound than the conventional "SAW" waveform.
	HQ-SAW: High quality sawtooth wave	This is a high-quality sawtooth waveform that is free of the aliasing noise that can be a problem on digital synthesizers. If you select HQ-SAW, the Sub OSC, Pulse Width, and Fat parameters will be unavailable.
	HQ-SQUARE: High quality square wave	This is a high-quality square waveform that is free of the aliasing noise that can be a problem on digital synthesizers. If you select HQ-SQUARE, the Sub OSC and Fat parameters will be unavailable.
	NOISE: Noise wave	This is white noise. You can use it to create the noise component of a sound.
	LA-SAW: LA sawtooth wave	This simulates a waveform used in the LA (Linear Arithmetic) sound generator of the Roland D-50. It has a milder sound than the conventional "SAW" waveform.
	LA-SQUARE: LA square wave	This simulates a waveform used in the LA (Linear Arithmetic) sound generator of the Roland D-50. It has a milder sound than the conventional "SQUARE" waveform.
	SUPER-SAW: Super Saw	This is an intensified simulation of a feature found on the Roland JP-8000/JP-8080. It is the sound of seven sawtooth waves played simultaneously. A pitch-shifted sound is added to the center. This is suitable for creating rich sounds such as string-type sounds.
	FBACK-OSC: Feedback Oscillator	This is an intensified simulation of a feature found on the Roland JP-8000/JP-8080. It is a sound that simulates guitar feedback. It is suitable for creating sharply aggressive sounds.
X-MOD-OSC: Cross Modulation Oscillator	This is an intensified simulation of a feature found on the Roland JP-8000/JP-8080. It uses the OSC2 waveform to modulate the frequency of OSC1.	

Parameter	Value	Description
Sub OSC Octave Select (Sub Oscillator Octave Select)	OFF	The sub-oscillator will not be used.
	-2	The sub-oscillator will be added two octaves below the basic pitch.
	-1	The sub-oscillator will be added one octave below the basic pitch.
	0	The sub-oscillator will be added at the same pitch as the basic pitch.
Sub Level (Sub Oscillator Level)	0-127	Specifies the volume of the sub oscillator.
Impact (Analog Oscillator Impact)	0.0-4.0	Specifies the sharpness of the attack of the analog oscillator. Higher settings will produce a sharper attack.
Wave Gain	-12- +12 dB	Sets the gain (amplification) of the waveform.
Pitch (Oscillator Pitch)	-63- +63	Adjusts the pitch of the oscillator.
Coarse Tune (Oscillator Coarse Tune)	-48- +48	Adjusts the pitch of the oscillator up or down in semitone steps (+/-4 octaves).
Fine Tune (Oscillator Fine Tune)	-50- +50	Adjusts the pitch of the oscillator up or down in 1-cent steps (+/-50 cents). MEMO One cent is 1/100th of a semitone.

Depending on the waveform you're using, the assignment of knobs 5 and 6 will change as follows.

Parameter	Value	Description
If Sub OSC is 0, -1, or -2		
Pulse Width	-63- +63	Specifies the amount by which the wave shape will be modified.
Detune	-63- +63	Specifies the detuning (pitch difference) of the sub-oscillator.
If the Waveform is SUPER-SAW		
SS Detune	-63- +63	Adjusts the detune (pitch difference) for the super-saw.
Mix	-63- +63	Adjusts the volume of the detuned sounds relative to the central sound. As the knob is rotated to the right, the detuned sounds will become louder, making the sound thicker.
If the Waveform is FBACK-OSC		
Harmonics	-63- +63	Varies the sound of the harmonics.
FBK Amount (Feedback Amount)	-63- +63	Adjusts the amount of feedback to adjust the level of the harmonics.
If the Waveform is X-MOD-OSC		
X-MOD (Cross Modulation Depth)	-63- +63	Cross Modulation is when OSC2 modifies the frequency of OSC1. X-MOD adjusts the depth of this Cross Modulation. As the knob is rotated toward the right, the sound of OSC1 will become more complex, with more overtones, and will be suitable for creating metallic sounds and sound effects. NOTE "Cross Modulation Depth" can be selected only for OSC1. NOTE "Cross Modulation Depth" does nothing if OSC2 is off.
Fat	0-127	Emphasizes the low-frequency region of the sound.
In other cases		
Pulse Width	-63- +63	Specifies the amount by which the wave shape will be modified.
Fat	0-127	Emphasizes the low-frequency region of the sound.

What is a sub-oscillator?

The sub-oscillator adds a low pitch to create a thicker sound. You can use the Detune parameter to add a detune effect.



Detune is the effect or technique of adding (layering) a sound at a slightly different pitch. When using the sub-oscillator, you can apply a detune effect by setting Detune to a value other than "0."

OSC Type (PCM OSC)



Parameter	Value	Description
Waveform (PCM Oscillator Waveform)	1-999 (wave number)	Selects the wave upon which the sound is to be based when using a PCM oscillator. TIP When you touch <Search>, the Wave List window will appear, allowing you to select the wave from the list. MEMO When you select a wave, the wave name, encoding type, and stereo/mono will also be displayed.
Start Offset (PCM Oscillator Start Offset)	0- **	Specifies the starting address of the wave.
Playback Mode (PCM Oscillator Playback Mode)	RETRIGGER LEGATO STEP EVENT	RETRIGGER: The sample will play back from the beginning each time you play a key. LEGATO: When you play legato, the playback point will be synchronized with the currently playing sound. STEP: Each time you play a key, the sample will play back to the next event (p. 189) and then stop. EVENT: The sample will be divided at each event and assigned to separate keys. Each time you press a key, the sample will play from the beginning of the corresponding event.
Vari Sw (PCM Oscillator Vari Switch)	OFF, ON	Switches whether the sound will be produced using VariPhrase (ON) or linearly (OFF).
Time Trip Sw (Time Trip Switch)	OFF, ON	Selects whether Time Trip will operate (ON) or not (OFF).
Beat Keep Sw (Time Trip Beat Keep Switch)	OFF, ON	After Time Trip is operated, this selects whether you will "chase" to the beat location where you otherwise would have been if Time Trip had not been operated (ON), or whether this "chase" will not occur (OFF).
Loop Sw (PCM Oscillator Loop Switch)	OFF, ON	Specifies whether the wave will be played as a loop (ON) or not (OFF).
Robot Sw (PCM Oscillator Robot Voice Switch)	OFF, ON	Specifies whether the pitch of the wave will be held steady (ON) or not (OFF). NOTE This is available only if the encode type (p. 188) is "SOLO."
Tempo Sync Sw (PCM Oscillator Tempo Sync Switch)	OFF, ON	Specifies whether the wave will be sounded in sync with the tempo clock (ON) or not (OFF).
Wave Gain	-12- +12 dB	Sets the gain (amplification) of the waveform.
Pitch (Oscillator Pitch)	-63- +63	Adjusts the pitch of the oscillator.

Editing a Tone (Pro Edit)

Com

OSC1/2

MOD

COSM1/2

TVA

AP Syn

Effects

Parameter	Value	Description
Coarse Tune (Oscillator Coarse Tune)	-48– +48	Adjusts the pitch of the oscillator up or down in semitone steps (+/-4 octaves).
Fine Tune (Oscillator Fine Tune)	-50– +50	Adjusts the pitch of the oscillator up or down in 1-cent steps (+/-50 cents). MEMO One cent is 1/100th of a semitone.
Time	-63– +63	This sets the playback speed (time).
Formant	-63– +63	This sets the vocal quality (formant).

OSC Type (External In)

You can use the signal being received from the rear panel INPUT jack as the oscillator. This allows you to play an external input source from the keyboard.



Parameter	Value	Description
Wave Gain	-12- +12 dB	Sets the gain (amplification) of the waveform.

Pitch (common to Analog and PCM)



Parameter	Value	Description
Pitch (Oscillator Pitch)	-63– +63	Adjusts the pitch of the oscillator.
Pitch Keyfollow (Oscillator Pitch Keyfollow)	-200– +200	<p>This specifies the amount of pitch change that will occur when you play a key one octave higher (i.e., 12 keys upward on the keyboard). If you want the pitch to rise one octave as on a conventional keyboard, set this to “+100.” If you want the pitch to rise two octaves, set this to “+200.” Conversely, set this to a negative value if you want the pitch to fall. With a setting of “0,” all keys will produce the same pitch.</p>
Coarse Tune (Oscillator Coarse Tune)	-48– +48	Adjusts the pitch of the oscillator up or down in semitone steps (+/-4 octaves).
Fine Tune (Oscillator Fine Tune)	-50– +50	Adjusts the pitch of the oscillator up or down in 1-cent steps (+/-50 cents). MEMO One cent is 1/100th of a semitone.
Random (Oscillator Random Pitch Depth)	0, 1, 2, 3, 4, 5, 6, 7, 8, 9, 10, 20, 30, 40, 50, 60, 70, 80, 90, 100, 200, 300, 400, 500, 600, 700, 800, 900, 1000, 1100, 1200	This specifies the width of random pitch deviation that will occur each time a key is pressed. If you do not want the pitch to change randomly, set this to “0.” These values are in units of cents (1/100th of a semitone).
Pitch LFO Depth (Oscillator Pitch LFO Depth)	-63– +63	Specifies how deeply the LFO will affect pitch.

cf. In this screen you can make settings for the envelope that affects the pitch. For details on envelope settings, refer to “Making Envelope Settings” (p. 121).

Pulse Width (Analog)



Parameter	Value	Description
Pulse Width	-63– +63	Specifies the amount by which the wave shape will be modified.
Pulse Width Keyfollow	-200– +200	Specifies the amount by which the pulse width value will be affected by the key you play.
Pulse Width LFO Depth	-63– +63	Specifies how deeply the LFO will affect pulse width.

cf.

In this screen you can make settings for the envelope that affects the pulse width. For details on envelope settings, refer to “Making Envelope Settings” (p. 121).

Fat (Analog)



Parameter	Value	Description
Fat	0–127	Emphasizes the low-frequency region of the sound.
Fat Keyfollow	-200– +200	Specifies the amount by which the fat value will be affected by the key you play.
Fat LFO Depth	-63– +63	Specifies how deeply the LFO will affect fat.



In this screen you can make settings for the envelope that affects the fat. For details on envelope settings, refer to “Making Envelope Settings” (p. 121).



If you use the sub-oscillator (p. 98), the Fat will change to the Detune.

Detune (Analog, when using Sub OSC)



Parameter	Value	Description
Detune	-63– +63	Specifies the detuning (pitch difference) of the sub-oscillator. This setting is valid if the Sub-Oscillator Octave Select is set to “-2, -1, or 0.”
Detune Keyfollow	-200– +200	Specifies the amount by which the detune value will be affected by the key you play.
Detune LFO Depth	-63– +63	Specifies how deeply the LFO will affect detune.

cf. →

In this screen you can make settings for the envelope that affects the detune. For details on envelope settings, refer to “Making Envelope Settings” (p. 121).

SS Detune (Analog, when SUPER-SAW is selected)



Parameter	Value	Description
SS Detune	-63– +63	Adjusts the degree of pitch detuning. As the knob is rotated to the right, the pitch will be detuned more greatly, making the sound more spacious.
SS Detune Keyfollow	-200– +200	Specifies the amount by which the detune value will be affected by the key you play.
SS Detune LFO Depth	-63– +63	Specifies how deeply the LFO will affect detune.

cf. → In this screen you can make settings for the envelope that affects the detune. For details on envelope settings, refer to “Making Envelope Settings” (p. 121).

Mix (Analog, when SUPER-SAW is selected)



Parameter	Value	Description
Mix	-63– +63	Adjusts the volume of the detuned sounds relative to the central sound. As the knob is rotated to the right, the detuned sounds will become louder, making the sound thicker.
Mix Keyfollow	-200– +200	Specifies the amount by which the Mix value will be affected by the key you play.
Mix LFO Depth	-63– +63	Specifies how deeply the LFO will affect Mix.



In this screen you can make settings for the envelope that affects the Mix. For details on envelope settings, refer to “Making Envelope Settings” (p. 121).

Harmonics (Analog, when FBACK-OSC is selected)



Parameter	Value	Description
Harmonics	-63- +63	Varies the sound of the harmonics.
Harmonics Keyfollow	-200- +200	Specifies the amount by which the Harmonics value will be affected by the key you play.
Harmonics LFO Depth	-63- +63	Specifies how deeply the LFO will affect Harmonics.

cf. In this screen you can make settings for the envelope that affects the Harmonics. For details on envelope settings, refer to “Making Envelope Settings” (p. 121).

TIP You can create distinctive effects by applying an LFO or envelope to Harmonics or FBK Amount.

FBK Amount (Analog, when FBACK-OSC is selected)



Parameter	Value	Description
FBK Amount (Feedback Amount)	-63– +63	Adjusts the amount of feedback to adjust the level of the harmonics.
Amount Keyfollow	-200– +200	Specifies the amount by which the feedback value will be affected by the key you play.
Amount LFO Depth	-63– +63	Specifies how deeply the LFO will affect feedback.



In this screen you can make settings for the envelope that affects the feedback. For details on envelope settings, refer to “Making Envelope Settings” (p. 121).



You can create distinctive effects by applying an LFO or envelope to Harmonics or FBK Amount.

X-Mod (Analog, when X-MOD-OSC is selected)



Parameter	Value	Description
X-Mod (Cross Modulation Depth)	-63– +63	Cross Modulation is when OSC2 modifies the frequency of OSC1. X-Mod adjusts the depth of this Cross Modulation. As the knob is rotated toward the right, the sound of OSC1 will become more complex, with more overtones, and will be suitable for creating metallic sounds and sound effects. NOTE "Cross Modulation Depth" can be selected only for OSC1. NOTE "Cross Modulation Depth" does nothing if OSC2 is off.
X-Mod Keyfollow	-200– +200	Specifies the amount by which the Cross Modulation value will be affected by the key you play.
X-Mod LFO Depth	-63– +63	Specifies how deeply the LFO will affect Cross Modulation.

cf. In this screen you can make settings for the envelope that affects the Cross Modulation. For details on envelope settings, refer to "Making Envelope Settings" (p. 121).

Time (PCM)



Parameter	Value	Description
Time	-63– +63	This sets the range of change in playback speed (time).
Time Keyfollow	-200– +200	Specifies the amount by which the time value will be affected by the key you play.
Time Offset	BWD	Specifies “reverse playback” as the basic speed when the time value is “0.”
	ZERO	Specifies “stop” as the basic speed when the time value is “0.”
	FWD	Specifies “normal playback” as the basic speed when the time value is “0.”
Time LFO Depth	-63– +63	Specifies how deeply the LFO will affect time.

Time Offset <How the Time parameter is related to playback speed>

Time	-40	-20	0	20	40
FWD	Reverse playback	Stop	Normal speed	2x speed	4x speed
ZERO	-2x speed	Reverse playback	Stop	Normal speed	2x speed
BWD	4x speed	-2x speed	Reverse playback	Stop	Normal speed

cf. In this screen you can make settings for the envelope that affects the time. For details on envelope settings, refer to “**Making Envelope Settings**” (p. 121).

Formant (PCM)



NOTE You can use this only if the Vari switch (p. 99) is on and when the Encode Type (p. 188) is “SOLO.”

Parameter	Value	Description
Formant	-63– +63	This sets the range of change in vocal quality (formant).
Formant Keyfollow	-200– +200	Specifies the amount by which the formant value will be affected by the key you play.
Energy	OFF, 1–127	Specifies how much the fundamental pitch will be emphasized in order to make the sound more well-defined. Set this to “OFF” if you do not want to use the Energy parameter.
Fmt LFO Depth (Formant LFO Depth)	-63– +63	Specifies how deeply the LFO will affect formant.

cf.

In this screen you can make settings for the envelope that affects the formant. For details on envelope settings, refer to “Making Envelope Settings” (p. 121).

OSC TVA (common to Analog and PCM)



Parameter	Value	Description
Level	0–127	Specifies the volume of the oscillator.
Level Keyfollow	-200– +200	Use this parameter if you want the volume of the oscillator to change according to the key that is pressed. Relative to the volume at the C4 key (center C), positive (+) settings will cause the volume to rise for notes higher than C4, and negative (-) settings will cause the volume to fall for notes higher than C4. Larger settings will produce greater change.
Level LFO Depth	-63– +63	Specifies how deeply the LFO will affect the volume of the oscillator.



In this screen you can make settings for the envelope that affects the sub TVA. For details on envelope settings, refer to “Making Envelope Settings” (p. 121).



If you don't notice any change when you adjust the OSC TVA values, check the TVA settings (p. 119).

LFO (common to Analog and PCM)



cf. → In this screen you can make settings for the LFO that affects the oscillator. For details on LFO settings, refer to “Making LFO Settings” (p. 122).

MOD

In the MOD section, you can not only simply mix OSC1 and OSC2, but also combine them in a variety of ways to create sounds. This is especially effective when you've selected analog oscillators.

Parameter	Value	Description
Modulator Switch	OFF, ON	Switches the modulator on/off.

Modulator Switch



MOD Type

Parameter	Value	Description
Modulator Type	MIX	Adds OSC1 and OSC2.
	RING	<p>This is a ring modulator. It generates a complex waveform by multiplying OSC1 and OSC2. For example, if OSC1 and OSC2 are both simple analog waveforms, you can create metallic bell-like sounds.</p>
	FM	<p>This is a frequency modulator. It generates a complex waveform by using OSC2 to apply FM (Frequency Modulation) to OSC1.</p>

Editing a Tone (Pro Edit)

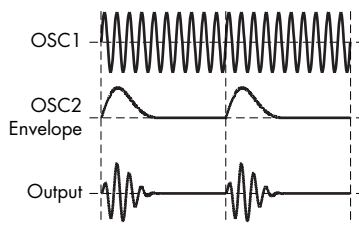
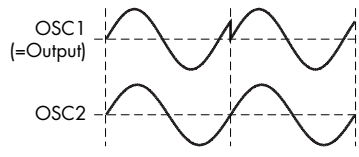
Parameter	Value	Description
	ENV RING	 <p>This is an envelope ring. It uses the volume changes (envelope) of OSC2 to control the volume of OSC1.</p>
	OSC SYNC	 <p>This is oscillator sync. It generates a complex waveform by forcibly resetting OSC1 to the beginning of its cycle in synchronization with the OSC2 frequency. The effect is applied only to OSC1, and is not output to OSC2. This is available only if OSC2 is an analog oscillator. For even greater effectiveness, choose an analog oscillator for OSC1 as well, and set the OSC1 pitch higher than OSC2.</p>
Original Level (Modulator Original Level)	0-127	Specifies the volume for the original sound of OSC1. MEMO This can be set if Modulator Type is set to "RING" or "FM."
Attack (Modulator Attack Time)	0-127	Specifies the attack time of the OSC2 envelope. MEMO This can be set if Modulator Type is set to "ENV RING."
Release (Modulator Release Time)	0-127	Specifies the release time of the OSC2 envelope. MEMO This can be set if Modulator Type is set to "ENV RING."

COSM1/COSM2

Here you can apply various effects to the sound. COSM effects are similar to the built-in effects (Tone-FX, reverb, chorus) or to conventional effect processors, but have the important difference that they are polyphonic, so that the effect is applied to each note you play.

In the COSM section you can select from a total of sixteen types, organized into four categories according to sound.

Parameter	Value	Description
COSM Switch	OFF, ON	Switches the COSM on/off.

COSM Switch

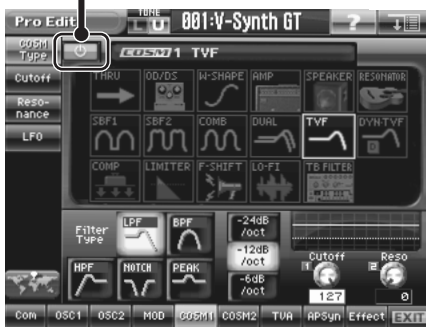

COSM Type

Parameter	Value	Description
COSM Type	THRU, OD/DS, W-SHAPE, AMP, SPEAKER, RESONATOR, SBF1/2, COMB, DUAL, TVF, DYN-TVF, COMP, LIMITER, F-SHIFT, LO-FI, TB FILTER	Use this parameter to select from among the 16 available COSMs. For details on each COSM type, refer to "COSM_EffectsList(E).pdf" in the "EFFECTS LIST" folder on the included CD-ROM.

LFO



cf. → For some COSM selections that you choose in COSM Type, you can make LFO settings. For details on LFO settings, refer to “**Making LFO Settings**” (p. 122).

TVA

This section determines the volume and panning. TVA stands for Time Variant Amplifier, and controls the overall volume of each note you play, affecting aspects of the sound such as master volume (level), envelope, keyboard velocity, pan, and tremolo.

TVA



Parameter	Value	Description
TVA Switch	OFF, ON	Switches the TVA on/off.
Level	0-127	Specifies the volume of the tone.
Level KF (Level Keyfollow)	-200- +200	Use this parameter if you want the volume of the patch to change according to the key that is pressed. Relative to the volume at the C4 key (center C), positive (+) settings will cause the volume to rise for notes higher than C4, and negative (-) settings will cause the volume to fall for notes higher than C4. Larger settings will produce greater change.
Level LFO Depth	-63- +63	Specifies how deeply the LFO will affect the volume of the patch.
Pan	L64-0-63R	Specifies the pan of the patch. "L64" is far left, "0" is center, and "63R" is far right.
Pan KF (Pan Keyfollow)	-200- +200	Use this parameter if you want key position to affect panning. Positive (+) settings will cause notes higher than C4 key (center C) to be panned increasingly further toward the right, and negative (-) settings will cause notes higher than C4 key (center C) to be panned toward the left. Larger settings will produce greater change.
Pan LFO Depth	-63- +63	Specifies how deeply the LFO will affect the pan.

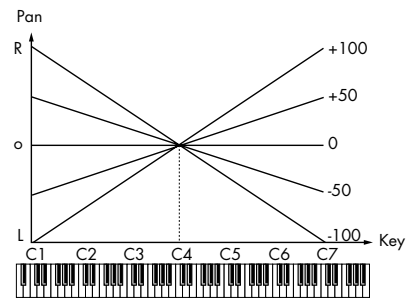

LFO



Parameter	Value	Description
LFO Switch	OFF, ON	Switches LFO on and off.

cf. In this screen you can make settings for the LFO that affects the TVA. For details on LFO settings, refer to “**Making LFO Settings**” (p. 122).

Making Envelope Settings

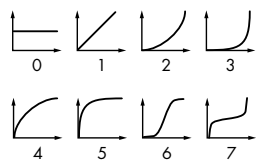
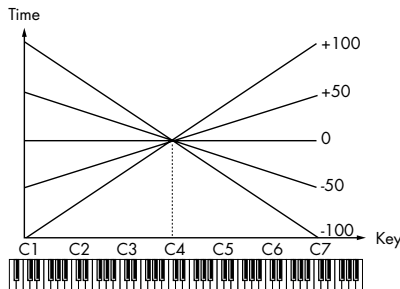
Parameter	Value	Description
Velocity Curve (Envelope Velocity Curve)	0-7	<p>Choose from the following seven curves to specify how your keyboard playing strength will affect the envelope depth. If you don't want your keyboard playing strength to affect the envelope depth, set this to "0".</p> 
Velocity Sens (Envelope Velocity Sensitivity)	-63- +63	Keyboard playing dynamics can be used to control the depth of the envelope. If you want the envelope to have more effect for strongly played notes, set this parameter to a positive (+) value. If you want the pitch envelope to have less effect for strongly played notes, set this to a negative (-) value.
Velocity A-Sens (Envelope Attack Time Velocity Sensitivity)	-63- +63	This allows keyboard dynamics to affect the attack time of the envelope. If you want attack time to be speeded up for strongly played notes, set this parameter to a positive (+) value. If you want it to be slowed down, set this to a negative (-) value.
Velocity D-Sens (Envelope Decay Time Velocity Sensitivity)	-63- +63	This allows keyboard dynamics to affect the decay time of the envelope. If you want decay time to be speeded up for strongly played notes, set this parameter to a positive (+) value. If you want it to be slowed down, set this to a negative (-) value.
Velocity R-Sens (Envelope Release Time Velocity Sensitivity)	-63- +63	This allows key release speed to affect the release time of the envelope. If you want release time to be speeded up for quickly released notes, set this parameter to a positive (+) value. If you want it to be slowed down, set this to a negative (-) value.
ADSR Attack (Envelope Attack Time)	0-127, Note	Specifies the attack time of the envelope (the time from when you press a key until the envelope level reaches the maximum value).
ADSR Decay (Envelope Decay Time)	0-127, Note	Specifies the decay time of the envelope (the time from when the envelope level reaches the maximum value until it falls to a constant value).
ADSR Sustain (Envelope Sustain Level)	0-127	Specifies the sustain level of the envelope (the level at which the envelope remains constant).
ADSR Release (Envelope Release Time)	0-127, Note	Specifies the release time of the envelope (the time from when you release a key until the envelope level reaches 0).
		<p>MEMO</p> <p>"ENVELOPE" in the lower right of the screen shows a graphical representation of the envelope produced by the current settings.</p>
Env Time KF (Envelope Time Keyfollow)	-200- +200	<p>Make this setting when you want the decay time and subsequent times of the envelope to be affected by the location of the key you play. Based on the envelope times for the C4 key (center C), positive (+) settings will cause notes higher than C4 to have increasingly shorter times, and negative (-) settings will cause them to have increasingly longer times. Larger settings will produce greater change.</p> 

Making LFO Settings

Parameter	Value	Description
Waveform (LFO Waveform)	SINE	Sine wave
	TRI	Triangle wave
	SAW	Sawtooth wave
	SQR	Square wave
	RND	Random wave
	TRP	Trapezoidal wave
	S&H	Sample & Hold wave (one time per cycle, LFO value is changed)
CHAOS	Chaos wave	
Offset (LFO Offset)	-100, -50, 0, +50, +100	Raises or lowers the LFO waveform relative to the central value. Positive (+) settings will move the waveform so that modulation will occur from the central value upward. Negative (-) settings will move the waveform so that modulation will occur from the central value downward.
Key Sync (LFO Key Sync Switch)	OFF, ON	This specifies whether the LFO cycle will be synchronized to begin when the key is pressed (ON) or not (OFF).
Delay Time (LFO Delay Time)	0-127	Delay Time (LFO Delay Time) specifies the time elapsed before the LFO effect is applied (the effect continues) after the key is pressed (or released). cf. After referring to “ How to Apply the LFO ” (p. 123), change the setting until the desired effect is achieved.
Rate (LFO Rate)	0-127, Note	Adjusts the modulation rate, or speed, of the LFO. LFO Rate sets the beat length for the synchronized tempo when the tempo that specifies the LFO cycle (Patch Tempo) is synchronized with the tempo set in a external sequencer. (Example) For a tempo of 120 (120 quarter notes occur in 1 minute (60 seconds)) Setting <ul style="list-style-type: none"> ♩ (half note) 1 second (60 / 60 = 1 (second)) ♪ (quarter note) 0.5 seconds (60 / 120 = 0.5 (seconds)) ♫ (eighth note) 0.25 seconds (60 / 240 = 0.25 (seconds)) NOTE This setting will be ignored if the Waveform parameter is set to “CHAOS.”
Fade Mode (LFO Fade Mode)	ON <<, ON >>, OFF <<, OFF >>	Specifies how the LFO will be applied. cf. After referring to “ How to Apply the LFO ” (p. 123), change the setting until the desired effect is achieved.
Fade Time (LFO Fade Time)	0-127	Specifies the time over which the LFO amplitude will reach the maximum (minimum). cf. After referring to “ How to Apply the LFO ” (p. 123), change the setting until the desired effect is achieved.

MEMO “LFO Curve” in the lower right of the screen shows a wave graphic that corresponds to the current settings.

How to Apply the LFO

- Apply the LFO gradually after the key is pressed

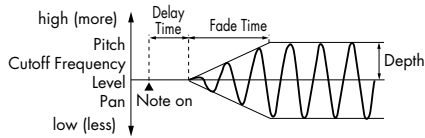

Delay Time	The time from when the keyboard is played until the LFO begins to be applied.
Fade Mode	ON <<
Fade Time	The time over which the LFO amplitude will reach the maximum after the Delay Time has elapsed.

- Apply the LFO gradually after the key is released

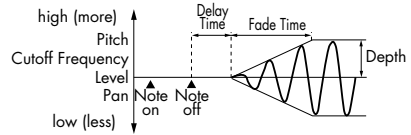

Delay Time	The time from when the keyboard is released until the LFO begins to be applied.
Fade Mode	OFF <<
Fade Time	The time over which the LFO amplitude will reach the maximum after the Delay Time has elapsed.

- Apply the LFO immediately when the key is pressed, and then gradually begin to decrease the effect

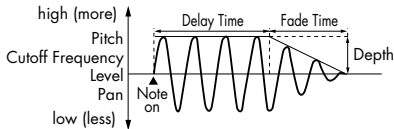

Delay Time	The time that the LFO will continue after the keyboard is played.
Fade Mode	ON >>
Fade Time	The time over which the LFO amplitude will reach the minimum after the Delay Time has elapsed.

- Apply the LFO from when the key is pressed until it is released, and gradually begin to decrease the effect when the key is released

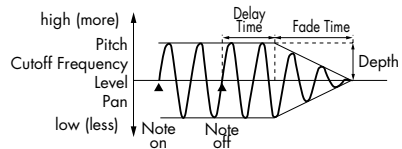

Delay Time	The time that the LFO will continue after the keyboard is released.
Fade Mode	OFF >>
Fade Time	The time over which the LFO amplitude will reach the minimum after the Delay Time has elapsed.

AP Syn (AP-Synthesis)

AP-Synthesis is the world’s first sound generating technology that is able to apply the “behavioral model” of specific acoustic instruments to synthesizer sounds, thus creating new synth sounds that are overflowing with living expression. Conventional physical modeling sound generators model a musical instrument’s “structure” (such as the shape of the resonating body, the length of the tube, the materials of the vibrating part). In contrast, AP-Synthesis models the way in which specific instruments behave in response to performance techniques such as trills, portamento, vibrato, or changes in dynamics.

Based on acoustic instruments that are considered particularly expressive lead instruments, the AP-Synthesis on the V-Synth GT provides five different models (phrase models): violin, erhu, sax, flute, and multifade.

By applying the selected phrase model to one of 38 different AP-Synthesis source waves, you can create completely new “living synth sounds” that have never been heard before.

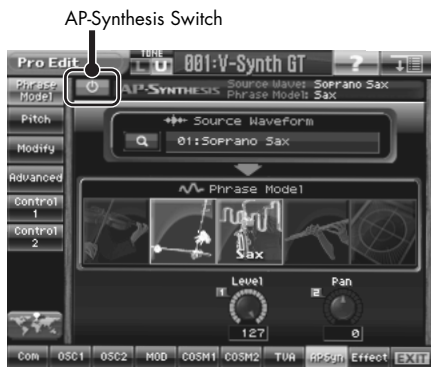

Parameter	Value	Description
AP-Synthesis Switch	OFF, ON	Switches AP-Synthesis on and off.

Using the MODIFY knob (panel)

If you hold down [SHIFT] and touch a knob graphic in the Modify screen (or the Advanced screen), you’ll be able to use the V-Synth GT’s front panel MODIFY knob to directly control the selected parameter. An “MD” indication will appear for a parameter that can be controlled with the MODIFY knob.



This is selected for direct control by the MODIFY knob.



Phrase Model



Parameter	Value	Description
Source Waveform	Soprano Sax	Specifies the source waveform.
	Tenor Sax 1	
	Tenor Sax 2	
	Flute	
	Shakuhachi 1	
	Shakuhachi 2	
	Quena Pipe	
	Pan Pipes	
	Shino Pipe	
	Ryuteki Pipe	
	Qudi Pipe	
	Uilleann Pipes	
	Oboe 1, Oboe 2	
	Wood Winds	
	Harmonica	
	Trumpet	
	Flugelhorn	
	Violin	
	Erhu 1, Erhu 2	
	MG Saw	
	Saw Wave 1	
	Saw Wave 2	
	Square Wave	
	Pulse Wave	
	Ramp Wave	
	Triangle Wave	
	Sine Wave	
Super Saw		
Detune Wave 1		
Detune Wave 2		
Detune Wave 3		
Detune Wave 4		
Detune Wave 5		
Synth Strings		
Robot Voice, Noise		
Phrase Model	Violin	Violin phrase model.
	Erhu	Erhu phrase model.
	Sax	Sax phrase model.
	Flute	Flute phrase model.
	Multifade	A model that is not categorized as a phrase model for the above instruments.
Level	0–127	The volume of AP-Synthesis.
Pan	L64–0–63R	The panning (stereo position) of AP-Synthesis.

Editing a Tone (Pro Edit)

Com

OSC1/2

MOD

COSM1/2

TVA

AP Syn

Effects

Pitch



Parameter	Value	Description
Pitch Coarse (Pitch Coarse Tune)	-48– +48	Adjusts the pitch of the tone in semitone steps (+/-4 octaves).
Pitch Fine (Pitch Fine Tune)	-50– +50	Adjusts the pitch of the tone in one-cent steps (+/-50 cents). MEMO 1 cent = 1/100th of a semitone
Octave Shift	-3– +3	Adjusts the pitch of the tone up or down in units of an octave (+/-3 octaves).

Modify (when Phrase Model is “Violin”)



Parameter	Value	Description
Attack Time	-100- +100	Adjusts the attack of the sound. Positive (+) values will make the attack slower, and negative (-) values will make the attack faster.
Release Time	-100- +100	Adjusts the length of the release. Positive (+) values will lengthen the release, and negative (-) values will shorten it.
Fortissimo Atk Level (Fortissimo Attack Level)	-100- +100	Adjusts the volume of the attack that occurs for strong input velocities (-100- +100). The volume will be louder for positive (+) values, or softer for negative (-) values.
Scrape Nz Level (Scrape Noise Level)	-100- +100	Adjusts the volume of the noise of the bow scraping on the string. The volume will be louder for positive (+) values, or softer for negative (-) values.
Natural Feel	-100- +100	Adjusts the amount of variation in the sound. Positive (+) values will produce more variation, and negative (-) values will produce less.
Vibrato Dly Time (Vibrato Delay Time)	-100- +100	Adjusts the time from the beginning of the note until vibrato begins to be applied. Positive (+) values will lengthen the time until vibrato begins, and negative (-) values will shorten the time.
Vibrato Depth	-100- +100	Adjusts the depth of vibrato when the dynamics are at the minimum. Positive (+) values will produce deeper vibrato, and negative (-) values will produce less vibrato.
Vibrato Rate	-100- +100	Adjusts the vibrato rate. Positive (+) values will make the vibrato faster, and negative (-) values will make it slower.

Modify (when Phrase Model is "Erhu")



Parameter	Value	Description
Attack Time	-100- +100	Adjusts the attack of the sound. Positive (+) values will make the attack slower, and negative (-) values will make the attack faster.
Release Time	-100- +100	Adjusts the length of the release. Positive (+) values will lengthen the release, and negative (-) values will shorten it.
Porta Time (Portamento Time)	-100- +100	Adjusts the speed of portamento. Positive (+) values will make portamento slower, and negative (-) values will make portamento faster.
Scrape Nz Level (Scrape Noise Level)	-100- +100	Adjusts the volume of the noise of the bow scraping on the string. The volume will be louder for positive (+) values, or softer for negative (-) values.
Natural Feel	-100- +100	Adjusts the amount of variation in the sound. Positive (+) values will produce more variation, and negative (-) values will produce less.
Vibrato Dly Time (Vibrato Delay Time)	-100- +100	Adjusts the time from the beginning of the note until vibrato begins to be applied. Positive (+) values will lengthen the time until vibrato begins, and negative (-) values will shorten the time.
Vibrato Depth	-100- +100	Adjusts the depth of vibrato when the dynamics are at the minimum. Positive (+) values will produce deeper vibrato, and negative (-) values will produce less vibrato.
Vibrato Rate	-100- +100	Adjusts the vibrato rate. Positive (+) values will make the vibrato faster, and negative (-) values will make it slower.

Modify (when Phrase Model is "Sax")



Parameter	Value	Description
Attack Time	-100- +100	Adjusts the attack of the sound. Positive (+) values will make the attack slower, and negative (-) values will make the attack faster.
Release Time	-100- +100	Adjusts the length of the release. Positive (+) values will lengthen the release, and negative (-) values will shorten it.
Porta Time (Portamento Time)	-100- +100	Adjusts the speed of portamento when the portamento switch is on. Positive (+) values will lengthen the portamento time, and negative (-) values will shorten the portamento time.
Breath Nz Level (Breath Noise Level)	-100- +100	Adjusts the volume of the breath noise. Positive (+) values will increase the volume, and negative (-) values will decrease it.
Natural Feel	-100- +100	Adjusts the amount of variation in the sound. Positive (+) values will produce more variation, and negative (-) values will produce less.
Vibrato Dly Time (Vibrato Delay Time)	-100- +100	Adjusts the time from the beginning of the note until vibrato begins to be applied. Positive (+) values will lengthen the time until vibrato begins, and negative (-) values will shorten the time.
Vibrato Depth	-100- +100	Adjusts the depth of vibrato when the dynamics are at the minimum. Positive (+) values will produce deeper vibrato, and negative (-) values will produce less vibrato.
Vibrato Rate	-100- +100	Adjusts the vibrato rate. Positive (+) values will make the vibrato faster, and negative (-) values will make it slower.

Modify (when Phrase Model is "Flute")



Parameter	Value	Description
Attack Time	-100- +100	Adjusts the attack of the sound. Positive (+) values will make the attack slower, and negative (-) values will make the attack faster.
Release Time	-100- +100	Adjusts the length of the release. Positive (+) values will lengthen the release, and negative (-) values will shorten it.
Slur Nz Level (Slur Noise Level)	-100- +100	Adjusts the volume of the slur noise (the transitional sound made when changing the pitch while continuing to produce sound). Positive (+) values will make this volume louder, and negative (-) values will lessen it.
Breath Nz Level (Breath Noise Level)	-100- +100	Adjusts the volume of the breath noise. Positive (+) values will increase the volume, and negative (-) values will decrease it.
Natural Feel	-100- +100	Adjusts the amount of variation in the sound. Positive (+) values will produce more variation, and negative (-) values will produce less.
Vibrato Dly Time (Vibrato Delay Time)	-100- +100	Adjusts the time from the beginning of the note until vibrato begins to be applied. Positive (+) values will lengthen the time until vibrato begins, and negative (-) values will shorten the time.
Vibrato Depth	-100- +100	Adjusts the depth of vibrato when the dynamics are at the minimum. Positive (+) values will produce deeper vibrato, and negative (-) values will produce less vibrato.
Vibrato Rate	-100- +100	Adjusts the vibrato rate. Positive (+) values will make the vibrato faster, and negative (-) values will make it slower.

Modify (when Phrase Model is "Multifade")



Parameter	Value	Description
Attack Time	-100- +100	Adjusts the attack of the sound. Positive (+) values will make the attack slower, and negative (-) values will make the attack faster.
Release Time	-100- +100	Adjusts the length of the release. Positive (+) values will lengthen the release, and negative (-) values will shorten it.
Porta Time (Portamento Time)	-100- +100	Adjusts the speed of portamento. Positive (+) values will lengthen the portamento time, and negative (-) values will shorten the portamento time.
Sub Tone Level	-100- +100	Adjusts the volume of the noise or sound that is heard in the background. Positive (+) values will increase the volume, and negative (-) values will decrease it. * This may not work for some selections of Source Waveform.
Natural Feel	-100- +100	Adjusts the amount of variation in the sound. Positive (+) values will produce more variation, and negative (-) values will produce less.
Vibrato Dly Time (Vibrato Delay Time)	-100- +100	Adjusts the time from the beginning of the note until vibrato begins to be applied. Positive (+) values will lengthen the time until vibrato begins, and negative (-) values will shorten the time. * This may not work for some selections of Source Waveform.
Vibrato Depth	-100- +100	Adjusts the depth of vibrato when the dynamics are at the minimum. Positive (+) values will produce deeper vibrato, and negative (-) values will produce less vibrato. * This may not work for some selections of Source Waveform.
Vibrato Rate	-100- +100	Adjusts the vibrato rate. Positive (+) values will make the vibrato faster, and negative (-) values will make it slower.

Advanced (when Phrase Model is "Violin")



Parameter	Value	Description
Brightness	-2- +2	Adjusts the brightness of the sound (five steps). Positive (+) values will brighten the sound, and negative (-) values will darken it.
Finger Nz Level (Finger Noise Level)	-100- +100	Adjusts the volume of the strings hitting the fingerboard. Positive (+) values will increase the volume, and negative (-) values will decrease it.
Tenuto Atk Time (Tenuto Attack Time)	-100- +100	Adjusts the attack time when playing tenuto. Positive (+) values will make the attack slower, and negative (-) values will make the attack faster.
Low Velo Limit (Low Velocity Limit)	-100- +100	Adjusts the lower limit of the dynamics produced by the force of your keyboard playing. Positive (+) values will increase the lower limit value, and negative (-) values will decrease it.
Low Dyn Ctrl Lmt (Low Dynamics Controller Limit)	-100- +100	Adjusts the lower limit of the dynamics produced when you operate the controller assigned to dynamics. Positive (+) values will increase the lower limit value, and negative (-) values will decrease it.
Vibrato Dyn Sens (Vibrato Dynamics Sensitivity)	-100- +100	Adjusts the linkage between changes in dynamics and changes in vibrato depth. Positive (+) values will produce deeper vibrato, and negative (-) values will produce less vibrato.
Vibrato Reac Tm (Vibrato Reaction Time)	-100- +100	Adjusts the reaction time when you control the vibrato using the controller assigned to vibrato. Positive (+) values will make the response slower, and negative (-) values will make the response quicker.
PitchBend Reac Tm (Pitch Bend Reaction Time)	-100- +100	Adjusts the reaction time when you operate the pitch bender to control the pitch. Positive (+) values will make the response slower, and negative (-) values will make the response quicker.
Dyn Ctrl1 Reac Tm (Dynamics Controller 1 Reaction Time)	-100- +100	Adjusts the reaction time when you control the dynamics using the controller assigned to dynamics. Positive (+) values will make the response slower, and negative (-) values will make the response quicker.
Dyn Ctrl2 Reac Tm (Dynamics Controller 2 Reaction Time)	-100- +100	Adjusts the reaction time when you control the dynamics using the controller assigned to dynamics. Positive (+) values will make the response slower, and negative (-) values will make the response quicker.
Ambience Level	-100- +100	Adjusts the amount of ambience. Positive (+) values will increase the amount of ambience, and negative (-) values will decrease it.

Advanced (when Phrase Model is “Erhu”)



Parameter	Value	Description
Brightness	-2- +2	Adjusts the brightness of the sound (five steps). Positive (+) values will brighten the sound, and negative (-) values will darken it.
Low Velo Limit (Low Velocity Limit)	-100- +100	Adjusts the lower limit of the dynamics produced by the force of your keyboard playing. Positive (+) values will increase the lower limit value, and negative (-) values will decrease it.
Low Dyn Ctrl Lmt (Low Dynamics Controller Limit)	-100- +100	Adjusts the lower limit of the dynamics produced when you operate the controller assigned to dynamics. Positive (+) values will increase the lower limit value, and negative (-) values will decrease it.
Vibrato Dyn Sens (Vibrato Dynamics Sensitivity)	-100- +100	Adjusts the linkage between changes in dynamics and changes in vibrato depth. Positive (+) values will produce deeper vibrato, and negative (-) values will produce less vibrato.
Vibrato Reac Tm (Vibrato Reaction Time)	-100- +100	Adjusts the reaction time when you control the vibrato using the controller assigned to vibrato. Positive (+) values will make the response slower, and negative (-) values will make the response quicker.
PitchBend Reac Tm (Pitch Bend Reaction Time)	-100- +100	Adjusts the reaction time when you operate the pitch bender to control the pitch. Positive (+) values will make the response slower, and negative (-) values will make the response quicker.
Dyn Ctrl1 Reac Tm (Dynamics Controller 1 Reaction Time)	-100- +100	Adjusts the reaction time when you control the dynamics using the controller assigned to dynamics. Positive (+) values will make the response slower, and negative (-) values will make the response quicker.
Dyn Ctrl2 Reac Tm (Dynamics Controller 2 Reaction Time)	-100- +100	Adjusts the reaction time when you control the dynamics using the controller assigned to dynamics. Positive (+) values will make the response slower, and negative (-) values will make the response quicker.
Ambience Level	-100- +100	Adjusts the amount of ambience. Positive (+) values will increase the amount of ambience, and negative (-) values will decrease it.

Advanced (when Phrase Model is "Sax")



Parameter	Value	Description
Brightness	-2- +2	Adjusts the brightness of the sound (five steps). Positive (+) values will brighten the sound, and negative (-) values will darken it.
Scoop Depth	-100- +100	Adjusts the amount of scoop. Positive (+) values will increase the amount of scoop, and negative (-) values will decrease it.
Key Nz Level (Key Noise Level)	-100- +100	Adjusts the volume of key noise. Positive (+) values will increase the volume, and negative (-) values will decrease it.
Growl Sens (Growl Sensitivity)	-100- +100	Adjusts the dynamics at which growl will begin to be applied. Positive (+) values will broaden the range to which growl is applied, and negative (-) values will narrow the range.
Low Velo Limit (Low Velocity Limit)	-100- +100	Adjusts the lower limit of the dynamics produced by the force of your keyboard playing. Positive (+) values will increase the lower limit value, and negative (-) values will decrease it.
Low Dyn Ctrl Lmt (Low Dynamics Controller Limit)	-100- +100	Adjusts the lower limit of the dynamics produced when you operate the controller assigned to dynamics. Positive (+) values will increase the lower limit value, and negative (-) values will decrease it.
Vibrato Dyn Sens (Vibrato Dynamics Sensitivity)	-100- +100	Adjusts the linkage between changes in dynamics and changes in vibrato depth. Positive (+) values will produce deeper vibrato, and negative (-) values will produce less vibrato.
Vibrato Reac Tm (Vibrato Reaction Time)	-100- +100	Adjusts the reaction time when you control the vibrato using the controller assigned to vibrato. Positive (+) values will make the response slower, and negative (-) values will make the response quicker.
PitchBend Reac Tm (Pitch Bend Reaction Time)	-100- +100	Adjusts the reaction time when you operate the pitch bender to control the pitch. Positive (+) values will make the response slower, and negative (-) values will make the response quicker.
Dyn Ctrl1 Reac Tm (Dynamics Controller 1 Reaction Time)	-100- +100	Adjusts the reaction time when you control the dynamics using the controller assigned to dynamics. Positive (+) values will make the response slower, and negative (-) values will make the response quicker.
Dyn Ctrl2 Reac Tm (Dynamics Controller 2 Reaction Time)	-100- +100	Adjusts the reaction time when you control the dynamics using the controller assigned to dynamics. Positive (+) values will make the response slower, and negative (-) values will make the response quicker.
Ambience Level	-100- +100	Adjusts the amount of ambience. Positive (+) values will increase the amount of ambience, and negative (-) values will decrease it.

Advanced (when Phrase Model is “Flute”)



Parameter	Value	Description
Brightness	-2- +2	Adjusts the brightness of the sound (five steps). Positive (+) values will brighten the sound, and negative (-) values will darken it.
Low Velo Limit (Low Velocity Limit)	-100- +100	Adjusts the lower limit of the dynamics produced by the force of your keyboard playing. Positive (+) values will increase the lower limit value, and negative (-) values will decrease it.
Low Dyn Ctrl Lmt (Low Dynamics Controller Limit)	-100- +100	Adjusts the lower limit of the dynamics produced when you operate the controller assigned to dynamics. Positive (+) values will increase the lower limit value, and negative (-) values will decrease it.
Vibrato Dyn Sens (Vibrato Dynamics Sensitivity)	-100- +100	Adjusts the linkage between changes in dynamics and changes in vibrato depth. Positive (+) values will produce deeper vibrato, and negative (-) values will produce less vibrato.
Vibrato Reac Tm (Vibrato Reaction Time)	-100- +100	Adjusts the reaction time when you control the vibrato using the controller assigned to vibrato. Positive (+) values will make the response slower, and negative (-) values will make the response quicker.
PitchBend Reac Tm (Pitch Bend Reaction Time)	-100- +100	Adjusts the reaction time when you operate the pitch bender to control the pitch. Positive (+) values will make the response slower, and negative (-) values will make the response quicker.
Dyn Ctrl1 Reac Tm (Dynamics Controller 1 Reaction Time)	-100- +100	Adjusts the reaction time when you control the dynamics using the controller assigned to dynamics. Positive (+) values will make the response slower, and negative (-) values will make the response quicker.
Dyn Ctrl2 Reac Tm (Dynamics Controller 2 Reaction Time)	-100- +100	Adjusts the reaction time when you control the dynamics using the controller assigned to dynamics. Positive (+) values will make the response slower, and negative (-) values will make the response quicker.
Ambience Level	-100- +100	Adjusts the amount of ambience. Positive (+) values will increase the amount of ambience, and negative (-) values will decrease it.

Advanced (when Phrase Model is “Multifade”)



Parameter	Value	Description
Brightness	-2- +2	Adjusts the brightness of the sound (five steps). Positive (+) values will brighten the sound, and negative (-) values will darken it.
Porta Depth (Portamento Depth)	-100- +100	Adjusts the amount of pitch change produced by portamento. Positive (+) values will increase the amount of pitch change, and negative (-) values will decrease it.
Fade1 Ctl Default (Fade 1 Control Default)	-100- +100	Adjusts the initial tone balance for fade 1 immediately after the sound is selected (before you operate a controller). * This may not work for some selections of Source Waveform.
Fade2 Ctl Default (Fade 2 Control Default)	-100- +100	Adjusts the initial tone balance for fade 2 immediately after the sound is selected (before you operate a controller). * This may not work for some selections of Source Waveform.
Low Velo Limit (Low Velocity Limit)	-100- +100	Adjusts the lower limit of the dynamics produced by the force of your keyboard playing. Positive (+) values will increase the lower limit value, and negative (-) values will decrease it. * This may not work for some selections of Source Waveform.
Low Dyn Ctrl Lmt (Low Dynamics Controller Limit)	-100- +100	Adjusts the lower limit of the dynamics produced when you operate the controller assigned to dynamics. Positive (+) values will increase the lower limit value, and negative (-) values will decrease it. * This may not work for some selections of Source Waveform.
Vibrato Dyn Sens (Vibrato Dynamics Sensitivity)	-100- +100	Adjusts the linkage between changes in dynamics and changes in vibrato depth. Positive (+) values will produce deeper vibrato, and negative (-) values will produce less vibrato.
Vibrato Reac Tm (Vibrato Reaction Time)	-100- +100	Adjusts the reaction time when you control the vibrato using the controller assigned to vibrato. Positive (+) values will make the response slower, and negative (-) values will make the response quicker.
Fade Ctrl Reac Tm (Fade Controller Reaction Time)	-100- +100	Adjusts the reaction time when you modify the tone by operating the controllers assigned to fade 1 and 2. Positive (+) values will make the response slower, and negative (-) values will make the response quicker. * This may not work for some selections of Source Waveform.
PitchBend Reac Tm (Pitch Bend Reaction Time)	-100- +100	Adjusts the reaction time when you operate the pitch bender to control the pitch. Positive (+) values will make the response slower, and negative (-) values will make the response quicker.
Dyn Ctrl1 Reac Tm (Dynamics Controller 1 Reaction Time)	-100- +100	Adjusts the reaction time when you control the dynamics using the controller assigned to dynamics. Positive (+) values will make the response slower, and negative (-) values will make the response quicker. * This may not work for some selections of Source Waveform.
Dyn Ctrl2 Reac Tm (Dynamics Controller 2 Reaction Time)	-100- +100	Adjusts the reaction time when you control the dynamics using the controller assigned to dynamics. Positive (+) values will make the response slower, and negative (-) values will make the response quicker. * This may not work for some selections of Source Waveform.
Ambience Level	-100- +100	Adjusts the amount of ambience. Positive (+) values will increase the amount of ambience, and negative (-) values will decrease it.

Control 1

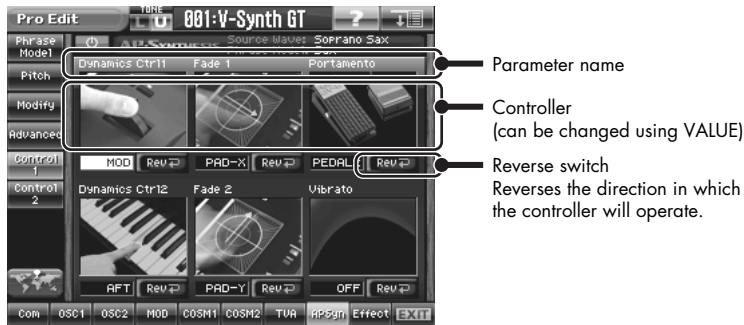

Parameter	Description
Dynamics Ctrl1 (Dynamics Controller 1)	Controls the dynamics. * If the Phrase Model is Multifade, this may not work for some selections of Source Waveform.
Dynamics Ctrl2 (Dynamics Controller 2)	Controls the dynamics. * If the Phrase Model is Multifade, this may not work for some selections of Source Waveform.
Fade 1	Controls the amount of fade 1. * This can be specified only if the Phrase Model is "Multifade." This may not work for some selections of Source Waveform.
Fade 2	Controls the amount of fade 2. * This can be specified only if the Phrase Model is "Multifade." This may not work for some selections of Source Waveform.
Portamento	Controls portamento on/off. * This is not supported by the Phrase Model "Flute."
Vibrato	Controls the rate and depth of vibrato.

Control 2

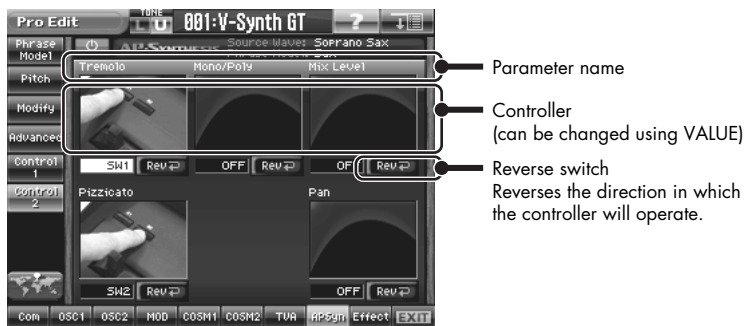

Parameter	Description
Tremolo	Switches to a tremolo sound. * This can be specified only if the Phrase Model is "Violin."
Pizzicato	Switches to pizzicato. * This can be specified only if the Phrase Model is "Violin."
Mono/Poly	Switches to an always-layered sound. * This can be specified only if the Phrase Model is "Violin."
Mix Level	Controls the volume.
Pan	Controls the panning.

Tone-FX (Tone Effect)

The V-Synth GT contains three high-quality effects: Tone-FX (tone effect), Chorus, and Reverb. The tone effect can be applied to individual tones, and the amount of signal sent to chorus and reverb can be specified for each tone.

Routing

The effect blocks are displayed as small rack units. By turning each effect on/off you can freely specify the connecting path (signal flow).

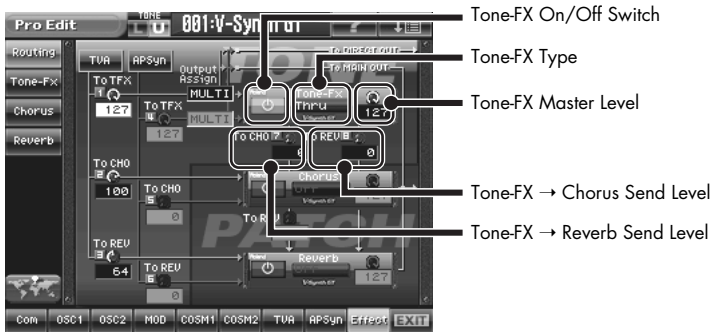

Parameter	Value	Description
TVA Tone-FX Send (TVA Tone-FX Send Level)	0-127	Sets the level of the signal sent to Tone-FX.
TVA CHO Send (TVA Chorus Send Level)	0-127	Sets the level of the signal sent to chorus.
TVA REV Send (TVA Reverb Send Level)	0-127	Sets the level of the signal sent to reverb.
TVA Output Assign	T-FX MAIN DIR	T-FX: Outputs the direct sound in stereo through Tone-FX. You can also apply chorus or reverb to the sound that passes through Tone-FX. MAIN: Outputs the direct sound to the MAIN OUT jacks in stereo without passing through Tone-FX. DIR: Outputs the direct sound to the DIRECT OUT jacks in stereo without passing through Tone-FX. Make this setting when you want to use external effects.
AP Syn Tone-FX Send (AP Syn Tone-FX Send Level)	0-127	Sets the level of the signal sent to Tone-FX.
AP Syn CHO Send (AP Syn Chorus Send Level)	0-127	Sets the level of the signal sent to chorus.
AP Syn REV Send (AP Syn Reverb Send Level)	0-127	Sets the level of the signal sent to reverb.
AP Syn Output Assign	T-FX MAIN DIR	T-FX: Outputs the direct sound in stereo through Tone-FX. You can also apply chorus or reverb to the sound that passes through Tone-FX. MAIN: Outputs the direct sound to the MAIN OUT jacks in stereo without passing through Tone-FX. DIR: Outputs the direct sound to the DIRECT OUT jacks in stereo without passing through Tone-FX. Make this setting when you want to use external effects.

Editing a Tone (Pro Edit)

Com

OSC1/2

MOD

COSM1/2

TVA

AP Syn

Effects

Parameter	Value	Description
Tone-FX (Tone-FX On/Off Switch)	OFF, ON	Switches Tone-FX on and off.
Tone-FX Type	00 (Thru)-41	Touch this to jump to the Tone-FX screen (p. 141), where you can choose the desired Tone-FX from 41 different types. For details on each Tone-FX type, refer to "COSM_EffectsList(E).pdf" in the "EFFECTS LIST" folder on the included CD-ROM.
Tone-FX Master Level	0-127	Adjusts the volume of the sound that has passed through the Tone-FX.
Tone-FX To CHO (Tone FX Chorus Send Level)	0-127	Adjusts the amount of chorus for the sound that passes through Tone-FX. If you don't want to add the Chorus effect, set it to "0."
Tone-FX To REV (Tone-FX Reverb Send Level)	0-127	Adjusts the amount of reverb for the sound that passes through Tone-FX. If you don't want to add the Reverb effect, set it to "0."
CHO (Chorus On/Off Switch)	OFF, ON	These parameters can be specified individually for each patch. For details, refer to " Effects (Setting Effects for a Patch) " (p. 76).
CHO Type (Chorus Type)	00 (Off)-08	
CHO Master Level (Chorus Master Level)	0-127	
CHO To REV (Chorus Reverb Send Level)	0-127	
REV (Reverb On/Off Switch)	OFF, ON	
REV Type (Reverb Type)	00 (Off)-13	
REV Master Level (Reverb Master Level)	0-127	

Tone-FX



Parameter	Value	Description
Tone-FX Switch	OFF, ON	Switches the Tone-FX on/off.
Tone-FX Type	00 (Thru)–41	Use this parameter to select from among the 41 available Tone-FX. In this setting screen, you can edit the parameters of the Tone-FX that is selected by the Tone-FX Type setting. For details on each Tone-FX type, refer to "COSM_EffectsList(E).pdf" in the "EFFECTS LIST" folder on the included CD-ROM. MEMO When you touch <Search>, the Tone-FX Type List window will appear, allowing you to select the Tone-FX from the list.

Chorus

This effect is applied to the entire patch.

For details, refer to "Effects (Setting Effects for a Patch)" (p. 76).

Reverb

This effect is applied to the entire patch.

For details, refer to "Effects (Setting Effects for a Patch)" (p. 76).

Using Steps to Vary the Sound (Multi Step Modulator)

The Multi Step Modulator is a function that modulates the value of various parameters according to a sixteen-step sequence. On the V-Synth GT, the patterns of this sequence are managed as "tracks." You can simultaneously use up to four tracks, with each track containing a different sequence. You can use the panel knobs to freely modify the sequence pattern.

1. Press [PATCH] to access the Patch Play screen.
2. Touch <Step Mod>.



<Step Mod>

The Multi Step Modulator screen will appear.

Multi Step Modulator Switch

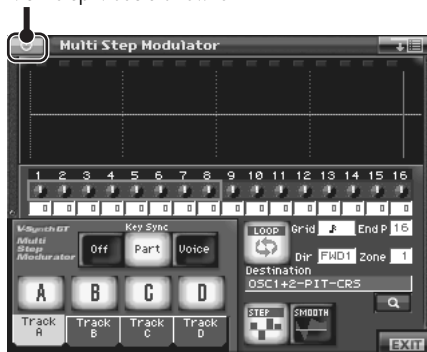

3. Turn <Multi Step Modulator Switch> ON.
The Multi Step Modulator will be applied to the currently selected patch.
4. Touch < A > < D > to turn tracks on/off as desired.

* If you turn all of the tracks off, there will be no effect even if <Multi Step Modulator Switch> is ON.



5. Make settings for the track.

Touch one of the tabs for a track name you turned on in step 4.

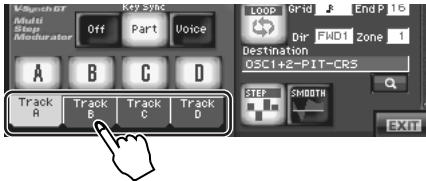

6. While playing the keyboard to hear the sound, input steps 1–8.

The V-Synth GT's E1–E8 knobs correspond to knobs 1–8 and 9–16. To switch between 1–8 and 9–16, hold down [SHIFT] and use [▲] [▼] (the frame in the screen will move). According to how you turn the knob, the effect will be shown as a graph of 1–16 steps, and the color will change.

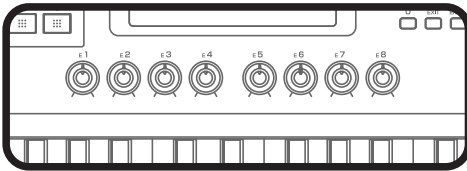

TIP You'll be able to draw the graph directly with your finger.

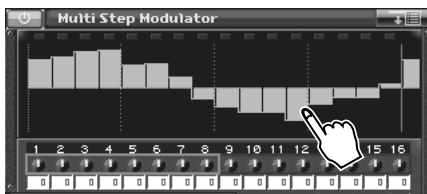

TIP If you touch <SMOOTH>, the graph will be smoothed. This will make the change in the sound occur gradually, producing a more LFO-like result.

TIP The step bar shown at the far right (number 17) is the same as the one that appears at the far left (number 1). This is helpful when you're setting up a looping sequence.

TIP The parameter that is modulated by each track will depend on the tone. In the screen, you can touch Destination to change the assigned parameter.

7. In the same way, make settings for other tracks you turned on in step 4.

8. If you want to stop using the step sequence, turn <Multi Step Modulator Switch> OFF.

cf. For details regarding each parameter, refer to "Multi Step Modulator" (p. 144).

9. Press the panel [EXIT] button to exit the Step Modulator screen.

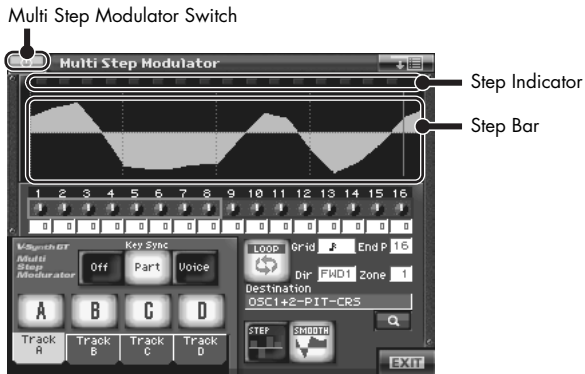

Multi Step Modulator

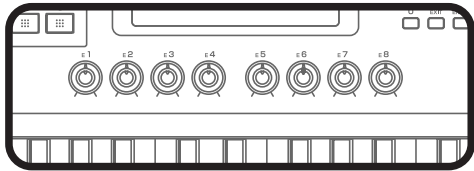

Parameter	Value	Description
Multi Step Modulator Switch * This setting applies to all tracks (Track A–D).	OFF, ON	This turns the multi step modulator on/off.
Step Indicator Step Bar		This indicates the current location within the step sequence. This graphically shows the sixteen steps. The step bar shown at the far right (number 17) is the same as the one that appears at the far left (number 1). This is helpful when you’re setting up a looping sequence. TIP If you touch < SMOOTH >, the graph will become a (smooth) line graph. If you touch < STEP >, the graph will become a bar graph.
Step knobs		Use these knobs to input the sixteen steps. TIP The V-Synth GT’s E1–E8 knobs correspond to knobs 1–8 and 9–16. To switch between 1–8 and 9–16, hold down [SHIFT] and use [▲] [▼] (the frame in the screen will move). According to how you turn the knob, the effect will be shown as a graph of 1–16 steps, and the color will change.
Key Sync (Step Modulator Key Sync) * This setting applies to all tracks (Track A–D).	Off	The step sequence will not be reset when a note-on occurs.
	Part	The step sequence will be reset when a note-on occurs, but will not be reset if the key was played legato.
	Voice	The step sequence will be reset each time a note-on occurs.

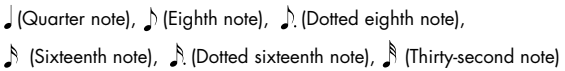

TIP
 When the cursor is at a step knob, you can hold down [SHIFT] and turn the VALUE dial to simultaneously modify the value of all steps.

Parameter	Value	Description
Track Button A–D (Step Modulator Track Buttons A–D)	OFF, ON	These turn the multi step modulator on/off for the four tracks (A–D).
Track TAB A–D (Step Modulator Track Tabs A–D)		These access the editing screens for the four multi step modulator tracks (A–D).
Loop (Step Modulator Loop Switch)	OFF, ON	This turns looping on/off for the step sequence.
Grid (Step Grid)	Note	This specifies the note value of each step. 
End P (Step Modulator End Point)	1–16	This specifies the sequence length as a number of steps.
Dir (Step Modulator Direction)	FWD1–3, BWD1–3	This specifies the direction in which the step sequence will play. 
Zone (Step Modulator Zone)	1–16	This specifies the zone (p. 88) to which the step modulator will be applied.
Destination (Step Modulator Destination)		The parameter that is controlled by the step sequence will depend on the tone.
STEP/SMOOTH (Step/Smooth Switch)	STEP, SMOOTH	Touch < SMOOTH > to select a line graph (smooth change), or touch < STEP > to select a bar graph (stepped change).
Multi Step Modulator Menu	Reset Value	Resets the step bar.
	Invert Value	Inverts the step bar in the vertical direction.
	Reverse Value	Inverts the step bar in the left/right direction.
	Shift Value R	Moves the step bar one step toward the right.
	Shift Value L	Moves the step bar one step toward the left.

Vocal Designer

If you select structure type 5, you'll be able to use Vocal Designer.

Vocal Designer is a function that uses cutting-edge human vocal modeling technology. By connecting a mic to the V-Synth GT and playing the keyboard while you sing, you can model an extremely realistic and natural singing voice.



<VOCAL DESIGNER>

How Vocal Designer is Structured

Vocal Designer consists of four elements: the mic, OSC1/2 (carrier), the vocoder, and effects.

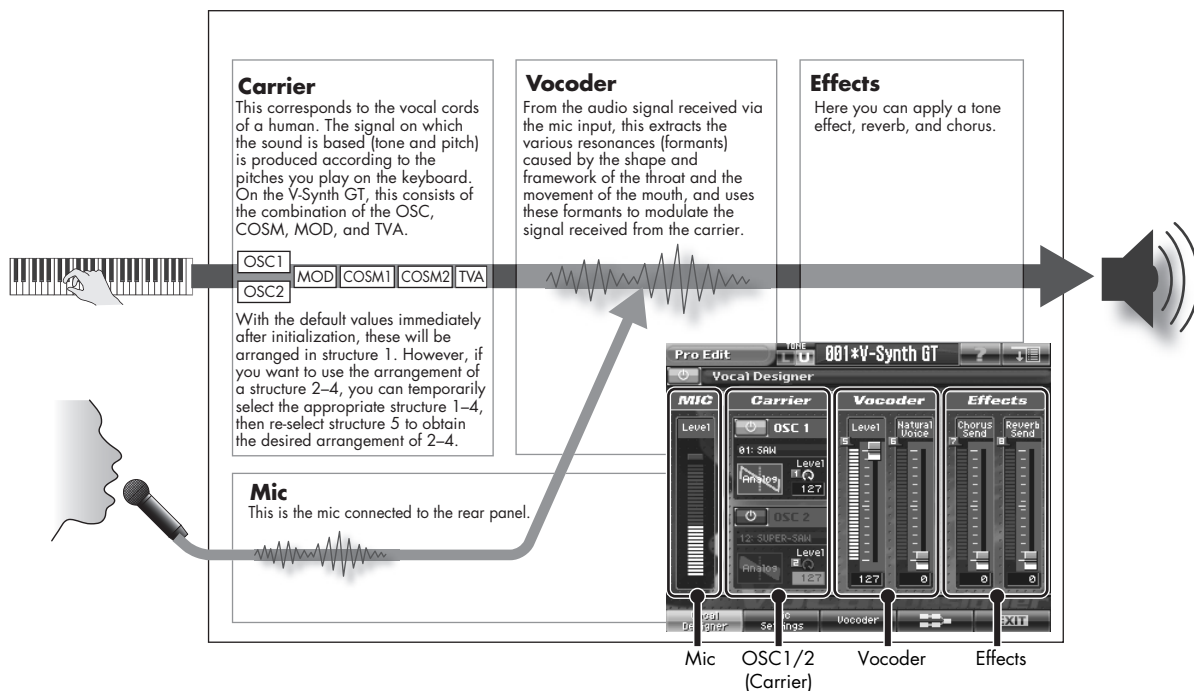

Using Vocal Designer

Connecting a Mic

1. Connect your mic to the "MIC IN jack."
2. Press INPUT [SETTING] on the panel.
The Audio Input Settings screen will appear.

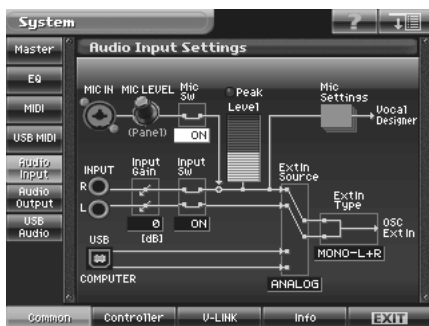

3. Check the mic settings.



While vocalizing into the mic, use the panel's INPUT MIC LEVEL knob to adjust the volume so that the Level indicator in the screen does not quite light red. If the Peak indicator lights, the volume is too high.

4. Press [EXIT] to return to the previous screen.

Make settings for Vocal Designer

1. Select structure type 5.

- Select Structure Type 5 in the Pro Edit screen (p. 86).
- Press STRUCTURE [5], then touch <VOCAL DESIGNER> in the Patch Play screen.



<VOCAL DESIGNER>

NOTE Make sure that UPPER or LOWER is lit as the KEY MODE of the patch for which Vocal Designer is selected.

2. Play the keyboard.

3. While continuing to hold down notes, vocalize into the mic.

The sound using Vocal Designer will be heard according to the volume of your voice.

NOTE Even if you're playing the keyboard, Vocal Designer won't produce sound unless you are vocalizing into the mic. Likewise, even if you're vocalizing into the mic, Vocal Designer won't produce sound unless you're playing the keyboard; you must be doing both.

4. In the lower part of the screen, touch <Vocal Designer>, <Mic Settings>, and <Vocoder>.

In each screen, make mic settings and vocoder settings.

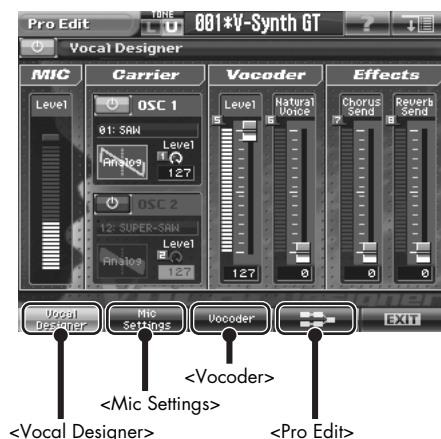

MEMO The sound will stop if you switch the oscillator waveform (p. 150) while holding down a key. If this occurs, release the key and press it again.

Vocal Designer



Parameter	Value	Description
Vocal Designer Switch	OFF, ON	Turns Vocal Designer on/off.
Mic		
Level	0–127	Indicates the mic input level. Use the panel INPUT MIC LEVEL knob to adjust the level so that the peak indication does not light.
Carrier		
OSC1 (Oscillator 1 Switch)	OFF, ON	Specifies whether the sound from OSC1 will be used as the carrier (ON) or not (OFF).
OSC1 Waveform (Oscillator 1 Waveform)	–	Selects the waveform that OSC1 will produce.
OSC1 Level (Oscillator 1 Level)	0–127	Specifies the level of OSC1.
OSC2 (Oscillator 2 Switch)	OFF, ON	Specifies whether the sound from OSC2 will be used as the carrier (ON) or not (OFF).
OSC2 Waveform (Oscillator 2 Waveform)	–	Selects the waveform that OSC2 will produce.
OSC2 Level (Oscillator 2 Level)	0–127	Specifies the level of OSC2.
Vocoder		
Level	0–127	Specifies the volume of Vocal Designer.
Natural Voice	0–127	Specifies the volume of the mic input sound (your own voice).
Effects		
Chorus Send (Chorus Send Level)	0–127	Specifies the level of the signal sent to chorus.
Reverb Send (Reverb Send Level)	0–127	Specifies the level of the signal sent to reverb.

Mic Settings

Vocal Designer

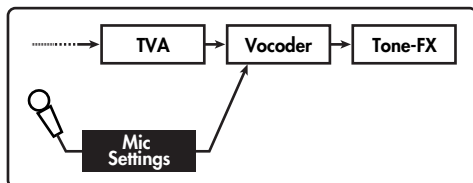

Mic effects such as equalizer are provided to enhance the mic input.

You can use these to adjust the character of the mic sound, and make it easier for you to sing.

As mic effects, equalizer (EQ), noise suppressor (Noise Sup), and compressor (Comp) are provided.

These mic effect settings can be stored together as mic settings, and called up when necessary.

Eight sets of mic settings can be stored. This allows you to easily use settings for Vocal Designer that are appropriate for a particular situation.

NOTE Note that when you edit the parameter value, the mic setting will also change simultaneously (and will be automatically saved).

MEMO Mic settings are System settings. They will be remembered even when you turn off the power. If you want to return all eight mic settings to the factory-set condition, execute a Factory Reset (p. 235).

Mic Type



Parameter	Value	Description
Vocal Designer Mic Settings		
Mic Setting	1–8	Selects the mic setting.
Edit Mic Name		Assigns a name for the mic setting. When you touch this, the Mic Setting Name screen will appear. Here you can assign a name to the mic setting in the same way as when assigning a name to a patch, etc. (p. 59).
Mic Level		
Level	0–127	Adjusts the volume of the mic input.

EQ

Equalizer: Adjusts the character of the low, mid, and high-frequency ranges. The EQ settings are shown by the graph in the middle of the screen.



Parameter	Value	Description
Mic/EQ Switch	OFF, ON	Turns the equalizer on/off.
3 Band EQ		
EQ Low Freq (EQ Low Frequency)	50, 63, 80, 100, 125, 160, 200, 250, 315, 400, 500, 630, 800, 1000, 1250, 1600, 2000, 2500, 3150, 4000 Hz	Specifies the center frequency at which the low-frequency range will be adjusted.
EQ Low Gain	-15- +15 dB	Specifies the gain (amount of boost or cut) for the low-frequency range. Positive settings will boost the low-frequency range.
EQ Mid Freq (EQ Mid Frequency)	50, 63, 80, 100, 125, 160, 200, 250, 315, 400, 500, 630, 800, 1000, 1250, 1600, 2000, 2500, 3150, 4000, 5000, 6300, 8000, 10000, 12500, 16000, 20000 Hz	Specifies the center frequency at which the mid-frequency range will be adjusted.
EQ Mid Gain	-15- +15 dB	Specifies the gain (amount of boost or cut) for the mid-frequency range. Positive settings will boost the mid-frequency range.
EQ Mid Q	0.3, 0.4, 0.6, 0.8, 1.0, 1.5, 2.0, 2.5, 3.0, 3.5, 4.0, 5.0, 6.0, 7.0, 8.0, 10.0, 12.0, 14.0, 16.0, 18.0, 20.0	Specifies the width of the mid-frequency range. Higher settings will narrow the range.
EQ Hi Freq (EQ High Frequency)	2000, 4000, 5000, 6300, 8000, 10000, 12500, 16000, 20000 Hz	Specifies the center frequency at which the high-frequency range will be adjusted.
EQ Hi Gain (EQ High Gain)	-15- +15 dB	Specifies the gain (amount of boost or cut) for the high-frequency range. Positive settings will boost the high-frequency range.

Noise Sup

Noise suppressor: Suppresses noise when no sound is being input.



Parameter	Value	Description
Mic/Noise Suppressor Switch	OFF, ON	Turns the noise suppressor on/off.
NS Threshold (Noise Suppressor Threshold)	-60– -36dB	Specifies the level at which the noise suppressor begins to operate. Sounds below the specified level will be muted.
NS Attack (Noise Suppressor Attack)	0–127	Specifies the duration over which the noise suppressor will disable muting.
NS Release (Noise Suppressor Release)	0–127	Specifies the time from when the noise suppressor begins operating until muting occurs.

Comp

Compressor: Reduces high-level sounds and boosts low-level sounds, thus improving the overall volume balance of the sound.



Parameter	Value	Description
Mic/Compressor Switch	OFF, ON	Turns the compressor on/off.
CP Ratio (Compressor Ratio)	1:1.0–1:16, 1:INF	Specifies the compression ratio.
CP Threshold (Compressor Threshold)	-36–0dB	Specifies the level at which compression will begin.
CP Attack (Compressor Attack)	0–100	Specifies the time from when the input exceeds the Threshold until the volume begins to be compressed.
CP Release (Compressor Release)	0–100	Specifies the time it is to take after the input falls below the Threshold before compression ceases.
CP Gain (Compressor Gain)	0–24 dB	Specifies the output gain.

Vocoder

Vocal Designer

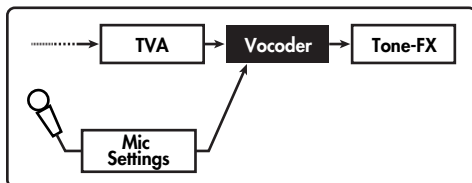

You can use these settings to modify the character of the vocal sound created by Vocal Designer. Choose one of the following four vocoder types, which will determine the character of the sound.

Parameter	Value	Description
Vocoder Type	Stereo	This produces a spacious stereo sound. It is suitable for simulating choral sounds such as choir or chorus.
	Mono	This type emphasizes the intelligibility of the vocal. It is suitable for creating solo vocal sounds. The output will be mono.
	Vintage	This produces the typical "vocoder sound." It is suitable for obtaining the sound of a vintage vocoder such as the VP-330.
	Enhance	This type boosts the high-frequency range. Use this when you want to emphasize the clarity of the vocal sound.

Stereo/Mono/Enhance



Parameter	Value	Description
Formant Type	Flat	No conversion.
	Soprano	Transforms the mic input sound into the specified voice range.
	Alto 1	MEMO "TalkBox" is suitable for obtaining metallic talkbox-type sounds.
	Alto 2	
	Baritone	
	Bass	
	TalkBox (Mono only)	
Level	0-127	Specifies the volume of Vocal Designer.
Attack	0-100	Specifies the attack time of the Vocal Designer sound relative to the mic input sound.
Release	0-100	Specifies the release time of the Vocal Designer sound relative to the mic input sound.
Consonant Level	0-127	Specifies the level at which the consonants extracted from the mic input sound will be output.
Consonant Detect	0-100	Specifies the degree to which consonants will be detected in the mic input sound. Higher settings will make it easier for consonants to be detected.

Vintage



Parameter	Value	Description
Vocoder		
EQ Low Freq	200–800 Hz	Specifies the center frequency at which the low-frequency range will be boosted or cut.
EQ Low Gain	-15– +15dB	Specifies the amount of boost/cut for the low-frequency range.
Hi Cut Switch	OFF, ON	Turns the high-frequency cut on/off. If you feel the sound is raspy, turn this switch on to make the sound smoother.
Level	0–127	Adjusts the volume of Vocal Designer.
Attack	0–100	Specifies the attack time of the Vocal Designer sound relative to the mic input sound.
Release	1–100	Specifies the release time of the Vocal Designer sound relative to the mic input sound.
Consonant Level	0–127	Specifies the level at which the consonants extracted from the mic input sound will be output.
Consonant HPF Freq	4500–9000 Hz	Specifies the frequency used when extracting the high-frequency components from the mic input audio as consonants. Components higher than the specified frequency will be extracted as consonants.
Chorus		
Vintage Vocoder Chorus Switch	OFF, ON	This is an on/off switch for the chorus effect applied to the vocal sound.
Chorus Rate	0.05–10.0 Hz	Adjusts the modulation frequency of the chorus effect.
Chorus Depth	0–127	Adjusts the modulation depth of the chorus effect.
Chorus Balance	D:0:100E– D:100:0E	Adjusts the balance between the vocal sound and the sound with chorus applied.
Chorus HPF Cutoff	200–8000 Hz	Specifies the frequency at which the high-frequency range will be cut.
Chorus Pre Delay	0.0–100 ms	Specifies the delay time until the chorus sound is heard.

MEMO The chorus of the Vintage vocoder is applied separately from the patch effect named Chorus.

Editing a Tone (SOUND SHAPER II)

By using the "Sound Shaper II" function you can edit the tone simply by turning knobs or pressing buttons.

1. Access the Patch Play screen, and select the tone whose settings you wish to modify.
2. Touch <SOUND SHAPER II>.



The SOUND SHAPER II window will appear.
Adjust the sound by operating the switches and knobs while you play the keyboard.

In the case of Structures 1–4

The most suitable parameters for OSC will be assigned.

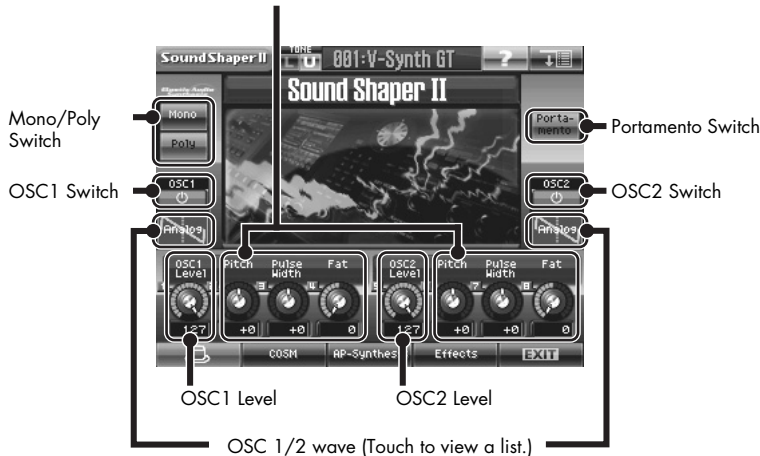

In the case of Structure 5

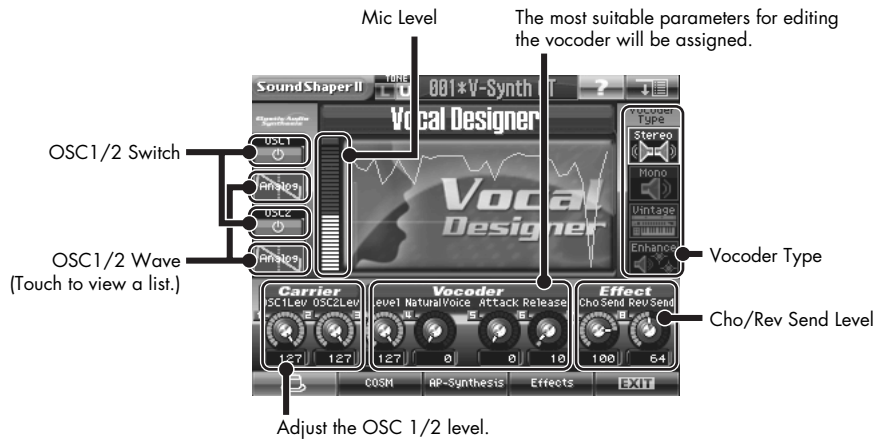

3. Touch <COSM> to make COSM settings (p. 160).
4. Touch <AP-Synthesis> to make AP-Synthesis settings (p. 161).
5. Touch <Effects> to make effect settings (p. 162).
6. Save the tone you created (p. 81).

COSM

Here you can use the [E1]–[E8] knobs to edit the most important COSM parameters.

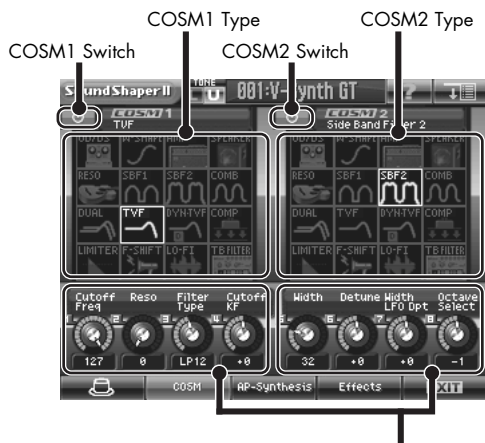

The most suitable parameters for COSM will be assigned.

1. Use the COSM 1/2 switches to turn COSM 1/2 on/off.
2. Touch the screen to select the COSM 1/2 types.
3. Use the [E1]–[E8] knobs to edit the COSM 1/2 parameters.

MEMO You can also change the type by using the VALUE dial or [INC/+] [DEC/-].

cf. For details on each parameter, refer to “COSM1/COSM2” (p. 117) or “COSM_EffectsList(E).pdf” in the “EFFECTS LIST” folder on the included CD-ROM.

AP-Synthesis

Here you can use the [E1]–[E8] knobs to edit the most important AP-Synthesis parameters.

AP-Synthesis Switch

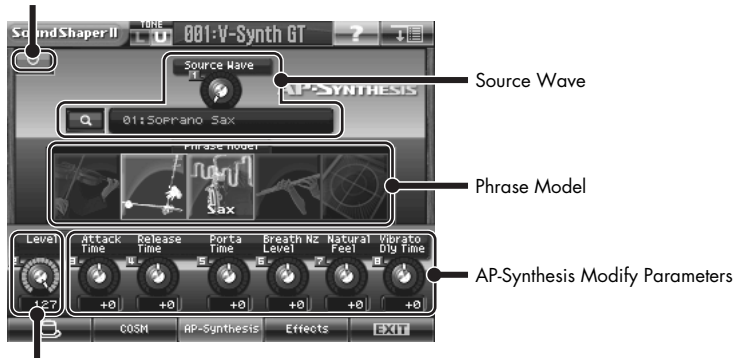

AP-Synthesis Level

1. Use the AP-Synthesis switch to turn AP-Synthesis on/off.

2. Use the [E1] knob to select the source wave.

MEMO You can also use the VALUE dial or [INC/+] [DEC/-] to change this.

3. Touch the screen to select the desired phrase model.

MEMO The available phrase models will depend on the source wave you've selected.

4. Use the [E2] knob to edit the AP-Synthesis level.

5. Use the [E3]–[E8] knobs to edit the AP-Synthesis parameters.

cf. For details on each parameter, refer to “AP Syn (AP-Synthesis)” [p. 124].

Effects

Here you can use the [E1]–[E8] knobs to edit the most important parameters of each effect.

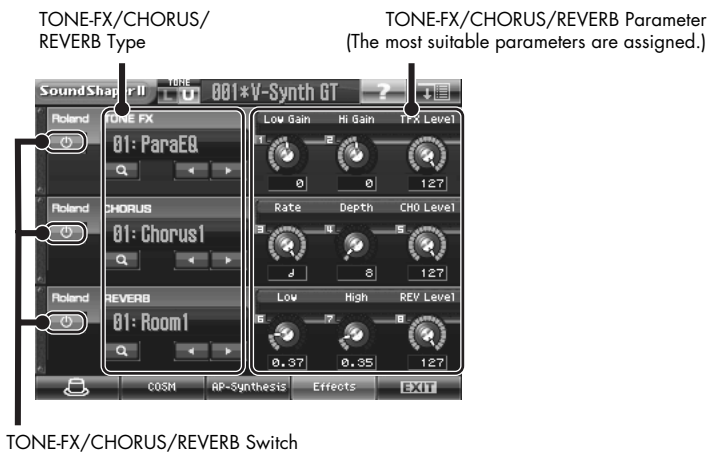

1. Use the effect switches to turn each effect on/off.
2. Select the desired type for each effect.
3. Use the [E1]–[E8] knobs to edit the parameters of each effect.

MEMO You can also edit the parameters by using the VALUE dial or [INC/+] [DEC/-].

cf. For details on the parameters of each effect, refer to “COSM_EffectsList(E).pdf” in the “EFFECTS LIST” folder on the included CD-ROM.

Sample Mode

In this chapter, we will explain the procedures for:

- Sampling (p. 163)
- Editing samples (p. 178)
- Converting samples so the VariPhrase function can be used (Encoding) (p. 187)

Sampling

What is a Template? (Settings before you sample)

A sampling template is something that holds a collection of settings for sampling (the setup settings, pre-effect settings, and metronome settings described below).

You can store eight different sampling templates. When you sample, you will always select one of these eight templates.

With the factory settings, eight sampling templates are preset.

cf. For details on modifying the settings, refer to “**Sampling Procedure**” (p. 165).

MEMO Sampling templates are system settings (with the exception of some metronome parameters). They are remembered even when you turn off the power. If you wish to restore all eight sampling templates to the factory settings, perform the Factory Reset operation (p. 235).

Applications of Each Template

The preset templates cover different input settings and pre-effect types.

Mic	Sample in mono from a mic. Connect a mic to the rear panel MIC IN jack.
Line	Connect your portable audio player or similar device to the INPUT jack on the rear panel.
Coaxial	Sample a digital signal. Connect your audio device to the rear panel COAXIAL IN connector.
Resampl	Play a sample on the V-Synth GT and sample the result. This is called “resampling.” For details on resampling, refer to p. 173.
Comp	Use the compressor pre-effect. The sample will be recorded from the rear panel INPUT jacks.
Limitter	Use the limiter pre-effect. The sample will be recorded from the rear panel INPUT jacks.
MIDI	Start sampling when a sequencer start (system realtime message: FA) is received. The sample will be recorded from the rear panel INPUT jacks.
USB	Sampling from a PC USB Audio.

Factory Settings of Each Template

Setup	Mic	Line	Coaxial	Resampl
Sampling Type	MONO	STEREO	STEREO	STEREO
Input Source	ANALOG	ANALOG	COAXIAL	RESAMPL
Trigger Mode	MANUAL	LEVEL	LEVEL	NOTE
Trigger Level	-12 (dB)	-12 (dB)	-24 (dB)	-12 (dB)
Pre Trigger	0 (msec)	0 (msec)	0 (msec)	0 (msec)
Pre Gain	0 (dB)	0 (dB)	0 (dB)	0 (dB)
PreFX Type	OFF	OFF	OFF	OFF
PreFX COMPRESSOR Sustain	0	0	0	0
PreFX COMPRESSOR Attack	0	0	0	0
PreFX COMPRESSOR Tone	0	0	0	0
PreFX COMPRESSOR Level	0	0	0	0
PreFX LIMITER Thres	-48	-48	-48	-48
PreFX LIMITER Release	0	0	0	0
PreFX LIMITER Tone	0	0	0	0
PreFX LIMITER Level	0	0	0	0
PreFX LIMITER Ratio	1.5:1	1.5:1	1.5:1	1.5:1
PreFX NOISE SUPR Threshold	-60	-60	-60	-60
PreFX NOISE SUPR Release	0	0	0	0
MetroType	REC	REC	REC	REC
CountIn	1MEASURE	OFF	OFF	1MEASURE

Setup	Comp	Limiter	MIDI	USB
SamplingType	STEREO	STEREO	STEREO	STEREO
InputSource	ANALOG	ANALOG	ANALOG	USB
TriggerMode	MANUAL	MANUAL	MIDI	LEVEL
TriggerLevel	-12 (dB)	-12 (dB)	-12 (dB)	-24 (dB)
PreTrigger	0 (msec)	0 (msec)	0 (msec)	0 (msec)
Pre Gain	0 (dB)	0 (dB)	0 (dB)	0 (dB)
PreFxType	COMP+NS	LIMIT+NS	OFF	OFF
PreFx COMPRESSOR Sustain	64	0	0	0
PreFx COMPRESSOR Attack	12	0	0	0
PreFx COMPRESSOR Tone	0	0	0	0
PreFx COMPRESSOR Level	0	0	0	0
PreFx LIMITER Thres	-48	-36	-48	-48
PreFx LIMITER Release	0	80	0	0
PreFx LIMITER Tone	0	0	0	0
PreFx LIMITER Level	0	0	0	0
PreFx LIMITER Ratio	1.5:1	4:1	1.5:1	1.5:1
PreFx NOISE SUPR Threshold	-60	-60	-60	-60
PreFx NOISE SUPR Release	0	0	0	0
MetroType	REC	REC	REC	REC
CountIn	1MEASURE	1MEASURE	OFF	OFF

Sampling Procedure

Here's how to input a sound from the input jacks and sample it. For resampling, refer to the following section. The V-Synth GT has the following input jacks.

- INPUT L, R
- MIC IN (mixed into INPUT R)
- DIGITAL AUDIO INTERFACE
 - OPTICAL IN
 - COAXIAL IN
 - USB (Audio)

Use the input jack that is appropriate for your situation.

- Monaural sampling from a mic
 - MIC IN
- Sampling from an analog source
 - INPUT L, R
- Sampling from a digital source
 - OPTICAL IN or COAXIAL IN
- Sampling via USB
 - USB

NOTE Howling could be produced depending on the location of microphones relative to speakers. This can be remedied by:

1. Changing the orientation of the microphone(s).
2. Relocating microphone(s) at a greater distance from speakers.
3. Lowering volume levels.

When sampling, you must make sure that the following two items are set correctly. If these two settings are incorrect, the sample will not be recorded as you intend.

- What type of sample are you recording? (stereo or mono)
 - In the Sampling General screen, set Sampling Type.
- Which input are you sampling from? (select the input jack)
 - In the Sampling General screen, set Input Source.

MEMO If you have set the metronome (p. 176), the metronome sound will be output from the DIRECT OUT jacks during sampling. However, the sound that is assigned to the DIRECT OUT jacks (p. 139) will not be output.

1. Press [SAMPLE].

The Sample Top screen appears.



2. Select the location (sample number) that you wish to sample.

Move the cursor to the desired sample. Normally, you will select a sample that has no wave; i.e., a sample number whose name is "NO SAMPLE."

In this screen you can use the following functions.

- Select a sample by directly touching it.
- Change the number in steps of eight by pressing [◀] [▶].
- Change the number in steps of one by touching < ▲ >< ▼ >, located beside the sample list, by pressing [▲] [▼] [INC/+] [DEC/-], or by turning the VALUE dial.
- Scroll the sample list by dragging the scroll bar located beside the sample list up or down.
- Move to the number 001 sample by touching <Top>.
- Move to the number 999 sample by touching <End>.
- Display information on the currently selected sample by touching <Info> (p. 192). However, this information will not be displayed for the factory-set waves.
- Audition the currently selected sample by touching <Prevw>.
- When you touch <Search Empty>, you will jump to the "NO SAMPLE" sample number that follows the current sample number.

3. Touch <Sampling>.

The Sampling Template screen appears.



4. Touch <TMPL 1>–<TMPL 8> to select a sampling template.

If you want to modify the settings of the selected sampling template, perform the following steps 5–7.

5. Touch one of the tabs displayed at the bottom of the screen to access the corresponding setting screen.

<General>: Setup settings (p. 174)

<Pre-Effect>: Pre-effect settings (p. 175)

<Metronome>: Metronome settings (p. 176)

cf. ➤ For details on each parameter, refer to the page references given.

6. In each setting screen, touch the touch panel to set the parameters.

Move the cursor to the value box of the parameter you want to edit, and use any of the following methods to edit it.

- Turn the VALUE dial
- Press [INC/+] or [DEC/-]
- Drag your fingertip on the touch panel

7. Adjust the sampling level.

Adjust the volume of the device that is producing the sound.

When sampling from the MIC IN jack, adjust the level by turning the front panel INPUT MIC LEVEL knob.

When sampling from the INPUT jacks, press the INPUT [SETTING] button on the front panel, and in the Audio Input Settings screen that appears, use <Input Gain> to adjust the level.

If you are sampling from the DIGITAL AUDIO INTERFACE IN connector, use the setup Pre gain (p. 174) or the pre-effect Output Level (p. 175) settings to adjust the level.

8. Touch <START> to start sampling.

The way in which sampling will start depends on the Trigger Mode setting in the Sampling General screen, as follows.

If "MANUAL" is selected, sampling will start after a count of the number of measures specified by the metronome Count-In setting.

If "MIDI" is selected, sampling will wait for the sequencer to start (system realtime message: FA). Sampling will begin when the sequencer start message is received.

If "LEVEL" is selected, sampling will wait for an input signal. Sampling will begin when the input signal exceeds the level specified by Trigger Level (p. 174).

If "NOTE" is selected, Sampling will begin when you play the keyboard or note message is received.



If you have selected "MIDI" or "LEVEL," you can touch <START> once again to begin sampling without waiting for the sequencer to start or the input signal to be received.



In the Sampling window, "Remain Time" indicates the remaining time (in seconds) available for sampling.



If memory becomes full, sampling will be halted. If this occurs, delete unneeded samples from memory (p. 172).

9. When you are finished sampling, touch <STOP>.

The display will indicate "COMPLETED!" Touch <PREVIEW> to hear the sound that you sampled, and check whether the sample was recorded as you wish.

<Cancel>: Discard the sample that you just recorded, and return to the Sampling Template screen.

<OK>: Finalize the sample that you just recorded, and register it in the sample list.

<RETRY>: Discard the sample that you just recorded, and sample once again.

10. If you're satisfied with the sound you sampled, touch <OK>.

The sampled sound will be registered in the sample list.

- If you want to discard the sample and try again, touch <RETRY>. <RETRY> will change to <START>, and now you can touch <START> to sample again.
- If you want to stop sampling, touch <Cancel> to return to the Sampling Template screen.



Even if you touch <OK> to register the sample in the sample list, that assignment is temporary, and will be lost when you turn off the power. If you want to keep the sample, you must name the sample (p. 168) and save it (p. 191).

Sample Name (Naming a Sample)

Assign a new name to the sample. You can assign a name consisting of up to twelve characters.

1. Access the Sample Top screen, and select the sample that you want to name (p. 178).
2. Touch <MENU> in the upper right of the screen.
A pulldown menu appears.

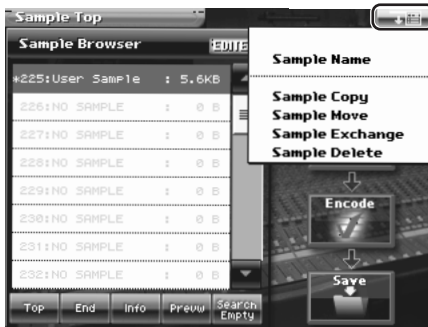

3. In the pulldown menu, touch <Sample Name>.
The Sample Name window appears.



4. Touch the on-screen alphabetic or numeric keys to enter the new name in the text box.
The on-screen keys have the following functions.

< << >> >>>	Move the cursor in the text box to the desired input location.
<shift>	Turn this on when you want to input uppercase letters or symbols.
<clear all>	Erases all characters in the text box.
<back space>	Deletes the character that precedes the cursor location.
<delete>	Deletes the character at the cursor location.

5. When you have finished inputting, touch <OK> to finalize the sample name.
If you want to return to the original unedited name, touch <EXIT>.

Sample Copy (Copying a Sample)

1. Access the Sample Top screen (p. 165).
2. Touch <MENU> in the upper right of the screen.
A pulldown menu appears.

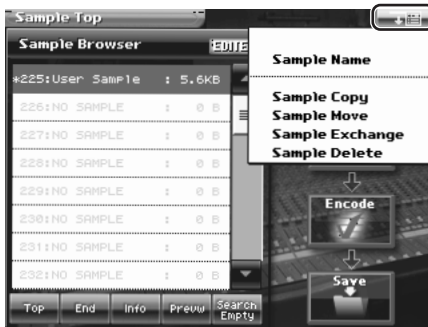

3. In the pulldown menu, touch <Sample Copy>.
The Sample Copy window appears.



4. Move the cursor to "Source" and select the copy-source sample.
5. Move the cursor to "Destination" and select the copy-destination sample.
TIP When you touch <Search>, the Sample List window will appear, allowing you to select the sample from the list.
6. Touch <Execute> to execute the copy operation.
7. Press [EXIT].
The Sample Copy window closes.

Sample Move (Moving a Sample)

1. Access the Sample Top screen (p. 165).
2. Touch <MENU> in the upper right of the screen.
A pulldown menu appears.

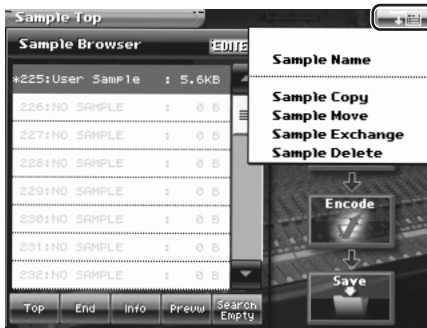

3. In the pulldown menu, touch <Sample Move>.
The Sample Move window appears.

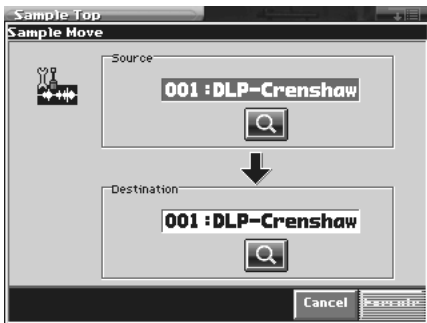

4. Move the cursor to "Source" and select the move-source sample.
5. Move the cursor to "Destination" and select the move-destination sample.
TIP When you touch <Search>, the Sample List window will appear, allowing you to select the sample from the list.
6. Touch <Execute> to execute the move operation.

Sample Exchange (Exchanging a Sample)

1. Access the Sample Top screen (p. 165).
2. Touch <MENU> in the upper right of the screen.
A pulldown menu appears.

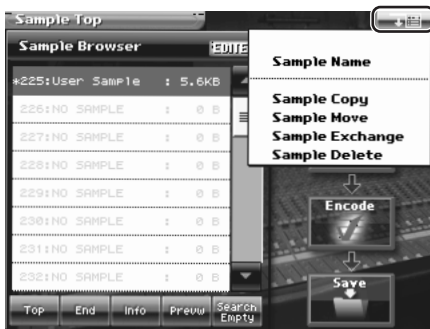

3. In the pulldown menu, touch <Sample Exchange>.
The Sample Exchange window appears.



4. Move the cursor to "Source" and select the exchange-source sample.
5. Move the cursor to "Destination" and select the exchange-destination sample.
TIP When you touch <Search>, the Sample List window will appear, allowing you to select the sample from the list.
6. Touch <Execute> to execute the exchange operation.

Sample Delete (Deleting a Sample)

1. Access the Sample Top screen (p. 165).
2. Touch <MENU> in the upper right of the screen.
A pulldown menu appears.

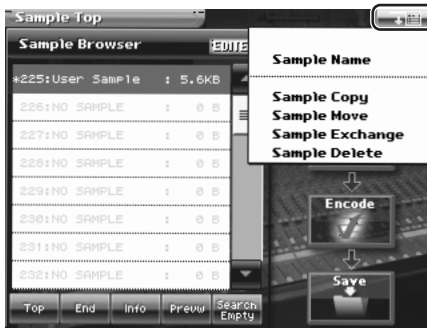

3. In the pulldown menu, touch <Sample Delete>.
The Sample Delete List window appears.



4. From the list, select the sample that you want to delete.
To select the sample, turn the VALUE dial, press [INC/+] [DEC/-], or press [▲] [▼].
You can also select this by directly touching it in the touch panel.
5. Touch <Execute>.
The selected sample will be deleted.
6. If you want to continue deleting other samples, repeat steps 4 and 5.
7. Press [EXIT].
The Sample Delete List window closes.

Resampling

The V-Synth GT is able to resample samples from its internal memory. This is called resampling. In actuality, the sounds that are output from the rear panel MAIN OUT L/MONO, R jacks are sampled.

For example, you could sample multiple samples played simultaneously, and record them as a single sample. You can conserve voices in this way.

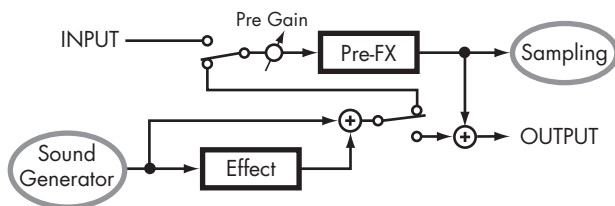

Before you enter Sample mode, make settings so that you can play the sample(s) you wish to resample.

The resampling procedure is essentially the same as the "Sampling Procedure" described in the preceding section.

However, please be aware of the following points.

- You must set the Input Source in the Sampling General screen to "RESAMPL."
- To adjust the sampling level, adjust the setup Pre gain (p. 174) and the pre-effect Output Level (p. 175).

Sampling General (Setup Settings)



Parameter	Value	Description
Sampling Type	STEREO L R	Samples in stereo.
	MONO MIX	Mixes the signals input to L and R, and sample in monaural.
	MONO L	Samples the L input signal in monaural.
	MONO R	Samples the R input signal in monaural.
Input Source	ANALOG	Samples from INPUT jacks or MIC IN jack.
	USB	The sound from USB audio will be sampled.
	OPTICAL	Samples from OPTICAL IN connector.
	COAXIAL	Samples from COAXIAL IN connector.
	RESAMPL	Select this when you wish to resample. The sound that is output to MAIN OUT L/MONO and R will be sampled.
Trigger Mode	MANUAL	Sampling will begin when you touch <START>.
	MIDI	Sampling will begin when an external sequencer start message (system real-time message: FA) is received.
	LEVEL	Sampling will start when the input signal exceeds the level specified by the Trigger Level setting.
	NOTE	Sampling will begin when you play the keyboard or note message is received.
Trigger Level	∞-00 dB	Specifies the input level at which sampling will begin when the Trigger Mode is set to "LEVEL." The trigger level is shown by the "┆" and "┆" in the level meter located at the right of the screen. NOTE If Trigger Mode is set to other than "LEVEL," this parameter has no effect.
Pre Trigger	0-1000 msec	After the selected trigger to start sampling has been received, previously received data for the length of time specified here will be included in the sampled data. When the Trigger Mode is set to "LEVEL" and the early portion of the sample is being lost, you can use this setting to include the early portion.
Pre Gain	-12- +36 dB	Adjusts the input gain. This will apply to the sound that is received from all input jacks. It will also be applied to the sound being resampled. With positive (+) values, the gain will be higher than originally, and with negative (-) values the gain will be lower than originally.

Sampling Pre-Effect (Pre-Effect Settings)



There are three pre-effects: compressor, limiter, and noise suppressor. By using these you can adjust the level of the sound being sampled.

Compressor	By reducing high levels and raising low levels, this effect smoothes out unevenness in volume.
Limiter	By compressing sounds that exceed a specified volume level, this effect prevents the sound from distorting.
Noise Suppressor	This effect leaves the original sound untouched, but mutes the noise that is heard during periods of silence.

Parameter	Value	Description
Type (Pre-Effect Type)	OFF	No pre-effect will be used.
	COMP+NS	Compressor and noise suppressor will be used.
	LMT+NS	Limiter and noise suppressor will be used.
	NS	Noise suppressor will be used.
■ Compressor		
Sustain	0-127	Specifies the time over which a low-level signal is raised until it reaches a fixed volume.
Attack (Attack Time)	0-127	Specifies the attack time of the input sound.
Tone	-50- +50	Adjusts the tone quality of the compressor.
Level (Output Level)	0- +24 dB	Adjusts the output volume.
■ Limiter		
Thres (Threshold Level)	-60-0 dB	Specifies the level (threshold level) at which the limiter will begin to function.
Release (Release Time)	0-127	Specifies the time from when the input level drops below the threshold level until the limiter turns off.
Tone	-50- +50	Adjusts the tonal quality of the limiter.
Level (Output Level)	0- +24 dB	Adjusts the output volume.
Ratio	1.5:1, 2:1, 4:1, 100:1	Specifies the compression ratio.
■ Noise Suppressor		
Threshold (Threshold Level)	-60-0 dB	Specifies the level at which the noise suppressor will begin to operate. When the signal falls below the specified level, it will be muted.
Release (Release Time)	0-127	Specifies the time from when the noise suppressor begins to operate until the volume reaches 0.

Metronome (Metronome Settings)

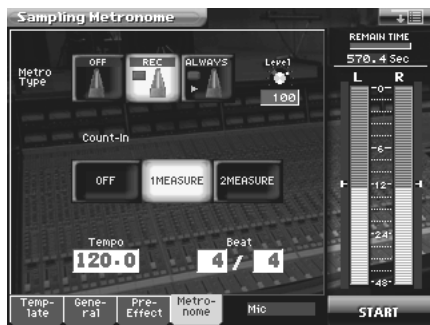

Parameter	Value	Description
Metro Type (Metronome Type)	OFF	The metronome will not sound.
	REC	The metronome will sound only during sampling.
	ALWAYS	The metronome will sound whenever you sample (including while you are making settings in preparation for sampling).
Level (Metronome Level)	0–127	Specifies the volume of the metronome.
Count In * If Trigger Mode is set to other than "MANUAL," this parameter has no effect.	OFF	A count will not be sounded before sampling.
	1MEASURE	A one-measure count will be sounded before sampling.
	2MEASURE	A two-measure count will be sounded before sampling.
Tempo	20.0–250.0	Specifies the tempo of the metronome.
Beat	0–31	Specifies the time signature of the metronome (Numerator). * If you set this to 0, no time signature accent note will be sounded.
	2, 4, 8, 16, 32	Specifies the time signature of the metronome (Denominator).

Template Name (Naming a Template)

A template can be given a name of up to eight characters.

1. Access the Sampling Template screen, and select the sample that you want to name (p. 165).
2. Touch <MENU> in the upper right of the screen.
A pulldown menu appears.



3. In the pulldown menu, touch <Template Name>.
The Sampling Template Name window appears.



4. Touch the on-screen alphabetic or numeric keys to enter the new name in the text box.
The on-screen keys have the following functions.

< << >> >>>	Move the cursor in the text box to the desired input location.
<shift>	Turn this on when you want to input uppercase letters or symbols.
<clear all>	Erases all characters in the text box.
<back space>	Deletes the character that precedes the cursor location.
<delete>	Deletes the character at the cursor location.

5. When you have finished inputting, touch <OK> to finalize the template name.
If you want to return to the original unedited name, touch <EXIT>.

Editing a Sample

When you have finished sampling, you can edit the sample data.

- NOTE** When editing a sample, touching <PREVIEW> will play the sample so you can check whether it was edited as you expect.
- NOTE** When the editing screens are displayed, playing the keyboard will not produce sound.
- NOTE** It is not possible to edit two or more samples simultaneously.
- NOTE** With some exceptions, editing a sample that has been encoded will cause the encoding data to be discarded. In this case, you must encode the data once again (p. 187).
- NOTE** The factory-set waves (preset waves) cannot be edited.

Common Procedure for Editing

Displaying the Sample Edit Screen

1. Press [SAMPLE].
The Sample Top screen appears.



2. Select the sample that you wish to edit.
For details on making this selection, refer to “Sampling Procedure” (p. 165).
3. Touch <Edit>.
The Sample Edit screen appears.

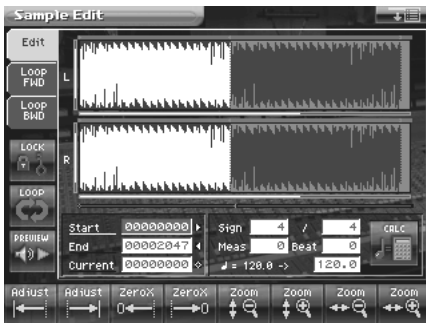

4. Touch one of the tabs in the left side of the screen to access the desired editing screen.

<Edit>: Edit the sample of the specified region (p. 182)

<Loop FWD>: Specify the loop region for forward playback (p. 185)

<Loop BWD>: Specify the loop region for backward playback (p. 185)

cf. For details on each editing operation, refer to the corresponding page.

5. When you have finished making settings, press [EXIT] to return to the Sample Top screen.

Functions Common to All Editing Screens

“Start,” “End,” and “Current” Settings

The V-Synth GT uses seven terms to indicate locations within a sample.

Sample Start	Beginning of the sample
Sample End	End of the sample
Loop Start, Loop End	When the Loop Play is ON, the region between these two points will be played repeatedly.
Edit Start, Edit End	Editing will affect the region between these two points.
Current	This is the currently selected location of the sample.

Move the cursor to “Start,” “End,” or “Current” to select the point that you want to specify. Then specify the location by turning the VALUE dial, by using [INC/+] [DEC/-], or by dragging your finger over the sample in the screen.

MEMO The region of the sample between Edit Start and Edit End is displayed with the color inverted.

MEMO When Current = Loop/Edit Start, moving Loop/Edit Start will cause Current to change as well.

NOTE It is not possible to move Loop/Edit Start to the right of Loop/Edit End.



(LENGTH LOCK)

This locks the length of the region between the start point (Start) and end point (End) of the sample. It is convenient to use this when you already know the length of the sample that you need, and want to find the right region to use.

After the length has been locked, you can turn the VALUE dial, use [INC/+] [DEC/-], or drag your finger over the sample in the screen to adjust the Start and End locations while maintaining the distance between these two points.



You can also use Adjust or Zero Cross Search while the length of the sample is locked.



(LOOP)

This switches loop playback on/off. Turn this on if you want the loop region specified in the Loop FWD/BWD screen to play repeatedly.



(PREVIEW)

This plays the sample. During playback, you can touch this once again to stop playback.



(Adjust)

In the Loop FWD/BWD screen, the Adjust function moves the Loop Start, Loop End, or Current locations to the nearest of the following locations 1–5.

In edit screens, the Adjust function moves the Edit Start, Edit End, or Current locations to the nearest of the following locations 1–7.

1	Sample Start location
2	Sample End location
3	Loop Start location
4	Loop End location
5	Current location
6	Edit Start location
7	Edit End location

Move the cursor to the point that you want to adjust ("Start," "End," or "Current"), and touch or .

Touching will move the point toward the left, and touching will move it toward the right.



In the Sample Encode screen (p. 187), this will move the Current location to the closest event.



For example, if you wish to touch <PREVIEW> to check whether the results of your editing were satisfactory, you can jump the current location.



In some cases nothing may happen, due to the relation between points or the Length Lock setting.





(Zero Cross Search)

This function searches for locations where the sample has a value of zero. When setting loop points or when cutting the sample, you should search for locations where the sample value is zero so that noise is not heard when you play the sample.

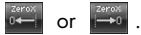
Move the cursor to the point ("Start," "End," or "Current") for which you want to find a zero-cross point, and then touch



Touching  will search toward the left, and touching  will search toward the right.



(Zoom)

This expands or shrinks the displayed sample.

In any screen that displays the sample, you can touch the following buttons to expand or shrink the displayed sample.

 : Shrink vertically

 : Expand vertically

 : Shrink horizontally

 : Expand horizontally

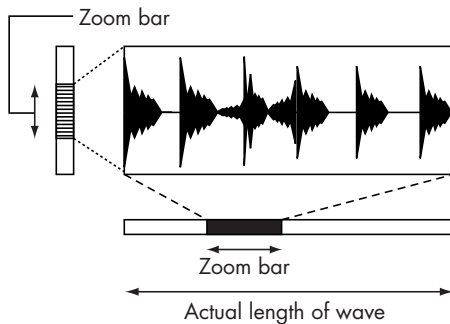

The vertical zoom bar indicates the magnification of the sample in the vertical direction. The horizontal zoom bar indicates the magnification of the sample in the horizontal direction, and shows the current location. As the display is magnified, the zoom bar will become narrower.

Editing the Specified Region of the Sample

You can specify a region of the sample, and edit the region by cutting or copying.

Basic Operation

1. Access the Sample Edit screen (p. 178).
2. Specify the region that you want to edit (Edit Start–Edit End), or the Current location (p. 179).
3. Touch <MENU> in the upper right of the screen.
A pulldown menu appears.



4. In the pulldown menu, touch the editing function that you want to execute.
A window appears, asking you to confirm the operation.

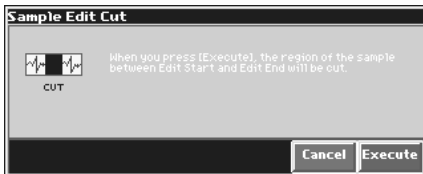

MEMO Some editing functions require you to input a numerical value. For details, refer to the following explanations of each editing function.

5. Touch <EXECUTE> to execute the editing function.



- If you want to cancel without executing, touch <Cancel>.
- By touching "Undo" in the pulldown menu, you can return to the state prior to executing the operation (Undo). Depending on the type of edit function you execute, or on the state of the work area, there may be cases in which the Undo function cannot be executed. In such cases, you will not be able to select <Undo>.

6. If you want to save the edited result, perform the Save operation (p. 191).

Sample Editing Functions

Undo
Cut...
Truncate...
Copy...
Clear...
Paste...
Insert...
Zero Insert...
LR-Mix...
Trim...
Normalize...
Reverse...
Region...

Cut	The region of the sample between Edit Start and Edit End will be cut.
Truncate	The region of the sample between Edit Start and Edit End will be kept, and the remainder of the sample will be deleted.
Copy	The sample between Edit Start and Edit End will be copied.
Clear	The sample between Edit Start and Edit End will be set to values of zero.
Paste	The copied data will be overwritten, beginning at the current location. NOTE If there is any sample data following the current location, it will be lost as far as the pasted portion extends.
Insert	The copied data will be inserted at the current location. TIP You can cut, paste, and insert between different samples. After copying, press [EXIT] to return to the Sample Top screen. Select a different sample, access the Sample Edit screen, and then paste or insert.
Zero Insert	This operation inserts silent space at the current location. It can also be used to lengthen a sample to a precise number of measures and beats. In the Sample Edit Zero Insert window, specify the length of the silent region that you want to insert. This setting is made in terms of a number of samples. Data in the V-Synth GT is handled as 44.1 kHz data, meaning that one second contains 44,100 data samples. TIP For example, if you wish to insert one second of silence, you would specify "44100" and execute Zero Insert. NOTE If the amount of remaining memory is small, it may not be possible to execute Copy, Paste, Insert, or Zero Insert. In such cases, delete unneeded samples from memory (p. 172).
LR-Mix	The stereo sample will be mixed to L, converting it into a monaural sample. If this is set to monaural, less wave memory will be used. This will also decrease the number of voices.
Trim (Trimming)	If the beginning and end of the sample are values other than zero, noise will be heard when you play the sample. Trim sets the values at the beginning and end of the sample to zero. In the Sample Edit Trim window, specify the length that you want to trim. This setting is made in terms of a number of samples. Data in the V-Synth GT is handled as 44.1 kHz data, meaning that one second contains 44,100 data samples. TIP For example, trimming at 100 samples. This will connect the first data sample and the one hundredth data sample by a smooth line of one hundred points. Similarly, the last data sample and the data sample one hundred samples before it will be connected by a smooth line of one hundred points.

Normalize	<p>The Normalize operation is used to uniformly increase or decrease the level of the entire sample without allowing it to distort. This is used when you wish to make the volume consistent with other samples.</p> <p>In the Sample Edit Normalize window, specify the degree of normalization that you want to use. The value is specified in terms of a percentage.</p> <p>TIP</p> <p>For example, let's suppose that 100 is the maximum volume at which the volume does not distort. Executing the Normal operation at a setting of 90% will make the maximum value of the sample be 90.</p> <p>NOTE</p> <p>If you normalize at a low setting and then normalize at a high setting, the audio quality will deteriorate. This means that if you intend to normalize several times, you should start from the higher value and work downward.</p>
Reverse	<p>The sample will be reversed between Edit Start and Edit End. If you want the sample to play backwards, execute Reverse to reverse the sample from the beginning.</p>
Region	<p>The region of the sample between Edit Start and Edit End can be stored in internal memory as a separate sample. The original sample will remain unchanged.</p> <p>Perform the following procedure.</p> <ol style="list-style-type: none">1. Select the region that you want to extract as a separate sample, and execute Region.2. In the Sample Edit Region window, select the sample number to which you want to paste the extracted region of the sample, and touch <OK>.3. Assign a name to the new sample, and touch <OK>. <p>MEMO</p> <p>If in step 2 you select a sample number that already has a sample, the sample data between Edit Start and Edit End will be added to the end of the selected sample.</p>

Loop Region Settings

When the loop switch (p. 180) is ON, you can specify the region that will be played back as a loop. The region of the sample between Loop Start and Loop End will be played back repeatedly.

In the Sample Loop FWD screen that appears when you touch <Loop FWD>, specify the loop region for forward playback. In the Sample Loop BWD screen that appears when you touch <Loop BWD>, specify the loop region for backward playback.

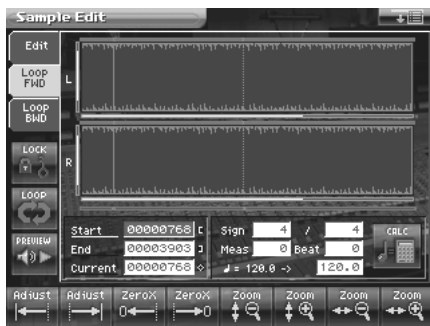

Immediately after sampling or loading a sample, Loop Start will be set to the beginning of the sample and Loop End to the end of the sample.

If you set Loop Start and Loop End to locations within the sample, the sample will play back from the beginning, and then the region between Loop Start and Loop End will play back repeatedly.

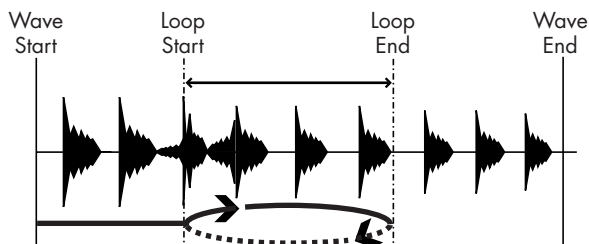

MEMO The data in the V-Synth GT is handled as 44.1 kHz data, which means there are 44,100 data samples per second. The shortest possible loop that can be set is 16 data samples.

NOTE Loop range settings are ignored when the Playback Mode (p. 99) is set to "STEP" or "EVENT."

Original Tempo Setting

The Original Tempo is the reference tempo of the sample used when synchronizing it to the master tempo.

Example: A sample whose original tempo is 100

If the master tempo is set to 200 and the sample is synchronized, the sample will play back at double the speed at which it was recorded. If you set the master tempo to 50 and synchronize the sample, it will play back at half the speed at which it was recorded.



The exact original tempo can be calculated from the time signature, number of measures, and number of beats for the sample length between Loop Start and Loop End. This means that you must first specify the loop region, and then set the original tempo.

NOTE If you wish to play back a loop while simultaneously synchronizing another sample, you must specify the correct original tempo. If you fail to do this, the sounds will drift out of synchronization.

1. Move the cursor to the item that you wish to set.
2. Either turn the VALUE dial or press [INC/+] [DEC/-] to set the "Sign" (time signature), "Meas" (measure), and Beat values.
3. Touch  .

The precise tempo will be displayed at the right of the "→." The tempo displayed here is the original tempo.

TIP You can also move the cursor to the original tempo, and set it by rotating the VALUE dial or by using [INC/+] [DEC/-].

Encode (Converting the Sample to V-Synth GT Data)

After you have finished editing the sample, you should encode it. By using the encoding that is appropriate for the sample, you'll be able to maintain a higher quality of audio while controlling the pitch, time, and formant.

NOTE The factory-set waves (preset waves) cannot be encoded.

Displaying the Encode Screen

NOTE Samples whose wave is too short (0.1 sec or less) cannot be encoded, and the Sample Encode screen cannot be accessed for such samples.

1. Press [SAMPLE].

The Sample Top screen appears.



2. Select the sample number that you wish to encode.

For details on how to select a sample, refer to “Sampling Procedure” (p. 165).

3. Touch <Encode>.

The Sample Encode screen appears.



To Execute the Encode Operation

In the Sample Encode screen, select the encode type, set the encode depth, and delete or add events. Then touch <Execute>. If you wish to stop the encode during the operation, touch <Abort>.

When encoding is completed, you will return to the Sample Top screen.

cf. For details on these settings, refer to the following sections.

MEMO The amount of time required by the encoding process will depend on the sample. You may need to wait a certain amount of time for encoding to be completed.

Selecting the Encoding Type

You can choose from the following four types of encoding. Touch the appropriate button to select a type.



LITE	This is the simplest encoding type. When you sample on the V-Synth GT, this type is selected by default. This type can be used with a variety of sounds, but to obtain the highest quality we recommend that you encode using one of the other types.
SOLO	This is suitable for monophonic vocals or monophonic wind instruments (such as sax, trumpet, or flute). If you encode the sample using this type, you will be able to control the formant (p. 112) and use the robot voice function (p. 99). Even if you encode using SOLO, you can still play the sample polyphonically.
BACKING	This is suitable for decay-type instruments. It is particularly suitable for phrases that include instruments with a clear attack (such as drums, percussion, and guitar chords).
ENSEMBLE	This is suitable for sustain-type instruments. It is particularly suitable when there are smooth changes in tone (such as choir or strings).

NOTE

- If the data is encoded using "BACKING" or "ENSEMBLE," it will not be possible to use the formant control or robot voice functions.
- Once a sample has been encoded, editing that sample (except for some operations) will cause the encoded data to be discarded. If you then access the Sample Encode screen in this state, "LITE" will always be selected as the encoding type. Select the appropriate encoding type, and then re-encode the sample.
- Depending on the sample, encoding with "SOLO" may cause the sound to be different than you expect, such as changes in pitch being incorrect by one octave. If this occurs, re-encode the sample using "BACKING" or "ENSEMBLE."
- If a sample that contains large amounts of reverb or delay is encoded using "SOLO," it may not sound as you expect. If this occurs, re-encode the sample using "BACKING" or "ENSEMBLE."

Automatically Detecting Events

By specifying the Depth, you can automatically detect and “▼” mark locations where there is a strong attack (i.e., locations where the volume changes abruptly). Such marked locations are called events.



Parameter	Value	Description
Depth (Encode Depth)	0-127	<p>In the Sample Encode screen, move the cursor to “Depth” and set the value. The higher the value you set, the more events will be assigned.</p>  <p>MEMO If the Playback Mode (p. 99) is “STEP,” the sample will play to the next event, and then stop each time you play the key. When the Playback Mode is set to “EVENT,” the sample will be divided at event locations, and assigned to each key.</p> <p>cf. ➤</p> <ul style="list-style-type: none"> • If you set Depth to a high value, a large number of events may be detected. If you encode in such a state, the interval between events will be too short, and the expected result will not be obtained when you play back in event units. • If you change the location of an event after encoding, you must re-encode the sample. When you encode, the newly detected event locations will take effect.

Deleting and Adding Events

Setting the Encode Depth and automatically detecting events does not guarantee that the events will be added at the locations that you expect. If necessary, you can delete or add events as you like.



In the Sample Encode screen, you can touch <PREVIEW> to play the sample from the current location until the next event.

By touching <PREVIEW>, you can play the sample to see whether events have been assigned to the locations that you expect.

NOTE Be aware that if you change the encode depth after deleting or adding events, the events that were modified manually will be discarded, and the events that were detected by depth will be displayed.

NOTE If you modify the location of events after encoding, you must re-encode. The modified location of the events will take effect when you encode.

Deleting an Event

1. Move the cursor to "Current."
2. By turning the VALUE dial, pressing [INC/+] [DEC/-], or dragging your finger over the sample in the screen, set Current to the location of the event that you want to delete.
3. Touch either  or  .
The Current location will move to the location of the next event toward the left or right.
4. Repeat step 3 to move Current to the location of the event that you wish to delete.
5. Touch  to delete the event.

NOTE The events at the beginning and end of a sample cannot be deleted.

Adding an Event

1. Move the cursor to "Current."
2. By turning the VALUE dial, pressing [INC/+] [DEC/-], or dragging your finger over the sample in the screen, move Current to the location at which you want to add the event.
3. Touch  to add the event.

Saving a Sample

Samples that you sample or encode will be lost when you turn off the power. If you want to keep these samples, use the Save Project screen in the Utility Menu.

When you edit the settings of a sample, an asterisk (*) will appear at the left of the sample name in the Sample Browser screen. When you save the sample to internal memory or USB memory, the asterisk (*) will disappear.

1. Access the Sample Top screen (p. 165).

2. Touch <Save>.

Jump to the Save Project screen in the Utility Menu.



For details on operations in this screen, refer to “**Save Project (Saving a Project)**” (p. 217).

Checking Sample Information

1. Access the Sample Top screen (p. 165).
2. Touch <Info>.
The Sample Information screen appears.



In the Sample Information screen you can check the following information for the sample.

- Encode type (p. 188)
- Sampling type (p. 174)
- Loop point location (Loop Start, Loop End) (p. 185)
- Time signature (p. 186)
- Original tempo (p. 186)
- Original pitch
- Original fine tune

MEMO Original Tempo, Original Pitch, and Original Fine Tune can be modified in this screen.

NOTE If you want to set an accurate original tempo, make settings in the sample editing screen (p. 186).

Parameter	Value	Description
Original Pitch	C-1 (0)– G9 (127)	Specifies the key that will play the sample at the pitch at which it was sampled.
Original Fine Tune	-50– +50	Adjusts the current pitch in one-cent steps (1/100 of a semitone) over a range of 1/2 semitone upward or downward.
LOOP MODE	One Shot	The sample will not loop, regardless of the Loop Switch (p. 99) setting of the patch.
	One Way	If the Loop Switch (p. 99) of the patch is on, the sample will loop in the forward direction between “LOOP START” and “LOOP END.”
	Alternate	If the Loop Switch (p. 99) of the patch is on, the sample will loop alternately backward and forward between the “LOOP START” and “LOOP END.”

3. When you have finished viewing the information, touch <OK> to close the window.

System Mode (Settings Common to All Modes)

Settings that affect the entire operating environment of the V-Synth GT, such as tuning and MIDI message reception, are referred to as system functions. This section explains how to make settings for the System functions and describes the functions of the different System parameters.

How to Make the System Function Settings

1. Press [SYSTEM].

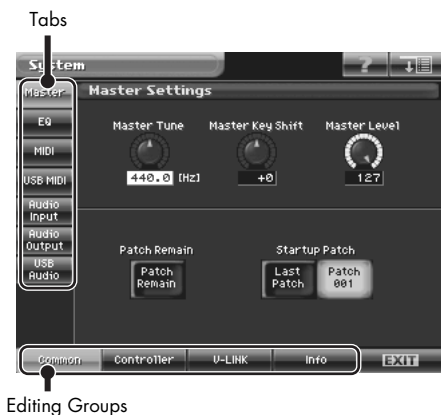

- 2. The parameters are organized into several editing groups. Touch one of the buttons at the bottom of the screen to select the edit group containing the parameters you want to set.**
- 3. Touch one of the tabs in the left of the screen to select the desired editing screen.**
- 4. Touch the various screens in which settings are made to edit the parameters.**

Move the cursor to the value box of the parameter you want to edit, and perform any of the following actions.

 - Turn the VALUE dial
 - Press [INC/+] or [DEC/-]
 - Drag your fingertip on the touch panel
- 5. Changes you make to the System function settings are only temporary—they will be discarded as soon as the power is turned off. If you want to keep any changes you've made in the system settings, you must save them in internal memory (p. 194).**

System Menu

System Write (Saving the System Settings)

Changes you make to the System function settings are only temporary—they will be discarded as soon as the power is turned off. If you want to keep any changes you've made in the system settings, you must save them in internal memory.

NOTE When you perform the save procedure, the data that previously occupied the save destination will be lost. However, the factory setting data can be recovered by performing the Initialization procedure.

1. **After you have edited the settings of the System function, touch <MENU>, located in the upper right of the screen.** A pulldown menu appears.



2. **In the pulldown menu, touch <System Write>.** A window like the following will appear.



3. **Touch <OK>.** The system settings will be saved, and you'll be returned to the Patch Edit screen.

System Init (Initializing the System Settings)

The current settings of the system functions can be restored to the factory settings.

1. Touch **<MENU>**, located in the upper right of the screen.

A pulldown menu appears.



2. In the pulldown menu, touch **<System Init>**.

A window like the following will appear.



3. Touch **<OK>**.



If you want the factory settings to be in effect the next time the V-Synth GT is powered up, touch **<Write>** to save the settings.

Common (Settings Common to the Entire System)

Master



Parameter	Value	Description
Master Tune	415.3–466.2 Hz	Adjusts the overall tuning of the V-Synth GT. The display shows the frequency of the A4 note (center A).
Master Key Shift	-24– +24	Shifts the overall pitch of the V-Synth GT in semitone steps.
Master Level	0–127	Adjusts the volume of the entire V-Synth GT.
Patch Remain (Patch Remain Switch)	OFF, ON	<p>Specifies whether currently sounding notes will continue sounding when another patch is selected (ON), or not (OFF).</p> <p>* This function is valid only when the effect is turned off.</p> <p>Also, when this is "ON," changes produced by incoming MIDI messages such as Volume (CC 7) or Pan (CC 10), as well as tonal quality and volume changes produced by the various controllers will be inherited.</p> <p>NOTE If you're using AP-Synthesis, the sound will be interrupted when you switch patches, even if the Patch Remain Switch is ON.</p>
Startup Patch	Last Patch	When the power is turned on, the V-Synth GT reinstates the patch selected at the time the V-Synth GT was last turned off.
	Patch 001	When the power is turned on, the V-Synth GT will be ready to play Patch "001."

EQ

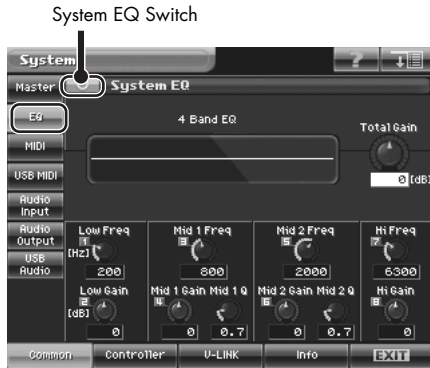

Parameter	Value	Description
System EQ Switch	OFF, ON	Switches the System EQ on/off.
Total Gain	-15- +15 dB	Adjusts the total gain.
Low Freq (Low Frequency)	50, 63, 80, 100, 125, 160, 200, 250, 315, 400, 500, 630, 800, 1000, 1250, 1600, 2000, 2500, 3150, 4000 Hz	Selects the frequency of the low range.
Low Gain	-15- +15 dB	Adjusts the gain of the low frequency. Positive (+) settings will emphasize the low-frequency range.
Mid 1 Freq (Mid 1 Frequency)	50, 63, 80, 100, 125, 160, 200, 250, 315, 400, 500, 630, 800, 1000, 1250, 1600, 2000, 2500, 3150, 4000, 5000, 6300, 8000, 10000, 12500, 16000, 20000 Hz	Selects the frequency of the middle range 1.
Mid 1 Gain	-15- +15 dB	Adjusts the gain of the middle range 1. Positive (+) settings will emphasize the middle range 1.
Mid 1 Q	0.5, 0.7, 1.0, 2.0, 4.0, 8.0	Adjusts the width of the middle range 1. Set a higher value for Q to narrow the range to be affected.
Mid 2 Freq (Mid 2 Frequency)	50, 63, 80, 100, 125, 160, 200, 250, 315, 400, 500, 630, 800, 1000, 1250, 1600, 2000, 2500, 3150, 4000, 5000, 6300, 8000, 10000, 12500, 16000, 20000 Hz	Selects the frequency of the middle range 2.
Mid 2 Gain	-15- +15 dB	Adjusts the gain of the middle range 2. Positive (+) settings will emphasize the middle range 2.
Mid 2 Q	0.5, 0.7, 1.0, 2.0, 4.0, 8.0	Adjusts the width of the middle range 2. Set a higher value for Q to narrow the range to be affected.
Hi Freq (High Frequency)	2000, 4000, 5000, 6300, 8000, 10000, 12500, 16000, 20000 Hz	Selects the frequency of the high range.
Hi Gain (High Gain)	-15- +15 dB	Adjusts the gain of the high frequency. Positive (+) settings will emphasize the high-frequency range.

MIDI



Parameter	Value	Description
Device ID (Device ID Number)	17–32	When you want to transmit or receive System Exclusive messages, set this parameter to match the Device ID number of the other MIDI device.
Clock Source	INT	The LFO frequency or Tone-FX change will synchronize to the patch tempo.
	MIDI	The LFO frequency or Tone-FX change will synchronize to the external MIDI clock.
	USB MIDI	The LFO frequency or Tone-FX change will synchronize to the external USB MIDI clock.
Receive MIDI Ch (Receive MIDI Channel)	1–16	Specifies the MIDI receive channel.
Receive Sw	OFF, ON	Specifies whether MIDI messages will be received (ON) or not received (OFF).
Program Change (Receive Program Change Switch)	OFF, ON	Specifies whether Program Change messages will be received (ON) or not (OFF).
Bank Select (Receive Bank Select Switch)	OFF, ON	Specifies whether Bank Select messages will be received (ON) or not (OFF).
System Ex (Receive System Exclusive Switch)	OFF, ON	Specifies whether System Exclusive messages will be received (ON) or not (OFF).
Transmit MIDI Ch (Transmit MIDI Channel)	1–16, RX CH, OFF	Specifies the transmit channel of MIDI messages. If you do not want to transmit MIDI messages to external MIDI devices, turn this parameter “OFF.” If you want the transmit channel to always match the Receive MIDI Channel, set this parameter to “RX CH.”
Program Change (Transmit Program Change Switch)	OFF, ON	Specifies whether Program Change messages will be transmitted (ON) or not (OFF).
Bank Select (Transmit Bank Select Switch)	OFF, ON	Specifies whether Bank Select messages will be transmitted (ON) or not (OFF).
Active Sens (Transmit Active Sensing Switch)	OFF, ON	Specifies whether Active Sensing messages will be transmitted (ON) or not (OFF).
Edit Data (Transmit Edit Data Switch)	OFF, ON	Specify whether changes you make in the settings of a patch will be transmitted as system exclusive messages (ON), or will not be transmitted (OFF).
Clock Out	OFF, ON	Specifies whether MIDI clock will be transmitted (ON) or not (OFF).

USB MIDI



Parameter	Value	Description
USB-MIDI Thru Switch	OFF, ON	Specifies whether MIDI messages received at the USB connector or MIDI IN connector when using MIDI via the USB connection will be retransmitted without change from the MIDI OUT connector or USB connector (ON), or will not be retransmitted (OFF).
		<div style="display: flex; justify-content: space-around;"> <div style="text-align: center;"> <p>USB-MIDI Thru Switch = OFF</p> </div> <div style="text-align: center;"> <p>USB-MIDI Thru Switch = ON</p> </div> </div>

Audio Input

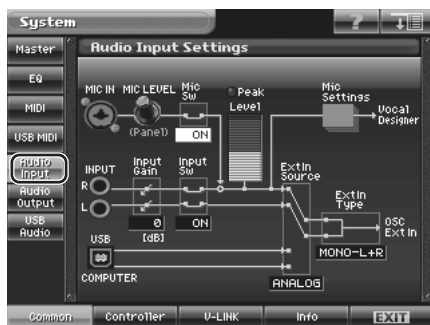

Parameter	Value	Description
Mic Sw (MIC Jack Switch)	ON, OFF	Specifies whether the rear panel MIC IN jack will be enabled (ON) or disabled (OFF).
Peak		This will light when the input volume is excessive.
Level		Indicates the input volume.
Input Gain (INPUT Jack Gain)	0dB, +10dB	Sets the gain of the rear panel INPUT jacks.
Input Sw (INPUT Jack Switch)	ON, OFF	Specifies whether the rear panel INPUT jacks will be enabled (ON) or disabled (OFF).
Ext In Source (External Input Source)	ANALOG USB	The MIC IN jack or INPUT jacks will be the input source. The USB audio from a computer connected to the V-Synth GT will be the input source.
Ext In Type (External Input Type)	STEREO MONO-L+R MONO-L MONO-R	Inputs in stereo. Mixes the L and R input signals and inputs in monaural. Inputs the L signal in monaural. Inputs the R signal in monaural.

Audio Output

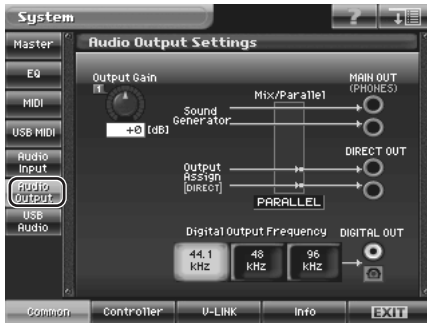

Parameter	Value	Description
Output Gain	-12- +12 dB	This adjusts the output gain from the V-Synth GT's Analog Out and Digital Out. When, for example, there are relatively few voices being sounded, boosting the output gain can let you attain the most suitable output level for recording and other purposes.
Mix/Parallel Specifies how the sound of the entire V-Synth GT will be output.	MIX	Set this to have the collective output of all sounds output from the MAIN OUT jacks. When you want to check the final overall sound being output, set to MIX. TIP Sounds output from the PHONES jack are the same as those output from the MAIN OUT jacks. Therefore, any sounds set with Output Assign to be output from the DIRECT OUT jacks is not output from the PHONES jack. Be sure to have any sound you want to hear through the headphones set to "MIX."
	PARALLEL	Outputs according to each Output Assign settings.
Digital Output Frequency	44.1, 48, 96 kHz	Sets the sampling frequency of the digital output. TIP Sounds output from the V-Synth GT's Digital Out are the same as those output from the MAIN OUT jacks.

USB Audio

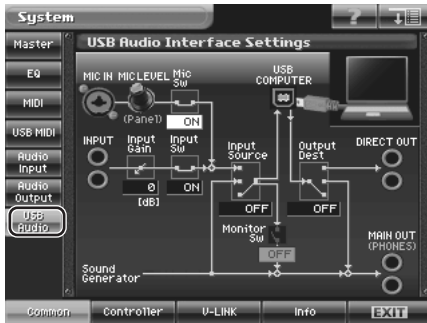

Parameter	Value	Description
Mic Sw (MIC Jack Switch)	ON, OFF	Specifies whether the rear panel MIC IN jack will be enabled (ON) or disabled (OFF).
Input Gain (Input Jack Gain)	0dB, +10dB	Sets the gain of the rear panel INPUT jacks.
Input Sw (Input Jack Switch)	ON, OFF	Specifies whether the rear panel INPUT jacks will be enabled (ON) or disabled (OFF).
Input Source (USB Audio Input Source)	OFF, MAIN, ANALOG	When the V-Synth GT is connected via USB to your computer, this specifies the source of the USB audio that will be output to the computer.
Monitor Sw (USB Audio Input Monitor Sw)	ON, OFF	Specifies whether USB Audio Input Source monitoring will be sent from the V-Synth GT's MAIN OUT (ON) or will not be sent (OFF).
Output Dest (USB Audio Output Destination)	OFF, MAIN, DIR	When the V-Synth GT is connected via USB to your computer, this specifies the output destination of the USB audio that is received from the computer.

Controller (Controller-related Settings)

Keyboard



Parameter	Value	Description
Keyboard Sens (Keyboard Sensitivity)	Light	Sets the keyboard sensitivity to "light."
	Medium	Sets the keyboard sensitivity to "normal."
	Heavy	Sets the keyboard sensitivity to "heavy."
Keyboard Velocity	REAL, 1–127	Specifies the velocity value that will be transmitted when you play the keyboard. If you want actual keyboard velocity to be transmitted, set this to "REAL." If you want a fixed velocity value to be transmitted regardless of how you play, specify the desired value (1–127).
Aftertouch Sens (Aftertouch Sensitivity)	0–200	Specifies the Aftertouch sensitivity. Higher values will allow Aftertouch to be applied more easily. Normally you will leave this at "100."
Local Sw (Local Switch)	OFF, ON	The Local Switch determines whether the internal sound generator is disconnected (OFF) from the controller section (keyboard, pitch bend/modulation lever, knobs, buttons, Time Trip Pad, D Beam controller, pedal, and so on); or not disconnected (ON). Normally this is left "ON," but if you wish to use the V-Synth GT's keyboard and controllers to control only external sound modules, set it to "OFF."

Time Trip Pad



Parameter	Value	Description
X Assign-XY	OFF	No message will be transmitted.
	CC01-31, 33-95 (Controller numbers 1-31, 33-95)	Specifies the MIDI controller number that will be transmitted by movements in the 'X' (horizontal) direction when the Time Trip pad is in XY mode.
X Assign-TT (X Assign-Time Trip)	OFF	No message will be transmitted.
	CC01-31, 33-95 (Controller numbers 1-31, 33-95)	Specifies the MIDI controller number that will be transmitted by movements in the 'X' (horizontal) direction when the Time Trip pad is in Time Trip mode.
Y Assign-XY	OFF	No message will be transmitted.
	CC01-31, 33-95 (Controller numbers 1-31, 33-95)	Specifies the MIDI controller number that will be transmitted by movements in the 'Y' (vertical) direction when the Time Trip pad is in XY mode.
Y Assign-TT (Y Assign-Time Trip)	OFF	No message will be transmitted.
	CC01-31, 33-95 (Controller numbers 1-31, 33-95)	Specifies the MIDI controller number that will be transmitted by movements in the 'Y' (vertical) direction when the Time Trip pad is in Time Trip mode.

D-Beam



Parameter	Value	Description
Beam Sens L, R (D Beam Sensitivity L, R)	0–200	This sets the D Beam Controller's sensitivity. Sens L is the left side, and Sens R is the right side. Increasing this value will make the D Beam controller more sensitive. Normally you will leave this at "100."
1–4 Assign L, R (D Beam 1–4 Assign L, R)	OFF CC01–31, 33–95	No message will be transmitted. Controller numbers 1–31, 33–95

Specifies the MIDI controller number that will be transmitted by movements in the D Beam Controller. Assign L is the left side, and Assign R is the right side.

C1/C2 Knob



Parameter	Value	Description
C1, 2 Knob Assign	OFF	No message will be transmitted.
	CC01–31, 33–95 (Controller numbers 1–31, 33–95)	Specifies the MIDI controller number that will be transmitted by movements in the ASSIGNABLE CONTROL knob.

S1/S2 Switch



Parameter	Value	Description
S1, 2 Switch Assign	OFF	No message will be transmitted.
	CC01–31, 33–95 (Controller numbers 1–31, 33–95)	Specifies the MIDI controller number that will be transmitted when you press the S1 or S2 switches.

Pedal



Parameter	Value	Description
Hold Polarity (Hold Pedal Polarity)	Standard, Reverse	Selects the polarity of the Hold pedal. On some pedals, the electrical signal output by the pedal when it is pressed or released is the opposite of other pedals. If your pedal has an effect opposite of what you expect, set this parameter to "Reverse." If you are using a Roland pedal (that has no polarity switch), set this parameter to "Standard."
Pedal 1, 2 Assign This specifies the function of each pedal connected to the CTRL 1, CTRL 2 PEDAL jacks.	OFF CC01–31, 33–95 BEND UP BEND DOWN AFT VALUE INC	The control pedal will not be used. Controller numbers 1–31, 33–95 Pitch bend (positive direction) Pitch bend (negative direction) Aftertouch The pedal will perform the same operation as pressing [INC/+]. This is convenient when you want to switch patches or tones while performing.
Pedal 1, 2 Polarity	Standard, Reverse	Selects the polarity of the pedal. On some pedals, the electrical signal output by the pedal when it is pressed or released is the opposite of other pedals. If your pedal has an effect opposite of what you expect, set this parameter to "Reverse." If you are using a Roland pedal (that has no polarity switch), set this parameter to "Standard."

V-LINK Settings

Tx



Parameter	Value	Description
V-LINK MIDI Channel	1-16	Specifies the channel used to transmit MIDI messages for V-LINK control.
V-LINK Audio Sw (V-LINK Audio Switch)	OFF, ON	Specifies whether sound from the externally connected video device will be played (ON) or not played (OFF).
Keyboard Output Fade Sw (V-LINK Keyboard Output Fade Switch)	OFF, ON	Specifies whether the video output from the video device will be stopped (ON) or will not be stopped (OFF) when you are not holding down a key.
Patch Palette Local Sw (V-LINK Patch Palette Local Switch)	OFF, ON	Specify whether you will press PATCH PALETTE [1]-[8] in V-LINK mode to switch patches (ON) or not (OFF).

Time Trip Pad



Parameter	Value	Description
Time Trip Pad Local Sw (V-LINK Time Trip Pad Local Switch)	OFF, ON	Specifies whether the Time Trip pad and the internal sound generator will be disconnected in V-LINK mode (OFF) or not disconnected (ON).
X Assign-XY (V-LINK X Assign-XY) Specify the V-LINK function that will be controlled when you operate the Time Trip pad in the X (horizontal) direction in XY mode. Y Assign-XY (V-LINK Y Assign-XY) Specify the V-LINK function that will be controlled when you operate the Time Trip pad in the Y (vertical) direction in XY mode.	OFF	The time trip pad will not be used.
	PLAYBACK-SPEED	Playback speed
	DISSOLVE-TIME	Dissolve time (time over which the image switches)
	AUDIO LEVEL	Volume during audio playback
	COLOR-CB	Color Cb (color-difference signal)
	COLOR-CR	Color Cr (color-difference signal)
	BRIGHTNESS	Brightness
	VFX1	Visual effects 1
	VFX2	Visual effects 2
	VFX3	Visual effects 3
	VFX4	Visual effects 4
	OUTPUT-FADE	Output fade
	T-BAR	T bar
Assign-Time Trip (V-LINK Assign-Time Trip) Specify the V-LINK function that will be controlled when you operate the Time Trip pad in Time Trip mode.	OFF	The time trip pad will not be used.
	TIME-TRIP	Time trip

D Beam



Parameter	Value	Description
D Beam Local Sw (V-LINK D Beam Local Switch)	OFF, ON	Specifies whether the D Beam controller will be disconnected from the internal sound generator in V-LINK mode (OFF) or not disconnected (ON).
1-4 Assign L, R (V-LINK D Beam 1-4 Assign L, R)	OFF	The D Beam controller will not be used.
Specify the V-LINK function that will be controlled when you operate the D Beam controller. Assign L is the left side, and Assign R is the right side.	PLAYBACK-SPEED	Playback speed
	DISSOLVE-TIME	Dissolve time (time over which the image switches)
	AUDIO LEVEL	Volume during audio playback
	COLOR-CB	Color Cb (color-difference signal)
	COLOR-CR	Color Cr (color-difference signal)
	BRIGHTNESS	Brightness
	VFX1	Visual effects 1
	VFX2	Visual effects 2
	VFX3	Visual effects 3
VFX4	Visual effects 4	
OUTPUT-FADE	Output fade	

C1/C2 Knob



Parameter	Value	Description
C1, 2 Knob Local Sw (V-LINK Knob1, 2 Local Switch)	OFF, ON	Specify whether the assignable controller knobs 1 or 2 will be disconnected from the internal sound generator in V-LINK mode (OFF) or not disconnected (ON).
C1, 2 Knob Assign (V-LINK Knob1, 2 Assign) Specify the V-LINK function that will be controlled when you turn the ASSIGNABLE CONTROL knob.	OFF	The assignable controller will not be used.
	PLAYBACK-SPEED	Playback speed
	DISSOLVE-TIME	Dissolve time (time over which the image switches)
	AUDIO LEVEL	Volume during audio playback
	COLOR-CB	Color Cb (color-difference signal)
	COLOR-CR	Color Cr (color-difference signal)
	BRIGHTNESS	Brightness
	VFX1	Visual effects 1
	VFX2	Visual effects 2
VFX3	Visual effects 3	
VFX4	Visual effects 4	
OUTPUT-FADE	Output fade	

Bender

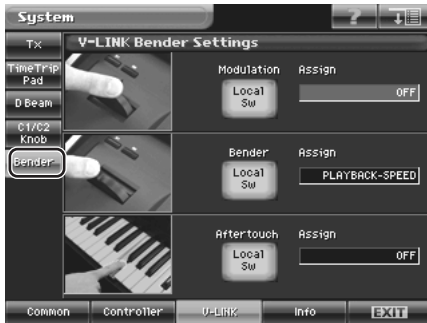

Parameter	Value	Description
Modulation Local Sw (V-LINK Modulation Local Switch)	OFF, ON	Specifies whether the modulation lever will be disconnected from the internal sound generator in V-LINK mode (OFF) or not disconnected (ON).
Bender Local Sw (V-LINK Pitch Bend Local Switch)	OFF, ON	Specifies whether the pitch bend lever will be disconnected from the internal sound generator in V-LINK mode (OFF) or not disconnected (ON).
Aftertouch Local Sw (V-LINK Aftertouch Local Switch)	OFF, ON	Specifies whether keyboard aftertouch will be disconnected from the internal sound generator in V-LINK Mode (OFF) or will not be disconnected (ON).
Modulation Assign (V-LINK Modulation Assign) Specify the V-LINK function that will be controlled when you operate the modulation lever.	OFF	The modulation lever/pitch bend lever/keyboard aftertouch will not be used.
	PLAYBACK-SPEED	Playback speed
	DISSOLVE-TIME	Dissolve time (time over which the image switches)
	AUDIO LEVEL	Volume during audio playback
	COLOR-CB	Color Cb (color-difference signal)
	COLOR-CR	Color Cr (color-difference signal)
	BRIGHTNESS	Brightness
	VFX1	Visual effects 1
	VFX2	Visual effects 2
	VFX3	Visual effects 3
Bender Assign (V-LINK Pitch Bend Assign) Specify the V-LINK function that will be controlled when you operate the pitch bend lever.	VFX4	Visual effects 4
	OUTPUT-FADE	Output fade
Aftertouch Assign (V-LINK Aftertouch Assign) Specify the V-LINK function that will be controlled by keyboard aftertouch.		

Info (Viewing Various Information)

Version (Checking the Version)

Here you can check the V-Synth GT's program version.



Features (Checking the Functions)

Here you can view a screen that introduces the functionality of the V-Synth GT.



Utility Mode

Utility mode provides various functions for your convenience when using the V-Synth GT. Press [UTILITY] to access the Utility Menu screen, then select and carry out the desired function.



- Project (Project-related Settings) p. 215
- USB Storage (Exchanging Files with Your Computer) p. 221
- Beep (Beep Tone Settings) p. 227
- E1-E8 Knobs (E1-E8 knob Settings) p. 228
- Screen Saver p. 229
- Wallpaper (Changing the Wallpaper) p. 230
- Calibration (Adjusting the Controllers) p. 231
- Format (Initializing Internal Memory or USB Memory) p. 234
- Factory Reset (Reset to Default Factory Settings) p. 235

Project (Project-related Settings)

You can load a project from USB memory into the V-Synth GT's temporary area, or save the project that's in the temporary area.

Load Project (Loading a Project into the V-Synth GT)

This operation will load a project from internal memory or USB memory into the V-Synth GT's temporary area.

NOTE When you load a project, the temporary area will be rewritten. If the temporary area contains data that you want to keep, store it to USB memory before you load other data.

1. Press [UTILITY] to access the Utility Menu screen.

2. Touch <Project>.

The Project Menu screen appears.



3. Touch <Load Project>.

The Load Project screen appears.



4. To load from internal memory, touch <Int>. To load from a USB memory, touch <USB>. Then select the project that you want to load.

5. Touch <OK>.

A Warning window like the following appears.



TIP If you want to cancel the procedure at this point, touch <EXIT>.

6. Touch <OK> to execute the operation.

NOTE It will take several minutes for the project to be loaded.

7. When <Completed!> is displayed, loading is finished.

Touch <OK> to return to the Patch Play screen.

Save Project (Saving a Project)

This operation saves the project from the temporary area into internal memory or USB memory.

1. Press [UTILITY] to access the Utility Menu screen.

2. Touch <Project>.

The Project Menu screen appears.



3. Touch <Save Project>.

The Save Project screen appears.

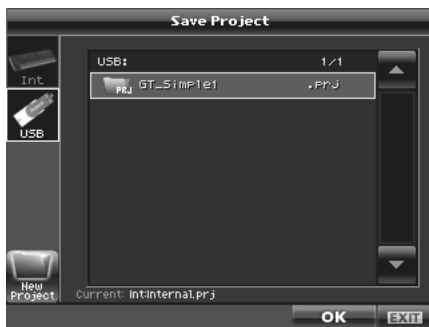

4. To save to internal memory, touch <Int>. To save to USB memory, touch <USB>. Then select the save-destination project.



If you want to save the data as a new project, touch <New Project>. The Project Name window will appear. Assign a name to the new project.

5. Touch <OK>.

A Warning window like the following appears.



TIP If you want to cancel the procedure at this point, touch <EXIT>.

6. Touch <OK> to execute the operation.

NOTE It will take several minutes for the project to be saved.

7. When <Completed!> is displayed, saving is finished.

Touch <OK> to return to the Patch Play screen.

Convert Project (Convert a Project)

This operation will convert (import) a V-Synth Version 2.0 or V-Synth XT project for use with your V-Synth GT.

1. Using your computer, create a folder named "XT" on your USB memory device.
2. Copy the V-Synth Version 2.0 or V-Synth XT project to the "XT" folder on the USB memory device, and connect it to the V-Synth GT's USB MEMORY connector.
3. Press [UTILITY] to access the Utility Menu screen.
4. Touch <Project>.
The Project Menu screen appears.



5. Touch <Convert Project>.
The Convert Project screen appears.

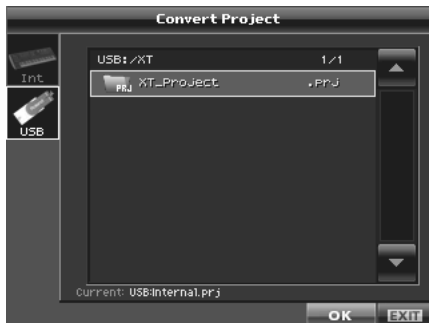

6. Touch the V-Synth Version 2.0 or V-Synth XT project in USB memory to select it.

7. Touch <OK>.

A Warning window like the following appears.

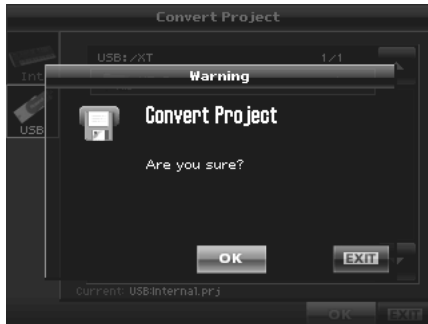

TIP If you want to cancel the procedure at this point, touch <EXIT>.

8. Touch <OK> to execute the operation.

NOTE It will take several minutes for the project to be converted.

USB Storage (Exchanging Files with Your Computer)

By connecting the V-Synth GT to your computer via a USB cable, you can save (back up) projects and other files such as individual patches, waves, and data from internal memory to the hard disk of your computer.

Using software on your computer, you can also edit wave data you've created on the V-Synth GT. Conversely, wave data created on your computer can be used by the V-Synth GT.

NOTE Never turn off the power or disconnect or reconnect the USB cable while using the USB Storage function to transfer data.

As appropriate for the computer you're using, please read “**Windows Users**” (p. 221) or “**Mac Users**” (p. 223).

Windows Users

Connecting the V-Synth GT to Your Computer

1. Make sure that the power of the V-Synth GT is turned off.
2. Start up your computer.
3. Connect the V-Synth GT and your computer using a USB cable.

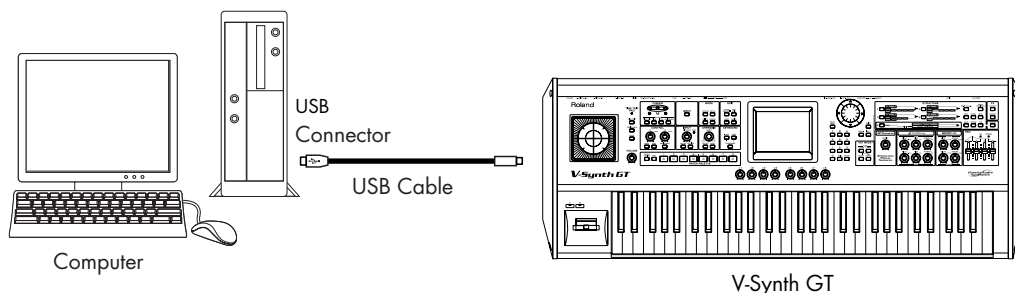

4. Turn on the power of V-Synth GT.

5. Touch <USB Storage> in the Utility Menu screen.

The USB Storage screen appears.



6. Touch <Mount the Internal Memory> to establish the connection with your computer.

7. When the USB connection is established, the driver installation will begin. A dialog box of "Found new hardware" will appear near the Windows task tray.

Installation is completely automatic. Please wait for it to be completed.

8. When installation is completed, open My Computer and you will see a new drive icon.

9. Once the V-Synth GT is connected, you can transfer files by operating your computer.

Disconnecting USB Storage

1. Use the device eject button shown in the taskbar at the lower right of your computer screen to cancel the connection with the V-Synth GT.

2. Press [EXIT].

The USB storage will be disconnected.

Mac Users

Connecting the V-Synth GT to Your Computer

1. Make sure that the power of the V-Synth GT is turned off.
2. Start up your computer.
3. Connect the V-Synth GT and your computer using a USB cable.

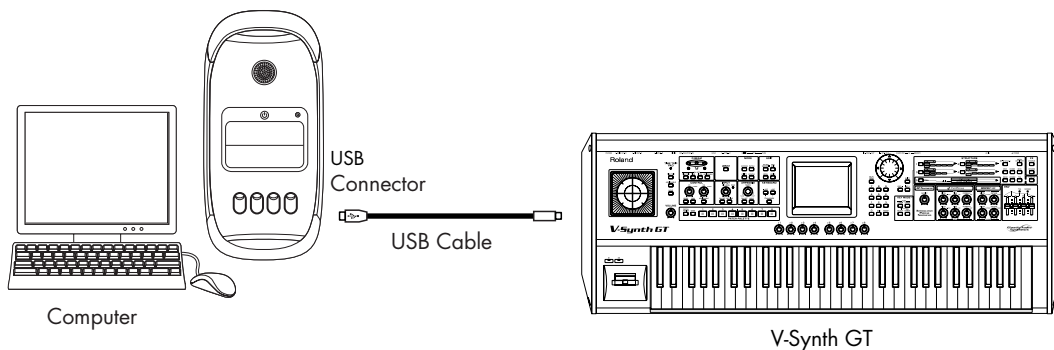

4. Turn on the power of V-Synth GT.
5. Touch <USB Storage> in the Utility Menu screen.
The USB Storage screen appears.



6. Touch <Mount the Internal Memory> to establish the connection with your computer.
7. When the USB connection is established, a new drive icon will appear on your desktop.
8. Once the V-Synth GT is connected, you can transfer files by operating your computer.

Disconnecting USB Storage

- 1. Select the V-Synth GT drive icon on the desktop, and drag it into the “trash.”**
Alternatively, select “Eject “V-SYNTH GT”” from the “Files” menu.
- 2. Press [EXIT].**
The USB storage will be disconnected.

Examples of Using Storage Function

Backing Up Patch and Wave Data (Project) from the V-Synth GT

When using USB in Storage function, the data within the V-Synth GT may be damaged if you operate your computer incorrectly or if your computer crashes. As a precaution against such occurrences, we recommend that you create a backup as described below.

Backing Up the V-Synth GT's Internal Data onto Your Computer

1. Use a USB cable to connect the V-Synth GT to your computer as described in "Connecting the V-Synth GT to your computer" (p. 221, p. 223).
2. Using your computer, copy the V-Synth GT's files and folders onto a drive (e.g., hard disk) of your computer.
3. Cancel the USB connection (p. 222, p. 224).

Loading Backup Data from Your Computer into the V-Synth GT

1. Use a USB cable to connect the V-Synth GT to your computer as described in "Connecting the V-Synth GT to your computer" (p. 221, p. 223).
2. Using your computer, copy the files and folders that you previously saved on your computer to the V-Synth GT.
3. Cancel the USB connection (p. 222, p. 224).



Note when connecting the V-Synth GT to your computer

Do not format, optimize, or execute the scan disk command on the V-Synth GT's user memory from your computer.

The V-Synth GT's File Structure

As seen from your computer, the V-Synth GT's file structure is as follows.

Do not perform operations on your computer to erase (format) or rename these folders or files.

If the V-Synth GT stops operating correctly, break the USB connection between the computer and the V-Synth GT (p. 222, p. 224), and then execute the Factory Reset command (p. 235).

This will erase all the data that has been saved on the V-Synth GT. As a precaution against such occurrences, we recommend that you always make a backup of your data (p. 225).

Internal Memory

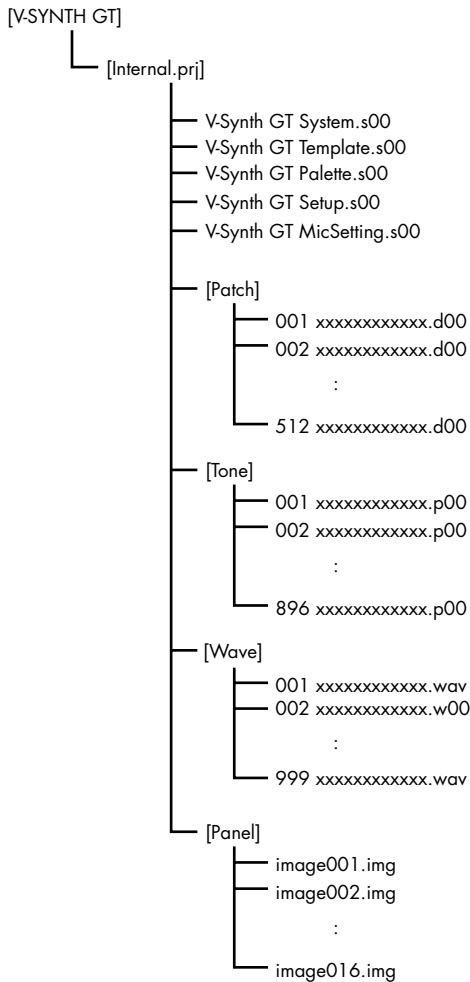

USB Memory

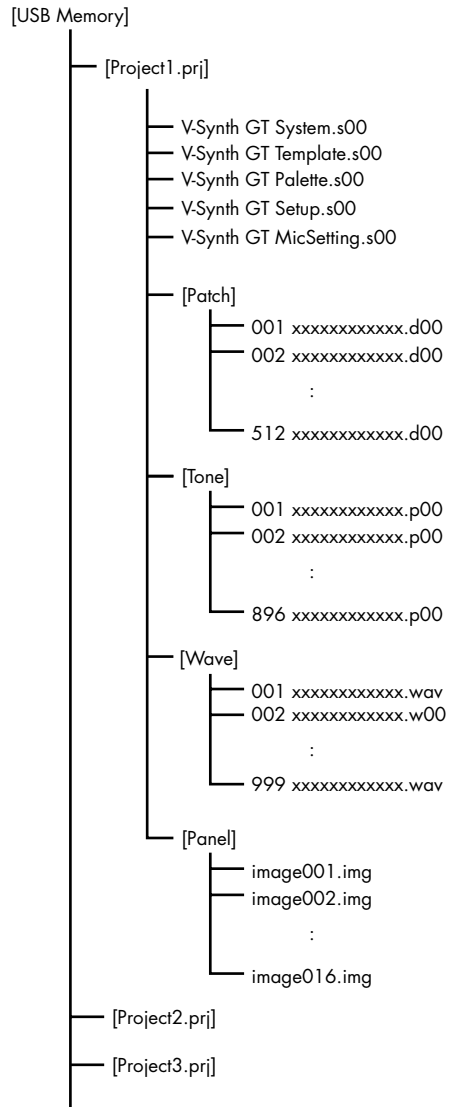

Beep (Beep Tone Settings)

You can specify whether a “beep” will be heard when you touch a valid point in the touch panel.

* With the factory settings, there will be a beep tone.

1. Press [UTILITY] to access the Utility Menu screen.

2. Touch <Beep>.

The beep tone will be switched on/off.



E1–E8 Knobs (E1–E8 knob Settings)

1. Press [UTILITY] to access the Utility Menu screen.
2. Touch <E1–E8 knobs>.
The E1–E8 Knob Settings screen appears.
3. Specify the parameters you wish to assign to the E1–E8 knobs.

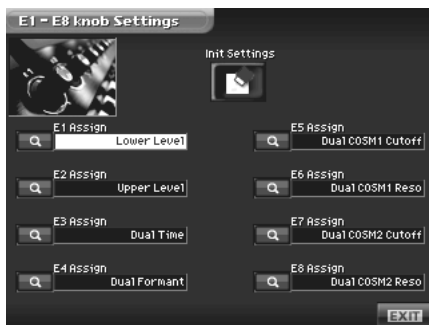

Parameter	Value	Description
Init Settings Sw		Initializes the settings of the E1–E8 knobs.
E1–E8 Assign		Specify the parameters assigned to the E1–E8 knobs.

Screen Saver

This feature allows you to have a simple animation be displayed whenever the V-Synth GT has not been operated for a certain period of time.

Because of the characteristics of the TFT liquid crystal display used in the V-Synth GT, leaving the same screen displayed for an extended time may cause that image to be burned into the screen. To avoid this, we recommend that you use the screen saver.

1. Press [UTILITY] to access the Utility Menu screen.

2. Touch <Screen Saver>.

The Screen Saver screen appears.



3. Touch the desired screen saver image to select it.

You can touch <Preview> to get a look at the screen saver image at the size of the actual screen.

Parameter	Value	Description
Screen Saver Time	OFF, 1– 60 min	Sets the time (minutes) until the screen saver begins working. If this is OFF, the screen saver will not appear.

Wallpaper (Changing the Wallpaper)

You can change the background image of the touch panel.

Via USB memory, you can also use data such as a photo you've taken as the background image.

1. Press [UTILITY] to access the Utility Menu screen.

2. Touch <Wallpaper>.

The Wallpaper screen appears.



3. Touch the image that you want to use as the background.

The selected image will appear in the background.

Import (Importing an Image as Wallpaper)

You can import a BMP file via USB memory and use it as wallpaper for the V-Synth GT.

1. Copy the bitmap file that you want to use as wallpaper (Windows BMP format, 24-bit, 320 x 240 pixels) to your USB memory (the root level), and connect the USB memory to the V-Synth GT's USB MEMORY connector.

2. Touch <Import> in the Wallpaper screen.

3. Touch the bitmap file in USB memory to select it.

4. Touch <OK>.



The V-Synth GT provides sixteen screens that you can use as wallpaper. The imported file will be overwritten over the currently selected screen.

Calibration (Adjusting the Controllers)

Adjusting the Positional Accuracy of the Touch Panel

Perform this adjustment if the touch panel no longer responds as you expect.

1. In the Utility Menu screen, touch <Calibration>.

The Calibration screen appears.

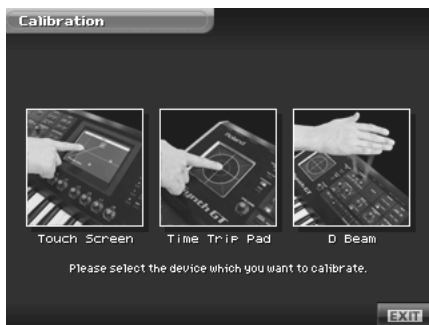

2. Touch <Touch Screen>.

The Touch Screen Calibration screen appears.



3. Touch the center of "+" symbol indicated by the square symbol in the screen, in the following order: left → top → right → bottom.

When you have touched all four points, the screen will close, and the sensitivity of the touch screen will be calibrated.

Adjusting the Positional Accuracy of the Time Trip Pad

Perform this adjustment if the Time Trip pad no longer responds as you expect.

1. In the Utility Menu screen, touch <Calibration>.

The Calibration screen appears.

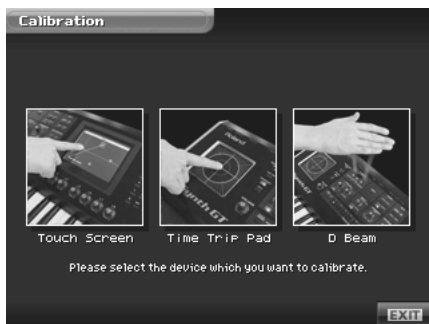

2. Touch <Time Trip Pad>.

The TT Pad Calibration screen appears.

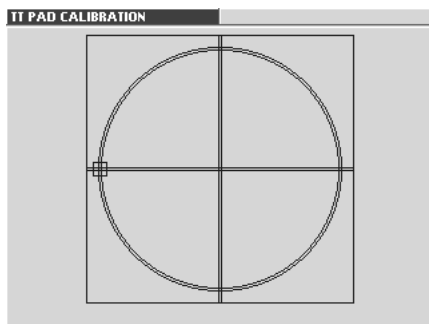

3. On the Time Trip pad, touch the points indicated by the square symbol in the screen, in the following order: left → top → right → bottom.

When you have touched all four points, the screen will close, and the sensitivity of the Time Trip pad will be calibrated.

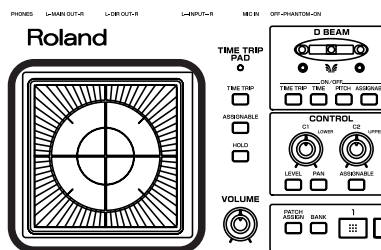

V-Synth GT

Adjusting the Sensitivity of the D Beam Controller

Perform this adjustment if the D Beam controller is functioning incorrectly, such as responding even though you have not operated it.

1. In the Utility Menu screen, touch <Calibration>.

The Calibration screen appears.

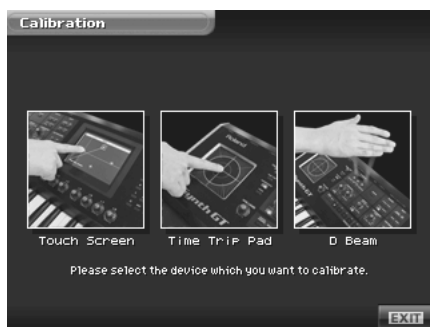

2. Touch <D Beam>.

The D Beam Calibration screen appears.

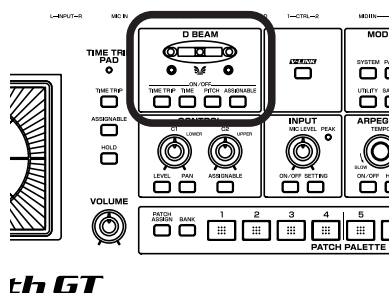
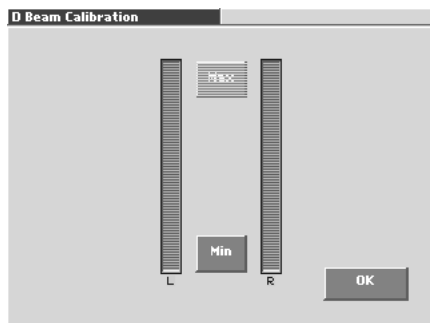

When you place your hand over the D Beam controller, the "L" or "R" level meter in the screen will move upward or downward.

3. First specify the location at which the D Beam controller will begin responding (i.e., the minimum value).

Move your hand toward the D Beam controller, and touch <Min> at the point where you want the controller to begin responding.

4. Next specify the location at which the D Beam controller will reach the peak (i.e., the maximum value).

Continue moving your hand toward the D Beam controller, and touch <Max> at the point where you want the peak response to occur.

5. While watching the level meter in the screen, raise and lower your hand to check the response of the D Beam controller.

6. If you are satisfied with the response, touch <OK>.

The sensitivity of the D Beam controller will be calibrated.

Format (Initializing Internal Memory or USB Memory)

You can initialize (format) internal memory or USB memory to erase all data.

1. Press [UTILITY] to access the Utility Menu screen.
2. Touch <Format>.
The Format screen appears.

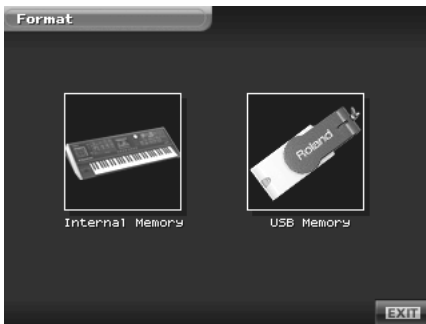

3. If you want to format the internal memory, touch <Internal Memory>.
If you want to format a USB memory, touch <USB Memory>.
4. When you format a USB memory, the Volume Name window will appear, allowing you to assign a new volume name.
5. Touch <OK>.
A Warning window like the following appears.

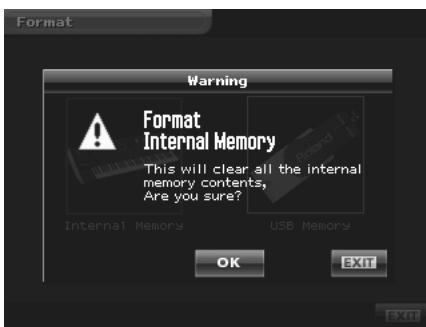

TIP If you want to cancel the procedure at this point, touch <EXIT>.

6. Touch <OK> to execute the operation.

Factory Reset (Reset to Default Factory Settings)

This restores all data in the V-Synth GT to the factory-set condition (Factory Reset).

NOTE If there is important data you've created that's stored in the V-Synth GT's internal memory, all such data is discarded when a Factory Reset is performed. If you want to keep the existing data, save it on a USB memory (p. 217) or USB backing up onto a computer (p. 221).

1. Press [UTILITY] to access the Utility Menu screen.

2. Touch <Factory Reset>.

The Factory Reset screen appears.



3. Touch <Execute> to execute the Factory Reset.

NOTE It will take several minutes for the factory reset to be carried out.

4. When <Completed!> is displayed, the factory reset is finished.

Touch <OK> to return to the Patch Play screen.

MIDI Implementation Chart

Synthesizer Keyboard
Model: V-Synth GT

MIDI Implementation Chart

Date: April 1, 2007
Version: 1.00

Function...	Transmitted	Recognized	Remarks
Basic Channel Default Changed	1-16 1-16	1-16 1-16	Memorized
Mode Default Messages Altered	Mode 3 Mono, Poly *****	Mode 3 Mode 3, 4 (M = 1)	* 2
Note Number : True Voice	0-127 *****	0-127 0-127	
Velocity Note On Note Off	O O	O O	
After Touch Key's Channel's	X O	O O	*1 *1
Pitch Bend	O	O	*1
Control Change	0, 32 O (Modulation)	*1 O	*1 Bank select
	1 O (Knob 1)	*1 X	*1 Modulation
	2 O (Pedal 2)	*1 X	*1 Breath type
	4 X	*1 X	*1 Foot type
	5 X	*1 O	*5 Portamento time
	6, 38 X	*1 O	Data entry
	10 X	O	Panpot
	11 O (Pedal 1)	*1 O	Expression
	12 O (Switch 1)	*1 X	*1 Effect control 1
	13 O (Switch 2)	*1 X	*1 Effect control 2
	16 O (D Beam1-L)	*1 X	*1 General purpose controller 1
	17 O (D Beam2-L)	*1 X	*1 General purpose controller 2
	18 O (D Beam3-L)	*1 X	*1 General purpose controller 3
	19 O (D Beam4-L)	*1 X	*1 General purpose controller 4
	34 O (Knob 2)	*1 X	*1 Breath type
	48 O (D Beam1-R)	*1 X	*1 General purpose controller 1
	49 O (D Beam2-R)	*1 X	*1 General purpose controller 2
	50 O (D Beam3-R)	*1 X	*1 General purpose controller 3
	51 O (D Beam4-R)	*1 X	*1 General purpose controller 4
	64 O (Hold)	O	O Hold 1
	65 X	*1 O	*5 Portamento
	66 X	*1 O	*5 Sostenuto
	80 O (TT Pad XY-X)	*1 X	*1 General purpose controller 5
	81 O (TT Pad XY-Y)	*1 X	*1 General purpose controller 6
82 O (TT Pad TT-X)	*1 X	*1 General purpose controller 7	
83 O (TT Pad TT-Y)	*1 X	*1 General purpose controller 8	
91 X	*1 O (Reverb)	*1 General purpose effects 1	
93 X	*1 O (Chorus)	*1 General purpose effects 3	
1-31, 64-95 O	*1 X	*1 Pedal, Knob, D Beam, TT Pad, Switch	
100, 101 X	*1 O	*1 RPN LSB, MSB	
Program Change : True Number	O ***** *1	O 0-127 *1	Program No. 1-128
System Exclusive	O *3	O *1	
System Common : Song Position : Song Select : Tune Request	X X X	X X X	
System Realtime : Clock : Commands	X *1 X	X *1 O *4	
Aux Messages : All Sound Off : Reset All Controllers : Local On/Off : All Notes Off : Active Sensing : System Reset	X X X X O X	O O X O (123-127) O X	
Notes	* 1 O X is selectable * 2 Recognized as M=1 even if M≠1. * 3 Transmitted when the Transmit Edit Switch is ON, or when RQ1 is received. * 4 Recognized when "Sampling Trigger" is "MIDI." * 5 Not received for AP-Synthesis		

Mode 1 : OMNI ON, POLY
Mode 3 : OMNI OFF, POLY

Mode 2 : OMNI ON, MONO
Mode 4 : OMNI OFF, MONO

O : Yes
X : No

Specifications

V-Synth GT: Synthesizer Keyboard

- **Keyboard**
61 keys (with velocity and channel aftertouch)
- **Sound Generator Configuration**
Dual-core (2 Tones per Patch: Upper, Lower)
Sections per Tone:
 - Oscillator (envelope x 4 + LFO x 1) x 2
 - Modulator x 1
 - COSM (envelope x 2 + LFO x 1) x 2
 - TVA (envelope x 1 + LFO x 1) x 1
 - Multi Step Modulator x 1
 - Tone-FX x 1
 - AP-Synthesis (Articulative Phrase Synthesis) x 1 (*)
 - Vocal Designer x 1 (*)

* Usable on either upper or lower (not both)
- **OSC1/OSC2 (Oscillator 1, 2)**
Analog Modeling: 14 waveforms
(SAW, SQUARE, TRIANGLE, SINE, RAMP, JUNO, HQ-SAW, HQ-SQUARE, NOISE, LA-SAW, LA-SQUARE, SUPER-SAW, FEEDBACK-OSC, XMOD-OSC)
PCM/VariPhrase (Preset waveforms + Sampling waveforms)
External Input
- **MOD (Modulator)**
4 types (RING, FM, ENV-RING, OSC-SYNC)
- **COSM**
16 types
(OD/DS, W-SHAPE, AMP, SPEAKER, RESONATOR, SBF1, SBF2, COMB, DUAL, TVF, DYN-TVF, COMP, LIMITER, F-SHIFT, LO-FI, TB FILTER)
- **Multi Step Modulator**
Provided independently for the Upper Tone and Lower Tone
Tracks per tone: 4
Maximum number of step: 16
Tempo: 20–250 BPM
- **AP-Synthesis**
Source Waveforms: 38 types
Phrase Models: Violin, Erhu, Sax, Flute, Multifade
- **Vocal Designer**
Carrier: Oscillator x 2, Modulator x 1, COSM x 2, TVA x 1, Multi Step Modulator x 1
Vocoder: 4 types (Stereo, Mono, Vintage, Enhance)
Formant: 7 types (Maximum)
- **Zones**
Upper Tone: 16
Lower Tone: 16
- **Arpeggiator**
Patterns: User programmable (supports use of control change messages)
Motifs: 8 types
Tempo: 20–250 BPM
- **MIDI Parts**
1
- **Maximum Polyphony**
28 voices (varies according to the sound generator load)
- **Internal Memory**
Project: 1
Patches: 512
Tones: 896
Wave Memory (RAM): 64 MB
- **Internal Storage**
Internal Flash Memory: 49.5 MB
- **External Storage Device**
USB Flash Memory
- **Effects**
Tone-FX: 41 types
Chorus: 8 types
Reverb: 13 types
4-band system EQ
Input Effects (Mic/Sampling)
- **Sampling Frequency**
Internal: 44.1 kHz
DIGITAL IN/OUT: 96, 48, 44.1 kHz
- **Signal Processing**
Internal Processing
Sound Generating Section: 32 bits (floating point)
Effects Section: 32 bits (fixed point)
DA Conversion: 24 bits
AD Conversion: 24 bits
- **Nominal Output Level**
MAIN OUT: +4 dBu
DIRECT OUT: +4 dBu
- **Nominal Input Level**
INPUT (L, R): -10/-20 dBu
MIC IN: -50–-10 dBu
- **Display**
320 x 240 dots backlit TFT full color touch screen

Specifications

● Connectors

Headphone Jack (Stereo 1/4 inch phone type)
Main Output Jacks (L/MONO, R) (1/4 inch TRS phone type)
Direct Output Jacks (L, R) (1/4 inch phone type)
Input Jacks (L, R) (1/4 inch phone type)
Mic Jack (1/4 inch phone type/XLR type, phantom power)
Hold pedal Jack
Control pedal Jacks (1, 2)
MIDI Connectors (IN, OUT, THRU)
USB Connectors
 COMPUTER (supports USB 2.0 file transfer, USB 1.1 USB
 MIDI, and USB Audio)
 MEMORY (supports USB 2.0 Flash Memory)
Digital Audio Interface (24-bit, IEC60958)
 COAXIAL (IN, OUT)
 OPTICAL (IN, OUT)
AC Inlet

● Power Supply

AC 115 V, AC 117 V, AC 220 V, AC 230 V, AC 240 V
(50/60 Hz)

● Power Consumption

30 W

● Dimensions

1066 (W) x 411 (D) x 125 (H) mm
42 (W) x 16-3/16 (D) x 4-15/16 (H) inches

● Weight

13.8 kg
30 lbs 7 oz

● Accessories

Owner's Manual
Quick Start
Driver Installation Guide
CD-ROM (USB Driver)
Power Cord

● Options

Keyboard Stand: KS-12
Pedal Switch: DP series
Footswitch: BOSS FS-5U
Expression Pedal: EV-5
USB Memory: M-UF128
Microphone: DR series

(0 dBu = 0.775 Vrms)

* In the interest of product improvement, the specifications and/or appearance of this unit are subject to change without prior notice.

Index

Symbols

[-/+OCT] 21, 44–45

Numerics

1–4 Assign L, R 205
V-LINK 210

A

AC IN 24
Active Sens 198
Adjust 180
ADSR Attack 121
ADSR Decay 121
ADSR Release 121
ADSR Sustain 121
Aftertouch 43
 Local Sw 212
Aftertouch Assign 212
Aftertouch Sens 203
Ambience Level 132–136
Amount Keyfollow 109
Amount LFO Depth 109
Analog 96, 102–110, 113–114
Analog OSC 95
AP Syn CHO Send 77
AP Syn Output Assign 77
AP Syn REV Send 77
AP Syn Tone-FX Send 77
AP-SYNTHESIS 29
AP-Synthesis 124
 Advanced 132–136
 Control 137–138
 Dynamics 137
 Erhu 128, 133
 Fade 137
 Flute 130, 135, 137
 Level 125
 Modify 127–131
 MODIFY Knob 124
 Mono/Poly 138
 Multifade 131, 136–137
 Pan 125
 Phrase Model 125
 Pitch 126
 Pizzicato 138
 Portamento 137
 Sax 129, 134
 Tremolo 138
 Violin 127, 132, 138
 Waveform 125
Arabic Scale 94
Arpeggiator 51

Arpeggio 51, 69
 Creating 71, 73–74
 Keyboard Velocity 70
 Motif 69
 Octave Range 70
 Shuffle Rate 70
 Shuffle Resolution 70
 Arpeggio Duration 70
Arpeggio Pattern 71
[ASSIGNABLE] 46, 48
 D Beam 20
 Time trip pad 20
ASSIGNABLE CONTROL Knobs 50
Assign-Time Trip 209
Attack 116
 MOD 121
 TVA 156–157
 Vocal Designer 116
Attack Time 128
 Erhu 130
 Flute 131
 Multifade 129
 Sax 121
 TVA 127
 Violin 200
Audio Input 201
Audio Output 201

B

BACKING 188
Backup 225
 Patch and Wave Data (Project) 21
[BANK] 198
Bank Select 205
Beam Sens L, R 99
Beat Keep Sw 227
Beep 43, 212
Bender 212
 Local Sw 212
Bender Assign 90
Bender/Octave 129–130
Breath Noise 129–130
Breath Nz Level 129–130

C

C1, 2 Knob 211
 Local Sw 206
C1, 2 Knob Assign 211
 V-LINK 186
CALC 233
Calibration 232
 D Beam 231
 Time Trip Pad 231
 Touch Panel 231

Index

- Carrier 147, 150
- Category
- Patch 41, 60
 - Tone 57, 83
- Chorus 78
- Vintage Vocoder 157
- Clock Out 198
- Clock Source 198
- Coarse Tune 97, 100, 102
- AP-Synthesis 126
- COAXIAL IN/OUT 24
- Compressor
- Sampling 175
 - Vocal Designer 154
- COMPUTER
- USB 24
- Connecting
- Amp/Speaker System 17
 - V-LINK 52
- Consonant Detect 156
- Consonant HPF Freq 157
- Consonant Level 156–157
- Controller Section 27
- Convert
- Project 219
- COSM Type 117
- COSM1/2 29
- COSM1/COSM2 117
- CTRL 1 Jack 24, 207
- CTRL 2 Jack 24, 207
- Cursor 33
- Cursor Buttons 33
- [CUTOFF] 23
- D**
- D BEAM 20
- D Beam 48, 67
- 1–4 Assign L, R 205
 - Calibration 233
 - Local Sw 210
 - Sensitivity 205
 - V-LINK 210
- [DEC/-] 22
- Decay
- TVA 121
- Decay Time
- TVA 121
- Default Factory Settings 235
- Delay Time
- LFO 122
- [DETUNE] 23
- Detune 97, 105
- Detune Keyfollow 105
 - Detune LFO Depth 105
- Device ID 198
- DIGITAL AUDIO Connectors 24
- Digital Output Freq 201
- DIRECT OUT Jacks 25
- Display 21
- Dynamics
- AP-Synthesis 137
- E**
- E1–E8 Knobs 35, 49, 228
- Edit Data 198
- Editing
- Patch 54
 - Sample 178, 182–183
 - Tone 80, 85, 158
- Effect
- Sampling 175
- Effects 76
- Encode 187
- Encoding Type 188
- Energy 112
- Env Time KF 121
- Envelope Ring 116
- Envelope Settings 121
- Envelope Sliders 35
- EQ (Equalizer)
- System Mode 197
 - Vocal Designer 152
- Erhu 128, 133
- [EXIT] 22
- Ext In Source 200
- Ext In Type 200
- External In 101
- External Input Source 200
- External Input Type 200
- F**
- Factory Data 31, 235
- Factory Reset 235
- Fade
- AP-Synthesis 137
- Fade Mode 122
- Fade Time 122
- Fat 104
- Fat Keyfollow 104
- Fat LFO Depth 104
- Favorite Patch 42
- FBK Amount 109
- File Structure 226
- Fine Tune 97, 100, 102
- AP-Synthesis 126
- Flute 130, 135
- FOOT PEDAL Jacks 24
- Formant Keyfollow 112
 - Formant Type 156
- Format 234
- Frequency Modulator 115
- Front Panel 20

H

Harmonics	108
Harmonics Keyfollow	108
Harmonics LFO Depth	108
Headphones	25
Hi Cut Switch	157
[HOLD]	
Time trip pad	20
Hold	
Arpeggio	51, 69
HOLD Jack	24, 51
Hold Pedal	51, 207
Hold Polarity	207

I

Icons	36
Impact	97
[INC/+]	22
Initializing	
E1–E8 Knobs	228
Internal Memory/USB Memory	234
Patch	62
System Settings	195
Tone	84
Input Gain	200, 202
INPUT Jacks	25
Input Source	174, 202
Input Sw	200, 202
Internal Memory	31
File Structure	226
Initialize	234

K

KEY MODE Buttons	23
Key Range	68
Key Sync	
LFO	122
Keyboard	
Aftertouch	43
Sensitivity	203
Split	88
Transpose (in Octave Units)	45
Transpose (in Semitone Steps)	44
Velocity	43
Keyboard Output Fade Sw	208
Keyboard Sens	203
Keyboard Velocity	70, 203
Keyword	
Patch	41
Tone	57

L

Legato Switch	87
Level	
AP-Synthesis	125
Lower Tone	65
Patch	65
Upper Tone	65
Vocal Designer	156–157
Level Keyfollow	113
Level KF	119
LFO	120
Delay Time	122
Fade Mode	122
Fade Time	122
Key Sync	122
Offset	122
Rate	122
Waveform	122
LFO Settings	122
Limiter	
Sampling	175
Loading	
Project	215
Local Sw	203
Aftertouch	212
Bender	212
C1, 2 Knob	211
D Beam	210
Modulation	212
Time Trip Pad	209
LOCK	180
LOOP	180
LOOP MODE	192
Lower Level	65
Lower Pan	65

M

MAIN OUT Jacks	25
Map Function	37
Master Key Shift	196
Master Level	196
Master Tune	196
Matrix Control	91
MEMORY	
USB	24
Memory	
Internal	31
Sampling	31
Structure	30
USB	31
Metronome	176
MIC IN Jack	25
Mic Settings	
Vocal Designer	151
Mic Sw	200, 202
MIDI	198
USB	199
MIDI Channel	198
V-LINK	208

Index

MIDI Clock	198
MIDI Connectors	24
MIDI Message	
V-LINK	53
MIDI Thru	199
Mix	107
Mix Keyfollow	107
Mix LFO Depth	107
Mix/Parallel	201
MOD	29
Modes	38
MODIFY Knob	124
Modulation	43
Local Sw	212
Modulation Assign	212
Modulation Lever	43
Modulator Type	115
Monitor Sw	202
Mono/Poly	87
AP-Synthesis	138
Motif (Arpeggio Motif)	69
Multi Step Modulator	142, 144
Multifade	131, 136

N

Name	
Patch	59
Sample	168
Template	177
Tone	82
Natural Feel	127–131
Noise Suppressor	
Sampling	175
Vocal Designer	153
Normalize	184
Numeric Keys	34

O

Octave Range	70
Octave Shift	45, 90
AP-Synthesis	126
Offset	
LFO	122
ON/OFF	
D Beam	20
Operation	
Touch Panel	33
OPTICAL IN/ OUT	24
Original Fine Tune	192
Original Pitch	192
Original Tempo	186
OSC1/2	29
Oscillator Sync	116
Output Dest	202
Output Gain	201

P

Pan	
AP-Synthesis	125
Lower Tone	65
Upper Level	65
Pan KF	119
Panel	
Front	20
Rear	24
Patch	
Creating	54
Editing	54
Favorite	42
Initializing	62
Keyword	41
Pitch	65
Saving	58
Selecting	40–42
Startup	196
Patch Category	41, 60
Patch Category List	61
Patch Coarse Tune	65
Patch Common	63
Patch Init	62
Patch Level	65
Patch List	41
Patch Menu	58
Patch Mode	38–39
Patch Name	59
Patch Palette	42
Patch Palette Local Sw	208
Patch Play Screen	39
Patch Remain	196
Patch Tempo	69
Patch Write	58
PCM	99, 102, 111–114
Pedal	207
Pedal 1 Assign	207
Pedal 1 Polarity	207
Pedal 2 Assign	207
Pedal 2 Polarity	207
PHANTOM Switch	24
PHONES Jack	25
Phrase Model	125
[PITCH]	20
Pitch	102
AP-Synthesis	126
Entire System	196
Patch	65
Pitch Bend	43
Pitch Bend Lever	43
Pitch Bend Range	90
Pitch Keyfollow	102
Pitch LFO Depth	102
Pizzicato	138
Polyphony	27

- Portamento 87
 AP-Synthesis 137
 Portamento Switch 87
 Portamento Time 87
 Portamento Type 87
 Power
 Turning Off 19
 Turning On 18
 POWER ON Switch 18
 POWER Switch 24
 Pre Gain 174
 Pre Trigger 174
 PREVIEW 180
 Pro Edit 85
 Program Change 198
 Project 31, 215
 Convert 219
 Loading 215
 Saving 217
 Pulse Width 97, 103
 Pulse Width Keyfollow 103
 Pulse Width LFO Depth 103
- R**
- Random 102
 Rate
 LFO 122
 Rear Panel 24
 Receive MIDI Channel 198
 Release
 MOD 116
 TVA 121
 Vocal Designer 156–157
 Release Time
 Erhu 128
 Flute 130
 Multifade 131
 Sax 129
 TVA 121
 Violin 127
 Resampling 173
 Reset
 Factory Settings 235
 [RESO] 23
 Reverb 79
 Ring Modulator 115
- S**
- S1, 2 Switch Assign 206
 S1/S2 Switch 67
 Sample
 Editing 178, 182–183
 Encode 187
 Saving 191
 Sample Copy 169
 Sample Delete 172
 Sample Exchange 171
 Sample Mode 38, 163
 Sample Move 170
 Sample Name 168
 Sampling 165
 Compressor 175
 Limiter 175
 Noise Suppressor 175
 Sampling Memory 31
 Sampling Template 163–164
 Sampling Template Name 177
 Sampling Type 174
 Saving
 Patch 58
 Project 217
 Sample 191
 System Settings 194
 Tone 81
 Sax 129, 134
 Scale Tune 94
 Scrape Noise 127
 Scrape Nz Level 127–128
 Screen Saver 229
 Section 29
 Selecting
 Patch 40–42
 Tone 55–57
 Sensitivity
 D Beam 205, 233
 Keyboard 203
 Shuffle Rate 70
 Shuffle Resolution 70
 Slur Noise 130
 Slur Nz Level 130
 Sound Generator Section 26
 SOUND SHAPER II 158
 Source Waveform 125
 Split 88
 SS Detune 106
 SS Detune Keyfollow 106
 SS Detune LFO Depth 106
 Start Offset 99
 Startup Patch 196
 Structure
 Section 29
 STRUCTURE Buttons 23
 Structure Type 28, 86
 Sub Level 97
 Sub OSC Octave Select 97
 Sub-Oscillator 98
 Sustain
 TVA 121
 Sustain Level
 TVA 121
 Synchronize 198
 Synchronizing
 Music and Video 52

Index

- [SYSTEM] 193
System Init 195
System Menu 194
System Mode 38, 193
System Settings
 Initializing 195
 Saving 194
System Write 194
- T**
- TalkBox 156
Temperament 94
Template
 Sampling 163–164
Tempo
 Metronome 176
 Patch 69
 Sample 186
Tempo Sync Sw 99
Temporary Area 31
[TIME] 20
Time Keyfollow 111
Time Offset 111
[TIME TRIP]
 D Beam 20
 Time trip pad 20
Time Trip Function 46
Time Trip Pad 20, 46, 66
 Calibration 232
 Local Sw 209
 V-LINK 209
 X Assign-TT 204
 X Assign-XY 204
 Y Assign-TT 204
 Y Assign-XY 204
Time Velo Sens 87
Tone
 Editing 80, 85, 158
 Initializing 84
 Keyword 57
 Saving 81
 Selecting 55–57
Tone Category 57, 83
Tone Category List 83
Tone Coarse Tune 94
Tone Effect 139
Tone Fine Tune 94
Tone Init 84
Tone List 57
Tone Menu 81
Tone Name 82
Tone Write 81
Tone-FX 141
Touch Panel
 Calibration 231
 Icons 36
 Operation 33
Touch Screen 33–34
Transmit MIDI Channel 198
[TRANPOSE] 21, 44
Transpose 44
Tremolo 138
Trigger Level 174
Trigger Mode 174
Trimming 183
Truncate 183
Tune 94
Tuning 196
 Patch 65
TVA 29
- U**
- Upper Level 65
Upper Pan 65
USB
 COMPUTER 24
 MEMORY 24
USB Audio 202
USB Connectors 24
USB Memory 31
 File Structure 226
 Initialize 234
USB MIDI 199
USB Storage 31, 221–225
USB-MIDI Thru Switch 199
Utility Mode 38, 214
- V**
- Value
 Editing 34
VALUE Dial 34
VariPhrase 32
Velocity 43
 Keyboard 203
Velocity A-Sens 121
Velocity Curve 121
Velocity D-Sens 121
Velocity R-Sens 121
Velocity Sens 121
Version 213
Violin 127, 132
V-LINK 52–53
 1–4 Assign L, R 210
 C1, 2 Knob Assign 211
 D Beam 210
 Functions 53
 Settings 208
 Time Trip Pad 209
 X Assign-XY 209
 Y Assign-XY 209
V-LINK Audio Sw 208
V-LINK MIDI Channel 208

VOCAL DESIGNER	29
Vocal Designer	146
Compressor	154
EQ (Equalizer)	152
Mic Settings	151
Noise suppressor	153
Settings	150
Vocoder	155
Stereo/Mono/Enhance	156
Vintage	157
Vocoder Type	155
Volume	196

W

Wallpaper	230
Wave Gain	97, 99, 101
Waveform	
Analog Oscillator	96
AP-Synthesis	125
LFO	122
PCM Oscillator	99
[WIDTH]	23
Writing	
Patch	58
System Settings	194
Tone	81

X

X Assign-TT	204
X Assign-XY	204
V-LINK	209
X-Mod	110
X-Mod Keyfollow	110
X-Mod LFO Depth	110

Y

Y Assign-TT	204
Y Assign-XY	204
V-LINK	209

Z

ZeroX (Zero Cross Search)	181
Zoom	181



For EU Countries

- UK** This symbol indicates that in EU countries, this product must be collected separately from household waste, as defined in each region. Products bearing this symbol must not be discarded together with household waste.
- DE** Dieses Symbol bedeutet, dass dieses Produkt in EU-Ländern getrennt vom Hausmüll gesammelt werden muss gemäß den regionalen Bestimmungen. Mit diesem Symbol gekennzeichnete Produkte dürfen nicht zusammen mit den Hausmüll entsorgt werden.
- FR** Ce symbole indique que dans les pays de l'Union européenne, ce produit doit être collecté séparément des ordures ménagères selon les directives en vigueur dans chacun de ces pays. Les produits portant ce symbole ne doivent pas être mis au rebut avec les ordures ménagères.
- IT** Questo simbolo indica che nei paesi della Comunità europea questo prodotto deve essere smaltito separatamente dai normali rifiuti domestici, secondo la legislazione in vigore in ciascun paese. I prodotti che riportano questo simbolo non devono essere smaltiti insieme ai rifiuti domestici. Ai sensi dell'art. 13 del D.Lgs. 25 luglio 2005 n. 151.
- ES** Este símbolo indica que en los países de la Unión Europea este producto debe recogerse aparte de los residuos domésticos, tal como está regulado en cada zona. Los productos con este símbolo no se deben depositar con los residuos domésticos.
- PT** Este símbolo indica que nos países da UE, a recolha deste produto deverá ser feita separadamente do lixo doméstico, de acordo com os regulamentos de cada região. Os produtos que apresentem este símbolo não deverão ser eliminados juntamente com o lixo doméstico.
- NL** Dit symbool geeft aan dat in landen van de EU dit product gescheiden van huishoudelijk afval moet worden aangeboden, zoals bepaald per gemeente of regio. Producten die van dit symbool zijn voorzien, mogen niet samen met huishoudelijk afval worden verwijderd.
- DK** Dette symbol angiver, at i EU-lande skal dette produkt opsamlles adskilt fra husholdningsaffald, som defineret i hver enkelt region. Produkter med dette symbol må ikke smides ud sammen med husholdningsaffald.
- NO** Dette symbolet indikerer at produktet må behandles som spesialavfall i EU-land, iht. til retningslinjer for den enkelte regionen, og ikke kastes sammen med vanlig husholdningsavfall. Produkter som er merket med dette symbolet, må ikke kastes sammen med vanlig husholdningsavfall.
- SE** Symbolen anger att i EU-länder måste den här produkten kasseras separat från hushållsavfall, i enlighet med varje regions bestämmelser. Produkter med den här symbolen får inte kasseras tillsammans med hushållsavfall.
- FI** Tämä merkintä ilmaisee, että tuote on EU-maissa kerättävä erillään kotitalousjätteistä kunkin alueen voimassa olevien määräysten mukaisesti. Tällä merkinnällä varustettuja tuotteita ei saa hävittää kotitalousjätteiden mukana.
- HU** Ez a szimbólum azt jelenti, hogy az Európai Unióban ezt a terméket a háztartási hulladéktól elkülönítve, az adott régióban érvényes szabályozás szerint kell gyűjteni. Az ezzel a szimbólummal ellátott termékeket nem szabad a háztartási hulladék közé dobni.
- PL** Symbol oznacza, że zgodnie z regulacjami w odpowiednim regionie, w krajach UE produktu nie należy wyrzucać z odpadami domowymi. Produktów opatrzonych tym symbolem nie można utylizować razem z odpadami domowymi.
- CZ** Tento symbol udává, že v zemích EU musí být tento výrobek sbíráán odděleně od domácího odpadu, jak je určeno pro každý region. Výrobky nesoucí tento symbol se nesmí vyhazovat spolu s domácím odpadem.
- SK** Tento symbol vyjadruje, že v krajinách EÚ sa musí zber tohto produktu vykonávať oddelene od domového odpadu, podľa nariadení platných v konkrétnej krajine. Produkty s týmto symbolom sa nesmú vyhazovať spolu s domovým odpadom.
- EE** See sümbool näitab, et EL-i maades tuleb see toode olempriigist eraldi koguda, nii nagu on igas piirkonnas määratletud. Selle sümboliga märgitud tooteid ei tohi ära visata koos olmeprügiga.
- LT** Šis simbolis rodo, kad ES šalyse šis produktas turi būti surenkamas atskirai nuo buitinių atliekų, kaip nustatyta kiekviename regione. Šiuo simboliu paženklinėti produktai neturi būti išmetami kartu su buitiniomis atliekomis.
- LV** Šis simbols norāda, ka ES valstīs šo produktu jāievāc atsevišķi no mājsaimniecības atkritumiem, kā noteikts katrā reģionā. Produkts ar šo simbolu nedrīkst izmest kopā ar mājsaimniecības atkritumiem.
- SI** Ta simbol označuje, da je treba proizvod v državah EU zbirati ločeno od gospodinskih odpadkov, tako kot je določeno v vsaki regiji. Proizvoda tem znakom ni dovoljeno odlagati skupaj z gospodinskimi odpadki.
- GR** Бхфъ фп уэмвпли дзлоней бфп уфйт цюсет фэт ЕЕ. фп респън бхфъ рсЭрей нб ухллЭгефбп оечсиуфб брф фб пйкйбкб бриссЯммбфб, уэмцинб ме фз нимпиеуЯб фэт кбие ресинчЮт. Фб респънфб рпх цЭспхн бхфъ фп уэмвпли ден рсЭрей нб бриссЯфрпнфбп мбжЯ ме фб пйкйбкб бриссЯммбфб.

For the USA

DECLARATION OF CONFORMITY Compliance Information Statement

Model Name : V-Synth GT
Type of Equipment : Synthesizer Keyboard
Responsible Party : Roland Corporation U.S.
Address : 5100 S. Eastern Avenue, Los Angeles, CA 90040-2938
Telephone : (323) 890-3700

For EU Countries



This product complies with the requirements of European Directives EMC 89/336/EEC and LVD 73/23/EEC.

For the USA

FEDERAL COMMUNICATIONS COMMISSION RADIO FREQUENCY INTERFERENCE STATEMENT

This equipment has been tested and found to comply with the limits for a Class B digital device, pursuant to Part 15 of the FCC Rules. These limits are designed to provide reasonable protection against harmful interference in a residential installation. This equipment generates, uses, and can radiate radio frequency energy and, if not installed and used in accordance with the instructions, may cause harmful interference to radio communications. However, there is no guarantee that interference will not occur in a particular installation. If this equipment does cause harmful interference to radio or television reception, which can be determined by turning the equipment off and on, the user is encouraged to try to correct the interference by one or more of the following measures:

- Reorient or relocate the receiving antenna.
- Increase the separation between the equipment and receiver.
- Connect the equipment into an outlet on a circuit different from that to which the receiver is connected.
- Consult the dealer or an experienced radio/TV technician for help.

This device complies with Part 15 of the FCC Rules. Operation is subject to the following two conditions:

- (1) this device may not cause harmful interference, and
- (2) this device must accept any interference received, including interference that may cause undesired operation.

Unauthorized changes or modification to this system can void the users authority to operate this equipment.
This equipment requires shielded interface cables in order to meet FCC class B Limit.

For Canada

NOTICE

This Class B digital apparatus meets all requirements of the Canadian Interference-Causing Equipment Regulations.

AVIS

Cet appareil numérique de la classe B respecte toutes les exigences du Règlement sur le matériel brouilleur du Canada.

Information

When you need repair service, call your nearest Roland Service Center or authorized Roland distributor in your country as shown below.

AFRICA

EGYPT

Al Fanny Trading Office
9, EBN Hagar Al Askalani
Street,
ARD El Golf, Heliopolis,
Cairo 11341, EGYPT
TEL: 20-2-417-1828

REUNION

Maison FO - YAM Marcel
25 Rue Jules Hermann,
Chaudron - BP79 97 491
Ste Clothilde Cedex,
REUNION ISLAND
TEL: (0262) 218-429

SOUTH AFRICA

(By) Ltd.
2 ASTRON ROAD DENVER
JOHANNESBURG ZA 2195,
SOUTH AFRICA
TEL: (011)417 3400
FAX: (011)417 3462

Paul Bothner(PTY)Ltd.
Royal Cape Park, Unit 24
Londonderry Road, Ottery 780
Cape Town, SOUTH AFRICA
TEL: (021) 799 4900

ASIA

CHINA

Roland Shanghai Electronics
Co.,Ltd.
5F, No.1500 Pingliang Road
Shanghai 200090, CHINA
TEL: (021) 5580-0800

Roland Shanghai Electronics
Co.,Ltd.
(BEIJING OFFICE)
10F, No.18 3 Section Anhuaxili
Chaoyang District Beijing
100011 CHINA
TEL: (010) 6426-5050

HONG KONG

Tom Lee Music Co., Ltd.
Service Division
22-32 Pun Shan Street, Tseun
Wan, New Territories,
HONG KONG
TEL: 2415 0911

Parsons Music Ltd.

8th Floor, Railway Plaza, 39
Kowloon Road South, T.S.T,
Kowloon, HONG KONG
TEL: 2333 1863

INDIA

Rivera Digitech (India) Pvt. Ltd.
409, Nirman Kendra
Mahalaxmi Flats Compound
Off. Dr. Edwin Moses Road,
Mumbai-400011, INDIA
TEL: (022) 2439 9051

INDONESIA

PT Citra IntiRama
Jl. Cideng Timur No. 15f-150
Jakarta Pusat
INDONESIA
TEL: (021) 6324170

KOREA

Cosmos Corporation
1461-9, Seocho-Dong,
Seocho Ku, Seoul, KOREA
TEL: (02) 3486-8855

MALAYSIA

Roland Asia Pacific Sdn. Bhd.
45-1, Block C2, Jalan PJU 1/39,
Dataran Prima, 47301 Petaling
Jaya, Selangor, MALAYSIA
TEL: (03) 7805-3263

PHILIPPINES

G.A. Yunganco & Co. Inc.
339 Gilj, Payat Avenue
Makati, Metro Manila 1200,
PHILIPPINES
TEL: (02) 899 9801

SINGAPORE

SWEET LEE MUSIC
COMPANY PTE. LTD.
150 Sims Drive,
SINGAPORE 387381
TEL: 6846-3676

TAIWAN

ROLAND TAIWAN
ENTERPRISE CO., LTD.
Room 5, 9th, No. 112 Chung
Shan N.Road Sec.2, Taipei,
TAIWAN, R.O.C.
TEL: (02) 2561 3339

THAILAND

Theera Music Co., Ltd.
330 Soi Verg NakornKasem,
New Road, Sumpantawongse,
Bangkok 10100, THAILAND
TEL: (02) 224-8821

AUSTRALIA/ NEW ZEALAND

AUSTRALIA/ NEW ZEALAND

Roland Corporation
Australia Pty.,Ltd.
38 Campbell Avenue
Dee Why West, NSW 2099
AUSTRALIA

For Australia
Tel: (02) 9982 8266
For New Zealand
Tel: (09) 3098 715

CENTRAL/LATIN AMERICA

ARGENTINA

Instrumentos Musicales S.A.
Av. Santa Fe 2055
(1123) Buenos Aires
ARGENTINA
TEL: (011) 4508-2700

BARBADOS

A&R Music Supplies LTD
12 Webster Industrial Park
Wildely, St.Michael, Barbados
TEL: (246)430-1100

BRAZIL

Roland Brasil Ltda.
Rua San Jose, 780 Sala B
Parque Industrial San Jose
Cofia - Sao Paulo - SP, BRAZIL
TEL: (011) 4615 5666

CHILE

Comercial Fancy II S.A.
Rut: 96.919.420-1
Natanjel Coq #739, 4th Floor
Santiago - Centro, CHILE
TEL: (02) 688-9540

COLOMBIA

Centro Musical Ltda.
Cra 43 B No 25 A 41 Bododega 9
Medellin, Colombia
TEL: (574)3812529

COSTA RICA

JUAN Bansbach Instrumentos
Musicales
Ave.1, Calle 11, Apartado
10237,
San Jose, COSTA RICA
TEL: 258-0211

CURACAO

Zeelandia Music Center Inc.
Orionweg 30
Curacao, Netherland Antilles
TEL:(305)5926866

DOMINICAN REPUBLIC

Instrumentos Fernando Giraldez
Calle Proyecto Central No.3
Ens. La Esperilla
Santo Domingo,
Dominican Republic
TEL:(809) 683 0305

ECUADOR

Mas Musica
Rumichaca 822 y Zaruma
Guayaquil - Ecuador
TEL:(593-4)2302364

EL SALVADOR

OMNI MUSIC
75 Avenida Norte y Final
Alameda Juan Pablo II,
Edificio No.4010 San Salvador,
EL SALVADOR
TEL: 262-0788

GUATEMALA

Casa Instrumental
Calzada Roosevelt 34-01,zona 11
Ciudad de Guatemala
Guatemala
TEL:(502) 599-2888

HONDURAS

Almacén Pajaro Azul S.A. de CV.
BO.Paz Barahona
3 Ave.11 Calle S.O
San Pedro Sula, Honduras
TEL: (504) 553-2029

MARTINIQUE

Musique & Son
Z. L'Es-Mangie
97232 Le Lamentin
Martinique F.W.I.
TEL: 596 596 426800

Gigamusie SARL

10 Rte De La Folie
97200 Fort De France
Martinique F.W.I.
TEL: 596 596 715222

MEXICO

Casa Veerkamp, s.a. de cv.
Av. Toluca No. 323, Col. Olivar
de los Padres 01780 Mexico
D.F. MEXICO
TEL: (55) 5668-6699

NICARAGUA

Bansbach Instrumentos
Musicales Nicaragua
Alameda D'Este Calle Principal
de la Farmacia Sta.Avenida
1 Cuadra al Lago.#503
Managua, Nicaragua
TEL: (505)277-2557

PANAMA

SUPRO MUNDIAL S.A.
Boulevard Andrews, Albrook,
Panama City, REP. DE
PANAMA
TEL: 315-0101

PARAGUAY

Distribuidora De
Instrumentos Musicales
J.E. Olear y ESC. Mandavira
Asuncion PARAGUAY
TEL: (595) 21 492147

PERU

Audionet
Distribuciones Musicales SAC
Juan Fanning 530
Miraflores
Lima - Peru
TEL: (511) 4461388

TRINIDAD

AMR Ltd
Ground Floor
Maritime Plaza
Barataria Trinidad W.I.
TEL: (868) 638 6385

URUGUAY

Todo Musica S.A.
Francisco Acuna de Figueroa
1771
C.P.: 11.800
Montevideo, URUGUAY
TEL: (02) 924-2335

VENEZUELA

Instrumentos Musicales
Allegro,C.A.
Av.las industrias edf.Guitar
import
#7 zona Industrial de Turumo
Caracas, Venezuela
TEL: (212) 244-1122

EUROPE

AUSTRIA

Roland Elektronische
Musikinstrumente HmbH.
Austrian Office
Eduard-Bodem-Gasse 8,
A-6020 Innsbruck, AUSTRIA
TEL: (0512) 26 44 260

BELGIUM/FRANCE/ HOLLAND/ LUXEMBOURG

Roland Central Europe N.V.
Houtstraat 3, B-2260, Oevel
(Westerlo) BELGIUM
TEL: (014) 575811

CROATIA

ART-CENTAR
Degenova 3,
HR - 10000 Zagreb
TEL: (1) 466 8493

CZECH REP.

CZECH REPUBLIC
DISTRIBUTOR S.r.o.
Vocitova 247/16
CZ - 180 00 PRAHA 8,
CZECH REP.
TEL: (2) 830 20270

DENMARK

Roland Scandinavia A/S
Nordhavnsvej 7, Postbox 880,
DK-2100 Copenhagen
DENMARK
TEL: 3916 6200

FINLAND

Roland Scandinavia As, Filial
Finland
Elannontie 5
FN-01510 Vantaa, FINLAND
TEL: (09) 68 24 020

GERMANY

Roland Elektronische
Musikinstrumente HmbH.
Oststrasse 96, 22844
Norderstedt, GERMANY
TEL: (040) 52 60090

GREECE/CYPRUS

STOLLAS S.A.
Music Sound Light
155, New National Road
Patras 26442, GREECE
TEL: 2610 435400

HUNGARY

Roland East Europe Ltd.
Warehouse Area "DEPO" Pf.83
HUNGARY
TEL: (23) 511011

IRELAND

Roland Ireland
G2 Calmount Park, Calmount
Avenue, Dublin 12
Republic of IRELAND
TEL: (01) 4294444

ITALY

Roland Italy S. p. a.
Viale delle Industrie 8,
20020 Arese, Milano, ITALY
TEL: (02) 937-78300

NORWAY

Roland Scandinavia Avd.
Kontor Norge
Lilleakerveien 2 Postboks 95
Lilleaker N-0216 Oslo
NORWAY
TEL: 2273 0074

POLAND

ROLAND POLSKA SP. Z O.O.
Ul. Gibraltarska 4,
PL-03 664 Warszawa
POLAND
TEL: (022) 679 4419

PORTUGAL

Roland Iberia, S.L.
Portugal Office
Cais das Pedras, 8/9-1 Dto
4050-465, Porto, PORTUGAL
TEL: 22 608 00 60

ROMANIA

FBS LINES
Piata Libertatii 1,
535005 Cheorgheni,
ROMANIA
TEL: (266) 364 609

RUSSIA

MuTeK
Dorozhnaya ul.3,korp.6
P.O.Box 62, Doha, QATAR
TEL: (095) 981-4967

SLOVAKIA

DAN Acoustic s.r.o.
Povazska 18,
SK - 940 01 Nové Zámky
TEL: (035) 6424 330

SPAIN

Roland Iberia, S.L.
Povazska 18,
SK - 940 01 Nové Zámky
TEL: (035) 6424 330

SWEDEN

Roland Scandinavia A/S
SWEDISH SALES OFFICE
Danvik Center 28, 2 tr.
S-131 30 Nacka SWEDEN
TEL: (08) 702 00 20

SWITZERLAND

ROLAND (SWITZERLAND) AG
Landstrasse 5, Postfach,
CH-4452 Hittgen,
SWITZERLAND
TEL: (061) 927-8383

UKRAINE

EURHYTHMICS Ltd.
P.O.Box 37-a,
Nedecyev Str. 30,
UA - 89600 Mukachevo,
UKRAINE
TEL: (03131) 414-40

UNITED KINGDOM

Roland (U.K.) Ltd.
Atlantic Close, Swansea
Enterprise Park, SWANSEA
SA7 9FJ,
UNITED KINGDOM
TEL: (01792) 702701

BAHRAIN

MoH Stores
No.16, Bab Al Bahrain Avenue,
P.O.Box 247, Manama 304,
State of BAHRAIN
TEL: 17 211 005

IRAN

MOCO INC.
No.41 Nile St, Dr.Shariyati Ave,
Robeyroo Cerahie Mirdamad,
Tehran, IRAN
TEL: (021) 285-4169

ISRAEL

Halilhi P. Greenspoon & Sons
Ltd.
8 Retzif Ha'aliya Hashnya St.
Tel-Aviv-Yafo ISRAEL
TEL: (03) 6823666

JORDAN

MUSIC HOUSE CO. LTD.
FREDDY FOR MUSIC
P. O. Box 922846
Amman 11192 JORDAN
TEL: (06) 5692696

KUWAIT

EASA HUSAIN AL-YOUSIFI
& SONS CO.
Abdullah Salem Street,
Safat, KUWAIT
Tel: 243-6399

LEBANON

Chahine S.A.L.
Gerge Zeidan St., Chahine
Bldg., Achrafieh, P.O.Box: 16-
5857
Beirut, LEBANON
TEL: (01) 20-1441

OMAN

TALENTIZ CENTRE L.L.C.
Malatan House No.1
Al Noor Street, Ruwi
SULTANATE OF OMAN
TEL: 2478 3443

QATAR

Al Emadi Co. (Badie Studio &
Stores)
P.O. Box 62, Doha, QATAR
TEL: 4423-554

SAUDI ARABIA

aDawiah Universal
Electronics APL
Corniche Road, Aldossary
Bldg., 1st Floor, Alkhobar,
SAUDI ARABIA
P.O.Box 2154, Alkhobar 31952
SAUDI ARABIA
TEL: (03) 898 2081

SYRIA

Technical Light & Sound
Center
Rawda, Abdul Qader Jazairi St.
Bldg. No. 21, P.O.BOX 13520,
Damascus, SYRIA
TEL: (011) 223-5384

TURKEY

ZUHAI DIS TICARET A.S.
Galip Dede Cad. No.57
Beyoglu - Istanbul / TURKEY
TEL: (0212) 249 85 10

U.A.E.

Zak Electronics & Musical
Instruments Co. L.L.C.
Zabeel Road, Al Sheroq Bldg.,
No. 14, Grand Floor, Dubai,
U.A.E.
TEL: (04) 3360715

NORTH AMERICA

ROLAND CANADA LTD.
(Head Office)
5480 Parkwood Way
Richmond B.C., V6V 2M4
CANADA
TEL: (604) 270 6626

ROLAND CANADA LTD.

(Toronto Office)
170 Admiral Boulevard
Mississauga On L5T 2N6
CANADA
TEL: (905) 362 9707

U. S. A.

Roland Corporation U.S.
5100 S. Eastern Avenue
Los Angeles, CA 90040-2938,
U. S. A.
TEL: (323) 890 3700

As of November 1, 2006 (ROLAND)



04566667

07-04-1N