

 Roland®

U-110

Owner's Manual

 **Roland**

MIDI **PCM SOUND MODULE**

U-110

Owner's Manual

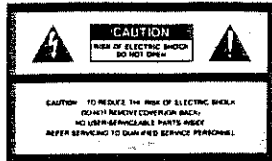

The lightning flash with arrowhead symbol, within an equilateral triangle, is intended to alert the user to the presence of uninsulated "dangerous voltage" within the product's enclosure that may be of sufficient magnitude to constitute a risk of electric shock to persons.



The exclamation point within an equilateral triangle is intended to alert the user to the presence of important operating and maintenance (servicing) instructions in the literature accompanying the product.

INSTRUCTIONS PERTAINING TO A RISK OF FIRE, ELECTRIC SHOCK OR INJURY TO PERSONS.

IMPORTANT SAFETY INSTRUCTIONS

WARNING When using electric products, basic precautions should always be followed, including the following:

1. Read all the instructions before using the product.
2. Do not use this product near water—for example, near a bathtub, washbowl, kitchen sink, in a wet basement, or near a swimming pool, or the like.
3. This product should be used only with a cart or stand that is recommended by the manufacturer.
4. This product, either alone or in combination with an amplifier and headphones or speakers, may be capable of producing sound levels that could cause permanent hearing loss. Do not operate for a long period of time at a high volume level or at level that is uncomfortable. If you experience any hearing loss or ringing in the ears, you should consult an audiologist.
5. The product should be located so that its location or position does not interfere with its proper ventilation.
6. The product should be located away from heat sources such as radiators, heat registers or other products that produce heat.
7. The product should avoid using in where it may be effected by dust.
8. The product should be connected to a power supply only of the type described in the operating instructions or as marked on the product.
9. The power-supply cord of the product should be unplugged from the outlet when left unused for a long period of time.
10. Do not tread on the power-supply cord.
11. Do not pull the cord but hold the plug when unplugging.
12. When setting up with any other instruments, the procedure should be followed in accordance with instruction manual.
13. Care should be taken so that objects do not fall and liquids are not spilled into the enclosure through openings.
14. The product should be serviced by qualified service personnel when:
 - A: The power-supply cord or the plug has been damaged; or
 - B: Objects have fallen, or liquid has been spilled into the product; or
 - C: The product has been exposed to rain; or
 - D: The product does not appear to operate normally or exhibits a marked change in performance; or
 - E: The product has been dropped, or the enclosure damaged.
15. Do not attempt to service the product beyond that described in the user-maintenance instructions. All other servicing should be referred to qualified service personnel.

SAVE THESE INSTRUCTIONS

ADVARSEL !

Lithiumbatteri. Eksplosionsfare.
Udskiftning må kun foretages af en sagkyndig,
og som beskrevet i servicemanual.

WARNING !

Lithiumbatteri. Explosionsrisk.
Får endast bytas av behörig servicetekniker.
Se instruktioner i servicemanualen.

ADVARSEL !

Lithiumbatteri. Fare for eksplosion.
Må bare skiftes av kvalifisert tekniker som
beskrevet i servicemanualen.

VAROITUS !

Lithiumparisto. Räjähdyksvaara.
Pariston saa vaihtaa ainoastaan
alan ammottimies.

WARNING

THIS APPARATUS MUST BE EARTH GROUNDED.

The three conductors of the mains lead attached to this apparatus are identified with color as shown in the table below, together with the matching terminal on the UK type power plug. When connecting the mains lead to a plug, be sure to connect each conductor to the correct terminal, as indicated. "This instruction applies to the product for United Kingdom."

MAINS LEADS		PLUG
Conductor	Color	Mark on the matching terminal
Live	Brown	Red or letter L
Neutral	Blue	Black or letter N
Ground/itg	Green-Yellow	Green, Green-Yellow, letter E or symbol

Bescheinigung des Herstellers / Importeurs

Hiermit wird bescheinigt, daß der/die/sas

ROLAND PCM SOUND MODULE U-110

(Gerät, Typ, Bezeichnung)

in Übereinstimmung mit den Bestimmungen der

Amtsbl. Vfg 1046 / 1984

(Anstellungsverfügung)

funk-entstört ist.

Der Deutschen Bundespost wurde das Inverkehrbringen dieses Gerätes angezeigt und die Berechtigung zur Überprüfung der Serie auf Einhaltung der Bestimmungen eingeräumt.

Roland Corporation Osaka / Japan

Name des Herstellers/Importeurs

RADIO AND TELEVISION INTERFERENCE

"Warning - This equipment has been verified to comply with the limits for a Class B computing device, pursuant to Subpart J, of Part 15, of FCC rules. Operation with non-certified or non-verified equipment is liable to result in interference to radio and TV reception."

The equipment described in this manual generates and uses radio-frequency energy. If it is not installed and used properly, that is, in strict accordance with our instructions, it may cause interference with radio and television reception.

This equipment has been tested and found to comply with the limits for a Class B computing device in accordance with the specifications in Subpart J, of Part 15, of FCC Rules. These rules are designed to provide reasonable protection against such a interference in a residential installation. However, there is no guarantee that the interference will not occur in a particular installation. If this equipment does cause interference to radio or television reception, which can be determined by turning the equipment on and off, the user is encouraged to try to correct the interference by the following measures:

• Disconnect other devices and their input/output cables one at a time. If the interference stops, it is caused by either the other device or its I/O cable.

• These devices usually require twisted shielded I/O cables. For Roland devices, you can obtain the proper shielded cable from your dealer. For non-Roland devices, contact the manufacturer or dealer for assistance.

If your equipment does cause interference to radio or television reception, you can try to correct the interference by using one or more of the following measures:

- Turn the TV or radio antenna until the interference stops.
- Move the equipment to one side or the other of the TV or radio.
- Move the equipment farther away from the TV or radio.
- Plug the equipment into an outlet that is on a different circuit than the TV or radio. (That is, make certain the equipment and the radio or television set are on circuits controlled by different circuit breakers or fuses.)
- Consider installing a rooftop television antenna with coaxial cable lead-in between the antenna and TV.

If necessary, you should consult your dealer or an experienced radio/television technician for additional suggestions. You may find helpful the following booklet prepared by the Federal Communications Commission:

"How to Identify and Resolve Radio-TV Interference Problems."

This booklet is available from the U.S. Government Printing Office, Washington, D.C. 20402, Stock No. 004-000-003-5-4.

U-110 Patch Setting Chart (Factory Preset)

Patch No.	Patch Name	Part 1	Part 2	Part 3	Part 4	Part 5	Part 6	Output Mode
		Tone Name Output Assign MIDI Channel Key Range	Tone Name Output Assign MIDI Channel Key Range	Tone Name Output Assign MIDI Channel Key Range	Tone Name Output Assign MIDI Channel Key Range	Tone Name Output Assign MIDI Channel Key Range	Tone Name Output Assign MIDI Channel Key Range	
01	Ac. Piano	A.PIANO 2 1 1 C-1 to G9	--- OFF --- ---	--- OFF --- ---	--- OFF --- ---	--- OFF --- ---	--- OFF --- ---	22
02	Brt Piano	A.PIANO 3 1 1 C-1 to G9	--- OFF --- ---	--- OFF --- ---	--- OFF --- ---	--- OFF --- ---	--- OFF --- ---	22
03	ff Piano	A.PIANO 7 1 1 C-1 to G9	--- OFF --- ---	--- OFF --- ---	--- OFF --- ---	--- OFF --- ---	--- OFF --- ---	22
04	Wide Piano	A.PIANO 2 1 1 C-1 to B1	A.PIANO 2 5 1 C2 to B2	A.PIANO 2 3 1 C3 to B3	A.PIANO 2 4 1 C4 to B4	A.PIANO 2 6 1 C5 to B5	A.PIANO 2 2 1 C6 to G9	20
05	Double A. P	A.PIANO 3 1 1 C-1 to G9	A.PIANO 3 2 1 C-1 to G9	--- OFF --- ---	--- OFF --- ---	--- OFF --- ---	--- OFF --- ---	8
06	Dtun Piano	A.PIANO 8 1 1 C-1 to G9	--- OFF --- ---	--- OFF --- ---	--- OFF --- ---	--- OFF --- ---	--- OFF --- ---	22
07	E. Piano	E.PIANO 1 1 1 C-1 to G9	--- OFF --- ---	--- OFF --- ---	--- OFF --- ---	--- OFF --- ---	--- OFF --- ---	22
08	Double E. P	E.PIANO 1 1 1 C-1 to G9	E.PIANO 1 2 1 C-1 to G9	--- OFF --- ---	--- OFF --- ---	--- OFF --- ---	--- OFF --- ---	8
09	Detune E. P	E.PIANO 5 1 1 C-1 to G9	--- OFF --- ---	--- OFF --- ---	--- OFF --- ---	--- OFF --- ---	--- OFF --- ---	22
10	Hard E. P	E.PIANO 4 1 1 C-1 to G9	--- OFF --- ---	--- OFF --- ---	--- OFF --- ---	--- OFF --- ---	--- OFF --- ---	22
11	Vibraphone	VIB 1 1 1 C-1 to G9	--- OFF --- ---	--- OFF --- ---	--- OFF --- ---	--- OFF --- ---	--- OFF --- ---	22
12	Hard Vib	VIB 3 1 1 C-1 to G9	--- OFF --- ---	--- OFF --- ---	--- OFF --- ---	--- OFF --- ---	--- OFF --- ---	22
13	Detune Bell	BELL 2 1 1 C-1 to G9	--- OFF --- ---	--- OFF --- ---	--- OFF --- ---	--- OFF --- ---	--- OFF --- ---	22
14	Marimba	MARIMBA 1 1 C-1 to G9	--- OFF --- ---	--- OFF --- ---	--- OFF --- ---	--- OFF --- ---	--- OFF --- ---	22
15	A. Guitar	A.GUITAR 1 1 1 C-1 to G9	--- OFF --- ---	--- OFF --- ---	--- OFF --- ---	--- OFF --- ---	--- OFF --- ---	22
16	Double A. G	A.GUITAR 2 1 1 C-1 to G9	A.GUITAR 2 2 1 C-1 to G9	--- OFF --- ---	--- OFF --- ---	--- OFF --- ---	--- OFF --- ---	8
17	12str A. G	A.GUITAR 4 1 1 C-1 to A#4	A. GUITAR 3 1 1 B4 to G9	--- OFF --- ---	--- OFF --- ---	--- OFF --- ---	--- OFF --- ---	21
18	Mute Sw EG	E.GUITAR 1 1 1 C-1 to G9	--- OFF --- ---	--- OFF --- ---	--- OFF --- ---	--- OFF --- ---	--- OFF --- ---	22
19	Double E.G	E.GUITAR 4 1 1 C-1 to G9	E.GUITAR 4 2 1 C-1 to G9	--- OFF --- ---	--- OFF --- ---	--- OFF --- ---	--- OFF --- ---	8
20	Slap Bass	SLAP 1 1 1 C-1 to G9	--- OFF --- ---	--- OFF --- ---	--- OFF --- ---	--- OFF --- ---	--- OFF --- ---	22

Patch No.	Patch Name	Part 1	Part 2	Part 3	Part 4	Part 5	Part 6	Output Mode
		Tone Name Output Assign MIDI Channel Key Range	Tone Name Output Assign MIDI Channel Key Range	Tone Name Output Assign MIDI Channel Key Range	Tone Name Output Assign MIDI Channel Key Range	Tone Name Output Assign MIDI Channel Key Range	Tone Name Output Assign MIDI Channel Key Range	
21	Detune Bass	SLAP 4 1 1 C-1 to G9	OFF --- ---	OFF --- ---	OFF --- ---	OFF --- ---	OFF --- ---	22
22	V-Sw Slap	SLAP 11 1 1 C-1 to G9	OFF --- ---	OFF --- ---	OFF --- ---	OFF --- ---	OFF --- ---	22
23	Fing Bass	FINGERED 1 1 1 C-1 to G9	OFF --- ---	OFF --- ---	OFF --- ---	OFF --- ---	OFF --- ---	22
24	Pick Bass	PICKED 2 1 1 C-1 to G9	OFF --- ---	OFF --- ---	OFF --- ---	OFF --- ---	OFF --- ---	22
25	Fless Bass	FRETLESS 1 1 1 C-1 to G9	OFF --- ---	OFF --- ---	OFF --- ---	OFF --- ---	OFF --- ---	22
26	Ac. Bass	AC.BASS 1 1 C-1 to G9	OFF --- ---	OFF --- ---	OFF --- ---	OFF --- ---	OFF --- ---	22
27	Synth Bass	SYN.BASS 1 1 C-1 to G9	OFF --- ---	OFF --- ---	OFF --- ---	OFF --- ---	OFF --- ---	22
28	Choir	CHOIR 1 1 1 C-1 to G9	OFF --- ---	OFF --- ---	OFF --- ---	OFF --- ---	OFF --- ---	22
29	Oct Choir	CHOIR 3 1 1 C-1 to G9	OFF --- ---	OFF --- ---	OFF --- ---	OFF --- ---	OFF --- ---	22
30	Double Chr	CHOIR 1 1 1 C-1 to G9	CHOIR 2 1 1 C-1 to G9	OFF --- ---	OFF --- ---	OFF --- ---	OFF --- ---	8
31	Strings	STRINGS 1 1 1 C-1 to G9	OFF --- ---	OFF --- ---	OFF --- ---	OFF --- ---	OFF --- ---	22
32	Double Str	STRINGS 3 1 1 C-1 to G9	STRINGS 3 2 1 C-1 to G9	OFF --- ---	OFF --- ---	OFF --- ---	OFF --- ---	8
33	E. Organ	E.ORGAN 1 1 1 C-1 to G9	OFF --- ---	OFF --- ---	OFF --- ---	OFF --- ---	OFF --- ---	22
34	Double Org1	E. ORGAN 4 1 1 C-1 to G9	E. ORGAN 4 2 1 C-1 to G9	OFF --- ---	OFF --- ---	OFF --- ---	OFF --- ---	8
35	Double Org2	E. ORGAN 5 1 1 C-1 to G9	E. ORGAN 5 2 1 C-1 to G9	OFF --- ---	OFF --- ---	OFF --- ---	OFF --- ---	8
36	Soft Tp	SOFT TP 1 1 1 C-1 to G9	OFF --- ---	OFF --- ---	OFF --- ---	OFF --- ---	OFF --- ---	22
37	Tp/Tromb	TP / TRB 1 1 1 C-1 to G9	OFF --- ---	OFF --- ---	OFF --- ---	OFF --- ---	OFF --- ---	22
38	Oct Tp/Trb	TP / TRB 6 1 1 C-1 to G9	OFF --- ---	OFF --- ---	OFF --- ---	OFF --- ---	OFF --- ---	22
39	Sax	SAX 1 1 1 C-1 to G9	OFF --- ---	OFF --- ---	OFF --- ---	OFF --- ---	OFF --- ---	22
40	Bright Sax	SAX 3 1 1 C-1 to G9	OFF --- ---	OFF --- ---	OFF --- ---	OFF --- ---	OFF --- ---	22
41	Detune Sax	SAX 4 1 1 C-1 to G9	OFF --- ---	OFF --- ---	OFF --- ---	OFF --- ---	OFF --- ---	22
42	Oct Sax	SAX 5 1 1 C-1 to G9	OFF --- ---	OFF --- ---	OFF --- ---	OFF --- ---	OFF --- ---	22

Patch No.	Patch Name	Part 1	Part 2	Part 3	Part 4	Part 5	Part 6	Output Mode
		Tone Name Output Assign MIDI Channel Key Range	Tone Name Output Assign MIDI Channel Key Range	Tone Name Output Assign MIDI Channel Key Range	Tone Name Output Assign MIDI Channel Key Range	Tone Name Output Assign MIDI Channel Key Range	Tone Name Output Assign MIDI Channel Key Range	
43	Brass	BRASS 1 1 1 C-1 to G9	OFF ---- ---- ----	OFF ---- ---- ----	OFF ---- ---- ----	OFF ---- ---- ----	OFF ---- ---- ----	22
44	Oct Brass	BRASS 3 1 1 C-1 to G9	OFF ---- ---- ----	OFF ---- ---- ----	OFF ---- ---- ----	OFF ---- ---- ----	OFF ---- ---- ----	22
45	Double Brs	BRASS 1 1 1 C-1 to G9	BRASS 1 2 1 C-1 to G9	OFF ---- ---- ----	OFF ---- ---- ----	OFF ---- ---- ----	OFF ---- ---- ----	8
46	Flute	FLUTE 1 1 1 C-1 to G9	OFF ---- ---- ----	OFF ---- ---- ----	OFF ---- ---- ----	OFF ---- ---- ----	OFF ---- ---- ----	22
47	Dtn Flute	FLUTE 2 1 1 C-1 to G9	OFF ---- ---- ----	OFF ---- ---- ----	OFF ---- ---- ----	OFF ---- ---- ----	OFF ---- ---- ----	22
48	Shakuhachi	SHAKU 1 1 1 C-1 to G9	OFF ---- ---- ----	OFF ---- ---- ----	OFF ---- ---- ----	OFF ---- ---- ----	OFF ---- ---- ----	22
49	Drums	DRUMS 1 1 C-1 to G9	OFF ---- ---- ----	OFF ---- ---- ----	OFF ---- ---- ----	OFF ---- ---- ----	OFF ---- ---- ----	22
50	Double Drm	DRUMS 1 1 C-1 to G9	DRUMS 2 1 C-1 to G9	OFF ---- ---- ----	OFF ---- ---- ----	OFF ---- ---- ----	OFF ---- ---- ----	8
51	Short Drm	DRUMS 1 1 C-1 to G9	OFF ---- ---- ----	OFF ---- ---- ----	OFF ---- ---- ----	OFF ---- ---- ----	OFF ---- ---- ----	22
52	Fantasy	BELL 1 1 1 C-1 to G9	VIB 3 2 1 C-1 to G9	CHOIR 1 1 1 C-1 to G9	CHOIR 1 2 1 C-1 to G9	A. PIANO 3 1 1 C-1 to G9	A. PIANO 3 1 1 C-1 to G9	13
53	Brs + Str	BRASS 3 1 1 C-1 to G9	STRINGS 3 1 1 C-1 to G9	TP / TRB 1 1 1 C-1 to G9	BRASS 1 1 1 C-1 to G9	OFF ---- ---- ----	OFF ---- ---- ----	21
54	5th Br + Str	BRASS 3 1 1 C-1 to G9	STRINGS 3 1 1 C-1 to G9	TP / TRB 1 1 1 C-1 to G9	BRASS 1 1 1 C-1 to G9	OFF ---- ---- ----	OFF ---- ---- ----	21
55	Choir + Str	CHOIR 3 1 1 C-1 to G9	STRINGS 3 1 1 C-1 to G9	OFF ---- ---- ----	OFF ---- ---- ----	OFF ---- ---- ----	OFF ---- ---- ----	21
56	Thick Bell	BELL 1 1 1 C-1 to G9	BELL 1 1 1 C-1 to G9	BELL 1 1 1 C-1 to G9	BELL 1 1 1 C-1 to G9	BELL 1 1 1 C-1 to G9	BELL 1 1 1 C-1 to G9	21
57	Guit > Piano	A.GUITAR 1 1 1 C-1 to G9	A.PIANO 7 1 1 C-1 to G9	OFF ---- ---- ----	OFF ---- ---- ----	OFF ---- ---- ----	OFF ---- ---- ----	22
58	Tramp > Sax	TP / TRB 4 1 1 C-1 to G9	SAX 1 1 1 C-1 to G9	OFF ---- ---- ----	OFF ---- ---- ----	OFF ---- ---- ----	OFF ---- ---- ----	22
59	Sax / Tp	TP / TRB 4 1 1 C-1 to G9	SAX 1 2 1 C-1 to G9	OFF ---- ---- ----	OFF ---- ---- ----	OFF ---- ---- ----	OFF ---- ---- ----	8
60	Multi - Set1	DRUMS 3 10 C-1 to G9	AC.BASS 4 2 C-1 to G9	A.PIANO 2 1 1 C-1 to G9	A.GUITAR 1 1 3 C-1 to G9	TP / TRB 5 4 C-1 to G9	SAX 1 6 5 C-1 to G9	49
61	Multi - Set2	DRUMS 3 10 C-1 to G9	SLAP 9 4 2 C-1 to G9	E.PIANO 2 5 1 C-1 to G9	E.GUITAR 1 6 3 C-1 to G9	BRASS 1 1 4 C-1 to G9	SAX 3 1 5 C-1 to G9	49
62	Multi - Set3	DRUMS 3 10 C-1 to G9	FINGERED 1 4 2 C-1 to G9	A.PIANO 7 5 1 C-1 to G9	E.GUITAR 1 6 3 C-1 to G9	BRASS 3 1 4 C-1 to G9	E.ORGAN 3 1 5 C-1 to G9	49
63	Multi - Set4	DRUMS 3 10 C-1 to G9	SYN.BASS 1 4 2 C-1 to G9	VIB 1 1 1 C-1 to G9	A.GUITAR 3 1 3 C-1 to G9	CHOIR 1 5 4 C-1 to G9	STRINGS 2 6 5 C-1 to G9	49
64	Multi - Set5	DRUMS 3 10 C-1 to G9	FRETLESS 1 4 2 C-1 to G9	E.PIANO 1 1 1 C-1 to G9	STRINGS 3 1 4 C-1 to G9	E.GUITAR 3 5 3 C-1 to G9	FLUTE 1 6 5 C-1 to G9	49

The patch No. 60 - 64, the volume level of each part is set at 127 (max) for using the multi output.

U-110 Preset Tones Chart

No.	Tone Name	Tone Type	Split/Threshold	Contents
Piano				
01	A. PIANO 1	V-MIX		mellow tone
02	A. PIANO 2	V-MIX		
03	A. PIANO 3	V-MIX - 8		bright tone
04	A. PIANO 4	V-MIX		honky tonk piano
05	A. PIANO 5	SINGLE		soft touch
06	A. PIANO 6	DETUNE		soft touch
07	A. PIANO 7	SINGLE		hard touch
08	A. PIANO 8	DETUNE		hard touch
09	A. PIANO 9	SINGLE		hard touch and bright tone
10	A. PIANO 10	DETUNE		hard touch and bright tone
E. Piano				
11	E. PIANO 1	V-MIX		soft and hard touch
12	E. PIANO 2	SINGLE		soft touch
13	E. PIANO 3	DETUNE		soft touch
14	E. PIANO 4	SINGLE		hard touch
15	E. PIANO 5	DETUNE		hard touch
Vibraphone				
16	VIB 1	SINGLE		soft touch
17	VIB 2	DETUNE		soft touch
18	VIB 3	V-MIX		soft and hard touch
Bell				
19	BELL 1	SINGLE		long release
20	BELL 2	DETUNE		long release
21	BELL 3	SINGLE		short release
22	BELL 4	DETUNE		short release
Marimba				
23	MARIMBA	SINGLE		
Guitar				
24	A. GUITAR 1	SINGLE		
25	A. GUITAR 2	DETUNE		
26	A. GUITAR 3	DUAL		
27	A. GUITAR 4	DUAL		
28	A. GUITAR 5	V-SW	v = 100	Includes the sound one octave lower Slow attack/Fast attack
29	E. GUITAR 1	V-SW	v = 100	Mute/Non-mute
30	E. GUITAR 2	SINGLE		Mute
31	E. GUITAR 3	SINGLE		Non-mute
32	E. GUITAR 4	DETUNE		Non-mute
Bass				
33	SLAP 1	SINGLE	E2 (40)	Thump/pull
34	SLAP 2	DETUNE	E2 (40)	Thump/pull
35	SLAP 3	SINGLE	B2 (47)	Thump/pull
36	SLAP 4	DETUNE	B2 (47)	Thump/pull
37	SLAP 5	V-SW	v = 100	Thump/pull
38	SLAP 6	V-SW	v = 100	Slow attack/Fast attack
* The keys more than F#4 (66) contains the harmonics sound in SLAP 1 to 6.				
39	SLAP 7	SINGLE	E2 (40)	Thump/pull
40	SLAP 8	DETUNE	E2 (40)	Thump/pull
41	SLAP 9	SINGLE	B2 (47)	Thump/pull
42	SLAP 10	DETUNE	B2 (47)	Thump/pull
43	SLAP 11	V-SW	v = 100	Thump/pull
44	SLAP 12	V-SW	v = 100	Slow attack/Fast attack
* The keys more than C#4 (61) contains the harmonics sound in SLAP 7 to 12.				
45	FINGERED 1	SINGLE		
46	FINGERED 2	DETUNE		
* The keys more than C#5 (73) contains the harmonics sound in FINGERED 1 and 2.				
47	PICKED 1	SINGLE		

No.	Tone Name	Tone Type	Split/Threshold	Contents
Bass				
48	PICKED 2	DETUNE		
49	FRETLESS 1	SINGLE		
50	FRETLESS 2	DETUNE		
* The keys more than D#6 (87) contains the harmonics sound in FRETLESS 1 and 2.				
51	AC. BASS	V-MIX		Fret-noise is slightly mixed.
52	SYN. BASS 1	V-MIX		Soft and hard touch
53	SYN. BASS 2	SINGLE		Soft touch
54	SYN. BASS 3	SINGLE		Hard touch
Choir				
55	CHOIR 1	SINGLE		Long release
56	CHOIR 2	SINGLE		Short release
57	CHOIR 3	DUAL		Long release (Includes the sound one octave lower)
58	CHOIR 4	DUAL		Short release (Includes the sound one octave lower)
Strings				
59	STRINGS 1	SINGLE	-5	Long release
60	STRINGS 2	SINGLE		Short release
61	STRINGS 3	DUAL		Long release (Includes the sound one octave lower)
62	STRINGS 4	DUAL		Short release (Includes the sound one octave lower)
Organ				
63	E. ORGAN 1	SINGLE		
64	E. ORGAN 2	DETUNE		
65	E. ORGAN 3	SINGLE		
66	E. ORGAN 4	DETUNE		
67	E. ORGAN 5	SINGLE	-4	
68	E. ORGAN 6	DETUNE		
69	E. ORGAN 7	SINGLE		
70	E. ORGAN 8	DETUNE		
71	E. ORGAN 9	DUAL		
72	E. ORGAN 10	DUAL		
73	E. ORGAN 11	DUAL		
74	E. ORGAN 12	DUAL		
75	E. ORGAN 13	DUAL		
Wind				
76	SOFT TP 1	SINGLE		
77	SOFT TP 2	DETUNE		
78	SOFT TP 3	SINGLE		Sforzand piano
79	TP / TRB 1	SINGLE		
80	TP / TRB 2	SINGLE		Mellow tone
81	TP / TRB 3	SINGLE		Bright tone
82	TP / TRB 4	SINGLE		Sforzand piano
83	TP / TRB 5	DETUNE		
84	TP / TRB 6	DUAL		Includes the sound one octave lower
85	SAX 1	SINGLE		
86	SAX 2	SINGLE		Mellow tone
87	SAX 3	SINGLE		Bright tone
88	SAX 4	DETUNE		
89	SAX 5	DUAL		Includes the sound one octave lower
90	BRASS 1	SINGLE		
91	BRASS 2	SINGLE		Sforzand piano
92	BRASS 3	DUAL		Includes the sound one octave lower
93	BRASS 4	DUAL		BRASS & SAX
94	BRASS 5	DUAL		TP / TRB & SAX
95	FLUTE 1	SINGLE		
96	FLUTE 2	DETUNE		
97	SHAKU 1	SINGLE		
98	SHAKU 2	DETUNE		
Drums				
99	DRUMS	SINGLE	-1	See "DRUMS SETTING CHART"

* The voicing capacity or the upper limit of the key range may vary with the tones you select.

Drums Setting Chart

	Note Name	Tone Name
	B1 (35)	Bass Drum 1
	C2 (36)	Bass Drum 2
C2	C#2 (37)	Rim Shot
	D2 (38)	Snare Drum 1
	D#2 (39)	Hand Clap
	E2 (40)	Snare Drum 2
	F2 (41)	Low Tom Tom 1
	F#2 (42)	Closed High Hat 1
	G2 (43)	Low Tom Tom 2
	G#2 (44)	Open High Hat 2
	A2 (45)	Middle Tom Tom 1
	A#2 (46)	Open High Hat 1
	B2 (47)	Middle Tom Tom 2
C3	C3 (48)	High Tom Tom 1
	C#3 (49)	Crash Cymbal
	D3 (50)	High Tom Tom 2
	D#3 (51)	Ride Cymbal
	E3 (52)	China Cymbal
	F3 (53)	Cup (Mute)
	F#3 (54)	Off
	G3 (55)	Off
	G#3 (56)	Cowbell
	A3 (57)	Crash Cymbal
	A#3 (58)	Snare Drum 3
C4	B3 (59)	Ride Cymbal
	C4 (60)	Off
	C#4 (61)	Off
	D4 (62)	Off
	D#4 (63)	Off
	E4 (64)	Off
	F4 (65)	Off
	F#4 (66)	Off
	G4 (67)	Off
	G#4 (68)	Off
	A4 (69)	Cabasa
	A#4 (70)	Off
	B4 (71)	Off
C5	C5 (72)	Off
	C#5 (73)	Off
	D5 (74)	Off
	D#5 (75)	Off
	E5 (76)	Off
	F5 (77)	Off
	F#5 (78)	Off
	G5 (79)	High Pitch Tom Tom 2
	G#5 (80)	Off
	A5 (81)	High Pitch Tom Tom 1
	A#5 (82)	Off
	B5 (83)	Off
C6	C6 (84)	Bass Drum 3
	C#6 (85)	Bass Drum 4
	D6 (86)	Snare Drum 4
	D#6 (87)	Snare Drum 5
	E6 (88)	Snare Drum 6
	F6 (89)	Low Tom Tom 3
	F#6 (90)	Closed High Hat 2
	G6 (91)	Middle Tom Tom 3
	G#6 (92)	China Cymbal
	A6 (93)	High Tom Tom 3
	A#6 (94)	Ride Cymbal
	B6 (95)	Off
C7	C7 (96)	Off

U-110 PCM SOUND MODULE

Owner's Manual

Thank you for purchasing the Roland PCM Sound Module U-110.

Please read the separate "MIDI" before reading this owner's manual.

Copyright © 1988 by ROLAND CORPORATION

All rights reserved. No part of this publication may be reproduced in any form without the written permission of ROLAND CORPORATION.

PANEL DESCRIPTIONS

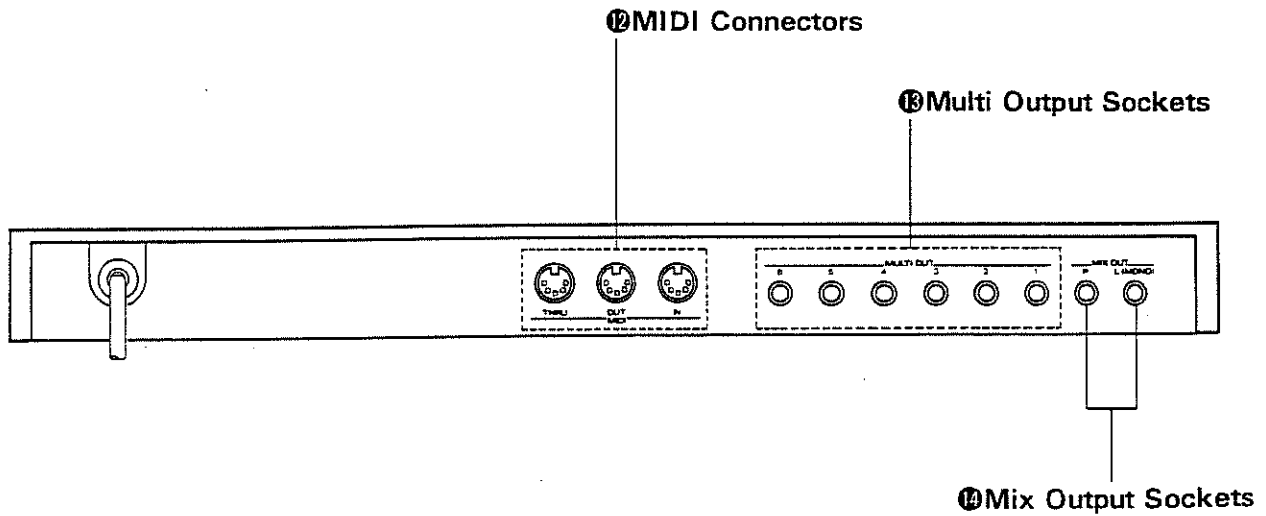
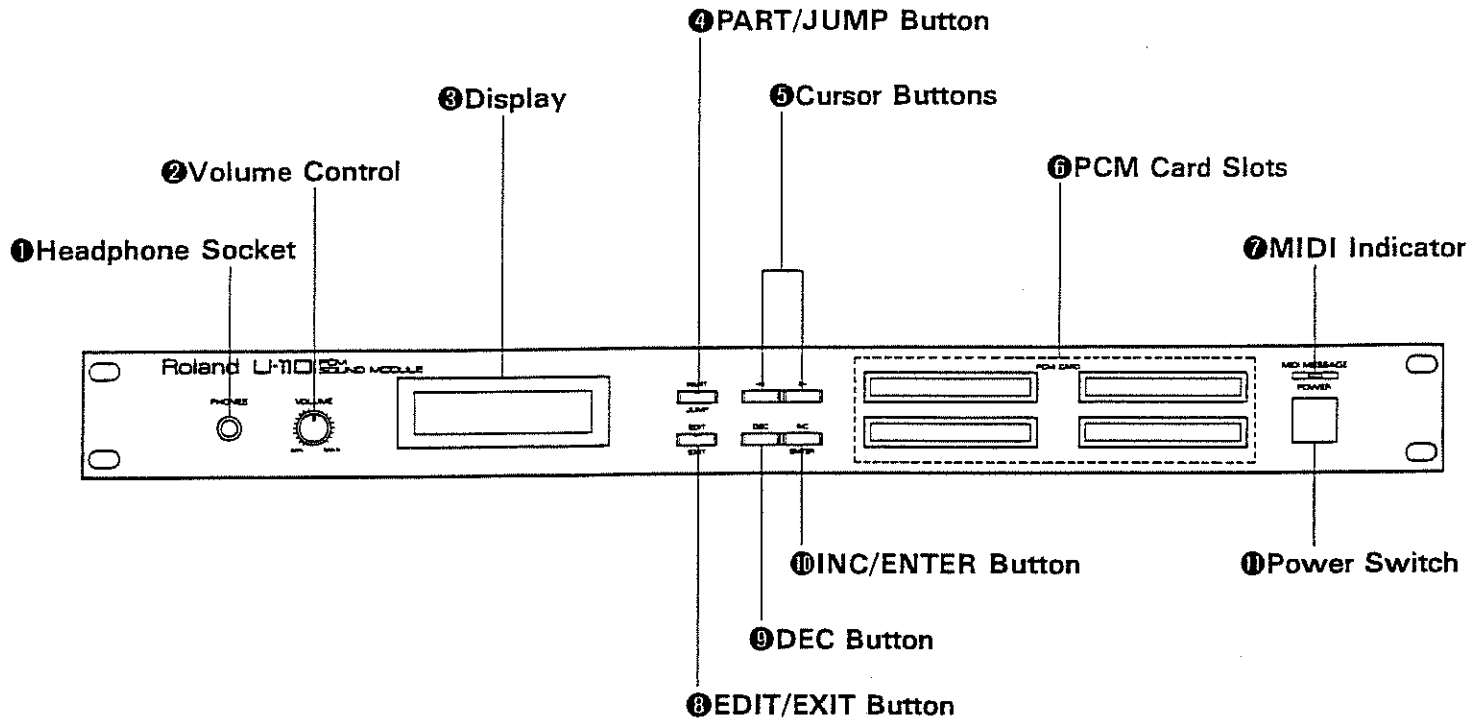

① PHONES (Headphones Socket)

Connect headphones to this socket. (Optimum are those with 8 to 150 ohm impedance.) Even while headphones are connected, sounds are sent through the Output Socket.

② VOLUME (Volume Control)

This adjusts the level of the sound sent through the Mix Output or Headphones Socket.

③ Display (Back lit)

This shows the current condition of the unit.

④ PART/JUMP (Part/Jump Button)

Press this button for selecting a Part or using the Page Jump/Mark function.

⑤ ◀ ▶ (Cursor Buttons)

Use these buttons to move the cursor for selecting a function or parameter shown in the Display.

⑥ PCM Card Slot

This is where the ROM card is to be inserted.

⑦ MIDI MESSAGE (MIDI Message Indicator)

This is lit while MIDI signals are being received.

⑧ EDIT/EXIT (Edit/Exit Button)

Press this button to enter the Edit mode. (The indicator lights up.) In the Edit mode, pressing the same button will shift the modes, finally returning to the Play mode.

⑨ DEC (Decrement Button)

In the Play mode, this button changes Patches. In the Edit mode, it can be used to change the values of a parameter, etc. Pressing the button decreases a number.

⑩ INC/ENTER (Increment/Enter Button)

In the Play mode, this button changes Patches. In the Edit mode, it can be used to change the values of a parameter (in the parameter setting display) or to select a parameter (in the menu display), etc. Pressing the button increases a number.

⑪ POWER (Power Switch)

This switches on or off the unit.

⑫ MIDI Connectors

These are for connecting MIDI devices.

⑬ MULTI OUT (Multi Output Sockets)

These are independent output sockets for the Voice Groups.

⑭ MIX OUT (Mix Output Sockets)

These are stereo output sockets. The sound sent through the Multi Output is not sent through the Mix Outputs.

■ IMPORTANT NOTES

◇ Power Supply ◇

- The appropriate power supply for this unit is shown on its name plate. Please make sure that the line voltage in your country meets the requirement.
- Do not use the same socket used for any noise generating device. (such as a motor or variable lighting system.)
- Make sure that the unit is turned off before connecting the power plug to the AC socket.
- When disconnecting the power plug from the socket, do not pull the cord but hold the plug to avoid damaging the cord.
- Avoid damaging the power cord.
- If the unit is not to be used for a long period of time, unplug the cord from the socket.
- It is normal for this unit to become hot while being operated.
- Check with your local Roland dealer if you wish to use this unit in a foreign country.
- Disconnect the AC cord immediately in the event of an electrical storm.

◇ Connections ◇

- Before setting up this U-110 with other MIDI devices, turn this unit off along with all other units.
- If you connect the instrument (this unit) to the amplifier with switched on, be sure to connect the cord to the instrument first, and when disconnecting, disconnect the cord from the amplifier first.

◇ Cabinet Cleaning Care ◇

- For cleaning the unit, use a dry and soft cloth.
- If the casing is stained, use a cloth slightly dampened with water.
- To remove stubborn stains, clean the casing with a cloth coated with a neutral detergent, then wipe it dry with a soft cloth.
- Do not use solvents such as paint thinner.

◇ Room Location ◇

- Avoid using this device in excessive heat or humidity conditions, or where it may be affected by direct sunlight or dust and avoid places subject to high vibration.

●Operating the unit near a neon light, fluorescent lamp, TV or CRT Display, may cause noise interference. If so, change the angle or the position of the unit.

●Operating this unit near a TV or radio may cause picture or noise interference. If this happens, move the unit away from these instruments.

●If a device with a large-sized transformer, such as a power amplifier, is mounted just above this device, hum may be produced.

●Do not place or drop anything heavy on the main unit or its power cord.

◇Memory Back Up System◇

●This unit features a memory back - up system that retains the data even after switched off. The battery that supports the backup circuit should be replaced every five years. Call the Roland service station for a battery replacement. (The first replacement may be required before five years, depending on how much time had passed before you purchased the unit.)

●When the battery is low, the Display defaults as shown below, and the data in the memory may be lost.

"Check Battery !"

●Although we do our utmost to protect your data during repairs, sometimes, especially when working on the memory itself or on a related area, some of our important data may be lost. Keep a separate record of all the data that you consider important. This can be done by saving it into the Memory Card or by writing it down on a sheet of paper.

◇How To Handle The Unit◇

●Adjust the volume control to a level that will not disturb the neighborhood, especially at night when sounds can travel over long distance.

●Do not allow fluid or foreign matter, such as water, beverages, coins and wires, to enter this unit.

●Do not examine or modify the internal components or circuitry. Electrical shocks or damage may result.

●Do not subject this unit to strong shocks, or move it while the power is on.

●If this unit fails to operate correctly, turn it off immediately and contact your Roland dealer.

■ TABLE OF CONTENTS

■ Panel Description	4
■ Important Notes	6

Basic Course

① Outline of the U-110	10
1. Features of the U-110	10
2. U-110's Modes	11
3. Structure of the U-110	13
4. Tone and the Number of Voices ..	15
② Connections	16
③ Play	17
1. Power-up	17
2. Setting the MIDI Receive Channel	18
3. Tone Selection	
(Changing sounds in each Part) ...	20
4. Memory Cards	23
5. Master Tuning	25
6. Output Modes	26
7. Output Assign	29
8. Part Level Setting	31
9. Pitch Setting	32
④ Patch	34
1. Patch Name	35
2. Patch Write	36
3. Patch Selection	38

Advance Course

① Basic Procedure	42
1. Basic Procedure in each Mode ...	42
2. Page Jump	45
② Play Mode	46
③ Setup Mode	48
1. Editing Procedure	48
2. Setup Parameters	49

④ Patch Edit Mode	52
1. Editing Procedure	54
2. Patch Parameters	55
a. Common Setting	55
b. Part Setting	58
c. Writing Mode	64
⑤ Utility Mode	66
1. Data Transfer (via MIDI)	66
a. Data Transfer to another U-110	66
b. Data Transfer to	
a MIDI sequencer	68
c. Data Transfer from	
a MIDI sequencer	68
2. LCD Contrast	69
3. ROM Play	70

Reference

① Troubleshooting	72
1. Before Calling for Repairs	72
2. Error Messages	74
② Appendix Tables	76
1. Parameter Table	76
2. Preset Tone Table	78
3. Blank Chart	81
■ Roland Exclusive Messages	84
■ MIDI Implementation	88
■ Specifications	93

Basic Course

1 Outline of the U-110	P. 10
------------------------	-------

2 Connections	P. 16
---------------	-------

3 Play	P. 17
--------	-------

4 Patch	P. 34
---------	-------

1 OUTLINE OF THE U-110

The U-110 is a PCM sound module which features many great functions. It can, for example, be used as extra sound sources for a MIDI keyboard or a MIDI sequencer.

1. Features of the U-110

- **DC – PCM Sound Source** The U-110 features DC-PCM sound sources, to retain high quality sounds.

- **Multi Timbral Function** The U-110's Multi Timbral function allows you to enjoy ensemble performance using only one sound module. In other words, one U-110 performs as several sound modules.

- **Multi Outputs** Six outputs are provided to allow you to send the audio signal of each sound separately. Thus, it is possible to use external effects independently for each sound and perform complex mixing.

- **Part** A Part can be regarded as equivalent to a signal conventional sound module. The U-110 features six Parts which can individually have MIDI channels, therefore each Part can be controlled separately.

- **Tone** A Tone is a basic sound unit. The U-110's memory stores up to 99 different preprogrammed Tones.

- **Patch** A Patch consists of sound data for each Part and effect settings, etc. The U-110 can store up to 64 different Patches which you can call instantaneously.

- **Built – in Digital Effects** The U-110 contains digital Chorus and Tremolo effects which create spacious stereo effects. The effect setting can be written with each Patch.

- **Memory Card** Optional memory cards (sound libraries) can be used for increasing the number of sounds. Up to four memory cards can be used at the same time.

2. U-110's Modes

The U-110's operation modes are divided into several groups as shown below, so that you can quickly access the desired procedure.

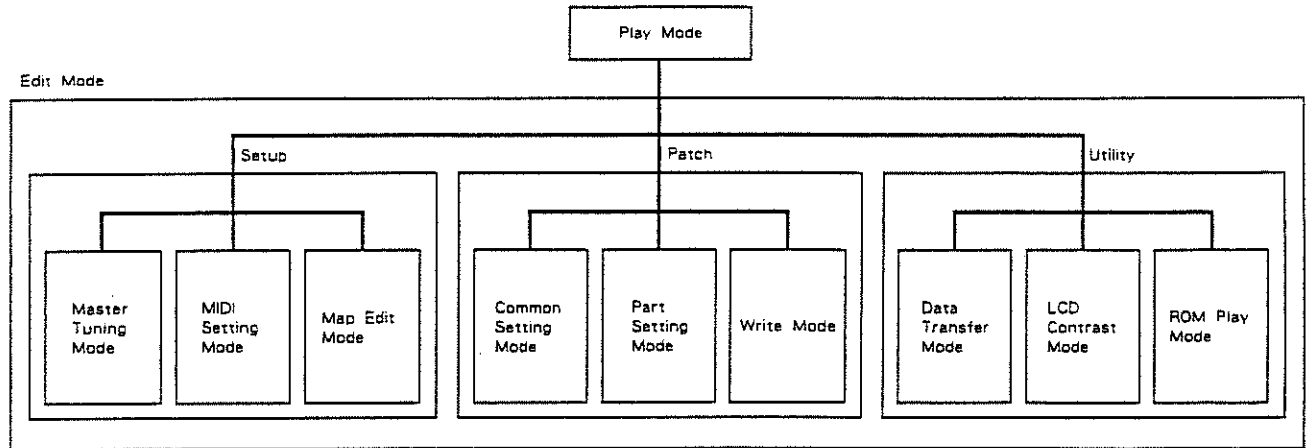

Play Mode

This is the normal playing mode. Allows checking of the parameter settings for each Part.

Setup Mode

Includes the following three functions :

- **Master Tuning**

Master Tuning parameters are edited.

- **MIDI Setting**

MIDI controls for all Parts are set.

- **Map Edit**

Map of the Tone Numbers and Program Change Numbers is set.

Patch Edit Mode

This mode contains the following three functions :

- **Common Setting**

Patch Name, Output or Effect settings are edited.

- **Part Setting**

Tone, Volume or MIDI channel of each Part are set.

- **Write Mode**

Patches are written into memory.

Utility Mode

This mode contains the following three functions :

- **Data Transfer**

Data transfer between the U-110 and an external device can be performed.

- **LCD Contrast**

The contrast of the Display can be adjusted.

- **ROM Play**

The U-110 plays the ROM data to demonstrate the excellent quality of the sounds.

3. Structure of the U-110

The U-110 may be described as several sound modules :

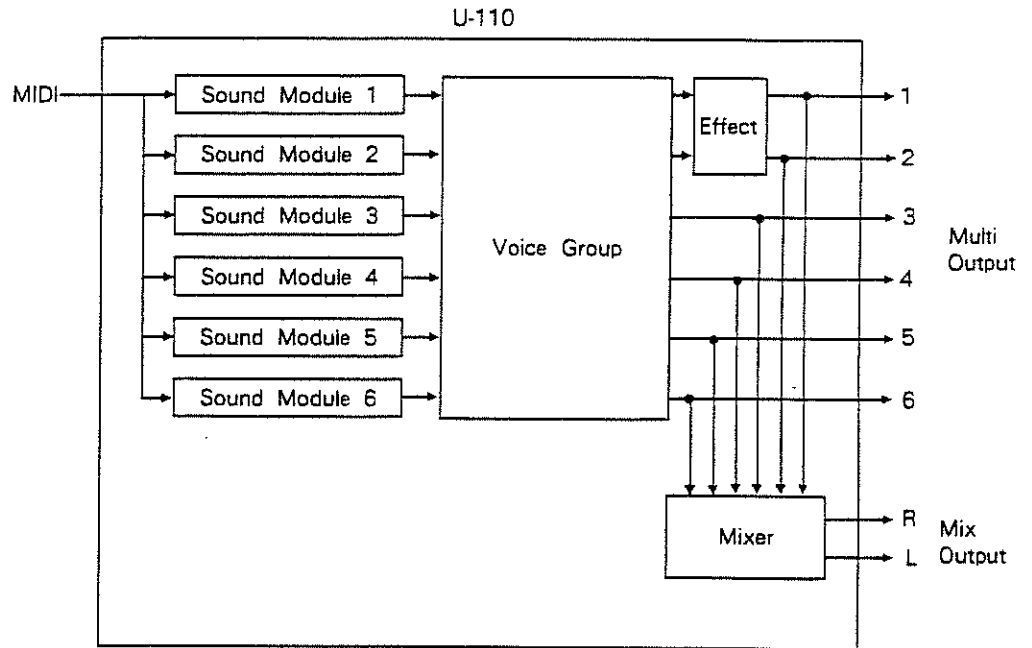

Tone

Each sound used (sampled) in the U-110 is called Tone. The U-110 stores 99 different preprogrammed Tones. You can extend the total memory capacity by using optional Memory Cards (sound libraries).

Part

One Part corresponds to one conventional sound module. The U-110 has six Parts (1 to 6) which can serve like six independent sound modules. Each Part is accompanied by various parameters which determine how each tone should be played, etc.

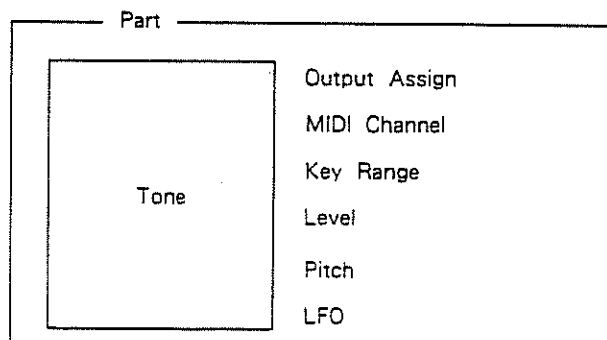

Patch

A Patch includes each Part's sound data (combination of Tones), effect settings, output mode, etc. It is here that you determine just how the U-110 will be used.

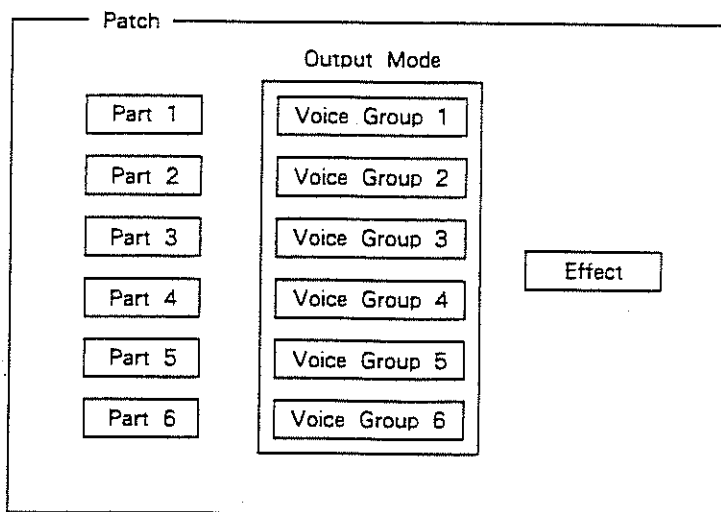

Multi Output and Mix Output

The U-110 features six independent Multi Outputs and a Mix Output which mixes all the six outputs. The Multi Outputs and Mix Output can be used at the same time, but the sound sent from the Multi Output is then not sent from the Mix Output. The Mix Output sends the sound imaging positioned as shown below according to the Output Assignment (which Voice Group should play which Part).

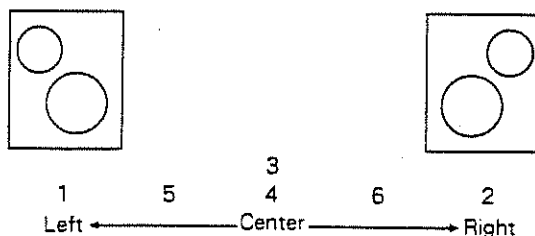

* Effect can be obtained only in the Voice Group 1 and 2's output.

4. Tone and the Number of Voices

The U-110 can play up to 31 voices at the same time. This, however, varies depending on the type of Tones to be played or the way the sounds are output. There are two types of Tones, a Tone consisting of one voice (Single, V – SW) and a Tone consisting of two voices (Dual, Detune, V – MIX). For instance, when a Tone that consists of two voices is played in 31 voice group, the maximum voices simultaneously played is 15 (any fraction is omitted). The maximum number of voices in each Part also varies depending on the Output Mode and Output Assignment.

	Number of voices	
Single	1	Tone made of one sound
V – SW (Velocity Switch)	1	Tone which selects one of two sounds depending on the key playing strength
Dual	2	Tone made of two different sounds
Detune	2	Tone made of two different pitches
V – MIX (Velocity Mix)	2	Tone which mixes two sounds in varying portions depending on the key playing strength

2 CONNECTIONS

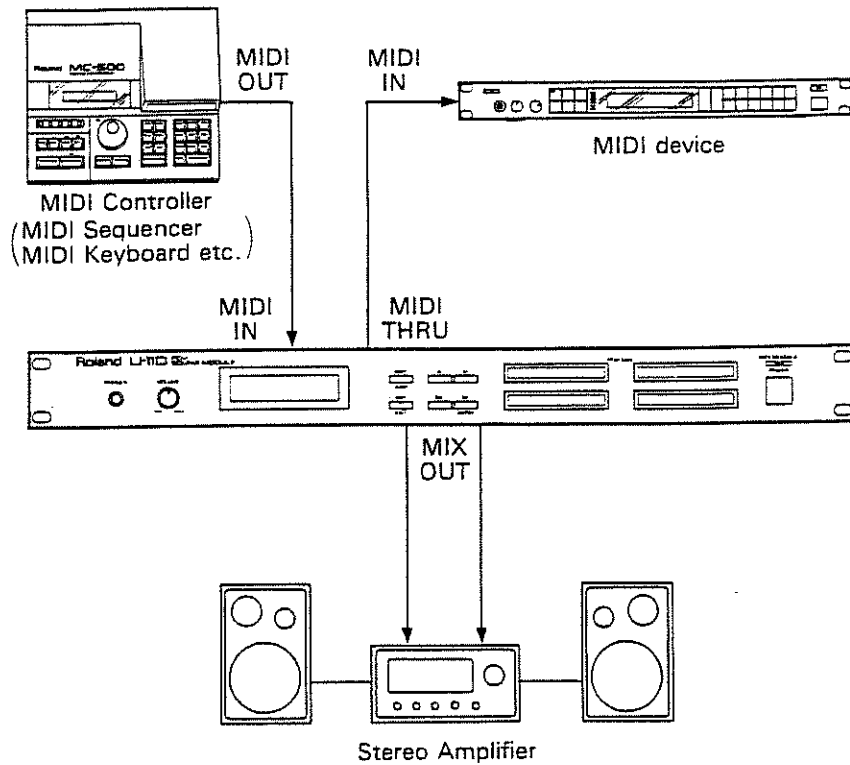

*The MIDI messages fed into the MIDI IN connector are output through the MIDI THRU connector. Theoretically, using MIDI THRU, any number of MIDI sound modules could be controlled by one controller unit.

In practice, however, connecting more than three MIDI sound modules may cause trouble. If you wish to connect more sound modules, use the optional MIDI Output Selector (MPU - 105) or MIDI Signal Indicator (A - 110).

*MIDI messages fed into the MIDI IN are not sent through the MIDI OUT.

*The sound sent from the Multi Output is not sent from the Mix Output.

*The supplied MIDI cable is specifically for MIDI connection. Do not use it for any other connection such as DIN Sync or audio setup.

3 PLAY

The U-110 is a sound module which is activated by MIDI messages sent from an external MIDI controller unit.

1. Power-up

Step 1 Make sure all the connections are correctly made, then switch the U-110 on.

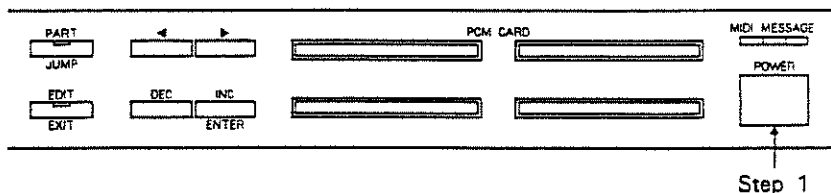

The Display responds as shown below :

```
PCM Sound Module
Roland U-110
```



```
P-01:Ac.Piano
M31|M31|*|*|*|*
```

Play Mode Display
(As an example)

Step 2 Switch on the connected MIDI controller unit.

2. Setting the MIDI Receive Channel

Channels of the connected MIDI devices should be set to the same numbers. If the receive channels of the U-110 are not set to the same numbers as the transmit channels of the controller unit, MIDI messages from the controller won't be received correctly, and the U-110 will not play properly. The U-110 allows you to set a MIDI receive channel separately for each Part. So set a MIDI receive channel for each Part you use.

Monitoring the current MIDI Receive Channel of each Part

The MIDI receive channel currently set for each Part can be monitored as follows :

Select the following display with  



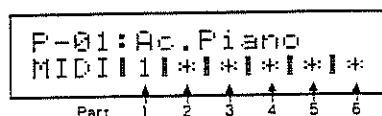



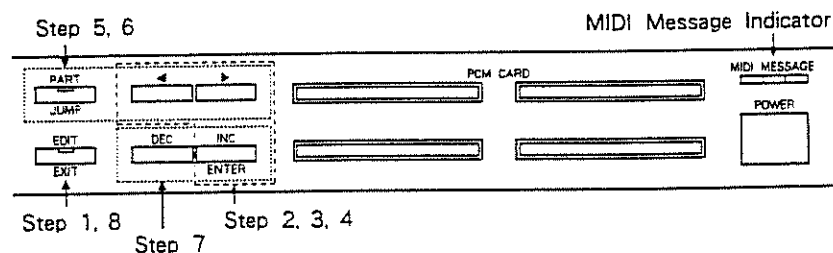

(In the Play Mode)



● "*" indicates an unused Part (a Part whose Output Assign is set to OFF).

Setting the MIDI Receive Channel



- Step 1 Press **EDIT** to enter the Edit mode (the indicator lights up).
- Step 2 Using  , select "PATCH" ("PATCH" should be blinking), then press **ENTER**.
- Step 3 Using  , select "PART", then press **ENTER**.
- Step 4 Using  , select "BAS", then press **ENTER**.
- Step 5 Using  , select "MIDI RCV. CH" display.

Step 6 Press **PART** (the indicator lights up), then select the Part whose MIDI channel you wish to set using **◀ ▶**.

Press **▶** for a higher number, **◀** for lower ones.

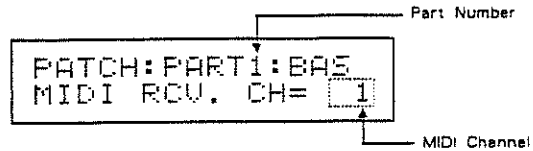

Step 7 Set the MIDI channel with **DEC** and **INC**. Press **INC** for a higher number, **DEC** for lower ones.

*When MIDI messages are received from the control unit, the MIDI Message Indicator on the U-110 lights up.

Step 8 Press **EXIT** four times to return to the Play mode (the indicator goes out).

The display will show "TEMP" by changing the settings.

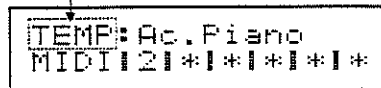

*The MIDI channel you have set will be erased when a different Patch is selected. To retain it, take an appropriate Patch Writing procedure (see page 36).

3. Tone Selection (Changing sounds in each Part)

99 different Tones are stored in the internal memory. If you wish to extend the memory capacity, use the optional memory cards (sound libraries).

Tone Selection within the U-110

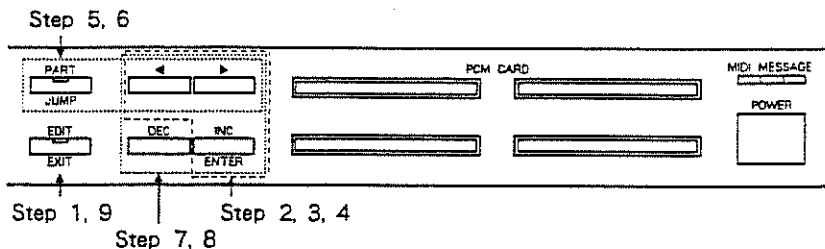

- Step 1 Press **EDIT** to enter the Edit mode (the indicator lights up.)
- Step 2 Using **◀ ▶**, select "PATCH" (cause "PATCH" to flash), then press **ENTER**.
- Step 3 Using **◀ ▶**, select "PART", then press **ENTER**.
- Step 4 Using **◀ ▶**, select "BAS", then press **ENTER**.
- Step 5 Using **◀ ▶**, select the next display.

The Display shows the Tone Number and Tone Name of the Tone currently assigned to the Part.

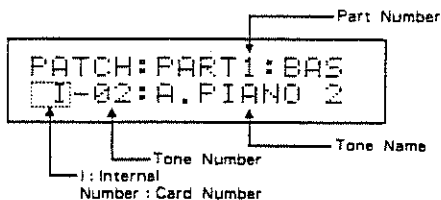

- Step 6 Press **PART** (the indicator lights up), then select the Part whose Tone you wish to set using **◀ ▶**.

Pressing **▶** increases the number and pressing **◀** decreases it.

Step 7 Select "Memory" section with **◀ ▶**, and select Internal or the number of the memory card with **DEC INC**.

*How to use memory cards is explained on page 23.

*If you select Tones from a memory card that is not connected securely or when no card is inserted at all, the Display shows "No Card!", but you can still select Tones from a memory card in advance.

Step 8 Select the "Tone Number" section with **◀ ▶**, then specify a Tone Number with **DEC INC**.

*Depending on the Tone you select, the maximum voices simultaneously played varies.

Step 9 Press **EXIT** four times to return to the Play mode (the indicator goes out).

*The edited data will be erased when a different Patch is selected. To retain it, take an appropriate Patch Writing procedure (see page 36).

Tone Selection from an External MIDI Control Unit

The Tones on the U-110 can be changed with Program Change messages sent from an external control unit. The Program Change number received on a MIDI channel assigned to a Part will select a corresponding Tone of the relevant Part.

The Program Change numbers correspond to the Tone numbers as shown below when the U-110 is released from the manufacturer. You may need to change the assignment (e.g. when using the Tone on a memory card). If so, follow page 51 "Map Edit".

Program Change Number	Tone Number
1	INT-01
2	INT-02
⋮	⋮
99	INT-99
100	INT-01
⋮	⋮
128	INT-29

All Parts are set to receive Program Change messages at the factory.

If your U-110 is set to ignore the Program Change messages, set to ON for each Part as shown below :

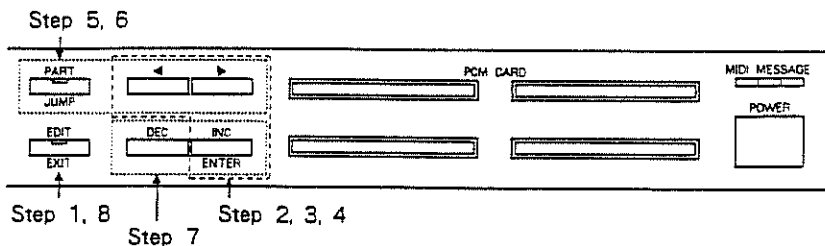

- Step 1 Press **EDIT** to enter the Edit mode (the indicator lights up).
- Step 2 Using **◀ ▶**, select "PATCH" ("PATCH" should be blinking), then press **ENTER** .
- Step 3 Using **◀ ▶**, select "PART", then press **ENTER** .
- Step 4 Using **◀ ▶**, select "BAS", then press **ENTER** .
- Step 5 Using **◀ ▶**, select "PGM CHANGE" display.



- Step 6 Press **PART** (the indicator lights up), then select the Part where you wish to receive Program Change using **◀ ▶**.
- Pressing **▶** increases the number and pressing **◀** decreases it.
- Step 7 Set the On/Off of the Program Change with **DEC INC** .
- Step 8 Press **EXIT** four times to return to the Play mode (the indicator goes out).

4. Memory Cards

Using the optional memory cards (sound libraries), you can increase the number of Tones available. Up to four memory cards can be used at the same time together with the internal memory.

Using Memory Cards

Securely insert a memory card into a Card Slot in the correct direction.

You can use any of the Card Slots.

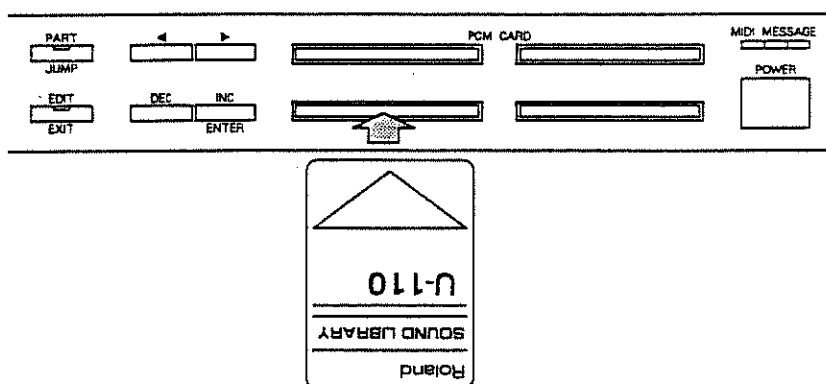

Specify the Card Number of the memory card you have connected and select a Tone Number as instructed in the previous section "Tone Selection".

*If you select a Tone on a memory card without the relevant memory card connected or without the card connected securely, "No Card!" message is shown in the Display, but you can still select a Tone on the memory card in advance.

*The number of Tones varies depending on the memory card. If no Tone is assigned to the selected Tone Number (no Tone Name is shown in the display), no sound is generated.

Checking if the Memory Card is correctly connected

When you select a Tone on a memory card, you can check if the memory card you are using is properly connected.

Using   call the following display (In the Play mode).

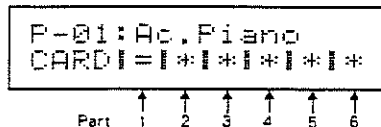

- When you have not specified any memory card or the memory card you have selected is correctly connected, "=" is shown in the Display.
- When the memory card you have selected is not connected, change to the memory card which is shown in the Display.
- The Parts not being used (the Parts where the Output Assign is set to OFF) are shown with "*".

5. Master Tuning

The Master Tuning function is used for tuning the U-110 to another musical instrument.

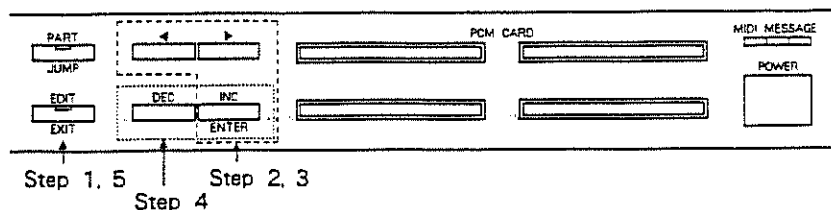

Step 1 Press **EDIT** to enter the Edit mode (the indicator lights up).

Step 2 Using **◀ ▶**, select "SETUP", then press **ENTER**.

Step 3 Using **◀ ▶**, select "M.TUNE", then press **ENTER**.

```

  SETUP : M. TUNE
  MST. TUNE = 0
  
```

Step 4 Set the desired pitch with **DEC** **INC**.
(0 : Middle A = 440Hz, variable range : - 99 to + 99 cents)

Pressing **DEC** lowers the pitch while pressing **INC** raises the pitch.

Step 5 Press **EXIT** three times to return to the Play mode (the indicator goes out).

*The Master Tuning you have set will be retained even after the unit is turned off.

6. Output Modes

The Output mode determines the number of voices sent through each Multi Output and whether or not to turn on the effect. The U-110's voices are divided into several Voice Groups. Each Voice Group can be sent out separately through the Multi Output sockets. There are 50 different combinations for the Voice Groups and the Multi Outputs.

*The Output Assign function allows you to select a Voice Group for each Part and assign it to one of the Multi Outputs (see page 29).

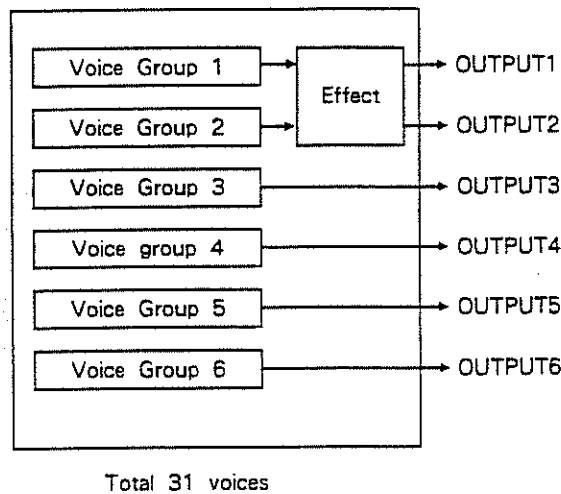

Monitoring the Output Mode

You can monitor the number of voices of each Voice Group as shown below:

Select the following display with   (In the Play mode).



● Output Modes

Mode No.	Voice Group					
	1	2	3	4	5	6
1	31					
2	27	4				
3	23	8				
4	23	4	4			
5	19	12				
6	19	8	4			
7	19	4	4	4		
8	15	16				
9	15	12	4			
10	15					
11	15	8	4	4		
12	15	4	4	4	4	
13	11	12	8			
14	11	12	4	4		
15	11	8	8	4		
16	11	8	4	4	4	
17	11	4	4	4	4	4
18	7	8	8	8		
19	7	8	8	4	4	
20	7	8	4	4	4	4
21	<L31>	<R31>				
22		M31				
23	<L16>	<R16>	15			
24		M16	15			
25	<L16>	<R16>	11	4		
26		M16	11	4		
27	<L16>	<R16>	7	8		
28		M16	7	8		
29	<L16>	<R16>	7	4	4	
30		M16	7	4	4	
31	<L16>	<R16>	3	4	4	4
32		M16	3	4	4	4
33	<L8>	<R8>	23			
34		MB	23			
35	<L8>	<R8>	19	4		
36		MB	19	4		
37	<L8>	<R8>	15	8		
38		MB	15	8		
39	<L8>	<R8>	15	4	4	
40		MB	15	4	4	
41	<L8>	<R8>	11	12		
42		MB	11	12		
43	<L8>	<R8>	11	8	4	
44		MB	11	8	4	
45	<L8>	<R8>	11	4	4	4
46		MB	11	4	4	4
47	<L8>	<R8>	7	8	8	
48		MB	7	8	8	
49	<L8>	<R8>	7	8	4	4
50		MB	7	8	4	4

*in the Output modes 21 to 50, Multi Outputs 1 and 2 are regarded as the same Voice Group, and effect can be turned on or off. The one without effect (M) is set to the center position of the sound imaging, and the one with effect is stereo output (L and R).

Setting the Output Mode

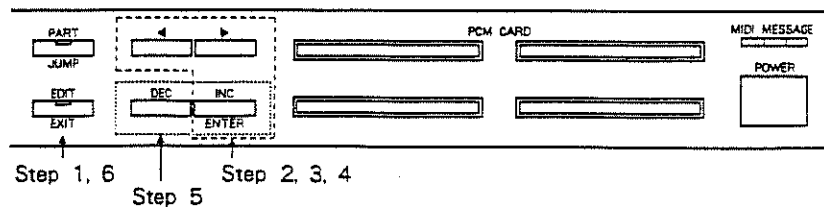

Step 1 Press **EDIT** to enter the Edit mode (the indicator lights up).

Step 2 Using **◀ ▶**, select "PATCH", then press **ENTER**.

Step 3 Using **◀ ▶**, select "COMMON", then press **ENTER**.

Step 4 Using **◀ ▶**, select "OUT", then press **ENTER**.

The Display shows the number of the Output Mode currently selected and the Voice Group.

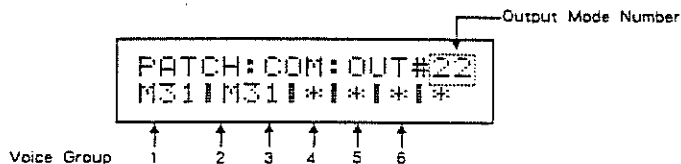

Step 5 Change the Output Number with **DEC** **INC**.

Step 6 Press **EXIT** four times to return to the Play mode (the indicator goes out).

*The edited data will be erased when a different Patch is selected. To retain it, take an appropriate Patch Writing procedure (see page 36).

7. Output Assign

The Output Assign function allows you to select a Voice Group for each Part and assign it to one of the Multi Outputs. It is possible to output more than one Part using the same Voice Group.

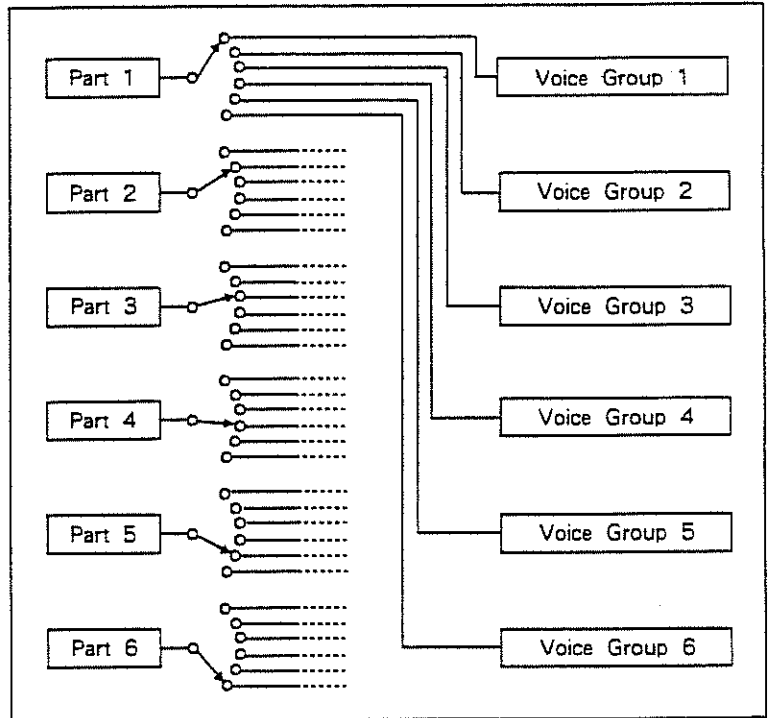



Each Voice Group is played as "Last Note Priority". When Note messages that exceed the maximum number of voices are received, the later Note messages are given priority, replacing the currently playing notes.

*When more than one Part are selected and assigned to the same Voice Group, some tones in the same Voice Group may be muted.

Monitoring the Output Assign

The number of the Voice Group currently assigned to each Part can be checked as shown below.

Call the following display with   .(In the Play mode)



●When Output Assign is set to OFF, "*" is displayed.

Setting the Output Assign

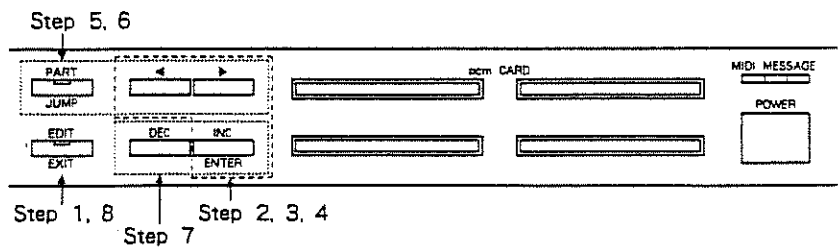

- Step 1 Press **EDIT** to enter the Edit mode (the indicator lights up.)
- Step 2 Using **◀ ▶**, select "PATCH", then press **ENTER**.
- Step 3 Using **◀ ▶**, select "PART", then press **ENTER**.
- Step 4 Using **◀ ▶**, select "BAS", then press **ENTER**.
- Step 5 Using **◀ ▶**, select "OUTPUT ASGN" display.

The Display shows the Voice Group number currently assigned to the Part.

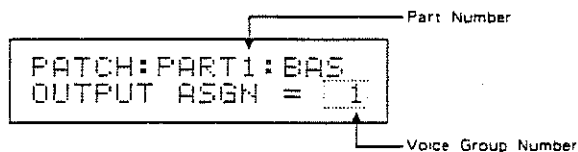

- Step 6 Press **PART** (the indicator lights up), then select the Part whose Output Assign is to be set using **◀ ▶**.

Pressing **▶** increases the number and pressing **◀** decreases.
- Step 7 Set the Voice Group Number (1 to 6 and OFF) with **DEC INC**. When it is set to OFF, the Part will not be played.
- Step 8 Press **EXIT** four times to return to the Play mode (the indicator goes out).

*The edited data will be erased when a different Patch is selected. To retain it, take an appropriate Patch Writing procedure (see page 36).

8. Part Level Setting

This sets the volume level of each Part, controlling the balance of the Parts.

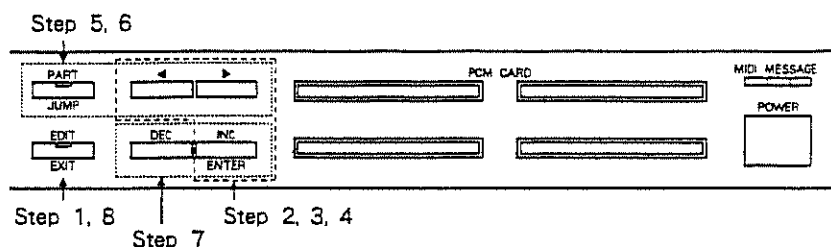

Step 1 Press **EDIT** to enter the Edit mode (the indicator lights up).

Step 2 Using **◀ ▶**, select "PATCH", then press **ENTER**.

Step 3 Using **◀ ▶**, select "PART", then press **ENTER**.

Step 4 Using **◀ ▶**, select "LEVEL", then press **ENTER**.

Step 5 Using **◀ ▶**, select "PART LEVEL" display.

The Display shows the volume of the Part currently selected.



Step 6 Press **PART** (the indicator lights up), then select the Part whose level is to be changed using **◀ ▶**.

Pressing **▶** increases the number and pressing **◀** decreases it.

Step 7 Set the volume (0 to 127) with **DEC** and **INC**.

Step 8 Press **EXIT** four times to return to the Play mode (the indicator goes out).

*The edited data will be erased when a different Patch is selected. To retain it, take an appropriate Patch Writing procedure (see page 36).

9. Pitch Setting

The pitch of the Tone assigned to each Part can be changed.

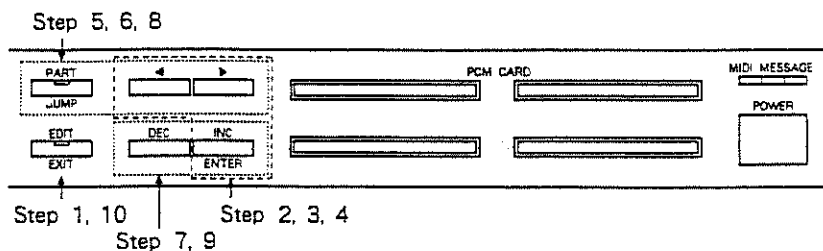

- Step 1 Press **EDIT** to enter the Edit mode (the indicator lights up).
- Step 2 Select "PATCH" using **◀ ▶**, then press **ENTER**.
- Step 3 Select "PART" using **◀ ▶**, then press **ENTER**.
- Step 4 Select "PIT" using **◀ ▶**, then press **ENTER**.
- Step 5 Call the "SHIFT CRS." display with **◀ ▶**.
- Step 6 Press **PART** (the indicator goes out), then using **◀ ▶**, select the Part whose pitch you wish to change.

```
PATCH:PART1:PIT
SHIFT CRS. = 0
```

- Step 7 Adjust the pitch in semi tone steps.(Variable range: -12 to +12 ; ±1octaves).

Pressing **DEC** lowers the pitch, while pressing **INC** raises the pitch.

- Step 8 To further adjust the pitch finely, press **PART** (the indicator goes out), then select the "SHIFT FINE" display.

```
PATCH:PART1:PIT
SHIFT FINE = 0
```



Step 9 Adjust the pitch with **DEC** and **INC** .(Variable range : -50 to +50 ; ± 50 cents)

Step 10 Press **EXIT** four times to return to the Play mode (the indicator goes out).

*The edited data is erased when a different Patch is selected. To retain it, take an appropriate Patch Writing procedure (see page 36).

4 PATCH

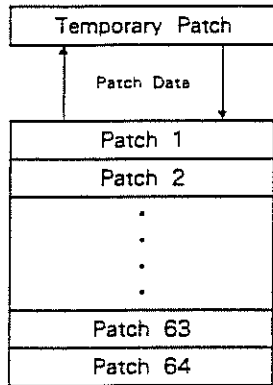
Parameter data of each Part, Patch Name, Output Mode and Effects you have edited are stored at a Temporary Patch. This, however, will be erased when a different Patch is selected. To retain the edited data, take an appropriate writing procedure (Patch Write). The U-110 can store up to 64 different Patches in the internal memory. Any of those Patches can be instantaneously recalled at any time you like.



*Data in a Temporary Patch can be retained even after the unit is switched off.

Parameters which can be written with a Patch are as follows :

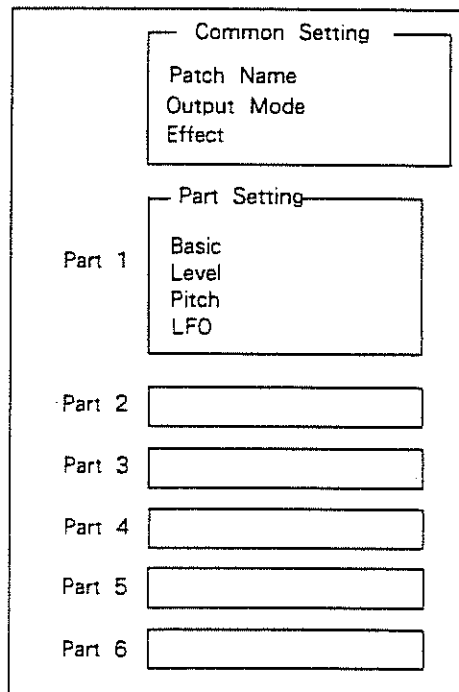

1. Patch Name

Each Patch can be named using up to 10 letters. It's a good idea to use names that easily remind you of what they do.

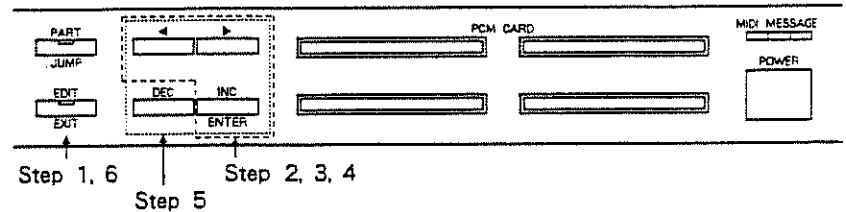

Step 1 Press **EDIT** to enter the Edit mode (the indicator lights up).

Step 2 Select "PATCH" using **◀ ▶**, then press **ENTER**.

Step 3 Select "COMMON" using **◀ ▶**, then press **ENTER**.

Step 4 Select "NAME" using **◀ ▶**, then press **ENTER**.

The Display shows the current Patch Name.

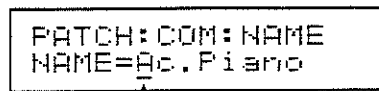

Step 5 Move the cursor (underline) with **◀ ▶** to the desired position, then change the letter with **DEC** and **INC**.

The available letters are as shown below :

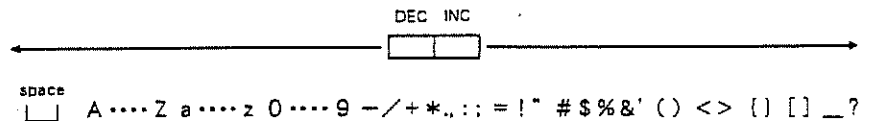

Step 6 Press **EXIT** four times to return to the Play mode (the indicator goes out).

2. Patch Write

The edited Patch data (temporary Patch data) can be written into a new location (Patch) in the internal memory.

Memory Protect

The U-110 features a Memory Protect function that protects data in memory from accidental erasure. To write an edited Patch, you must release the Memory Protect first.

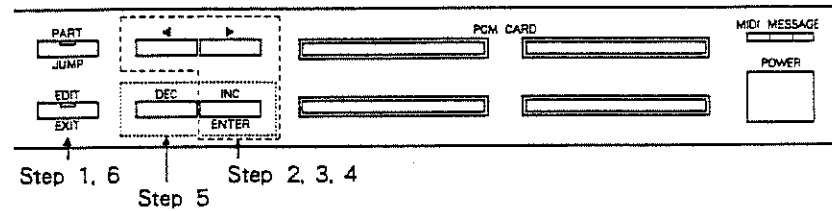

Step 1 Press **EDIT** to enter the Edit mode (the indicator lights up).

Step 2 Select "PATCH" using **◀ ▶**, then press **ENTER**.

Step 3 Select "WRT" using **◀ ▶**, then press **ENTER**.

Step 4 Select "MEM. P" using **◀ ▶**, then press **ENTER**.



Step 5 Set the Memory Protect to OFF with **DEC INC**.

Step 6 To continue to write, press **EXIT** once, then go to Step 4 in the following Writing Procedure.

*The Memory Protect setting will be retained even after the unit is turned off. Be sure to return the Memory Protect to ON every time you have finished writing to protect data in memory.

Writing Procedure

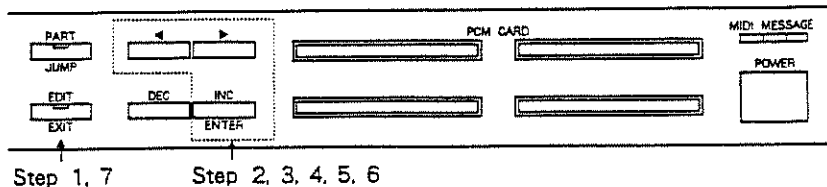

Step 1 Press **EDIT** to enter the Edit mode (the indicator lights up).

Step 2 Select "PATCH" using **◀ ▶**, then press **ENTER**.

Step 3 Select "WRT" using **◀ ▶**, then press **ENTER**.

Step 4 Select "WRITE" using **◀ ▶**, then press **ENTER**.

```
PATCH:WRT:WRITE
TMP → PATCH-01?
```

Specify the Patch Number

Step 5 Select the destination Patch (new location) using **◀ ▶**.

Step 6 Press **ENTER** to execute writing.

When the writing procedure is completed, the Display will respond as shown below for a while, then return to the display prior to the writing procedure.

```
PATCH:WRT:WRITE
Write Complete
```

Step 7 Press **EXIT** four times to return to the Play mode (the indicator goes out).

*If you try to write a Patch with the Memory Protect set to ON, the Display will respond as shown below. Set the Memory Protect to OFF, and perform the writing procedure again.

```
PATCH:WRT:WRITE
Memory Protected
```

*It's wide to keep a record of the setting of the Patch you have written on the Blank Chart (see page 81) for future use.

3. Patch Selection

You can call any of the 64 Patches stored in memory during live performance .

Patch Selection within the U-110

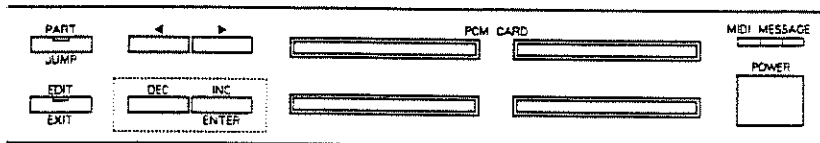

Press **DEC** or **INC** in the Play mode.

The Display shows the current Patch Number and the Patch Name.

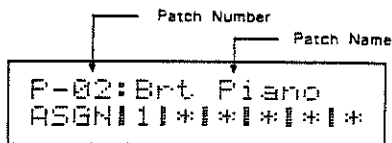

Patch Selection from an external MIDI Control Unit

The Patches in the U-110 can also be changed with the Program Change messages sent from an external MIDI control unit. Program Change messages are received on the set Control Channel.

The Program Change numbers correspond to the Patch Numbers as shown below :

Program Change	Patch Number
1	01
2	02
.	.
.	.
63	63
64	64
65	ignored
.	
.	
128	

*When the MIDI channel of a Part is set to the same channel as the Control Channel and Program Change function is set to ON on both channels, the corresponding Patch is selected according to the Program Change number first, then a Tone is selected.

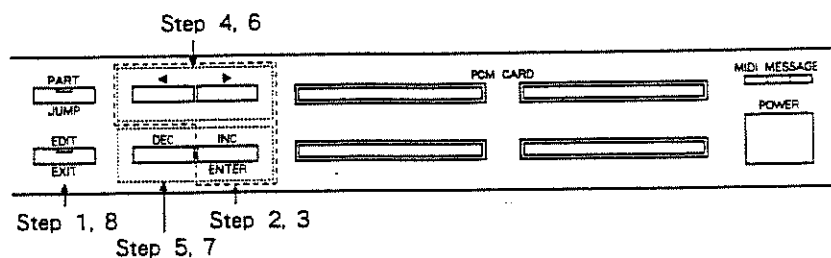

- Step 1 Press **EDIT** to enter the Edit mode (the indicator lights up).
- Step 2 Select "SETUP" using **◀ ▶**, then press **ENTER**.
- Step 3 Select "MIDI" using **◀ ▶**, then press **ENTER**.
- Step 4 Select the "CTRL CHANNEL" display using **◀ ▶**.
- ```

SETUP:MIDI
CTRL CHANNEL =16

```
- Step 5 Set the Control Channel with **DEC** and **INC**. (Variable range : 1 to 16)
- Step 6 Press the cursor button (**▶**) twice to call the "PGM CHANGE" display.
- ```

SETUP:MIDI
PGM CHANGE =OFF

```
- Step 7 Set ON or OFF the Program Change function with **DEC** or **INC**.
- Step 8 Press **EXIT** three times to return to the Play mode (the indicator goes out).

*In any mode other than the Play mode, the U-110's Patches are not changed with the Program Change messages.

*The Program Change and Control Channel settings will be retained even after the unit is switched off.

Advanced Course

1 Basic Procedure	P. 42
-------------------	-------

2 Play Mode	P. 46
-------------	-------

3 Setup Mode	P. 48
--------------	-------

4 Patch Edit Mode	P. 52
-------------------	-------

5 Utility Mode	P. 66
----------------	-------

1 Basic Procedure

1. Basic Procedure in each Mode

The U-110's parameters (functions) are divided into several modes and set out in a tree structure as shown below :

*If you cannot remember the current mode, press **EXIT** until the unit is returned to the Play mode.

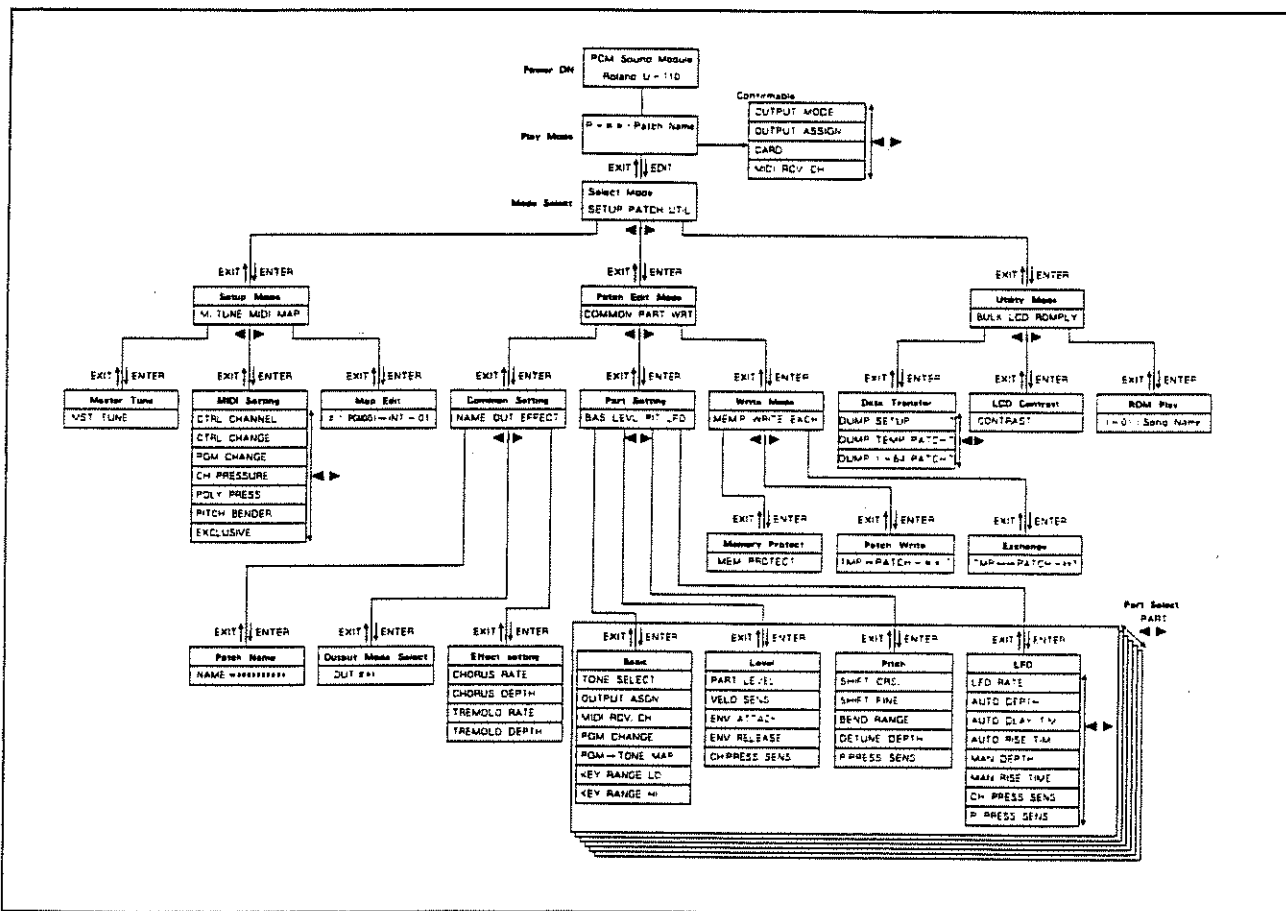

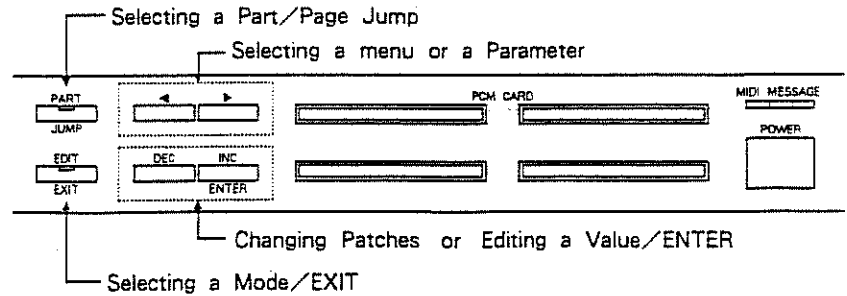

● **EDIT / EXIT**

Press this button to move from the Play mode to the Edit mode. When the unit is in the Edit mode, the indicator of this button is lit. Each press of this button in the Edit mode will move up to the previous branch and finally to the Play mode.

● **◀ ▶**

In the Play Mode these buttons change displays. In the Edit mode, they are used for selecting a menu or changing displays in the same function.

● **DEC INC / ENTER**





In the Play mode, these buttons are used for changing Patches. In the menu display of the Edit mode, **ENTER** should be pressed to move to another branches. Pressing **INC** increases a value to be set and **DEC** button decreases it. By pressing **INC** (or **DEC**) while holding **DEC** (or **INC**) down, the change of the number is quickened.

● **PART / JUMP**





This button can be used to jump to a display which has been written in memory (Page Jump function). The Page Jump function is available either in the Play or Edit mode. In the Part setting display of the Edit mode, this button is used for selecting a Part. Each time **PART** is pressed, the indicator alternately lights up and goes out. When the indicator is lit, the cursor buttons (**◀ ▶**) can select a **PART** and when it is not lit, the cursor buttons select a display residing on the same layer.

	PART/JUMP	EDIT/EXIT	CURSOR (◀ ▶)	DEC	INC/ENTER
Play Mode	Page Jump	Mode Selection	Display Selection		Patch Selection
Mode Select	Page Jump	EXIT	Menu Selection	---	ENTER
Setup Menu	Page Jump	EXIT	Menu Selection	---	ENTER
Master Tune	Page Jump	EXIT	-----		Value Editing
MIDI Setting	Page Jump	EXIT	Parameter Selection		Value Editing
Map Edit	Page Jump	EXIT	Cursor Shifting		Value Editing
Patch Edit Menu	Page Jump	EXIT	Menu Selection	---	ENTER
Common Setting Menu	Page Jump	EXIT	Menu Selection	---	ENTER
Patch Name	Page Jump	EXIT	Cursor Shifting		Letter Selection
Output Mode	Page Jump	EXIT	-----		Value Editing
Effect	Page Jump	EXIT	Parameter Selection		Value Editing
Part Setting Menu	Part Select/Page Jump	EXIT	Menu Selection	---	ENTER
Basic	Part Select/Page Jump	EXIT	Parameter Selection		Value Editing
Level	Part Select/Page Jump	EXIT	Parameter Selection		Value Editing
Pitch	Part Select/Page Jump	EXIT	Parameter Selection		Value Editing
LFO	Part Select/Page Jump	EXIT	Parameter Selection		Value Editing
Write Mode Menu	Page Jump	EXIT	Menu Selection	---	ENTER
Memory Protect	Page Jump	EXIT	-----	OFF	ON
Patch Write	Page Jump	EXIT	Patch Selection	---	ENTER
Exchange	Page Jump	EXIT	Patch Selection	---	ENTER
Utility Menu	Page Jump	EXIT	Menu Selection	---	ENTER
Data Transfer	Page Jump	EXIT	Data Type Selection	---	ENTER
LCD Contrast	Page Jump	EXIT	-----		Value Editing
ROM Play	Page Jump	EXIT	Song Selection	STOP	PLAY

2. Page Jump

The Page Jump function can quickly call the display you have written (Page Marked) with one of the four tags:  ,   in any mode. By putting in memory display you will often use, you can achieve quicker editing.

Writing Page Marks

- Step 1 Select the display to be page-marked.
- Step 2 Keep pressing  until the indicator flashes.
- Step 3 Press the button to be page-marked (   ).

The Display responds as shown below, and the page marks are written.





Page Memorized.

*The page mark you have written will be retained even after the unit is turned off.

*The Page Mark does not include the Part Number of the Part setting.

*The Page Mark function is available for a Play mode display.

Page Jump

To jump to the page-marked display, press the relevant button (  ,  ) while holding  .

2 Play Mode

This is the normal playing mode.

Patches can be changed with **DEC** **INC**, and displays are shifted with **◀** **▶**.

Patch Number * The display will show "TEMP" by changing the settings.

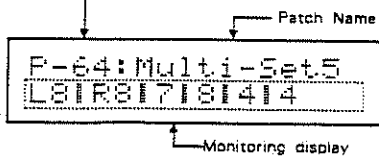

*To change Patches with Program Changes, be sure to set the unit to the Play mode. In any other mode, Patches cannot be changed.

Monitoring the Output Mode

The number of voices in each Voice Group can be monitored.

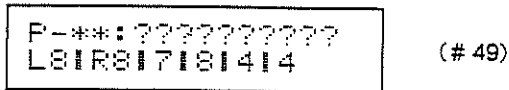

Monitoring the Output Assign

The number of the Voice Group assigned to each Part can be monitored.

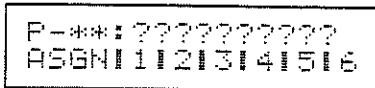

The Part whose Output Assign is set to OFF will be represented as "".

Memory Card Check

When you select a Tone from a memory card, you can check if the memory card is correctly connected.

```
F-**:??????????
CARDI=|1|=|3|=
```

*When you have failed to specify a memory card or when the selected memory card is not connected properly, "=" is shown in the Display.

*If the selected memory card is not connected properly, insert the memory card already indicated in the display.

Unused Parts those with Output Assign set to OFF) will be represented as "" whether the memory card is connected or not.

Monitoring MIDI Receive Channel

The MIDI Receive Channel set for each Part can be monitored.

```
F-**:??????????
MIDI|1|2|3|4|5|6
```

Unused Parts those with Output Assign set to OFF) will be represented as "", regardless of the current MIDI channel setting.

3 SETUP MODE

The Setup mode contains the Master Tuning and MIDI Map functions.

Parameter	Display
Master Tune	MST. TUNE
MIDI	
Control Channel	CTRL CHANNEL
Control Change	CTRL CHANGE
Program Change	PGM CHANGE
Channel Pressure	CH PRESSURE
Polyphonic Pressure	POLY PRESS
Pitch Bender	PITCH BENDER
Exclusive	EXCLUSIVE
Map Edit	MAP

1. Editing Procedure

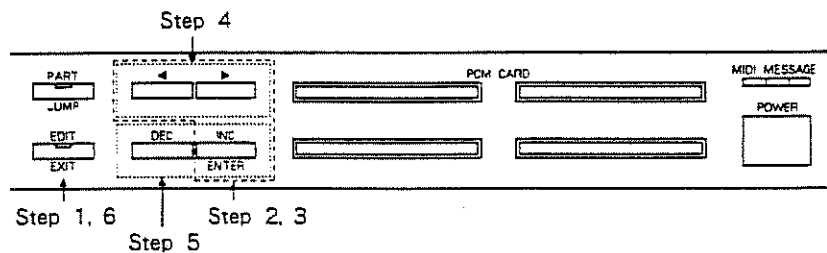

- Step 1 Press **EDIT** to enter the Edit mode (the indicator lights up).
- Step 2 Select "SETUP" using **◀ ▶**, then press **ENTER**.
- Step 3 Select the function to be edited with **◀ ▶**, then press **ENTER**.
- Step 4 Select the parameter of the function to be edited with **◀ ▶**.
- Step 5 Change the value with **DEC** and **INC**.
- Step 6 Press **EXIT** three times to return to the Play mode (the indicator goes out.)

*The Setup parameter you have edited is retained in memory even after the unit is switched off.

2. Setup Parameters

Master Tuning

This sets the pitch of the entire Part from -99 to +99 cents.
At 0, the middle A (A4) = 440Hz.

```
SETUP:M.TUNE  
MST. TUNE = 0
```

MIDI

● Control Channel

This sets the MIDI channel on which Program Change (Patch selection) messages are received. (Valid settings are from 1 to 16)
Control Channel can also be used for receiving the Master Tune (registered parameter) or receiving and transmitting the Exclusive messages.

```
SETUP:MIDI  
CTRL CHANNEL = 16
```

● Control Change

This selects whether or not to receive the Control Change messages.
Control Change messages include Hold, Volume, Modulation and Bend Range (registered parameter).

```
SETUP:MIDI  
CTRL CHANGE = ON
```

● Program Change

This selects whether or not to receive Program Change (Patch selection) messages on the set Control Channel.

```
SETUP:MIDI  
PGM CHANGE = ON
```

The Program Change numbers correspond to the Patch numbers as shown below :

Program Change	Patch Number
1	01
2	02
.	.
.	.
63	63
64	64
65	ignored
.	
.	
128	

*When the MIDI Channel of a Part is set to the same number as the Control Channel and the Program Change is set to ON in both channels, Patches are changed according to the Program Change number received at that channel first, then Tones are changed next.

● Channel Pressure
(Channel Aftertouch)

This selects whether or not to receive Channel Pressure messages (aftertouch messages sent on each MIDI channel).

```
SETUP:MIDI
CH PRESSURE = ON
```

● Polyphonic Pressure
(Polyphonic Aftertouch)

This selects whether or not to receive Polyphonic Pressure messages (aftertouch messages independently sent for each key).

```
SETUP:MIDI
POLY PRESS = OFF
```

● Pitch Bender

This selects whether or not to receive Pitch Bender messages.

```
SETUP:MIDI
PITCH BENDER = ON
```

● Exclusive

This selects whether or not to receive the Exclusive messages.

```
SETUP:MIDI
EXCLUSIVE = ON
```

Map Edit

When changing Tones in each Part from an external MIDI device, the Map Edit parameter sets how the Program Change numbers (128 numbers) should be assigned to the Tone Numbers. The U-110 can store up to six different Maps (Program Change number assignments). You can set which Map should be used for each Part by carrying out the Patch Edit procedure.

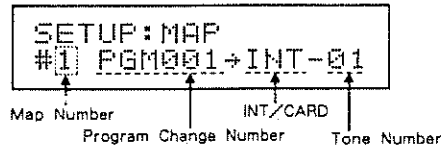

Move the cursor to the number you wish to set with **◀** **▶** then set the number with **DEC** and **INC** .

*You could write the Map you have made in the Blank Chart (page 82) for future use.

The Program Change numbers are assigned to the Tone numbers as shown below when shipped.

Program Change Number	Tone Number
1	INT--01
2	INT-02
⋮	⋮
99	INT-99
100	INT-01
⋮	⋮
128	INT-29

4 PATCH EDIT MODE

The Patch Edit mode includes the following three functions :

*The edited data is erased when a different Patch is selected. If you wish to retain it, take the appropriate Patch Write procedure.

● Common Setting

This sets the parameters common for all the Parts.

Parameter	Display
Patch Name	NAME
Output Mode	OUT #
Effect	
Chorus Rate	CHORUS RATE
Chorus Depth	CHORUS DEPTH
Tremolo Rate	TREMO. RATE
Tremolo Depth	TREMO. DEPTH

● Part Setting

This sets the parameters each Part.

Parameter	Display
Basic	
Tone	1-*** : <input type="text" value="name"/>
Output Assign	OUTPUT ASGN
MIDI Recive Channel	MIDI RCV. CH
Program Change	PGM CHANGE
Map	PGM→TONE MAP
Key Range (Low)	KEY RANGE LO
Key Range (High)	KEY RANGE HI
Level	
Part Level	PART LEVEL
Velocity Sensitivity	VELO SENS
ENV Attack Rate	ENV ATTACK
ENV Release Rate	ENV RELEASE
Channel Pressure Sensitivity	CH. PRESS SENS
Pitch	
Shift Corse	SHIFT CRS.
Shift Fine	SHIFT FINE
Bend Range	BEND RANGE
Detune Depth	DETUNE DEPTH
Polyphonic Pressure Sensitivity	P. PRESS SENS
LFO	
Rate	LFO RATE
Auto Depth	AUTO DEPTH
Auto Delay Time	AUTO DLAY TIM
Auto Rise Time	AUTO RISE TIM
Manual Depth	MAN DEPTH
Manual Rise Time	MAN RISE TIME
Channel Pressure Sensitivity	CH. PRESS SENS
Polyphonic Pressure Sensitivity	P. PRESS SENS

● Write

This sets the Memory Protect On/Off, Patch Write and Exchange function.

Parameter	Display
Memory Protect	MEM. PROTECT
Patch Write	WRITE
Exchange	EXCH

1. Editing Procedure

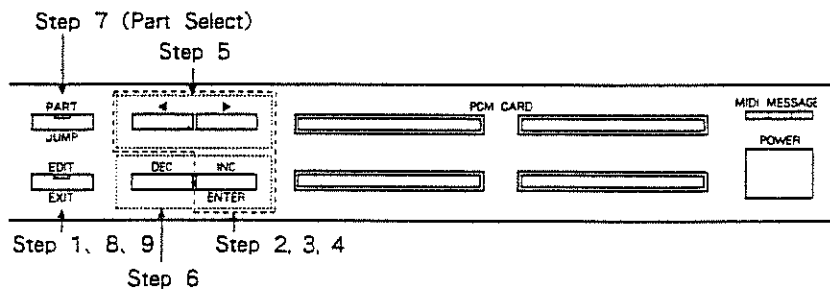





- Step 1 Press **EDIT** to enter the Edit mode (the indicator lights up).
- Step 2 Select "PATCH" using **◀ ▶**, then press **ENTER**.
- Step 3 Select the relevant menu with **◀ ▶**, then press **ENTER**.
- Step 4 Select the menu with **◀ ▶**, then press **ENTER**.
- Step 5 With **◀ ▶**, select the parameter to be edited.
- Step 6 Change the value with **DEC** and **INC**.
- Step 7 To move to a different Part during the Part setting procedure, make the indicator of **PART** lights, then call the desired Part with **◀ ▶**. To change parameters, turn off the **PART** indicator.
- Step 8 To edit a parameter on a different branch, return to the display where you can select the relevant section, then repeat the above procedure.
- Step 9 Press **EXIT** three times to return to the Play mode (the indicator goes out).

2. Patch Parameters

a. Common Setting

Patch Name

Each Patch can be named using up to 10 letters.

Move the cursor (underline) to the letter to be changed with  , then change the letter with  and .

```
PATCH: COM: NAME
NAME= _
      |
      v
    Cursor
```

The following letters can be used for a Patch Name.

DEC INC

←—————  —————→

 A.....Z a.....z 0.....9 -/+*.,:; = ! " # \$ % & ' () < > () [] _ ?

Output Mode

The Output Mode determines the Voice Group sent through each Multi Output.

You can select one of the 50 different combinations (see next page) of the Voice Groups and Multi Outputs.

```
PATCH: COM: OUT#49
L8IR9I7I8I4I4
```

*If you change the Output Mode during playing, all the Parts will be muted for a moment.

● Output Modes

Mode No.	Voice Group					
	1	2	3	4	5	6
1	31					
2	27	4				
3	23	8				
4	23	4	4			
5	19	12				
6	19	8	4			
7	19	4	4	4		
8	15	16				
9	15	12	4			
10	15					
11	15	8	4	4		
12	15	4	4	4	4	
13	11	12	8			
14	11	12	4	4		
15	11	8	8	4		
16	11	8	4	4	4	
17	11	4	4	4	4	4
18	7	8	8	8		
19	7	8	8	4	4	
20	7	8	4	4	4	4
21	< L31 >	< R31 >				
22		M31				
23	< L16 >	< R16 >	15			
24		M16	15			
25	< L16 >	< R16 >	11	4		
26		M16	11	4		
27	< L16 >	< R16 >	7	8		
28		M16	7	8		
29	< L16 >	< R16 >	7	4	4	
30		M16	7	4	4	
31	< L16 >	< R16 >	3	4	4	4
32		M16	3	4	4	4
33	< L8 >	< R8 >	23			
34		M8	23			
35	< L8 >	< R8 >	19	4		
36		M8	19	4		
37	< L8 >	< R8 >	15	8		
38		M8	15	8		
39	< L8 >	< R8 >	15	4	4	
40		M8	15	4	4	
41	< L8 >	< R8 >	11	12		
42		M8	11	12		
43	< L8 >	< R8 >	11	8	4	
44		M8	11	8	4	
45	< L8 >	< R8 >	11	4	4	4
46		M8	11	4	4	4
47	< L8 >	< R8 >	7	8	8	
48		M8	7	8	8	
49	< L8 >	< R8 >	7	8	4	4
50		M8	7	8	4	4

*In the Output modes 21 to 50, Multi Outputs 1 and 2 are regarded as the same Voice Group, and effect can be turned on or off. The one without effect (M) is set to the center position of the sound imaging, and the one with effect is stereo output (L and R).

Effect

● **Chorus Rate**

The rate of chorus effect can be set from 0 to 15. Higher values increase the rate.

```
PATCH:COM:EFFECT
CHORUS RATE = 7
```

● **Chorus Depth**

The depth of chorus effect can be set from 0 to 15. Higher values deepen the effect.

```
PATCH:COM:EFFECT
CHORUS DEPTH= 7
```

● **Tremolo Rate**

The rate of tremolo effect can be set from 0 to 15. Higher values increase the rate.

```
PATCH:COM:EFFECT
TREMO. RATE = 7
```

● **Tremolo Depth**

The depth of tremolo effect can be set from 0 to 15. Higher values deepen the effect.

```
PATCH:COM:EFFECT
TREMO. DEPTH= 7
```

b. Part Setting

Basic Group

● Tone Select

This selects Tones to be assigned to each Part from the internal memory or memory card.

```
PATCH:PART1:BAS
I-01:A.PIANO.1
```

*The number of Tones stored varies depending on the memory card. If no Tone is assigned to the selected Tone Number (no Tone Name is shown in the Display), no sound is generated.

*Though "No Card!" is displayed when a selected card is not present or not inserted properly, you can still make tone selections.

*If you change Tones during playing, the corresponding Part will be muted for a moment.

● Output Assign

The Output Assign function allows you to select a Voice Group for each Part and assign it to one of the Multi Outputs.

When the Output Assign is set to OFF, the Part will be muted.

It is possible to output more than one Part using the same Voice Group.

```
PATCH:PART1:BAS
OUTPUT ASGN = 1
```

*If you change the Output Assign Modes during playing, the corresponding Part will be muted for a moment.

* Each Voice Group is played as "Last note priority".

● MIDI Receive Channel

This sets the MIDI channel on which MIDI messages are received, from 1 to 16. On the MIDI receive channel, the unit receives Note On/Off, Control Change, Program Change (Tone selection), Channel Pressure and Pitch Bender data for each Part.

```
PATCH:PART1:BAS
MIDI RCV. CH= 1
```

● Program Change

This selects whether or not to receive Program Change messages which change Tones in each Part.

```
PATCH:PART1:BAS
PGH CHANGE = ON
```

● Map

This selects which of the set Maps should be used for changing Tones in each Part with Program Change messages.

```
PATCH:PART1:BAS
PGM→TONE MAP = 1
```

* How to set the Maps are explained on page 51 "Map Edit".

● Key Range Low

This sets the lowest note to be played with the received Note messages. C - 1 to G9 (middle C = C4).

```
PATCH:PART1:BAS
KEY RANGE LO= C-1
```

● Key Range High

This sets the highest note to be played with the received Note messages. C - 1 to G9 (middle C = C4).

```
PATCH:PART1:BAS
KEY RANGE HI= G9
```



Key Range Low Playing Range Key Range High

Level Group

This group includes the functions which are related to the volume changes of each Part.

● **Part Level**

This sets the base volume of each Part from 0 to 127. Higher values increases the volume.

```
PATCH:PART1:LEVL
PART LEVEL = 127
```

*Part level corresponds to MIDI Volume Change messages.

● **Velocity Sensitivity**

The sensitivity for controlling the volume with Velocity messages (key playing strength) can be set from 0 to 15. Higher values increase the volume changes caused by stronger playing.

```
PATCH:PART1:LEVL
VELO SENS = 15
```

● **ENV Attack Rate**

This sets the Attack Rate ; from -7 to +7. "+" values quicken the rate, while "-" values decrease the rate.

```
PATCH:PART1:LEVL
ENV ATTACK = 0
```

● **ENV Release Rate**

This sets the release rate (time needed for a sound to decay) from -7 to +7. "+" values quicken the rate, while "-" values decrease the rate.

```
PATCH:PART1:LEVL
ENV RELEASE = 0
```

● **Channel Pressure Sensitivity**
(Channel Aftertouch Sensitivity)

This sets the sensitivity for controlling volume with Channel Pressure messages (aftertouch messages) from 0 to 15. Higher values increase the volume changes caused by stronger key playing.

```
PATCH:PART1:LEVL
CH.PRESS SENS = 0
```

Pitch Group

This group includes parameters which determine how pitch should change.

● **Shift Coarse**

This sets the base pitch of sound in semitone steps. - 12 to +12 (± 1 octave) are valid.

```
PATCH:PART1:PIT
SHIFT CRS. = 0
```

● **Shift Fine**

This adjusts the pitch set with Shift Coarse. - 50 to +50 (50 cents) are valid.

```
PATCH:PART1:PIT
SHIFT FINE = 0
```

● **Bend Range**

This sets the amount of pitch to be changed with Bender messages when the bender lever is moved to the left or right extreme. 0 to 12 (semitone steps, ± 1 octave) are valid, changing the base pitch by that many semitones.

```
PATCH:PART1:PIT
BEND RANGE = 2
```

● **Detune Depth**

When you use a Tone with the Detune effect, this sets how the pitch should be shifted. 0 to 15 are valid; higher values increasing the depth of Detune.

```
PATCH:PART1:PIT
DETUNE DEPTH= 0
```

● **Polyphonic Pressure Sensitivity**
(Polyphonic Aftertouch Sensitivity)

This sets the amount of change in pitch upon reception of Polyphonic Pressure (Aftertouch) messages. Valid are the settings - 24 to +12. (semitone steps, - 2 to + 1 octave)

```
PATCH:PART:PIT
P.PRESS SENS= 0
```

LFO Group

This group includes parameters related with the LFO (Vibrato effect) set independently for each Part, and its independent LFO.

*The actual depth of the vibrato effect is affected by the Auto Depth, Manual Depth and Pressure Sensitivity values, but it does not change over 160 cents.

● **Rate**

This sets the rate of vibrato from 0 to 127. Higher values quicken the rate.

```
PATCH:PART1:LFO
LFO RATE      = 64
```

● **Auto Depth/Auto Delay Time/Auto Rise Time**

These parameters set how the vibrato varies automatically upon reception of Note On messages.

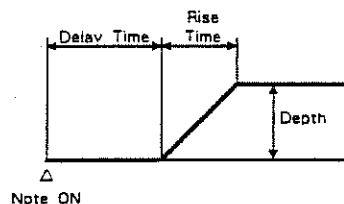

Auto Depth : This sets the depth of vibrato from 0 to 15. Higher values deepen the effect.

```
PATCH:PART1:LFO
AUTO DEPTH    = 0
```

Auto Delay Time : This sets the time needed for the vibrato effect to be engaged from the moment the Note On is received. 0 to 15 are valid, higher values resulting in longer time.

```
PATCH:PART1:LFO
AUTO DELAY TIM= 0
```

Auto Rise Time : This sets the time needed for the vibrato effect to reach its maximum. 0 to 15 are valid, higher values resulting longer time.

```
PATCH:PART1:LFO
AUTO RISE TIM= 0
```

● Manual Depth / Manual Rise Time

These determine how the vibrato is changed with Modulation messages.

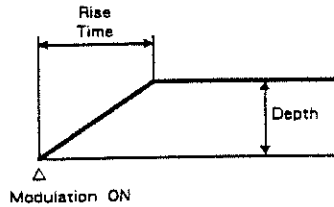

Manual Depth : This sets the depth of vibrato from 0 to 15. Higher values deepen the effect.

```
PATCH:PART1:LFO
MAN DEPTH = 5
```

Manual Rise Time : This sets the time needed for the vibrato effect to reach its maximum. 0 to 15 are valid, higher values extending the time.

```
PATCH:PART1:LFO
MAN RISE TIME = 3
```

● Channel Pressure Sensitivity
(Channel Aftertouch Sensitivity)

This sets the sensitivity for controlling vibrato effect with Channel Pressure (aftertouch) messages. 0 to 7 are valid, higher values will increase the changes caused by stronger playing.

```
PATCH:PART1:LFO
CH.PRESS SENS = 0
```

● Polyphonic Pressure Sensitivity
(Polyphonic Aftertouch Sensitivity)

This sets the sensitivity of the vibrato controlled by Polyphonic Pressure (aftertouch) messages. 0 to 7 are valid; higher values increasing the change in vibrato respective to the amount of pressure on the key.

```
PATCH:PART1:LFO
P.PRESS SENS = 0
```

c. Writing Mode

The edited Patch (Common and Part settings) is automatically saved into a temporary location (Temporary Patch), but this will be erased when a different Patch is selected. To retain the edited data, set the Memory Protect function to OFF, then take an appropriate Patch Write or Exchange procedure.

Memory Protect



The Memory Protect function is provided to protect data in memory from accidental erasure. Set the Memory Protect to OFF when you write a new Patch.

However, be sure to return it to ON every time you have finished writing.

```
PATCH:WRT:PROTEC  
MEM. PROTECT= ON
```

Patch Write

The Patch Write function allows you to write a Patch stored in a Temporary Patch to a Patch Number.

Using  , assign the destination Patch Number, then press .

```
PATCH:WRT:WRITE  
TMP → PATCH-01?
```

↑
Destination Patch Number

*It's a good idea to make a record of your settings on a chart.(see page 81)

Exchange

The Exchange function allows you to swap a Temporary Patch and a Patch Number. That is, the Temporary Patch is written in memory. This function may be useful for comparing two Patches or re-arranging the order of Patches.

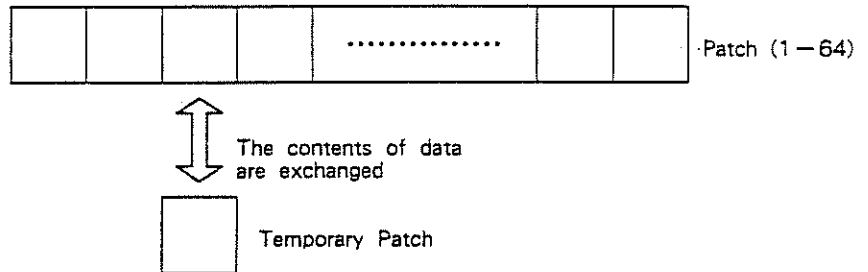

Using , assign the destination Patch Number, then press .

```
PATCH:WRT:EXCH
TMP ↔ PATCH-01?
```

↑
Patch Number to be exchanged

● Patch Compare

Pressing will call the Temporary Patch and the assigned Patch Number alternately, so that you can compare these two sounds.

● Patch Exchange

For example, to exchange the settings held by P-03 and P-10: First, in the Play Mode, select P-03, then exchange P-03 and P-10. Then, perform a Write (or Exchange) procedure with P-03 (the settings of a temporary P-10).

Procedures similar to this can be repeated when changing settings for numerous Patches.

5 Utility Mode

The Utility mode allows you to transfer data, control the LCD contrast and play ROM performance data.

1. Data Transfer (via MIDI)

Using the Roland Exclusive messages, the U-110's data can be transferred to another U-110 or MIDI sequencer, etc. The U-110's data transfer is performed in a One Way method that transmits data without confirming the status of the receiver.

●Data which can be transferred

- Setup Data
- Temporary Patch Data
- Patch Data (1 to 64)

a. Data Transfer to another U-110

Connections

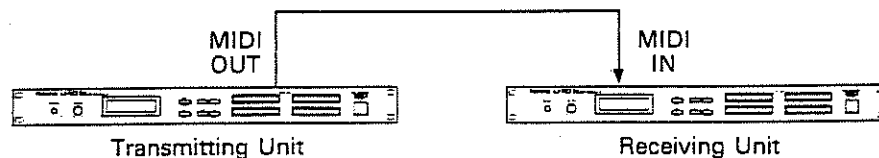

How to transfer data

The transfer procedure is controlled from transmitting unit. You do not need to operate the receiving unit.

Before data transfer, set the transmitting and receiving unit as follows :

- Set the Control Channels of the transmitter and receiver to the same number.(Otherwise, data cannot be transferred.)
- Set the Exclusive on the receiver to ON.
- If you wish to transfer Patch data (1 to 64), set the Memory Protect on the receiver to OFF.

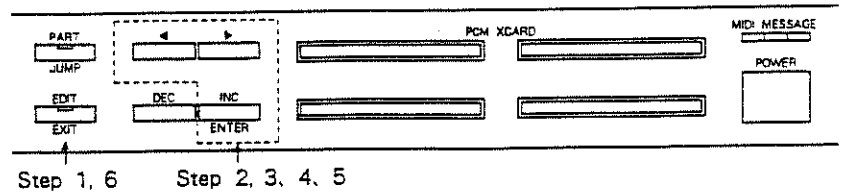

- Step 1 Press **EDIT** to enter the Edit mode (the indicator lights up).
- Step 2 Select "UTIL" using **◀ ▶**, then press **ENTER**.
- Step 3 Select "BULK" using **◀ ▶**, then press **ENTER**.
- Step 4 Select the block of the data you wish to transfer, using **◀ ▶**.

Setup Data

```
UTILITY: BULK
DUMP SETUP ?
```

Temporary Data

```
UTILITY: BULK
DUMP TEMP PATCH?
```

Patch Data (1 to 64)

```
UTILITY: BULK
DUMP 1-64 PATCH?
```

- Step 5 Press **ENTER** to transfer the selected data.

```
UTILITY: BULK
Transmitting...
```

When the Data Transfer is completed, the Display responds as shown below for a while, then returns to the display prior to the Data Transfer procedure.

```
UTILITY: BULK
Dump Complete
```

- Step 6 Press **EXIT** three times to return to the Play mode (the indicator goes out).

b. Data Transfer to a MIDI Sequencer

Connections

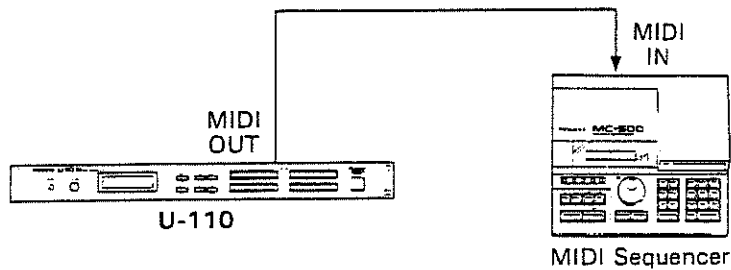

How to transfer data

Set the sequencer so it is ready for receiving Exclusive messages, then take the Data Transfer procedure as shown in the previous section (on page 67).

* Read the owner's manual of the sequencer you use.

c. Data Transfer from a MIDI sequencer

Connections

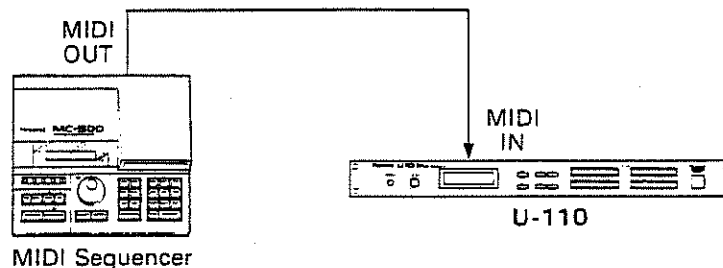

How to transfer data

The transfer procedure is controlled from the transmitting side. You do not need to operate the receiving unit. Before data transfer, set the transmitting and receiving unit as follows :

- Set the Control Channels of the transmitter and receiver to the same number. (Otherwise, data cannot be transferred.)
- Set the Exclusive on the receiver (U-110) to ON.
- If you wish to transfer Patch data (1 to 64), set the Memory Protect on the receiver to OFF.

* Read the owner's manual of the sequencer you use.

2. LCD Contrast

The contrast of the Display can be adjusted.

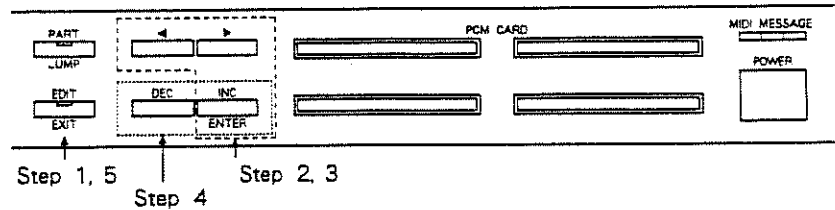

Step 1 Press **EDIT** to enter the Edit mode (the indicator lights up).

Step 2 Select "UTIL" using **◀ ▶**, then press **ENTER**.

Step 3 Select "LCD" using **◀ ▶**, then press **ENTER**.

```

UTILITY:LCD
CONTRAST   = 10
  
```

Step 4 Adjust the contrast with **DEC** and **INC**.

Step 5 Press **EXIT** three times to return to the Play mode (the indicator goes out).

*The LCD Contrast you set is retained even after the unit is switched off.

3. ROM Play

The U-110's ROM Play function allows you to play the demonstration songs stored in ROM. To fully enjoy the excellent quality of the sounds, use a stereo amplifier, if possible.

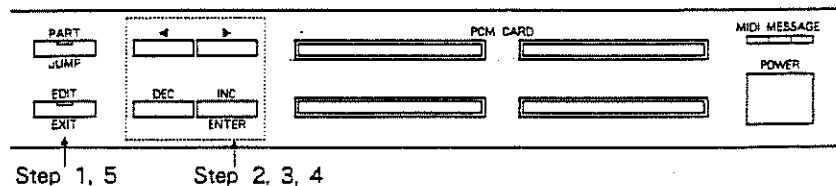

Step 1 Press **EDIT** to enter the Edit mode (the indicator lights up).

Step 2 Select "UTIL" using **◀ ▶**, then press **ENTER**.

Step 3 Select "ROM PLY" using **◀ ▶**, then press **ENTER**.

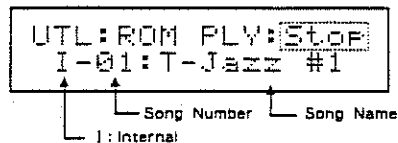

Step 4 Pressing **INC** at this stage will play songs 1 to 4 in sequence. If you wish to play a specific song, select the song with **◀ ▶**, then press **INC**. To stop playing, press **DEC**.

Step 5 To return to the Play mode, stop playing first, then press **EXIT** three times.

* During ROM playing, MIDI control functions are not available.

* ROM performance data is not output through the MIDI OUT.

Song Number	Song Name	
I-01	T-Jazz #1	Music by M. Sakaue Idecs (c) 1988 by Roland
I-02	Swing High	Music by Eric Persing (c) 1988 by Eric Persing
I-03	Cloud 9	Music by Eric Persing (c) 1988 by Eric Persing
I-04	No One Home	Music by Adrian Scott (c) 1988 by Adrian Scott

Reference

1 Troubleshooting	P. 72
-------------------	-------

2 Appendix Tables	P. 76
-------------------	-------

1 TROUBLESHOOTING

1. Before Calling for Repairs

If the U-110 does not function properly, please refer to the following information.

▶ No sound is heard

○ Check if the Output sockets are correctly connected according to the Output Mode.

[Refer to page 26, 55]

○ Check if the MIDI receive channel of each Part is correctly set.

[Refer to page 18, 59]

○ Check if the Output Assign of each Part is correctly set.

[Refer to page 29, 58]

○ Check if the Key Range (Low/High) in each Part is correctly set.

[Refer to page 59]

○ Check if the level of each Part is not set too low.

[Refer to page 31, 60]

○ Check if the memory card which contains the Tone you have assigned is connected securely.

▶ Pitch is strange

○ Check if the Master Tuning is correctly set.

[Refer to page 25, 49]

○ Check if the Pitch Shift in each Part is correctly set.

[Refer to page 32, 61]

○ Check if the Bender messages are still set ON.

► Bender effect cannot be obtained

○Make certain the Pitch Bender in the Setup mode is not set to OFF.

[Refer to page 50]

○Check if the Bend Range in each Part is correctly set.

[Refer to page 61]

► MIDI Pitch Modulation is not obtained

○Make certain the Control Change in the Setup mode is not set to OFF.

[Refer to page 49]

○Make certain the Manual Depth of the LFO is not set to zero.

[Refer to page 63]

2. Error Messages

When an error message is shown in the Display, resolve it as follows.

*If the same error message is shown repeatedly even though everything else seems in order, call your local Roland dealer.

▶ Error Message shown when the battery is exhausted

Check Battery!

○The battery for the backup circuits is exhausted. Call your local Roland dealer.

▶ Error Message shown during Writing or Bulk Data Receiving Mode

Memory Protected

○The Memory Protect on the U-110 is set to ON. Set it to OFF, then repeat the procedure.

▶ Error Message shown when a Memory Card is being used

Illegal CARD

○The connected memory card is not for the U-110. Immediately remove it, then insert a proper memory card.

○If this error message is shown when a memory card for U-110 is being used, the card is damaged, or the card slot has broken down. Call your local Roland dealer.

► **Error Message shown while MIDI messages are being received**

Chk Sum Err [**]

- This is a checksum error in the Exclusive messages. " *" shows the correct checksum... Check the data on the transmitting unit first, then if there is nothing wrong with it, check the connections between the two units.

MIDI Buffer Full

- This is shown when the U-110 receives a volume of data that exceeds its processing capabilities. It is likely you have repetitively sent data which takes a long time to be processed, such as Program Change.

Act Sensing Err.

- This is shown when no message follows within 300msec after Active Sensing is received. Check if the MIDI cables are not damaged.

2 APPENDIX TABLES

1. Parameter Table

● Setup Mode

Parameter	Display	Variable Range
Master Tune	MST. TUNE	- 99 0 + 99
MIDI		
Control Channel	CTRL CHANNEL	1 16
Control Change	CTRL CHANGE	OFF, ON
Program Change	PGM CHANGE	OFF, ON
Channel Pressure	CH PRESSURE	OFF, ON
Polyphonic Pressure	POLY PRESS	OFF, ON
Pitch Bender	PITCH BENDER	OFF, ON
Exclusive	EXCLUSIVE	OFF, ON
Map Edit	MAP	1 6

● Patch Edit Mode

[Common Setting]

Parameter	Display	Variable Range
Patch Name	NAME	(spc) A Z, a z, 0 9 - / + * . : ; = ! " # \$ % & ' () < > { } [] _ ?
Output Mode	OUT #	1 50
Effect		
Chorus Rate	CHORUS RATE	0 15
Chorus Depth	CHORUS DEPTH	0 15
Tremolo Rate	TREMO. RATE	0 15
Tremolo Depth	TREMO. DEPTH	0 15

[Part Setting]

Parameter Group	Parameter	Display	Variable Range
Basic Group	Tone		1-01 99, ** -01 99
	Output Assign	OUTPUT ASGN	1 6, OFF
	MIDI Recive Channel	MIDI RCV. CH	1 16
	Program Change	PGM CHANGE	OFF, ON
	Map	PGM → TONE MAP	1 6
	Key Range (Low)	KEY RANGE LO	C-1 G9
	Key Range (High)	KEY RANGE HI	C-1 G9
Level Group	Part Level	PART LEVEL	0 127
	Velocity Sensitivity	VELO SENS	0 15
	ENV Attack Rate	ENV ATTACK	-7 0 +7
	ENV Release Rate	ENV RELEASE	-7 0 +7
	Channel Pressure Sensitivity	CH. PRESS SENS	0 15
Pitch Group	Shift Corse	SHIFT CRS.	-12 0 +12
	Shift Fine	SHIFT FINE	-50 0 +50
	Bend Range	BEND RANGE	0 12
	Detune Depth	DETUNE DEPTH	0 15
	Polyphonic Pressure Sensitivity	P. PRESS SENS	-24, -12, -7, -5 0 +5, +7, +12
LFO Group	Rate	LFO RATE	0 127
	Auto Depth	AUTO DEPTH	0 15
	Auto Delay Time	AUTO DLAY TIM	0 15
	Auto Rise Time	AUTO RISE TIM	0 15
	Manual Depth	MAN DEPTH	0 15
	Manual Rise Time	MAN RISE TIME	0 15
	Channel Pressure Sensitivity	CH. PRESS SENS	0 7
	Polyphonic Pressure Sensitivity	P. PRESS SENS	0 7

[Write]

Parameter	Display	Variable Range
Memory Protect	MEM. PROTECT	OFF, ON
Patch Write	TMP → PATCH	01 ... 64
Exchange	TMP ↔ PATCH	01 ... 64

● Utility Mode

Parameter	Display	Variable Range
Data Transfer	DUMP	SETUP, TEMP PATCH, 1 - 64 PATCH
LCD Contrast	CONTRAST	0 15
ROM Play		1 - 01 04

2. Preset Tone Table

No.	Tone Name	Tone Type	Split/Threshold	Contents
Piano				
01	A. PIANO 1	V-MIX		mellow tone
02	A. PIANO 2	V-MIX		
03	A. PIANO 3	V-MIX		bright tone
04	A. PIANO 4	V-MIX		honky tonk piano
05	A. PIANO 5	SINGLE		soft touch
06	A. PIANO 6	DETUNE		soft touch
07	A. PIANO 7	SINGLE		hard touch
08	A. PIANO 8	DETUNE		hard touch
09	A. PIANO 9	SINGLE		hard touch and bright tone
10	A. PIANO 10	DETUNE		hard touch and bright tone
Vibraphone				
11	E. PIANO 1	V-MIX		soft and hard touch
12	E. PIANO 2	SINGLE		soft touch
13	E. PIANO 3	DETUNE		soft touch
14	E. PIANO 4	SINGLE		hard touch
15	E. PIANO 5	DETUNE		hard touch
Bell				
16	VIB 1	SINGLE		soft touch
17	VIB 2	DETUNE		soft touch
18	VIB 3	V-MIX		soft and hard touch
Bell				
19	BELL 1	SINGLE		long release
20	BELL 2	DETUNE		long release
21	BELL 3	SINGLE		short release
22	BELL 4	DETUNE		short release
Marimba				
23	MARIMBA	SINGLE		
Guitar				
24	A. GUITAR 1	SINGLE		
25	A. GUITAR 2	DETUNE		
26	A. GUITAR 3	DUAL		
27	A. GUITAR 4	DUAL		
28	A. GUITAR 5	V-SW	v = 100	Includes the sound one octave lower Slow attack/Fast attack
29	E. GUITAR 1	V-SW	v = 100	Mute/Non-mute
30	E. GUITAR 2	SINGLE		Mute
31	E. GUITAR 3	SINGLE		Non-mute
32	E. GUITAR 4	DETUNE		Non-mute
Bass				
33	SLAP 1	SINGLE	E2 (40)	Thump/pull
34	SLAP 2	DETUNE	E2 (40)	Thump/pull
35	SLAP 3	SINGLE	B2 (47)	Thump/pull
36	SLAP 4	DETUNE	B2 (47)	Thump/pull
37	SLAP 5	V-SW	v = 100	Thump/pull
38	SLAP 6	V-SW	v = 100	Slow attack/Fast attack
*The keys more than F#4 (66) contains the harmonics sound in SLAP 1 to 6.				
39	SLAP 7	SINGLE	E2 (40)	Thump/pull
40	SLAP 8	DETUNE	E2 (40)	Thump/pull
41	SLAP 9	SINGLE	B2 (47)	Thump/pull
42	SLAP 10	DETUNE	B2 (47)	Thump/pull
43	SLAP 11	V-SW	v = 100	Thump/pull
44	SLAP 12	V-SW	v = 100	Slow attack/Fast attack
*The keys more than C#4 (61) contains the harmonics sound in SLAP 7 to 12.				
45	FINGERED 1	SINGLE		
46	FINGERED 2	DETUNE		
*The keys more than C#5 (73) contains the harmonics sound in FINGERED 1 and 2.				
47	PICKED 1	SINGLE		

No.	Tone Name	Tone Type	Split/Threshold	Contents
Bass				
48	PICKED 2	DETUNE		
49	FRETLESS 1	SINGLE		
50	FRETLESS 2	DETUNE		
* The keys more than D#6 (87) contains the harmonics sound in FRETLESS 1 and 2.				
51	AC. BASS	V-MIX		Fret-noise is slightly mixed.
52	SYN. BASS 1	V-MIX		Soft and hard touch
53	SYN. BASS 2	SINGLE		Soft touch
54	SYN. BASS 3	SINGLE		Hard touch
Choir				
55	CHOIR 1	SINGLE		Long release
56	CHOIR 2	SINGLE		Short release
57	CHOIR 3	DUAL		Long release (Includes the sound one octave lower)
58	CHOIR 4	DUAL		Short release (Includes the sound one octave lower)
Strings				
59	STRINGS 1	SINGLE		Long release
60	STRINGS 2	SINGLE		Short release
61	STRINGS 3	DUAL		Long release (Includes the sound one octave lower)
62	STRINGS 4	DUAL		Short release (Includes the sound one octave lower)
Organ				
63	E. ORGAN 1	SINGLE		
64	E. ORGAN 2	DETUNE		
65	E. ORGAN 3	SINGLE		
66	E. ORGAN 4	DETUNE		
67	E. ORGAN 5	SINGLE		
68	E. ORGAN 6	DETUNE		
69	E. ORGAN 7	SINGLE		
70	E. ORGAN 8	DETUNE		
71	E. ORGAN 9	DUAL		
72	E. ORGAN 10	DUAL		
73	E. ORGAN 11	DUAL		
74	E. ORGAN 12	DUAL		
75	E. ORGAN 13	DUAL		
Wind				
76	SOFT TP 1	SINGLE		
77	SOFT TP 2	DETUNE		
78	SOFT TP 3	SINGLE		Sforzand piano
79	TP / TRB 1	SINGLE		
80	TP / TRB 2	SINGLE		Mellow tone
81	TP / TRB 3	SINGLE		Bright tone
82	TP / TRB 4	SINGLE		Sforzand piano
83	TP / TRB 5	DETUNE		
84	TP / TRB 6	DUAL		Includes the sound one octave lower
85	SAX 1	SINGLE		
86	SAX 2	SINGLE		Mellow tone
87	SAX 3	SINGLE		Bright tone
88	SAX 4	DETUNE		
89	SAX 5	DUAL		Includes the sound one octave lower
90	BRASS 1	SINGLE		
91	BRASS 2	SINGLE		Sforzand piano
92	BRASS 3	DUAL		Includes the sound one octave lower
93	BRASS 4	DUAL		BRASS & SAX
94	BRASS 5	DUAL		TP / TRB & SAX
95	FLUTE 1	SINGLE		
96	FLUTE 2	DETUNE		
97	SHAKU 1	SINGLE		
98	SHAKU 2	DETUNE		
Drums				
99	DRUMS	SINGLE		See "DRUMS SETTING CHART"

* The voicing capacity or the upper limit of the key range may vary with the tones you select.

● Drums Setting Table

Note Name	Tone Name
B1 (35)	Bass Drum 1
C2 (36)	Bass Drum 2
C#2 (37)	Rim Shot
D2 (38)	Snare Drum 1
D#2 (39)	Hand Clap
E2 (40)	Snare Drum 2
F2 (41)	Low Tom Tom 1
F#2 (42)	Closed High Hat 1
G2 (43)	Low Tom Tom 2
G#2 (44)	Open High Hat 2
A2 (45)	Middle Tom Tom 1
A#2 (46)	Open High Hat 1
B2 (47)	Middle Tom Tom 2
C3 (48)	High Tom Tom 1
C#3 (49)	Crash Cymbal
D3 (50)	High Tom Tom 2
D#3 (51)	Ride Cymbal
E3 (52)	China Cymbal
F3 (53)	Cup (Mute)
F#3 (54)	Off
G3 (55)	Off
G#3 (56)	Cowbell
A3 (57)	Crash Cymbal
A#3 (58)	Snare Drum 3
B3 (59)	Ride Cymbal
C4 (60)	Off
C#4 (61)	Off
D4 (62)	Off
D#4 (63)	Off
E4 (64)	Off
F4 (65)	Off
F#4 (66)	Off
G4 (67)	Off
G#4 (68)	Off
A4 (69)	Cabasa
A#4 (70)	Off
B4 (71)	Off
C5 (72)	Off
C#5 (73)	Off
D5 (74)	Off
D#5 (75)	Off
E5 (76)	Off
F5 (77)	Off
F#5 (78)	Off
G5 (79)	High Pitch Tom Tom 2
G#5 (80)	Off
A5 (81)	High Pitch Tom Tom 1
A#5 (82)	Off
B5 (83)	Off
C6 (84)	Bass Drum 3
C#6 (85)	Bass Drum 4
D6 (86)	Snare Drum 4
D#6 (87)	Snare Drum 5
E6 (88)	Snare Drum 6
F6 (89)	Low Tom Tom 3
F#6 (90)	Closed High Hat 2
G6 (91)	Middle Tom Tom 3
G#6 (92)	China Cymbal
A6 (93)	High Tom Tom 3
A#6 (94)	Ride Cymbal
B6 (95)	Off
C7 (96)	Off

3. Blank Chart

● Patch

Patch No.	Patch Name					
Output Mode #	1	2	3	4	5	6
Chorus Rate			Chorus Depth			
Tremolo Rate			Tremolo Depth			

		Part1	Part2	Part3	Part4	Part5	Part6
Basic	Tone No.						
	Tone Name						
	Output Assign						
	MIDI Channel						
	Program Change						
	Map No.						
	Key Range (Lo)						
	Key Range (Hi)						
Level	Part Level						
	Velocity Sens.						
	ENV Attack Rate						
	ENV Release Rate						
	Ch. Pressure Sens.						
Pitch	Shift Coarse						
	Shift Fine						
	Bender Range						
	Detune Depth						
	Poly. Pressure Sens.						
LFO	LFO Rate						
	Auto Depth						
	Auto Delay Time						
	Auto Rise Time						
	Manual Depth						
	Manual Rise Time						
	Ch. Pressure Sens.						
	Poly. Pressure Sens.						

● Map

MAP No.							
PGM	Tone No.	PGM	Tone No.	PGM	Tone No.	PGM	Tone No.
1		33		65		97	
2		34		66		98	
3		35		67		99	
4		36		68		100	
5		37		69		101	
6		38		70		102	
7		39		71		103	
8		40		72		104	
9		41		73		105	
10		42		74		106	
11		43		75		107	
12		44		76		108	
13		45		77		109	
14		46		78		110	
15		47		79		111	
16		48		80		112	
17		49		81		113	
18		50		82		114	
19		51		83		115	
20		52		84		116	
21		53		85		117	
22		54		86		118	
23		55		87		119	
24		56		88		120	
25		57		89		121	
26		58		90		122	
27		59		91		123	
28		60		92		124	
29		61		93		125	
30		62		94		126	
31		63		95		127	
32		64		96		128	

Roland Exclusive Messages

1. Data Format for Exclusive Messages

Roland's MIDI implementation uses the following data format for all exclusive messages (type IV):

Byte	Description
F0H	Exclusive status
41H	Manufacturer ID (Roland)
DEV	Device ID
MDL	Model ID
CMD	Command ID
[BODY]	Main data
F7H	End of exclusive

MIDI status : F0H, F7H

An exclusive message must be flanked by a pair of status codes, starting with a Manufacturer-ID immediately after F0H (MIDI version 1.0).

Manufacturer-ID : 41H

The Manufacturer-ID identifies the manufacturer of a MIDI instrument that triggers an exclusive message. Value 41H represents Roland's Manufacturer-ID.

Device-ID : DEV

The Device-ID contains a unique value that identifies the individual device in the multiple implementation of MIDI instruments. It is usually set to 00H - 0FH, a value smaller by one than that of a basic channel, but value 00H - 1FH may be used for a device with multiple basic channels.

Model-ID : MDL

The Model-ID contains a value that uniquely identifies one model from another. Different models, however, may share an identical Model-ID if they handle similar data.

The Model-ID format may contain 00H in one or more places to provide an extended data field. The following are examples of valid Model-IDs, each representing a unique model:

0111
0211
0311
0011, 0111
0011, 0211
0011, 0011, 0111

Command-ID : CMD

The Command-ID indicates the function of an exclusive message. The Command-ID format may contain 00H in one or more places to provide an extended data field. The following are examples of valid Command-IDs, each representing a unique function:

0111
0211
0311
0011, 0111
0011, 0211
0011, 0011, 0111

Main data : BODY

This field contains a message to be exchanged across an interface. The exact data size and contents will vary with the Model-ID and Command-ID.

2. Address-mapped Data Transfer

Address mapping is a technique for transferring messages conforming to the data format given in Section 1. It assigns a series of memory-resident records—waveform and tone data, switch status, and parameters, for example—to specific locations in a machine-dependent address space, thereby allowing access to data residing at the address a message specifies.

Address-mapped data transfer is therefore independent of models and data categories. This technique allows use of two different transfer procedures: one-way transfer and handshake transfer.

One-way transfer procedure (See Section 3 for details.)

This procedure is suited for the transfer of a small amount of data. It sends out an exclusive message completely independent of a receiving device status.

Connection Diagram



Connection at point 2 is essential for "Request data" procedures. (See Section 3.)

Handshake-transfer procedure (See Section 4 for details.)

This procedure initiates a predetermined transfer sequence (handshaking) across the interface before data transfer takes place. Handshaking ensures that reliability and transfer speed are high enough to handle a large amount of data.

Connection Diagram

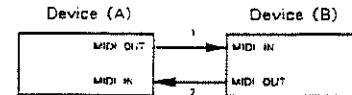

Connection at points 1 and 2 is essential.

Notes on the above two procedures

- *There are separate Command-IDs for different transfer procedures.
- *Devices A and B cannot exchange data unless they use the same transfer procedure, share identical Device-ID and Model ID, and are ready for communication.

3. One-way Transfer Procedure

This procedure sends out data all the way until it stops when the messages are so short that answerbacks need not be checked.

For long messages, however, the receiving device must acquire each message in time with the transfer sequence, which inserts intervals of at least 20 milliseconds in between.

Types of Messages

Message	Command ID
Request data 1	RQ1 (11H)
Data set 1	DT1 (12H)

Request data # 1 : RQ1 (11H)

This message is sent out when there is a need to acquire data from a device at the other end of the interface. It contains data for the address and size that specify designation and length, respectively, of data required.

On receiving an RQ1 message, the remote device checks its memory for the data address and size that satisfy the request.

If it finds them and is ready for communication, the device will transmit a "Data set 1 (DT1)" message, which contains the requested data. Otherwise, the device will send out nothing.

Byte	Description
F0H	Exclusive status
41H	Manufacturer ID (Roland)
DEV	Device ID
MDL	Model ID
11H	Command ID
anH	Address MSB
⋮	⋮
	LSB
sqH	Size MSB
⋮	⋮
	LSB
sum	Checksum
F7H	End of exclusive

- *The size of the requested data does not indicate the number of bytes that will make up a DTI message, but represents the address fields where the requested data resides.
- *Some models are subject to limitations in data format used for a single transaction. Requested data, for example, may have a limit in length or must be divided into predetermined address fields before it is exchanged across the interface.
- *The same number of bytes comprises address and size data, which, however, vary with the Model-ID.
- *The error checking process uses a checksum that provides a bit pattern where the least significant 7 bits are zero when values for an address, size, and that checksum are summed.

≠ Data set 1 : DTI (12H)

This message corresponds to the actual data transfer process. Because every byte in the data is assigned a unique address, a DTI message can convey the starting address of one or more data as well as a series of data formatted in an address-dependent order.

The MIDI standards inhibit non-real time messages from interrupting an exclusive one. This fact is inconvenient for the devices that support a "soft-through" mechanism. To maintain compatibility with such devices, Roland has limited the DTI to 256 bytes so that an excessively long message is sent out in separate segments.

Byte	Description
F0H	Exclusive
41H	Manufacturer ID (Roland)
DEV	Device ID
MDL	Model ID
12H	Command ID
aaH	Address MSB
⋮	⋮
	LSB
ddH	Data
⋮	⋮
sum	Check sum
F7H	End of exclusive

- *A DTI message is capable of providing only the valid data among those specified by an RQI message.
- *Some models are subject to limitations in data format used for a single transaction. Requested data, for example, may have a limit in length or must be divided into predetermined address fields before it is exchanged across the interface.
- *The number of bytes comprising address data varies from one Model-ID to another.
- *The error checking process uses a checksum that provides a bit pattern where the least significant 7 bits are zero when values for an address, size, and that checksum are summed.

≠ Example of Message Transactions

- Device A sending data to Device B
Transfer of a DTI message is all that takes place.

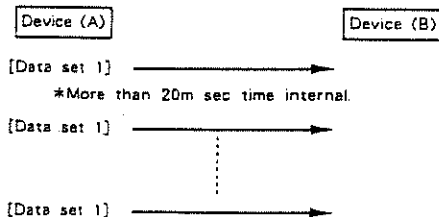

- Device B requesting data from Device A
Device B sends an RQI message to Device A. Checking the message, Device A sends a DTI message back to Device B.

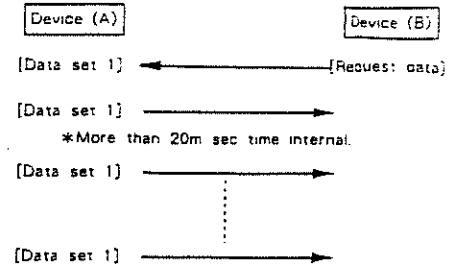

4. Handshake - Transfer Procedure

Handshaking is an interactive process where two devices exchange error checking signals before a message transaction takes place, thereby increasing data reliability. Unlike one-way transfer that inserts a pause between message transactions, handshake transfer allows much speedier transactions because data transfer starts once the receiving device returns a ready signal.

When it comes to handling large amounts of data -- sampler waveforms and synthesizer tones over the entire range, for example -- across a MIDI interface, handshaking transfer is more efficient than one-way transfer.

Types of Messages

Message	Command ID
Want to send data	WSD (40H)
Request data	RQD (41H)
Data set	DAT (42H)
Acknowledge	ACK (43H)
End of data	EOD (45H)
Communication error	ERR (4EH)
Rejection	RJC (4FH)

≠ Want to send data : WSD (40H)

This message is sent out when data must be sent to a device at the other end of the interface. It contains data for the address and size that specify designation and length, respectively, of the data to be sent.

On receiving a WSD message, the remote device checks its memory for the specified data address and size which will satisfy the request. If it finds them and is ready for communication, the device will return an "Acknowledge (ACK)" message. Otherwise, it will return a "Rejection (RJC)" message.

Byte	Description
F0H	Exclusive status
41H	Manufacturer ID (Roland)
DEV	Device ID
MDL	Model ID
40H	Command ID
aaH	Address MSB
⋮	⋮
	LSB
ssH	Size MSB
⋮	⋮
	LSB
sum	Check sum
F7H	End of exclusive

- *The size of the data to be sent does not indicate the number of bytes that make up a "Data set (DAT)" message, but represents the address fields where the data should reside.
- *Some models are subject to limitations in data format used for a single transaction. Requested data, for example, may have a limit in length or must be divided into predetermined address fields before it is exchanged across the interface.
- *The same number of bytes comprises address and size data, which, however, vary with the Model ID.
- *The error checking process uses a checksum that provides a bit pattern where the least significant 7 bits are zero when values for an address, size, and that checksum are summed.

Request data : RQD (41H)

This message is sent out when there is a need to acquire data from a device at the other end of the interface. It contains data for the address and size that specify designation and length, respectively, of data required.

On receiving an RQD message, the remote device checks its memory for the data address and size which satisfy the request. If it finds them and is ready for communication, the device will transmit a "Data set (DAT)" message, which contains the requested data. Otherwise, it will return a "Rejection (RJC)" message.

Byte	Description
F0H	Exclusive status
41H	Manufacturer ID (Roland)
DEV	Device ID
MDL	Model ID
41H	Command ID
aaH	Address MSB
⋮	⋮
	LSB
ssH	Size MSB
⋮	⋮
	LSB
sum	Check sum
F7H	End of exclusive

- *The size of the requested data does not indicate the number of bytes that make up a "Data set (DAT)" message, but represents the address fields where the requested data resides.
- *Some models are subject to limitations in data format used for a single transaction. Requested data, for example, may have a limit in length or must be divided into predetermined address fields before it is exchanged across the interface.
- *The same number of bytes comprises address and size data, which, however, vary with the Model-ID.
- *The error checking process uses a checksum that provides a bit pattern where the least significant 7 bits are zero when values for an address, size, and that checksum are summed.

Data set : DAT (42H)

This message corresponds to the actual data transfer process. Because every byte in the data is assigned a unique address, the message can convey the starting address of one or more data as well as a series of data formatted in an address-dependent order.

Although the MIDI standards inhibit non-real time messages from interrupting an exclusive one, some devices support a "soft-through" mechanism for such interrupts. To maintain compatibility with such devices, Roland has limited the DAT to 256bytes so that an excessively long message is sent out in separate segments.

Byte	Description
F0H	Exclusive status
41H	Manufacturer ID (Roland)
DEV	Device ID
MDL	Model ID
42H	Command ID
aaH	Address MSB
⋮	⋮
	LSB
⋮	⋮
⋮	⋮
sum	Check sum
F7H	End of exclusive

- *A DAT message is capable of providing only the valid data among those specified by an RQD or WSD message.
- *Some models are subject to limitations in data format used for a single transaction. Requested data, for example, may have a limit in length or must be divided into predetermined address fields before it is exchanged across the interface.
- *The number of bytes comprising address data varies from one model ID to another.
- *The error checking process uses a checksum that provides a bit pattern where the least significant 7 bits are zero when values for an address, size, and that checksum are summed.

Acknowledge : ACK (43H)

This message is sent out when no error was detected on reception of a WSD, DAT, "End of data (EOD)", or some other message and a requested setup or action is complete. Unless it receives an ACK message, the device at the other end will not proceed to the next operation.

Byte	Description
F0H	Exclusive status
41H	Manufacturer ID (Roland)
DEV	Device ID
MDL	Model ID
43H	Command ID
F7H	End of exclusive

End of data : EOD (45H)

This message is sent out to inform a remote device of the end of a message. Communication, however, will not come to an end unless the remote device returns an ACK message even though an EOD message was transmitted.

Byte	Description
F0H	Exclusive status
41H	Manufacturer ID (Roland)
DEV	Device ID
MDL	Model ID
45H	Command ID
F7H	End of exclusive

Communications error : ERR (4EH)

This message warns the remote device of a communications fault encountered during message transmission due, for example, to a checksum error. An ERR message may be replaced with a "Rejection (RJC)" one, which terminates the current message transaction in midstream.

When it receives an ERR message, the sending device may either attempt to send out the last message a second time or terminate communication by sending out an RJC message.

Byte	Description
F0H	Exclusive status
41H	Manufacturer ID (Roland)
DEV	Device ID
MDL	Model ID
4EH	Command ID
F7H	End of exclusive

ala
sed
ray
ted
om
les
en
sd.
on
er
ss
ill

Rejection : RJC (4FH).

This message is sent out when there is a need to terminate communication by overriding the current message. An RJC message will be triggered when:

- a WSD or RQI message has specified an illegal data address or size.
- the device is not ready for communication.
- an illegal number of addresses or data has been detected.
- data transfer has been terminated by an operator.
- a communications error has occurred.

An ERR message may be sent out by a device on either side of the interface. Communication must be terminated immediately when either side triggers an ERR message.

Byte	Description
F0H	Exclusive status
41H	Manufacturer ID (Roland)
DEV	Device ID
MDL	Model ID
4FH	Command ID
F7H	End of exclusive

Example of Message Transactions

● Data transfer from device (A) to device (B).

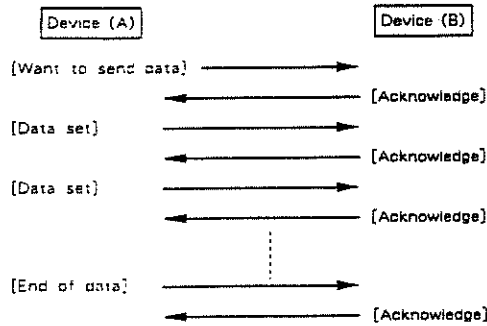

● Device (A) requests and receives data from device (B).

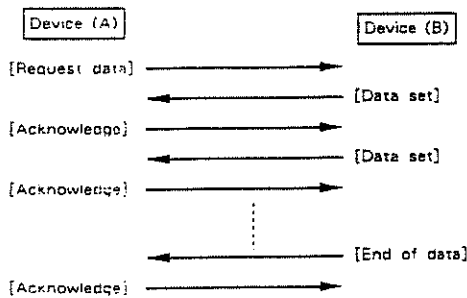

● Error occurs while device (A) is receiving data from device (B).

1) Data transfer from device (A) to device (B)

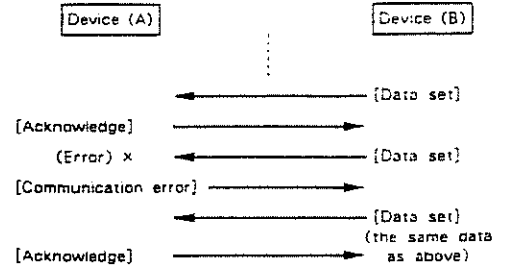

2) Device (B) rejects the data re-transmitted, and quits data transfer.

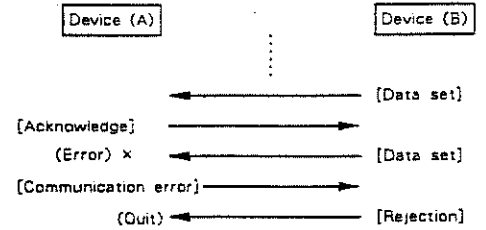

3) Device (A) immediately quits data transfer.

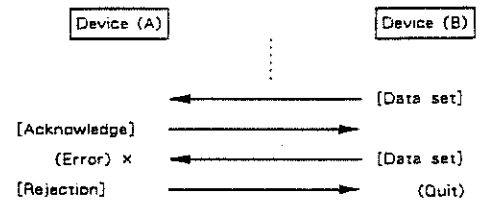

1. TRANSMITTED DATA

■ System Exclusive

Exclusive

Status
 F0H : System Exclusive
 F7H : EOX (End Of Exclusive)

Transmitted in the following three cases.

- 1) Operating Bulk - Dump
- 2) Operating Parameter Transmitting in Patch edit mode.
- 3) Receiving DATA REQUEST (DT1)

Exclusive messages are transmitted only when exclusive switch (setup parameter) is ON. But manual bulk dump transmitting is always available irrespective of the switch.

Refer to Section 4. to see details.

2. RECOGNIZED RECEIVE DATA (CONTROL CHANNEL)

■ CONTROL CHANGE

Control change messages are recognized only when control change switch (setup parameter) is on.

Data Entry MSB

Status	Second	Third
BnH	06H	vvH

MSB of value that corresponds to the parameter specified by RPC.
 (Refer to RPC)

n = MIDI channel 0H - FH (1 - 16)

Data Entry LSB

Status	Second	Third
BnH	26H	vvH

LSB of value that corresponds to the parameter specified by RPC. (Refer to RPC)

Data Increment

Status	Second	Third
BnH	60H	vvH

The value that corresponds to the parameter specified by RPC will be increased when this message is received.
 vv will be ignored. (Refer to RPC)

Data Decrement

Status	Second	Third
BnH	61H	vvH

The value that corresponds to the parameter specified by RPC will be decreased when this message is received.
 vv will be ignored. (Refer to RPC)

RPC LSB

Status	Second	Third
BnH	64H	vvH

LSB of the parameter number specified by RPC. (Refer to RPC)

RPC MSB

Status	Second	Third
BnH	65H	vvH

MSB of the parameter number specified by RPC. (Refer to RPC)

* RPC (Registered Parameter Control)

Using MIDI RPC, parameters can be changed by control change messages. In control channel, only Master Fine Tune can be changed.

RPC MSB and RPC LSB specify the parameter to be controlled, and Data Entry MSB Data Entry LSB, Data increment and Data Decrement change the value.

RPC MSB	RPC LSB	Data Entry MSB	Data Entry LSB	Description
00H	01H	vv	vv	Master Fine Tuning
		00H	4AH	- 99 cent
		40H	00H	0 cent
		7FH	36H	- 99 cent

■ Program Change

Recognized when 'SETUP: PGM CHANGE' is 'ON'.

Patch Change

Status	Second
CnH	ppH

pp = Patch number - 1 (0 - 63)
 pp will be ignored when pp is larger than 63.

■ Exclusive

Recognized when 'SETUP: EXCLUSIVE' is 'ON'.

Status	Second
F0H	: System Exclusive
F7H	: EOX (End Of Exclusive)

Using System Exclusive Messages, Patch parameters can be changed individually. Also used for BULK DUMP operations. Refer to Section 4.

3. RECOGNIZED RECEIVE DATA (SEPARATE CHANNEL)

Separate channel means individual PART channel. So, it is possible to control 6 - PART in individually by using separate channels. (System exclusive messages are recognized or transmitted in only control channel.)

■ Note Event

Note Off

Status	Second	Third
8nH	kkH	vvH
9nH	kkH	00H

kk = Note Number 00H - 7FH
 vv = Velocity ignored
 n = MIDI channel 0H - FH (1 - 16)

Note On

Status	Second	Third
9nH	kkH	vvH

kk = Note Number 00H - 7FH (Key Range can be changed)
 vv = Velocity 00H - 7FH
 n = MIDI channel 0H - FH (1 - 16)

■ Polyphonic Key Pressure

Recognized when 'SETUP: POLY PRESS' is 'ON'.

Polyphonic Key Pressure

Status	Second	Third
AnH	kkH	vvH

kk = Note number 00H - 7FH
 vv = Polyphonic Key Pressure Value 00H - 7FH

■ CONTROL CHANGE

Control change messages are recognized only when control change switch (setup parameter) is on.

Modulation Depth

Status	Second	Third
BnH	01H	vvH

vv = Modulation Depth (0 - 127)

DATA Entry MSB

Status	Second	Third
BnH	06H	vvH

MSB of value that corresponds to the parameter specified by RPC.(Refer to RPC)

n = MIDI channel 0H - FH (1 - 16)

Volume

Status	Second	Third
BnH	07H	vvH

'vv' corresponds to the parameter; 'PATCH : PART : PART LEVEL'.
vv = 00H - 0FH (0 - 15)

Data Entry LSB

Status	Second	Third
BnH	26H	vvH

LSB of value that corresponds to the parameter specified by RPC.(Refer to RPC)

Hold 1

Status	Second	Third
BnH	40H	vvH

vv = 00H - 3FH : OFF
vv = 40H - 7FH : ON

Data Increment

Status	Second	Third
BnH	60H	vvH

The value that corresponds to the parameter specified by RPC will be increased when this message is received.
vv will be ignored.(Refer to RPC)

Data Decrement

Status	Second	Third
BnH	61H	vvH

The value that corresponds to the parameter specified by RPC will be decreased when this message is received.
vv will be ignored.(Refer to RPC)

RPC LSB

Status	Second	Third
BnH	64H	vvH

LSB of the parameter number specified by RPC.(Refer to RPC)

RPC MSB

Status	Second	Third
BnH	65H	vvH

MSB of the parameter number specified by RPC.(Refer to RPC)

All Controllers Reset

Status	Second	Third
BnH	79H	vvH

If this message is recognized, all following parameters will be reseted.

Modulation, Hold1, Pitch Bend, Channel Pressure, Polyphonic Key Pressure And, the value 'aa' will be ignored.

* RPC (Registered Parameter Control)

Using MIDI RPC, parameters can be changed by control change messages. In separate channel, only Bend Range can be changed.(Refer to * RPC of control channel)

RPC MSB	LSB	Data Entry MSB	LSB	Description
00H	00H	vv	ignored	Bend Range
		vv = 0H - 0CH		0 - 12 semitons

Mode Message

All Notes Off

Status	Second	Third
BnH	aaH	vvH

If the value 'aa' is between 7BH and 7FH

Program Change

Recognized when 'PATCH : PART : PGM CHANGE' is 'ON'.

Tone Change

Status	Second
CnH	ppH

pp = 00H - 7FH

When this message is received, the number 'pp' will be converted to corresponding TONE number referring to the PGM → TONE MAP.

Channel Pressure

Recognized when 'SETUP : CH PRESSURE' is 'ON'.

Channel Pressure

Status	Second
DnH	vvH

vv = Channel Pressure value 00H - 7FH

Pitch Bender Change

Recognized when 'SETUP : PITCH BENDER' is 'ON'.

Pitch Bender Change

Status	Second	Third
EnH	vvH	vvH

vv vv = Pitch Bender value 00 00 - 7F 7F

Active Sensing

Active Sensing

Status
FEH

Once this message is received, U-110 start watching the time intervals of messages data. If no data is recognized for more than 300msec, all sounds will be muted and all controllers will be reseted. And U-110 will stop watching the time interval of message data after that.

4. Exclusive Communication

4.1 General Description

There are two types of U-110's exclusive messages. One is individual parameter communication. (Refer Section 4.2) And another is Bulk Dump. (Refer Section 4.3) Coarse address map of exclusive communications is as follows.

Address (7Bit - Hex)	Description
Individual Parameters	
000100	Patch Parameters
Bulk Dump	
010000	Setup Parameters
010100	Patch Parameters (Temporary)
020000	Patch Parameters (1 - 64)
060000	Program Change Map 1 - 6

Check Sum

All exclusive messages of U-110 includes check sum data. That is explained in 'Roland Exclusive Messages'.

If you want to transmit these messages to U-110 from computers or MIDI sequencers, you must calculate their check sum values. Super-MRC (a sequencer software for Roland MC-500, MC-500MKII, MC-300) can calculate them automatically. Of course, you need not calculate when you use the exclusive message data which you recorded from U-110 directly.

There is another way to calculate check sum data very easily. U-110 displays correct check sum value if it receive a exclusive message which includes wrong check sum data. So you can know correct value by transmitting a exclusive data which includes dummy check sum. You will complete the exclusive message when you replace the dummy data with correct data.

4.2 Individual Parameter Control

4.2.1 Description

These communications are available when 'SETUP: MIDI: EXCLUSIVE' is 'ON'.

A patch parameter which is displayed in current LCD page, will be transmitted when [PART/JUMP] button is pressed.

Transmitting 'RQ1' means requiring U-110 to transmit a value of a parameter. If U-110 received any 'RQ1', it will transmit the corresponding data with 'DT1'.

Transmitting 'DT1' to U-110 means changing corresponding parameters of U-110.

Each parameters have various data length. And data length of a message which includes 'RQ1' command is ignored and regard as proper length.

All message must include top address data of the parameter. The message which includes halfway address will be ignored. It is explained in following address maps.

4.2.2 Address Map of Individual

Parameter Control

Address (7Bit Hex)	Data	Description
000100	Patch Parameters	
0	0000 1111	TOPE NAME LOWER
1	0000 0000	TOPE NAME UPPER
:	0000 1111	(20H FFH (in ASCII map))
13	Access from address 000000, not 000001 000013	
18	0000 0000	OUTPUT WIDE 0 19 (: 50)

Display Value on LCD

19	0000 0000	CHORUS RATE	0 - 15 (0 - 15)
1A	0000 0000	CHORUS DEPTH	0 - 15 (0 - 15)
1B	0000 0000	TREMOLO RATE	0 - 15 (0 - 15)
1C	0000 0000	TREMOLO DEPTH	0 - 15 (0 - 15)

n = PART number (0 - 5)

001n00	0000 0aaa	OUTPUT ASSIGN	0 - 6 (1 - 6, OFF)
001n01	0000 0aaa	RECEIVE CHANNEL	0 - 15 (1 - 16)
001n02	000a 0aaa	TOPE MEDIA	0 - 31 (INT, CO1 - C31)
001n03	0aaa 0aaa	TOPE NUMBER	0 - 98 (1 - 99)
001n04	0000 0aaa	BEND RANGE	0 - 12 (0 - 12)
001n05	0aaa 0aaa	KEY RANGE LO	0 - 127 (C-1 - G9)
001n06	0aaa 0aaa	KEY RANGE HI	0 - 127 (C-1 - G9)
001n07	0aaa 0aaa	PART LEVEL	0 - 127 (0 - 127)
001n08	0000 0aaa	VELOCITY SENS	0 - 15 (0 - 15)
001n09	0000 0aaa	LEVEL PRESS SENS	0 - 15 (0 - 15)
001n0A	0000 0aaa	ENV ATTACK RATE	1 - 15 (-7 - -7)
001n0B	0000 0aaa	ENV RELEASE RATE	1 - 15 (-7 - -7)
001n0C	0aaa 0aaa	PITCH SHIFT COARSE	52 - 76 (-12 - +12)
001n0D	0aaa 0aaa	PITCH SHIFT FINE	14 - 114 (-50 - +50)
001n0E	0000 0aaa	LFO RATE 0 - 15 (0 - 15)	0 - 15 (0 - 15)
001n0F	0000 0aaa	LFO AUTO DELAY TIME	0 - 15 (0 - 15)
001n10	0000 0aaa	LFO AUTO RISE TIME	0 - 15 (0 - 15)
001n11	0000 0aaa	LFO AUTO DEPTH	0 - 15 (0 - 15)
001n12	0000 0aaa	LFO MAX RISE TIME	0 - 15 (0 - 15)
001n13	0000 0aaa	LFO MAX DEPTH	0 - 15 (0 - 15)
001n14	0000 0aaa	LFO CH PRESS SENS	0 - 7 (0 - 7)
001n15	0000 000a	PGM CHANGED - 1 (OFF, ON)	
001n16	0000 0aaa	PGM CHANGE MAP	0 - 5 (1 - 6)
001n17	0000 0aaa	DETUNE DEPTH	0 - 15 (0 - 15)
001n18	0000 0aaa	PITCH POLY PRESS SENS	0 - 15 (-24 - +12)
001n19	0000 0aaa	LFO POLY PRESS SENS	0 - 7 (0 - 7)

4.3 Bulk Dump

4.3.1

If U-110 received bulk dump data with 'DT1' command, the corresponding internal data will be changed.

Bulk Dump data are transmitted when U-110 received 'RQ1' command or operated manually.

There are some types of Bulk Dump data as follows.

A. SETUP

Function: Communication of SETUP parameters except PGM → TONE maps.

Usage of RQ1: Address : 010000H (7bit - hex)
Data length : 000020H (7bit - hex)

Response of RQ1: Transmitted as follows. (Command ID is 'DT1')

Packets * : 1
Address : 010000H
Data length : 000020H

* Packet means a data block from 'F0H' to 'F7H'.

Manual transfer: Transmitted with Map data at 'UTILITY: BULK DUMP SETUP'.

Response of DT1: All MIDI controller value (bender, ch. pressure,...) is reseted.

B. Patch parameter (Temporary)

Function: Communication of the Temporary Patch parameters.

Usage of RQ1: Address : 010100H
Data length : 000200H

Response of RQ1: Same as the manual transfer.

Manual transfer: Transmitted at 'UTILITY: BULK DUMP TEMP PATCH'.

Packets : 2
Address : 010100H, 010200H
Data length : 00007FH, 00007FH

Response of DT1: All MIDI controller value (bender, ch. pressure,...) is reseted, and all sounds are muted.

C. Patch parameter (1 - 64)

Function : Communication of the Patch (1 - 64) parameters.

Usage of RQ1 : Address : 020000H
Data length : 010000H

Response of RQ1 : Same as the manual transfer.

Manual transfer : Transmitted at 'UTILITY : BULK DUMP 1 - 64 PATCH'.

Packets : 128
Address : 020000H, 020100H, ... ,027F00H
Data length : 00007FH, 00007FH, ... ,00007FH

Response of DT1 : Only 1 - 64 patch parameters will be changed.

D. Program change map

Function : Communication of the program change (PGM → TONE maps).

Usage of RQ1 : Address : 060000H
Data length : 001800H

Response of RQ1 : Same as the manual transfer.

Manual transfer : Transmitted with setup data at
'UTILITY : BULK DUMP SETUP'.

Packets : 24
Address : 060000H, 060100H, ... ,061700H
Data length : 00007FH, 00007FH, ... ,00007FH

Response of DT1 : Only program change maps will be changed.

4.2.2 Address map of Bulk Dump

mal

sted

NE

Address (7Bit - Hex)	Data	Description
010000 : 01001F		Setup (except program change map)
010100 : 01027F		Patch Parameters (Temporary)
020000 : 027F7F		Patch Parameters (1 - 64)
060000 : 06177F		Program Change Map 1 - 6

.P.

ed.

ed.

Function ...		Transmitted	Recognized	Remarks
Basic Channel	Default	1 - 16	1 - 16	Memorized
	Changed	1 - 16	1 - 16	
Mode	Default	×	Mode 3	
	Messages	×	×	
	Altered	*****		
Note Number	True Voice	×	0 - 127	
		*****	0 - 127	
Velocity	Note ON	×	○ (v = 1 - 127)	
	Note OFF	×	×	
After Touch	Key's	×	* 1	
	Ch's	×	* 1	
Pitch Bender		×	* 1 (0 - 12 semi)	9 bit resolution
Control Change	1	×	* 1	Modulation
	7	×	* 1	Main Volume
	64	×	* 1	Hold 1
	100, 101	* 1, * 2 (0, 1)	* 1, * 2 (0, 1)	RPC LSB, MSB
	6, 38	* 1, * 2	* 1, * 2	Data Entry MSB, LSB
	96, 97	* 1, * 2	* 1, * 2	Data Increment .Decrement
Prog Change	True #	×	* 1 (0 - 127)	

System Exclusive		* 1	* 1	
System Common	Song Pos	×	×	
	Song Sel	×	×	
	Tune	×	×	
System Real Time	Clock	×	×	
	Commands	×	×	
Aux Message	Local ON/OFF	×	×	
	All Notes OFF	×	○ (123 - 127)	
	Active Sense	×	○	
	Reset	×	×	
Notes		* 1 Can be set to o or x manually, and memorized. * 2 RPC = Registered parameter control number. RPC # 0 : Pitch bend sensitivity RPC # 1 : Master fine tuning Parameter values are given by Data Entry.		

■ SPECIFICATIONS

U-110 : PCM Sound Module

● Sound Module

DC - PCM Sound

Maximum Number of Voices : 31

● Front Panel

Volume Control Knob

Part/Jump Button

Cursor Buttons (◀ ▶)

Edit/Exit Button

Decrement Button

Increment/Enter Button

Headphones Socket

Card Slots (× 4)

Power Switch

● Display

16 letter 2 line LCD (backlit)

● Indicator

Part/Jump Indicator

Edit Indicator

MIDI Message Indicator

● Rear Panel

MIDI Connectors (IN/OUT/THRU)

Multi Output Sockets (1 to 6)

Mix Output Sockets (L/R)

● Dimensions

482 (W) × 358 (D) × 45 (H) mm

19" × 14" × 1-3/4"

EIA - 1U Rack Mount Type

● Weight

4.5 kg / 9 lb. 15 oz.

● Power Consumption

21W

● Accessories

Connection Cable (2.5m) × 1

MIDI Cable (1m) × 1

Owner's Manual

Preset Tone/Patch Setting Chart

Operation Map/Parameter Chart

Rom Play Manual

Guide Book for MIDI

● Options

Sound Library SN-U110-01 to 07

Stereo Headphones RH-100

Connection Cord PJ-1M

MIDI/SYNC Cable MSC-07 / 15 / 25 / 50
/ 100

*The supplied MIDI cable is specifically for MIDI connection. Do not use it for any other connection such as DIN Sync or audio setup.

*The specifications of this product are subject to change without prior notice for improvement.

 Roland®

10693

UPC

10693



0991

U-110

 Roland

270154B2 : 88.10.BE2-3S