

Roland

MIDI RHYTHM COMPOSER

TR-626

Owner's Manual

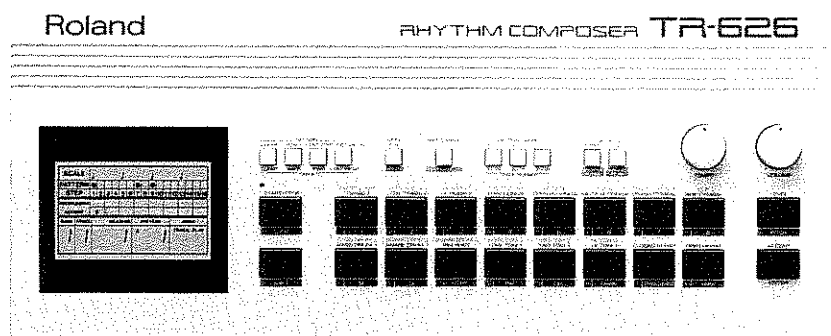

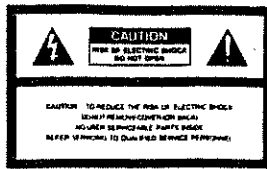

The lightning flash with arrowhead symbol, within an equilateral triangle, is intended to alert the user to the presence of uninsulated "dangerous voltage" within the product's enclosure that may be of sufficient magnitude to constitute a risk of electric shock to persons.



The exclamation point within an equilateral triangle is intended to alert the user to the presence of important operating and maintenance (servicing) instructions in the literature accompanying the product.

INSTRUCTIONS PERTAINING TO A RISK OF FIRE, ELECTRIC SHOCK OR INJURY TO PERSONS.

IMPORTANT SAFETY INSTRUCTIONS

WARNING When using electric products, basic precautions should always be followed, including the following:

1. Read all the instructions before using the product.
2. To reduce the risk of injury, close supervision is necessary when a product is used near children.
3. Do not use this product near water—for example, near a bathtub, washbowl, kitchen sink, in a wet basement, or near a swimming pool, or the like.
4. This product should be used only with a cart or stand that is recommended by the manufacturer.
5. This product, either alone or in combination with an amplifier and headphones or speakers, may be capable of producing sound levels that could cause permanent hearing loss. Do not operate for a long period of time at a high volume level or at level that is uncomfortable. If you experience any hearing loss or ringing in the ears, you should consult an audiologist.
6. The product should be located so that its location or position does not interfere with its proper ventilation.
7. The product should be located away from heat sources such as radiators, heat registers or other products that produce heat.
8. The product should avoid using in where it may be affected by dust.
9. The product should be connected to a power supply only of the type described in the operating instructions or as marked on the product.
10. The power-supply cord of the product should be unplugged from the outlet when left unused for a long period of time.
11. Do not tread on the power-supply cord.
12. Do not pull the cord but hold the plug when unplugging.
13. When setting up with any other instruments, the procedure should be followed in accordance with instruction manual.
14. Care should be taken so that objects do not fall and liquids are not spilled into the enclosure through openings.
15. The product should be serviced by qualified service personnel when:
 - A: The power-supply cord or the plug has been damaged; or
 - B: Objects have fallen, or liquid has been spilled into the product; or
 - C: The product has been exposed to rain; or
 - D: The product does not appear to operate normally or exhibits a marked change in performance; or
 - E: The product has been dropped, or the enclosure damaged.
16. Do not attempt to service the product beyond that described in the user-maintenance instructions. All other servicing should be referred to qualified service personnel.

SAVE THESE INSTRUCTIONS

ADVARSEL!

Lithiumbatteri. Eksplosionsfare.
Udskiftning må kun foretages af en sagkyndig,
og som beskrevet i servicemanual.

WARNING!

Lithiumbatteri. Explosionsrisk.
Får endast bytas av behörig servicetekniker.
Se instruktioner i servicemanualen.

ADVARSEL!

Lithiumbatteri. Fare for eksplosion.
Må bare skiftes av kvalifisert tekniker som
beskrevet i servicemanualen.

VAROITUS!

Lithiumparisto. Räjähdyksvaara.
Pariston saa vaihtaa ainoastaan
alan ammottimies.

WARNING

THIS APPARATUS MUST BE EARTH GROUNDED.

The three conductors of the mains lead attached to this apparatus are identified with color as shown in the table below, together with the matching terminal on the UK type power plug. When connecting the mains lead to a plug, be sure to connect each conductor to the correct terminal, as indicated. "This instruction applies to the product for United Kingdom."

MAINS LEADS		PLUG
Conductor	Color	Mark on the matching terminal
Live	Brown	Red or letter L
Neutral	Blue	Black or letter N
Grounding	Green-Yellow	Green, Green-Yellow, letter E or symbol

Bescheinigung des Herstellers /Importeurs

Hiermit wird bescheinigt, daß der/die/das

ROLAND RHYTHM COMPOSER TR-626

(Gerät, Typ Bescheinigung)

in Übereinstimmung mit den Bestimmungen der

Amtsbl. Vfg 1046 / 1984

(Amtsblätterverfügung)

funk-entstört ist.

Der Deutschen Bundespost wurde das Inverkehrbringen dieses Gerätes angezeigt und die Berechtigung zur Überprüfung der Serie auf Einhaltung der Bestimmungen eingeräumt.

Roland Corporation Osaka / Japan

Name des Herstellers/Importeurs

RADIO AND TELEVISION INTERFERENCE

"Warning - This equipment has been verified to comply with the limits for a Class B computing device, pursuant to Subpart J, of Part 15, of FCC rules. Operation with non-certified or non-verified equipment is likely to result in interference to radio and TV reception."

The equipment described in this manual generates and uses radio-frequency energy. If it is not installed and used properly, that is, in strict accordance with our instructions, it may cause interference with radio and television reception.

This equipment has been tested and found to comply with the limits for a Class B computing device in accordance with the specifications in Subpart J, of Part 15, of FCC Rules. These rules are designed to provide reasonable protection against such a interference in a residential installation.

However, there is no guarantee that the interference will not occur in a particular installation. If this equipment does cause interference to radio or television reception, which can be determined by turning the equipment on and off, the user is encouraged to try to correct the interference by the following measures:

- Disconnect other devices and their interconnect cables one at a time. If the interference stops, it is caused by either the other device or its FCC cable.
- These devices usually require Roland designed shielded I/O cables. For Roland devices, you can obtain the proper shielded cable from your dealer. For non-Roland devices, contact the manufacturer or dealer for assistance.
- If your equipment does cause interference to radio or television reception, you can try to correct the interference by using one or more of the following measures:
 - Turn the TV or radio antenna until the interference stops.
 - Move the equipment to one side or the other of the TV or radio.
 - Move the equipment farther away from the TV or radio.
 - Plug the equipment into an outlet that is on a different circuit than the TV or radio. (That is, make certain the equipment and the radio or television set are on circuits controlled by different circuit breakers or fuses.)
 - Consider installing a rooftop television antenna with coaxial cable leads in between the antenna and TV.

If necessary you should consult your dealer or an experienced radio-television technician for additional suggestions. You may find helpful the following booklet provided by the Federal Communications Commission:

"How to Identify and Resolve Radio-TV Interference Problems"

This booklet is available from the U.S. Government Printing Office, Washington, D.C. 20402. Since the 200-000-0036-6.

Please read the separate volume "MIDI", before reading this owner's manual.

Copyright © 1987 by ROLAND CORPORATION

All rights reserved. No part of this publication may be reproduced in any form without the written permission of ROLAND CORPORATION.

CONTENTS

Panel Description	3
Important	5
Outline of the TR-626	7
Connections	8
1 Basic Operation	9
1. Checking the drum voices and the sounds output	9
a. Manual playing	10
b. Playing the factory preset	13
c. Adjusting individual drum voices	16
■ Level (sound volume) adjustment	16
■ Pitch (musical interval) adjustment	18
2. A Brief Description of Rhythm Writing	20
3. Playing and Writing Rhythm Patterns	23
a. Rhythm pattern playing	24
b. Rhythm pattern writing	26
■ Tap writing	26
■ Step writing	31
4. Track Writing and Playing	35
a. Track writing	35
b. Track playing	41
2 Applications	42
1. Functions to use while pattern writing	42
a. Copying rhythm patterns	42
b. Setting the scale and last step	43
c. Chaining rhythm patterns	47
d. Block writing	48
e. Flam	49
f. Shuffle	52
2. Functions to use while track writing	54
a. Delete	54
b. Insert	56
c. Copying bars	58
d. Block writing	60
e. Last measure	60
3. Functions to use while playing a track	61
a. Continue start	61
b. Continue play	61
c. Last measure	61
4. Miscellaneous function	62
a. Designating a bar number	62
b. Block play	63
3 Storing Rhythm Patterns in External Memory	64
1. Memory card	64
a. Changing banks	66
b. Formatting memory cards	67
c. Copying data between banks	68
2. Tape Memory	70
a. Saving	70
b. Verification	72
c. Loading	74
4 Other Useful Functions	75
a. Multi-out jack	75
b. Trigger-out jack	75
c. Start/Stop with a Pedal switch	76
5 MIDI	77
1. Checking the MIDI Function	78
2. Altering a MIDI Function setting	79
a. Using the TR-626 is to be used as a MIDI sound source	79
■ Altering the reception channel	83
■ Altering the OMNI mode	83
■ Altering the key Number of each drum voice	84
b. MIDI synchronized playing	85
■ Altering the sync mode	87
c. Playing MIDI sound modules with the TR-626	89
■ Altering transmission channels for individual sound modules	90
d. MIDI exclusive messages	91
6 Tape SYNC	94
1. Recording a synchronized signal	94
2. Playing with a synchronized signal	95
Before calling the Repaires	97
Attachments	99
Specifications	105

Panel Description

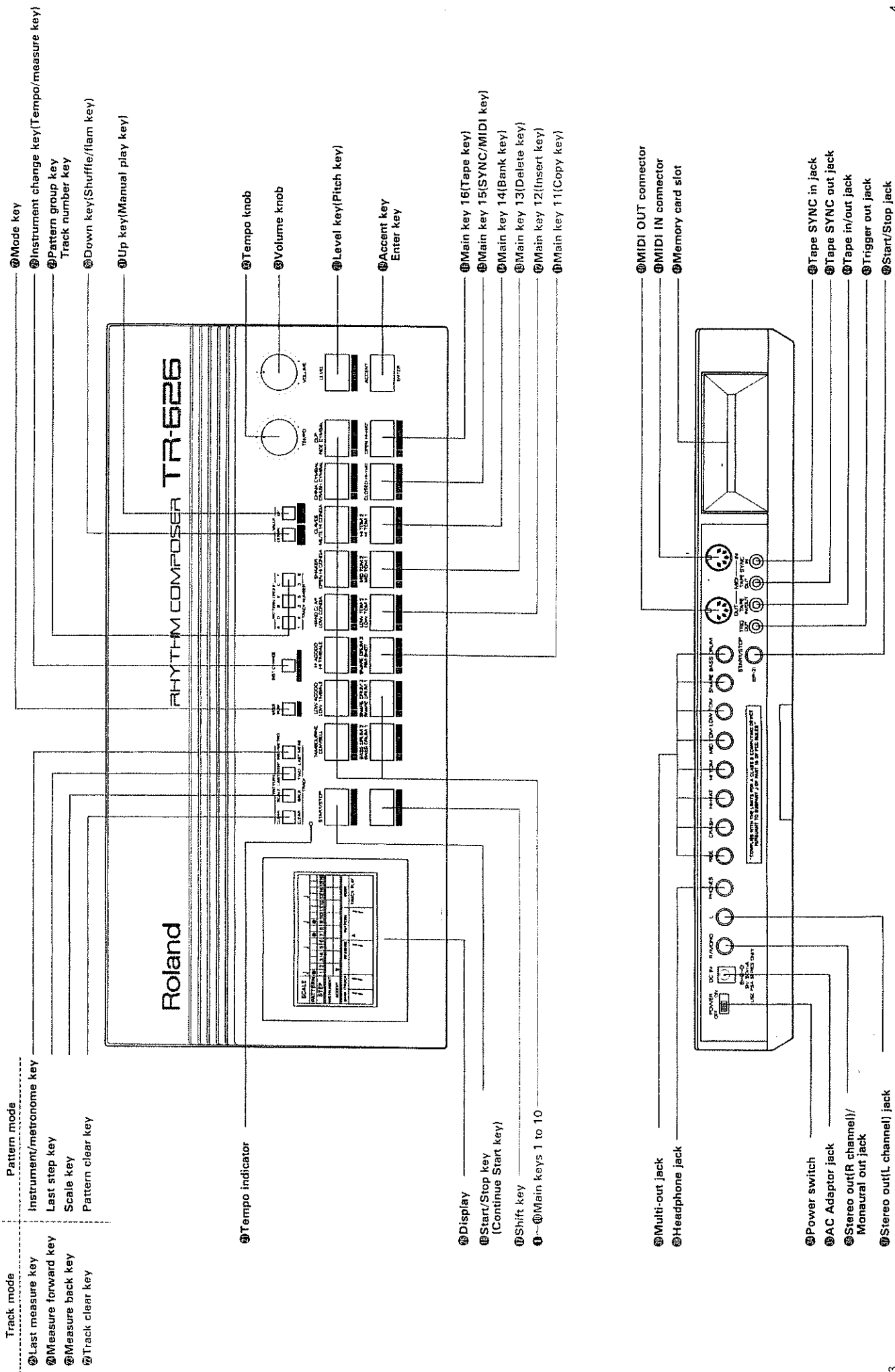

Important

Installation

- There may be interference if the TR-626 is played near a neon or a fluorescent light. Should this occur, change the position of the TR-626.
- Do not play this unit where there is excessive heat or humidity or where it may be affected by direct sunlight or it may become dusty.

Cleaning

- When it becomes dusty, wipe it clean with a soft cloth dampened with a neutral detergent and then wipe it once more with a dry soft cloth.
- Do not use solvents such as paint thinner to clean the TR-626.

Liquid crystal display

- The Display is best viewed from the front of the unit.
- It should not be pushed forcibly or beaten.

Initialization

- After putting batteries into the TR-626 as shown below in "Battery Replacement," the TR-626 must be initialized. Turn the machine off (Power Switch), then turn it back on while holding Mode Key and Pattern Group Key A down.

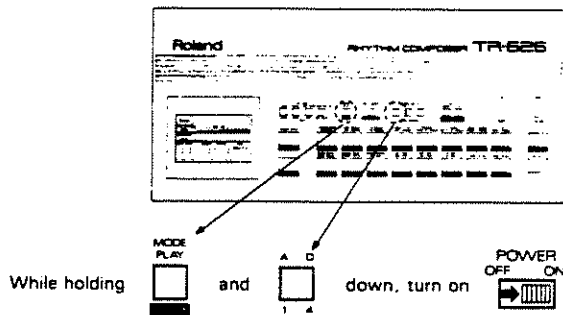

*Doing this operation erases all the data stored in the memory (eg. rhythm pattern and track data). Every setting is initialized to the values set at the factory before shipment.

Memory Backup

Batteries are used, not only for ordinary purposes but also to save stored data after the unit has been turned off. However, if the batteries are worn out or not set properly in their box, the data will be lost after turning the power off. Even when an AC adapter is used, batteries must kept in the battery box.

Battery replacement

- Always observe the following concerning batteries.
- Replace the batteries once a year not matter how infrequently the unit has been used.
- Always replace all of the batteries.
- Never include any used batteries with a group of new batteries. Similarly, never include a different kind battery in a group of otherwise matching ones.
- An old battery kept in the unit may leak battery fluid and damage the unit. If the unit is not to be used for long periods of time, please save the data on a tape or the optional memory card "M-128D", then switch the unit off and remove the batteries. (Any problems or damage resulting from leaked battery fluid is not covered by the warranty.)
- Be sure to place batteries correctly in place, matching polarities correctly, positive to positive and negative to negative.

Battery replacement frequency

● The service life of an ordinary battery is about sixteen hours. This will vary according to the uses to which the battery is put and the type of battery. Should the Tempo Indicator flash more feebly or the sound and/or the operation of the unit become unstable, replace the batteries immediately.

AC adaptor

● For AC operation be sure to use the BOSS AC ADAPTOR PSA-120, 220 or 240 depending on the voltage system in your country, and never use one Adaptor for two units simultaneously.

Replacing batteries

● When performance data has already been written and the batteries have to be replaced, the data can be completely saved if the batteries are replaced within ten minutes. If this is not possible, we recommend that the memory contents be saved onto an audio tape or a optional memory card.(M-128D)

*1.5V (L3) × 6 batteries are necessary.

(1) Make sure that the TR-626 is turned off.

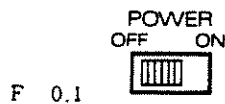

(2) Remove the battery cover found at the bottom of the unit.

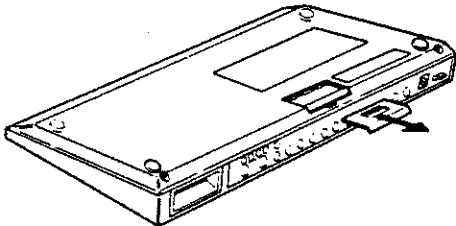

(3) Remove the batteries from the battery box, and replace them with new ones. are to match their polarities correctly (+ to + and - to -).

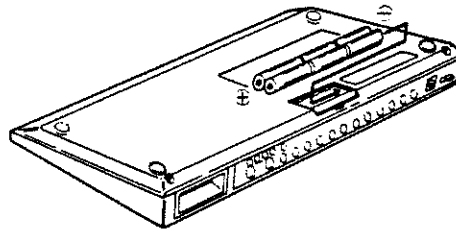

(4) Replace the battery cover.

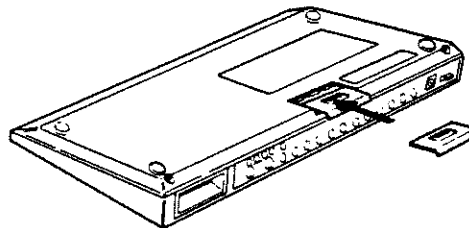

Outline of the TR-626

- ☆The TR-626 Rhythm Composer is a rhythm machine that employs digitally recorded drum voices allowing you to enjoy perfectly reproduced preset rhythm patterns or user-programmed rhythms.
- ☆Its 30 drum voices permit you to create a wide variety of basic drum sounds and latin percussions. In addition, 8 drum groups can be output from 8 Multi Out Jacks.
- ☆The pitch and the level (volume) can be independently set for each drum voice.
- ☆The large display window makes the operation easy to see and understand.
- ☆You can program 6 Tracks (to a maximum of 999 bars) using 96 rhythm patterns, 48 preset and 48 user-programmed. Realistic rhythms can be created by accenting each drum voice individually, with our flam and shuffle effects.
- ☆There are two methods for programming a rhythm pattern: Step Writing in which we enter or load one Step at a time without worrying about tempo, and Tap Writing which is to program a rhythm by actually tapping the Instrument Keys in time with a metronome.
- ☆Playing with a memory card, M-128D, an option, can be treated exactly the same as the internal memory of the TR-626. Data can be instantaneously stored or accessed. A memory card increases the memory capacity 3 times.
- ☆The tape interface function permits the storage and the access of data using a cassette tape.
- ☆This unit meets MIDI specifications permitting interfacing with other MIDI devices. It can be synchronized with them or be used as a rhythm sound source for them. Its Tape Sync Function can be used for multi-track recording in MTR (Multi Track Recorder).

Connections

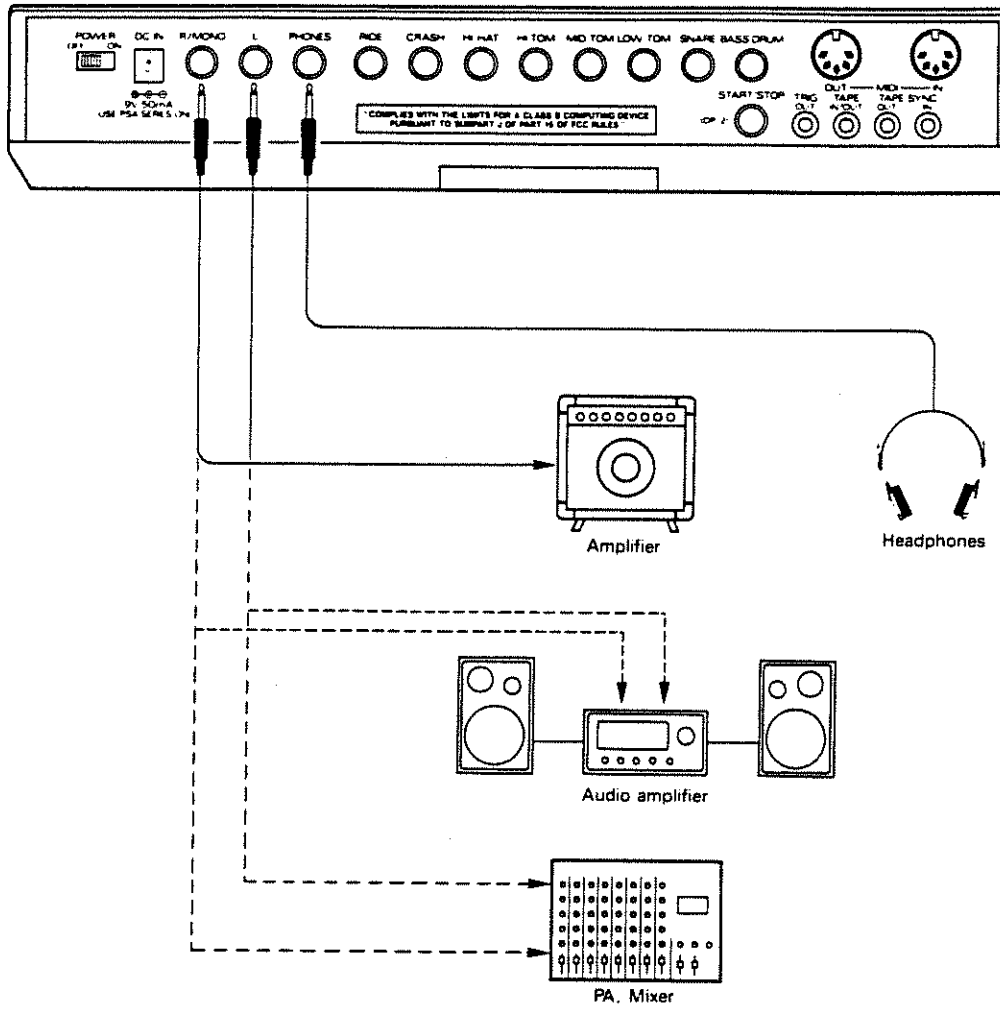

1 Basic Operation

1. Checking the drum voices and the sounds output

The TR-626 stores 30 different drum voices including Latin percussions.

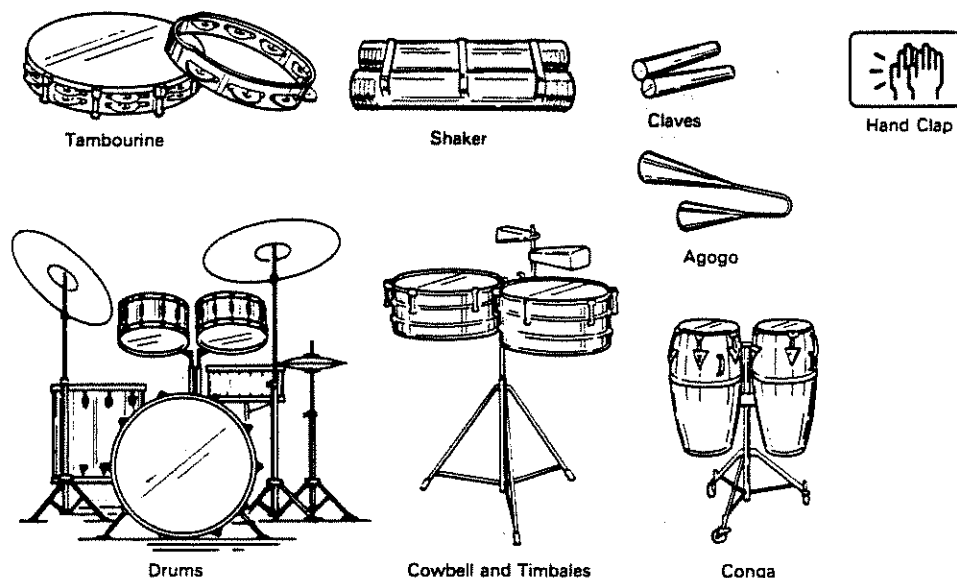

	Drum Voice Group			
1	SNARE DRUM 1 (SD1)	SNARE DRUM 2 (SD2)	LOW TIMBALE (LTB)	HI TIMBALE (HTB)
2	CRASH CYMBAL (CCY)	RIDE CYMBAL (RCY)	CHINA CYMBAL (CHINA)	CUP (CUP)
3	LOW TOM 1 (LT1)	MID TOM 1 (MT1)	HI TOM 1 (HT1)	OPEN HI CONGA (OHCG)
	LOW TOM 2 (LT2)	MID TOM 2 (MT2)	HI TOM 2 (HT2)	LOW CONGA (LCG)
4	OPEN HI-HAT (OHH)	CLOSED HI-HAT (CHH)		
5	RIM SHOT (RIM)	SNARE DRUM 3 (SD3)		
6	BASS DRUM 1 (BD1)	BASS DRUM 2 (BD2)		
7	HAND CLAP (HCP)	CLAVES (CLAVES)	MUTE HI CONGA (MHCG)	SHAKER (SHAKER)
8	COWBELL (CB)	TAMBOURINE (TAMB)	LOW AGOGO (LAG)	HI AGOGO (HAG)

*The drum voices belonging to the same voice group cannot be sounded simultaneously.

*What is written in () is abbreviation of a drum voice.

a. Manual playing

Play the 30 drum voices that are preset in the TR-626 to check that they sound as they should.

Step 1 Turn the power on (Power Switch).

The Display will display the following :

SCALE	J															
PATTERN	●●		●●●●													
STEP	1	2	3	4	5	6	7	8	9	10	11	12	13	14	15	16
INSTRUMENT																
ACCENT	9															
BANK TRACK	11		MEASURE	1c		PATTERN	14		MODE							
TRACK PLAY																

Step 2 When the Main Keys (1 to 16) are pressed, the sound described above the keys will be heard. If you press a key while holding the Accent Key down, the sound emitted will be accented.

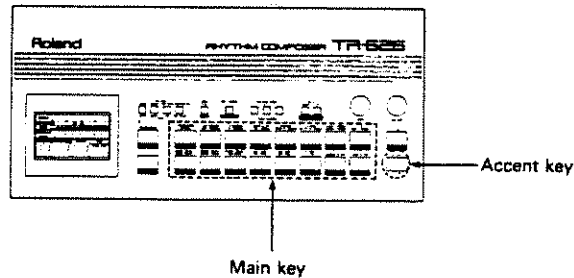

Each of the Main Keys 1 to 14 have been allocated 2 drum voices. These two voices' names are written above each Main Key on the front panel.

Selecting the upper or the lower voice is done in the following manner :

1) Block Switching

To change all of the drum voices from upper to lower or from lower to upper, while holding the Instrument Change Key down, press the Up Key to go to the upper voices, or press down the Down Key to go to the lower voices.

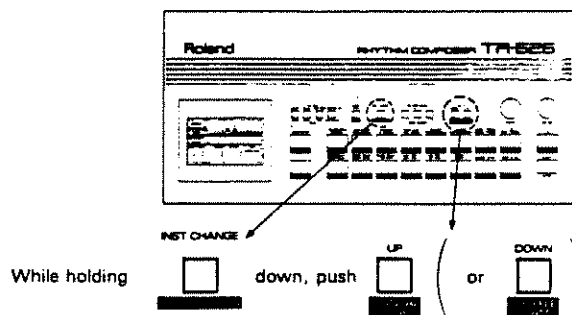

2) Individual switching

To change the drum voices individually from upper to lower or from lower to upper, press the Main Key (1 to 14) that you would like to change while holding the Instrument Change Key down.

(For switching the drum voice of Main key 10)

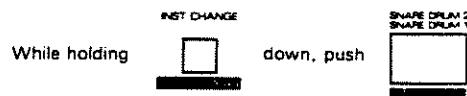

After changing some or all of the Main Keys from the upper to the lower voice or vice versa, the switch can be undone by repeating the operation. Figures that remain constantly lit are allocated to Lower drum voices. Figures that flash are allocated to Upper drum voices.

*Drum Voices that are allocated to the Main Keys can be switched in all of the modes. (See p.21.)

*Drum Voices can be changed while playing the rhythm composer.

*The drum voice chosen is retained in memory after the power is turned off.

● Checking the drum voice currently allocated to each Main Key

Pressing the Instrument Change Key will display which drum voice is currently allocated to each Main Key.

INSTRUMENT	1	2	3	4	5	6	7	8
ACCENT	9	10	11	12	13	14	15	16

When the number of the Main key is lit, the drum voice marked at the lower line above the key is used. The upper drum voice is used when the number is flashing.

b. Playing the Factory Preset

The TR-626 has some preset data in its memory. It can be reproduced by carrying out the following procedure :

Check to see if the TR-626 is in TRACK PLAY mode and on Track 1.

BANK	TRACK	MEASURE	PATTERN	MODE
1	1	1 c	14	TRACK PLAY

If any other mode is shown, set the TR-626 to TRACK PLAY mode by pushing the Mode Key until it is. If Track 1 is not displayed, put the machine onto Track 1 by pressing Track Number Key.1 (4)

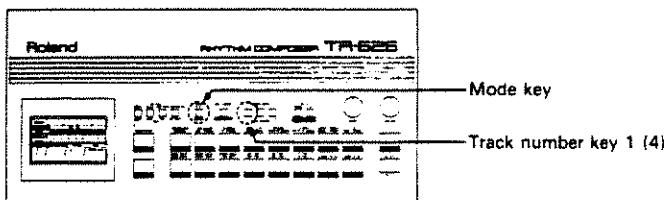

Push the Start/Stop Key to begin playing. Pushing it again will stop the reproduction of the preset Rhythm.

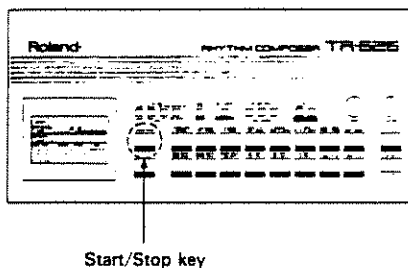

During the reproduction of the preset Rhythm, shows the contents of the performance information.

SCALE	J															
PATTERN	●	●														
STEP	1	2	3	4	5	6	7	8	9	10	11	12	13	14	15	16
INSTRUMENT																
ACCENT	9															
BANK	TRACK		MEASURE	PATTERN	MODE											
1	1		8	7	TRACK PLAY											

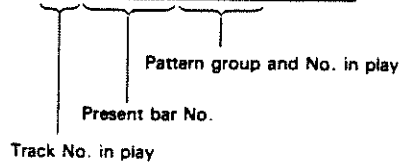

The volume is adjusted with the Volume Control Knob. The tempo is adjusted with the Tempo Control Knob.

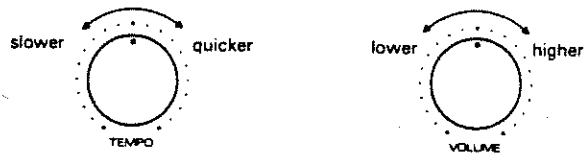

If you would like a numerical tempo value to be displayed, push the Tempo/Measure Key while holding the Shift Key down.

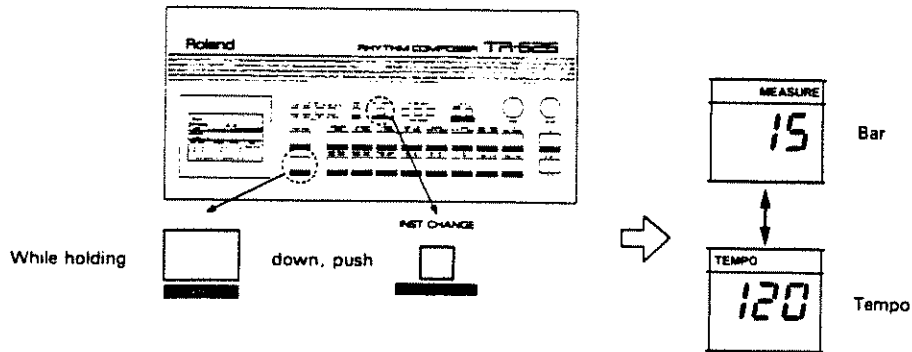

The tempo can be set within a range between 40 to 240. It is displayed as follows :

40-140Displays every numerical value increase of 2.
(40, 42, 44, ...)

140-240Displays every numerical value increase of 4.
(140, 144, 148, ...)

Repeating this procedure will recover the original indication.

***After emitting the final bar, the first bar will automatically be repeated.**

***Only Track 1 has data written on it prior to shipping the unit. No sound will be reproduced if one of Tracks 2 to 6 are chosen.**

c. Adjusting individual drum voices

The volume (level) and the pitch can be set for each drum voice. Once set, this setting will be retained in memory even after the power has been turned off.

■ Level (sound volume) adjustment

Step 1 Press the Level Key.

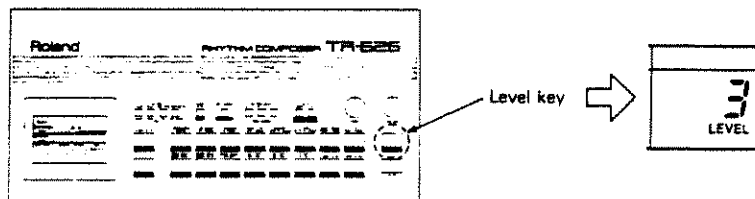

The Display will display LEVEL. Every drum voice's level is now adjustable.

Step 2 Press whichever of the Main Keys (1 to 16) whose drum voice level you would like to adjust.

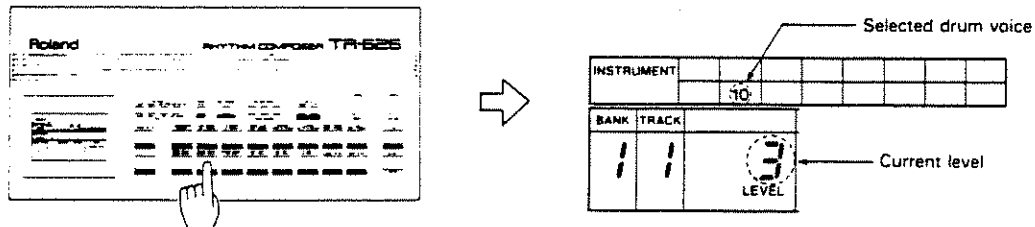

The Display gives the number of the designated Main Key and its presently allocated drum voice level.

If you would like to adjust the level of a drum voice currently not chosen for the designated Main Key, switch the Key's voice by pressing the Main Key again while holding the Instrument Change key down.

Step 3 To increase the level, press the Up Key. To decrease the level, press the Down Key.

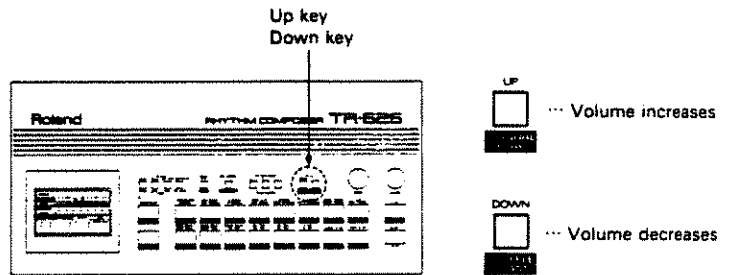

Drum voices sources can be set within a range between 0 to 5. (At 0, no sound will be emitted.) If the TR-626 is not in playing mode, this setting can be done while checking the volume with the Main Key.

If you would like to adjust the level of other drum voices, repeat Steps 2 and 3.

Step 4 Press the Level Key again to return to the condition before step 1 procedure is taken.

LEVEL will no longer be displayed.

*The level can be adjusted in every mode (see p.21) except while writing an accent.

■ Pitch (musical interval) adjustment

Step 1 Press the Pitch Key while holding the Shift Key down.

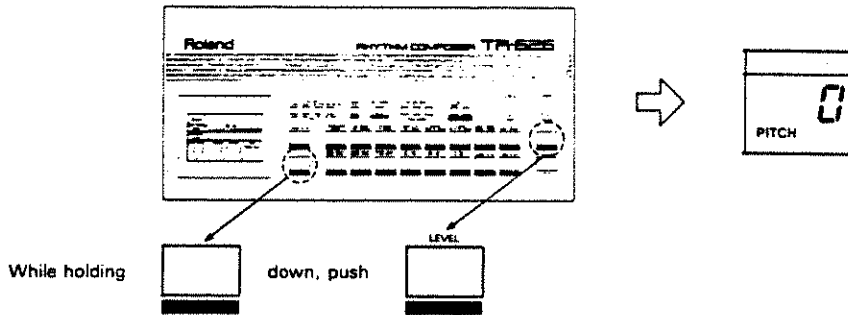

The Display will display PITCH. The pitch can be set for every drum voice.

Step 2 Push the Main Keys whose drum voices' pitch you would like to adjust.

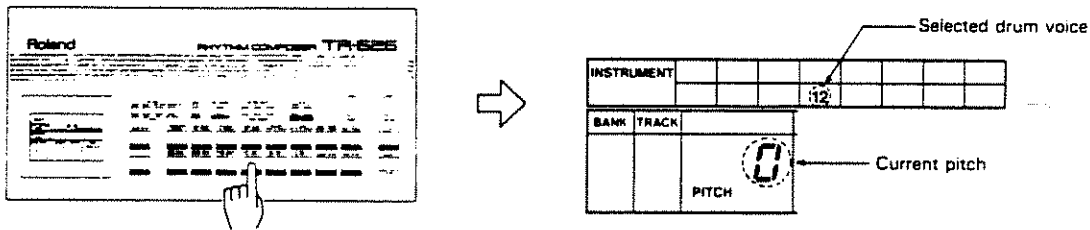

The Display gives the Main Key Number and its pitch. (The pitch is set at 0 at the factory.) If you would like to adjust the pitch of the drum voice currently not chosen for the designated Main Key, switch the Key's voice by pressing the Main Key while holding the Instrument Change Key down.

Step 3 To heighten the pitch, press the Up Key. To lower the pitch, press the Down Key.

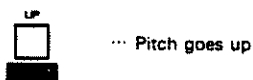

The pitch of drum voices can be set between -7 to +7. If the TR-626 is not in playing mode, this setting can be done while checking the volume with the Main Key.

If you would like to change other drum voices' pitches, repeat Steps 2 and 3.

Step 4 While pressing the Shift Key again, push the Pitch Key to return to the condition before Step 1 procedure taken.

PITCH will no longer be displayed.

*The pitch can be adjusted in every mode (see page 21) except while writing an accent.

*The actual variable range of pitch in each drum voice differs from each other. Changing pitches of a voice may result in change of tone.

(How to initialize the level and the pitch)

To initialize the TR-626's level and pitch settings to the values set in the factory do the following :

Make sure that the unit is turned off, then turn the unit on while holding the Level Key down.



2. A Brief Description of Rhythm Writing

When writing the rhythm for a musical composition using the TR-626, the work can be largely divided into two areas :

1) **Pattern writing** which is to create a rhythm pattern for one bar.

There are two ways to write patterns. One is to manually play the TR-626 keeping time with the metronome (Tap Writing), and the other is set the time for each drum voice (Step Writing).

2) **Track Writing** which is to write rhythm tracks for a composition by combining user-programmed and preset rhythm patterns.

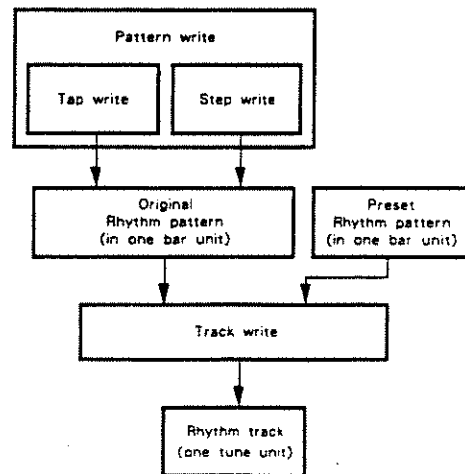

All of this work is done in the following five modes :



Track play...Plays one tune unit

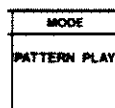

Pattern play...Plays one bar unit



Track write...Creates one tune unit playing data

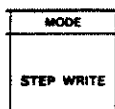

Step write...Creates one bar unit playing data (1)

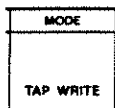

Tap write...Creates one bar unit playing data (2)

The current mode is always shown in the Display. Execute the following steps shown on the next page to switch the mode :

***It is impossible to change modes while rhythm is running.**

Ⓢ Play mode (Track play/Pattern play)

Every time the Mode Key is pushed, the play mode switches between these two.

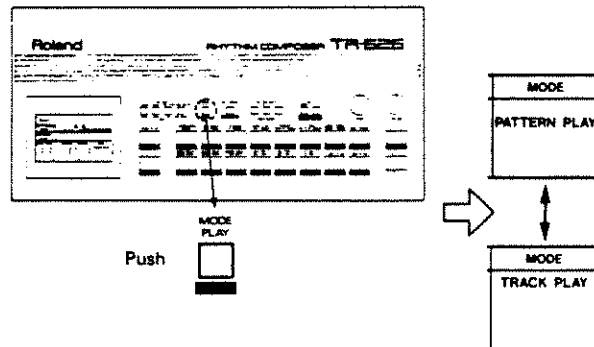

Ⓢ Writing mode (Track writing/Step writing/Tap writing)

Every time the Mode Key is pressed while the shift Key is being held down, the writing mode changes from one to another among these three.

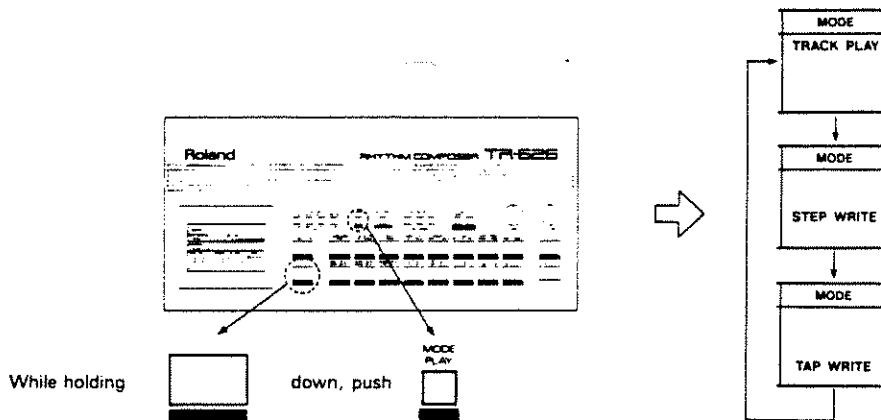

3. Playing and Writing Rhythm Patterns

First off, a bar or bars of rhythm pattern should be written. Although it is possible, of course, to write every rhythm originally, it is usually easier and simpler to combine basic patterns already stored in the TR- 626's memory. Preset and user-programmed patterns can be combined to make new patterns. The rhythm patterns are organized in six groups of A to F. There are sixteen rhythms memorized for each group.

		Pattern Number						
		1	2	3	...	14	15	16
Pattern Group	A	<div style="border: 1px solid black; padding: 5px; width: fit-content; margin: 0 auto;"> Preset Rhythm C-3 </div>						
	B							
	C							
	D	<div style="border: 1px solid black; padding: 5px; width: fit-content; margin: 0 auto;"> Original Rhythm F-3 </div>						
	E							
	F							

Preset rhythms, which cannot be rewritten, are stored in pattern groups A, B, and C. It is possible to alter the level and the pitch of each drum voice. Your own rhythm patterns can be written in pattern groups D, E and F.

a. Rhythm pattern playing

Refer to the Table of Preset Rhythms found on p.99 when selecting a preset rhythm pattern. The booklet "Preset Rhythm Scores" will also be helpful for this.

Step 1 Choose the pattern play mode by pressing the Mode Key.

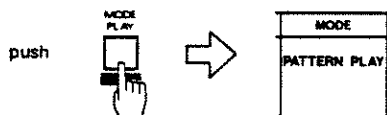

Step 2 Select the pattern group to play by pressing the Pattern Group Key.

Pushing the left button chooses A or D; pushing the center button chooses B or E; and pushing the right button chooses C or F. Pushing the left button alternates between A and D; pushing the center button alternates between B and E; pushing the right button alternates between C and F.

Step 3 Selecting the Pattern Number with the Main Keys (1 to 16)

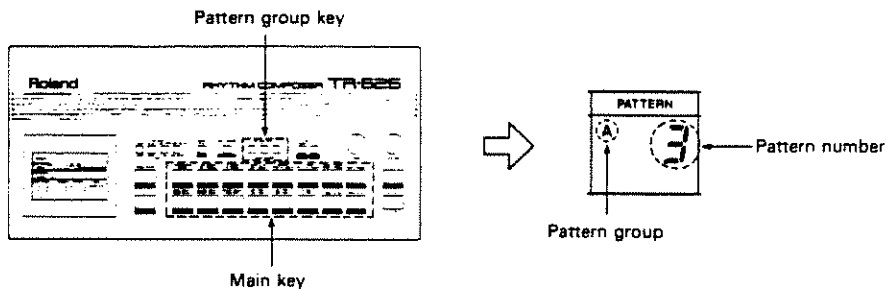

The Display gives the pattern group and the pattern number of the selected rhythm pattern.

Step 4 Press the Start/Stop Key.



The selected rhythm pattern will be played repeatedly.

***Even while playing, other rhythm patterns can be selected by following Steps 2 and 3. (A rhythm pattern correctly selected will be played starting from the beginning of the next bar.)**

Step 5 Push the Start/Stop button once again to stop playing the rhythm pattern.

b. Rhythm pattern writing

Pattern groups D, E, and F can be rewritten.

Sixteen different rhythm patterns can be written into each pattern group.

Thus, it is possible to write 48 original rhythm patterns.

Writing a single bar of a rhythm is called pattern writing. There are two methods of pattern writing. Step writing and Tap writing. Step writing sets the time for the drum voices with the 16 Main Keys. It is useful when writing rhythms for a score or just for a complicated composition. Tap writing is simpler, the composer simply taps the rhythm on the Main keys to the metronome.

The following discussion assumes that a 4/4 beat is used. For explanations of writing different rhythm patterns at other beats, please refer to the next section on Applications on p.42.

■ Tap Writing

Rhythm patterns written manually to a metronome.

- Step 1 Make sure that the TR-626 is not playing.
- Step 2 Enter the Tap Writing mode by pressing the Mode Key several times while holding the Shift Key down.



- Step 3 With the Pattern Group Key select the D, E, and F pattern group.



*A, B, and C pattern group should not be selected.

Step 4 While holding the Pattern Clear Key down, push the Main Key (1 to 16) for the pattern number whose previously written rhythm patterns you would like to erase and gain access to their, now open, memory space.

(When Pattern No. 1 should be selected)

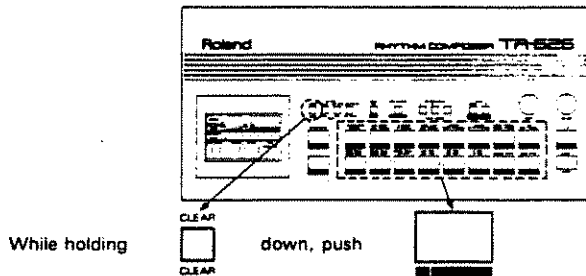

If you would like access to the previous pattern, to modify it in some manner, and not to erase it, simply press the relevant Main Key and do not press the Pattern Clear Key.

Step 5 Allocate the drum voices, if any, which you would like to program with the Main Keys (1 to 14). (See p.11.)

Step 6 Push the Start/Stop Key to begin playing.

The Tempo Indicator will flash, the metronome (RIM SHOT) will sound at every beat, and the head of each bar will be accented. If the metronome does not make any sound, press the Instrument / Metronome Key.

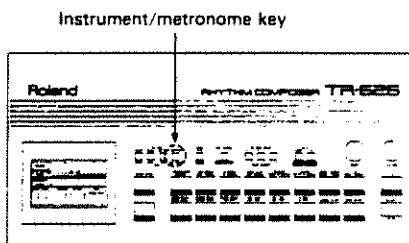

Pushing the Instrument / Metronome Key again will make the metronome stop.

(Manual playing)

① While holding the Shift Key down, push the Manual Play Key.

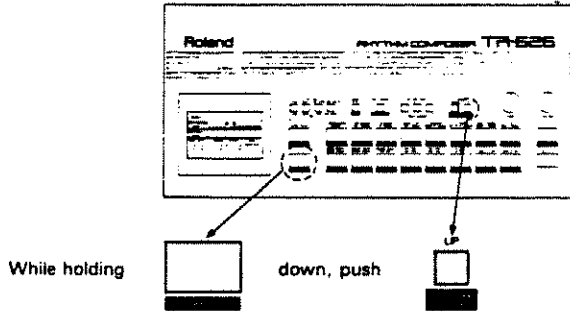

② Tapping the Main Keys (1 to 16) will make the drum voices assigned to the keys sound. You can tap the keys as a test to check the sound before writing a pattern to memory.

③ It is impossible at this time to write a played rhythm pattern to memory until you pushing the Manual Play Key while holding the Shift Key down.

Step 7

When the Main Keys (1 to 16) are tapped, the drum voices allocated to them will emit sound and be written into the rhythm pattern according to the time at which they are tapped. Push the Main Keys (1 to 16) which you would like to work with, and keeping time with the metronome, write your rhythm pattern. Play this repeatedly until you have written a bar.

* The written rhythm patterns can be erased by pressing the Main Key while holding the Pattern Clear Key down.

(When the rhythm pattern written with the drum voice allocated to Main Key 10 should be erased)

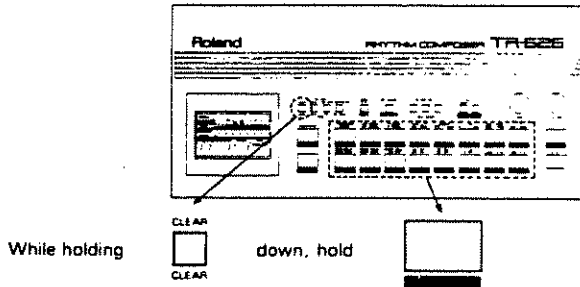

Next, program accented drum voices. If this is not desired, skip the following Steps and proceed to Step 12.

Step 8 Push the Accent Key.

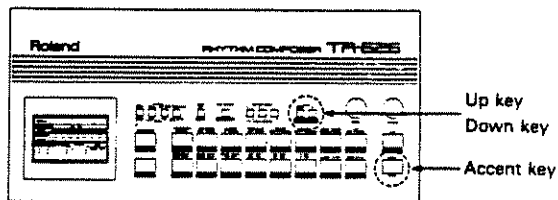

The Display gives the current accent level.

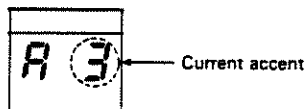

Step 9 Set the accent level higher or lower with the down and the up Keys.

Press up Key ... Accent is intensified

Press down Key ... Accent is reduced

The accent can be assigned between -3 to +3. In ordinary tap writing, is done at 0 accent level.

Step 10 Push the Main Keys of the drum voice which you would like to accent. The accented sound will be programmed in time with the metronome.

Repeat Steps 9 and 10 as often as desired to add accents where and how you wish.

Step 11 Push the Accent Key again to return to ordinary tap writing mode.

Step 12 After finishing writing, push the Start/Stop Key to stop playing the TR-626.

*Tap Written sounds are automatically set to the timing that is programmed into the machine. The TR-626 is programmed to a sixteen note timing interval. Any note written out of timing will be automatically rewritten to the closest sixteenth note. (Refer to p.43 for an explanation of setting timing.)

*To see the display of a drum voice rhythm pattern that has been written to memory, push the Instrument/Metronome Key, and without releasing it, push the Main Keys. In this way, the Step where the drum voice is written is verified.

(Indication of the rhythm pattern of the drum voice allocated to Main Key 9)

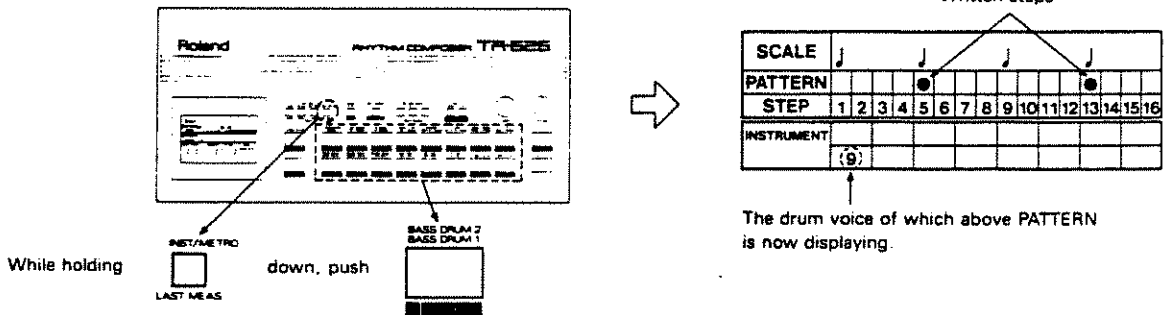

*Do not write the drum voices that belongs to the same voice group into the same Step. (See page 9.)

*If the drum voice of the same group is written into the same Step, the later voice will take over the precedence and the first will be erased.

■ Step Writing

In Step Writing, we write the timing value for each of the drum voices with the 16 Main Keys. We use this method mainly to write rhythm patterns for musical notes.

*With the TR-626, the rhythm and the beat of a musical note is expressed as shown below.

The image shows three musical staves with rhythmic patterns and corresponding step writing tables. Each table has a 'SCALE' row with a treble clef and a 'STEP' row with 16 numbered boxes.

CLOSED HI-HAT		⇒	<table border="1"> <tr><td>SCALE</td><td></td></tr> <tr><td>PATTERN</td><td>● ● ● ● ● ● ● ● ● ● ● ● ● ● ● ●</td></tr> <tr><td>STEP</td><td>1 2 3 4 5 6 7 8 9 10 11 12 13 14 15 16</td></tr> </table>	SCALE		PATTERN	● ● ● ● ● ● ● ● ● ● ● ● ● ● ● ●	STEP	1 2 3 4 5 6 7 8 9 10 11 12 13 14 15 16
SCALE									
PATTERN	● ● ● ● ● ● ● ● ● ● ● ● ● ● ● ●								
STEP	1 2 3 4 5 6 7 8 9 10 11 12 13 14 15 16								
SNARE DRUM 1		⇒	<table border="1"> <tr><td>SCALE</td><td></td></tr> <tr><td>PATTERN</td><td>● ● ● ● ● ● ● ● ● ● ● ● ● ● ● ●</td></tr> <tr><td>STEP</td><td>1 2 3 4 5 6 7 8 9 10 11 12 13 14 15 16</td></tr> </table>	SCALE		PATTERN	● ● ● ● ● ● ● ● ● ● ● ● ● ● ● ●	STEP	1 2 3 4 5 6 7 8 9 10 11 12 13 14 15 16
SCALE									
PATTERN	● ● ● ● ● ● ● ● ● ● ● ● ● ● ● ●								
STEP	1 2 3 4 5 6 7 8 9 10 11 12 13 14 15 16								
BASS DRUM 1		⇒	<table border="1"> <tr><td>SCALE</td><td></td></tr> <tr><td>PATTERN</td><td>● ● ● ● ● ● ● ● ● ● ● ● ● ● ● ●</td></tr> <tr><td>STEP</td><td>1 2 3 4 5 6 7 8 9 10 11 12 13 14 15 16</td></tr> </table>	SCALE		PATTERN	● ● ● ● ● ● ● ● ● ● ● ● ● ● ● ●	STEP	1 2 3 4 5 6 7 8 9 10 11 12 13 14 15 16
SCALE									
PATTERN	● ● ● ● ● ● ● ● ● ● ● ● ● ● ● ●								
STEP	1 2 3 4 5 6 7 8 9 10 11 12 13 14 15 16								

Follow Steps 1 to 4 as in Tap Writing, (except that Step Write mode should be selected in Step 2) then :



- Step 5 Press the Start/Stop Key to begin playing.
- Step 6 Allocate the drum voices to be written into the Main Key (1 to 14). (See p.11.)
- Step 7 Press the Main Key (1 to 16) while holding the Instrument/Metronome Key down, choosing which drum voice to be written.

(When OPEN HI-HAT should be selected)

The diagram shows the Roland TR-626 control panel. Two keys are highlighted with arrows: 'INST/METRO' and 'OPEN HI-HAT'. Below the panel, a legend indicates: 'While holding' followed by a square icon, 'down, push' followed by another square icon.

The Main Keys (1 to 16) function here as keys for designating the Step of a rhythm pattern.

Step 8

While looking at the display, press the Main Key (1 to 16) that now designate the Step number at which you want the drum voice to sound.

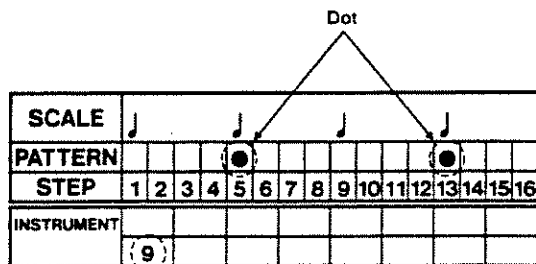

A dot (●) in the Display indicates the designated Step.

*Pushing the same key again cancels this designation.

Repeat Steps 6 through 8 as many times as desired to program other drum voices.

To accent drum voices carry out Steps 9 to 13. If this is not desired, skip the following Steps and proceed to Step 14.

Step 9

Push the Accent Key.

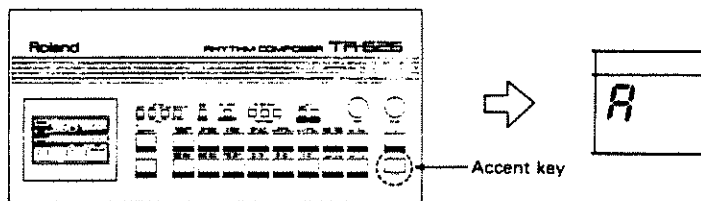

Step 10 Press the Main Key while holding Instrument/Metronome Key down to select the drum voice where you would like to write accent.

Step 11 Press the Main Keys (1 to 16) for the Steps to be accented. The numbers in the Display of the Steps designated by the Main Key will flash and their currently set accent level will be displayed. In ordinary Step Writing the accent is set at 0.

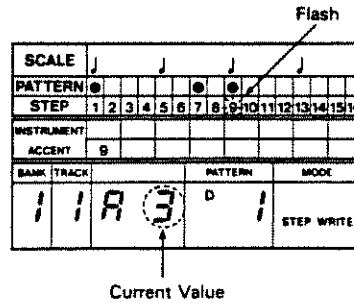

*If no drum voice is assigned to the Steps designated in Step 11 the following will be displayed to show that no accents have been assigned.

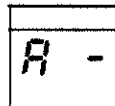

Step 12 Set the accent level higher or lower with the down and the up Keys.

The accent can be assigned between -3 to +3.

Repeat Steps 10 to 12 as often as desired to add accents to whatever drum voices you would like.

Step 13 Push the Accent Key again to return to ordinary step writing mode.

Step 14 After finishing writing, push the Start/Stop Key to stop the TR-626 playing.

*Do not program the drum voices which belong to the same voice group (see p.9) into the same step.

While playing a rhythm pattern, you can change from Step Writing to Tap Writing or vice versa, by simply pressing Mode Key. So, if you make mistakes in Tapwriting, you can change to the Step write mode and correct the mistakes. Also, you can change to the Tap Write mode to add more voice to the rhythm written in the Step write mode.

4. Track Writing and Playing

A track is the combination of various rhythm patterns written in bars that ultimately make a tune.

With the TR-626, 6 tracks, roughly equivalent to about 6 tunes, can be written.

a. Track writing

Step 1 Push the Mode Key to put the TR-626 into track play mode.

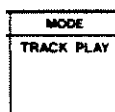

Step 2 Push the Track Number Key to choose the track (1 to 6) which you would like to use.

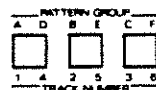

- Pushing the left button chooses 1 and 4; pushing the center button chooses 2 and 5, and pushing the right button chooses 3 and 6.
- Pushing each of these buttons again will alternate between the two tracks: that is between 1 and 4, 2 and 5, and 3 and 6.

The Display will give the number of the track that has been selected.

(When track 1 was selected)

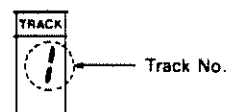

Step 3 Enter track writing mode by pressing the Mode Key while holding the Shift Key down.



*Once a track has been chosen, it cannot be changed in the Track Write mode.

Step 4 To erase data previously written on a track, push the Enter Key while holding the Track Clear Key down.

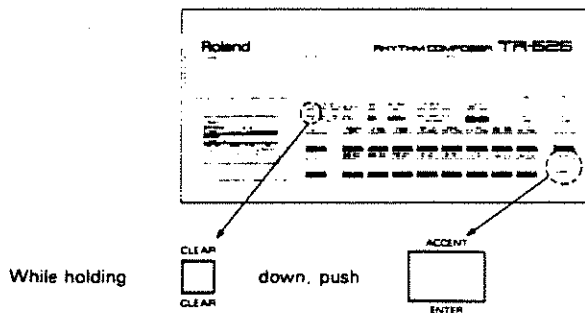

Step 5 If you would like to hear a rhythm pattern as you are writing in a track, push the Start/Stop Key.

The rhythm pattern will be played repeatedly.

Step 6 Choose the pattern group and the pattern number of the rhythm pattern which you would like to write (into the 1st bar) using the Pattern Group Key (A to F) and the Main Keys (1 to 16).

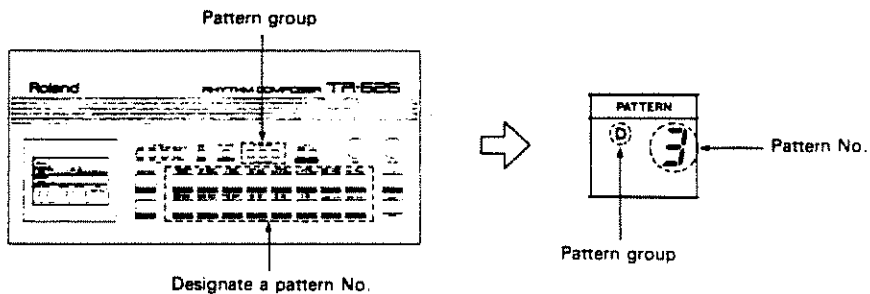

The Display gives the pattern group and number chosen.

Step 7 Push the Enter Key.



The designated rhythm pattern is written into the 1st bar. The bar in the Display changes to 2.

Repeat steps 6 and 7 for every bar you want to write.

To play the track that has just been written follow the instructions in "b. Track playing" on page 41.

*There are 999 bars that can be written in the 6 tracks. When the following message appears while writing tracks all 999 bars have been used. In order to write more new bars, it is necessary to erase some of the other tracks.

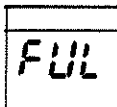

*In track playing, one track is played repeatedly. If you want the track to end after playing once, you must write several empty bars after the final bar. Then, while the empty bars are being played, push the Start / Stop Key.

●When an incorrect rhythm pattern is written in a track in steps 6 and 7, it can be corrected as follows :

- Step 1 When the rhythm patterns are being played, press the Start/Stop Key to stop the unit.
- Step 2 Find the incorrect bar (s) in the Display with the Measure Back Key and the Measure Forward Key.

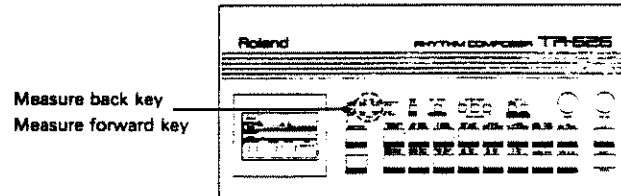

Measure Back Key ... Goes one bar backward

Measure Forward Key ... Goes one bar forward

- Step 3 Select the correct rhythm pattern, then press the Enter Key.

*To insert a new pattern between already written pattern, or to delete a pattern, please refer to p.54-57 in the section on Applications.

● Example of track writing :

The best way to learn how to write rhythm patterns from musical notes into a track is to work through an example.

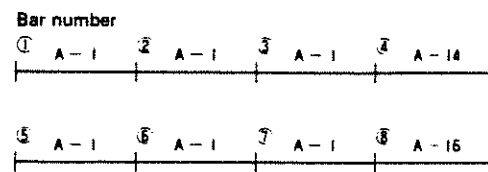

Execute steps 1 to 5 of "a. Track writing" on page 35 then do the procedures shown on the next page :

Step 1 In the music note example the first bar is A-1 so push Pattern Group Key A, then Main Key 1, and then the Enter Key. Be sure to follow this order. Then program pattern A-1.

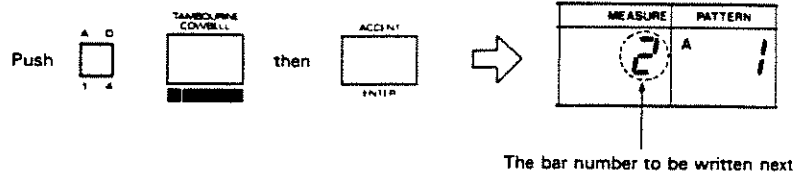

Step 2 The second bar is also A-1, the same as the first, so push the Enter Key only.



Step 3 The third bar is also A-1, so push the Enter Key again.

Step 4 The fourth bar is A-14, so push Main Key 14, then the Enter Key.

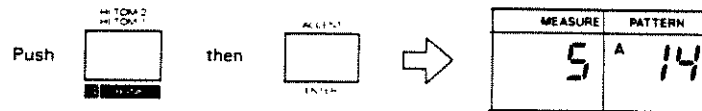

Step 5 Continue in the same manner to write the 5th to the 8th bars.

To play the track just written carry out the instructions found in "b. Track Playing" given on the next page.

b. Track playing

Now, we shall play the complete tune made up of rhythm patterns that were created by track writing.

- Step 1** Press the Mode Key several times until the TR-626 is in Track Playing mode.



- Step 2** Press the Track Number Key to select the track desired (1 to 6).



The Display gives the number of the selected track.

(When Track 2 is selected)

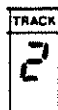

- Step 3** Push the Start/Stop Key to begin playing the chosen track.

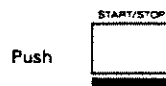

After the last bar has been played, it will automatically be reset to the first bar and the pattern will be repeated.

- Step 4** Press the Start/Stop Key to stop playing the track.

2 Applications

The following functions will allow you to more effectively and easily write and play complicated rhythm patterns.

1. Functions to use while pattern writing

These functions are usable when either tap or step writing rhythm patterns.

a. Copying Rhythm Patterns

User-programmed and preset rhythm patterns can be copied onto another pattern number. When there is an old rhythm pattern that is similar to one that you would like to have it is often quicker and easier to copy and then modify the old pattern.

- Step 1** Check that the TR-626 is not playing.
- Step 2** Decide where you want the old pattern copied to and then select this pattern with the Pattern Group Keys (D, E, and F) and the Main Keys (1 to 16).
- Step 3** Press and hold the Shift Key while all of the following instructions are carried out in the order written here: press the Copy Key (Main Key 11), then press the Pattern Group Key of the rhythm pattern that you would like to copy, then press the pattern number (Main Key 1 to 16), and lastly push the Enter Key.

*Chained rhythm patterns (see p.47) cannot to be copied. Only the pattern of the pressed Main Key can be copied.

Examples of copying operation

(Copying preset rhythm A-5 to D-1)

(1) Designation of the pattern group and No. for the copy receiving side

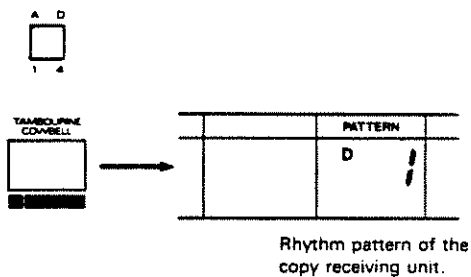

(2) Copying operation

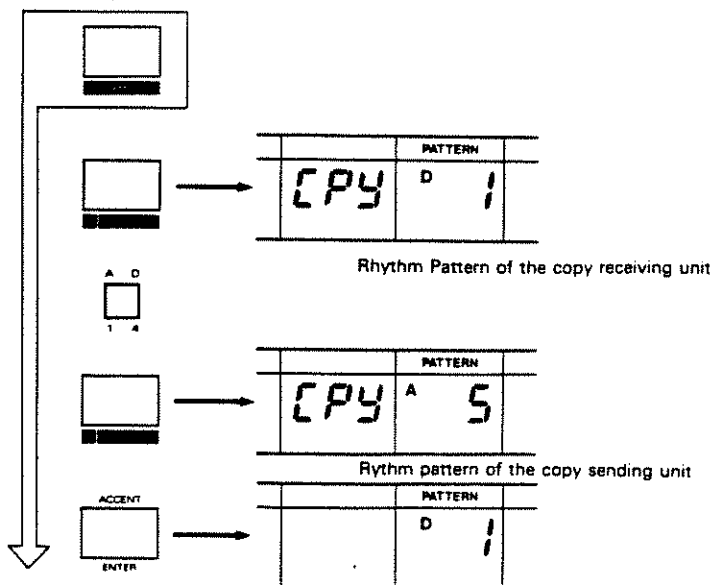









b. Setting the scale and last step

The default setting is 4/4 time, that is sixteen notes per step. Therefore to program any other beat, it is necessary to reset the type of note per step (scale) and the number of steps, that is which will be the last step, for each pattern in order to write at 3/4 time or thirty-two notes per step or where triplet notes or other different rhythms are required.

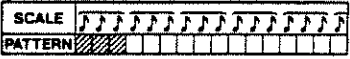
● Setting the scale (minimum note)

One of the following four scales can be selected for each pattern :

	<p>Sixteenth notes per step </p>
	<p>Thirty-second notes per step </p>
	<p>Triplet per step </p>
	<p>Sextuplet per step </p>

 = ♩ is equivalent to a quarter note

- Step 1** Check that the TR-626 is not playing.
- Step 2** Select the pattern group and number whose scale you want to change with the Pattern Group Keys (D, E, and F) and the Main Keys (1 to 16).
- Step 3** While looking at the scale indication on the Display, push the Scale Key several times to set the scale.

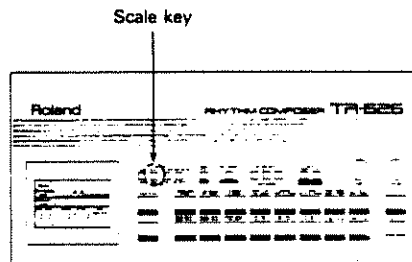

● **Setting the last step, that is to set the length of a bar**

The last step can be set for each pattern.

- Step 1** Check that the TR-626 is not playing.
- Step 2** Select the pattern group and number whose last step you would like to set with the Pattern Group Keys (D, E, and F) and the Main Keys (1 to 16).
- Step 3** While pressing the Last Step Key push the Main Keys (1 to 16) to set the step number.

(Setting the last step at 12)

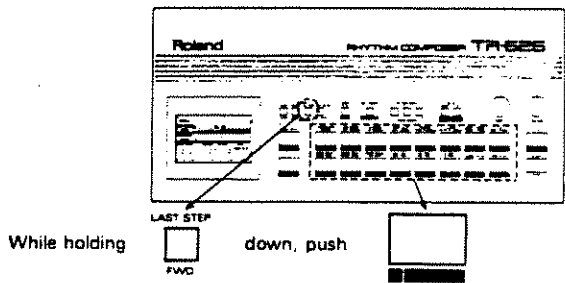

When writing a 3/4 time pattern on a sixteen note step, one bar has 12 steps.

(3/4 time)











Bass
DRUM 1

SNARE
DRUM 1











CLOSED
HI-HAT











Scale : 1 step = 

Last step : 12

SCALE															
PATTERN	●	●	●	●	●	●	●	●	●	●	●	●	●	●	●
STEP	1	2	3	4	5	6	7	8	9	10	11	12			

→

SCALE															
PATTERN	●	●	●	●	●	●	●	●	●	●	●	●	●	●	●
STEP	1	2	3	4	5	6	7	8	9	10	11	12			

SCALE															
PATTERN	●	●	●	●	●	●	●	●	●	●	●	●	●	●	●
STEP	1	2	3	4	5	6	7	8	9	10	11	12			

In a scale of eighth note triplets per step, three steps makes a beat. therefore a rhythm pattern at a 4/4 beat has 12 steps.



(4/4 time using triplets)



BASS DRUM 1

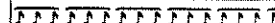

SNARE DRUM 1

CLOSED HI-HAT

Scale : 1 step = 
Last step : 12

SCALE	
PATTERN	
STEP	1 2 3 4 5 6 7 8 9 10 11 12

SCALE	
PATTERN	
STEP	1 2 3 4 5 6 7 8 9 10 11 12

SCALE	
PATTERN	
STEP	1 2 3 4 5 6 7 8 9 10 11 12



In a scale of thirty-two notes per step, 8 steps make a beat. Therefore, no more than two beats can be made with 16 steps. As a result of this, when a 4/4 time rhythm pattern is to be made, as in the figure, two patterns are used for writing it and then a single rhythm pattern is made by chaining them together. (See p.47.)

BASS DRUM 1



SNARE DRUM 1

CLOSED HI-HAT



Scale : 1 step = 
Last step : 16

SCALE	
PATTERN	
STEP	1 2 3 4 5 6 7 8 9 10 11 12 13 14 15 16

+

SCALE	
PATTERN	
STEP	1 2 3 4 5 6 7 8 9 10 11 12 13 14 15 16

+

SCALE	
PATTERN	
STEP	1 2 3 4 5 6 7 8 9 10 11 12 13 14 15 16

+

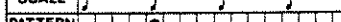
SCALE	
PATTERN	
STEP	1 2 3 4 5 6 7 8 9 10 11 12 13 14 15 16

A rhythm pattern like this is made by dividing it into three patterns and later changing them.

(When three patterns are necessary)

The diagram shows a musical staff with a sequence of notes: a quarter note, an eighth note, a quarter note, an eighth note, a quarter note, and an eighth note. An arrow points from this sequence to three tables, each representing a different pattern used to create the sequence.

SCALE	$\frac{1}{2}$	$\frac{1}{4}$	$\frac{1}{4}$	$\frac{1}{2}$	$\frac{1}{4}$	$\frac{1}{4}$	$\frac{1}{2}$	$\frac{1}{4}$	$\frac{1}{4}$	$\frac{1}{2}$	$\frac{1}{4}$	$\frac{1}{4}$	$\frac{1}{2}$
PATTERN	●		●		●	●							
STEP	1	2	3	4	5	6	7	8					

+

SCALE	$\frac{1}{2}$	$\frac{1}{4}$	$\frac{1}{4}$	$\frac{1}{2}$	$\frac{1}{4}$	$\frac{1}{4}$	$\frac{1}{2}$	$\frac{1}{4}$	$\frac{1}{4}$	$\frac{1}{2}$	$\frac{1}{4}$	$\frac{1}{4}$	$\frac{1}{2}$
PATTERN				●	●								
STEP	1	2	3	4	5	6							

+

SCALE	$\frac{1}{2}$	$\frac{1}{4}$	$\frac{1}{4}$	$\frac{1}{2}$	$\frac{1}{4}$	$\frac{1}{4}$	$\frac{1}{2}$	$\frac{1}{4}$	$\frac{1}{4}$	$\frac{1}{2}$	$\frac{1}{4}$	$\frac{1}{4}$	$\frac{1}{2}$
PATTERN	●	●	●										
STEP	1	2	3	4									

Scale : 1 step = $\frac{1}{2}$
Last step : 8

Scale : 1 step = $\frac{1}{4}$
Last step : 6

Scale : 1 step = $\frac{1}{2}$
Last step : 4

c. Chaining rhythm patterns

The chaining function permits two or more rhythm patterns to be chained together so that they are played as one pattern. This function is very useful when one step has thirty-two notes or when the rhythm is variable or unusual, such as in quintuple time. The chained patterns are treated as one bar in track writing.

- Step 1** Check that the TR-626 is not playing.
- Step 2** Select the pattern group that contains the rhythm patterns you would like to link with the Pattern Group Keys (D, E, and F).
- Step 3** While pressing the Main Keys (1 to 16) of the first and the last pattern number that you want to join together, push the Enter Key. Only patterns having adjacent numbers can be chained.

(Chaining pattern numbers 9, 10, 11, and 12)

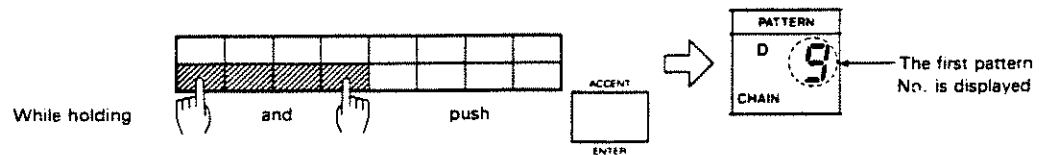

CHAIN will appear in the Display.

If you later want to break the chain, press the Enter Key while pressing the pattern number where you would like to separate the chain.

*After a chain is split, two smaller chains will be formed in each half, if there are two or more patterns in each resulting half. For example, if pattern numbers 1 to 5 were in a chain and the chain was separated at number 3, numbers 1 and 2, 4 and 5 would then be left in two small chains and number 3 would be independent of both of the new small chains.

d. Block writing

To write adjacent rhythm patterns as a block, press the Main Keys of the first and final pattern numbers of the rhythm patterns.

(Making a block of rhythm patterns 9 to 12)

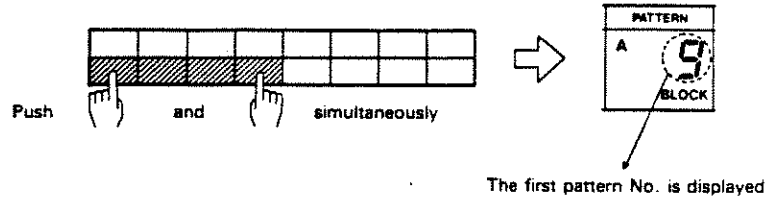

BLOCK will appear in the Display.

e. Flam

A flam sound is the one that results when two drum sticks are played with an interval, the first weakly and then the second stronger.

● Writing Flames

The flam effect can be added to nine drum voices.

They are: SNARE DRUMs 1, 2, and 3
 LOW TOMs 1 and 2
 MID TOMs 1 and 2
 HI TOMs 1 and 2

(In tap writing)

- Step 1 Check that the TR-626 is not playing.
- Step 2 Select the pattern group and number to which you would like to add the flam effect with the Pattern Group Keys (D, E, and F) and the Main Keys (1 to 16).
- Step 3 Push the Start/Stop Key to start playing the TR-626.
- Step 4 While pressing the Shift Key with the rhythm you want, push the Main Keys (9 to 13) for the drum voices you would like this to add flam.

The dots (●) on the steps to which you program the flam effect will flash.

(In step writing)

- Step 1 Check that the TR-626 is not playing.
- Step 2 Select the pattern group and number to which you would like to add the flam effect with the Pattern Group Keys (D, E, and F) and the Main Keys (1 to 16).
- Step 3 Push the Start/Stop Key to start playing the TR-626.
- Step 4 Allocate the drum voices to be written to the Main Key.(See page 11.)
- Step 5 While pressing the Instrument/Metronome Key, push the Main Keys for the drum voices to which you would like to add the flam effect.

Step 6 While holding the Shift Key down, push the Main Key (1 to 16) that corresponds to the step where the flam is to be written.

The dots (●) on the steps to which you program the flam effect will flash.

Do this again for every other step that you would like to add the flam effect.

Step 7 To write flams in other drum voices, repeat steps 4 to 6.

● **Setting Flam Intervals**

Flam intervals can be set at one of five positions, from 0 to 4, for each pattern.



Step 1 While pressing the Shift Key, push the Shuffle/Flam Key twice, so that FLAM appears in the Display. Each time the Shuffle/Flam Key is pressed the TR-626 alternates between SHUFFLE and FLAM in the Display.

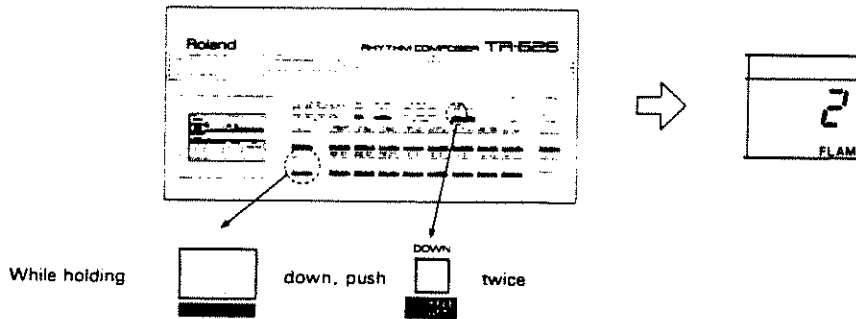

Currently set values appear in the Display.

Step 2 Keeping the Shift Key pressed, set the flam interval by pressing the Main Keys (9 to 13).

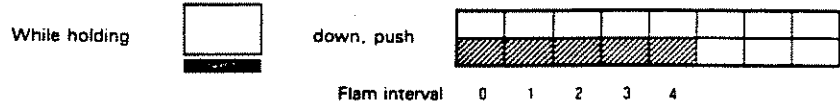

Higher values make longer intervals. (At "0", no flam effect is obtained.)

f. Shuffle

The shuffle effect adds a bounce, or lilt, that can be discerned in actual performance even if the intervals on the musical score are the same.

When shuffle is set to any value other than 0, the steps of even number will lag slightly, to creating this effect.

SCALE	♩	♩	♩	♩	♩	♩	♩	♩	♩	♩	♩	♩	♩	♩	♩
PATTERN	●	●			●	●									
STEP	1	2	3	4	5	6	7	8	9	10	11	12	13	14	15

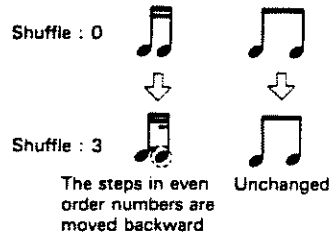

Step 1

While pressing the Shift Key, push the Shuffle/Flam Key once, so that SHUFFLE appears in the Display. Each time the Shuffle/Flam Key is pressed the TR-626 alternates between SHUFFLE and FLAM in the Display.

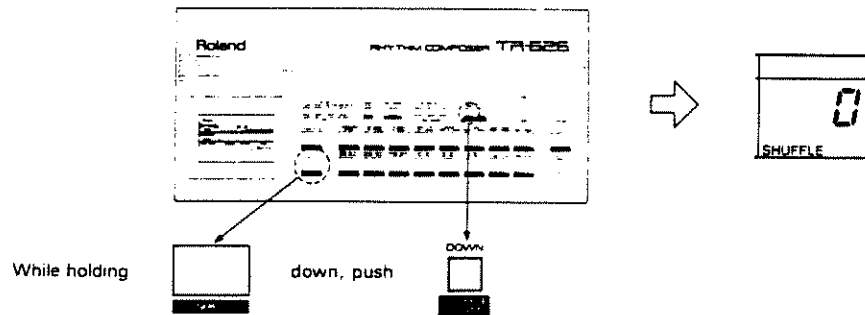

Currently set values appear in the Display.

Step 2 Without releasing the Shift Key, set the desired shuffle by pressing the Main Keys (9 to 13).

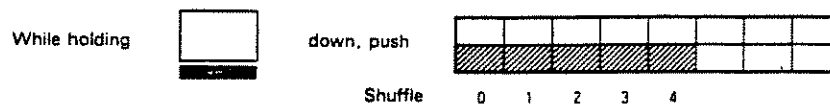

Shuffle can be set at one of five positions, from 0 to 4, for each pattern. The higher the value, the stronger the bounce. At 0, there is no effect.

*The shuffle effect cannot be added to triplet scales.

2. Functions to use while track writing

a. Delete

Any numbers of rhythm patterns written in tracks can be deleted at a time.

- Step 1** Call the first bar that you would like to delete. (See p.62.)
- Step 2** Press and hold the Shift Key while all of the following instructions are carried out in the order written here: press the Delete Key (Main Key 13), then assign the number (with the Main Keys 1 to 10) of the final bar to be deleted, and finally push the Enter Key.

*To delete to the last bar, push the Last Measure Key instead of specifying the number of the final bar.

*To delete a single bar only, press the Delete Key as in step 2 and then push the Enter Key.

Example of deleting operation

(Deleting the 21st to 24th bars)

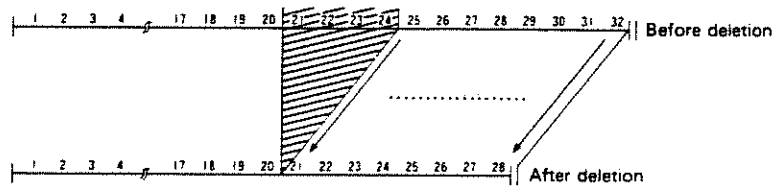

1 21st bar is called (Bar designation)

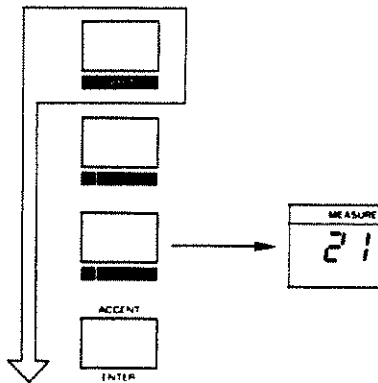

2 Deleting operation (deleting up to 24th bar)

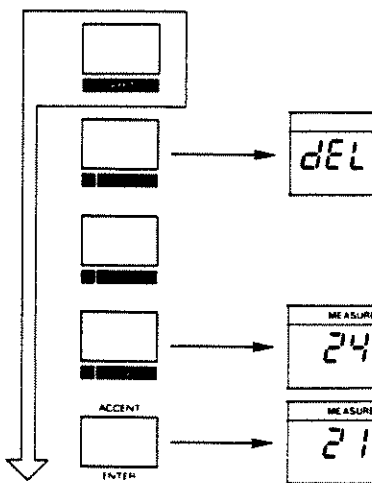

(When every bar from 25th bar onward are to be deleted)

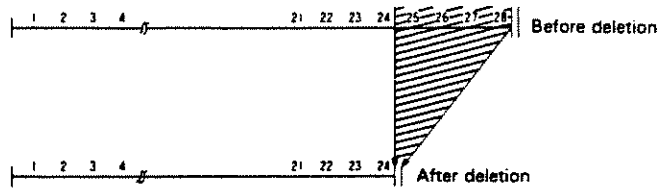

① Call 25th bar

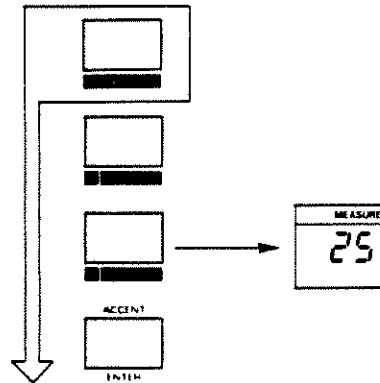

② Delete up to the final bar

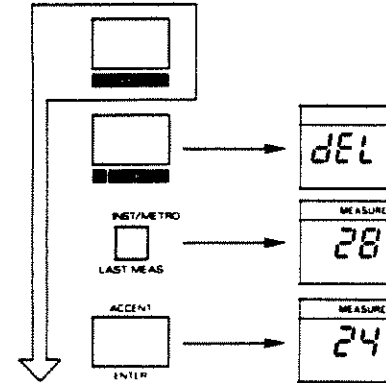

(To delete the 19th bar only)

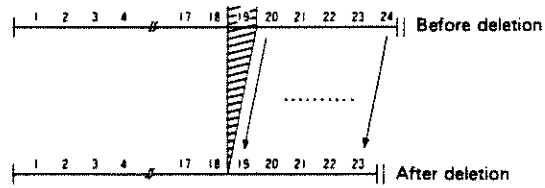

① Call the 19th bar

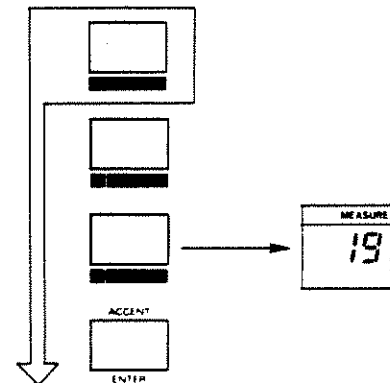

② Deleting operation

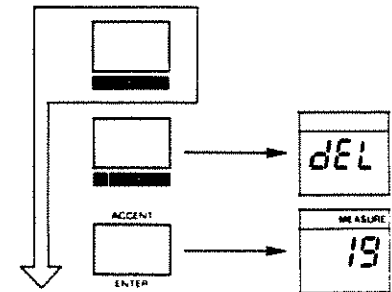

b. Insert

New rhythm patterns can be inserted into a track which already has rhythm patterns written on it.

- Step 1 Designate the bar into which you would like to insert the pattern. (See p.62.)
- Step 2 Select the rhythm pattern which you would like to insert using the Pattern Group Keys (A to F) and the Main Keys (1 to 16).
- Step 3 While pressing the Shift Key, push the Insert Key (Main Key 12) and then the Enter Key.

Example of inserting operation

(Inserting pattern A-1 into the third bar position)

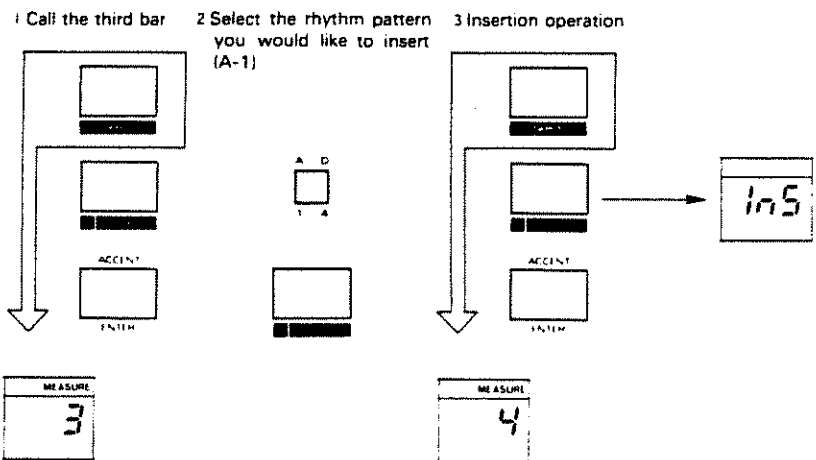
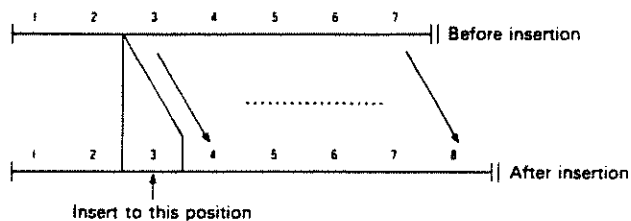

(Inserting pattern A-1 to A-4 into the third bar position)

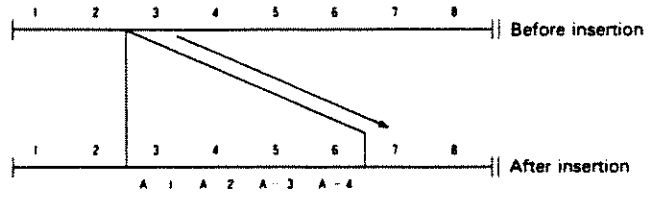

1 Call the third bar

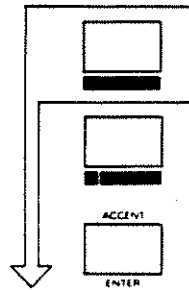

2 Select the rhythm pattern you would like to insert (A-1 to A-4)

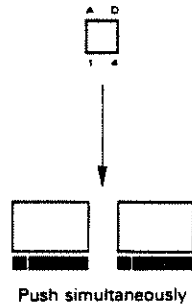

3 Inserting operation

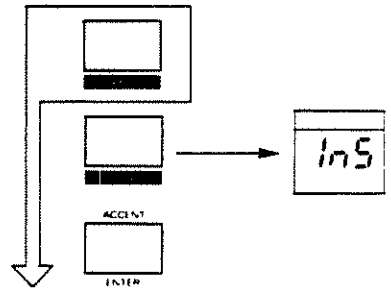

c. Copying bars

A string of bars which have already been written into a track can be copied onto another part of the same track. This is especially convenient when you would like to use an unbroken group of bars several times.

Step 1 Designate the number of the first bar to which you would like to insert the copy of the string. (See p.62)

Step 2 Press and hold the Shift Key while you carry out the following instructions in the following order: push the Copy Key (Main Key 11), the number of the first bar to be copied (with the Main Keys 1 to 10), the Enter Key, the number of the final bar to be copied (with the Main Keys 1 to 10), and then the Enter Key again.

*It is impossible to copy a string of bars to one of the bars within that string. For example, you cannot insert the 5th to 10th bars to a place beginning at the 9th bar.

*Do not copy bars from one track to another.

*When you attempt to copy incorrectly, the following appears in the Display:

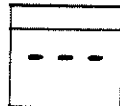

Copying operation examples

(When the contents of the 13th through 16th bars are to be copied to positions beginning with the 19th bar)

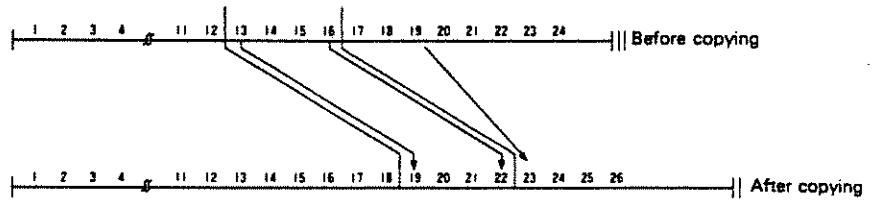

① Call the 19th bar

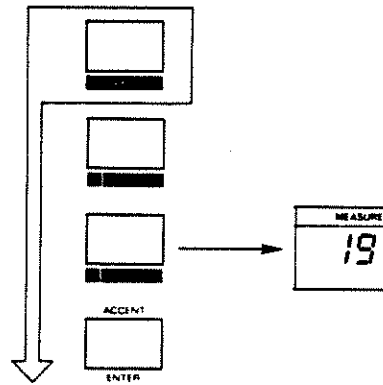

② Copying operation

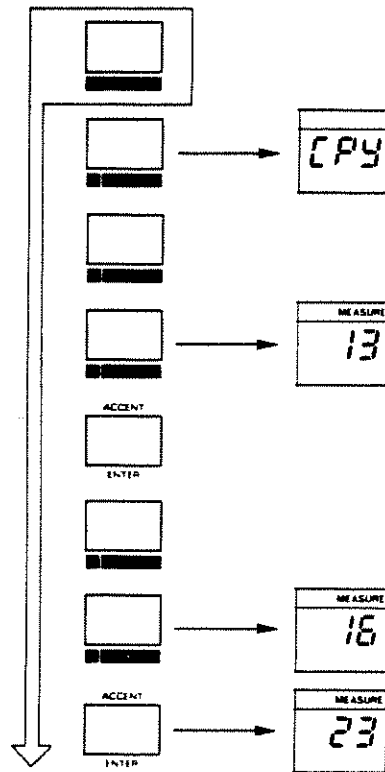

d. Block Writing

Within one pattern group a rhythm pattern having an unbroken string of pattern numbers can be programmed as a block.

When a rhythm pattern uses several bars frequently is written over an consecutive pattern numbers, it can be conveniently written in a block in track writing.

Step 1 When assigning pattern numbers for writing a rhythm pattern into tracks, push the first and final pattern numbers' Main Keys simultaneously that you would like to write in a block.

(When pattern numbers 9 through 12 are to be written in a block)

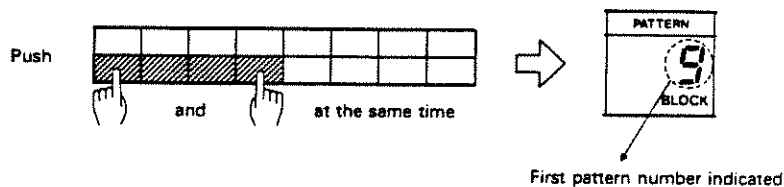

BLOCK will appear in the Display.

Step 2 Press the Enter Key and the rhythm pattern that has been written will be written at once.

e. Last Measure

When you would like to continue writing after the already written tracks, you may want to go directly to the youngest empty bar number. To do this push the Last Measure Key while the TR-626 is not playing.

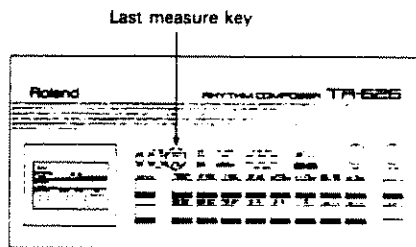

3. Functions to use while playing a track

These functions can be set when the rhythm is stopped in the Track Play mode.

a. Continue Start

When you would like to begin playing once more from the point at which you stopped earlier, push the Continue Start Key while holding the Shift Key down.



b. Continue Play

When you would like to begin playing from a point that you designate.

- Step 1 Designate the bar from which you would like to begin. (See next page.)
- Step 2 Push the Continue Start Key while holding the Shift Key down.

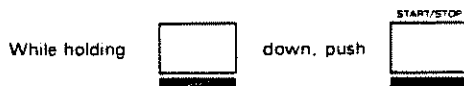

c. Last Measure

The last bar and its rhythm pattern of the currently chosen track will appear in the Display as long as the Last Measure Key is pressed.

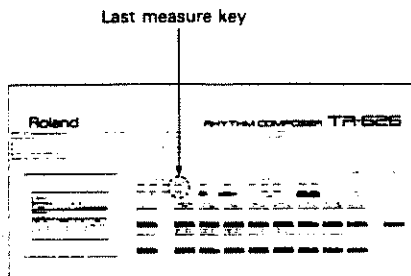

4. Miscellaneous Functions

a. Designating a bar number

When rhythm is stopped in play or in track writing mode, it is possible to designate the bar number of the track that is currently selected.

(1) If you would like to designate the number of several bars in order, use the Measure Forward and the Measure Back Keys.

Measure Back Key Each time the key is pressed, the bar number will decrease by one. (10, 9, 8, ...)

Measure Forward Key ... Each time the key is pressed, the bar number will increase by one. (1, 2, 3, ...)

(2) To designate a bar number directly, while pressing the Shift Key and designate the bar number with the Main Keys (1 to 10) and then push the Enter Key.

(When bar No. 15 is to be designated)

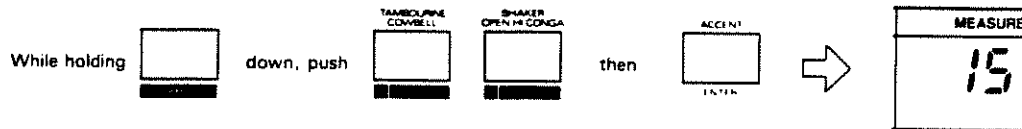

b. Block Play

In pattern play mode, rhythm patterns adjacent to each other within the same pattern group are played continuously. To designate pattern numbers, press two Main Keys, for the first and last pattern numbers which you would like to play in this way without a break.

(Making a block of rhythm patterns 9 to 12)

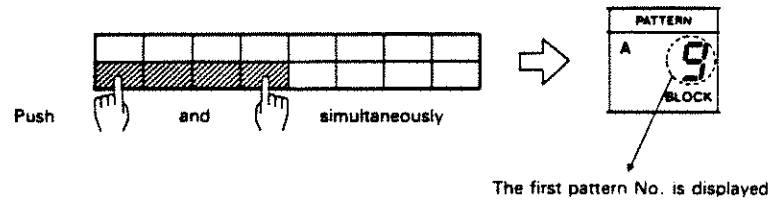

BLOCK appears in the display.

When the Start/Stop Key is pressed, the rhythm patterns designated as a block will play continuously, that is from start to end over and over.

3 Storing Rhythm Patterns in External Memory

Rhythm patterns and track data that have been written in the TR-626 can be stored externally in a memory card or an audio tape. Using a memory card is recommended for storing important data.

1. Memory Card

Please use our Memory Card M-128D, an option, for preserving TR-626 data.

***When using the Memory Card M-128D, read the instructions provided with it.**

***Please do not use any other manufacturer's memory card.**

A memory card has twice the memory capacity that the TR-626 itself has. We call the TR-626's memory Bank 1. Banks 2 and 3 are allocated to memory cards. Level and pitch for a drum voice can be independently set in each bank. The distribution of drum voices to the Main Keys and the MIDI setting functions are done in common for all the banks and memorized by the TR-626's memory.

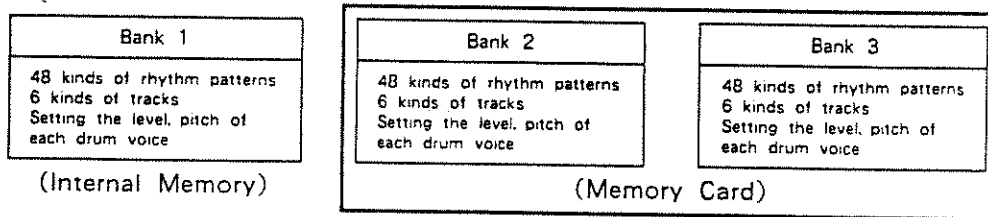

***Preset rhythm patterns (A, B, and C) are used in common by all the banks.**

When a new memory card is to be used for the first time, it must be formatted for the TR-626 before it can be used. (See p.67.) After it has been properly formatted, it can store rhythm and track patterns in exactly the same manner that the regular memory of the TR-626 does.

A memory card has a Protect Switch to protect stored data. Normally this switch should be set to ON. However, in order to store data with the memory card, or to change the pitch and level of drum voices the Protect Switch must be turned OFF before doing these operations. Turn a memory card's Protect Switch on and off in play mode.

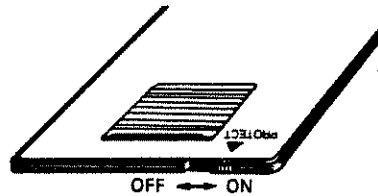

If you attempt to memorize data while the Protect Switch is on, the following will appear in the Display :

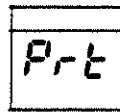

If you attempt to turn the Protect Switch ON in write mode, the TR-626 will stop and then go into play mode.

***Be especially careful when turning the Protect Switch ON. Bank track data will be damaged if the Protect Switch is turned on in track writing mode.**

Any operation done with a memory card should be done when the TR-626 is in track play mode and is stopped.

a. Changing banks

While pressing the Shift Key, press the Bank Key (Main Key 14) to change the bank.

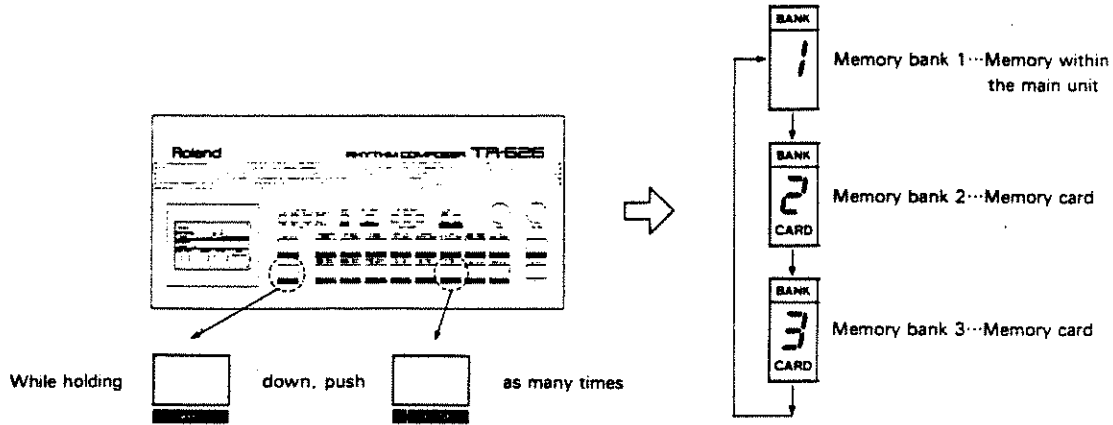

*If the memory card is not inserted properly all the way into its slot, the bank will not be changed and the following will appear in the Display :

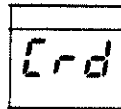

b. Formatting a memory card

When a new memory card is used for the first time, it must first be formatted for use with the TR-626.

- Step 1** Insert the new memory card into the memory card slot securely until it clicks.

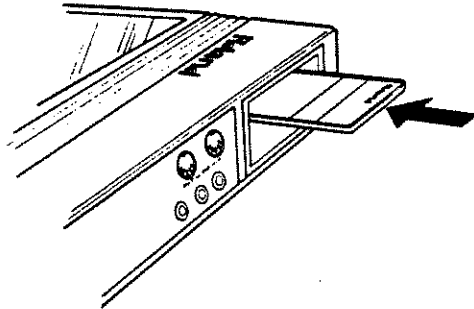

- Step 2** Turn the card's Protect Switch OFF. Change banks (See the previous page.) so that F appears in the Display.

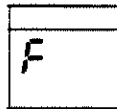

- Step 3** Push the Enter Key while holding the Track Clear Key down.

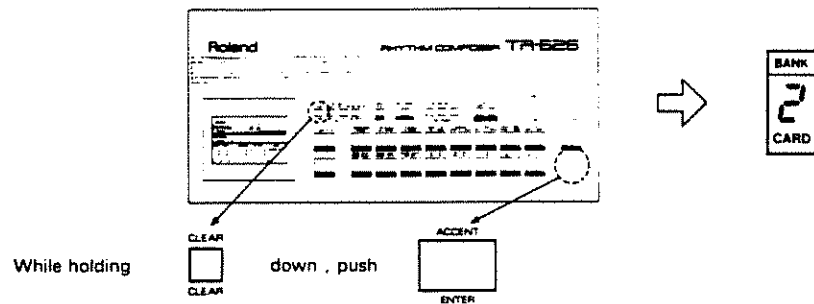

The card is now formatted. The bank will change to Bank 2.

*If the Protect Switch is left ON the card cannot be formatted.

c. Copying data between banks

Any data in one bank can be copied to another. Storing and moving data to and from Bank 1 to Banks 2 and 3 can be done easily. This method is quicker and more secure than working with audio tapes.

Data can also be copied between Banks 2 and 3.

- Step 1** Turn the Protect Switch OFF before copying data into a memory card.
- Step 2** While pressing the Shift Key, push the Bank Key (Main Key 14) to designate which bank will receive the data.
- Step 3** While pressing the Shift Key, push the Copy Key (Main Key 11), then push Main Key (1 to 3) to designate which bank will send the data, then push the Enter Key.

The data of the bank designated in step 3 will be copied onto the bank designated in step 2.

- Step 4** Turn the memory card's Protect Switch ON.

*New data copied onto a location in a bank that has old data will erase the old data.

*If you attempt to copy data onto a memory card whose Protect Switch is ON the following message will appear. The data should not be copied. Begin again after turning the Protect Switch OFF.

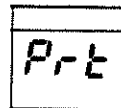

Data Copying between banks operation examples

(When copying the data of memory bank 1 into memory bank 2)

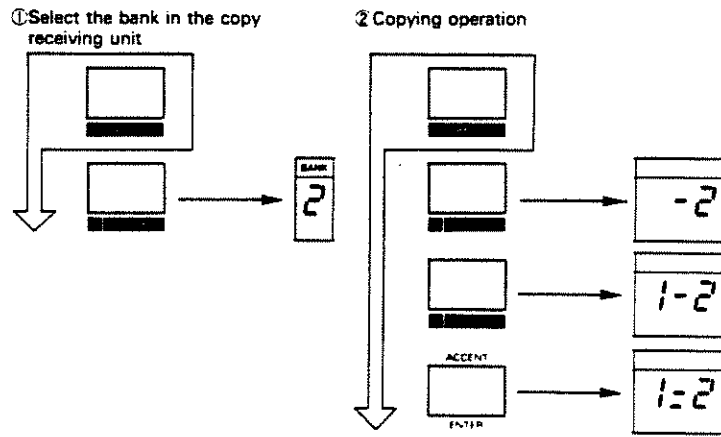

2. Tape memory

Data stored in the TR-626, that is in Bank 1, can be stored collectively on an audio tape.

Putting data from the TR-626 onto a tape is called "saving"; calling data from a tape to the TR-626 is called "loading"; and checking if data has been correctly saved is called "verification."

*Do this while the TR-626 is in track play mode in Bank 1 and is stopped.

*It should not be done in Banks 2 or 3.

a. Saving

- Step 1** Connect a tape recorder's microphone jack to the TR-626's Tape In /Out Jack found at the back of the TR-626 as shown in the figure.

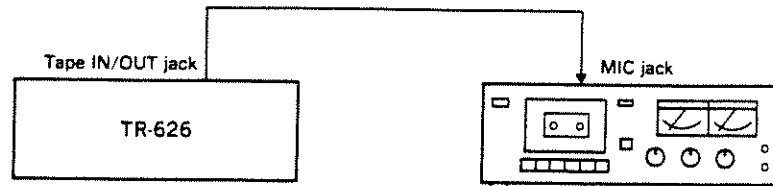

- Step 2** Start recording with the tape recorder.

Step 3 While pressing the Shift Key, push the Tape Key (Main Key 16), then push Main Key 1, check that "S" appears in the Display, and lastly push the Enter Key.

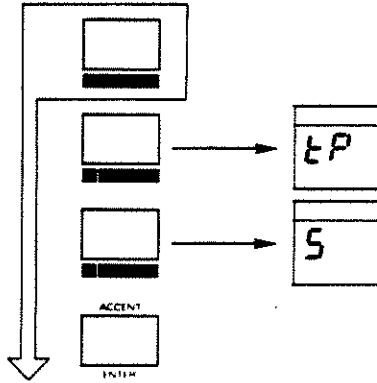

*Set the recording level at about +3 VU after Step 3 while a pilot tone is still being heard (for about five seconds).

After finishing saving, the TR-626 will go into track play mode.

*If you would like to suspend saving press Main Key 1.

*After finishing do not fail to verify that the data has been correctly copied.

b. Verification

- Step 1** **Connect the TR-626 to the tape recorder as shown in the figure. Do not change any of the TR-626 connections.**

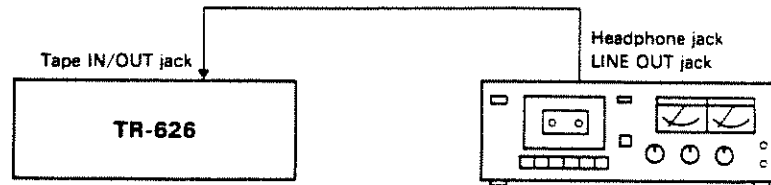

- Step 2** **Rewind the tape a up to the beginning of the data, where you will hear pilot tone.**
- Step 3** **Start playing the tape.**
- Step 4** **While pressing the Shift Key, push the Tape Key (Main Key 16), then push Main Key 2, check that "V" appears in the Display, and lastly push the Enter Key. Do this before a pilot tone changes to a modulated tone.**

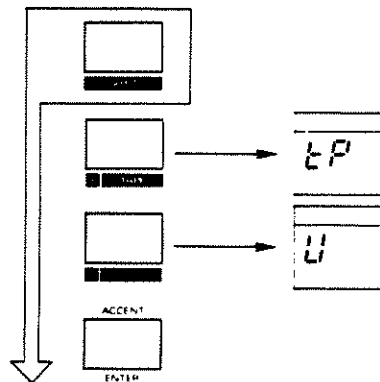

When the TR-626 is verifying, the tempo indicator will light. Data being input from the Tape In/Out Jack and the original data in Bank 1 are being compared.

When the data has been verified as having been correctly saved, the TR-626 will go into track play mode.

*If you would like to suspend verifying push Main Key 1.

*If the signal was not transmitted correctly from its beginning or if reading it becomes difficult at some point the following error message will appear :

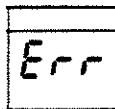

Errors occur largely as a result of two causes. One is that the volume is not set properly while verifying. In this case, simply stop the tape recorder, adjust the reproduction level, and start verifying once more from the beginning. If it has a tone control, adjust this also if it seems appropriate to do so. The second cause is that the data was not recorded properly. In this case, adjust the recording level and save the data from the beginning, that is, start over completely. If an error message is still indicated after the above procedure, try again using a different tape recorder.

c. Loading

- Step 1 Make the same connections that are required for verifying.
- Step 2 Find the position on the tape to start from by listening to the "pee" sound in the same way as it was done for verifying.
- Step 3 Start playing the tape.
- Step 4 While pressing the Shift Key, push the Tape Key (Main Key 16), then push Main Key 3, check that "L" appears in the Display, and finally push the Enter Key. Do this before a pilot tone changes to a modulated tone.

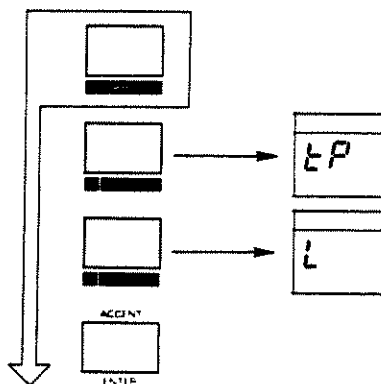

When the TR-626 is loading from the tape, the Tempo Indicator will light.

When the data has been loaded correctly, the TR-626 will go into track play mode.

*If you would like to suspend loading, push Main Key 1.

*Please try to always save and load as much as possible using the same tape recorder.

4 Other Useful Functions

a. Multi-out Jack

The TR-626 is equipped, in addition to its stereo output jacks, with eight multi-out jacks that are for the drum voices. Each drum voice can be output individually through sound effect machines such as echo machines.

The following drum voices are assigned to each multi-out jack.

MULTI OUT JACK	OUTPUT VOICE
BASS DRUM	BASS DRUM 1/2
SNARE	SNARE DRUM 1/2/3 RIM SHOT
LOW TOM	LOW TOM 1/2
MID TOM	MID TOM 1/2
HI TOM	HI TOM 1/2
HI-HAT	CLOSED HI-HAT OPEN HI-HAT
CRASH	CRASH CYMBAL CHINA CYMBAL
RIDE	RIDE CYMBAL CUP

*A drum voice sound output through a multi-out jack cannot be output through a stereo output jack.

b. Trigger-out Jack

When a rim shot sound written in a pattern is generated, the trigger messages (+5 V approx. 18 ms) are output through Trigger-out Jack.

When trigger signals are used to control an external sound source (=trigger receiving device), that sound source can be added to the rhythm pattern.

c. Start/Stop with a Pedal Switch

The Start/Stop function can be controlled with an optional footswitch (DP-2, BOSS FS-5L, etc) by connecting it to the Start/Stop Jack on the rear panel.

***It works in every mode.**

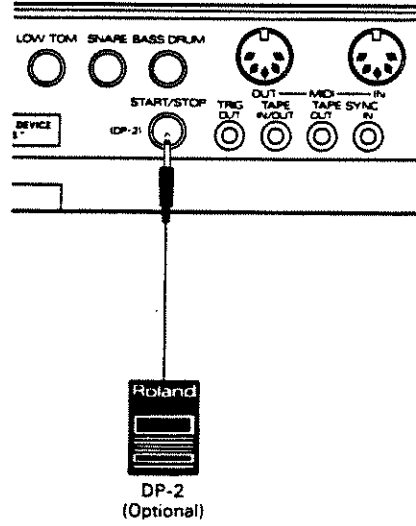

5 MIDI Function

*Please read the separate booklet "MIDI" for a full explanation of MIDI.

The TR-626 is equipped with a MIDI terminal (IN/OUT) to allow you to have a much more colorful play by connecting the TR-626 to other MIDI devices such as sequencers, keyboards, and the like. The transmission and reception of the following kinds of MIDI data is possible through the MIDI terminal:

- 1)Key information that corresponds to every sound source. It is data that is arranged so that the sound for each percussion instrument is set to the pitch of each key. (See p.80.)
- 2)Track Number (Song Select)
- 3)Bar Number (Song Position Pointer)
- 4)Synchronized signals for tempo clock, start/stop, etc.
- 5)Pattern Data, Track Data, Level/Pitch Data
(Via Exclusive messages)

1. Checking the MIDI Function

Check this function while the TR-626 is stopped in Track Play mode.

While pressing the Shift Key, push the SYNC/MIDI Key (Main Key 15) and then push the Enter Key repeatedly. Each time the Enter Key is pushed, the setting for each MIDI function will be shown in the display.

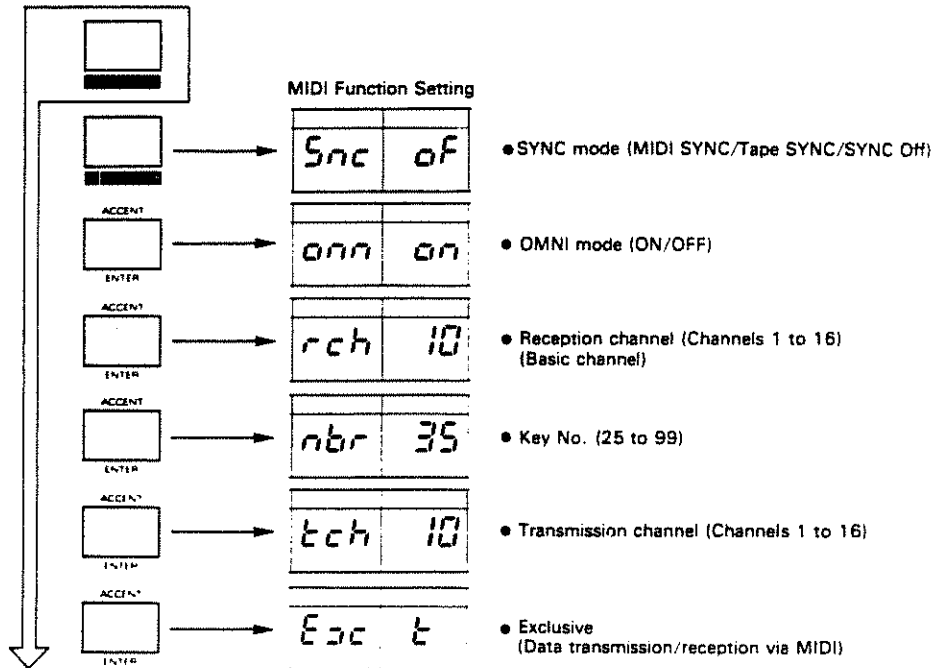

When you would like to change the setting of a particular MIDI function, first get the required MIDI function in the display, then change it while holding the Shift Key down.

*A new setting will be retained in memory even after turning the power off. It will be in force for every bank.

2. Altering a MIDI Function Setting

This section explains how to set the MIDI function for the most commonly used connections.

a. When the TR-626 is to be used as a MIDI sound source

The drum voices of the TR-626 can be made to emit sound when rhythm pattern playing data is supplied from external devices, such as other rhythm machines, keyboards, sequencers, etc., that have MIDI terminals. In an instance such as this the rhythm pattern playing data does not need to be written into the TR-626's memory.

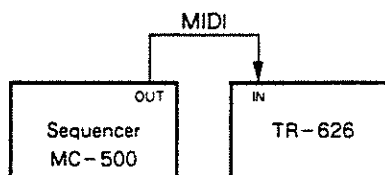

Step 1 Change either the transmitter's transmission channel or the TR-626's reception channel to set them to the same MIDI channel. (Refer to "o Altering the reception channel" on p.83.)

*If only one receiving MIDI device is used, step 1 can be dispensed with. Simply turn the OMNI mode on, instead of off, in step 2.

*Changing the transmission channel of the transmitter (s) should be done strictly in accordance with the instructions in the operation manual for the transmitter (s).

(Transmission/Reception Channel)

There are 16 MIDI channels. The transmission channel, the channel for transmitting playing information, can be designated as any of Channels 1 to 16. Since this is so, when information about several channels is sent through a single MIDI cable, playing information sent will be received only by the reception channel designated to accept it.

Step 2 Turn the TR-626's OMNI mode off. (See "Altering OMNI mode" on p.83.)

(OMNI Mode)

When OMNI mode is turned off, only the information sent on the reception channel will be received out of information sent on several channels. When OMNI ON is selected, information sent on all the reception channels will be received no matter what channel may be set.

Step 3 Set the Key Number (=Note Number) of each drum voice of the TR-626 to the corresponding sound sources of the transmitter (s). (See "Altering the Key Number of each drum voice" on p.84.)

(Key Number)

Key Numbers can be set to control the generation of sound for every drum voice of the TR-626.

From the manufacturer, the Key Numbers were set as follows :

	(37)	(39)		(42)	(44)	(46)		(49)	(51)		(54)	(56)	(58)		(61)	(63)		(66)	(68)	(70)		(73)	(75)
	RIM	HCP		CHH		OHH		CCY	RCY		TAMB	CB	SD3			OHCG		LTB	LAG				CLAVES
(35)	(36)	(38)	(40)	(41)	(43)	(45)	(47)	(48)	(50)	(52)	(53)	(55)	(57)	(59)	(60)	(62)	(64)	(65)	(67)	(69)	(71)	(72)	(74)
BD1	BD2	SD1	SD2	LT1	LT2	MT1	MT2	HT1	HT2	CHINA	CUP				MHCG	LCG	HTB	HAG	SWER				

Middle C

* Each drum voice uses abbreviation e.g. BD for bass drum. (See page 9.)

Step 4 Starting the transmitter will make the TR-626 play in accordance with the transmitted playing information.

* Turn the SYNC mode off in order to transmit playing data from a sequencer or other rhythm machines. If playing data has already been written into a track designated by the TR-626, and if the transmitter begins playing the TR-626 in MIDI SYNC mode, the TR-626's rhythm pattern will be output in addition to the transmitter's rhythm pattern.

The transmitter's playing data

(When data comes from a sequencer)

The TR-626's rhythm patterns and score data written into a sequencer correspond as shown below. Key Numbers for every sound source were set as set from the factory. (See the previous page.)

(Instrument)	(Key number)		(Score)
BASS DRUM 1	35	●	→ 8Va
SNARE DRUM 1	38	●	→ 8Va
CLOSED HI-HAT	42	●	→ 8Va
OPEN HI-HAT	46	●	→ 8Va

*The intensity of each accent is determined by the velocity of Note Event in MIDI messages.

By writing a score as directed by the operating method recommended by each sequencer manufacturer you can make the TR-626 play according to that score.

(When data comes from other rhythm machines)

First write the rhythm pattern into the transmitter's memory that you would like to make the TR-626 play and then set the transmitter's sound source key numbers to the drum voice key numbers of the TR-626 that you want to output the transmitter's rhythm pattern.

*The sound volume for each drum voice of the TR-626 will be determined by velocity of Note Event in MIDI messages. Levels set in the TR-626's Bank will be ignored. Note that any sound source whose level is set at 0 will not emit any sound even if received by MIDI.

■ Altering the reception channel (Basic Channel) 1 to 16.

- Step 1** Check the MIDI function as explained in "Checking the MIDI function" on p.78 and have the display indicate the reception channel setting.

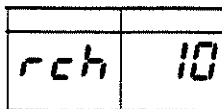

- Step 2** Push the Up Key when you would like a higher channel than the one currently set. Push the Down Key when you would like a lower channel.

The channel chosen can be any between Channels 1 to 16.

■ Altering OMNI mode (ON/OFF)

- Step 1** Check the MIDI function as explained in "Checking the MIDI function" on p.78 and have the display indicate whether the OMNI mode is on or off.

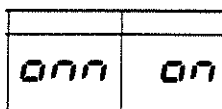

- Step 2** Push the Up Key to turn the OMNI mode on. Push the Down Key to turn the OMNI mode off.

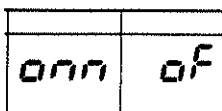

...Receives only the messages on a receive channel

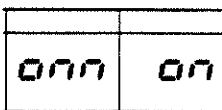

...Receives the messages on the all channels

■ Altering each drum voice's key number (25 to 99)

Key number of each drum voice are common for reception and transmission.

- Step 1 Check the MIDI function as explained in "Checking the MIDI function" on p.78 and have the display indicate the current key number setting.

nr	35
----	----

- Step 2 Push the Main Key of the drum voice that you would like to change and the display will show the Key Number of the designated drum voice.

(When BASS DRUM 1 was selected)

INSTRUMENT									
ACCENT	9								

nr	35
----	----

- Step 3 Push the Up Key when you would like a higher Key Number than the one currently set. Push the Down Key when you would like a lower Key Number.

The Key Number can be set between 25 and 99.

*If a single Key Number is assigned to more than one drum voice, only one of those voices will be accepted when playing information is received for that Key Number. If one or more drum voices is given the same Key Number, any drum voice shown on the lower line above the Main Keys will take precedence over the upper line, and within the upper and lower lines, the voice having the Main Key of the smaller number will be given priority.

b. MIDI Synchronized Playing

Rhythm machines and sequencers that have MIDI terminals can be played synchronously. When two or more rhythm machines and sequencers are connected and played synchronously, the MIDI device that dictates the tempo and the other settings is called the master and the device (s) that are controlled are called the slave (s).

(Synchronized play with the TR-626 acting as the Master)

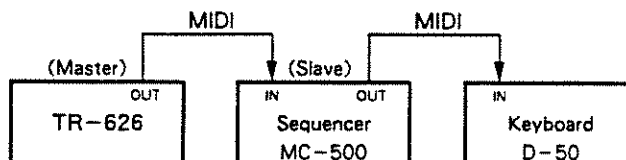

- Step 1** Set every slave device to OMNI OFF.
- Step 2** Set all of the slave devices to operate synchronously in response to signals from the TR-626.
- Step 3** When the Start/Stop Key of the TR-626 is pressed, all of the slave devices will begin playing in unison at the tempo dictated by the TR-626.

*If the slave devices are equipped to accept Song Select and Song Position Pointer MIDI information, the track number and the bar number designated by the TR-626 can be designated to the same settings by the slave devices.

(Synchronized play with the TR-626 acting as a Slave)

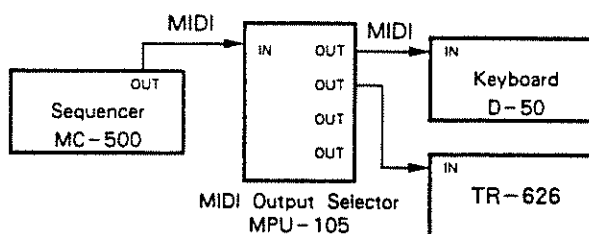

- Step 1** Set the TR-626 to MIDI SYNC mode. (Refer to "Altering SYNC mode" on p.87.)

SYNC mode : Determine whether the external MIDI device or the TR-626 itself will control the TR-626's tempo, starting, stopping, etc. If the TR-626 is to be in control, carry out the procedure above in Synchronized play with the TR-626 acting as the Master. If not do as below.

- Step 2** **Set the TR-626's OMNI to OFF. (Refer to "Altering OMNI mode" on p.83.)**

- Step 3** **The master device's transmission channel and the TR-626's reception channel are usually set to different numbers. However, they can be set the same if you would like to play the TR-626's drum voices with the performance information sent from the master device as well as with the TR-626's own data. (Refer to "Altering the reception channel" on p.83.)**

- Step 4** **When the master device begins to play, the TR-626 will begin sync to it.**

■ Alternating the SYNC mode

Step 1 Check the MIDI function as explained in "Checking the MIDI function" on p.78 and have the display indicate the current SYNC mode setting.

Snc	of
-----	----

Step 2 Push the Up Key and the Down Key to change the SYNC mode.

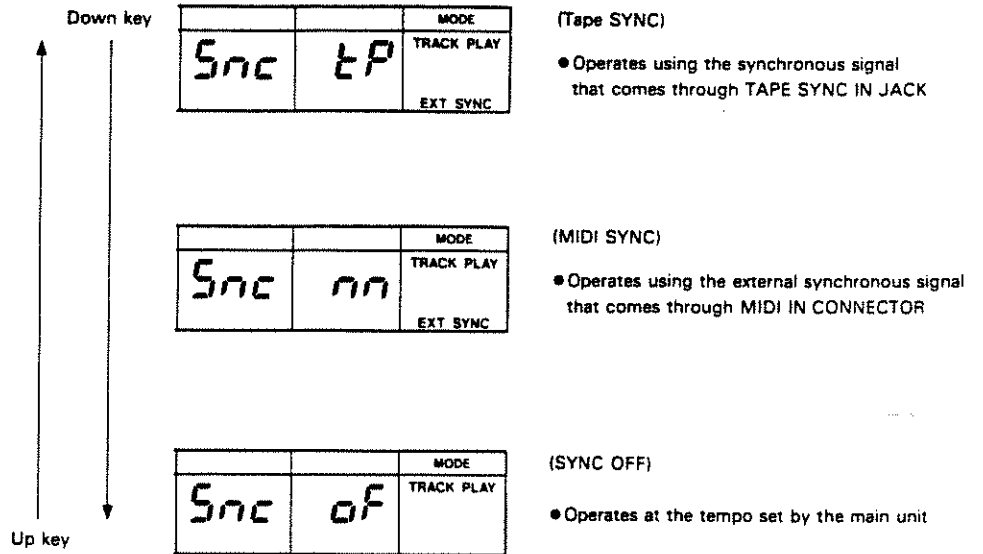

When the TR-626 is syncing to external devices, EXT SYNC will appear in the display. When you make the Display show tempo, the following sync mode is also displayed.

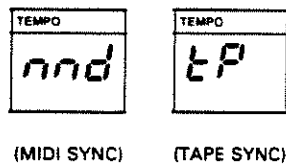

*When the SYNC mode is set at TAPE SYNC or MIDI SYNC, and the Start /Stop Key is pushed, the TR-626 will not begin to play until it receives an external signal. To release it from this state do the following :

When in TAPE SYNC mode

The mode will change to SYNC OFF by pushing the Start/Stop Key again.

When in MIDI SYNC mode

The mode will change to SYNC OFF by pushing the Start/Stop Key again, then having the display indicate the SYNC mode setting, and then pushing the Down Key.

c. Playing MIDI sound modules with the TR-626

The TR-626 outputs its rhythm pattern through its MIDI terminal while it is playing. Making use of this capability, the TR-626 can make more than one external samplers and other machines, which are programmed with their own sound sources, sound effects, specific sounds, etc., play according to the TR-626's output rhythm pattern.

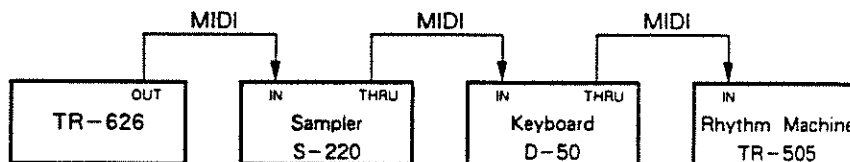

- Step 1** Match the reception channels of the receiving MIDI devices to the transmission channels for each of the TR-626's drum voices. (Refer to "Altering the transmission channel for each drum voice" on p.90)
- Step 2** Set the receiving device (s) to OMNI OFF.
- Step 3** Set the key numbers of each sound source (drum voice) of the TR-626 and the receiving devices to be the same. (Refer to "Altering the Key Number of each drum voice" on p.84.)

When the TR-626 starts to play, the external units will also start to play according to the playing information written in the TR-626.

*The sound level of the receiving sound sources are determined by the accents set for each drum voice in the TR-626 rhythm pattern. This over-rides the level settings on each drum voice of the TR-626.

■ **Altering the transmission channels for individual sound modules (Channels 1 to 16)**

Transmission channels can be set individually for each sound source. This allows for more than one MIDI sound source to be controlled separately by the TR-626. Please note that from the manufacturer, all of the sound sources were set to Channel 10.

- Step 1** Check the MIDI function as explained in "Checking the MIDI function" on p.78 and have the display indicate the transmission channel settings.

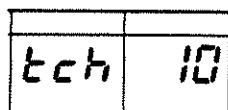

- Step 2** Push the Main Key of the sound source of the transmission channel you would like to change. The display will indicate the designated sound source transmission channel.

- Step 3** Push the Up Key when you would like a higher transmission channel than the one currently set. Push the Down Key when you would like a lower channel.

Transmission channel can be set from 1 to 16.

d. MIDI Exclusive messages (Data transmission/reception by MIDI)

With a MIDI exclusive message, Bank 1 data (rhythm pattern, track data and level and pitch settings of each drum voice) can be transferred in a block to another TR-626 or another unit capable of receiving and memorizing exclusive messages. The following is an example of transferring data between two TR-626 units. To learn about transferring between other machines, please read the relevant operation manual for those units.

● Data transmission to another TR-626

Writing a transmitter's Bank 1 data into the receiver's Bank 1:

The TR-626s should be connected as shown below:

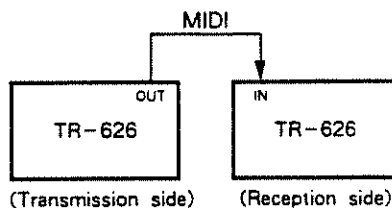

Step 1

Set the reception channels (basic channel) of the transmitter and the receiver TR-626s to be the same and set both of their memories to Bank 1 (internal memory).

*If the TR-626s are not both in Memory Bank 1, the following operation cannot be done.

*Operations using exclusive messages are done through the basic channel. With the TR-626, however, the reception channel is equivalent to the basic channel.

Step 2 Do the following operation on the receiver TR-626 :

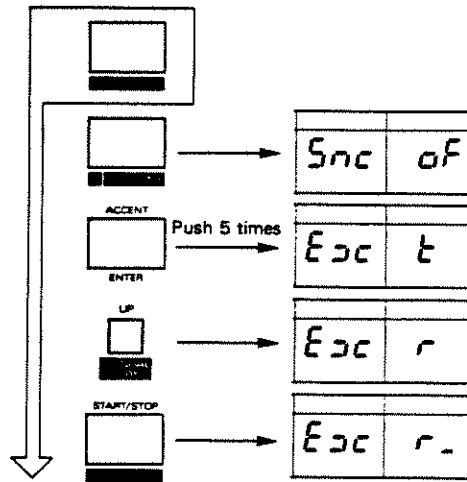

The receiver TR-626 is now set to receive data.

Step 3 Do the following operation on the transmitter TR-626 :

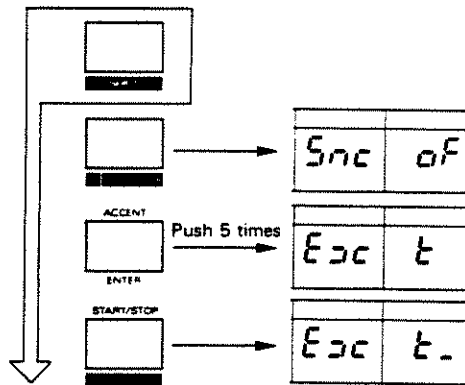

Step 4

When the transmission and the reception of data is being carried out correctly, the receiver TR-626 will display the following :

Esc	r :

After completing transferring data, both the transmitter and the receiver return to their normal states.

*Transferring data is completed in about 5 seconds.

When an error occurs, the receiver TR-626 will display the following and will stop receiving the data :

Err

*To stop the transmission or the reception of data that has already begun, push the Start/Stop Keys of both the transmitter and the receiver.

*If you would like to transfer data written in Memory Bank 2 or 3, that is in a Memory Card, first copy the data to Bank 1 as explained in "Copying data between banks" on p. 68, and then carry out the above operation.

6 Tape SYNC

The TR-626 can be synchronized with an MTR (Multi-track recorder) using Tape SYNC. Certain drum voices can be transmitted through the multi-out jacks. Therefore, by recording drum voices added by special sound effects several times on a multi-track recorder, you can add effects individually for each drum voice, even when you do not have many sound effect devices at your disposal.

1. Recording a synchronized signal

Connect the TR-626 to an MTR as below, to record both a synchronized signal for tape sync on a track of an MTR.

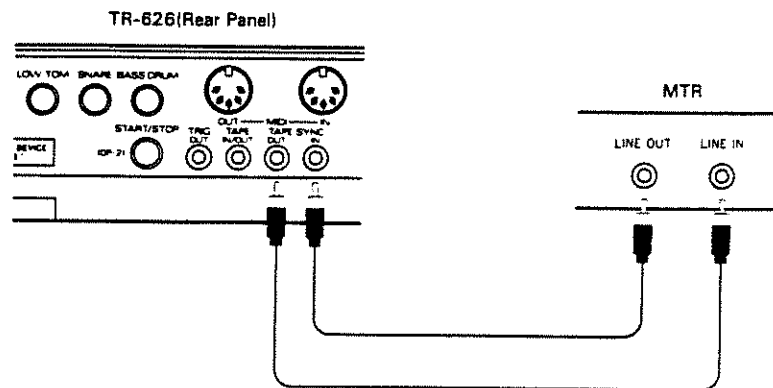

A pilot tone is constantly output through the TR-626's Tape SYNC Out Jack while it is stopped. Set the MTR recording level of the signal so that it is maintained between -10 to -3 VU.

- Step 1** Adjust Tempo Knob to set the playing tempo.
- *Set it to a tempo at or below 180. Synchronized playing cannot be done correctly at any setting above this limit.
- Step 2** Start the MTR recording. Several seconds later, push the Start/Stop Key of the TR-626 to begin playing.
- Step 3** When this finishes, push the Start/Stop Key again, then stop the MTR. The MTR has now recorded the synchronized signal.

2. Playing with a synchronized signal

Synchronize the TR-626 with a tape-recorded synchronized signal to have it start playing.

Connect the TR-626 to the MTR as below :

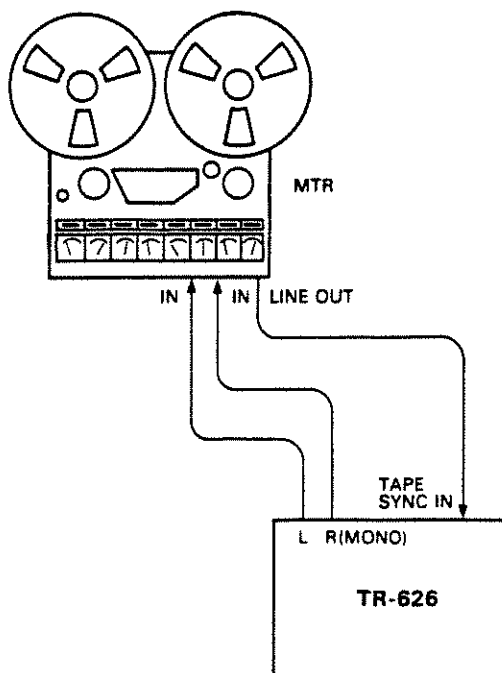

Rewind the tape onto which the synchronized signal was recorded. Find the part of the tape where a pilot tone is heard before the modulated tone begins. This is the place from which to begin.

Step 1 Set the TR-626 on Tape SYNC mode. (See p.87.)

		MODE
Snc	tP	TRACK PLAY
		EXT SYNC

Step 2 Start the MTR playing.

Step 3 **Push the Start/Stop Key.**

*The tape will start to play synchronized correctly if a pilot tone is still heard before a modulated tone begins.

*If the tapes still do not synchronize properly, adjust the MTR's synchronized signal's output level and try again. If it still does not work, change the recording level and start over again from the beginning at step 1 in "1. Recording a synchronized signal."

Before calling the Repaires

Symptom

Possible cause

Drum Voice

- No sound is heard.
 - The level of the drum voice is set to 0.
 - The overall volume is set to the minimum.
- Tone of the sound is strange.
 - The pitch of the drum voice is not set properly.
 - The drum voice you want is not assigned to the Main key.
- Level and pitch cannot be adjusted.
 - The Protect Switch is set to ON in Memory Banks 2 or 3.

Writing

- Writing The unit cannot enter the writing mode.
 - The Protect Switch is set to ON in Memory Banks 2 or 3.
- A rhythm pattern cannot be written.
 - The unit is set to the Manual Play mode.
 - The unit is set to the Level/Pitch mode.
 - The unit is set to the accent writing mode of the Step writing mode.
- The drum voice you have written is erased.
 - You have written the drum voices of the same group in one step.
- Shuffle cannot be obtained.
 - The scale is set to the triplet or its multiple.
- Flam cannot be written.
 - The drum voice other than SD1/2/3, LT1/2, MT1/2 or HT1/2 is selected.(Flam can be written only in these drum voices.)
- Flam cannot be set.
 - The flam interval is set to 0.

Tape Memory

- Verification and loading cannot be done.
 - Connections are not made properly.
 - The output level of the tape recorder is not appropriate.
 - You have used different tape recorders for saving and loading.
 - The recording level during saving was not appropriate.
 - The tape used is damaged.

Tape Sync

- Tape sync cannot be performed.
- Connections are not made properly.
- The output level of the tape recorder is not appropriate.
- The recording level for sync signals is not appropriate.
- TAPE SYNC mode is not selected.
- You have failed to push the Start key.

Memory Card

- You cannot change the Memory Banks.
- The memory card is not inserted properly.
- Data cannot be copied onto a memory card.
- The Protect Switch on the memory card is set to ON.

MIDI

- The unit cannot receive MIDI messages.
- Connections are not made properly.
- The OMNI OFF mode selected and the MIDI receive channel of the unit is not set to the same number of the transmit channel of the external unit.
- Key numbers of the unit do not match those of the external unit.
- The unit receives even the messages other than the receive channel.
- OMNI ON is selected.
- Sync cannot be performed.
- MIDI SYNC mode is not selected.
- Song Select and Song Position Pointer cannot be received.
- MIDI SYNC mode is not selected.
- Exclusive messages cannot be received.
- You have performed transmission procedure prior to reception.
- The basic channels of the transmitter and receiver are not set to the same one.

Others

- The unit is automatically changed from the Writing to Playing mode.
- Memory card's Protect Switch is set to ON in Memory Banks 2 and 3.
- Rhythm does not start playing by pushing the Start key.
- The track is empty.
- EXT SYNC mode is selected.
- Track data is rewritten automatically.
- You have turn off the unit in the Track Write mode.
- You have set the memory card's Protect Switch ON or disconnect the memory card with Memory Banks 2 and 3 set to Track Write mode.

■ PRESET RHYTHM

[Pattern Group A]

1	2	3	4	5	6	7	8
Rock 8Beat 1	Rock 8Beat 2	Rock 8Beat 3	Rock 8Beat 4	Rock 16Beat 1	Rock 16Beat 2	Disco 1	Disco 2
9	10	11	12	13	14	15	16
Slow Rock	Shuffle	Funky 1	Funky 2	Rock Fill-in 1	Rock Fill-in 2	Triplet Fill-in	Rock Fill-in 3

[Pattern Group B]

1	2	3	4	5	6	7	8
Swing 1	Swing 2	Bossanova 1	Bossanova 2	Mambo	Merengue	Rhumba	Beguine
9	10	11	12	13	14	15	16
Samba 1	Samba 2	Tango	Marching	Swing Fill-in	Latin Fill-in	Latin Break	Samba Fill-in

[Pattern Group C]

1	2	3	4	5	6	7	8
Oldies 1	Oldies 2	Oldies R & B	Reggae 1	Reggae 2	Rap	Hip Hop	Electric Funk
9	10	11	12	13	14	15	16
Metal 1	Metal 2	Rock Vari 1	Rock Vari 2	Reggae Fill-in	Electric Fill-in	Metal Fill-in	Count Click

■ PROGRAM RHYTHM

[Pattern Group D]

1	2	3	4	5	6	7	8
9	10	11	12	13	14	15	16

[Pattern Group E]

1	2	3	4	5	6	7	8
9	10	11	12	13	14	15	16

[Pattern Group F]

1	2	3	4	5	6	7	8
9	10	11	12	13	14	15	16

■ PATTERN NOTE

BANK :

PATTERN GROUP :

PATTERN NUMBER :

SCALE :

LAST STEP :

SHUFFLE :

FLAM :

STEP
(INSTRUMENT)

	1	2	3	4	5	6	7	8	9	10	11	12	13	14	15	16

BANK :

PATTERN GROUP :

PATTERN NUMBER :

SCALE :

LAST STEP :

SHUFFLE :

FLAM :

STEP
(INSTRUMENT)

	1	2	3	4	5	6	7	8	9	10	11	12	13	14	15	16

BANK :

PATTERN GROUP :

PATTERN NUMBER :

SCALE :

LAST STEP :

SHUFFLE :

FLAM :

STEP
(INSTRUMENT)

	1	2	3	4	5	6	7	8	9	10	11	12	13	14	15	16

BANK :

PATTERN GROUP :

PATTERN NUMBER :

SCALE :

LAST STEP :

SHUFFLE :

FLAM :

STEP
(INSTRUMENT)

	1	2	3	4	5	6	7	8	9	10	11	12	13	14	15	16

Specifications

TR-626 : RHYTHM COMPOSER

● Preset Rhythm Patterns

48 Patterns
(16 Patterns in each of A, B and C Groups)

● Users Programmable Rhythm Patterns

48 Patterns
(16 Patterns in each of D, E and F Groups)
[48 Patterns in each of 3 Banks : Memory Card
M-128D used]

● Tempo

40 to 240 beats per minute

● Track

6 Tracks (Max. 999 bars total)
[6 Tracks in each of 3 Banks : Memory Card
M-128D used]

● Steps (in a bar)

1 to 16 Steps

● Accent

-3 to +3 (7 levels) in each drum voice

● Pitch

-7 to +7 (15 pitches) in each drum voice

● Level

0 to +5 (6 levels) in each drum voice

● Drum Voices (8 voice groups, total of 30 voices)

BASS DRUM 1/BASS DRUM 2,
SNARE DRUM 1/SNARE DRUM 2
/LOW TIMBALE/HI TIMBALE,
LOW TOM 1/LOW TOM 2/MID TOM 1
/MID TOM 2/HI TOM 1/HI TOM 2
/OPEN HI CONGA/LOW CONGA,
OPEN HI-HAT/CLOSED HI-HAT,
CRASH CYMBAL/RIDE CYMBAL
/CHINA CYMBAL/CUP,
RIM SHOT/SNARE DRUM 3,
HAND CLAP/CLAVES/MUTE HI CONGA
/SHAKER,
COWBELL/TAMBOURINE/LOW AGOGO
/HI AGOGO.

*Drum voices belonging to the same voice group
do not sound simultaneously.

● Control & Indicator

	Shift function
Start/Stop key	Continue Start key
Instrument change key	Tempo/measure key
Down key	Shuffle/flam key
Up key	Manual play key
Level key	Pitch key

Pattern mode	Track mode
Pattern clear key	Track clear key
Scale key	Measure back key
Last step key	Measure forward key
Instrument/metronome key	Last measure key
Pattern group key	Track number key
A / D	1 / 4
B / E	2 / 5
C / F	3 / 6

Main key (1 to 16)
Shift key
Mode key
Enter key/Accent key
Tempo knob
Volume knob
Tempo indicator
Display

● **Rear Panel**

Mono/Stereo Out Jack (R)
Stereo Out Jack (L)
Headphone Jack

Multi Out Jack

[Display]	[Output Voice]
BASS DRUM	BASS DRUM 1,2
SNARE	SNARE DRUM 1,2,3 /RIM SHOT
LOW TOM	LOW TOM 1,2
MID TOM	MID TOM 1,2
HI TOM	HI TOM 1,2
HI-HAT	CLOSED HI-HAT /OPEN HI-HAT
CRASH	CRASH CYMBAL /CHINA CYMBAL
RIDE	RIDE CYMBAL/CUP

Start/Stop Jack (DP-2)
Trigger Out Jack (RIM SHOT)
Tape In/Out Jack
Tape Sync In Jack
Tape Sync Out Jack
MIDI IN Connector
MIDI OUT Connector
Memory Card Slot
Power Switch
AC Adaptor Jack (9V) : Use PSA series AC Adaptor
only

● **Consumption** : 50mA

● **Dimensions** : 400 (W) × 194 (D) × 55 (H) mm
15-3/4" × 7-5/8" × 2-3/16"

● **Weight** : 1.3kg/2lb 14oz (including the battery)

● **Accessories**

Dry-cell batteries (UM-3×6)
Connection Cable (II-250)
Owner's Manual
Preset Rhythm Score
Preset Rhythm Seals
Operation Chart
Booklet "MIDI"

● **Options**

AC Adaptor (BOSS PSA series)
Pedal Switch (DP-2, BOSS FS-5U)
Memory Card (M-128D)

Roland Exclusive Messages

1. Data Format for Exclusive Messages

Roland's MIDI implementation uses the following data format for all exclusive messages (type IV):

Byte	Description
F0H	Exclusive status
41H	Manufactures ID (Roland)
DEV	Device ID
MDL	Model ID
CMD	Command ID
[BODY]	Maindata
F7H	End of exclusive

MIDI status : F0H, F7H

An exclusive message must be flanked by a pair of status codes, starting with a Manufactures-ID immediately after F0H (MIDI version 1.0).

Manufactures-ID : 41H

The Manufactures-ID identifies the manufacturer of a MIDI instrument that triggers an exclusive message. Value 41H represents Roland's Manufactures-ID.

Device-ID : DEV

The Device-ID contains a unique value that identifies the individual device in the multiple implementation of MIDI instruments. It is usually set to 00H - 0FH, a value smaller by one than that of a basic channel, but value 00H - 1FH may be used for a device with multiple basic channels.

Model-ID : MDL

The Model-ID contains a value that uniquely identifies one model from another. Different models, however, may share an identical Model-ID if they handle similar data.

The Model-ID format may contain 00H in one or more places to provide an extended data field. The following are examples of valid Model-IDs, each representing a unique model:

01H
02H
03H
00H, 01H
00H, 02H
00H, 00H, 01H

Command-ID : CMD

The Command-ID indicates the function of an exclusive message. The Command-ID format may contain 00H in one or more places to provide an extended data field. The following are examples of valid Command-IDs, each representing a unique function:

01H
02H
03H
00H, 01H
00H, 02H
00H, 00H, 01H

Main data : BODY

This field contains a message to be exchanged across an interface. The exact data size and contents will vary with the Model-ID and Command-ID.

2. Address-mapped Data Transfer

Address mapping is a technique for transferring messages conforming to the data format given in Section 1. It assigns a series of memory-resident records--waveform and tone data, switch status, and parameters, for example--to specific locations in a machine-dependent address space, thereby allowing access to data residing at the address a message specifies.

Address-mapped data transfer is therefore independent of models and data categories. This technique allows use of two different transfer procedures: one-way transfer and handshake transfer.

One-way transfer procedure (See Section 3 for details.)

This procedure is suited for the transfer of a small amount of data. It sends out an exclusive message completely independent of a receiving device status.

Connection Diagram

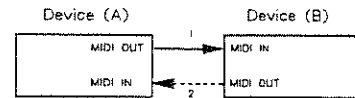

Connectional point 2 is essential for "Request data" procedures. (See Section 3.)

Handshake-transfer procedure (See Section 4 for details.)

This procedure initiates a predetermined transfer sequence (handshaking) across the interface before data transfer takes place. Handshaking ensures that reliability and transfer speed are high enough to handle a large amount of data.

Connection Diagram

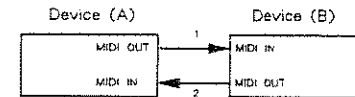

Connection at points 1 and 2 is essential.

Notes on the above two procedures

- *There are separate Command-IDs for different transfer procedures.
- *Devices A and B cannot exchange data unless they use the same transfer procedure, share identical Device-ID and Model ID, and are ready for communication.

3. One-way Transfer Procedure

This procedure sends out data all the way until it stops when the messages are so short that answerbacks need not be checked.

For long messages, however, the receiving device must acquire each message in time with the transfer sequence, which inserts intervals of at least 20 milliseconds in between.

Types of Messages

Message	Command ID
Request data 1	RQ1 (11H)
Data set 1	DT1 (12H)

Request data # 1 : RQ1 (11H)

This message is sent out when there is a need to acquire data from a device at the other end of the interface. It contains data for the address and size that specify designation and length, respectively, of data required.

On receiving an RQ1 message, the remote device checks its memory for the data address and size that satisfy the request.

If it finds them and is ready for communication, the device will transmit a "Data set 1 (DT1)" message, which contains the requested data. Otherwise, the device will send out nothing.

Byte	Description
F0H	Exclusive status
41H	Manufactures ID (Roland)
DEV	Device ID
MDL	Model ID
11H	Command ID
aaH	Address MSB
⋮	⋮
⋮	LSB
55H	Size MSB
⋮	⋮
⋮	LSB
sum	Check sum
F7H	End of exclusive

- *The size of the requested data does not indicate the number of bytes that will make up a DT1 message, but represents the address fields where the requested data resides.
- *Some models are subject to limitations in data format used for a single transaction. Requested data, for example, may have a limit in length or must be divided into predetermined address fields before it is exchanged across the interface.
- *The same number of bytes comprises address and size data, which, however, vary with the Model-ID.
- *The error checking process uses a checksum that provides a bit pattern where the least significant 7 bits are zero when values for an address, size, and that checksum are summed.

Data set 1 : DT1 (12H)

This message corresponds to the actual data transfer process. Because every byte in the data is assigned a unique address, a DT1 message can convey the starting address of one or more data as well as a series of data formatted in an address-dependent order.

The MIDI standards inhibit non-real time messages from interrupting an exclusive one. This fact is inconvenient for the devices that support a "soft-through" mechanism. To maintain compatibility with such devices, Roland has limited the DT1 to 256 bytes so that an excessively long message is sent out in separate segments.

Byte	Description
FOH	Exclusive
41H	Manufactures ID (Roland)
DEV	Device ID
MDL	Model ID
12H	Command ID
aaH	Address MSB
⋮	⋮
	LSB
ddH	Data
⋮	⋮
sum	Check sum
F7H	End of exclusive

- *A DT1 message is capable of providing only the valid data among those specified by an RQ1 message.
- *Some models are subject to limitations in data format used for a single transaction. Requested data, for example, may have a limit in length or must be divided into predetermined address fields before it is exchanged across the interface.
- *The number of bytes comprising address data varies from one Model-ID to another.
- *The error checking process uses a checksum that provides a bit pattern where the least significant 7 bits are zero when values for an address, size, and that checksum are summed.

Example of Message Transactions

- Device A sending data to Device B
Transfer of a DT1 message is all that takes place.

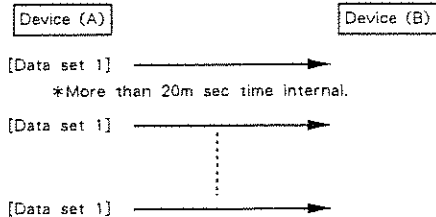

- Device B requesting data from Device A
Device B sends an RQ1 message to Device A. Checking the message, Device A sends a DT1 message back to Device B.

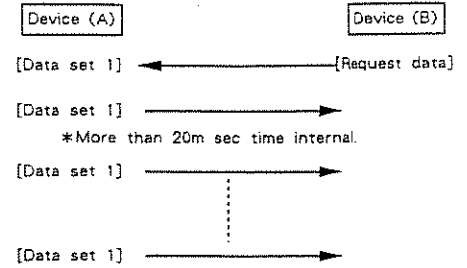

4. Handshake - Transfer Procedure

Handshaking is an interactive process where two devices exchange error checking signals before a message transaction takes place, thereby increasing data reliability. Unlike one-way transfer that inserts a pause between message transactions, handshake transfer allows much speedier transactions because data transfer starts once the receiving device returns a ready signal.

When it comes to handling large amounts of data—sampler waveforms and synthesizer tones over the entire range, for example—across a MIDI interface, handshaking transfer is more efficient than one-way transfer.

Types of Messages

Message	Command ID
Want to send data	WSD (40H)
Request data	RQD (41H)
Data set	DAT (42H)
Acknowledge	ACK (43H)
End of data	EOD (45H)
Communication error	ERR (4EH)
Rejection	RJC (4FH)

Want to send data : WSD (40H)

This message is sent out when data must be sent to a device at the other end of the interface. It contains data for the address and size that specify designation and length, respectively, of the data to be sent.

On receiving a WSD message, the remote device checks its memory for the specified data address and size which will satisfy the request. If it finds them and is ready for communication, the device will return an "Acknowledge (ACK)" message.

Otherwise, it will return a "Rejection (RJC)" message.

Byte	Description
F0H	Exclusive status
41H	Manufactures ID (Roland)
DEV	Device ID
MDL	Model ID
40H	Command ID
aaH	Address MSB
⋮	⋮
	LSB
ssH	Size MSB
⋮	⋮
	LSB
sum	Check sum
F7H	End of exclusive

- *The size of the data to be sent does not indicate the number of bytes that make up a "Data set (DAT)" message, but represents the address fields where the data should reside.
- *Some models are subject to limitations in data format used for a single transaction. Requested data, for example, may have a limit in length or must be divided into predetermined address fields before it is exchanged across the interface.
- *The same number of bytes comprises address and size data, which, however, vary with the Model-ID.
- *The error checking process uses a checksum that provides a bit pattern where the least significant 7 bits are zero when values for an address, size, and that checksum are summed.

Request data : RQD (41H)

This message is sent out when there is a need to acquire data from a device at the other end of the interface. It contains data for the address and size that specify designation and length, respectively, of data required.

On receiving an RQD message, the remote device checks its memory for the data address and size which satisfy the request. If it finds them and is ready for communication, the device will transmit a "Data set (DAT)" message, which contains the requested data. Otherwise, it will return a "Rejection (RJC)" message.

Byte	Description
F0H	Exclusive status
41H	Manufactures ID (Roland)
DEV	Device ID
MDL	Model ID
41H	Command ID
aaH	Address MSB
⋮	⋮
	LSB
ssH	Size MSB
⋮	⋮
	LSB
sum	Check sum
F7H	End of exclusive

*The size of the requested data does not indicate the number of bytes that make up a "Data set (DAT)" message, but represents the address fields where the requested data resides.

*Some models are subject to limitations in data format used for a single transaction. Requested data, for example, may have a limit in length or must be divided into predetermined address fields before it is exchanged across the interface.

*The same number of bytes comprises address and size data, which, however, vary with the Model-ID.

*The error checking process uses a checksum that provides a bit pattern where the least significant 7 bits are zero when values for an address, size, and that checksum are summed.

Data set : DAT (42H)

This message corresponds to the actual data transfer process. Because every byte in the data is assigned a unique address, the message can convey the starting address of one or more data as well as a series of data formatted in an address-dependent order.

Although the MIDI standards inhibit non-real time messages from interrupting an exclusive one, some devices support a "soft-through" mechanism for such interrupts. To maintain compatibility with such devices, Roland has limited the DAT to 256bytes so that an excessively long message is sent out in separate segments.

Byte	Description
F0H	Exclusive status
41H	Manufactures ID (Roland)
DEV	Device ID
MDL	Model ID
42H	Command ID
aaH	Address MSB
⋮	⋮
	LSB
ddH	Data
⋮	⋮
sum	Check sum
F7H	End of exclusive

*A DAT message is capable of providing only the valid data among those specified by an RQD or WSD message.

*Some models are subject to limitations in data format used for a single transaction. Requested data, for example, may have a limit in length or must be divided into predetermined address fields before it is exchanged across the interface.

*The number of bytes comprising address data varies from one model ID to another.

*The error checking process uses a checksum that provides a bit pattern where the least significant 7 bits are zero when values for an address, size, and that checksum are summed.

Acknowledge : ACK (43H)

This message is sent out when no error was detected on reception of a WSD, DAT, "End of data (EOD)", or some other message and a requested setup or action is complete. Unless it receives an ACK message, the device at the other end will not proceed to the next operation.

Byte	Description
F0H	Exclusive status
41H	Manufactures ID (Roland)
DEV	Device ID
MDL	Model ID
43H	Command ID
F7H	End of exclusive

End of data : EOD (45H)

This message is sent out to inform a remote device of the end of a message. Communication, however, will not come to an end unless the remote device returns an ACK message even though an EOD message was transmitted.

Byte	Description
F0H	Exclusive status
41H	Manufactures ID (Roland)
DEV	Device ID
MDL	Model ID
45H	Command ID
F7H	End of exclusive

Communications error : ERR (4EH)

This message warns the remote device of a communications fault encountered during message transmission due, for example, to a checksum error. An ERR message may be replaced with a "Rejection (RJC)" one, which terminates the current message transaction in midstream.

When it receives an ERR message, the sending device may either attempt to send out the last message a second time or terminate communication by sending out an RJC message.

Byte	Description
F0H	Exclusive status
41H	Manufactures ID (Roland)
DEV	Device ID
MDL	Model ID
4EH	Command ID
F7H	End of exclusive

Rejection : RJC (4FH)

This message is sent out when there is a need to terminate communication by overriding the current message. An RJC message will be triggered when :

- a WSD or RQD message has specified an illegal data address or size.
- the device is not ready for communication.
- an illegal number of addresses or data has been detected.
- data transfer has been terminated by an operator.
- a communications error has occurred.

An ERR message may be sent out by a device on either side of the interface. Communication must be terminated immediately when either side triggers an ERR message.

Byte	Description
FOH	Exclusive status
41H	Manufactures ID (Roland)
DEV	Device ID
MDL	Model ID
4FH	Command ID
F7H	End of exclusive

Example of Message Transactions

● Data transfer from device (A) to device (B).

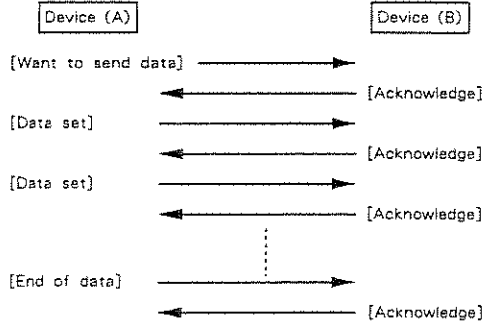

● Device (A) requests and receives data from device (B).

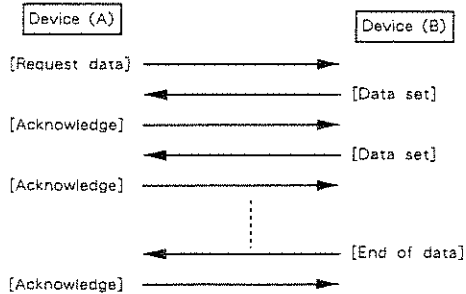

● Error occurs while device (A) is receiving data from device (B).

1) Data transfer from device (A) to device (B).

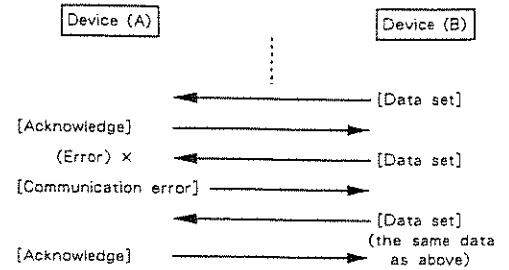

2) Device (B) rejects the data re-transmitted, and quits data transfer.

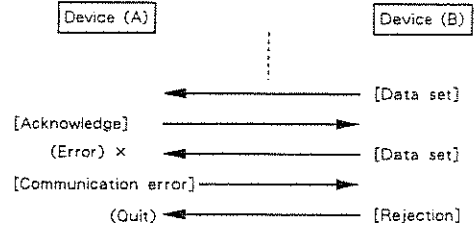

3) Device (A) immediately quits data transfer.

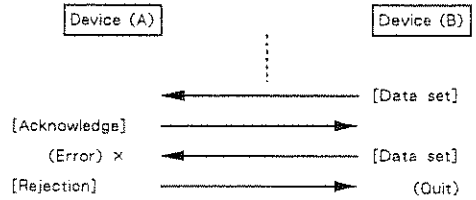

1. TRANSMITTED DATA

■ Note event

Note off

Status	Second	Third
9nH	kkH	00H

n=Transmit channel: 0H-FH (1-16)
 kk=Note number: 19H-63H (25-99)

Note on

Status	Second	Third
9nH	kkH	vvH

kk=Note number: 19H-63H (25-99)
 vv=Velocity: 12H-7FH (18-127)
 Determined by Accent value: -3 to +3

Transmit channel for each voice can be set to any of 1 to 16 by panel operation. Note number of each voice can be assigned to one of 25 to 99. The above settings can be made by panel operation and are non-volatile. The accent value (-3 to +3) written in a pattern determines the note velocity, overriding the volume level set internally.

Accent	Velocity
-3	12H
-2	19H
-1	23H
0	30H
+1	42H
+2	5BH
+3	7FH

■ System exclusive

Status
 F0H: System Exclusive
 F7H: EOX (End of Exclusive)

Refer to 3. EXCLUSIVE COMMUNICATIONS.

■ System common

Song Position Pointer

Status	Second	Third
F2H	llH	hhH

ll=Least significant: 00H-7FH (0-127)
 hh=Most significant: 00H-7FH (0-127)

Sent whenever MEASURE FORWARD or MEASURE BACK is pressed, or a measure number is specified.

Song Select

Status	Second
F3H	ssH

ss=song select: 00H-05H (0-5)

Sent whenever the track is set to new track from the panel. One each of the track numbers 1 to 6 corresponds to the song selects 0 to 5 in that order.

■ System real time

Timing Clock

Status
 FBH

Sent even if the rhythm is not running.

Start

Status
 FAH

Sent upon pressing START for playing.

Continue

Status
 FBH

Sent upon pressing CONTINUE START for re-running the rhythm.

Stop

Status
 FCH

Sent whenever the rhythm is stopped.

When Sync mode is set at MIDI, the TR-626 sends (software through) the real time messages received from MIDI IN.

2. RECOGNIZED RECEIVE DATA

■ Channel mode message

OMNI OFF

Status	Second	Third
BbH	7CH	00H

OMNI ON

Status	Second	Third
BbH	7DH	00H

b=Basic channel: 0H-FH (1-16)

■ Note event

Note on

Status	Second	Third
9bH	kkH	vvH

b=Basic channel: 0H-FH (1-16)
 kk=Note number: 19H-63H (25-99)
 vv=Velocity: 01H-7FH (1-127)

The basic channel (receive channel) can be changed to 1-16 by panel operation. The Basic channel is non-volatile. Assignment of a Note number to a voice is common to MIDI IN and MIDI OUT. Assignment can be independent of the remaining voices. A MIDI IN note number will sound the voice to which it is assigned. The associated Velocity determines the volume of the voice, defeating the internal level setting.

■ System exclusive

Status
 F0H: System Exclusive
 F7H: EOX (End of Exclusive)

Refer to 3. EXCLUSIVE COMMUNICATIONS.

■ System common

Recognized only when the TR-626 is in 'STOP' status in the Track Play mode.

Song Position Pointer

Status	Second	Third
F2H	llH	hhH

ll=Least significant: 00H-7FH (0-127)
 hh=Most significant: 00H-7FH (0-127)

Song Select

Status	Second
F3H	ssH

ss=song select: 00H-05H (0-5)
 06H-7FH ignored

One each of track numbers 1 to 6 corresponds to the song selects 0 to 5 in that order, regardless of memory bank being currently selected (internal or external memory card).

■ System real time

Recognized only when the Sync mode is set at MIDI.

Timing Clock

Status
 FBH

When Sync mode is set at MIDI, the TR-626 keeps rhythm timing to this clock.

Start

Status
FAH

When Sync mode is set at MIDI, the TR-626 starts running on the Start message.

Continue

Status
FBH

When Sync mode is set at MIDI, the TR-626 starts continue play upon receiving this message.

Stop

Status
FCH

When Sync mode is set at MIDI, the TR-626 stops upon receipt of this message.

3. EXCLUSIVE COMMUNICATIONS

See the TR-626 Owner's Manual for send/receive procedures of the exclusive messages.

One way communication

■ Data set

When recognized, the following messages are stored internally.

Byte	Description
FOH	Exclusive status
41H	Roland-ID
0bH	Device-ID=MIDI (basic channel)
1DH	Model-ID (TR-626)
12H	Command-ID (DT)
aaH	Address (MSB)
bbH	Address (LSB)
ddH	Data dd=00H-7FH
:	:
ddH	Data
ssH	Sum ss : aaH + bbH + ddH + ... + ddH + ssH = 0
F7H	EOX (End of Exclusive)

■ Address mapping of data

With the TR-626 the following data for memory bank 1 are available for send/receive of exclusive messages. Pattern, track, and the level and pitch of each voice

Address		Description
aaH (MSB)	bbH (LSB)	
00H	20H	data start address
		data
2DH	10H	data end address

Function...		Transmitted	Recognized	Remarks
Basic Channel	Default Changed	1-16 1-16	1-16 1-16	Memorized (non-volatile)
Mode	Default Messages Altered	Mode 3 *****	Mode 1 OMNI ON/OFF	Memorized (non-volatile)
Note Number	True Voice	25-99 *1 *****	25-99 *1	assignable to each voice
Velocity	Note ON Note OFF	○ 9n v=18-27 × 9n v=0	○ 9b v=1-127 ×	n=Inst CH *2 b=Basic CH
After Touch	Key's Ch's	× ×	× ×	
Pitch Bender		×	×	
Control Change		×	×	
Prog Change	True #	× *****	×	
System Exclusive		○	○	
System Common	Song Pos Song scl Tune	○ ○ ×	○ SYNC=MIDI ○ SYNC=MIDI ×	0-5
System Real Time	Clock Commands	○ ○	○ SYNC=MIDI ○ SYNC=MIDI	
Aux Message	Local ON/OFF All Notes OFF Active Sense Reset	× × × ×	× × × ×	
Notes		*1 Can be changed by panel operation. *2 Transmit channel number of each voice can be changed to 1 to 16 by panel operation.		

Mode 1 : OMNI ON, POLY
 Mode 3 : OMNI OFF, POLY

Mode 2 : OMNI ON, MONO
 Mode 4 : OMNI OFF, MONO

○ : Yes
 × : No

TR-626

PRESET RHYTHM SCORE

プリセット・リズム・スコア

パターン・グループ A

1	2	3	4	5	6	7	8
ロック 8ビート 1	ロック 8ビート 2	ロック 8ビート 3	ロック 8ビート 4	ロック 16ビート 1	ロック 16ビート 2	ディスコ 1	ディスコ 2
9	10	11	12	13	14	15	16
スロー・ロック	シャッフル	ファンキー 1	ファンキー 2	ロック フィル・イン 1	ロック フィル・イン 2	トリプレット フィル・イン	ロック フィル・イン 3

パターン・グループ B

1	2	3	4	5	6	7	8
スウィング 1	スウィング 2	ボサノバ 1	ボサノバ 2	マンボ	メレンゲ	ルンバ	ビギン
9	10	11	12	13	14	15	16
サンバ 1	サンバ 2	タンゴ	マーチ	スウィング フィル・イン	ラテン フィル・イン	ラテン ブレイク	サンバ フィル・イン

パターン・グループ C

1	2	3	4	5	6	7	8
オールディーズ 1	オールディーズ 2	オールディーズ R & B	レゲエ 1	レゲエ 2	ラップ	ヒップホップ	エレクトリック ファンク
9	10	11	12	13	14	15	16
メタル 1	メタル 2	ロック バリエーション 1	ロック バリエーション 2	レゲエ フィル・イン	エレクトリック フィル・イン	メタル フィル・イン	カウント クリック

Pattern Group A

1	2	3	4	5	6	7	8
Rock 8Beat 1	Rock 8Beat 2	Rock 8Beat 3	Rock 8Beat 4	Rock 16Beat 1	Rock 16Beat 2	Disco 1	Disco 2
9	10	11	12	13	14	15	16
Slow Rock	Shuffle	Funky 1	Funky 2	Rock Fill-in 1	Rock Fill-in 2	Triplet Fill-in	Rock Fill-in 3

Pattern Group B

1	2	3	4	5	6	7	8
Swing 1	Swing 2	Bossanova 1	Bossanova 2	Mambo	Merengue	Rhumba	Beguine
9	10	11	12	13	14	15	16
Samba 1	Samba 2	Tango	Marching	Swing Fill- in	Latin Fill-in	Latin Break	Samba Fill-in

Pattern Group C

1	2	3	4	5	6	7	8
Oldies 1	Oldies 2	Oldies R & B	Reggae 1	Reggae 2	Rap	Hip Hop	Electric Funk
9	10	11	12	13	14	15	16
Metal 1	Metal 2	Rock Vari 1	Rock Vari 2	Reggae Fill-in	Electric Fill-in	Metal Fill-in	Count Click

A-1 ロック・8ビート1 Rock 8Beat 1

*Names of drum voices shown here are abbreviation.(See page 9 in the owner's manual.)

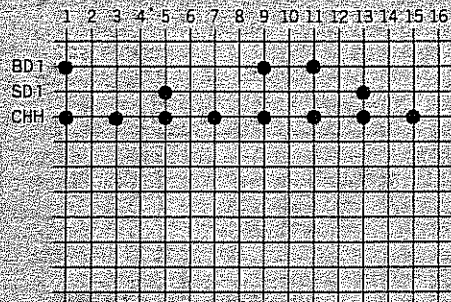

SCALE :
 LAST STEP : 16
 SHUFFLE :
 ★FLAM :

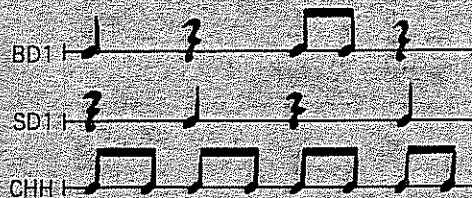

A-2 ロック・8ビート2 Rock 8Beat 2

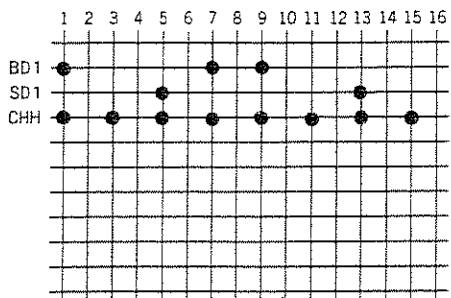

SCALE :
 LAST STEP : 16
 SHUFFLE :
 ★FLAM :



A-3 ロック・8ビート3 Rock 8Beat 3

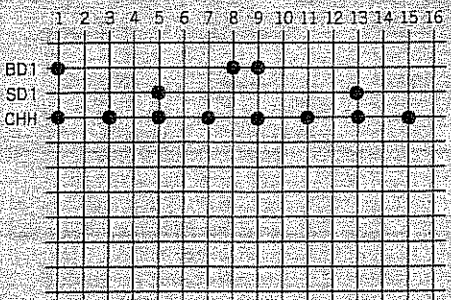

SCALE :
 LAST STEP : 16
 SHUFFLE :
 ★FLAM :

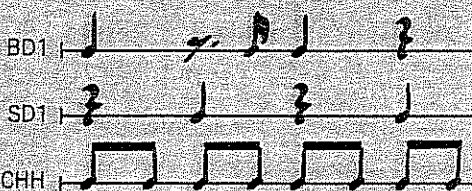

A-4 ロック・8ビート4 Rock 8Beat 4

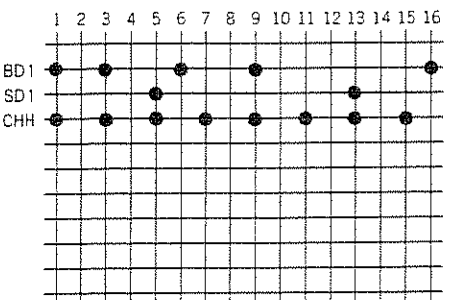

SCALE :
 LAST STEP : 16
 SHUFFLE :
 ★FLAM :



A-5 ロック・16ビート1 Rock 16Beat 1

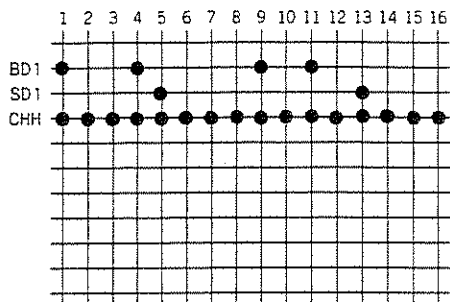

SCALE :

LAST STEP : 16

SHUFFLE :

★FLAM :

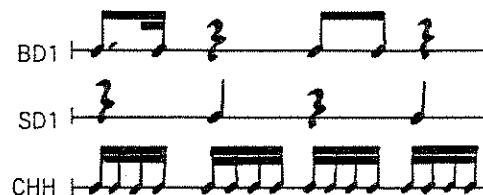

A-6 ロック・16ビート2 Rock 16Beat 2

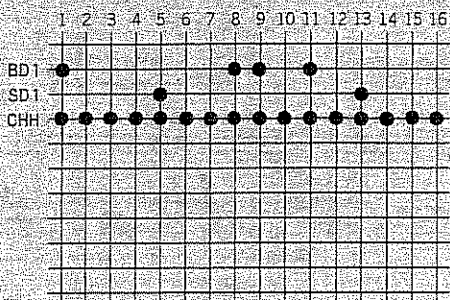

SCALE :

LAST STEP : 16

SHUFFLE :

★FLAM :

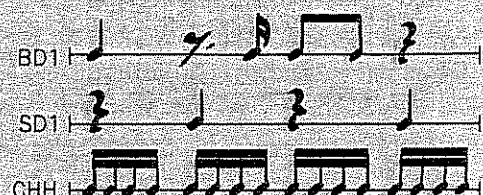

A-7 ディスコ1 Disco 1

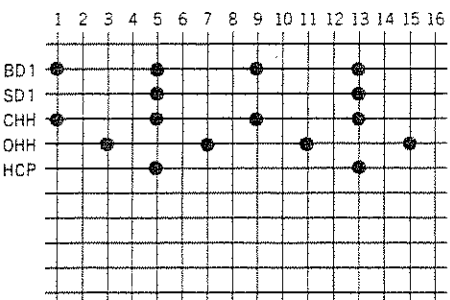

SCALE :

LAST STEP : 16

SHUFFLE :

★FLAM :



A-8 ディスコ2 Disco 2

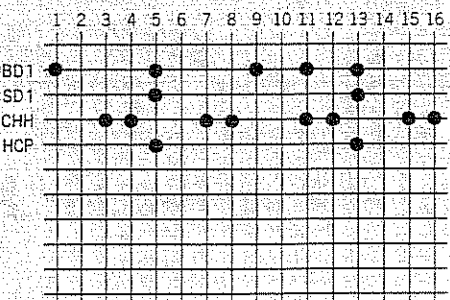

SCALE :

LAST STEP : 16

SHUFFLE :

★FLAM :

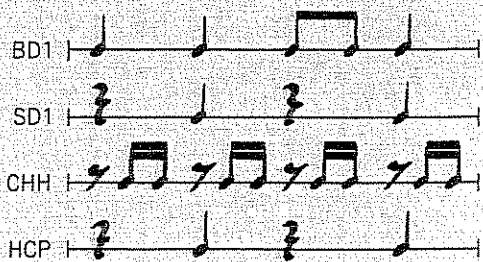

A-9 スロー・ロック Slow Rock

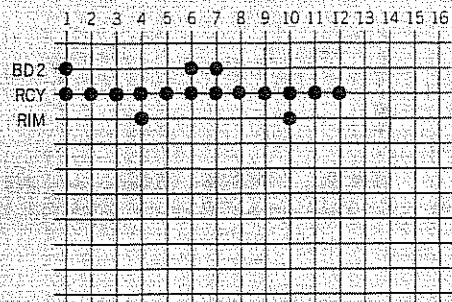

SCALE : 
 LAST STEP : 12
 SHUFFLE :
 ★FLAM :



A-10 シャッフル Shuffle

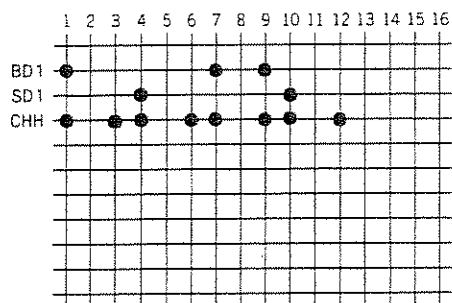

SCALE : 
 LAST STEP : 12
 SHUFFLE :
 ★FLAM :



A-11 ファンキー1 Funky 1

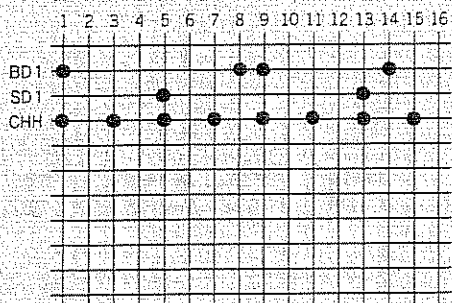

SCALE : 
 LAST STEP : 16
 SHUFFLE : 2
 ★FLAM :



A-12 ファンキー2 Funky 2

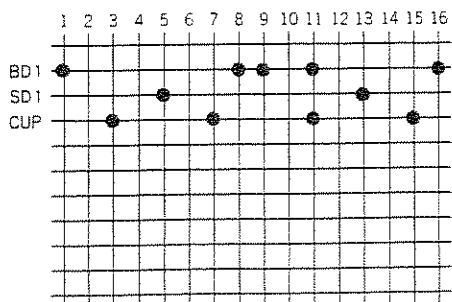

SCALE : 
 LAST STEP : 16
 SHUFFLE : 2
 ★FLAM :

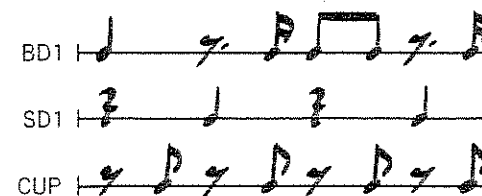

B-1 スウィング1 Swing 1

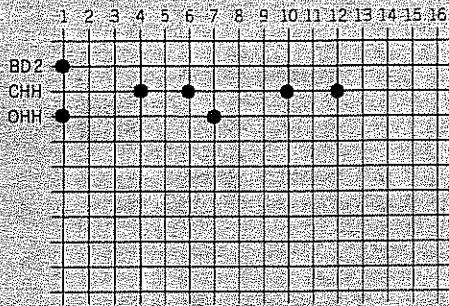

SCALE : 
 LAST STEP : 12
 SHUFFLE :
 ★FLAM :



B-2 スウィング2 Swing 2

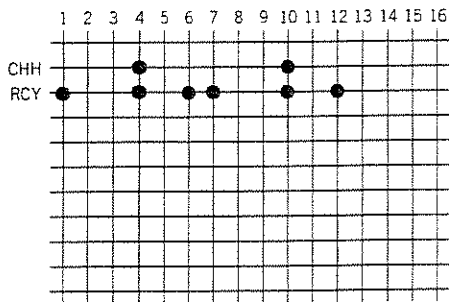

SCALE : 
 LAST STEP : 12
 SHUFFLE :
 ★FLAM :



B-3 ボサノバ1 Bossanova 1

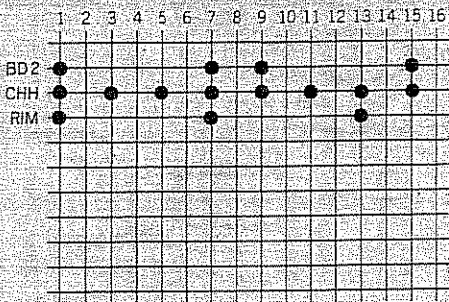

SCALE : 
 LAST STEP : 16
 SHUFFLE :
 ★FLAM :

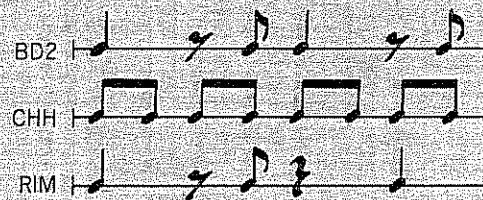

B-4 ボサノバ2 Bossanova 2

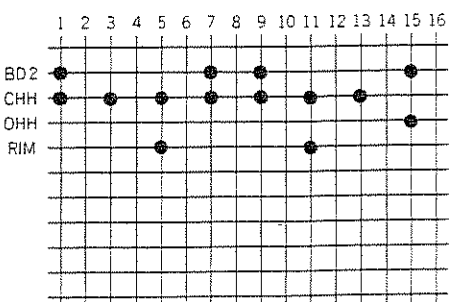

SCALE : 
 LAST STEP : 16
 SHUFFLE :
 ★FLAM :

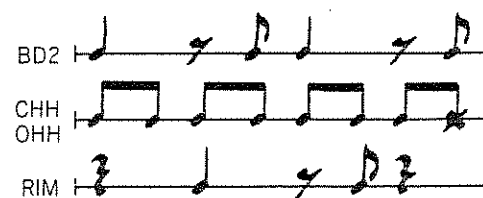

B-5 マンボ Mambo

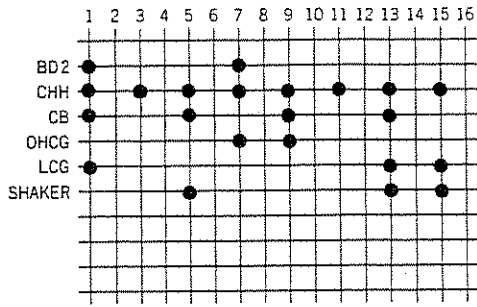

SCALE :
 LAST STEP : 16
 SHUFFLE :
 ★FLAM :

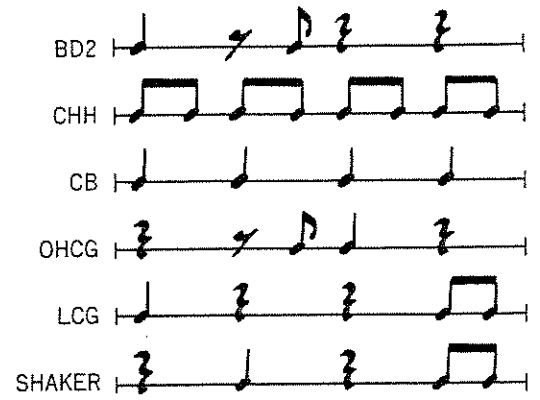

B-6 メレンゲ Merengue

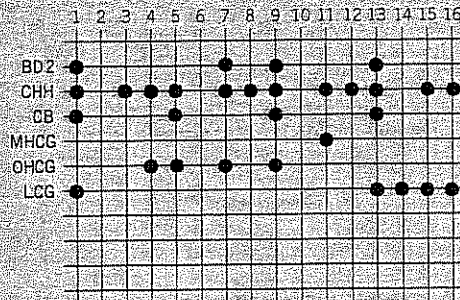

SCALE :
 LAST STEP : 16
 SHUFFLE :
 ★FLAM :

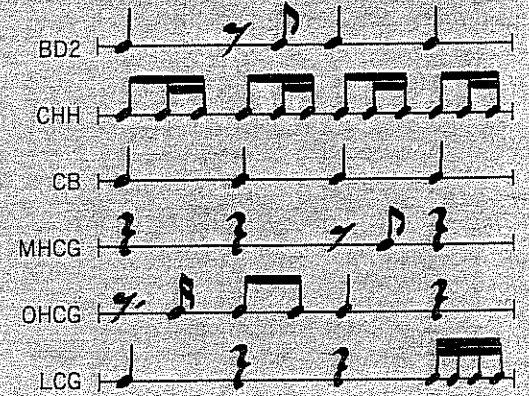

B-7 ルンバ Rhumba

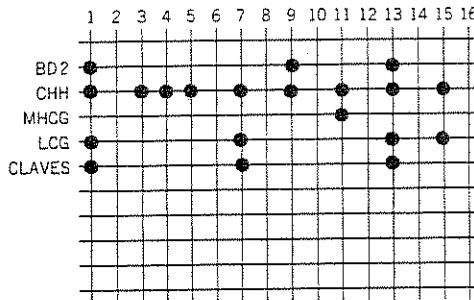

SCALE :
 LAST STEP : 16
 SHUFFLE :
 ★FLAM :

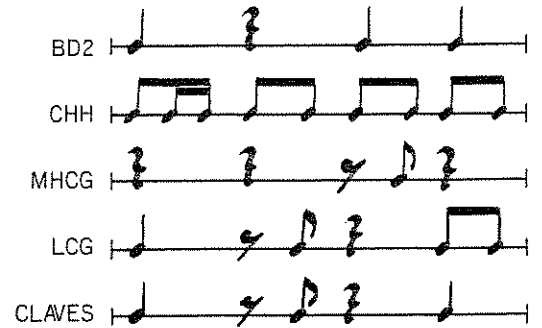

B-8 ビギン Beguine

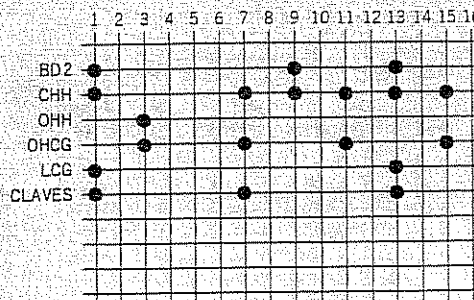

SCALE :
 LAST STEP : 16
 SHUFFLE :
 ★FLAM :



B-9 サンバ1 Samba 1

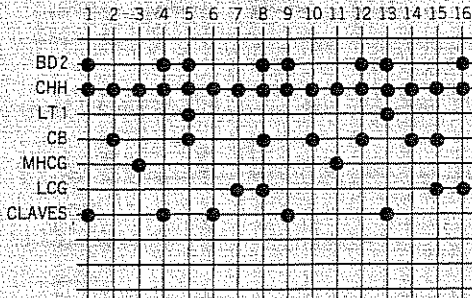

SCALE :

LAST STEP : 16

SHUFFLE :

★FLAM :

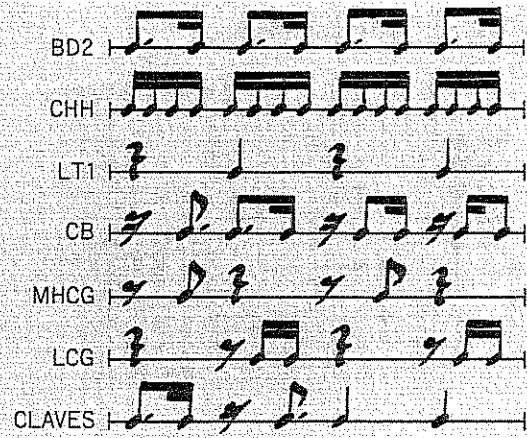

B-10 サンバ2 Samba 2

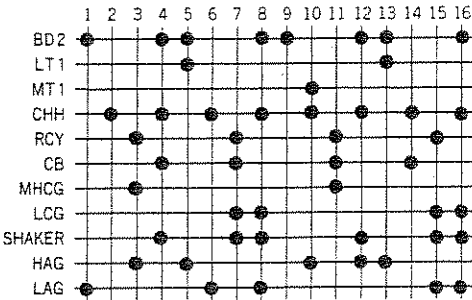

SCALE :

LAST STEP : 16

SHUFFLE :

★FLAM :

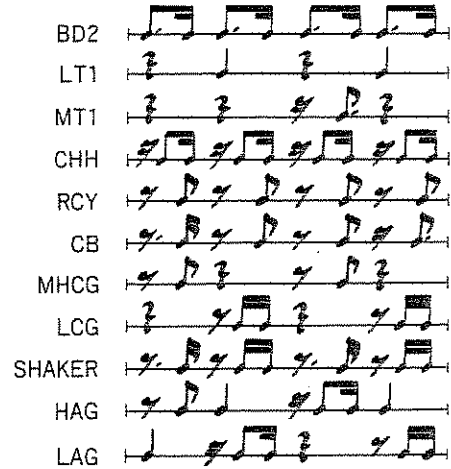

B-11 タンゴ Tango

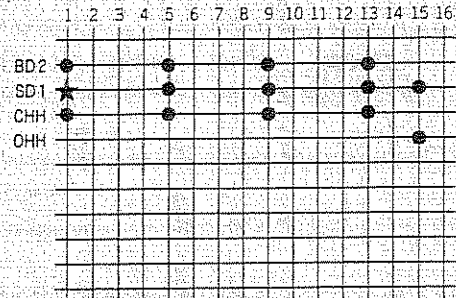

SCALE :

LAST STEP : 16

SHUFFLE :

★FLAM : 2

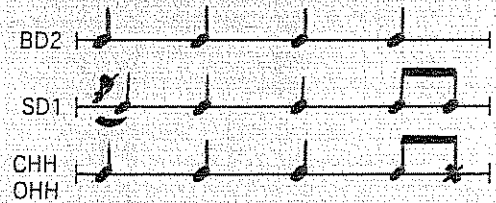

B-12 マーチ Marching

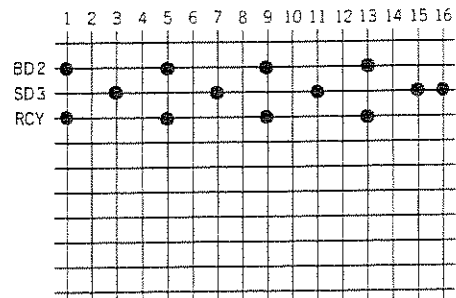

SCALE :

LAST STEP : 16

SHUFFLE :

★FLAM :

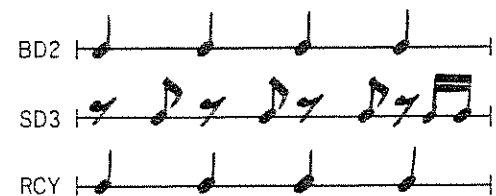

B-13 スウィング・フィル・イン Swing Fill-in

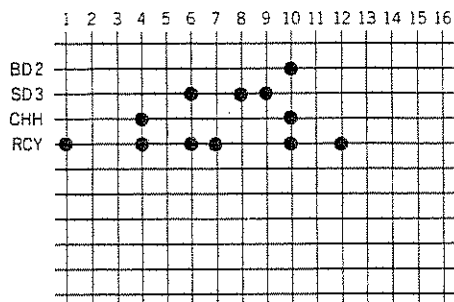

SCALE :
 LAST STEP : 12
 SHUFFLE :
 ★FLAM :



B-14 ラテン・フィル・イン Latin Fill-in

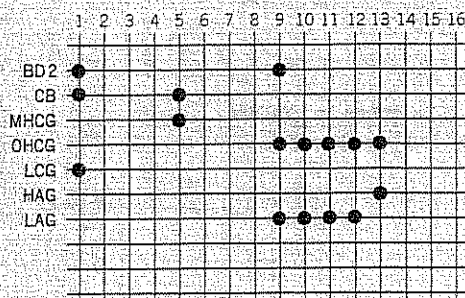

SCALE :
 LAST STEP : 16
 SHUFFLE :
 ★FLAM :

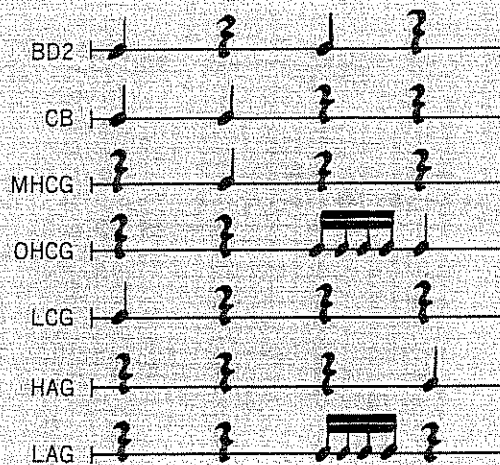

B-15 ラテン・ブレイク Latin Break

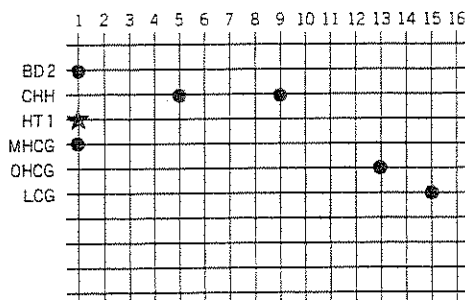

SCALE :
 LAST STEP : 16
 SHUFFLE :
 ★FLAM : 1

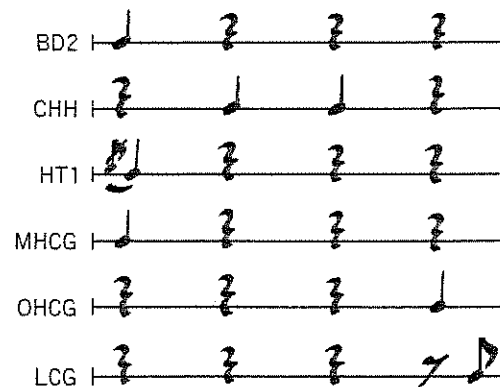

B-16 サンバ・フィル・イン Samba Fill-in

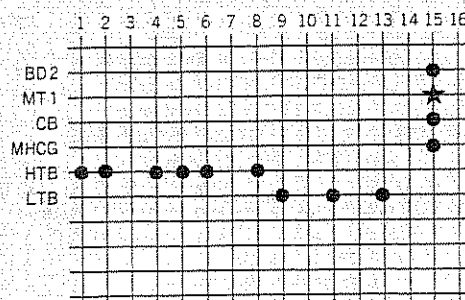

SCALE :
 LAST STEP : 16
 SHUFFLE :
 ★FLAM : 1

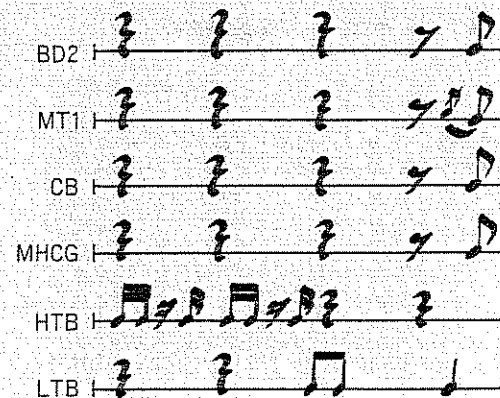

C-1 オールディーズ1 Oldies 1

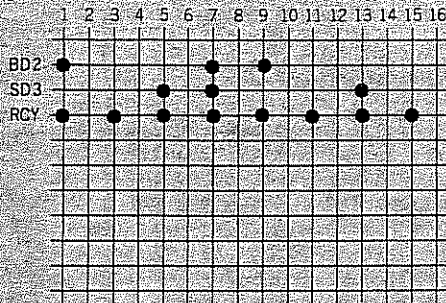

SCALE :

LAST STEP : 16

SHUFFLE :

★FLAM :

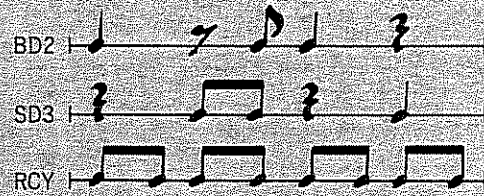

C-2 オールディーズ2 Oldies 2

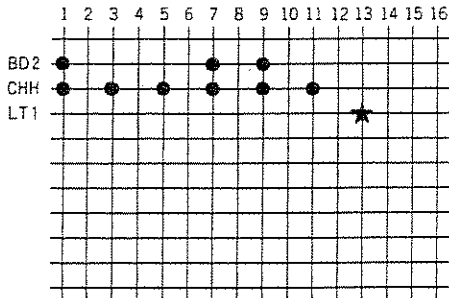

SCALE :

LAST STEP : 16

SHUFFLE :

★FLAM : 1



C-3 オールディーズR&B Oldies R&B

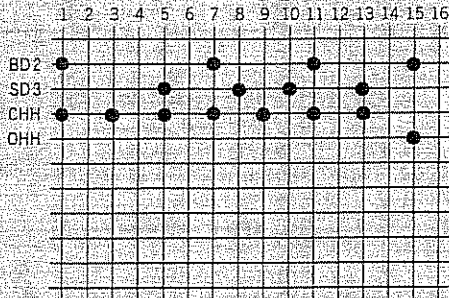

SCALE :

LAST STEP : 16

SHUFFLE : 2

★FLAM :

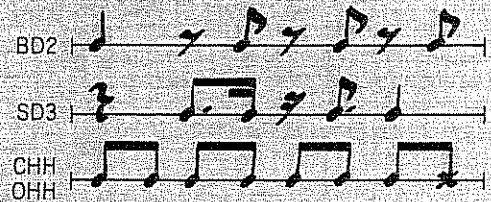

C-4 レゲエ1 Reggae 1

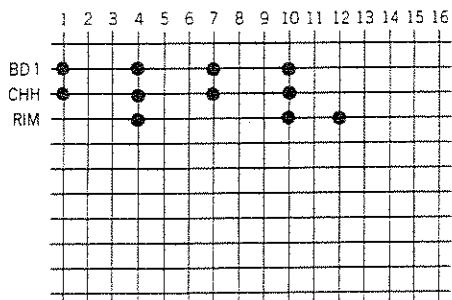

SCALE :

LAST STEP : 12

SHUFFLE :

★FLAM :

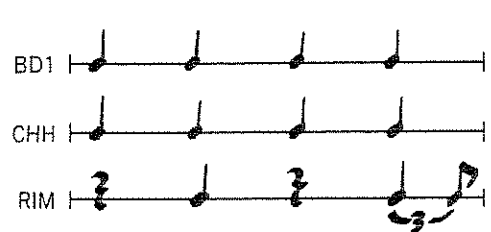

C-5 レゲエ 2 Reggae 2

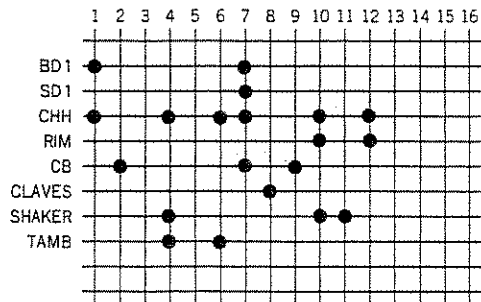

SCALE :

LAST STEP : 12

SHUFFLE :

★FLAM :

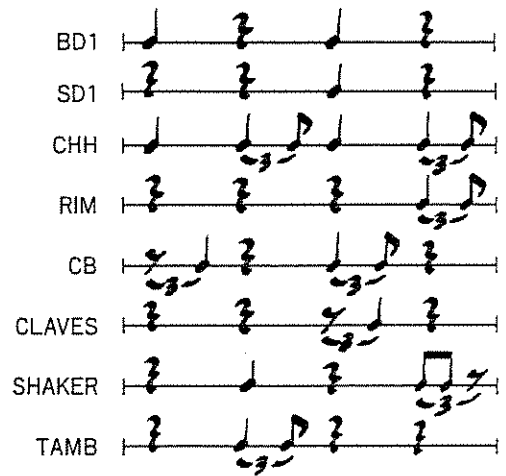

C-6 ラップ Rap

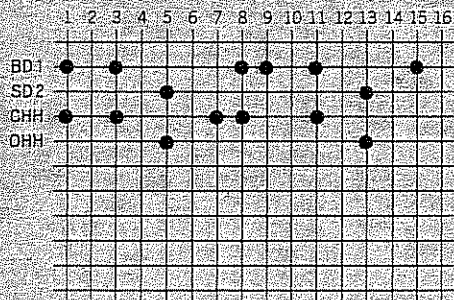

SCALE :

LAST STEP : 16

SHUFFLE :

★FLAM :

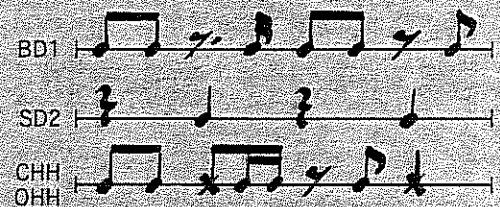

C-7 ヒップ・ホップ Hip Hop

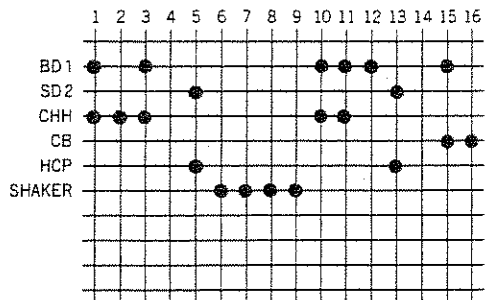

SCALE :

LAST STEP : 16

SHUFFLE :

★FLAM :



C-8 エレクトリック・ファンク Electric Funk

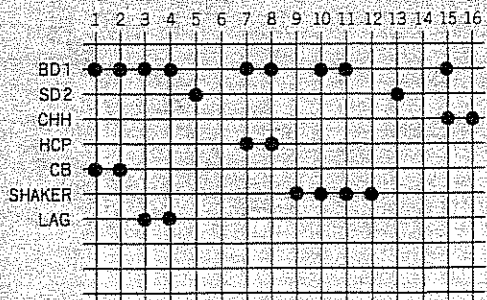

SCALE :

LAST STEP : 16

SHUFFLE :

★FLAM :

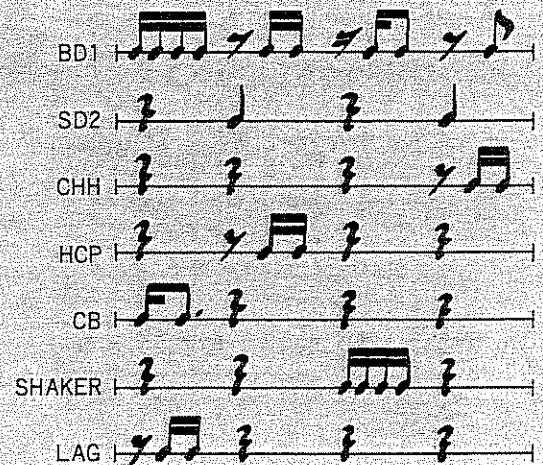

C-9 メタル1 Metal 1

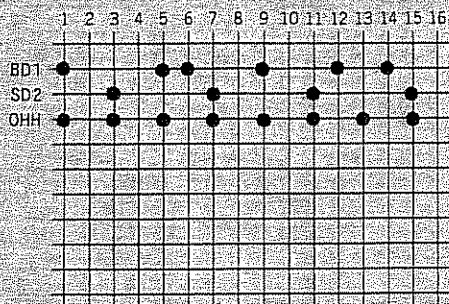

SCALE :
 LAST STEP : 16
 SHUFFLE :
 ★FLAM :

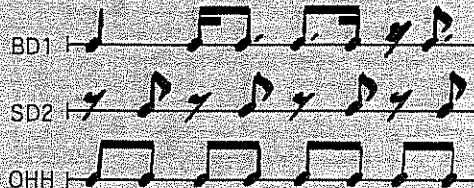

C-10 メタル2 Metal 2

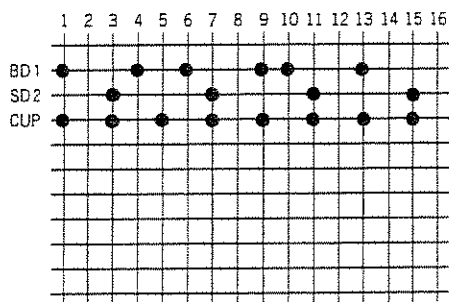

SCALE :
 LAST STEP : 16
 SHUFFLE :
 ★FLAM :



C-11 ロック・バリエーション1 Rock Vari. 1

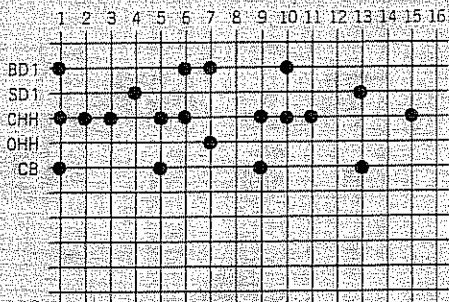

SCALE :
 LAST STEP : 16
 SHUFFLE : 1
 ★FLAM :



C-12 ロック・バリエーション2 Rock Vari. 2

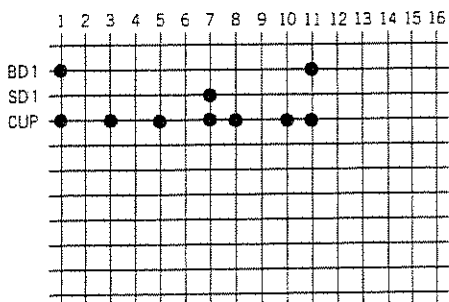

SCALE :
 LAST STEP : 12
 SHUFFLE :
 ★FLAM :



C-13 レゲエ・フィル・イン Reggae Fill-in

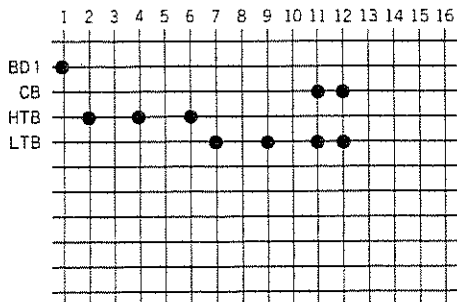

SCALE :
 LAST STEP : 12
 SHUFFLE :
 ★FLAM :

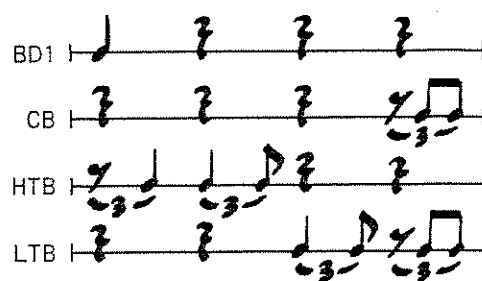

C-14 エレクトリック・フィル・イン Electric Fill-in

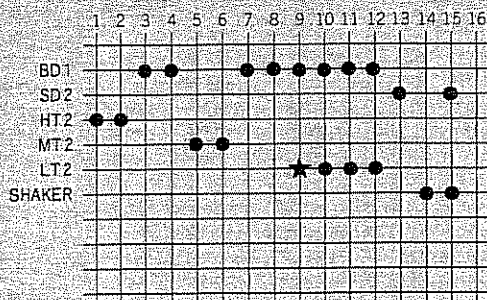

SCALE :
 LAST STEP : 16
 SHUFFLE :
 ★FLAM : 4



C-15 メタル・フィル・イン Metal Fill-in

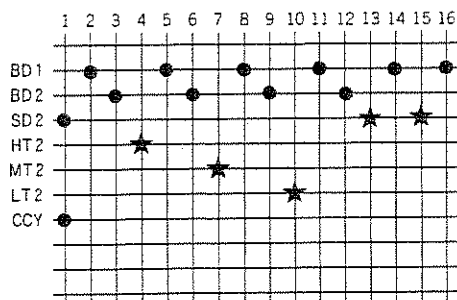

SCALE :
 LAST STEP : 16
 SHUFFLE :
 ★FLAM : 1

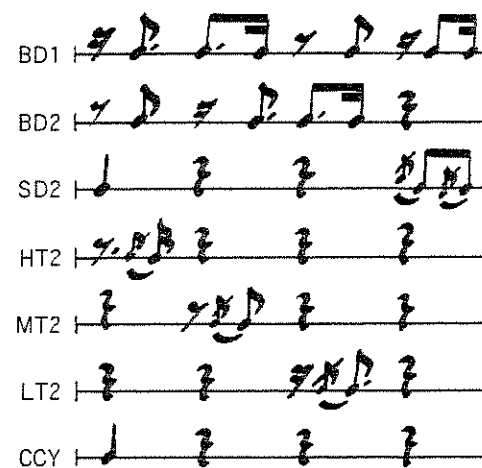

C-16 カウント・クリック Count Click

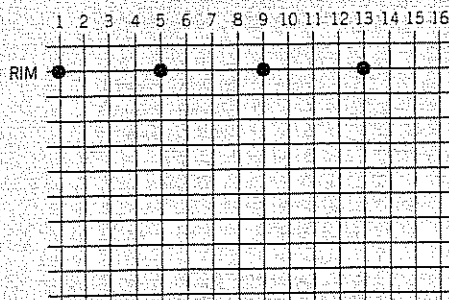

SCALE :
 LAST STEP : 16
 SHUFFLE :
 ★FLAM :

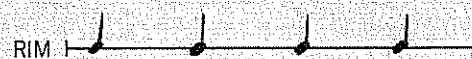

 Roland®

10477

UPC 10477



12991

 Roland

〒559 大阪市住之江区新北島3-7-13 代表 (06)681-5431

'87-10-C3-2S