

Roland Synthesizer

SYSTEM 100

**EXPANDER**

MODEL **102**

*INSTRUCTION MANUAL*

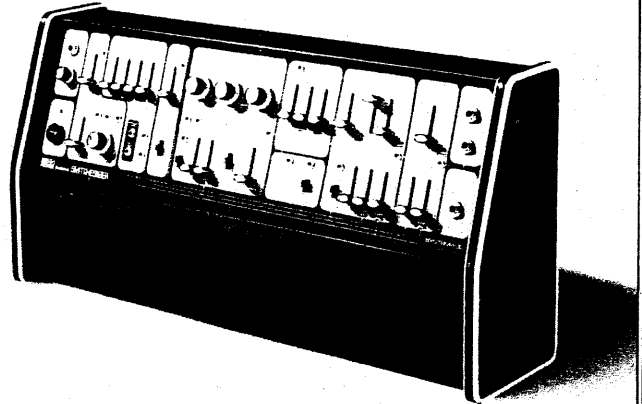

  
Roland

## CONTENTS

---

INTRODUCTION .....	3
AN IMPORTANT NOTE .....	3
1. USING THE EXPANDER UNIT .....	4
1-1-0 The ADSR or ENVELOPE GENERATOR .....	5
1-2-0 The VCO or VOLTAGE CONTROLLED OSCILLATOR ...	7
1-3-0 The VCF or VOLTAGE CONTROLLED FILTER .....	14
2. THE NEW ELEMENTS .....	19
2-1-0 The RING MODULATOR .....	19
2-2-0 The S/H or SAMPLE AND HOLD .....	23
3. IN CASE OF DIFFICULTY .....	28
3-1-0 Troubles .....	28
3-2-0 Things to remember .....	28
THE LAST WORD .....	29
SPECIFICATIONS .....	30
INSTANT INDEX	
INDEX TO TERMS .....	31

---

## INTRODUCTION

Although it is designed as a part of the ROLAND System 100, the Model 102 Expander Unit can be used for greatly expanding the possibilities of almost any 1 volt per octave synthesizer. While it doubles the number of basic elements contained in the Model 101 Synthesizer, it more than doubles the sound synthesizing capabilities, especially with the inclusion of the RING MODULATOR and SAMPLE AND HOLD.

It may be of interest to note that in our test laboratories we tried using two Expander Units with the Model 101 Synthesizer and were able to come up with some surprisingly good sounds. (The gate pulse and keyboard control voltage were fed to the second Expander Unit from the COMPUTER jacks on the back of the synthesizer).

## AN IMPORTANT NOTE . . . . .

In this manual, all elements of the synthesizer are suffixed with a number. "1" means Model 101 Synthesizer elements; "2" means Model 102 Expander Unit elements.

Example: VCO-1 = Model 101 Synthesizer VCO  
VCO-2 = Model 102 Expander Unit VCO.

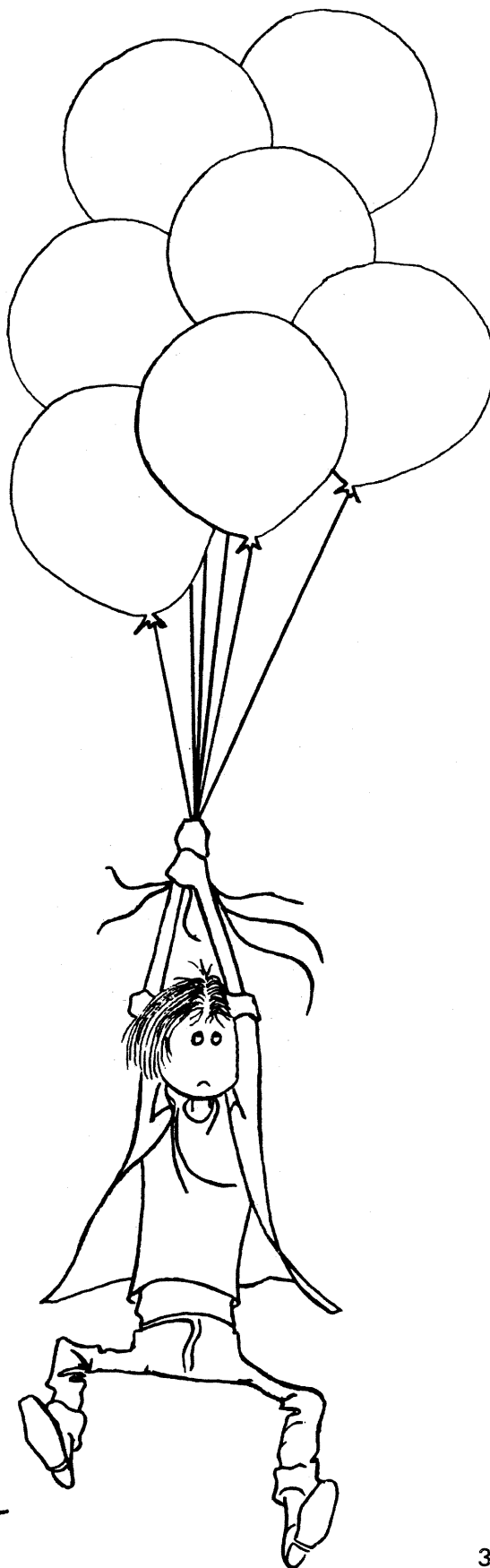

*W.W. Keaton*

# 1. USING THE EXPANDER UNIT

## 1-0-1 Before we begin . . . . .

The Model 102 Expander Unit is designed to stand up behind the main Model 101 Synthesizer.

Fig. 1-1

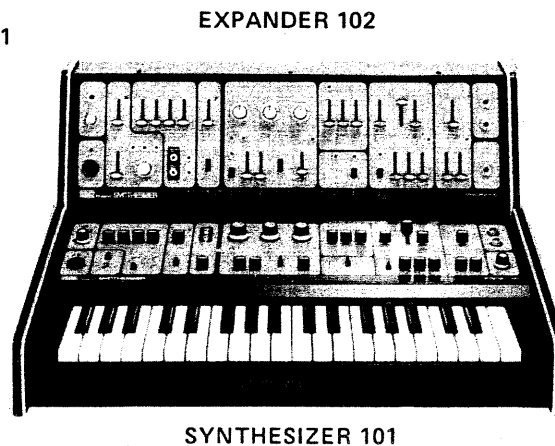

Attach the enclosed masonite panel to the bottom of the Expander Unit as shown in fig. 1-2.

## 1-0-2 The POWER switches . . . . .

Note that both the 101 Synthesizer and 102 Expander Unit have their own POWER switches and that both switches have to be ON in order to use both units.

## 1-0-3 Connections . . . . .

Fig. 1-3 shows how to connect the two units together and to your amplifier.

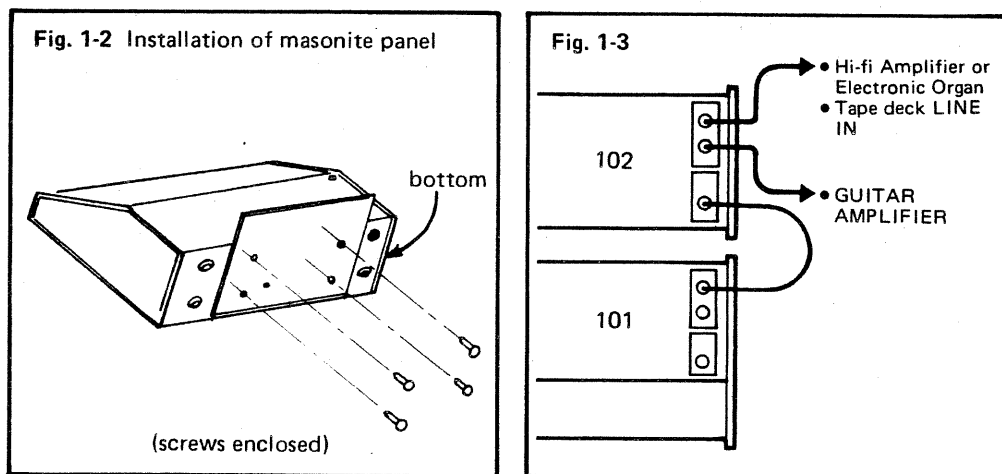

## 1-0-4 Headphones . . . . .

In order to monitor the output of both units, use the PHONES jack and LEVEL control on the Model 102 Expander Unit.

## 1-1-0 The ADSR or ENVELOPE GENERATOR

Fig. 1-4

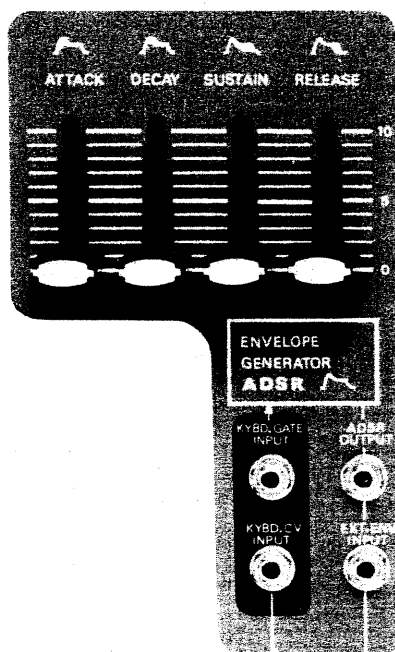

ADSR-2 is exactly the same as ADSR-1 except that the gate pulse connection is made externally through a patch cord. (The clock pulse from the S/H is the only internal connection for triggering ADSR-2; see 2-2-1).

### 1-1-1 Experimenting with the two ADSR's . . . . .

In Patch 25 (ADSR Test), the 101 Synthesizer and the 102 Expander Unit are set to produce two different qualities of sound to make it easier to hear the control and effects of the four ways to connect the two ADSR's.

Set Patch 25a. Striking a key on the keyboard will show that ADSR-1 is controlling both units.

Set Patch 25b. Striking a key now will show that both ADSR's have separate control of their own units.

Set Patch 25c. In this patch, ADSR-2 controls both units.

Set Patch 25d. In this patch, each ADSR controls the opposite unit. There is no advantage to this arrangement, so it is of little value except as an experiment.

### 1-1-2 The delayed vibrato . . . . .

Patch 8 (Delayed Vibrato) shows how you can use ADSR-2 to induce a delayed vibrato effect into any patch set on the 101 Unit. The violin sound (Patch 34, MODEL 101 SYNTHESIZER PATCH BOOK) is a good patch to try this with.

### 1-1-3

#### How it works . . . . .

There is no connection to the 102 Unit KYBD CV INPUT jack, so VCO-2 receives no control voltage from the keyboard.

The VCO-2 FREQUENCY control is set at the low end of the scale so VCO-2 acts as an LFO for modulating VCO-1.

The output at VCA-2 is a sine wave (refer to Patch 45 (Sine Wave), MODEL 101 SYNTHESIZER PATCH BOOK). This low frequency sine wave is used to modulate VCO-1 by means of the patch cord and the VCO-1 EXT CV slider to produce the vibrato effect.

The keyboard gate pulse triggers ADSR-2, which controls the amplitude of the output of VCA-2. The ADSR-2 ATTACK time will determine the amount of delay before the full vibrato is allowed to pass through VCA-2.

### 1-1-4

#### The snare drum . . . . .

Try Patch 14 (Snare Drum). This is a typical patch which depends on the mixing of the outputs of both units to produce one sound.

The 101 Unit generates the rattling of the snares and the 102 Unit generates the drum "tone".

The two VCA ADSR controls should be adjusted so as to get the proper balance between the two elements of the drum sound.

## 1-2-0 The VCO or VOLTAGE CONTROLLED OSCILLATOR

Fig. 1-5



The keyboard control voltage connection to VCO-2 is made externally through a patch cord (see Patch 25).

In many patches, the VCO's must be tuned in relation to each other.

### 1-2-1 Unison tuning . . . . .

Tuning the VCO's to unison and setting up the same patch on both units gives a "chorus" effect as when two or more instruments are playing.

Try Patch 17 (String Orchestra). To tune, start with the VCA-2 controls at "0" and tune VCO-1 in the normal way.

Turn off the test OSCILLATOR, raise the VCA-2 ADSR control and tune VCO-2 to unison with VCO-1.

Use slightly different LFO rates to increase the feeling of more than one violin.

Also, try tuning the VCO's so that they are not exactly in tune with each other to get the effect of a group of violinists who are not playing exactly the same pitches.

Try using the pulse wave from one or both VCO's. Try LFO modulation of one or both pulse waves and try different LFO rates with different PULSE WIDTH control settings.

Try varying the ADSR and VCF settings slightly.

### 1-2-2

#### Octave tuning . . . . .

Try Patch 17 (String Orchestra) with the VCO's tuned to the interval of one or two octaves. Use the two VCA ADSR controls to try different balances in sound.

### 1-2-3

#### The vibraphone . . . . .

Patch 21 (Vibraphone) is a good example of a patch which combines slightly different settings of the synthesizer elements to produce one single but more complicated sound (as opposed to "group" or "chorus" sounds). Note that in this patch the VCA-1 ADSR control should be set a little higher than the VCA-2 ADSR control.

### 1-2-4

#### Other intervals . . . . .

Try intervals other than octaves with the String Orchestra patch.

Also, try some of the above tuning experiments with Patch 9 (Flute + Violin).

### 1-2-5

#### VCO synchronization . . . . .

The output of the VCO SYNC OUTPUT jack (VCO-1) is a square wave (bottom of fig. 1-6) whose frequency is equal to the frequency output of VCO-1. This square wave can be used to force the frequency of VCO-2 to follow the frequency of VCO-1. (This is called tracking).

### 1-2-6

#### Strong sync . . . . .

Set Patch 27 (VCO Strong Sync Test). Before inserting the sync patch cord, tap middle A and tune VCO-2 to unison with VCO-1. You will find that no matter how perfectly you tune the VCO's, they will eventually drift off frequency just enough to cause the sound to "roll" slightly. In some patches, this is actually a desirable feature, but in others it is undesirable.

Try inserting the sync patch cord and the frequency of VCO-2 locks right on to the frequency of VCO-1.

Try moving the VCA-2 INITIAL GAIN control up and down and you can hear the feeling of added power (rather than a "chorus" effect) in the output sound.

Try turning the VCO-2 FREQUENCY control counter clockwise all the way down to the 10 HZ position and you'll find that the frequency output of VCO-2 does not change, although the power output goes down. (See fig. 1-6a, b, c).

Remove the sync patch cord and tune VCO-2 to unison with VCO-1 again, then replace the cord. Try a few notes on the keyboard and you'll find that VCO-2 will track with VCO-1 no matter what key you play.

Tap middle A and move the VCA-1 INITIAL GAIN control to "0", then try slowly turning the VCO-2 FREQUENCY control clockwise.



Fig. 1-6 VCO sync wave forms for the sawtooth wave.

(h) Wave form  
(g) + (a)



(g) Output of VCO-2  
when tuned about 9  
octaves above VCO-1



(f) Output of VCO-2  
when tuned to slightly  
above one octave  
above VCO-1



(e) Output of VCO-2  
when tuned to one  
octave above VCO-1

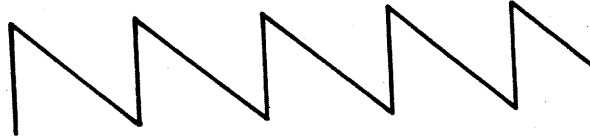

(d) Output of VCO-2  
when tuned to slightly  
above VCO-1

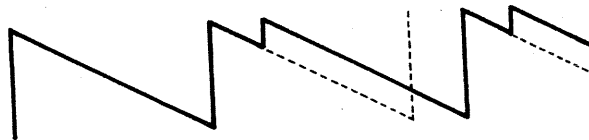

(c) Output of VCO-2  
when tuned to unison  
with VCO-1



(b) Output of VCO-2  
when tuned lower  
than unison with  
VCO-1

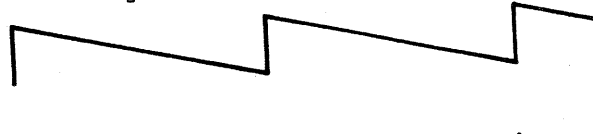

(a) Output of VCO-1

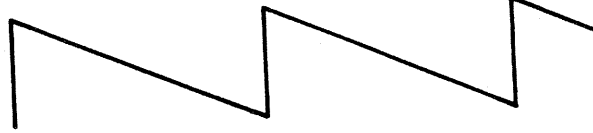

VCO-1 sync output

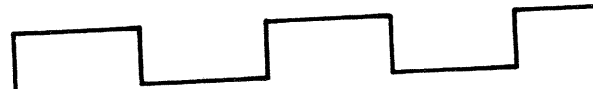

The first thing you may notice is that although the basic pitch remains the same (remember that with the VCA-1 INITIAL GAIN control at "0", you can't hear the output of VCO-1), the harmonic content of the output changes as you turn the FREQUENCY control. Fig. 1-6 shows this.

#### 1-2-7 The wave forms . . . . .

The dotted lines in fig. 1-6 show what the VCO-2 wave forms would look like if it weren't for the effect of the sync from VCO-1.

As a result of the sync, each time the VCO-1 wave jumps up to its high level, it also forces VCO-2 to jump up to its high point and start its own wave all over again.

#### 1-2-8 The pitches . . . . .

This forcing of VCO-2 to begin its wave over again each time VCO-1 starts a new cycle causes the ear to hear the same basic pitch (the VCO-1 pitch) continuously as the VCO-2 FREQUENCY control is turned up. This basic pitch gets weaker, however, the higher you go.

Not only that, but "under" this basic pitch you can hear the pitch that VCO-2 is trying to generate. This gets clearer the higher you get with the VCO-2 FREQUENCY control. Fig. 1-6g shows this. Here, VCO-2 is tuned about nine octaves above VCO-1. Notice that VCO-1 still influences VCO-2, but its influence comes much less often in relation to the wave VCO-2 is trying generate. In other words, VCO-2 is able to generate quite a few complete cycles of its own wave before the VCO-1 sync gives it a kick. This makes the VCO-2 pitch much easier to hear.

Try this. Move the VCO-2 FREQUENCY control to some rather high point. Remove the sync patch cord and you can clearly hear the pitch being generated by VCO-2. Keep this pitch in mind as you replace the patch cord and you can hear that the VCO-2 pitch still remains even though you can also hear the basic VCO-1 pitch now.

Try moving the sync patch cord jack in and out of its plug with the VCO-2 FREQUENCY control at different points and you can see that as you get nearer unison, the pitch that VCO-2 is trying to generate gradually submerges into the overall tone color.

#### 1-2-9 Variations . . . . .

Try experimenting with the two VCO's using different sources of control voltage on one or both VCO's (via the VCO EXT CV jacks and VCO LFO controls). Patch 29 (Sync Tone Color Experiment) is a good patch to try this with.

#### 1-2-10 Weak sync . . . . .

Plugging the sync patch cord into the WEAK VCO SYNC jack (VCO-2) produces a weaker coupling of the sync signal to VCO-2. The result is that VCO-2 will track only at certain intervals which are multiples of the VCO-1 frequency.

**1-2-11 Weak sync patch . . . . .**

Try Patch 28 (VCO Weak Sync Test). Before plugging in the sync patch cord, tune VCO-2 to unison with VCO-1. Plug in the sync patch cord and the frequencies may lock. If not, move the VCO-2 FINE TUNING control slightly counter clockwise.

Tap middle A, then slowly turn the VCO-2 FREQUENCY control down. You'll notice that the frequency of VCO-2 will progress downwards almost in steps of different intervals with a "rolling" effect between these steps. These "rolling" places are settings where VCO-2 will not track with VCO-1.

Try also turning the VCO-2 FREQUENCY control slowly upwards to the 10 KHZ position.

**1-2-12 Tracking . . . . .**

With strong sync, VCO-2 will always track with VCO-1 no matter what the frequency ratio (musical interval) is.

With weak sync, VCO-2 will track with VCO-1 only on certain perfect and major intervals.

When tuning VCO-2 to unison or octaves above VCO-1, use strong sync, but tune the VCO's before inserting the sync patch cord if you want to avoid the sound quality caused by the distortions of slight mistunings (as in fig. 1-6d, f). At more than one octave above VCO-1, you will probably be able to find other intervals where VCO-2 will track. (For example, 1 octave + perfect fifth as in Patch 7 (Clarinet), explained in 1-2-15).

For other intervals (where you don't want the distortion noted above) use weak sync. VCO-2 will usually track when tuned to most perfect and major intervals.

NOTE: Sometimes you may have to readjust the VCO-2 FINE TUNING slightly to get VCO-2 to track accurately for the full range of the keyboard.

**1-2-13 Accenting given harmonics . . . . .**

From the above, it can be seen that VCO-2 can be used to increase the intensity of the fundamental or any one of the other harmonics in a sound, since the sync will eliminate VCO frequency drift.

Try Patch 11 (horn). The output of VCO-2 is fed into the EXT INPUT of AUDIO MIXER-1. The triangular wave is close to a sine wave in shape and serves to strengthen the fundamental of the horn tone.

**1-2-14 Synthesis . . . . .**

When you take a wave form rich in harmonics such as a saw-tooth or square wave and use a filter (the VCF, for example) to filter out unwanted harmonics, you are using subtractive synthesis.

If you take a number of sine waves and combine them in the proper frequencies and amplitudes so as to produce a certain sound with its proper harmonic spectrum, you are using additive synthesis.

Subtractive synthesis is usually the less complicated of the two and is therefore the more common.

#### 1-2-15 Additive synthesis . . . . .

With the VCO sync function, it is possible to do a certain amount of additive synthesis. Patch 7 (Clarinet) is an example of this.

Start with the AUDIO MIXER-1 EXT INPUT slider at "0", tap middle A on the keyboard and tune VCO-1 to unison with the test signal.

When you play middle A, you want VCO-2 to produce the E one octave and a fifth above this, so tap this E key and make a mental note of the pitch. Lower the AUDIO MIXER-1 VCO slider and raise the EXT INPUT slider (with the sync patch cord removed). Strike middle A and tune VCO-2 to the pitch noted above. Change sliders and keys on the keyboard until the VCO-2 pitch is correct, then raise the AUDIO MIXER-1 VCO and EXT INPUT controls and use the VCO-2 FINE TUNING to eliminate the beat. Plug in the sync patch cord.

#### 1-2-16 How it works . . . . .

This patch is a good example of limited additive synthesis.

Fig. 1-7e (same as fig. 1-25, MODEL 101 SYNTHESIZER INSTRUCTION MANUAL) shows the wave form produced by a real clarinet.

You'll notice that the overall shape of the wave is square, so we started with a square wave from VCO-1, with the VCF-1 CUTOFF FREQUENCY at about "3.5" to round off the corners of the square wave as shown in fig. 1-7c.

We also used a square wave output from VCO-2 and the result after passing through VCF-2 is shown in fig. 1-7a.

Fig. 1-7b shows what the wave from VCO-2 looks like after passing through VCF-1. This, combined with the output of VCO-1, produces the total wave form shown in fig. 1-7d, which is pretty close to the true clarinet wave.

All the above was done in our laboratory using an oscilloscope. Even without an oscilloscope, experimenting should show you many ways you can use additive synthesis.

Fig. 1-7 Wave forms of Patch (Clarinet)

(a) Output of VCF-2

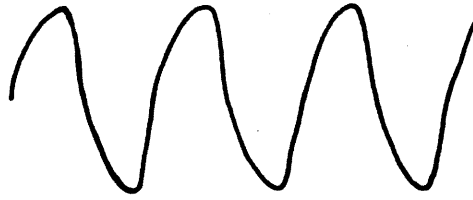

(b) Output of VCF-1  
(VCO-2 wave only)

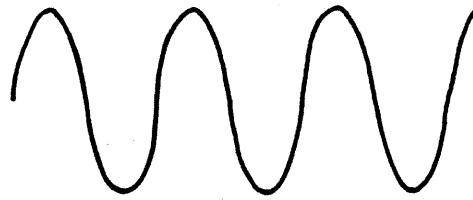

(c) Output of VCF-1  
(VCO-1 wave only)

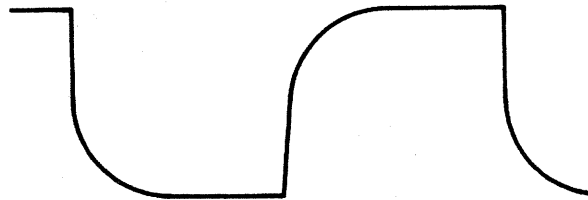

(d) Total output of  
VCF-1  
(b + c)

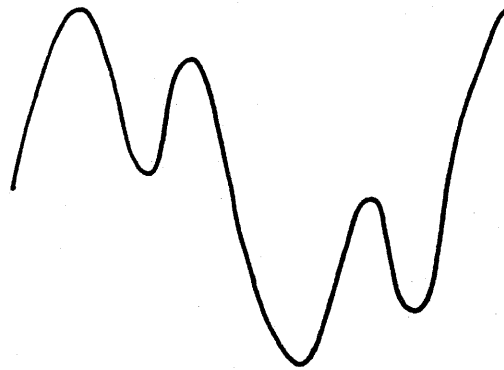

(e) True clarinet wave  
form (sounding D<sub>4</sub>)

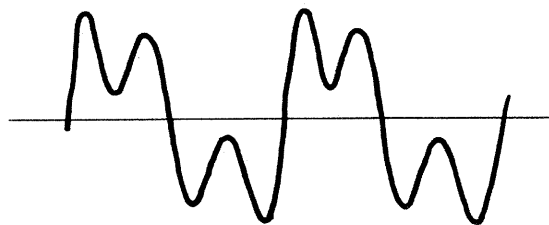

**1-3-0 The VCF or VOLTAGE CONTROLLED FILTER**

Fig. 1-8

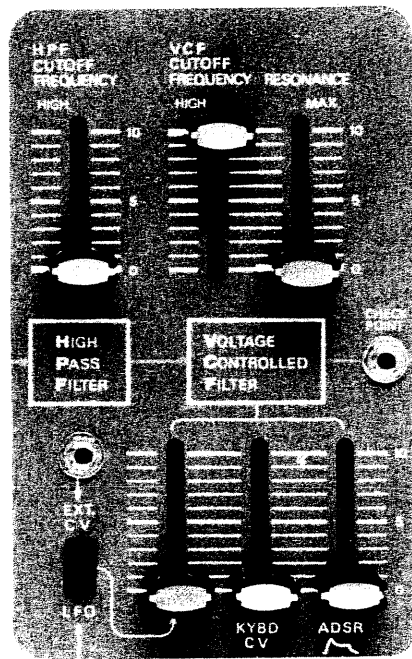

A group of scientists worked all through the fifties trying to electronically produce human voices for use in computers. This research was considered a failure because they never came up with a talking machine. This would not be worth mentioning except for the fact that the scientists found that the basic components they developed were good for making music.

Thus, the present day voltage controlled synthesizer was born.

**1-3-1 Two VCF's . . . . .**

From the above, you can gather correctly that the production of voice sounds is quite complex, however it can be done to a limited degree using two VCF's. We will try to keep this as simple as possible by approaching it from the electronic point of view without trying to explain any of the physics of the human voice system.

With two VCF's in parallel (fig. 1-9), set within the ranges shown in fig. 1-10, the synthesizer can produce passable vowel sounds.

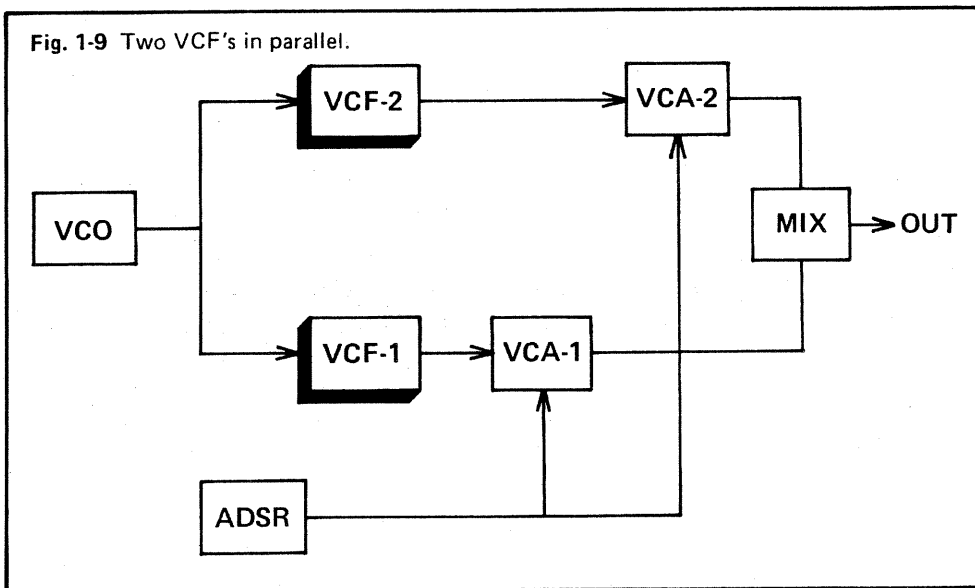

1-3-2

How to do it . . . . .

Start by setting Patch 3 (Basic Vowel Patch), then set the VCF CUTOFF FREQUENCY controls as shown in fig. 1-10 for the frequencies of the vowel sound you want to produce.

For example, to produce the female "ō", set the VCF-1 CUTOFF FREQUENCY at between 450 Hz. and 750 Hz., and the VCF-2 CUTOFF FREQUENCY at between 700 Hz. and 1300 Hz. (or vice versa). The exact points will determine the voice quality.

Fig. 1-10 Filter settings for vowel sounds.

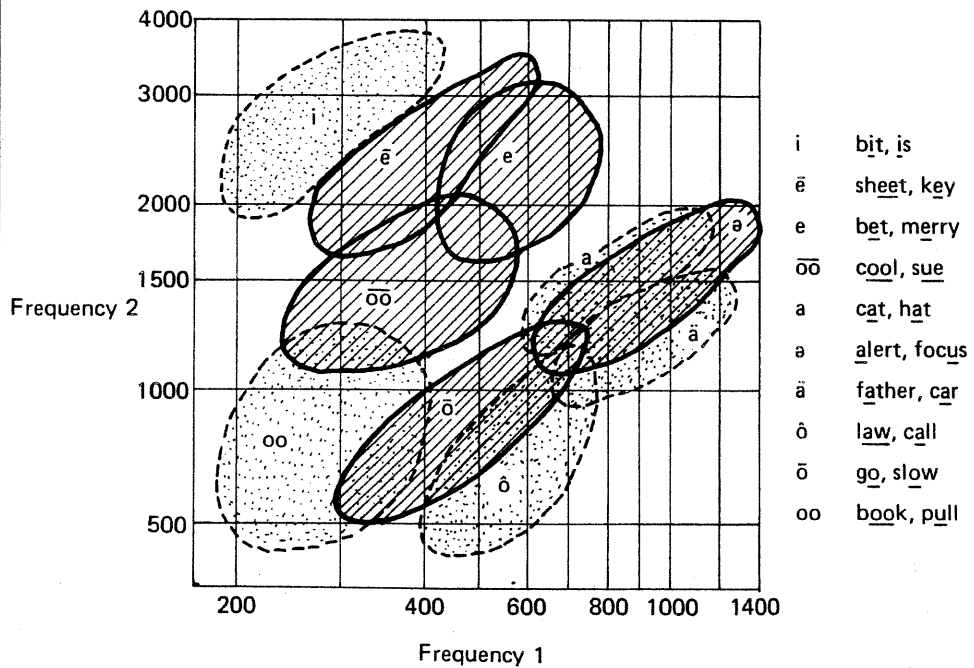

For female voices, use upper right portion of "balloons";  
for male voices, use lower left portion of "balloons".

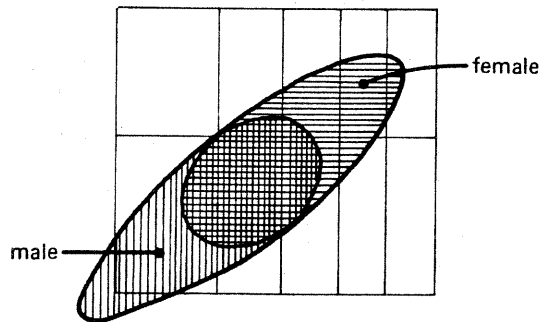

1-3-3 How to set the cutoff points . . . . .

Since the VCF can be made to oscillate, it is rather a simple matter to set the cutoff frequency of the filter accurately by comparing the output of the oscillating VCF with the pitches shown in fig. 1-11.





### 1-3-5

#### Pronunciation . . . . .

Even the pronunciation of simple sounds requires one or both of the VCF cutoff points to change during the pronunciation.

Fig. 1-12 shows the movement of the VCF cutoff point in order to reproduce the "ō" sounds of three different test subjects when they were asked to pronounce the word "Hiroshima".

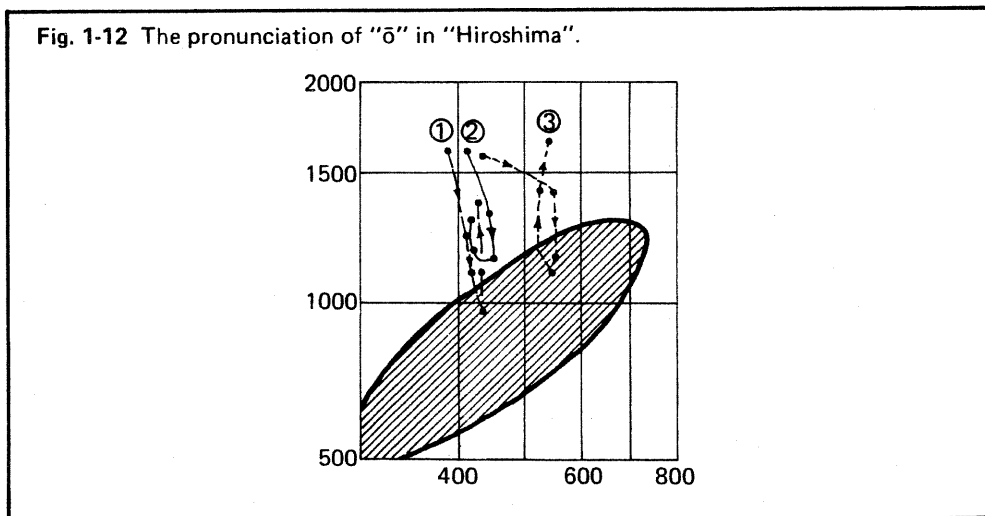

### 1-3-6

#### "You" . . . . .

Patch 23 ("You") shows how it is possible to use the ADSR's to help you move the VCF cutoff points automatically to a certain degree. If this patch is set up correctly, the synthesizer should pronounce a passable "you".

### 1-3-7

#### The sequencer . . . . .

With the Model 104 Sequencer Unit, it is possible to program the movement of the VCF cutoff points a little more freely, to a certain degree. (See 2-5-6, MODEL 104 SEQUENCER INSTRUCTION MANUAL).

### 1-3-8

#### Thunder . . . . .

Before we leave the VCF, try Patch 18 (Thunder), which is another example of using two VCF's.

The NOISE GENERATOR signal is used to modulate the oscillating VCF-2. ADSR-2 also modulates VCF-2 to give the first "crash" sound.

The output of VCF-2 is used to modulate the oscillating VCF-1. ADSR-1 also modulates VCF-1 and helps produce the sound of the thunder as it rolls off into the distance.

If you lower the VCA ADSR controls one at a time, you can hear these two elements of the thunder sound separately.

## 2. THE NEW ELEMENTS OF THE SYNTHESIZER

### 2-1-0 The RING MODULATOR

Fig. 2-1

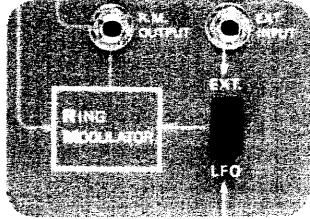

In the MODEL 101 SYNTHESIZER INSTRUCTION MANUAL we talked about two kinds of modulation.

### 2-1-1 Frequency modulation . . . . .

Frequency modulation (FM) is the variation of a frequency by a modulating signal, such as using the LFO to modulate the frequency output of the VCO to produce a vibrato effect. (1-6-1, p. 40; MODEL 101 SYNTHESIZER INSTRUCTION MANUAL).

Patch 5 (Bell) from the MODEL 101 SYNTHESIZER PATCH BOOK uses the VCO to modulate the oscillating VCF to produce bell-like sounds. The wave produced by this patch looks something like fig. 2-2.

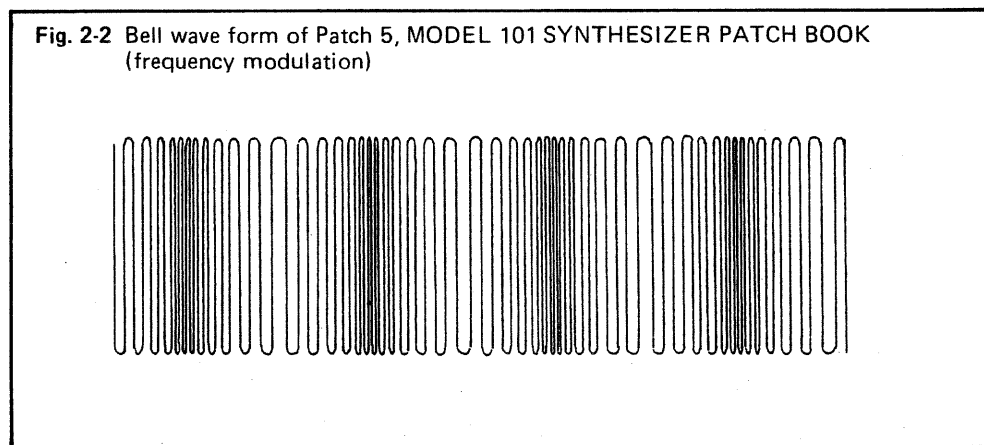

### 2-1-2 Amplitude modulation . . . . .

Amplitude modulation (AM) is the variation of the amplitude of a wave or sound by another signal, such as using the LFO to control the VCA to induce a tremolo effect in the output sound. (1-6-4, p. 42; MODEL 101 SYNTHESIZER INSTRUCTION MANUAL).

Set Patch 24 (AM Test). With the VCA-1 LFO control at "0", the output wave looks like fig. 2-3a.

Moving the VCA-1 LFO control to about "2" would produce the wave shown in fig. 2-3b.

Moving the VCA-1 LFO control up to "10" would produce the output shown in fig. 2-3c.

If it were possible to move the VCA-1 LFO control higher than "10", it would produce the output shown in fig. 2-3d. Notice the points of "silence".

### 2-1-3 The balanced modulator . . . . .

A balanced modulator puts the center of the modulating wave at the center of the modulated wave, as shown in fig. 2-3e. Real bells produce sound waves like this.

Another name for balanced modulator is ring modulator; the frequency relationships are shown in fig. 2-4.

Fig. 2-3 Amplitude modulation wave forms

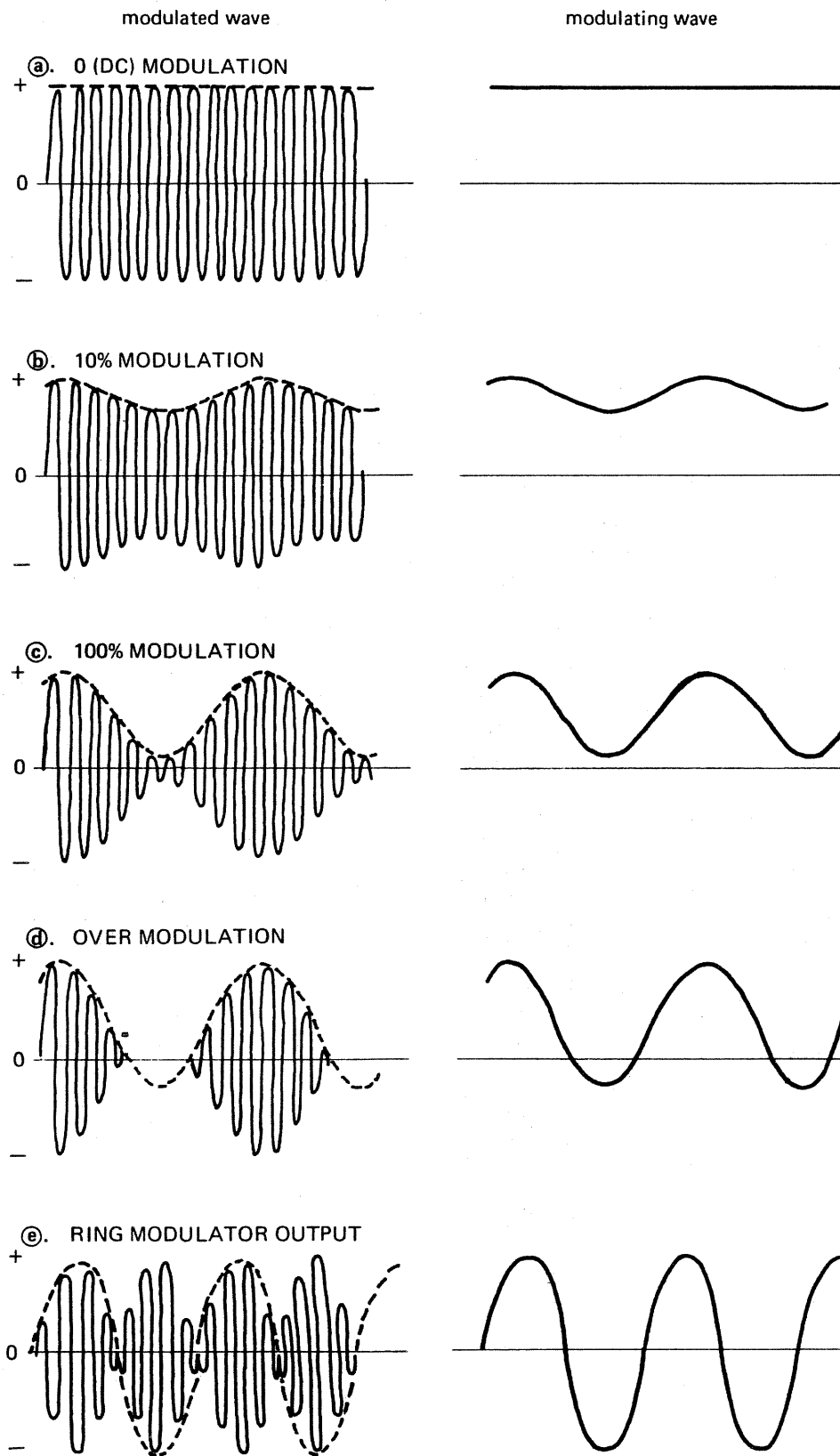

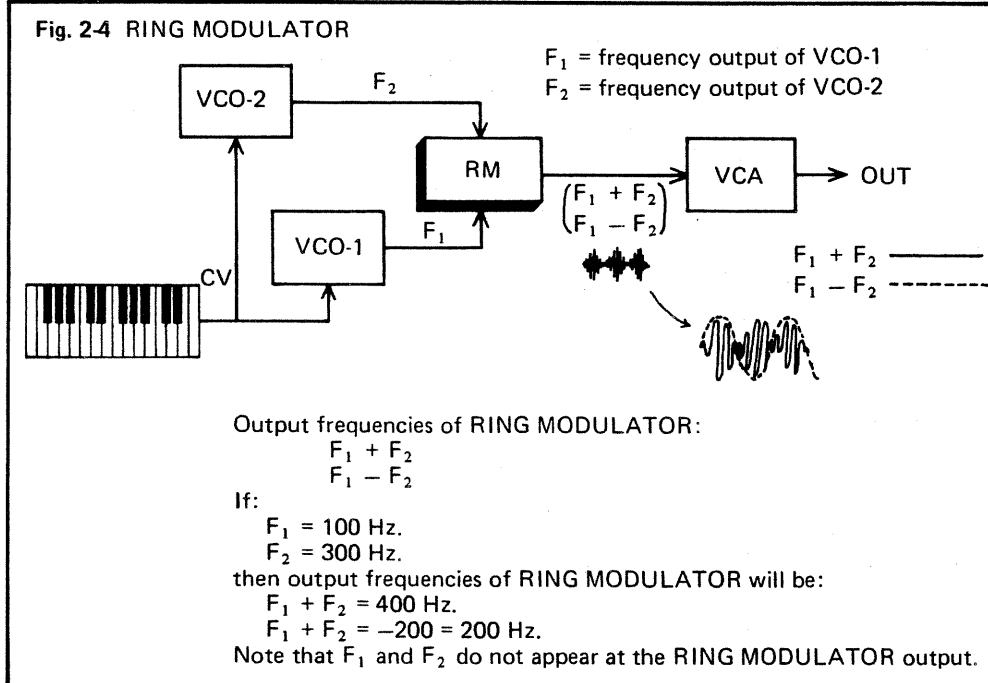

Patch 13 (Ring Modulator) shows the basic patch for using the RING MODULATOR with inputs from the two VCO's. Note that in this patch, if you remove the patch cord to the RING MODULATOR EXT INPUT jack, you will get no sound (or you can hear a little of the VCO-2 output if your external amplifier volume is turned high).

The purest bell-like sounds are obtained when combining sine waves; the triangular wave is close enough to the sine wave to produce good bell sounds.

Try other wave forms, as well as noise and LFO-2.

Also, experiment with many different VCO FREQUENCY settings.

## 2-1-4

### The gong . . . . .

There are many ways you can use the RING MODULATOR; we will give one more example here.

Set Patch 10 (Gong). Set the VCO-1 FREQUENCY control at about 100 Hz. and tune VCO-2 to a perfect fourth above VCO-1.

Note that the outputs from both VCA-2 and VCA-1 are being used.

The VCA-2 output is the bell sound comprised of the sum and difference of the VCO frequencies (fig. 2-4).

The output of VCA-1 is a sine wave whose frequency is the same as VCO-1. When mixed with the bell sound in the final MIXER, it produces a deeper pitch and gives the total sound a stronger feeling of tonality.

**2-2-0 The S/H or SAMPLE AND HOLD**

Fig. 2-5

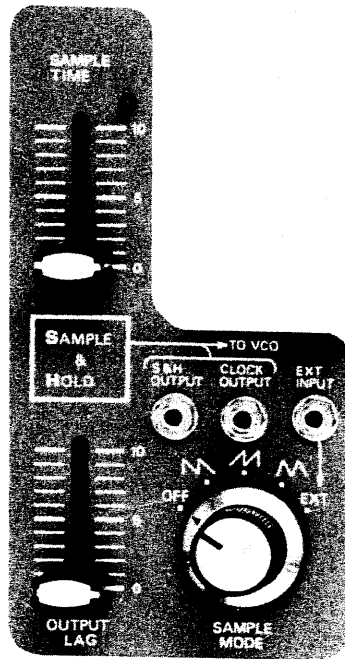

The S/H (or S & H) is used for creating voltage sequences either in repeating patterns or at random.

**2-2-1**

**How it works . . . . .**

Try Patch 26 (S/H Test). Fig. 2-6 shows how it works.

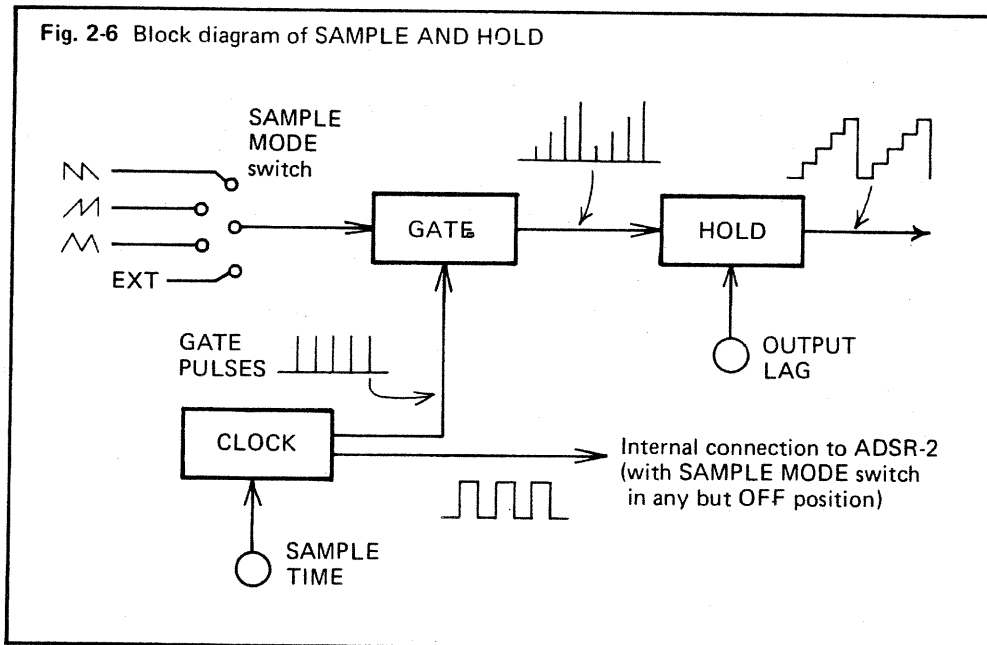

At the left, the position of the SAMPLE MODE switch determines which LFO wave form is to be sampled.

The CLOCK circuit generates short sharp pulses which control the gate. Each clock pulse opens the gate for an instant, thus allowing the HOLD circuit to "see" what the voltage of the LFO wave is at that particular instant.

The HOLD circuit "sees" this voltage and "remembers" it until the next time the gate opens.

The Clock also generates a square wave (whose frequency equals the frequency of the gate pulses) which is internally connected to ADSR-2 (when the SAMPLE MODE switch is in any position other than OFF).

## 2-2-2

### The wave forms . . . . .

Fig. 2-7 shows more clearly the relations between the different wave forms in the S/H.

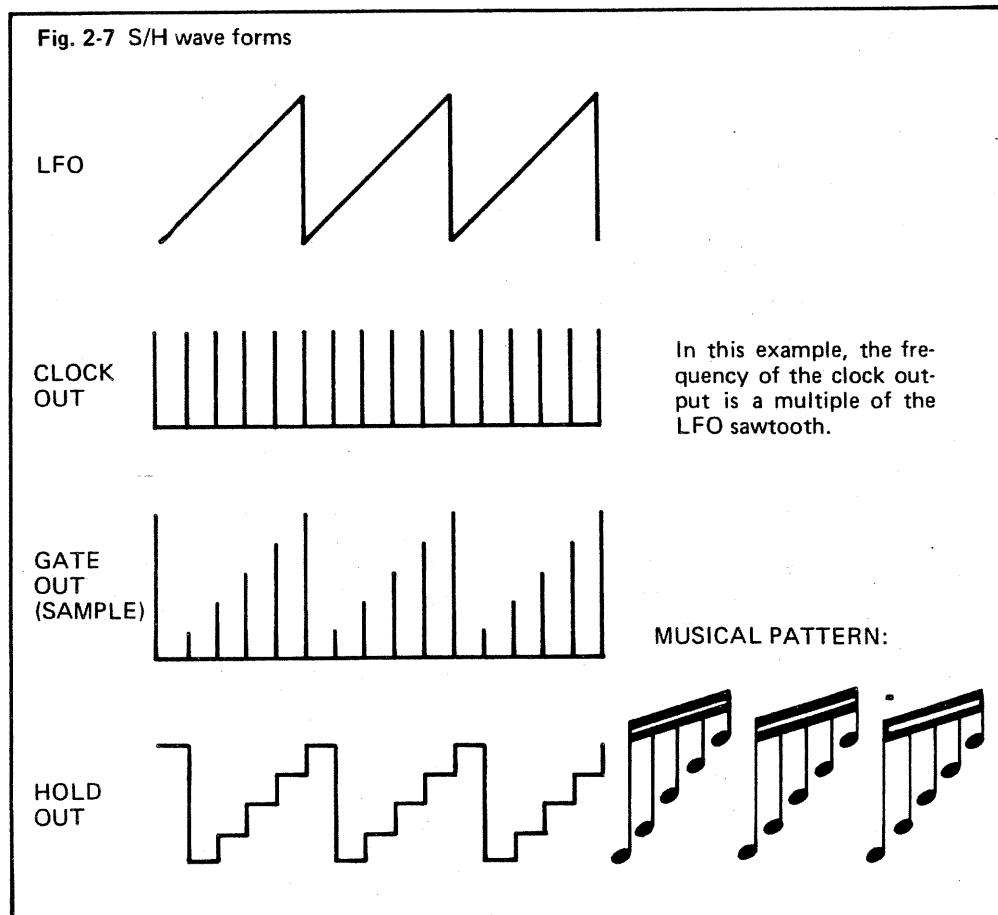

Also, fig. 2-7 shows the musical representation of the pattern if the S/H output is used to control the VCO. The frequency of these pitches would depend on the voltages of the samples taken and they often will not fall within our musical scale system. This is definitely not a disadvantage, however, as the resulting sound pattern can add beautiful tonal effects and coloring to music built on the conventional scale systems.



Since both the clock rate (SAMPLE TIME) and the sampled frequency (LFO FREQUENCY) can be changed, the number of possible patterns is almost infinite. Fig. 2-8 shows a few.

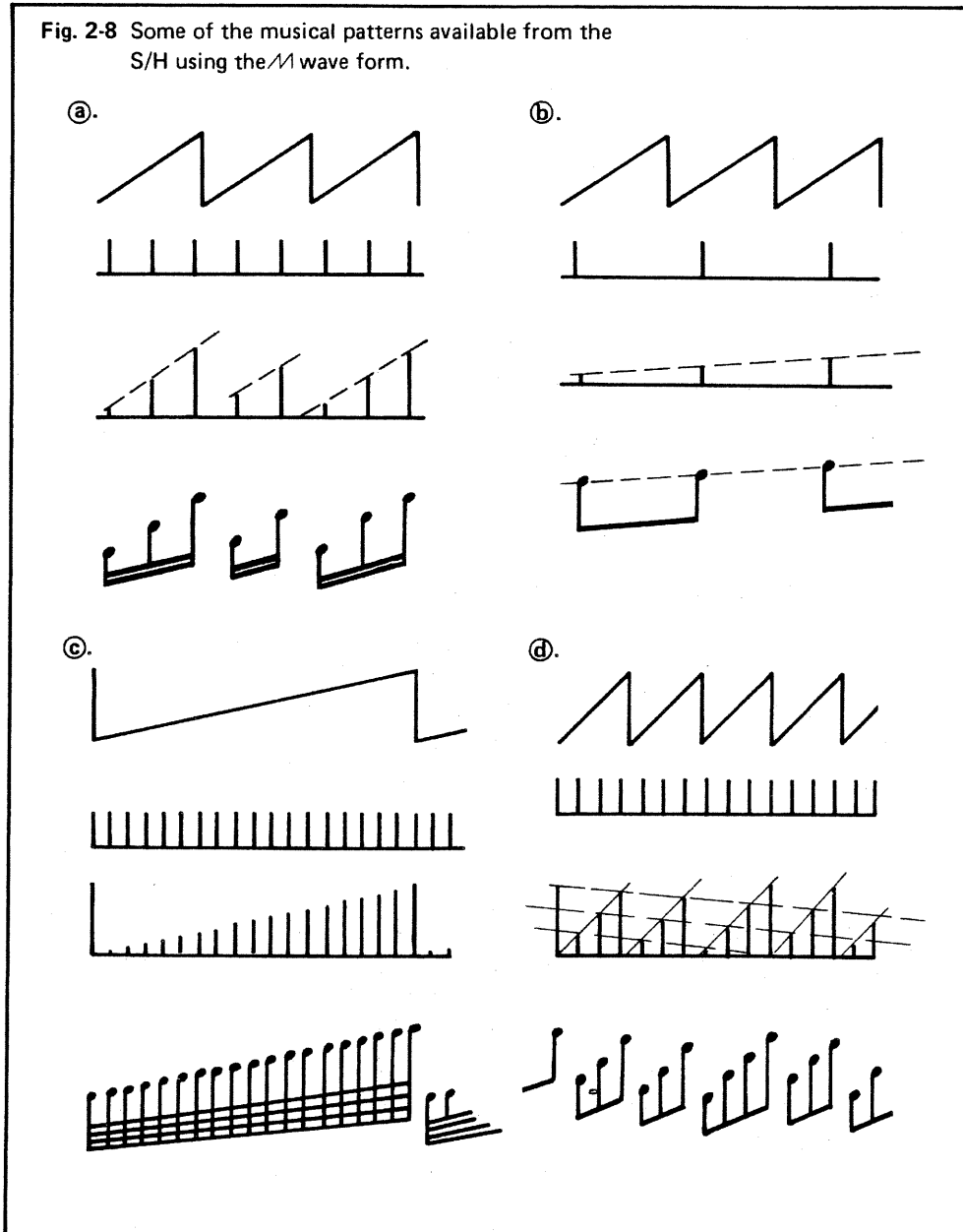

### 2-2-3

#### Lag time . . . . .

Notice that the voltage output of the S/H in this particular example (fig. 2-6) resembles a staircase. The OUTPUT LAG control will affect this control voltage in exactly the same way as the PORTAMENTO control affects the control voltage output from the keyboard controller. Try it with Patch 26 (S/H Test).

Fig. 2-9 shows the S/H output with different degrees of OUTPUT LAG setting.

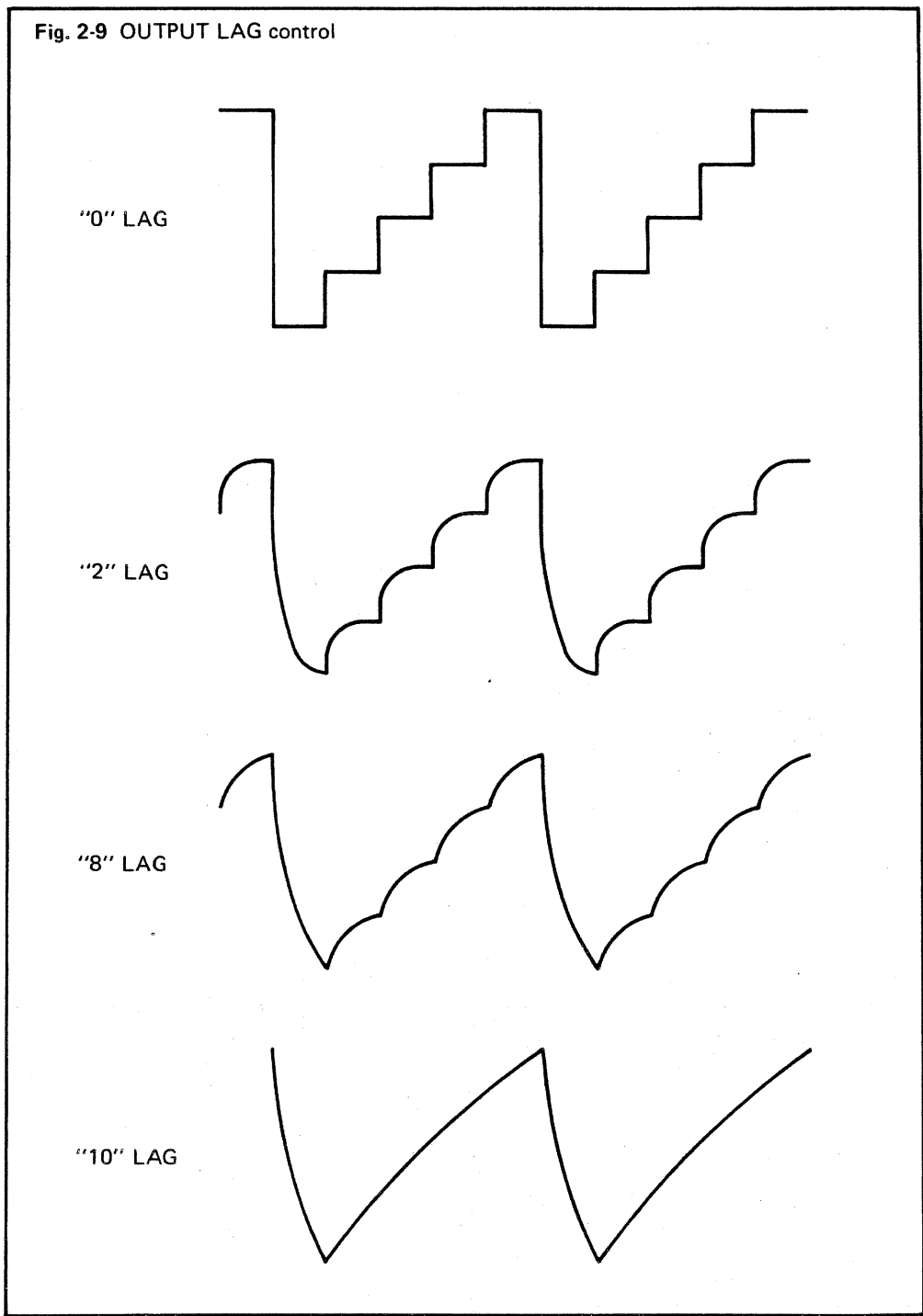

**2-2-4**

**Random patterns . . . . .**

Since noise is a random combination of different frequencies, (1-8-0, p. 48; MODEL 101 SYNTHESIZER INSTRUCTION MANUAL), if we use the S/H to take samples from the NOISE GENERATOR, the result will be random voltages.

To generate random notes with Patch 26 (S/H Test), just add a patch cord between the NOISE OUTPUT jack and the S/H EXT INPUT jack and change the SAMPLE MODE switch to EXT. The VCO-2 EXT CV/S & H slider will determine the range of pitches produced.

**2-2-5      The wind . . . . .**

Try Patch 22 (Wind). In this patch, the NOISE GENERATOR not only supplies the sound source for the wind sound, but it also acts as the random signal source for the S/H. The output of the S/H is used to shift the cutoff point of VCF-1 to give the effect of the changing wind.

**2-2-6      The tornado . . . . .**

Try Patch 20 (Tornado). This uses the VCF-2 RESONANCE control to give some whistling tone to the total wind sound.

**2-2-7      The birds . . . . .**

Try Patch 4 (Birds) for an interesting effect using the S/H.

It works like this: The S/H is sampling noise to produce random values of control voltage.

The output of the S/H is used to control the frequency of VCO-2 which is set near its lowest point.

With the VCO-2 WAVE FORM switch at  and the PULSE WIDTH MOD at MIN, the output of VCO-2 is a series of short pulses occurring at random time intervals.

The random pulses from VCO-2 are used as gate pulses to trigger ADSR-1.

ADSR-2 is triggered from the S/H clock internally (SAMPLE MODE not at OFF).

VCF-1 is oscillating (RESONANCE at "10") and the frequency output is being modulated by both ADSR-1 and ADSR-2. (Move the VCA-2 ADSR control to "0" to hear only this effect).

The output of VCF-1 also is fed to VCF-2 (via AUDIO MIXER-2) and further altered there by means of the ADSR-2 and LFO-2 control of VCF-2.

The two VCF outputs are mixed together in the final output MIXER.

This is a good patch to experiment with. Try altering it in different ways.

**2-2-8      The steam locomotive . . . . .**

Patch 16 (Steam Locomotive) is an example of a patch which uses the S/H only as a clock for triggering ADSR-2.

The whistle sound is only a very rough approximation and sounds more like a toy locomotive than the real thing. Most real steam locomotive whistles are made up of five separate pitches of more or less equal amplitude and would require five VCO's to reproduce.

## 3. IN CASE OF DIFFICULTY

Everything mentioned in Section 5 (pp. 74-76) of the MODEL 101 SYNTHESIZER INSTRUCTION MANUAL also applies to the Model 102 Expander Unit.

<b>3-1-0</b>	<b>Troubles</b>
--------------	-----------------

Turn the STANDARD test OSCILLATOR LEVEL control up.

**3-1-1**      **If you hear sound . . . . .**

If you hear sound, your external amplifier is working and both the 101 and 102 Units are receiving power.

Check the control settings as per Section 5 of the MODEL 101 SYNTHESIZER INSTRUCTION MANUAL.

**3-1-2**      **If you don't hear sound . . . . .**

The trouble may be your external amplifier/speaker system and/or its connections.

Also, check the synthesizer POWER switches. If you are using one of the OUTPUTs from the 102 Unit, the 102 Unit POWER switch must be ON in order for the final MIXER to operate.

If the INPUT of the 102 Unit MIXER is connected to the LOW OUTPUT of the 101 Unit, the sound from the 101 Unit will be weak.

<b>3-2-0</b>	<b>Things to remember</b>
--------------	---------------------------

If you use the OUTPUT from the 102 Unit, or if you want to use both Units, both POWER switches must be ON (1-0-2).

Keyboard control voltage and keyboard gate pulse connections to the 102 Unit must be made externally through patch cords (1-1-1; 1-2-0).

ADSR-2 will be triggered by the S/H clock when the S/H SAMPLE MODE switch is in any position other than OFF. (2-2-1).

## **THE LAST WORD.....**

A lot of time and effort has gone into the design and preparation of the SYSTEM 100 SYNTHESIZER, its accompanying instruction manuals and patch books. If you have any suggestions, ideas, questions, problems, complaints, praise, etc., please feel free to write directly to:

Synthesizer Project Manager  
Roland Corporation  
3-2-26, Shinkitajima  
Suminoe-ku  
Osaka, JAPAN

It may not be possible to reply to all letters, but all letters will be read and given due consideration by all staff members of the synthesizer division.

# SPECIFICATIONS

## MODEL-102 EXPANDER UNIT

### 1. VCO (Voltage Controlled Oscillator)

Frequency Range : 3Hz-40KHz  
VCO Output : 10Vp-p  
VCO Sync. Input : Strong and Weak

#### CONTROLS

WAVE FORM : Triangular, Sawtooth,  
Square Wave, Pulse Wave  
(Pulse Width Controlled)

FREQUENCY : 10Hz-10KHz (at A2 key)  
continuously variable

FINE TUNING : 1 oct.

PULSE WIDTH : 5%-50%  
(MANUAL, ADSR, LFO)

EXT. CV or : 1V/oct.  
S/H LFO

### 2. RING MODULATOR

Ext. Input : 10Vp-p  
Ring Modulator Output : 10Vp-p

### 3. AUDIO MIXER

Ext. Input Impedance : more than 50K $\Omega$

#### CONTROLS

VCO, RING MODULATOR, EXT. INPUT

### 4. HIGH PASS FILTER

HPF Cutoff Frequency : 10Hz-10KHz

### 5. VCF (Voltage Controlled Filter)

Cutoff Frequency Range : 20Hz-100KHz

#### CONTROLS

VCF CUTOFF : 20Hz-20KHz

FREQUENCY

RESONANCE : 0-self oscillation

LFO/EXT. CV : 1V/oct.

KYBD CV

ADSR

### 6. VCA (Voltage Controlled Amplifier)

#### CONTROLS

INITIAL GAIN

LFO

ADSR

### 7. ENVELOPE GENERATOR (ADSR)

KYBD Gate Input : +14V

from MODEL-101

KYBD CV Input : 1V/oct.

from MODEL-101

ADSR Output : +6V (contour peak)

Env. Input : +6V (contour peak)

#### CONTROLS

ATTACK Time : 0.4msec-3sec

DECAY Time : 0.8msec-6sec

SUSTAIN Level : 0-100% (contour peak)

RELEASE Time : 0.8msec-6sec

### 8. LFO (Low Frequency Oscillator)

Wave Form : Sawtooth, Sine, Wave,  
Square Wave

#### CONTROL

LFO FREQUENCY : 0.15-25Hz

### 9. SAMPLE AND HOLD

Ext. Input : 10Vp-p

S/H Output :

Clock Output :  $\pm 14V$

#### CONTROLS

SAMPLE MODE : OFF, Sawtooth, Re-  
verse Sawtooth, Trian-  
gular Ext. Input

SAMPLE TIME : 0.6Hz-125Hz

OUTPUT LAG : 0-2sec

### 10. OUTPUT MIXER

Input : 6Vp-p max

Input Impedance : 50K $\Omega$

### 11. AUDIO SIGNAL OUTPUT

High Output : 3Vp-p with 1K $\Omega$  out-  
put impedance.

Low Output : 0.3Vp-p with 1K $\Omega$  out-  
put impedance.

### 12. HEADPHONE OUTPUT

0.3V max into standard 8-ohm stereo head-  
phones.

### 13. DIMENSIONS AND WEIGHT

Overall Size : 610mm (24") wide,  
155mm (6.1") deep,  
305mm (12") high.

Net Weight : 7.5Kg (16.5 lbs.)

### 14. POWER REQUIREMENTS

100-120V 50-60Hz

220-250V 50-60Hz : 10W max

Specifications are subject to change without notice.

# INSTANT INDEX

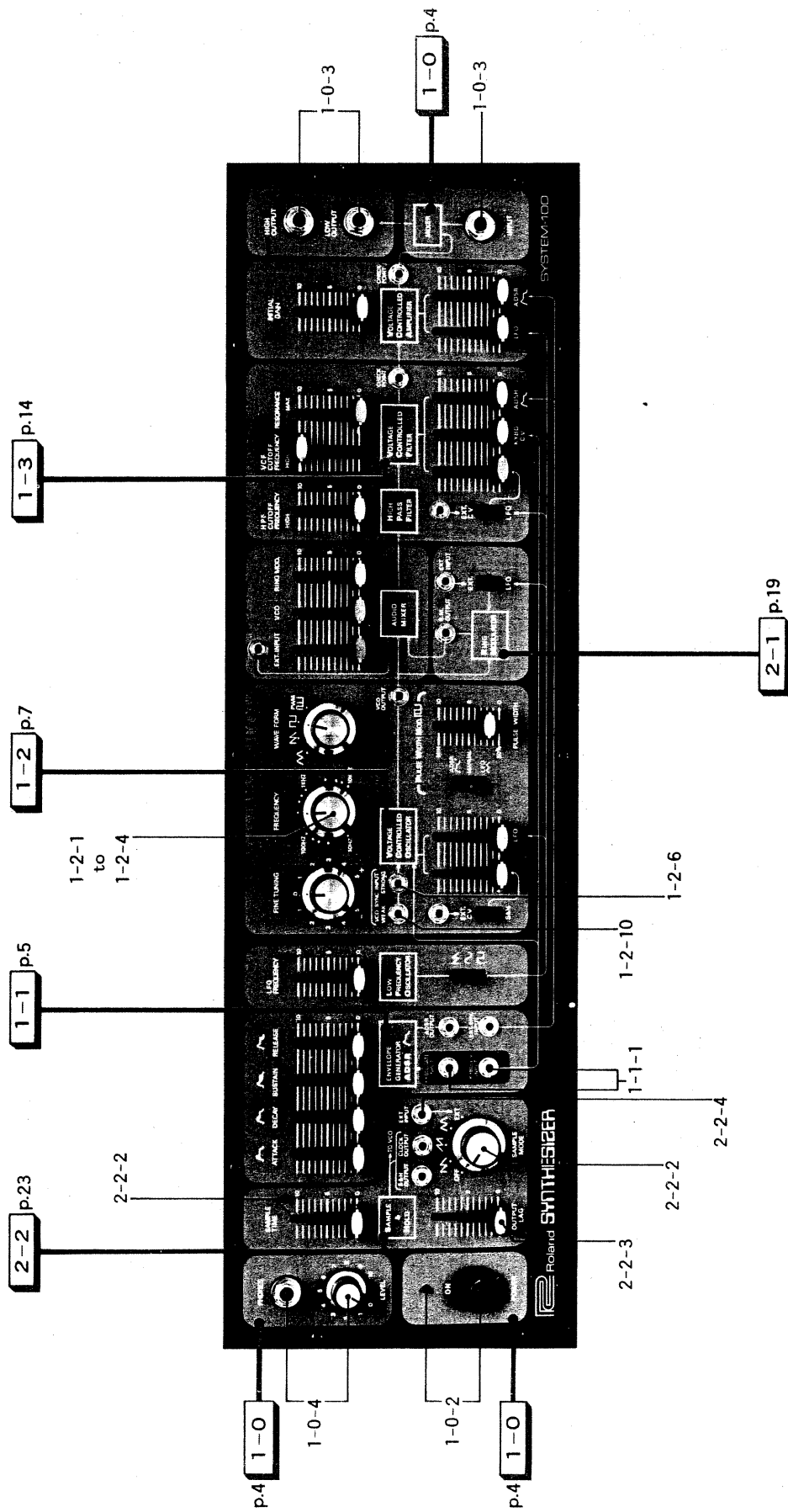

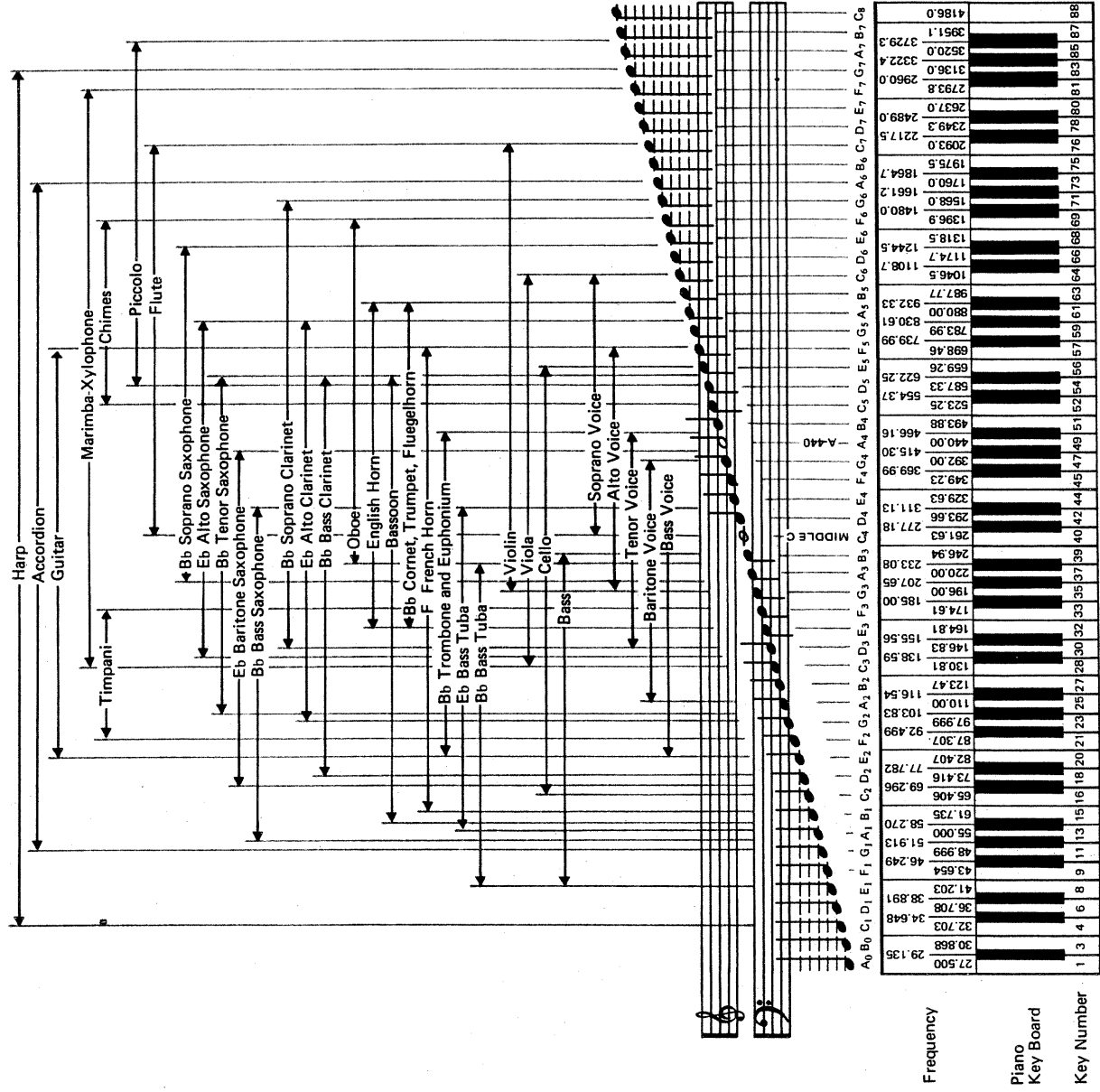

Frequency

Piano Key Board

Key Number

Chart showing frequency ranges

Instrument	Frequency Range (Hz)	Key Number
Harp	27.500 - 4186.0	1 - 88
Accordion	27.500 - 3951.1	1 - 88
Guitar	27.500 - 3520.0	1 - 88
Marimba	27.500 - 3322.4	1 - 88
Xylophone	27.500 - 3136.0	1 - 88
Chimes	27.500 - 2960.0	1 - 88
Piccolo	27.500 - 2793.8	1 - 88
Flute	27.500 - 2637.0	1 - 88
Bb Soprano Saxophone	27.500 - 2493.0	1 - 88
Eb Alto Saxophone	27.500 - 2217.5	1 - 88
Bb Tenor Saxophone	27.500 - 2093.0	1 - 88
Eb Baritone Saxophone	27.500 - 1975.5	1 - 88
Bb Bass Saxophone	27.500 - 1864.7	1 - 88
Bb Soprano Clarinet	27.500 - 1760.0	1 - 88
Eb Alto Clarinet	27.500 - 1661.2	1 - 88
Bb Bass Clarinet	27.500 - 1480.0	1 - 88
Oboe	27.500 - 1396.9	1 - 88
English Horn	27.500 - 1318.5	1 - 88
Bassoon	27.500 - 1174.7	1 - 88
Bb Cornet, Trumpet, Flugelhorn	27.500 - 1108.7	1 - 88
F French Horn	27.500 - 1046.5	1 - 88
Bb Trombone and Euphonium	27.500 - 987.77	1 - 88
Eb Bass Tuba	27.500 - 932.33	1 - 88
Bb Bass Tuba	27.500 - 880.00	1 - 88
Violin	27.500 - 830.61	1 - 88
Viola	27.500 - 783.99	1 - 88
Cello	27.500 - 739.99	1 - 88
Bass	27.500 - 698.46	1 - 88
Soprano Voice	27.500 - 659.26	1 - 88
Alto Voice	27.500 - 622.25	1 - 88
Tenor Voice	27.500 - 587.33	1 - 88
Baritone Voice	27.500 - 554.37	1 - 88
Bass Voice	27.500 - 523.26	1 - 88
Timpani	27.500 - 493.88	1 - 88
Bb Soprano Clarinet	27.500 - 466.16	1 - 88
Eb Alto Clarinet	27.500 - 440.00	1 - 88
Bb Bass Clarinet	27.500 - 415.30	1 - 88
Oboe	27.500 - 392.00	1 - 88
English Horn	27.500 - 369.99	1 - 88
Bassoon	27.500 - 349.23	1 - 88
Bb Cornet, Trumpet, Flugelhorn	27.500 - 329.63	1 - 88
F French Horn	27.500 - 293.66	1 - 88
Bb Trombone and Euphonium	27.500 - 277.18	1 - 88
Eb Bass Tuba	27.500 - 261.63	1 - 88
Bb Bass Tuba	27.500 - 246.94	1 - 88
Violin	27.500 - 233.00	1 - 88
Viola	27.500 - 220.00	1 - 88
Cello	27.500 - 207.65	1 - 88
Bass	27.500 - 196.00	1 - 88
Soprano Voice	27.500 - 185.00	1 - 88
Alto Voice	27.500 - 174.61	1 - 88
Tenor Voice	27.500 - 164.81	1 - 88
Baritone Voice	27.500 - 155.66	1 - 88
Bass Voice	27.500 - 146.83	1 - 88
Timpani	27.500 - 130.81	1 - 88
Bb Soprano Clarinet	27.500 - 123.47	1 - 88
Eb Alto Clarinet	27.500 - 116.54	1 - 88
Bb Bass Clarinet	27.500 - 110.00	1 - 88
Oboe	27.500 - 103.83	1 - 88
English Horn	27.500 - 97.999	1 - 88
Bassoon	27.500 - 92.499	1 - 88
Bb Cornet, Trumpet, Flugelhorn	27.500 - 87.307	1 - 88
F French Horn	27.500 - 82.407	1 - 88
Bb Trombone and Euphonium	27.500 - 77.782	1 - 88
Eb Bass Tuba	27.500 - 73.416	1 - 88
Bb Bass Tuba	27.500 - 69.296	1 - 88
Violin	27.500 - 66.406	1 - 88
Viola	27.500 - 61.735	1 - 88
Cello	27.500 - 58.270	1 - 88
Bass	27.500 - 55.000	1 - 88
Soprano Voice	27.500 - 51.913	1 - 88
Alto Voice	27.500 - 48.999	1 - 88
Tenor Voice	27.500 - 46.249	1 - 88
Baritone Voice	27.500 - 43.654	1 - 88
Bass Voice	27.500 - 41.203	1 - 88
Timpani	27.500 - 38.891	1 - 88
Bb Soprano Clarinet	27.500 - 36.708	1 - 88
Eb Alto Clarinet	27.500 - 34.648	1 - 88
Bb Bass Clarinet	27.500 - 32.703	1 - 88
Oboe	27.500 - 30.868	1 - 88
English Horn	27.500 - 29.135	1 - 88
Bassoon	27.500 - 27.500	1 - 88



# INDEX TO TERMS

The first figure after each word indicates the page number.  
The second figure indicates the paragraph number.  
The words are underlined in the text to make them easier to find.

additive synthesis, 12; 1-2-14  
AM, 20; 2-1-2  
amplitude modulation, 20; 2-1-2

balanced modulator, 20; 2-1-3

FM, 20; 2-1-1  
frequency modulation, 20; 2-1-1

modulation, amplitude, 20; 2-1-2  
modulation, frequency, 20; 2-1-1

ring modulator, 20; 2-1-3

sample and hold, 23; 2-2-0  
S/H or S &H, 23; 2-2-0  
subtractive synthesis, 11; 1-2-14  
sync, 10; 1-2-7

tracking, 8; 1-2-5, 1-2-6

 Roland®

---

**10265**

UPC 10265

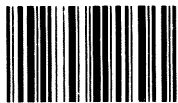

10981