

**BOSS®**

# SP-505

Groove  
Sampling  
Workstation

## Owner's Manual

Thank you, and congratulations on your choice of the BOSS SP-505 Groove Sampling Workstation.

Before using this unit, carefully read the sections entitled:

- **USING THE UNIT SAFELY** (page 2-3)
- **IMPORTANT NOTES** (page 4-5)

These sections provide important information concerning the proper operation of the unit.

Additionally, in order to feel assured that you have gained a good grasp of every feature provided by your new unit, Owner's manual should be read in its entirety. The manual should be saved and kept on hand as a convenient reference.

### ■ Printing Conventions in This Manual

- Text or numerals enclosed in square brackets [ ] indicate buttons.  
[PLAY] PLAY button  
[REC] REC button
- Reference such as (p. \*\*) indicate pages in this manual to which you can refer.

Copyright © 2001 BOSS CORPORATION

All rights reserved. No part of this publication may be reproduced in any form without the written permission of BOSS CORPORATION.

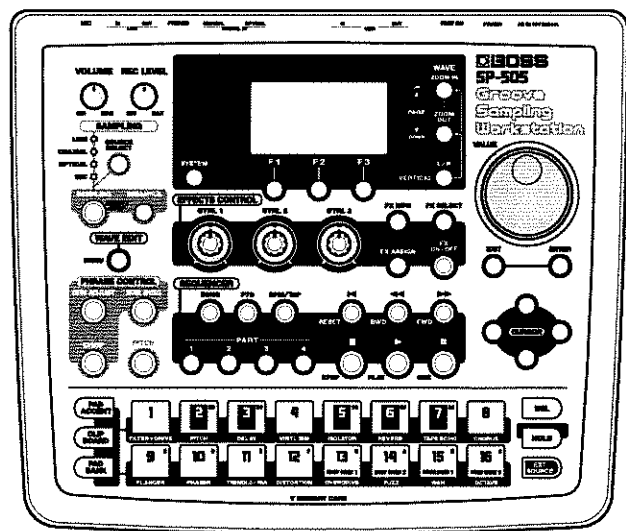

# USING THE UNIT SAFELY

## INSTRUCTIONS FOR THE PREVENTION OF FIRE, ELECTRIC SHOCK, OR INJURY TO PERSONS

### About ⚠ WARNING and ⚠ CAUTION Notices

<b>⚠ WARNING</b>	Used for instructions intended to alert the user to the risk of death or severe injury should the unit be used improperly.
<b>⚠ CAUTION</b>	Used for instructions intended to alert the user to the risk of injury or material damage should the unit be used improperly. * Material damage refers to damage or other adverse effects caused with respect to the home and all its furnishings, as well to domestic animals or pets.

### About the Symbols

	The ⚠ symbol alerts the user to important instructions or warnings. The specific meaning of the symbol is determined by the design contained within the triangle. In the case of the symbol at left, it is used for general cautions, warnings, or alerts to danger.
	The ⚡ symbol alerts the user to items that must never be carried out (are forbidden). The specific thing that must not be done is indicated by the design contained within the circle. In the case of the symbol at left, it means that the unit must never be disassembled.
	The ⚡ symbol alerts the user to things that must be carried out. The specific thing that must be done is indicated by the design contained within the circle. In the case of the symbol at left, it means that the power-cord plug must be unplugged from the outlet.

### ALWAYS OBSERVE THE FOLLOWING

#### ⚠ WARNING

- Before using this unit, make sure to read the instructions below, and the Owner's Manual.

---

- Do not open or perform any internal modifications on the unit or its AC adaptor. (The only exception would be where this manual provides specific instructions which should be followed in order to put in place user-installable options; see p. 5.)

---

- Do not attempt to repair the unit, or replace parts within it (except when this manual provides specific instructions directing you to do so). Refer all servicing to your retailer, the nearest Roland Service Center, or an authorized Roland distributor, as listed on the "Information" page.

---

- Never use or store the unit in places that are:
  - Subject to temperature extremes (e.g., direct sunlight in an enclosed vehicle, near a heating duct, on top of heat-generating equipment); or are
  - Damp (e.g., baths, washrooms, on wet floors); or are
  - Humid; or are
  - Exposed to rain; or are
  - Dusty; or are
  - Subject to high levels of vibration.

---

- Make sure you always have the unit placed so it is level and sure to remain stable. Never place it on stands that could wobble, or on inclined surfaces.

#### ⚠ WARNING

- Be sure to use only the AC adaptor supplied with the unit. Also, make sure the line voltage at the installation matches the input voltage specified on the AC adaptor's body. Other AC adaptors may use a different polarity, or be designed for a different voltage, so their use could result in damage, malfunction, or electric shock.

---

- Do not excessively twist or bend the power cord, nor place heavy objects on it. Doing so can damage the cord, producing severed elements and short circuits. Damaged cords are fire and shock hazards!

---

- This unit, either alone or in combination with an amplifier and headphones or speakers, may be capable of producing sound levels that could cause permanent hearing loss. Do not operate for a long period of time at a high volume level, or at a level that is uncomfortable. If you experience any hearing loss or ringing in the ears, you should immediately stop using the unit, and consult an audiologist.

---

- Do not allow any objects (e.g., flammable material, coins, pins); or liquids of any kind (water, soft drinks, etc.) to penetrate the unit.

**⚠ WARNING**

- Immediately turn the power off, remove the AC adaptor from the outlet, and request servicing by your retailer, the nearest Roland Service Center, or an authorized Roland distributor, as listed on the "Information" page when:
  - The AC adaptor, the power-supply cord, or the plug has been damaged; or
  - Objects have fallen into, or liquid has been spilled onto the unit; or
  - The unit has been exposed to rain (or otherwise has become wet); or
  - The unit does not appear to operate normally or exhibits a marked change in performance.

---

- In households with small children, an adult should provide supervision until the child is capable of following all the rules essential for the safe operation of the unit.

---

- Protect the unit from strong impact. (Do not drop it!)

---

- Do not force the unit's power-supply cord to share an outlet with an unreasonable number of other devices. Be especially careful when using extension cords—the total power used by all devices you have connected to the extension cord's outlet must never exceed the power rating (watts/amperes) for the extension cord. Excessive loads can cause the insulation on the cord to heat up and eventually melt through.

---

- Before using the unit in a foreign country, consult with your retailer, the nearest Roland Service Center, or an authorized Roland distributor, as listed on the "Information" page.

**⚠ CAUTION**

- The unit and the AC adaptor should be located so their location or position does not interfere with their proper ventilation.

---

- Always grasp only the plug on the AC adaptor cord when plugging into, or unplugging from, an outlet or this unit.

---

- Whenever the unit is to remain unused for an extended period of time, disconnect the AC adaptor.

---

- Try to prevent cords and cables from becoming entangled. Also, all cords and cables should be placed so they are out of the reach of children.

---

- Never climb on top of, nor place heavy objects on the unit.

---

- Never handle the AC adaptor or its plugs with wet hands when plugging into, or unplugging from, an outlet or this unit.

---

- Before moving the unit, disconnect the AC adaptor and all cords coming from external devices.

---

- Before cleaning the unit, turn off the power and unplug the AC adaptor from the outlet.

---

- Whenever you suspect the possibility of lightning in your area, disconnect the AC adaptor from the outlet.

---

- When removing the card cover, remove only the specified screws (p. 5).

---

- Should you remove the optical connector caps or screws, make sure to put them in a safe place out of children's reach, so there is no chance of them being swallowed accidentally.

# IMPORTANT NOTES

In addition to the items listed under “USING THE UNIT SAFELY” on page 2–3, please read and observe the following:

## Power Supply

- Do not use this unit on the same power circuit with any device that will generate line noise (such as an electric motor or variable lighting system).
- The AC adaptor will begin to generate heat after long hours of consecutive use. This is normal, and is not a cause for concern.
- Before connecting this unit to other devices, turn off the power to all units. This will help prevent malfunctions and/or damage to speakers or other devices.

## Placement

- Using the unit near power amplifiers (or other equipment containing large power transformers) may induce hum. To alleviate the problem, change the orientation of this unit; or move it farther away from the source of interference.
- This device may interfere with radio and television reception. Do not use this device in the vicinity of such receivers.
- Do not expose the unit to direct sunlight, place it near devices that radiate heat, leave it inside an enclosed vehicle, or otherwise subject it to temperature extremes. Excessive heat can deform or discolor the unit.
- To avoid possible breakdown, do not use the unit in a wet area, such as an area exposed to rain or other moisture.

## Maintenance

- For everyday cleaning wipe the unit with a soft, dry cloth or one that has been slightly dampened with water. To remove stubborn dirt, use a cloth impregnated with a mild, non-abrasive detergent. Afterwards, be sure to wipe the unit thoroughly with a soft, dry cloth.
- Never use benzine, thinners, alcohol or solvents of any kind, to avoid the possibility of discoloration and/or deformation.

## Additional Precautions

- Please be aware that the contents of memory can be irretrievably lost as a result of a malfunction, or the improper operation of the unit. To protect yourself against the risk of losing important data, we recommend that you periodically save a backup copy of important data you have stored in the unit's memory on a memory card.
- Unfortunately, it may be impossible to restore the contents of data that was stored in the unit's memory or a memory card once it has been lost. Roland Corporation assumes no liability concerning such loss of data.
- Use a reasonable amount of care when using the unit's buttons, sliders, or other controls; and when using its jacks and connectors. Rough handling can lead to malfunctions.
- Never strike or apply strong pressure to the display.
- When connecting / disconnecting all cables, grasp the connector itself—never pull on the cable. This way you will avoid causing shorts, or damage to the cable's internal elements.
- To avoid disturbing your neighbors, try to keep the unit's volume at reasonable levels. You may prefer to use headphones, so you do not need to be concerned about those around you (especially when it is late at night).
- When you need to transport the unit, package it in the box (including padding) that it came in, if possible. Otherwise, you will need to use equivalent packaging materials.
- Use a cable from Roland to make the connection. If using some other make of connection cable, please note the following precautions.
  - Some connection cables contain resistors. Do not use cables that incorporate resistors for connecting to this unit. The use of such cables can cause the sound level to be extremely low, or impossible to hear. For information on cable specifications, contact the manufacturer of the cable.

## Before Using Memory Cards (SmartMedia)

### Using Memory Cards

- Carefully insert the Memory card all the way in—until it is firmly in place.

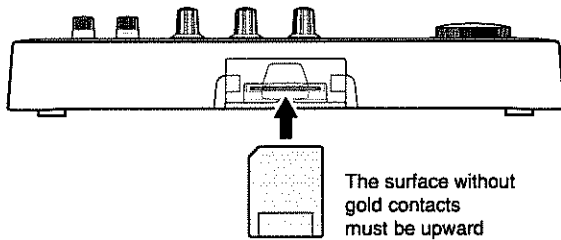

- Never touch the terminals of the Memory card. Also, avoid getting the terminals dirty.

### Copyright



- Unauthorized recording, distribution, sale, lending, public performance, broadcasting, or the like, in whole or in part, of a work (musical composition, video, broadcast, public performance, or the like) whose copyright is held by a third party is prohibited by law.
- Do not use this unit for purposes that could infringe on a copyright held by a third party. BOSS/Roland assumes no responsibility whatsoever with regard to any infringements of third-party copyrights arising through your use of this unit.

## Remove the Card Cover

When removing the card cover, first remove the two screws that hold the card cover on the bottom of the unit using a coin or screwdriver.

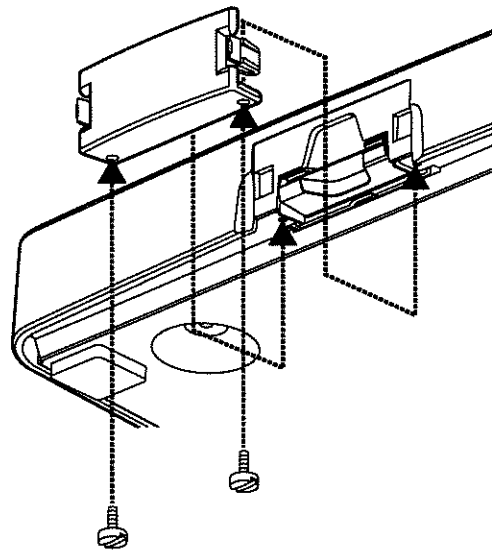
- When turning the unit upside-down, get a bunch of newspapers or magazines, and place them under the four corners or at both ends to prevent damage to the buttons and controls. Also, you should try to orient the unit so no buttons or controls get damaged.
- When turning the unit upside-down, handle with care to avoid dropping it, or allowing it to fall or tip over.



- When removing the card cover, remove only the specified screws. 
- Should you remove the optical connector caps or screws, make sure to put them in a safe place out of children's reach, so there is no chance of them being swallowed accidentally. 

# Contents

<b>IMPORTANT NOTES .....</b>	<b>4</b>
Remove the Card Cover .....	5
<b>Main Features .....</b>	<b>9</b>
<b>Names of Things and What They Do.....</b>	<b>10</b>
Front Panel.....	10
Rear Panel.....	13
<b>Quick Start.....</b>	<b>14</b>
Making the Connections.....	14
Turning the power on.....	15
Turning the power off.....	15
The SP-505's display.....	16
Parameter list display.....	16
Wave display.....	16
Sub-window display.....	16
Press the pads to play sounds.....	17
Listening to the preset patterns.....	18
An overview of the SP-505.....	19
How the sections of the SP-505 are connected.....	19
How the SP-505 is organized.....	19
Applying effects.....	21
Recording a sample.....	22
If you are not satisfied with the sampled sound.....	23
Changing the BPM (tempo) of the sample (BPM Adjust).....	24
Synchronizing the BPM (tempo) of several samples (BPM Sync).....	25
Dividing a sample between several pads (Chop).....	26
Playing pitches with a sample (Pitch).....	27
<b>Chapter 1. Playing samples from the pads .....</b>	<b>29</b>
What are the 32 pad banks?.....	29
Basic ways to play samples.....	29
The number of samples that can be played simultaneously.....	30
Switching the pad bank.....	30
Switching the pad accent.....	30
Using the Hold function to play samples.....	30
Changing how the sample sounds or stops (Pad Play).....	31
Looping the sound (Loop Mode).....	31
Playing a sample backward (Reverse Playback).....	32
Playing an audio input signal (EXT Source).....	32
Adjusting the EXT source settings.....	33
Changing the BPM of a sample.....	33
<b>Chapter 2. Using the internal effects .....</b>	<b>34</b>
Selecting pads to which effects are applied (FX Assign).....	34
Selecting the pad that will be the effect synchronization source (SYNC SOURCE).....	34
Selecting an effect.....	35
Using the pads to select an effect.....	35
Turning the effect on/off.....	35
Controlling how the effect is applied.....	35
Effects List.....	36
<b>Chapter 3. Recording samples .....</b>	<b>39</b>
Before you sample.....	39
Stereo/mono sampling selection.....	39
Selecting the Sampling Grade.....	39
About the sampling time.....	39

Starting sampling automatically when sound is input.....	39
Applying an effect while you sample.....	40
Selecting the input source .....	40
Sampling procedure .....	41
Re-sampling samples (Resampling).....	42
Resampling procedure 1 (Auto) .....	42
Resampling procedure 2 (Manual) .....	43
<b>Chapter 4. Changing the settings of a sample.....</b>	<b>44</b>
Procedure .....	44
Adjusting the volume of a sample.....	44
Adjusting the stereo position of a sample.....	44
Changing how a sample plays and stops .....	44
Looping the playback of a sample .....	44
Playing a sample backward.....	45
Playing a sample in Phrase or Single modes .....	45
Changing the number of measures of a sample.....	45
Changing the time signature of a sample.....	45
Adjusting the BPM (tempo) of a sample .....	46
Specifying the start/end points of the sound (Omitting unwanted portions) .....	46
Adjusting the volume of a specified region of the sample.....	47
<b>Chapter 5. Deleting or copying a sample .....</b>	<b>49</b>
Deleting a sample.....	49
Using the clipboard to copy a sample .....	49
Copying a single sample.....	49
Copying multiple samples .....	50
Exchanging samples.....	50
<b>Chapter 6. Applying special processing to a sample.....</b>	<b>51</b>
Dividing a sample into individual notes (Chop) .....	51
Editing the points at which the sample is divided .....	51
About the dividing point adjustment screen.....	51
Adding a dividing point.....	52
Deleting a dividing point .....	52
Making fine adjustments to the dividing points.....	53
Playing pitches with a sample (Pitch) .....	54
<b>Chapter 7. Playing songs and patterns .....</b>	<b>55</b>
Adjusting the BPM (tempo) of a song or pattern.....	55
Playing a song .....	55
Selecting and playing songs from the song list .....	56
Playing patterns.....	56
Selecting and playing a pattern from the pattern list .....	57
Muting individual parts .....	57
<b>Chapter 8. Creating patterns.....</b>	<b>58</b>
About pattern recording .....	58
Pattern data .....	58
Realtime recording procedure .....	58
Erasing unwanted performance data (Realtime Recording).....	59
Microscope editing procedure.....	59
Viewing the performance data (Microscope Edit).....	60
Deleting unwanted performance data (Microscope Edit) .....	60
Changing the pad number (Microscope Edit).....	60
Adjusting the dynamics (accent) of the sound (Microscope Edit) .....	61
Changing the length of the sound (Microscope Edit) .....	61
Moving the timing of the sound (Microscope Edit) .....	61

Changing the rhythmic feel of a pattern (Swing) .....	61
Assigning a name to a pattern .....	62
Storing the part mute status .....	62
<b>Chapter 9. Creating a song .....</b>	<b>63</b>
About song recording .....	63
Making song settings .....	63
Song recording procedure .....	63
Deleting a pattern .....	64
Inserting a pattern .....	64
Changing a pattern .....	64
Assigning a name to a song .....	64
<b>Chapter 10. Deleting or copying a pattern or song .....</b>	<b>65</b>
Deleting a pattern or song .....	65
Copying a pattern or song .....	65
<b>Chapter 11. Using a memory card .....</b>	<b>66</b>
About memory cards .....	66
Inserting a memory card .....	66
Formatting a memory card .....	66
Saving data on a memory card (Save) .....	67
Saving sample data .....	67
Saving sequencer data .....	67
Loading memory card data into internal memory (Load) .....	68
Loading sample data .....	68
Loading sequencer data .....	68
Deleting data from a memory card .....	69
Loading WAV/AIFF files into the SP-505 .....	69
Precautions concerning the loading of WAV/AIFF files .....	70
Deleting a WAV/AIFF file .....	70
<b>Chapter 12. Using the SP-505 with other MIDI devices .....</b>	<b>71</b>
About MIDI .....	71
Changing the MIDI settings .....	71
Synchronizing the performance of the SP-505 and an external MIDI device .....	72
Sync mode settings .....	72
<b>Chapter 13. Making system settings .....</b>	<b>73</b>
About the CONFIG parameters .....	73
<b>Chapter 14. Restoring the factory settings .....</b>	<b>74</b>
Factory settings .....	74
Procedure .....	74
<b>Chapter 15. Appendices .....</b>	<b>75</b>
Troubleshooting .....	75
Error message list .....	78
Parameter List .....	80
Preset Sample .....	82
Preset Pattern .....	82
MIDI Implementation .....	83
MIDI Implementation Chart .....	87
Specifications .....	88
<b>Index .....</b>	<b>89</b>



# Main Features

The SP-505 is a groove sampling workstation that provides all the functionality you need to produce dance music.

## Chop function

The "Chop" function detects the attacks within a sampled phrase, and divides the sample into separate sound events. The samples that are generated in this way are automatically assigned to pads.

## Pitch function

By using the "Pitch" function you can play pitches using a sample.

## BPM Sync function

The "BPM Sync" function allows the BPM of up to 16 phrases to be synchronized at a single touch.

## Waveform display

You can edit the start/end points or truncate the sample while viewing its waveform in the display. You can also zoom-in on the waveform for even more detailed editing.

## Maximum polyphony: 8 notes

Up to eight samples (mono) of a 44.1 kHz sampling frequency can be played simultaneously.

## Extended sampling using SmartMedia

The internal memory of the SP-505 allows a maximum of approximately 17 minutes of sampling.

In addition, separately available memory cards (SmartMedia; 8-128 MB) can be used for extended sampling.

For example, by using 64 MB SmartMedia, you can sample up to 32 minutes in standard mode, or approximately 197 minutes in low-fi mode.

\* 1MB/2MB/4MB SmartMedia cannot be used.

\* SmartMedia is a trademark of Toshiba Corp.

## Support for WAV/AIFF files

WAV/AIFF files from your computer can be loaded via SmartMedia into the SP-505.

## Re-sampling

You can play back samples while applying internal effects and re-sample the result to create new samples without any loss of audio quality.

## Preset sounds

Comes loaded with 64 preset samples (including drum and bass), and 40 preset patterns.

## Pattern Select function

Preset or user patterns can be recalled directly using the 16 key pads.

## Pattern sequencer

The SP-505 has a built-in pattern sequencer, which lets you combine patterns of several measures to create a "song."

## 26 different effects

The SP-505 provides a selection of 26 different effects, ranging from Vinyl Simulator, which simulates the characteristics of an analog record, to Isolator and Reverb. Effects can be controlled in real time using three knobs.

## Digital In

Two Digital In connectors (optical/coaxial) are provided, allowing digital audio signals from a CD or computer to be sampled.

# Names of Things and What They Do

## Front Panel

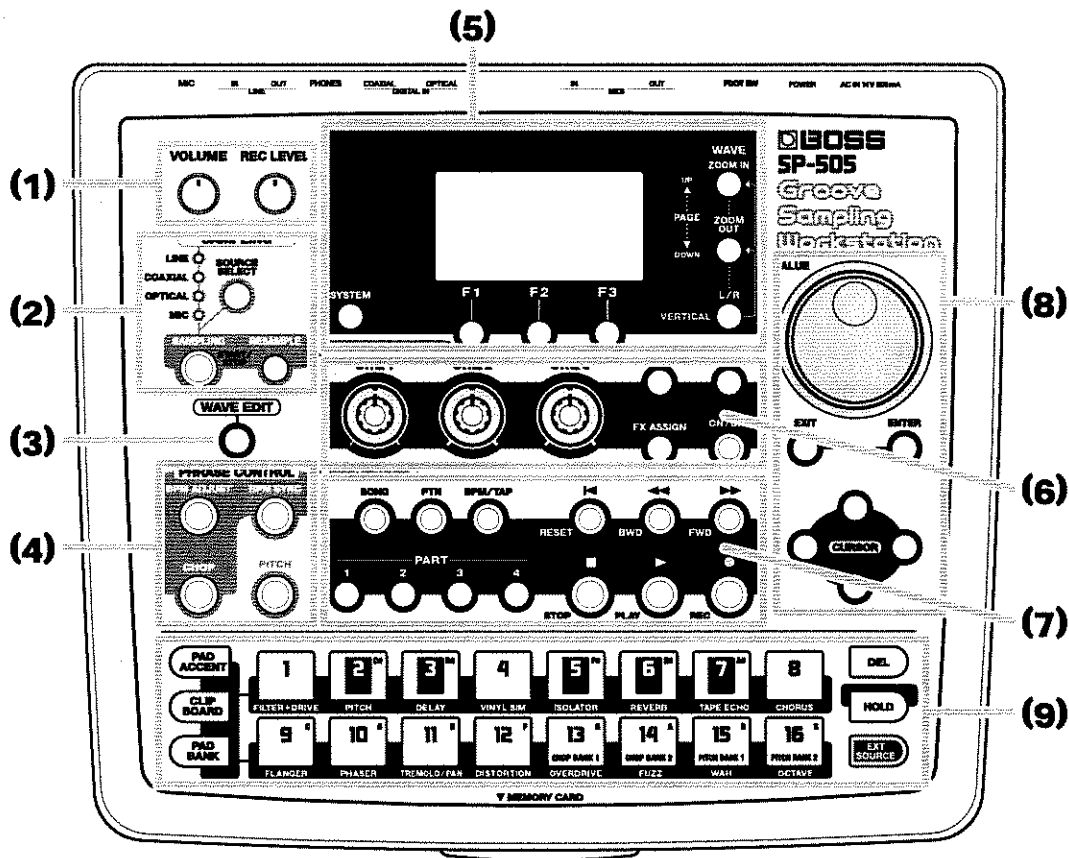

(1)

### VOLUME (Volume Knob)

Adjusts the overall volume of the SP-505.

### REC LEVEL (REC Level Knob)

Adjusts the volume during sampling.

Adjusts the EXT SOURCE volume.

## (2) SAMPLING

### SOURCE SELECT Button

This selects the input source (input jack) that is to be sampled.

### SAMPLING Button

This stops/starts sampling.

### RESAMPLE Button

Press this to resample.

(3)

### WAVE EDIT Button

Press this to edit the sampled waveform.

## (4) PHRASE CONTROL

### BPM ADJUST Button

Press this when you want to control the BPM of a sampled phrase in real time.

### BPM SYNC Button

By pressing this button, you can synchronize the BPM of the 16 samples that can currently be played by pressing the pads.

### CHOP Button

This function detects the attacks within a sampled phrase, divides the phrase into individual samples, and assigns them to separate pads.

### **PITCH Button**

This allows you to play scales with the sample.

## **(5)**

### **SYSTEM Button**

Press this button when you want to make system-related settings, such as adjusting the display contrast or setting the MIDI channel.

### **Display**

A variety of information is shown here.

### **F1-F3 Buttons**

The function of these buttons will change depending on the screen. The function names will be indicated in the display (above each button).

### **ZOOM IN Button ZOOM OUT Button**

When you are editing a sampled waveform, these buttons zoom-in or zoom-out on the sampled waveform in the display.

In other situations, these buttons switch between screen pages.

- \* *If you continue pressing the button, the screens will switch successively.*
- \* *If you hold down one button and press the opposite button, the screens will switch more rapidly.*

### **L/R Button**

While editing the waveforms of stereo samples, this button is pressed to switch between the left and right channel waveforms.

## **(6) EFFECTS CONTROL**

### **CTRL 1-CTRL 3 (Control knobs 1-3)**

These knobs provide for the realtime control of the parameters assigned to them, which vary depending on the effect selected.

### **FX INFO (Effect Information) Button**

Press this button when you want the status of an effect setting to be shown in the display.

### **FX SELECT (Effect Select) Button**

Press this button to select effects.

By pressing this button and then pressing a pad [1]–[16], you can directly select effect numbers 1–16.

### **FX ASSIGN (Effect Assign) Button**

Press this button to specify the pad (sample) to which you want to apply an effect.

### **FX ON/OFF (Effect On/Off) Button**

This button turns the effect on/off.

## **(7) SEQUENCER**

### **SONG Button**

Press this button to play back a song.

### **PTN (Pattern) Button**

Press this button to play back patterns.

### **BPM/TAP Button**

Press this button when you want to set the BPM of a song or pattern.

By pressing this button four times at the desired tempo, you can also set the Tap Tempo.

### **PART Buttons 1-4**

These buttons switch the sounded/muted status of each part of the pattern or song.

**Button lit:** will sound

**Button dark:** muted

### **RESET Button**

Resets the unit so playback of a song or pattern will start at the beginning.

### **BWD (Backward) Button**

Press this button to move the playback position backwards, by one measure each time you press it, to the beginning of previous measures.

- \* *If you continue pressing the button, you will move successively backward to the beginning of the previous measure.*

### **FWD (Forward) Button**

Press this button to move the playback position forwards, by one measure each time you press it, to the beginning of subsequent measures.

- \* *If you continue pressing the button, you will move successively forward to the beginning of the next measure.*

### **STOP Button**

This button stops playback of the song or pattern.

### **PLAY Button**

This button starts playback of the song or pattern.

## Names of Things and What They Do

### **REC (Recording) Button**

Press this button when you want to record a song or pattern.

### **(8)**

### **VALUE Dial**

Use this to adjust the value of a setting.

### **EXIT Button**

Press this button to cancel an operation. You are returned to the Play page.

### **ENTER Button**

Press this button to confirm a value that you've specified, or to execute an operation.

### **CURSOR Buttons** ←/→/↑/↓

These buttons move the cursor.

- \* *If you continue pressing a button, the cursor will continue to move.*
- \* *If you hold down one button while you press the opposite button, the cursor will move more rapidly.*

### **(9)**

### **PAD ACCENT Button**

Press this button to adjust the volume of the samples assigned to the pads.

### **CLIPBOARD Button**

Press this to temporarily save a sample in the clipboard.

### **PAD BANK Button**

Used to select the pad bank (32 banks).

### **Pads 1-16**

Press these pads to play the sample assigned to each pad. The pad will light while the sample is playing.

These pads are also used to select songs, patterns, pad banks, and effects.

### **DEL (Delete) Button**

Use this button to delete the sample assigned to a pad.

### **HOLD Button**

If you hold down a pad and press this button, the sample will continue to play even after you take your finger off the pad.

### **EXT SOURCE (External source) Button**

You can use this button to play external input sources. Effects can also be applied to the external input source.

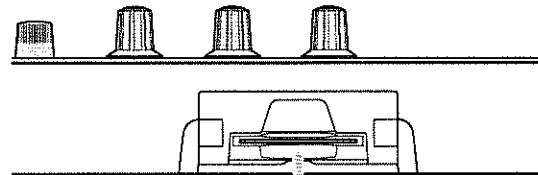

**(10)**

### **(10)**

### **MEMORY CARD Slot**

A memory card (SmartMedia; sold separately) can be inserted here. Using a memory card allows you to sample for longer times than possible with the internal memory.

Data from internal memory can also be saved (backed up) on a memory card.

## Rear Panel

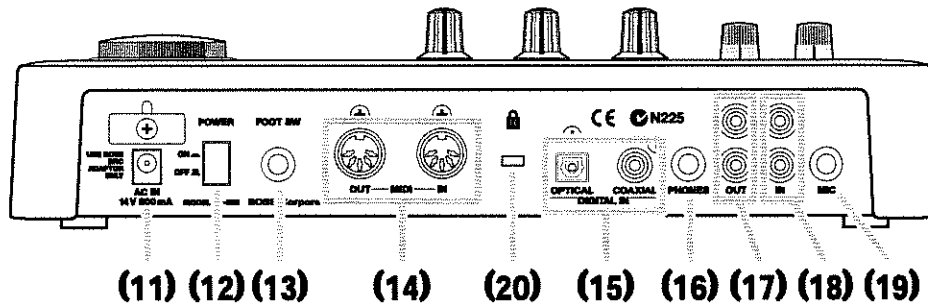

### (11)

#### AC Adaptor Jack

Connect the supplied AC adaptor (BRC series) to this jack.

\* *Never use any AC adaptor other than the one that was supplied with the SP-505. Doing so can cause malfunctions.*

### (12)

#### POWER Switch

This switch turns the power on/off.

### (13)

#### FOOT SW (Foot Switch) Jack

A separately available foot switch (FS-5U) can be connected here, allowing you to start/stop playback of a pattern or song.

### (14)

#### MIDI IN/OUT Connectors

These connectors allow external MIDI devices (sequencers, keyboards, rhythm machines, etc.) to be connected.

Use a MIDI cable (sold separately) to make connections.

### (15)

#### DIGITAL IN Jacks OPTICAL/COAXIAL

These are input jacks for digital audio signals. Both optical and coaxial types are provided.

### (16)

#### PHONES (Headphone) Jack

By connecting headphones, you can hear the same sound as that output from LINE OUT. A stereo phone plug can be connected here.

### (17)

#### LINE OUT Jacks L/R

These are stereo RCA phono audio output jacks, which can be used to output the sound to an amp or mixer.

### (18)

#### LINE IN Jacks L/R

These are stereo RCA phono audio input jacks for connection to an audio source device that you want to sample, such as a CD player.

### (19)

#### MIC Jack

An external mic can be connected to this jack.

### (20)

#### Security Slot (🔒)

<http://www.kensington.com/>

# Quick Start

## Making the Connections

1. Make sure of the following for all the equipment you will be connecting.
  - The power is turned off.
  - The volume is turned down.
2. Connect the AC adaptor (BRC series) to the AC adaptor jack, and plug it into an AC outlet.

- \* Use only the BRC series. If you use any other AC adaptor, you risk causing malfunction and/or damage.
- \* To prevent the inadvertent disruption of power to your unit (should the plug be pulled out accidentally), and to avoid applying undue stress to the AC adaptor jack, anchor the power cord using the cord hook, as shown in the illustration.

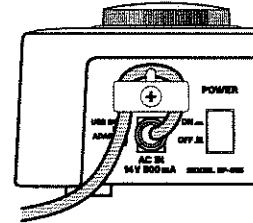

3. Connect the audio cables and MIDI cables as shown in the diagram.

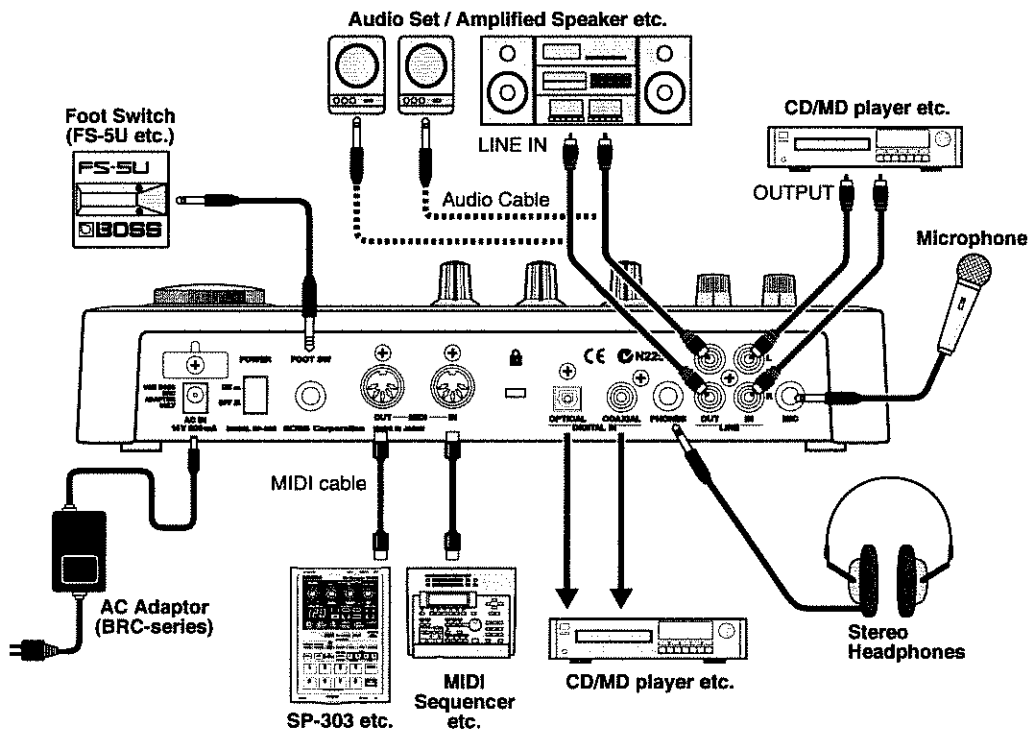

- \* To prevent malfunction and/or damage to speakers or other devices, always turn down the volume, and turn off the power on all devices before making any connections.
- \* If you connect a foot switch (FS-5; sold separately) to the FOOT SW jack, set the polarity switch as shown below.
- \* Howling could be produced depending on the location of microphones relative to speakers. This can be remedied by:
  1. Changing the orientation of the microphone(s).
  2. Relocating microphone(s) at a greater distance from speakers.
  3. Lowering volume levels.

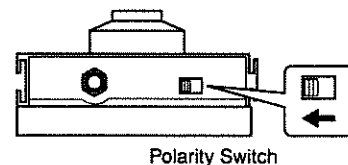

## Turning the power on

Once the connections have been completed, turn on power to your various devices in the order specified. By turning on devices in the wrong order, you risk causing malfunction and/or damage to speakers and other devices.

1. Before turning on the power, check the following points:
  - Have the connections been made correctly?
  - Have you turned down the volume on the SP-505 and all connected devices?
  - If you are using a memory card, make sure that it is firmly inserted all the way.

### NOTE

If the memory card is inserted only halfway into the card slot when the power is turned on, not only the card but the data in the SP-505 itself will be damaged.

If you insert or remove a card with the power turned on, or turn on the power when a card is inserted halfway, a message of "WARNING! Data Maybe Damaged!" will appear, and operation will stop. If this occurs, turn off the power, insert the card all the way or remove it, and then turn the power on once again.

2. Turn on the POWER switch located on the rear panel of the SP-505.
  - \* Even when the volume is turned down, you may notice some noise when the power is turned on, but this does not indicate a malfunction.

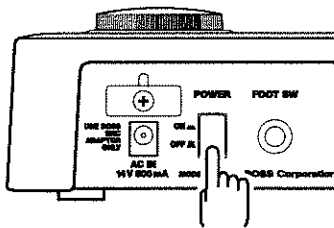

This unit is equipped with a protection circuit. A brief interval (a few seconds) after power up is required before the unit will operate normally.

3. Turn on the power of the connected devices.

4. While striking the pads of the SP-505, turn the VOLUME knob to adjust the volume appropriately.
  - \* If you have connected an external amp, slightly raise the volume of the external amp before you turn the SP-505's VOLUME knob.

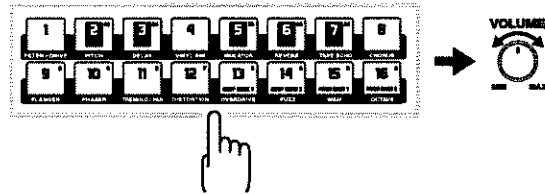

## Turning the power off

1. Before you turn off the power, check the following points.
  - Are the volume controls of the SP-505 and connected equipment turned down?
2. Turn off the power of the connected equipment.
3. Turn off the POWER switch of the SP-505.

### NOTE

Never turn off the power while "Keep Power On!" appears in the display.

## The SP-505's display

Broadly speaking, the SP-505 displays two types of screens.

### Parameter list display

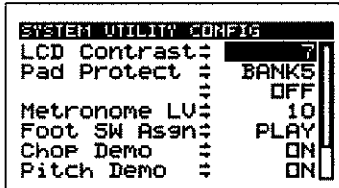

The scroll bar in the right of the screen shows the current location of the cursor relative to the entire list.

- Press CURSOR [↑] [↓] to move the cursor up or down in steps of a single line.
- Press [PAGE UP][PAGE DOWN] to move the cursor in steps of an entire page.
- Use the VALUE dial to edit the parameter.

### Wave display

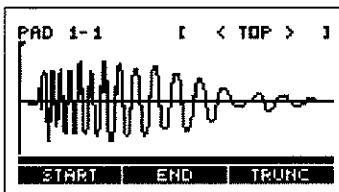

- Press [L/R] to switch between the left channel (Lch) and right channel (Rch) of a stereo sample.
- Press [ZOOM IN][ZOOM OUT] to zoom-in or zoom-out on the horizontal axis (time axis) of the waveform.
- Hold down [L/R] and press [ZOOM IN][ZOOM OUT] to expand or shrink the vertical axis (amplitude axis) of the waveform.
- Press CURSOR [←][→] to move the displayed area of the waveform in the horizontal direction.
- Use the VALUE dial to move the wave pointer.

### Sub-window display

You can switch sub-windows by pressing the following six buttons.

- [PAD BANK]
- [PAD ACCENT]
- [BPM/TAP]
- [FX INFO]
- [FX SELECT]
- [FX ASSIGN]

(Example) When you press [PAD BANK]



In a sub-window, you can press [EXIT] to return to the previous screen.



## Press the pads to play sounds

The SP-505 contains already-sampled sounds such as drum and bass. You can play these sounds by pressing the pads.

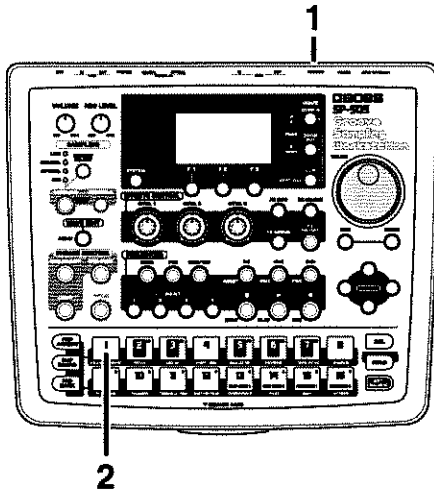

1. Turn on the POWER switch of the SP-505.
2. Press pad [1].  
You will hear a drum sound.  
Pads [2]–[16] also contain drum sounds. Press the pads to play the drums.

The SP-505 can play samples that were sampled on the SP-303.

1. Use the SP-303 to sample a sound into bank C or D (memory card).
2. Insert the memory card containing the sample into the card slot of the SP-505.
3. Change the SP-505's pad bank to 17. (p. 30)
4. Press a pad.  
You will hear the sound that was sampled on the SP-303.

\* If an SP-303 memory card is used by the SP-505, the SP-505's own files may be saved on the memory card. This will reduce the available space on the memory card.

## Listening to the preset patterns

The SP-505 contains 40 preset patterns, each consisting of several measures.

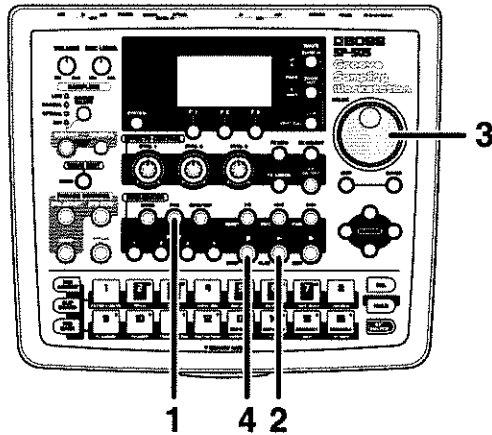

**1. Press [PTN].**

Make sure that the display shows the following.

(For a preset pattern)

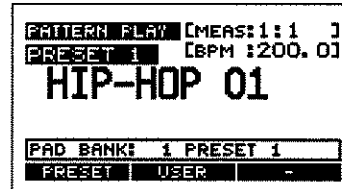

(For a user pattern)

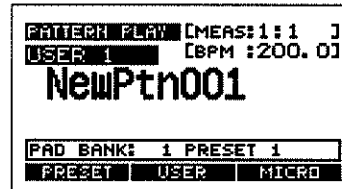

**MEMO**

A display like those shown above is called the "Play screen."

**2. Press [PLAY].**

The pattern will play.

During playback, [PLAY] will blink in time with the BPM (tempo).

\* At the factory settings, the user patterns do not contain anything.

**3. Use the VALUE dial to select the pattern that you want to play next.**

When the currently playing pattern reaches the end, playback will switch to the selected pattern.

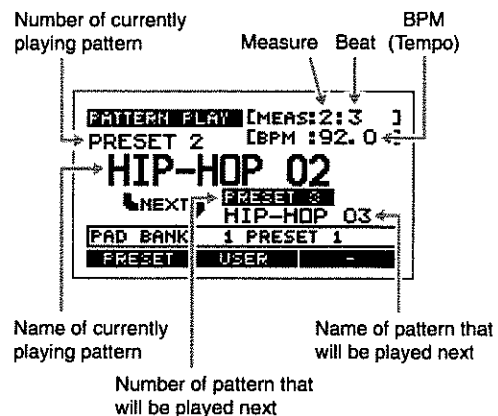

**4. To stop playback, press [STOP].**

## An overview of the SP-505

### How the sections of the SP-505 are connected

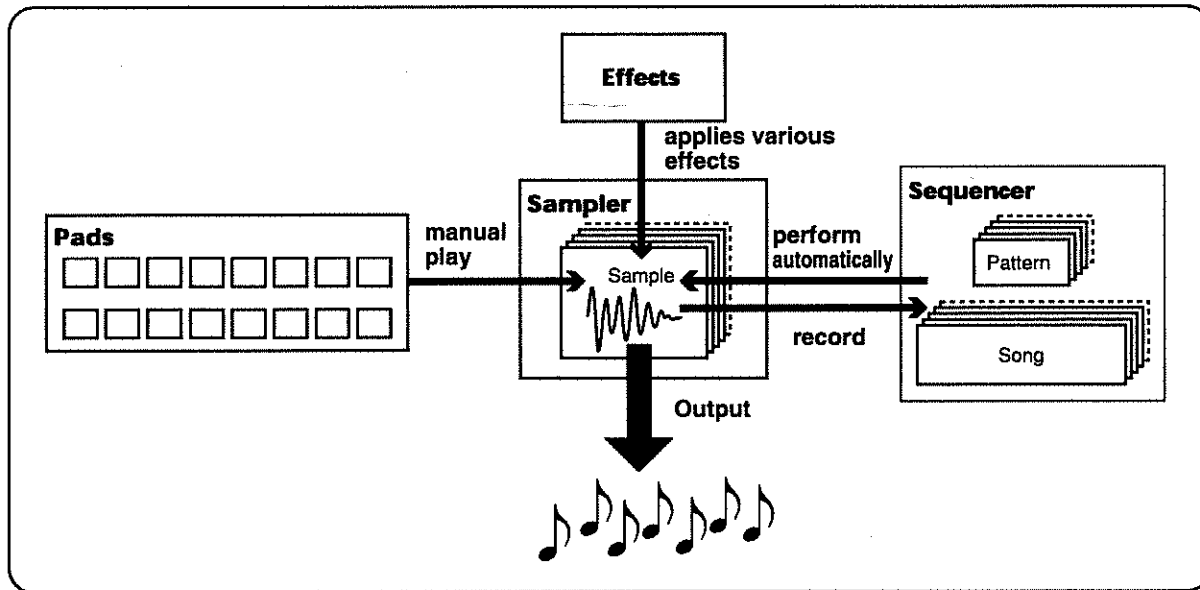

#### Sampler

The SP-505 does not contain a sound generator (a section that creates sound). Instead, it records (samples) various sounds such as music and vocals, and plays back these sounds.

#### Effects

This section applies various effects to the sampled sound (samples). You can select from 26 different effects, such as Reverb, which adds reverberation; and Lo Fi Processor, which gives the sound a "lo-fi" character.

#### Pads

You can play samples by striking the pads. Think of these as switches that play samples.

#### Sequencer

This section lets you record the timing at which samples are played. By playing back this data, you can make the SP-505 perform "automatically."

### How the SP-505 is organized

The SP-505 uses three data structures: "samples," which contain sound, "patterns," which contain performances, and "songs," which consist of patterns joined together.

#### What is a sample?

A sample is a "sound" consisting of a sampled waveform (e.g., performance, instrumental sound, vocal) and various settings that determine how the sample will be played. A sample can be assigned to a pad and played, or it can be played from the internal sequencer or an external sequencer. The SP-505 contains 64 internal samples (preset samples), and also allows you to record 128 of your own samples (user samples). Up to 256 user samples can be stored on a separately available memory card.

Depending on how it is intended to be played, a sample can be classified as one of two types: a phrase sample or a single sample.

## Quick Start

### Phrase samples

A sample of an actual performance is generally called a "phrase sample."

When using a phrase sample on the SP-505, set the Play Type sample parameter to "PHRASE." This allows the BPM (tempo) of the sample to automatically be adjusted to match the playback BPM of the sequencer BPM.

The sample BPM can be adjusted in a range of 0.5–1.3 times.

- \* If the sequencer BPM exceeds the allowable BPM range of the sample, the BPM of the sample will be doubled or halved to stay within the allowable range. This setting is suitable for phrases that are one or two measures long.

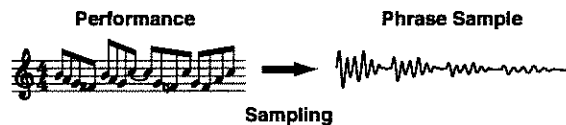

### Single samples

Short samples are generally called "single samples."

When using a single sample on the SP-505, set the Play Type parameter to "SINGLE." With this setting, the sample will always be played at its own BPM (tempo).

This is suitable for sounds that are played as individual notes, such as drums or sound effects.

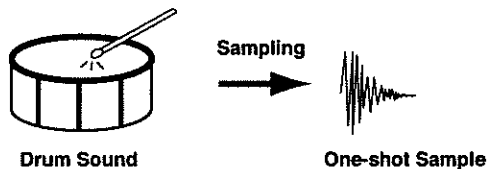

### What is a pattern?

A pattern is performance data (sequence data) between one and eight measures long, which records the timing at which samples are played. A pattern consists of four parts, and each track can record a separate performance for sounds such as drums or bass. You can think of samples as being like instruments, while patterns are comparable to the musical score.

You can keep switching patterns during playback, or join patterns together to create a song.

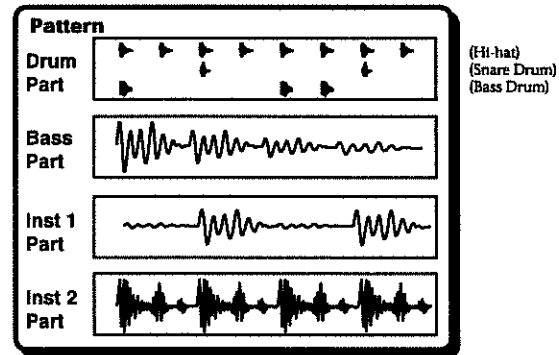

The internal memory of the SP-505 contains 40 preset patterns suitable for dance rhythms, and 100 user patterns in which your own sequence data can be freely recorded.

- \* A pattern simply records the timing at which a sample is sounded, and does not record the sample itself. Thus if you overwrite a sample, the content of the performance will change.
- \* A pattern can be a maximum of eight measures long.
- \* When a phrase sample is played, the BPM (tempo) of the phrase sample itself is ignored, and the BPM (tempo) of the pattern will be used.

### What is a song?

A "song" consists of several patterns joined in the desired order of playback. You can create a song beforehand, and then simply play it back on the sequencer when you need to perform live. Up to twenty songs can be stored in internal memory.

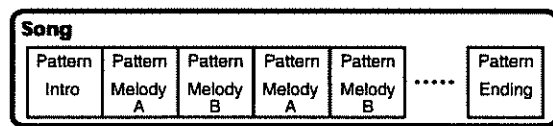

- \* A song simply contains information about the order in which patterns are to be played back; it does not contain the sequence data of the patterns themselves. This means that if you modify the sequence data of one or more of the patterns, the result obtained when playing back the song will also change.
- \* When you play back a song, you can enable the BPM (tempo) specified for each pattern (p. 55).

## Applying effects

The SP-505 contains 26 different effects.

You can use these effects to modify the sound of the sampled phrases.

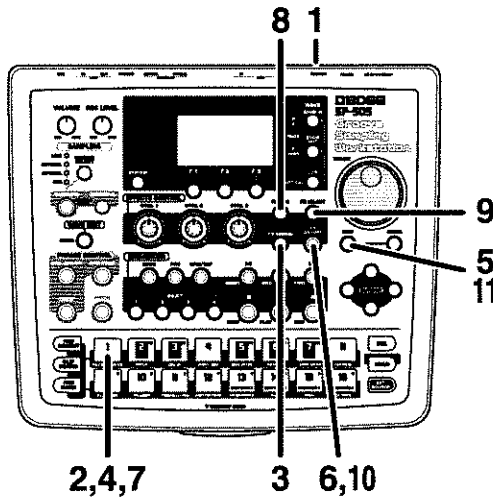

1. Turn on the POWER switch of the SP-505.
2. Press pad [1].  
The sample will play.
3. Press [FX ASSIGN] in the Effect section.
4. Press the pad to which you want to apply an effect.  
For this example, press pad [1] so that [1] is highlighted.

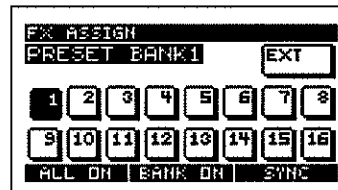

5. Press [EXIT].
6. Press [FX ON/OFF] in the Effect section, illuminating the button.
7. Once again press pad [1].  
The effect will be applied to the sound of the preset sample.
8. If you want to see the current effect settings, press [FX INFO].  
The display will show the currently selected effect name, and the parameters that can be controlled by the CTRL 1-3 knobs.

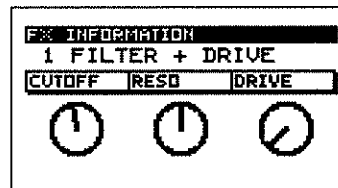

9. To change the effect, press [FX SELECT].  
A list of the effects will be displayed.  
Effect nos. 1-16 can be selected directly by pressing pads [1]-[16]. For effect no. 17 and higher, turn the VALUE dial to select the effect, and press [ENTER] to confirm your selection.
10. To turn off the effect, press [FX ON/OFF] to make the button go dark.
11. Press [EXIT] to return to the Play screen.

## Recording a sample

The SP-505 can sample for a maximum of approximately 17 minutes using its internal memory.

- \* With the exception of special cases such as personal use, unauthorized use of samples taken from a CD, record, tape, video, or broadcast copyrighted by a third party is forbidden by law.

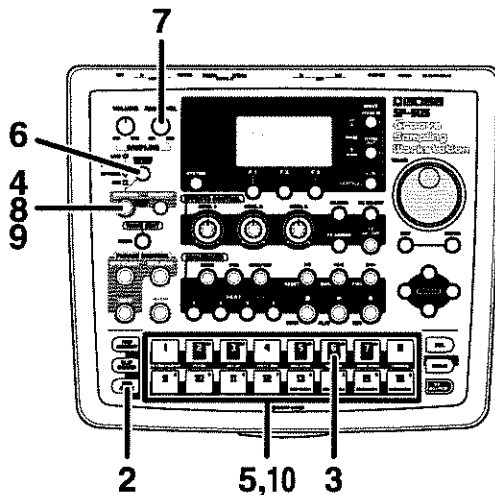

1. Connect your CD player to the SP-505's LINE IN jacks or DIGITAL IN jack.
2. Press [PAD BANK].  
A list of the pad banks will be displayed.



3. Select the Pad Bank.  
For this example, press pad [6] to select USER BANK 2.  
\* At the factory settings, USER BANK 1 is protected, so sampling is not possible. To disable protection, turn the SYSTEM UTILITY CONFIG Pad Protect setting OFF. For details of the procedure, refer to "Chapter 13. Making system settings" (p.73).
4. Press [SAMPLING].  
[SAMPLING] will blink, and you will be in sampling-standby mode.  
At this time, pads to which no sample has been assigned will blink.

### NOTE

Never turn off the power while the display indicates "Keep Power On!"

- \* If you decide to cancel sampling, press [EXIT].
5. Press a pad to select the pad to which you intend to sample.  
\* If a sample is already assigned to the selected pad, the display will ask "OK to Overwrite?" If you want to sample to that pad, press [F1] (YES). To cancel, press [F2] (NO).
  6. Press [SOURCE SELECT] to select LINE IN, COAXIAL, or OPTICAL.  
\* If you select COAXIAL or OPTICAL, the display will indicate "Awaiting Digital Signal" until a digital signal is detected.  
\* Noise may occur if an unstable digital signal is input.
  7. Adjust the sampling level.  
Play back the CD, and turn the REC LEVEL knob to adjust the level so that the third "□" from the top in the level meter shown in the display becomes black occasionally.  
\* If COAXIAL or OPTICAL are selected, the REC LEVEL knob will have no effect.

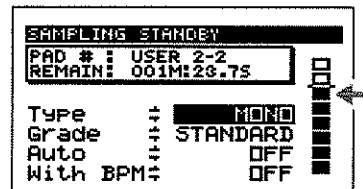

8. At the point you want to begin sampling, press [SAMPLING].  
[SAMPLING] will change from blinking to solidly lit, and sampling will start.

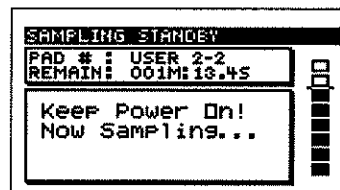

9. At the point you want to stop sampling, press [SAMPLING].  
Sampling will stop.

\* Sampling will stop automatically if you exceed the available sampling time.

10. Press the pad to play back the sampled sound.

### MEMO

When sampling ends, the BPM will be calculated automatically from the length of the sample. You can use the BPM Adjust function (p. 24) or BPM Sync function (p. 25) to edit this BPM.

### MEMO

If the beginning or end of the sample contains unwanted sound or silence, you can make settings so that only the desired portion is played. For details refer to p. 46, "Specifying the start/end points of the sound (Omitting unwanted portions)."

### NOTE

Never turn off the power while the display indicates "Keep Power On!"

## If you are not satisfied with the sampled sound

Delete the sampled sound, and try the procedure again from step 2.

Here's how to delete a sample.

1. Press [DEL].
2. Press the pad to which the sample you want to delete is assigned. The pad number will be highlighted.  
You may select more than one pad simultaneously.  
You can cancel your selection by pressing the pad once again.

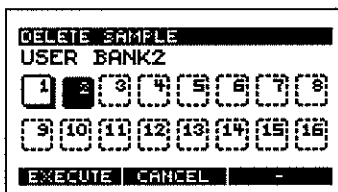

3. Press [F1] (EXECUTE).  
To cancel, press [F2] (CANCEL) or [EXIT].

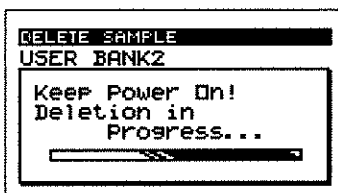

The sample will be deleted.

## Changing the BPM (tempo) of the sample (BPM Adjust)

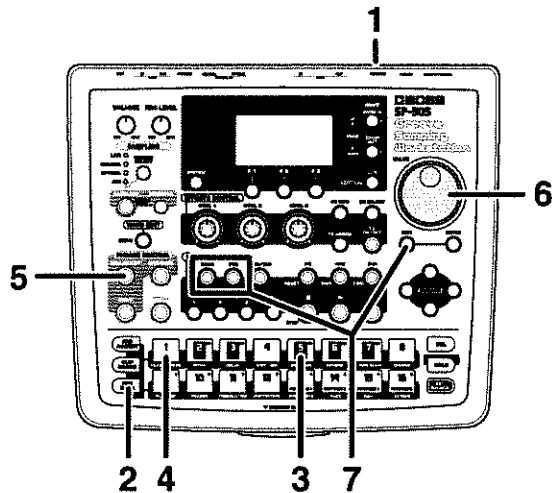

1. Turn on the POWER switch of the SP-505.
2. Press [PAD BANK].  
A list of the pad banks will be displayed.

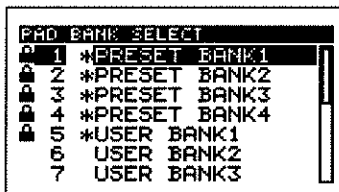

3. Select the pad bank.  
For this example, press pad [5] to select USER BANK 1.
4. Press pad [1].  
The sample will play.

5. Press [BPM ADJUST].

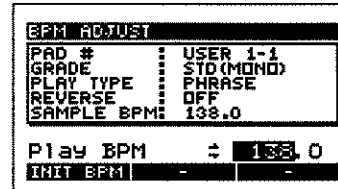

- PAD#:** The number of the currently selected pad  
(Example) USER1-1: Pad [1] of user bank 1
- GRADE:** Sampling grade (stereo/mono)  
STD (Standard), LONG, LO-FI
- PLAY TYPE:** PHRASE, SINGLE
- REVERSE:** ON, OFF
- SAMPLE BPM:** BPM of the currently selected sample

6. Use the VALUE dial to adjust the BPM.

You can adjust the value in steps of one BPM over a range of 40.0–200.0.

You can also press CURSOR [→] to adjust the value in steps of 0.1 BPM.

- \* The sample BPM can be adjusted in a range of 0.5–1.3 times its original value. If you make settings that exceed the allowable BPM range of the sample, the sample BPM will be doubled or halved to stay within the allowable range. Press a sampled pad, and notice that the BPM has changed.
- \* You may notice more noise if you change the BPM (tempo).
- \* It is not possible to adjust the BPM of a sample whose Play Type is set to SINGLE.
- \* If the sample is shorter than approximately 200 ms, changes in BPM will not be reflected.
- \* It is not possible to adjust the BPM of a sample that is set to reverse playback.
- \* To return to the original BPM, press [F1] (INIT BPM).

7. Press [EXIT], [SONG], or [PTN] to return to the Play screen.



## Synchronizing the BPM (tempo) of several samples (BPM Sync)

You can synchronize the BPM of the sixteen pads in the currently selected pad bank.

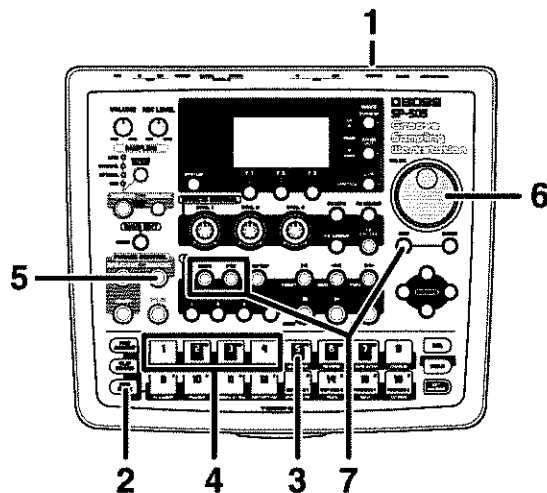

1. Turn on the POWER switch of the SP-505.
2. Press [PAD BANK].  
A list of the pad banks will be displayed.



3. Select the pad bank.  
For this example, press pad [5] to select USER BANK 1.
4. Press pad [1], [2], [3], and [4].  
The sample will play.
5. Press [BPM SYNC].  
The BPM will be synchronized.  
The currently playing sound will begin playing once again from the beginning of the sample.

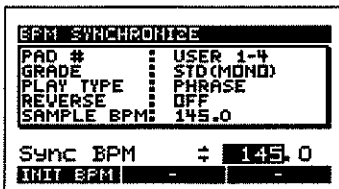

- PAD#:** Currently selected pad number  
(Example) USER1-4: Pad [4] of user bank 1
- GRADE:** Sampling grade (stereo/mono)  
STD (Standard), LONG, LO-FI
- PLAY TYPE:** PHRASE, SINGLE
- REVERSE:** ON, OFF
- SAMPLE BPM:** BPM of the currently selected sample

6. Use the VALUE dial to adjust the BPM.  
You can adjust the value in steps of one BPM over a range of 40.0-200.0.  
You can also press CURSOR [→] to adjust the value in steps of 0.1 BPM.
  - \* The sample BPM can be adjusted in a range of 0.5-1.3 times its original value. If the synchronized BPM exceeds the allowable range of the sample BPM, the sample BPM will be doubled or halved to stay within the allowable range. Simultaneously press each of the pads you sampled, and notice that the BPM is synchronized.
  - \* You may notice more noise if you change the BPM (tempo).
  - \* It is not possible to adjust the BPM of a sample whose Play Type is set to SINGLE.
  - \* If the sample is shorter than approximately 200 ms, changes in BPM will not be reflected.
  - \* It is not possible to adjust the BPM of a sample that is set to reverse playback.
  - \* To return to the original BPM, press [F1] (INIT BPM).
7. Press [EXIT], [SONG], or [PTN] to return to the Play screen.
  - \* If you repeatedly loop samples, synchronization may drift.
  - \* Synchronization may drift if you change the BPM while the sounds play.

## Dividing a sample between several pads (Chop)

The "Chop" function of the SP-505 detects the attacks within a sampled phrase, and divides the original sample into samples containing individual sound events.

The divided samples will be assigned to the 32 pads of "chop banks (1-2)" (pad banks 13-14).

- \* It is not possible to divide the samples of the Chop bank.
- \* It is not possible to divide a stereo sample.
- \* If the phrase contains a large number of notes, or simultaneously sounding notes, it may not be divided as you expect.
- \* The sample start/end point settings will be ignored.

**MEMO**

When shipped from the factory, there is data suitable for testing a chop function in USER 1-5.

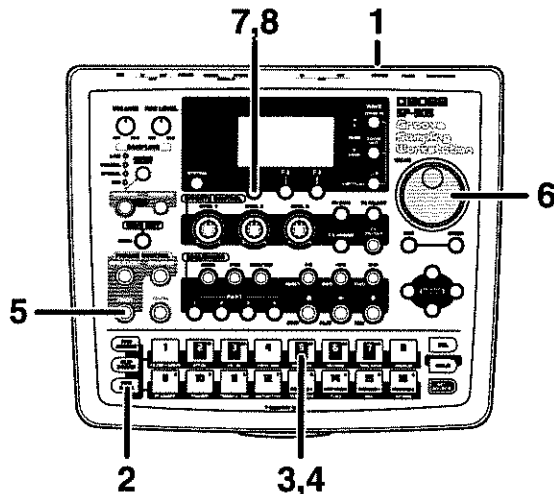

1. Turn on the POWER switch of the SP-505.
2. Press [PAD BANK].  
A list of the pad banks will be displayed.

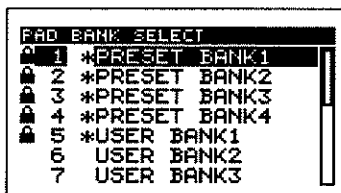

3. Select the pad bank.  
For this example, press pad [5] to select USER BANK 1.
4. Press pad [5].  
The sample will play.

5. Press [CHOP].

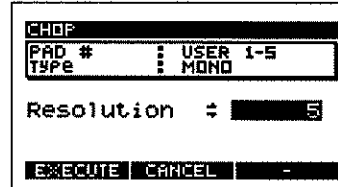

6. Use the VALUE dial to set the detail (RESOLUTION) at which the sample will be divided.  
Higher settings will cause the sample to be divided into a larger number of samples.

7. To execute the operation with the resolution level you specified in step 6, press [F1] (EXECUTE).  
To cancel, press [F2] (CANCEL).

\* If you press [F3] (CANCEL) while the display indicates "Processing Data...", the operation will be aborted.

Pads [1]-[16] will light automatically, and will play back the divided sample.

A screen will ask you whether to save the divided samples.

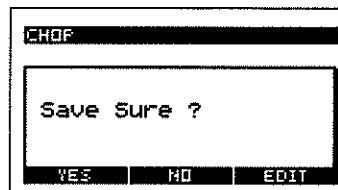

8. To save, press [F1] (YES).  
To cancel, press [F2] (NO) or [EXIT].

\* If pad banks 13-14 (Chop banks; p. 29) already contain samples, a message of "OK to Overwrite?" will appear. If you do not mind changing the samples of pad banks 13-14, press [F1] (YES). To cancel, press [F2] (NO).

**NOTE**

Never turn off the power while the display indicates "Keep Power On!"

## Playing pitches with a sample (Pitch)

The SP-505's "Pitch" function lets you play different pitches with a sample.

- \* It is not possible to play pitches with a stereo sample.
- \* It is not possible to play pitches with samples of the Pitch bank.

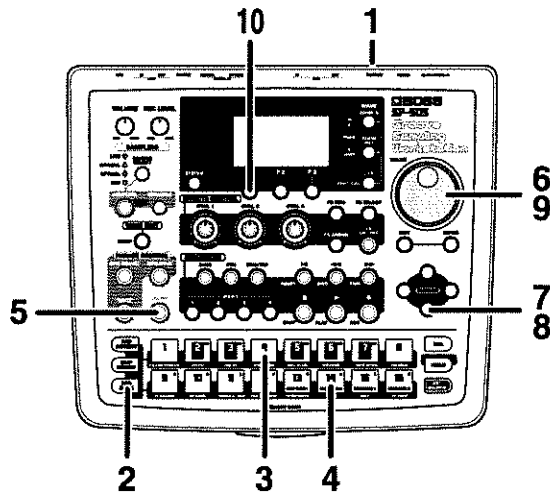

1. Turn on the POWER switch of the SP-505.
2. Press [PAD BANK].  
A list of the pad banks will be displayed.



3. Select the pad bank.  
For this example, press pad [4] to select PRESET BANK 4.
4. Press the pad of the sample that you want to use to play pitches.  
For this example, press pad [14].
5. Press [PITCH].

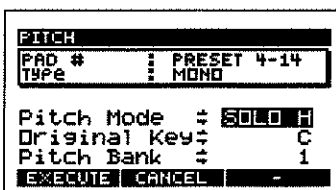

6. Use the VALUE dial to select the mode.  
**Pitch Mode**  
**SOLO L:** Suitable for single-note samples of low-range instruments such as bass.  
**SOLO H:** Suitable for single-note samples of high-range instruments such as piano or guitar.  
**MUSIC:** Suitable for most music samples.  
\* Depending on the sample, it may not be possible to play pitches successfully.
7. Press CURSOR [↓] to move the cursor to "Original Key."  
You can select one of the pad sounds, and use it to play scaled pitches. Use the VALUE dial to select the pad whose sound you want to use to play scales.  
**Original Key:** C, C#, D, D#, E, F, F#, G, G#, A, A#, B, C <UP>  
In this case, set this to G.  
Pads correspond to keys as follows.

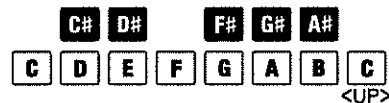

8. Press CURSOR [↓] to move the cursor to "Pitch Bank."
9. Use the VALUE dial to select the pitch bank.  
**Pitch Bank:** 1, 2
10. To execute the Pitch function, press [F1] (EXECUTE).  
To cancel, press [F2] (CANCEL) or [EXIT].  
Pads [2]–[16] will light automatically, and will play the sample at different pitches.

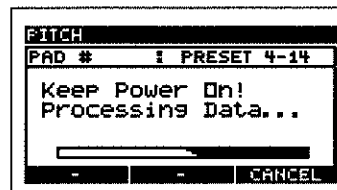

- \* Depending on the volume of the original sample, the sound may distort if you use the Pitch function. In this case, lower the volume of the original sample. (p. 44; "Adjusting the volume of a sample")
- \* While the display indicates "Processing Data...", you can press [F3] (CANCEL) to abort the operation.
- \* If the pitch bank (1 or 2) already contains samples, a message of "OK to Overwrite?" will appear. If it is ok to change the samples of the pitch bank, press [F1] (YES). To cancel, press [F2] (NO).

## Quick Start

- \* *When you play pitches using a sample, unwanted space may occur at the beginning or end of the sound. After the Pitch function is executed, settings will be made automatically, so only the necessary portion is sounded. If you want to make fine adjustments, refer to "Specifying the start/end points of the sound (Omitting unwanted portions)" (p.46).*

### NOTE

Never turn off the power while the display indicates "Keep Power On!"

# Chapter 1. Playing samples from the pads

## What are the 32 pad banks?

A group of 16 samples assigned to the pads of the front panel is called a “pad bank.”

There are a total of 32 pad banks, allowing you to use a maximum of 506 samples.



Refer to p. 30, “Switching pad banks”

### Pad banks 1-4

Pad banks 1–4 of the SP-505 contain preset samples. These preset samples cannot be erased.

### Pad banks 5-12

Ordinary samples can be stored in these banks.

### Pad banks 13-16

The SP-505 has “Chop” (p. 26, 51) and “Pitch” (p. 27, 54) functions that process a sample in special ways. Samples that are newly created by these functions are stored in special pad banks reserved for these purposes.

#### Pad banks 13 and 14 (Chop banks 1 and 2):

These banks are used to store samples created by the “Chop” function.

#### Pad banks 15 and 16 (Pitch banks 1 and 2):

These banks are used to store samples created by the “Pitch” function.

\* *Ordinary sampling cannot be carried out with respect to the chop banks or pitch banks.*

### About pad banks 17-32 (Card banks 1-16)

These banks are for saving samples on a memory card.

## Basic ways to play samples

When you press a pad, the sample assigned to that pad will sound.

You can also play a sample by pressing a pedal switch (FS-5U; sold separately) connected to the FOOT SW jack (p. 14).

In this case, you must specify which of the sixteen samples will be played (p. 73).

The SP-505 is able to play samples that were recorded by the SP-303.

1. On the SP-303, sample into bank C or D (memory card).
2. Insert the memory card containing the samples into the SP-505.
3. Change the SP-505's pad bank to 17. (p. 30)
4. Press a pad.

You will hear the sound that was sampled on the SP-303.

\* *If an SP-303 memory card is used in the SP-505, the SP-505's own files may be saved on the memory card. This will reduce the available amount of space on the memory card.*



### The number of samples that can be played simultaneously

A total of eight sounds, including those played back by a song/pattern and those played from the pads, can be played simultaneously. Each stereo sample counts as two sounds. If more than eight pads are pressed, the sample of the last-pressed pad will be given priority and will sound, and the sample of a pad you pressed earlier will stop sounding. Samples whose phrase type is set to Phrase (p. 45) will take priority over Single samples.

### Switching the pad bank

1. Press [PAD BANK].

A list of pad banks will appear. The number of the currently selected pad bank will be highlighted.

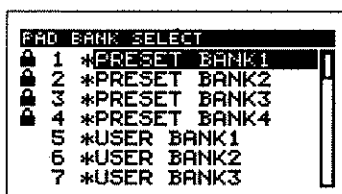

2. Use the VALUE dial to select a pad bank.

Pad banks 1–16 can be selected directly by pressing pads [1]–[16]. To select number 17 or later, turn the VALUE dial to select the pad bank, and press [ENTER] to confirm your selection.

The selected pad bank will appear in the display.

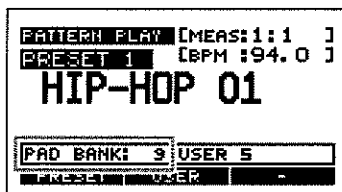

- \* Pad banks 17–32 are for the memory card. They cannot be selected if a memory card is not inserted.

### Switching the pad accent

You can adjust the volume at which a pad will sound when you press it.

- \* The pad accent setting is not remembered. It reverts to 127 each time the power is turned on.

1. Press [PAD ACCENT].

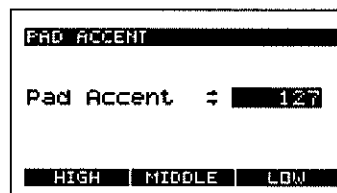

2. Use the VALUE dial to adjust the accent.

Range: 1–127

[F1] (HIGH) sets the accent to 127.

[F2] (MIDDLE) sets the accent to 100.

[F3] (LOW) sets the accent to 80.

3. Press [EXIT], [SONG], or [PTN] to return to the Play screen.

### Using the Hold function to play samples

By using the Hold function, you can make a sample continue sounding even after you release your finger from its pad.

This is convenient when you want to continuously play a looped phrase sample.

However, even in this case, it is not possible to exceed the limitation of eight simultaneous notes.

- \* Hold is valid only for samples that are set to Gate playback. The Hold function will not work for samples that are set to Trigger playback or Drum playback (see section below).

1. Press a pad to play a sample.
2. While the sample is playing, press [HOLD] before you remove your finger from the pad.  
Hold will be turned on for the pad, and the sample will continue playing even after you remove your finger from the pad.
3. If you once again press the pad that is sounding, or press [HOLD], the sound will stop.

- \* When you press [HOLD] once again, all sounds that were being held will stop.

## Changing how the sample sounds or stops (Pad Play)

You can select one of the following Pad Play settings to specify how the sample will play when you press a pad.

### TRIG (trigger):

The sound will start when you press the pad, and continue even after you release the pad. Press the pad once again to stop the sound.

### GATE:

The sound will start when you press the pad, and stop when you release the pad.

### DRUM:

The sound will start when you press the pad, and will stop automatically at the End Point (p. 46) of the sample.

\* If you select "DRUM," the loop settings (see item below) will be ignored, and the sample will play only once. This setting is suitable for playing phrases from a MIDI drum pad or similar controller.

If DRUM is selected, the sound cannot be interrupted, so be careful when using this setting for an extremely long sample.

1. Press the pad of the sample for which you want to make settings.
2. Press [WAVE EDIT].
3. Use CURSOR [↓] [↑] to move the cursor to the "Pad Play" line.

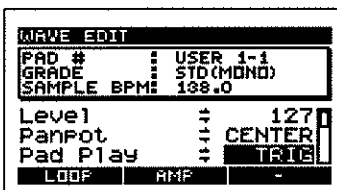

4. Use the VALUE dial to select either "TRIG," "GATE," or "DRUM."
  - If you want to make settings for another sample in the same pad bank, press the pad for that sample and repeat steps 3 and 4.
  - If you want to make settings for a sample in a different pad bank, switch the pad bank (p. 30), press the pad for that sample, and repeat steps 3 and 4.
5. Press [EXIT], [SONG], or [PTN] to return to the Play screen.

## Looping the sound (Loop Mode)

"Looping" refers to making the sample continue playing repeatedly from the beginning (Start Point) to the end (End Point). On the SP-505 you can create basic rhythms by looping samples.

For each sample, you can select one of the following settings (Loop Mode).

**OFF:** Don't loop

**ON:** Loop (from the Start Point to the End Point)

1. Press the pad of the sample for which you want to make settings.
2. Press [WAVE EDIT].
3. Press CURSOR [↓] [↑] to move the cursor to the "Loop Mode" line.

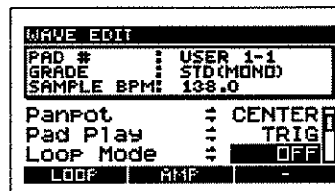

4. Use the VALUE dial to select "OFF" or "ON."
  - If you want to make settings for another sample in the same pad bank, press the pad for the sample that you want to set, and perform steps 3 and 4.
  - If you want to make settings for a sample in a different pad bank, change pad banks (p. 30), press the pad for the sample that you want to set, and perform steps 3 and 4.
5. Press [EXIT], [SONG], or [PTN] to return to the Play screen.

### NOTE

Never turn off the power while the display indicates "Keep Power On!"

### Playing a sample backward (Reverse Playback)

"Reverse playback" plays a sample backward, producing the effect similar to when a tape is played in the reverse direction.

For each sample, you can select one of the following reverse settings.

**OFF:** Don't reverse

**ON:** Reverse

1. Press the pad of the sample for which you want to make settings.
2. Press [WAVE EDIT].
3. Use CURSOR [↓] [↑] to move the cursor to the "Reverse" line.

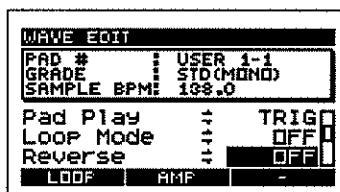

4. Use the VALUE dial to select "OFF" or "ON."
- If you want to make settings for another sample in the same pad bank, press the pad for the sample that you want to set, and perform steps 3 and 4.
- If you want to make settings for a sample in a different pad bank, switch pad banks (p. 30), press the pad for the sample that you want to set, and perform steps 3 and 4.
5. Press [EXIT], [SONG], or [PTN] to return to the Play screen.

#### NOTE

Never turn off the power while the display indicates "Keep Power On!"

### Playing an audio input signal (EXT Source)

Even without sampling, the SP-505 lets you use a pad to control an internal input sound, and start/stop the sound and apply effects in the same way as a sample.

1. Connect a CD player or mic.

Connect your CD player to the LINE IN jacks, or your mic to the MIC jack.

\* It is not possible to use digital input (COAXIAL/OPTICAL jacks) as an EXT source.

2. Press [SOURCE SELECT] to select the input.

Select either LINE IN or MIC, depending on the jacks to which you connected your CD player or mic.

3. When you press [EXT SOURCE], getting it to light, the external input source will be heard.

When you press [EXT SOURCE] once again to make it go dark, the external input source will no longer be heard.

4. Use the REC LEVEL knob to adjust the volume.



## Adjusting the EXT source settings

You can change the following settings for the EXT source.

### Type

**MONO:** The Lch and Rch signals from LINE IN will be mixed, and output to LINE OUT.

**STEREO:** The Lch and Rch signals from LINE IN will be output to LINE OUT Lch and Rch respectively.

### Level 0-127

Adjusts the volume.

### Panpot LEFT, CENTER, RIGHT

**LEFT:** Pan the sound to OUTPUT L.

**CENTER:** Pan the sound to the center.

**RIGHT:** Pan the sound to OUTPUT R.

\* If Type is set to STEREO, the Panpot setting will be ignored.

### Pad Play TRIG, GATE

**TRIG:** The sound will begin playing when you press the pad, and stop when you press the pad once again.

**GATE:** The sound will play only while you hold down the pad.

1. Press [EXT SOURCE].
2. Press [WAVE EDIT].
3. Use CURSOR [↓] [↑] to move the cursor to the parameter whose setting you want to adjust.

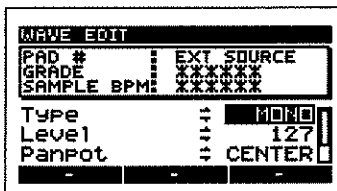

4. Use the VALUE dial to adjust the setting.
5. Press [EXIT], [SONG], or [PTN] to return to the Play screen.



Never turn off the power while the display indicates "Keep Power On!"

## Changing the BPM of a sample

You can change the BPM of a sampled phrase.

1. Sample a phrase (a one or two measure portion of a song).



"Recording a sample"; p. 22

2. Press the pads to play the sampled phrase.
3. Press [BPM ADJUST].

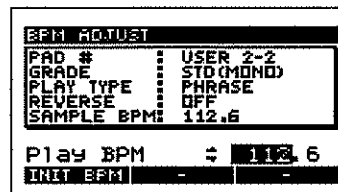

4. Use the VALUE dial to adjust Play BPM.  
The BPM of the currently playing phrase will change. You can also press CURSOR [→] and adjust the setting in 0.1 BPM steps.
  - \* You can press [F1] (INIT BPM) to return to the original BPM.
5. Press [EXIT], [SONG], or [PTN] to return to the Play screen.
  - \* If the Play Type setting for the sample is set to SINGLE, it is not possible to change the BPM. Change the Play Type to PHRASE. (p. 45)
  - \* It is not possible to change the BPM if the sample is set to reverse playback. Turn Reverse OFF. (p. 45)
  - \* If the sample is shorter than approximately 200 ms, changes in BPM will not be reflected.

# Chapter 2. Using the internal effects

- \* You can have any one effect turned on at a given time. Multiple effects cannot be on simultaneously. If you do want to use multiple effects on a sample, or if you need to have a different effect applied to each individual effect, then use "resampling." Resampling allows you to use a sample that has effects added to it as a new sample. For more detailed information, refer to "Re-sampling samples (Resampling)" (p. 42).
- \* The effect settings are not remembered when the power is turned off.

## Selecting pads to which effects are applied (FX Assign)

By using the FX Assign function you can apply an effect to multiple pads, or turn the effect on/off for each pad.

1. Press [FX ASSIGN].

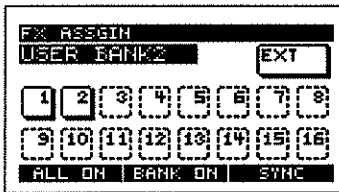

2. Press the pads to turn the effect on/off.

Pressing [F1] (ALL ON/OFF) will turn the effect on/off for the pads of all 32 pad banks.

Pressing [F2] (BANK ON/OFF) will turn the effect on/off for the 16 pads of the currently selected pad bank.

You can press [EXT SOURCE] to apply the effect to the external input sound.

You can also switch the pad bank by turning the VALUE dial.

The effect will not be used (white)

The effect will be used (black)

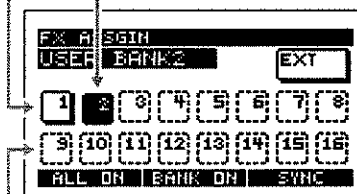

No sample is assigned (dotted line)

- \* You can also use [FX ASSIGN] before the effect is actually applied, to select the pads to which the effect will apply.
- \* When you use VINYL SIMULATOR, NOISE GENERATOR, or RADIO TUNING, the sound of the effect (noise) will be output regardless of the FX assign settings.

3. When you have finished making settings, press [EXIT].

## Selecting the pad that will be the effect synchronization source (SYNC SOURCE)

The delay and slicer effects can be synchronized to the BPM.

- About BPM synchronization for delay and slicer

**Song/pattern playback in progress:**

Synchronized to the BPM of the song or pattern

**Song/pattern playback stopped:**

Synchronized to the BPM of the sample

- \* The BPM of the sample can be viewed in "SAMPLE BPM" in the Wave Edit screen. (p. 44)

Here we will specify the sample (pad) that is to be the sync source while song/pattern playback is stopped.

1. Press [FX ASSIGN].

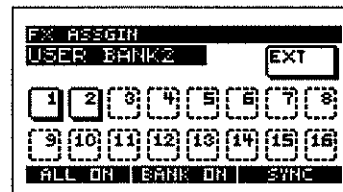

An underline appears below the number of the pad that is currently the sync source.

2. Press [F3] (SYNC).

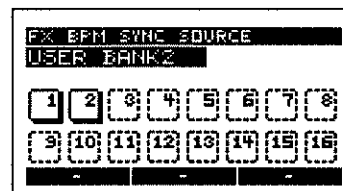

3. Press the pad to specify the sample that is to be the sync source.

Sample is assigned (white)

Specified as the sync source (black)

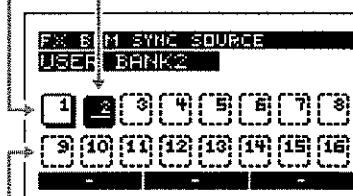

No sample is assigned (dotted line)

- When you have finished making settings, press [EXIT] twice.

## Selecting an effect

- Press [FX SELECT].  
A list of the effects will be displayed. The number of the currently selected effect will be highlighted.



- Use the VALUE dial to select the desired effect.
- Press [ENTER].  
To cancel, press [EXIT].  
The selected effect and the settings of its parameters will be displayed.

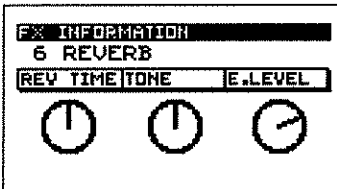

- Press [EXIT], [SONG], or [PTN] to return to the Play screen.

## Using the pads to select an effect

Effect nos. 1-16 can be selected directly by pressing pads [1]-[16].

- Press [FX SELECT].  
A list of the effects will be displayed. The currently selected effect is highlighted.
- Press a pad [1]- [16] to select an effect.  
The effect names are printed below each pad.  
\* Simply selecting an effect will not actually apply that effect. To apply the effect, press [FX ON/OFF] to make the button light and turn the effect on, and select the pad(s) to which you want the effect to be applied (FX Assign; p. 34).
- Press [EXIT], [SONG], or [PTN] to return to the Play screen.

## Turning the effect on/off

The SP-505 contains 26 different effects. You can press [ON/OFF] to select whether these effects will be applied (on) or not (off).

- [FX ON/OFF] lit: The effect will be applied.  
[FX ON/OFF] dark: The effect will not be applied.

## Controlling how the effect is applied

- Turn an EFFECTS CONTROL knob (CTRL 1-3).  
The effect will change in various ways, depending on the knob you operate.
- To see the currently selected effect and the parameter settings of that effect, press [FX INFO].

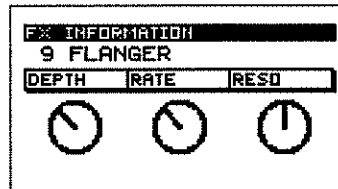

- Press [EXIT], [SONG], or [PTN] to return to the Play screen.

## Chapter 2. Using the internal effects

### Effects List

DSP EFFECTS	CTRL 1	CTRL 2	CTRL 3
<b>1. FILTER + DRIVE</b> Low-pass filter with overdrive. Cuts the high frequencies and adds distortion.	<b>CUTOFF</b> Adjusts the cutoff frequency.	<b>RESO (Resonance)</b> Adjusts the peak level at the cut-off frequency.	<b>DRIVE</b> Adds distortion.
<b>2. PITCH SHIFTER</b> Modifies the pitch.	<b>PITCH</b> Changes the pitch up or down two octaves.	<b>FEEDBACK</b> Adjusts the feedback amount of the pitch shift sound.	<b>BALANCE</b> Adjusts the volume balance between the effect sound and the direct sound.
<b>3. DELAY</b> Repeats the sound.	<b>DLY TIME (Delay Time)</b> Adjusts the time of the delayed sound. (*1)	<b>FEEDBACK</b> Adjust the number of times that the delay will repeat.	<b>E.LEVEL (Effect Level)</b> Specifies the volume of the delay.
<b>4. VINYL SIMULATOR</b> Gives the sound the sonic qualities of an analog record.	<b>COMP (Compressor)</b> Adjusts the sense of compression in the sound that is characteristic of analog records.	<b>NOISE LV (Noise Level)</b> Adjusts the volume of analog record noise.	<b>WOW/F (Wow Flutter)</b> Adjusts the rotational irregularities that occur when playing an analog record.
<b>5. ISOLATOR</b> Extracts and deletes sounds in the low-, mid-, or high-frequency range.	<b>LOW</b> Extracts/ deletes sounds in the low-frequency range.	<b>MID (Middle)</b> Extracts/ deletes sounds in the midrange.	<b>HIGH</b> Extracts/ deletes sounds in the high-frequency range.
<b>6. REVERB</b> Adds reverberation to the sound	<b>REV TIME (Reverb Time)</b> Adjusts the time of reverb.	<b>TONE</b> Adjusts the quality of the reverb.	<b>E.LEVEL (Effect Level)</b> Adjusts the volume of the reverb.
<b>7. TAPE ECHO</b> Vintage tape echo effect.	<b>REPEAT (Repeat Rate)</b> Sets the tape speed.	<b>INTENS (Intensity)</b> Sets the amount of repetition of the echo sound.	<b>E.LEVEL (Effect Level)</b> Adjusts the volume of the echo sound.
<b>8. CHORUS</b> Adds spaciousness and depth to the sound.	<b>DEPTH</b> Sets the depth of the chorus.	<b>RATE</b> Specifies the rate of modulation.	<b>E.LEVEL (Effect Level)</b> Adjusts the volume of the effect sound.
<b>9. FLANGER</b> Adds a undulation like that of a jet ascending or descending.	<b>DEPTH (Depth/Manual)</b> Adjusts the depth of the undulation. When the CTRL 2 knob (RATE) is turned fully counterclockwise, pitch (Manual) is adjusted.	<b>RATE</b> Adjusts the rate of the undulation. When turned fully counterclockwise, the undulation stops, and the pitch (Manual) can be adjusted with the CTRL 1 knob (DEPTH).	<b>RESO (Resonance)</b> Adds a particular undulation to the sound.
<b>10. PHASER</b> Adds a kind of cyclic undulation to the sound.	<b>DEPTH (Depth/Manual)</b> Adjusts the depth of the undulation. When the CTRL 2 knob (RATE) is turned fully counterclockwise, pitch (Manual) is adjusted.	<b>RATE</b> Adjusts the rate of the undulation. When turned fully counterclockwise, the undulation stops, and the pitch (Manual) can be adjusted with the CTRL 1 knob (DEPTH).	<b>RESO (Resonance)</b> Adds a particular undulation to the sound.
<b>11. TREMOLO / PAN</b> Cyclically changes the volume or pan.	<b>DEPTH</b> Adjusts the amount of change in the volume or pan.	<b>RATE</b> Adjusts the rate of change in the volume or pan.	<b>WAVE (Tremolo/Pan Waveform)</b> Changes the periodic curve of the change in volume or pan. When turned counterclockwise, it is the volume that changes; when turned clockwise, the pan changes.
<b>12. DISTORTION</b> Strongly distorts the sound.	<b>DIST (Distortion)</b> Adjusts the depth of distortion.	<b>TONE</b> Adjusts the tonal character.	<b>LEVEL</b> Specifies the volume.

<b>DSP EFFECTS</b>	<b>CTRL 1</b>	<b>CTRL 2</b>	<b>CTRL 3</b>
<b>13. OVERDRIVE</b>	<b>DRIVE</b>	<b>TONE</b>	<b>LEVEL</b>
Mildly distorts the sound.	Adjusts the depth of distortion.	Adjusts the tonal character.	Specifies the volume.
<b>14. FUZZ</b>	<b>DRIVE</b>	<b>TONE</b>	<b>LEVEL</b>
Adds harmonics and distorts the sound.	Adjusts the depth of distortion.	Adjusts the tonal character.	Specifies the volume.
<b>15. WAH</b>	<b>SENS</b>	<b>FREQ (Frequency)</b>	<b>PEAK</b>
Produces a "wah" effect	Adjusts the sensitivity of the Wah effect.	Adjusts the pitch of the effect sound.	Adjusts the wah's peak volume.
<b>16. OCTAVE</b>	<b>-2OCT (-2 Octave Level)</b>	<b>-1OCT (-1 Octave Level)</b>	<b>D.LEVEL (Direct Level)</b>
Adds sound octaves lower.	Adds sound two octaves lower than the original sound.	Adds sound one octave lower than the original sound.	Adjusts the volume level of the direct sound.
<b>17. COMPRESSOR</b>	<b>SUSTAIN</b>	<b>ATTACK</b>	<b>LEVEL</b>
Makes the volume more consistent.	Adjusts the amount of the compressor effect that is applied.	Adjusts the sound's attack.	Specifies the volume.
<b>18. EQUALIZER</b>	<b>LOW</b>	<b>MID (Middle)</b>	<b>HIGH</b>
Adjusts the volume level for each individual frequency range.	Adjusts the volume of the low frequency range.	Adjusts the volume of the midrange.	Adjusts the volume of the high frequency range.
<b>19. LO-FI PROCESSOR</b>	<b>SMPL RTE (Sample Rate)</b>	<b>BIT</b>	<b>FILTER</b>
Gives the sound a "low-fidelity" character.	Adjusts the sampling frequency. (*2)	Adjusts the bit count.	Adjust the sensitivity with which the filter will be affected.
<b>20. NOISE GENERATOR</b>	<b>COLOR</b>	<b>QUALITY</b>	<b>LEVEL</b>
Generates noise.	Adjusts the tone of the hissing noise.	Sets how often the scratch noise is produced.	Adjust the volume level of the hissing noise.
<b>21. RADIO TUNING</b>	<b>TUNING</b>	<b>NOISE LV (Noise Level)</b>	<b>FERQ RNG (Frequency Range)</b>
Reproduces the sound being played on the radio.	Adjusts the degree of noise that occurs when tuning a radio.	Specifies the volume of the noise.	Adjusts the tonal character.
<b>22. SLICER + FLANGER</b>	<b>PTN (Timing Pattern)</b>	<b>RATE</b>	<b>FLANGER</b>
Continuously cuts the sound. Includes a flanger effect.	Select a pattern to specify the timing at which the sound will be cut. (*3)	Adjusts the length of the PTN (Timing Pattern). (*4)	Adjusts the degree of the flanger effect.
<b>23. RING MODULATOR</b>	<b>FREQ (Frequency)</b>	<b>E.LEVEL (Effect Level)</b>	<b>D.LEVEL (Direct Level)</b>
Creates a metallic sound quality.	Adjusts the pitch of the metallic sound.	Adjusts the volume of the effect sound.	Adjusts the volume level of the direct sound.
<b>24. CHROMATIC P.S.</b>	<b>PITCH 1</b>	<b>PITCH 2</b>	<b>BALANCE (Direct/Effect Balance)</b>
Two-voice pitch shifter that changes the pitch in semitone steps.	Changes Pitch 1 up or down one octave in semitone intervals.	Changes Pitch 2 up or down one octave in semitone intervals.	Adjusts the balance of the effect sound and direct sound.
<b>25. VOICE TRANSFORMER</b>	<b>FORMANT</b>	<b>E.LEVEL (Effect Level)</b>	<b>D.LEVEL (Direct Level)</b>
Processes human vocals to produce a variety of different voices.	Adjusts the vocal characteristics (formant).	Adjusts the volume level of the effect sound.	Adjusts the volume level of the direct sound.
<b>26. CENTER CANCELER</b>	<b>L-R BAL (L-R Balance)</b>	<b>LO BOOST (Low Boost)</b>	<b>HI BOOST (High Boost)</b>
Eliminates the vocals and other sounds located at the center.	Finds the best point for deletion.	Boosts the bass and other low-frequency sounds located at the center.	Boosts the high-frequency sounds.

## Chapter 2. Using the internal effects

- (\*1) Of the samples to which the effect is applied, the time (delay time) is specified in note value units relative to the tempo of the sample of the sync-source pad.







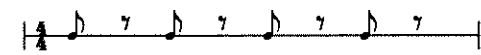
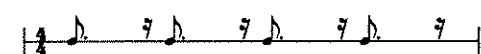
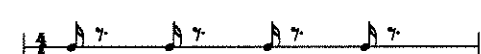

The types of notes that can be set:

thirty-second note (♩ <sub>32</sub> )	sixteenth note (♩ <sub>16</sub> )	dotted sixteenth note (♩ <sub>16</sub> .)
eighth-note triplets (♩ <sub>8</sub> 3)	eighth note (♩ <sub>8</sub> )	dotted eighth note (♩ <sub>8</sub> .)
quarter-note triplets (♩ <sub>4</sub> 3)	quarter note (♩ <sub>4</sub> )	dotted quarter note (♩ <sub>4</sub> .)
half-note triplets (♩ <sub>2</sub> 3)	half note (♩ <sub>2</sub> )	dotted half note (♩ <sub>2</sub> .)
whole note (♩ <sub>1</sub> )		

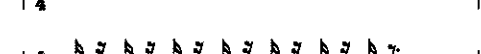
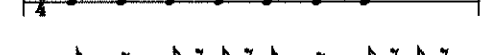
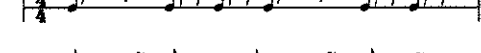
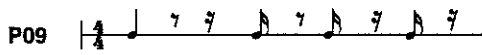
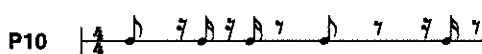
However, you cannot select delay time settings exceeding approximately 6 seconds.

In addition, playback of a pattern is based on the pattern's tempo.

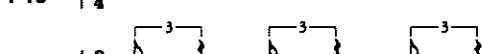
- (\*2) As you rotate the knob clockwise, the sampling frequency of 44.1 kHz is multiplied by a factor of 1 through 1/16, with the change occurring consecutively. If you turn this OFF, the sampling frequency will be 44.1 kHz.
- (\*3) The following choices are available for PTN when the selection is made using the CTRL 1 knob, and "22. SLICER + FLANGER" is selected.

<p>P01 </p> <p>P02 </p> <p>P03 </p> <p>P04 </p> <p>P05 </p> <p>P06 </p> <p>P07 </p> <p>P08 </p>	<p>P09 </p> <p>P10 </p> <p>P11 </p> <p>P12 </p> <p>P13 </p> <p>P14 </p> <p>P15 </p> <p>P16 </p>
--	--

- (\*4) Of the samples to which the effect is applied, the PTN rate will synchronize to the tempo of the sample of the sync-source pad.

However, if a pattern is being played back, then this is synchronized to the pattern tempo.

The sync rate can be adjusted with the RATE setting as shown below.

With RATE at minimum (the CTRL 2 knob turned completely to the left):

one PTN cycle corresponds to one measure.

With RATE at maximum (the CTRL 2 knob turned completely to the right):

one PTN cycle corresponds to one-eighth of a measure.

You can set the cycle to one measure, one-half measure, one-quarter measure, or one-eighth measure according to the CTRL 2 knob position.

RATE	PTN cycle
x1	one TIMING PTN cycle corresponds to one measure
x2	one TIMING PTN cycle corresponds to one-half of a measure
x4	one TIMING PTN cycle corresponds to one-quarter of a measure
x8	one TIMING PTN cycle corresponds to one-eighth of a measure

# Chapter 3. Recording samples

- \* *Unauthorized recording (sampling) of audio material whose copyright is owned by a third party is prohibited by law, except for the special case of personal use. Do not make illegal recordings.*
- \* *Boss Corporation will take no responsibility for any claim of damages made against you by copyright holders on the basis of illegal recordings you may make using Boss products.*

## Before you sample

Before you sample, please read the following explanations regarding the settings used for sampling and the available sampling time.

## Stereo/mono sampling selection

For each pad, you can specify whether sampling will be performed in stereo or monaural.

### Parameter: Type

#### MONO:

Monaural sampling.

#### STEREO:

Stereo sampling. Stereo sampling occupies twice the sampling time and twice the polyphony (number of simultaneous notes) of monaural sampling. (The number of samples that can be played simultaneously; p. 30)

- \* *It is not possible to change between stereo and mono after sampling.*

## Selecting the Sampling Grade

For each pad, you can select one of three Sampling Grades (STANDARD/LONG/LO-FI).

- \* *It is not possible to change the Sampling Grade after sampling.*

### Parameter: Grade

Grade	Audio quality	Sampling frequency
STANDARD	Select this when you want to sample at high quality.	44.1 kHz
LONG	This allows twice the sampling time of STANDARD. The quality is slightly lower.	22.05 kHz
LO-FI	The sound will be "lo-fi," and the sampling time will be much longer.	11.025 kHz

## About the sampling time

The available sampling times for internal memory and a memory card are shown below.

- \* *These times are for monaural sampling. For the internal memory, this is the total time of the samples in pad banks 5-16. For the memory card, this is the total time of the samples in pad banks 17-32.*
- \* *The available sampling time will be half if you use stereo sampling.*

### Internal (times approximate)

STANDARD	LONG	LO-FI
2 minutes	5 minutes	17 minutes

### Memory card (times approximate)

Capacity	STANDARD	LONG	LO-FI
8 MB	4 minutes	8 minutes	24 minutes
16 MB	8 minutes	16 minutes	49 minutes
32 MB	16 minutes	32 minutes	98 minutes
64 MB	32 minutes	64 minutes	197 minutes
128 MB	64 minutes	129 minutes	395 minutes

- \* *If you have saved internal samples and pattern or song data on the memory card (p. 67), the available sampling time on the memory card will be less than listed above.*

## Starting sampling automatically when sound is input

You can make settings so that sampling begins automatically when the input sound exceeds a specified level.

- \* *If you are using an effect, sampling will begin when the sound that includes the effect sound (noise) exceeds the specified level.*

### Parameter: Auto

#### OFF:

Select this setting if you want to start sampling manually.

#### LEVEL 1-8:

Specify the audio input level at which you want sampling to begin automatically. When the input sound exceeds this level, sampling will begin automatically. LEVEL 1 is the lowest.

The screen will show a symbol to indicate the specified level.

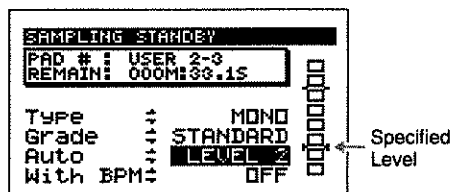

## Chapter 3. Recording samples

### Parameter: With BPM

**OFF:** The timing at which the sound will stop (End Point) is not specified.

**40.0–200.0:** The end of the sound (End Point) will automatically be set on a beat of the specified BPM value.

\* The End Point will be set accurately if you slightly delay the end of sampling.

#### HINT

By combining Auto (automatically start sampling when sound is input) and With BPM (specify the timing at which the sound will stop), you can cause only the desired portion to sound.

#### (Example 1)

If you sample a sound with a length of BPM=120  
(Auto, with BPM=120.0)

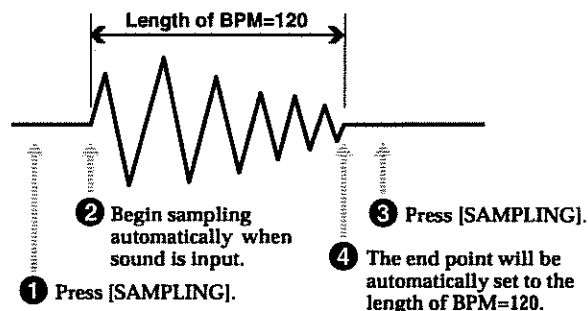

Sample BPM : 120.0  
Measure : 1  
Beat : 4/4

#### (Example 2)

If you sample only half of a sound with a length of BPM=120  
(Auto)

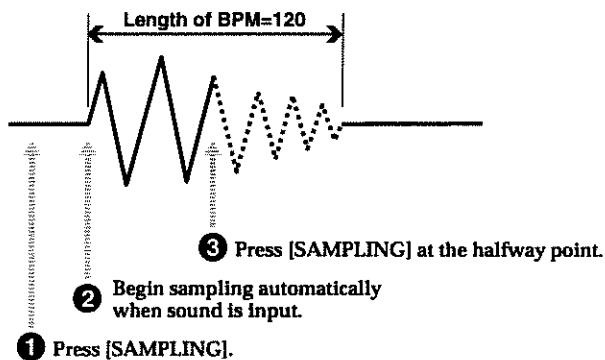

Sample BPM : 120.0  
Measure : 1/2  
Beat : 4/4

## Applying an effect while you sample

If you want to apply an effect while you sample, press [FX ON/OFF] to make the button light.

## Selecting the input source

1. Connect the input device from which you want to sample, such as a CD player or mic.

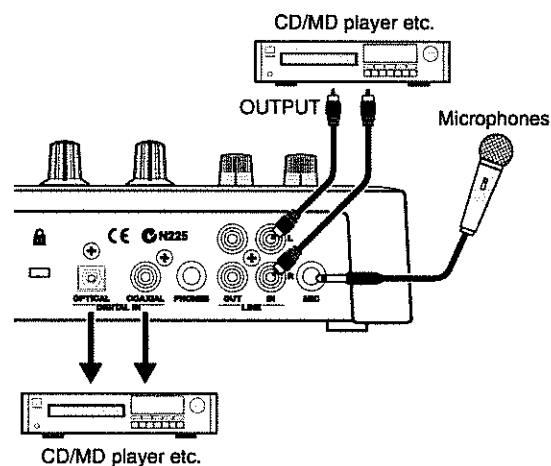

2. Press [SAMPLING].  
[SAMPLING] will blink, and the SP-505 will be in standby mode.

#### NOTE

Never turn off the power while the display indicates "Keep Power On!"

3. Press [SOURCE SELECT] to select the input source. The indicator of the selected input source will light.
  - \* If you select COAXIAL or OPTICAL, the display will indicate "Awaiting Digital Signal" until a digital signal is detected. Some CD/MD players output a digital signal only during playback, so play back your CD/MD player to get the SP-505 to recognize the signal.
  - \* DIGITAL IN supports only digital signals with a 44.1 kHz sampling frequency. If a digital signal other than 44.1 kHz is input, the display will indicate "Waiting Digital Signal."
  - \* Noise may occur if an unstable digital signal is input.



## Sampling procedure

### 1. Press [SAMPLING].

[SAMPLING] will blink, and the SP-505 will be in standby mode.

At this time, pads to which no sample has been assigned will blink.

- \* If samples are assigned to all pads in the currently selected pad bank, no pad will blink. Please switch pad banks. (p. 30)

### NOTE

Never turn off the power while the display indicates "Keep Power On!"

- \* If you decide to cancel sampling at this point, press [EXIT].

### 2. Select the pad to which the sampled sound will be assigned.

- \* If a sample is already assigned to the selected pad, the display will ask "OK to Overwrite?" If you want to use that pad, press [F1] (YES). To cancel, press [F2] (NO).

### 3. Select the input source. (p. 40)

### 4. Set the sampling conditions. (Refer to p. 39-40)

The remaining sampling time available will be displayed in the top line (REMAIN).

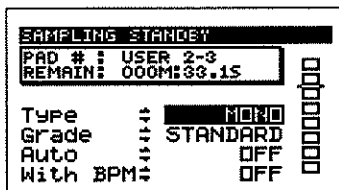

#### Type

MONO: Monaural recording  
STEREO: Stereo recording

#### Grade

STANDARD: High-quality sampling  
LONG: Extended length sampling  
LO-FI: Lo-fi sampling

#### Auto

OFF: Begin sampling manually  
LEVEL 1-8: Begin sampling automatically at the specified internal

#### With BPM

OFF: The timing at which the sound will stop (End Point) is not specified.

40.0-200.0: When sampling ends, the end of the sound (End Point) will automatically be set to the beat (relative to the specified BPM) that occurred immediately before you pressed the button.

- \* The End Point will be set accurately if you slightly delay the end of sampling.

### 5. Adjust the sampling level.

Turn the REC LEVEL knob to adjust the level so that the third "□" from the top in the level meter shown in the display becomes black occasionally.

- \* The REC LEVEL knob has no effect if you selected COAXIAL or OPTICAL as the input source.

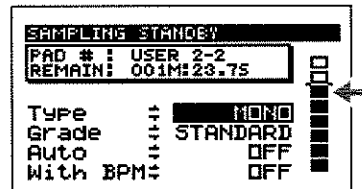

### 6. Press [SAMPLING].

[SAMPLING] will light, and sampling will start.

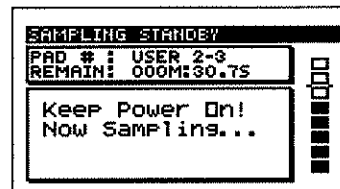

If you set AUTO to LEVEL 1-8, the display will indicate that the SP-505 is waiting for audio input.

Sampling will start when the input reaches the specified level.

### 7. At the point where you want to stop sampling, press [SAMPLING].

This completes the sampling procedure.

- \* Sampling will end automatically if the available sampling time is exceeded.

### 8. Press the pad to play back the sampled sound.

- \* If there is unwanted sound or silence at the beginning or end of the sample, you can set it so that only the desired portion of the sample is actually played. For details refer to p. 46, "Specifying the start/end points of the sound (Omitting unwanted portions)."



### Re-sampling samples (Resampling)

On the SP-505, previously recorded samples can be sampled once again. This is called "resampling." For example, this allows multiple samples to be played simultaneously and then sampled to combine them into one sample, or to be resampled with an effect applied.

There are two ways to perform resampling: you can use "Auto" to start/end resampling automatically, or you can start/end sampling manually.

#### Applying an effect while you sample

If you want to apply an effect while you sample, press [FX ON/OFF] to make the button light.

#### Resampling procedure 1 (Auto)

1. Press [RESAMPLE] to make the button light.

[SAMPLING] will blink, and the SP-505 will be in standby mode.

At this time, pads to which no sample has been assigned will begin blinking.

- \* If samples are assigned to all pads in the currently selected pad bank, no pad will blink. Please switch pad banks. (p. 30)

#### NOTE

Never turn off the power while the display indicates "Keep Power On!"

- \* If you want to cancel resampling at this point, press [EXIT].

2. Press the pad to which you want to assign the resampled sound (sample).

- \* If a sample is already assigned to the selected pad, the display will ask "OK to Overwrite?" If you want to use that pad, press [F1] (YES). To cancel, press [F2] (NO).

3. Make settings for resampling. (Refer to p. 39-40)

The remaining time available for sampling is shown in the top line (REMAIN).

#### Type

MONO: Monaural recording  
STEREO: Stereo recording

#### Grade

STANDARD: High-quality sampling  
LONG: Extended-length sampling  
LO-FI: Lo-fi sampling

#### Auto

In this case, turn this ON.

ON: When you select the pad from which resampling will be performed (the Source Pad) and start resampling, the source pad will automatically begin playing, and resampling will end when the source pad finishes playing.

OFF: Manually start/end resampling.

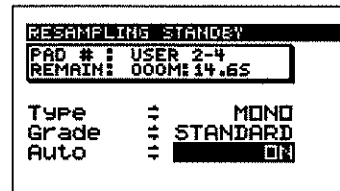

4. Press [SAMPLING].

The resampling-destination pad will change to being lit, and the pads to which a sample has been assigned will blink.

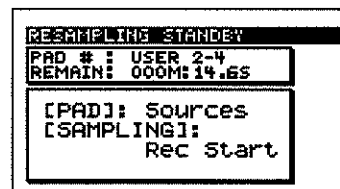

5. As necessary, switch the pad bank (p. 30), and press the pad(s) for the sample(s) that you want to resample (the Source Pads).

The pad(s) you press will change from blinking to lighting solidly. You may select more than one pad.

If you once again press a pad that is lit, it will change from lit to blinking, and will be removed from selection.

You can select multiple pads or [EXT SOURCE].

- \* Although you can select multiple pads for resampling, there are limits to the maximum number.

If the resampling source pads contain monaural samples...  
Maximum of four

If the resampling source pads contain stereo samples...  
Maximum of two

6. Press [SAMPLING].

The source pad(s) will begin playing, and resampling will start.

- \* It is not possible to switch pad banks during resampling.

When the selected sample(s) finish playing, resampling will end automatically.

If you press [SAMPLING] while the selected sample(s) are playing, resampling will end before it is completed.

## Resampling procedure 2 (Manual)

1. Press [RESAMPLE] to make the button light.  
[SAMPLING] will blink, and the SP-505 will be in standby mode.  
At this time, pads to which no sample has been assigned will blink.  
\* If samples are assigned to all pads in the currently selected pad bank, no pad will blink. Please switch pad banks. (p. 30)

### NOTE

Never turn off the power while the display indicates "Keep Power On!"

2. Press the pad to which you want to assign the resampled sound (sample).  
\* If a sample is already assigned to the selected pad, the display will ask "OK to Overwrite?" If you want to use that pad, press [F1] (YES). To cancel, press [F2] (NO).
3. Make settings for resampling. (Refer to p. 39-40)  
The remaining time available for sampling is shown in the top line (REMAIN).

### Type

MONO: Monaural recording  
STEREO: Stereo recording

### Grade

STANDARD: High-quality sampling  
LONG: Extended-length sampling  
LO-FI: Lo-fi sampling

### Auto

In this case, turn this OFF.

OFF: Manually start/end resampling.

ON: When you select the pad from which resampling will be performed (the Source Pad) and start resampling, the source pad will automatically begin playing, and resampling will end when the source pad finishes playing.

4. Press [SAMPLING].



5. As necessary, switch the pad bank (p. 30), and press the pad(s) for the sample(s) that you want to resample (the Source Pads).

The source pad will begin playing, and resampling will start.

[EXT SOURCE] can also be specified as the source pad.

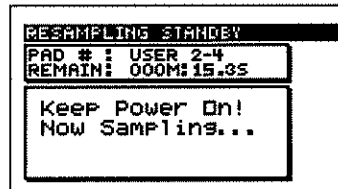

- \* It is not possible to switch pad banks during resampling.
6. When you are finished resampling, press [SAMPLING].

# Chapter 4. Changing the settings of a sample

## Procedure

1. Press the pad of the sample whose settings you want to change.
2. Press [WAVE EDIT].

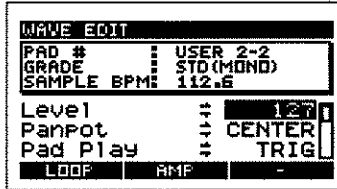

3. Use CURSOR [↑] [↓] to select the setting (parameter) that you want to change.
4. Use the VALUE dial to change the value of the setting.
  - If you want to change the settings of another sample in the same pad bank, press the pad for that sample, and repeat steps 3 and 4.
  - If you want to change the settings of a sample in another pad bank, switch to that pad bank (p. 30), press the pad for the sample you want to edit, and repeat steps 3 and 4.
5. Press [EXIT], [SONG], or [PTN] to return to the Play screen.

### NOTE

Never turn off the power while the display indicates "Keep Power On!"

## Adjusting the volume of a sample

To adjust the volume of a sample, select "Level" in step 3 of "Procedure" on p. 44.

### Level 0-127

This adjusts the volume.

## Adjusting the stereo position of a sample

To adjust the stereo position of a sample, select "Panpot" in step 3 of "Procedure" on p. 44.

### Panpot LEFT, CENTER, RIGHT

- LEFT:** Pan the sound to OUTPUT L.  
**CENTER:** Pan the sound to the center.  
**RIGHT:** Pan the sound to OUTPUT R.

\* Panpot has no effect for samples that were sampled with a Type of STEREO.

## Changing how a sample plays and stops

To change how a sample plays and stops when you press a pad, select "Pad Play" in step 3 of "Procedure."

### Pad Play TRIG, GATE, DRUM

**TRIG:** The sample will start playing when you press the pad, and will stop when you press the pad once again.

**GATE:** The sample will play only while you continue holding down the pad.

**DRUM:** When you press the pad, the sample will play once, and will stop at the End point.

\* If you select DRUM, the Loop Mode setting has no effect.

## Looping the playback of a sample

If you want a sample to loop (play back repeatedly), select "Loop Mode" in step 3 of "Procedure."

### Loop Mode ON, OFF

- ON:** The sample will loop (play back repeatedly).  
**OFF:** The sample will not loop.

## Playing a sample backward

If you want a sample to play in reverse (backward), select "Reverse" in step 3 of "Procedure" on p. 44.

### Reverse ON, OFF

**ON:** The sample will play in the reverse direction.  
(Reverse playback)

**OFF:** The sample will play in the normal direction.  
(Normal)

\* If you change the reverse settings while a sample is sounding, the modified setting will take effect the next time the sample is played.

## Playing a sample in Phrase or Single modes

To specify whether a sample will be played in Phrase or in Single modes, select "Play Type" in step 3 of "Procedure" on p. 44.

### Play Type PHRASE, SINGLE

**PHRASE:** The sample will be played as a phrase. When at this setting, the BPM of the sample can be adjusted automatically to match the playback BPM (tempo) or the BPM of the sequencer.

**SINGLE:** The sample will be played as a single sound. With this setting, the sample will always play at its own BPM (tempo).

\* The BPM of a sample can be adjusted in a range of 0.5–1.3 times the original setting. If you make settings that exceed the allowable BPM range of the sample, the sample BPM will be doubled or halved to stay within the allowable range.

\* If the sample is shorter than approximately 200 ms, changes in BPM will not be reflected.

The sample BPM will be calculated automatically and displayed in the top line as SAMPLE BPM, but the BPM cannot be calculated correctly if the original number of measures and the time signature of the sample are incorrect.

In this case, you will need to change the number of measures or the time signature of the sample.

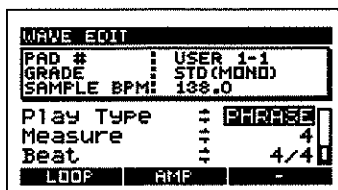

## Changing the number of measures of a sample

You can specify the number of measures and the time signature of a sample so that the displayed BPM will be the true BPM of that sample. The specified BPM will be displayed in the top line as SAMPLE BPM.

To specify the number of measures when playing the phrase as a sample, select "Measure" in step 3 of "Procedure" on p. 44.

### Measure 1/128-1/2, 1-99998

Specify the number of measures in the ranges of 1/128–1/2 or 1–99998 measures.

\* The number of measures can be specified as half or twice the original number of measures.

It is not possible to specify a number of measures that would result in SAMPLE BPM exceeding the range of 40.0–200.0.

\* It is not possible to set the number of measures if Play Type is set to SINGLE.

## Changing the time signature of a sample

To change the time signature of a sample, select "Beat" in step 3 of "Procedure" on p. 44.

### Beat 1/4-8/4

Specify the time signature in the range of 1/4 to 8/4.

\* It is not possible to set a time signature that would result in SAMPLE BPM exceeding the range of 40.0–200.0.

\* It is not possible to set the time signature if Play Type is set to SINGLE.

## Adjusting the BPM (tempo) of a sample

1. In the Play screen, press [BPM ADJUST].
2. Use the VALUE dial to specify the BPM (tempo).

### Play BPM 40.0-200.0

The top line displays the original BPM (tempo).

You can also press CURSOR [→] to make adjustments in 0.1 BPM units.

- \* The sample BPM can be adjusted in a range of 0.5–1.3 times. If the synchronized BPM exceeds the allowable range of the sample BPM, the sample BPM will be doubled or halved to stay within the allowable range.
- \* If the sample is shorter than approximately 200 ms, changes in BPM will not be reflected.

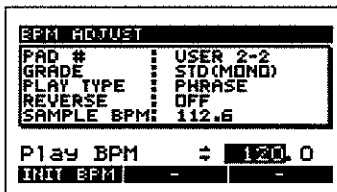

- PAD#:** Currently selected pad number  
(Example) USER1-1:  
Pad [1] of user bank 1
- GRADE:** Sampling grade (stereo/mono)  
STD (Standard), LONG, LO-FI
- PLAY TYPE:** PHRASE, SINGLE
- REVERSE:** ON, OFF
- SAMPLE BPM:** BPM of the currently selected sample

- \* Changing the BPM (tempo) may cause noise to be heard.
  - \* If you want to return to the BPM used when sampling, press [F1] (INIT BPM).
  - \* It is not possible to set Play BPM if Play Type is set to SINGLE.
  - \* It is not possible to set Play BPM for a sample that is set to reverse playback.
3. Press [EXIT], [SONG], or [PTN] to return to the Play screen.

## Specifying the start/end points of the sound (Omitting unwanted portions)

\* While you are setting the start/end points of a sample, the Play BPM setting is ignored, and the sample will play at its original BPM (tempo).

1. Press the pad of the sample whose start/end points you want to change.
  2. Press [WAVE EDIT].
  3. Press [F1] (LOOP).
- The sample waveform will be displayed.

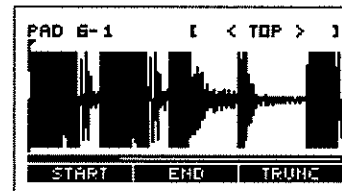

The pad number will be shown at the left side of the top line of the display.

(Example) PAD 6-1: Pad [1] of pad bank 6

The number of samples of the wave pointer position will be shown in the right side of the top line of the display.

The beginning of the sample waveform is indicated as <TOP>, and the end as <BOTTOM>.

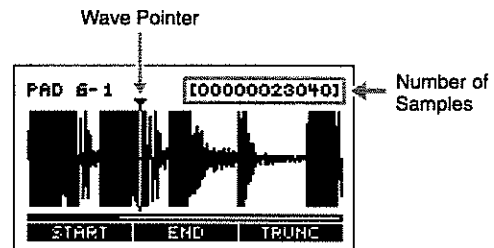

\* Even if a sample has been set to reverse playback, the waveform will be displayed in the normal direction.

4. Use CURSOR [←][→] to move the entire screen left or right, use the VALUE dial to move the wave pointer to the point where you want the sample to begin sounding, and press [F1] (START).
5. Use CURSOR [←][→] to move the entire screen left or right, and use the VALUE dial to move the wave pointer to the point where you want the sample to stop sounding, and press [F2] (END).

The region between the playback start/stop points will be highlighted.

- \* It is not possible to specify the start/end points in a way that would leave less than 70 ms between the beginning and end of the sound.
  - \* If you set the start point at the beginning of the waveform, and set the end point at the end of the waveform, the highlighted region will return to normal, and the start/end points will be cancelled.
6. Press the pad to listen to the sample play back, and check the start/end point settings.  
By holding down [PAD] and pressing [F1] (START) or [F2] (END), you can listen to the sound before or after the start/end points.
  - If you want to make fine adjustments to the start/end points, press [ZOOM IN] to magnify the waveform display, use the VALUE dial to move the wave pointer, and press [F1] (START) or [F2] (END).  
Press [ZOOM OUT] to shrink the waveform display and return to the previous display.
  - By holding down [L/R] and pressing [ZOOM IN] [ZOOM OUT], you can zoom-in or zoom-out on the vertical axis (amplitude axis) of the waveform.
  - When you press [F3] (TRUNC), the screen will ask you whether it is ok to truncate (delete) the portions before and after the start/end points. If you want to truncate the sample, press [F1] (YES). To cancel, press [F2] (NO).
  - \* By executing Truncate, you can conserve sample memory and increase the remaining time available for sampling.
  - \* Once Truncate has been executed, it will not be possible to return to the original start/end point locations.
7. Press [SONG] or [PTN], or press [EXIT] twice to return to the Play screen.

**NOTE**

Never turn off the power while the display indicates "Keep Power On!"

## Adjusting the volume of a specified region of the sample

The volume of a specified region in a sample can be adjusted. For example, if a sample contains noise, you can lower the volume of the region containing the noise, to make it less obtrusive.

- \* The tonal quality may change if you perform this operation repeatedly.
- \* While you are adjusting the volume of a specified region in the sample, the Play BPM setting will be ignored, and the sample will play at its original BPM (tempo).

1. Press the pad of the sample whose volume you want to adjust for a specified region.
2. Press [WAVE EDIT].
3. Press [F2] (AMP).

The sample waveform will be displayed.

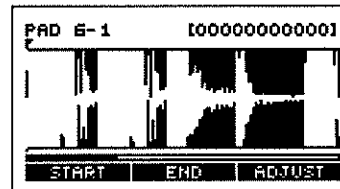

The pad number will be shown at the left side of the top line of the display.

(Example) PAD 6-1: Pad [1] of pad bank 6

The number of samples of the wave pointer position will be shown in the right side of the top line of the display.

- \* Even if the sample has been set to reverse playback, the waveform will be displayed in the normal direction.
4. Use CURSOR [←][→] to move the entire screen left or right, use the VALUE dial to move the wave pointer to the beginning of the region for which you want to change the volume, and then press [F1] (START).
  - \* When wave pointer locates on except the region between the specified start and end points, the display will indicate [\*\*\*\*\*], and it is not possible to set the beginning of the region for which you want to change the volume.

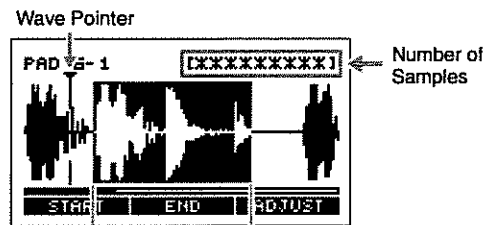

The region between the specified start and end points

## Chapter 4. Changing the settings of a sample

5. Use CURSOR [←][→] to move the entire screen left or right, use the VALUE dial to move the wave pointer to the end of the region in which you want to change the volume, and then press [F2] (END).

The region between the specified start and end points will be highlighted.

- \* When wave pointer locates on except the region between the specified start and end points, the display will indicate [\*\*\*\*\*], and it is not possible to set the end of the region for which you want to change the volume.
- If you want to make fine adjustments to the start and end points of the region in which the volume will be adjusted, press [ZOOM IN] to magnify the waveform display, use the VALUE dial to move the wave pointer, and press [F1] (STRT) or [F2] (END). Press [ZOOM OUT] to reduce the magnification of the waveform display, returning to the previous display size.
- By holding down [L/R] and pressing [ZOOM IN] [ZOOM OUT], you can zoom-in or zoom-out on the vertical axis (amplitude axis) of the waveform.

6. Press [F3] (ADJUST).

Use the VALUE dial to adjust the volume.

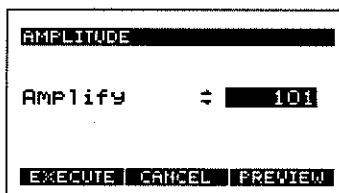

7. Use the VALUE dial to adjust the volume.

**Amplify: 0–400**

A setting of 400 will double the amplitude of the waveform, and 0 will produce an amplitude of 0.

By pressing [F3] (PREVIEW) you can preview the volume that will result.

- \* The sound will be played starting slightly before the specified start point, for a maximum of nine seconds.
8. When you are finished adjusting the volume, press [F1] (EXECUTE).
- To cancel, press [F2] (CANCEL) or [EXIT].  
The volume will revert to the original settings.  
If you pressed [F1] (EXECUTE), you will be asked to confirm the volume change.

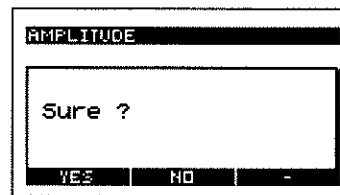

9. To finalize your change in the volume, press [F1] (YES). To cancel, press [F2] (NO).

- \* Once you have finalized the volume change, it is not possible to return to the original volume.

10. Press [SONG] or [PTN], or press [EXIT] twice to return to the Play screen.

### NOTE

Never turn off the power while the display indicates "Keep Power On!"



# Chapter 5. Deleting or copying a sample

## Deleting a sample

1. Press [SONG] or [PTN] to access the Play screen.
2. Press [DEL].
3. Press the pad whose sample you want to delete.

You may select more than one pad.

If you want to select a sample of another pad bank, switch pad banks (p. 30) and then press a pad to select the sample.

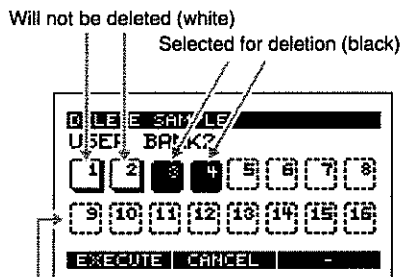

No sample is assigned (dotted line)

If you press a selected pad once again, the display will change back to white, canceling the selection.

4. To delete the selected sample(s), press [F1] (EXECUTE). To cancel, press [F2] (CANCEL) or [EXIT].

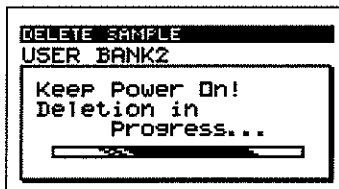

### NOTE

Never turn off the power while the display indicates "Keep Power On!"

## Using the clipboard to copy a sample

The "clipboard" is a function that temporarily stores a desired sample. You can use this function to copy a sample. This is convenient when you want to copy between different pad banks, or to swap (exchange) the location of samples.

## Copying a single sample

1. Press [SONG] or [PTN] to display the Play screen.

2. Hold down the pad of the sample that you want to copy, and press [CLIPBOARD].

The sample will be copied to the clipboard, and [CLIPBOARD] will light.

When you press [CLIPBOARD], the copied sample will play.

3. Hold down [CLIPBOARD] and press the copy-destination pad.

- If you want to copy to a different pad bank, press [PAD BANK] to switch the pad bank. (p. 30)
- If the copy-destination pad contains a sample, you will be asked "OK to Overwrite?" If it is ok to overwrite and erase the previous sample, press [F1] (YES). If you do not want to erase the previous sample, press [F2] (NO).
- If you hold down [CLIPBOARD] and press [DEL], the sample that was copied to the clipboard will be erased.

### NOTE

Never turn off the power while the display indicates "Keep Power On!"



### Copying multiple samples

1. Press [SONG] or [PTN] to display the Play screen.
2. Hold down the pad of the sample that you want to copy, and press [CLIPBOARD].  
The sample will be copied to the clipboard, and [CLIPBOARD] will light.
3. Repeat step 2 for each of the samples you want to copy, to copy them to the clipboard.  
A maximum of 16 samples can be copied to the clipboard.  
\* If multiple samples have been copied to the clipboard, pressing [CLIPBOARD] will play the sample that was copied first.

4. Hold down [CLIPBOARD] and press the copy-destination pad.  
The samples will be copied starting from the pad you pressed last.  
When you press [CLIPBOARD], the sample that will be copied next will play, allowing you to check the sample.  
(Example)

Pad [1] + [CLIPBOARD]	→	copy the sample of pad [1]
Pad [2] + [CLIPBOARD]	→	copy the sample of pad [2]
Pad [3] + [CLIPBOARD]	→	copy the sample of pad [3]



[CLIPBOARD] + pad [13]	→	pad [3] sample will be copied to pad [13]
[CLIPBOARD] + pad [12]	→	pad [2] sample will be copied to pad [12]
[CLIPBOARD] + pad [11]	→	pad [1] sample will be copied to pad [11]

When all samples have been copied, the clipboard will be empty, and [CLIPBOARD] will go dark.

- If you want to copy to another pad bank, press [PAD BANK] to switch pad banks. (p. 30)
- If the copy-destination pad contains a sample, you will be asked "OK to Overwrite?" If you are sure you want to overwrite (erase) the existing sample, press [F1] (YES). If you do not want to overwrite it, press [F2] (NO) to cancel the operation.
- If you hold down [CLIPBOARD] and press [DEL], one sample that was copied to the clipboard will be erased.

#### **NOTE**

Never turn off the power while the display indicates "Keep Power On!"

### Exchanging samples

You can exchange (swap) samples between two pads to change the order of the samples.

1. Press [SONG] or [PTN] to display the Play screen.
2. Hold down one of the pads whose sample you want to exchange, and press [CLIPBOARD].  
The sample will be copied to the clipboard, and [CLIPBOARD] will light.  
The copied sample will play when you press [CLIPBOARD].
3. Hold down [CLIPBOARD], and press the pad of the other sample you want to exchange.
  - If you want to exchange samples with another pad bank, press [PAD BANK] to switch the pad bank. (p. 30)  
The display will ask "OK to Overwrite?"
4. If you are sure you want to exchange the samples, press [F3] (EXCHANGE).  
The samples will be exchanged.

#### **NOTE**

Never turn off the power while the display indicates "Keep Power On!"

# Chapter 6. Applying special processing to a sample

## Dividing a sample into individual notes (Chop)

The SP-505's "Chop" function divides a sample at each of the attacks in the sample waveform, and assigns each divided sample to a pad.

For example, a drum phrase can be divided into samples containing separate rhythm instruments such as "bass drum," "snare," and "hi-hat."

- \* It is not possible to divide a sample from one of the Chop banks.
- \* It is not possible to divide a stereo sample.
- \* Phrases that contain numerous notes or simultaneously sounding notes may not be divided as you expect.
- \* Even if you have an effect applied when you execute "Chop," that effect will not be added to the divided samples.

### MEMO

The divided samples will be assigned to the thirty-two pads of pad banks 13-14 ("Chop banks 1-2").

- \* The sample will be divided into samples for a maximum of 32 pads, starting at the beginning of the original waveform. The rest of the waveform will not be assigned to pads.
- \* All of the remaining sound will be assigned to the last-divided sample.
- \* The start/end point settings of sample are ignored.

1. Press the pad of the sample that you want to divide.
2. Press [CHOP].

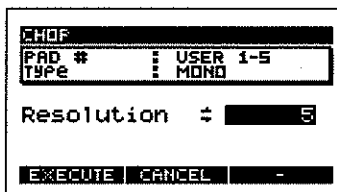

3. Use the VALUE dial to specify the detail (RESOLUTION) with which the sample will be divided.  
Higher settings will cause the sample to be divided into smaller pieces.
4. To execute the division at the resolution you specified in step 3, press [F1] (EXECUTE).  
To cancel, press [F2] (CANCEL) or [EXIT].  
\* If you press [F3] (CANCEL) while the display indicates "Processing Data...", the operation will be aborted.

Pads [1]-[16] will light automatically, and the divided samples will play back.

A message will ask whether you want to save the divided samples.

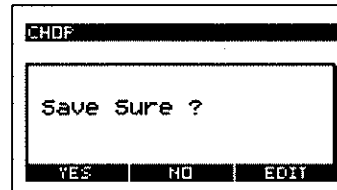

5. To save, press [F1] (YES).  
To cancel, press [F2] (NO) or [EXIT].  
\* If pad banks 13-14 (Chop banks; p. 29) already contain samples, you will be asked "OK to Overwrite?" If you are sure you want to overwrite the samples of pad banks 13-14, press [F1] (YES). To cancel, press [F2] (NO).

### NOTE

Never turn off the power while the display indicates "Keep Power On!"

## Editing the points at which the sample is divided

### About the dividing point adjustment screen

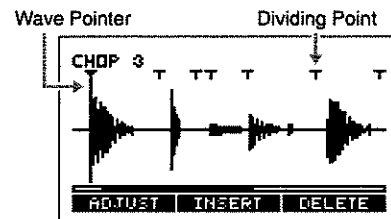

The location of the wave pointer is the currently selected dividing point.

CHOP1-32

This indicates the number of the divided sample that is currently selected.

- By turning the VALUE dial you can move to the previous or next dividing point.  
You can also press a pad to move to another dividing point.
- By pressing CURSOR [←][→] you can move the waveform display area horizontally.
- By pressing [ZOOM IN][ZOOM OUT] you can zoom-in or zoom-out on the waveform.

## Chapter 6. Applying special processing to a sample

- By holding down [L/R] and pressing [ZOOM IN] [ZOOM OUT], you can zoom-in or zoom-out on the vertical axis (amplitude axis) of the waveform.
- When adding or making fine adjustments to the dividing point, the number of samples at the location of the wave pointer will be displayed in the upper right of the screen. If the sample is shorter than 70 ms due to the pointer location, the display will indicate [\*\*\*\*\*].

### Adding a dividing point

1. In step 5 of the "Chop" procedure (p. 51), press [F3] (EDIT).  
The sample waveform will be displayed.
2. Use the VALUE dial to select a dividing point before or after the location where you want to add a division.  
You can also press a pad to select the dividing point.
3. Press [F2] (INSERT).

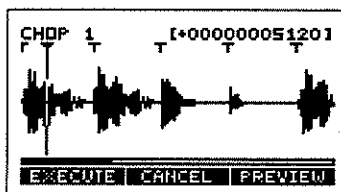

4. Use CURSOR [←][→] to display the location at which you want to add a dividing point.
5. Use the VALUE dial to move the wave pointer to the location where you want to add a division.  
By pressing [F3] (PREVIEW) you can listen to the sound that would result if the sample were divided at the wave point location.
6. To execute the addition of the dividing point, press [F1] (EXECUTE).  
To cancel, press [F2] (CANCEL) or [EXIT].
  - \* It is not possible to specify a dividing point that would create a sample shorter than 70 ms.
  - \* After adding a dividing point, it is not possible to return the 32nd dividing point (the last dividing point) to its original state.
7. If you want to add another dividing point, repeat steps 2-6.

If you want to delete a dividing point, follow the procedure in "Deleting a dividing point" (below), starting with step 2. If you want to make fine adjustments to a dividing point, follow the procedure in "Making fine adjustments to the dividing points" (p. 53), starting with step 2.

8. When you are finished, press [EXIT].  
You will be asked whether to save the divided samples.
9. To save, press [F1] (YES).  
To cancel, press [F2] (NO) or [EXIT].
  - \* If pad banks 13-14 (Chop banks; p. 29) already contain samples, you will be asked "OK to Overwrite?" If you are sure you want to overwrite the samples of pad banks 13-14, press [F1] (YES). To cancel, press [F2] (NO).

### NOTE

Never turn off the power while the display indicates "Keep Power On!"

### Deleting a dividing point

1. In step 5 of the "Chop" procedure (p. 51), press [F3] (EDIT).  
The sample waveform will be displayed.
2. Use the VALUE dial to move the wave point to the dividing location that you want to delete.  
You can also press a pad to move to the dividing point of that pad.

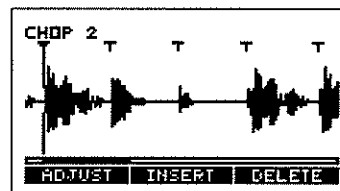

3. Press [F3] (DELETE).
4. If you want to delete another dividing point, repeat steps 2-3.  
If you want to add a dividing point, follow the procedure in "Adding a dividing point" (above), starting with step 2. If you want to make fine adjustments to a dividing point, follow the procedure in "Making fine adjustments to the dividing points" (p. 53), starting with step 2.
5. When you are finished deleting dividing points, press [EXIT].  
You will be asked whether you want to save the divided samples.
6. To save, press [F1] (YES).  
To cancel, press [F2] (NO) or [EXIT].
  - \* If pad banks 13-14 (Chop banks; p. 29) already contain samples, you will be asked "OK to Overwrite?" If you are sure you want to overwrite the samples of pad banks 13-14, press [F1] (YES). To cancel, press [F2] (NO).



Never turn off the power while the display indicates "Keep Power On!"

### Making fine adjustments to the dividing points

1. In step 5 of the "Chop" procedure (p. 51), press [F3] (EDIT).

The sample waveform will be displayed.

2. Use the VALUE dial to move to the dividing point whose location you want to adjust.

You can also press a pad to move to the dividing point whose location you want to adjust.

3. Press [F1] (ADJUST).

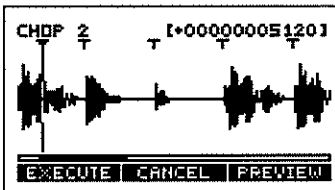

4. Use the VALUE dial to move the wave pointer to the dividing point whose location you want to adjust.  
You can use CURSOR [←][→] to move the screen.  
By pressing [F3] (PREVIEW) you can listen to the sound at the current location of the wave pointer.

5. To finalize the edited location of the dividing point, press [F1] (EXECUTE).

To cancel, press [F2] (CANCEL) or [EXIT].

*\* It is not possible to set a dividing point in a way that would create a sample shorter than 70 ms.*

6. If you want to make additional fine adjustments to the dividing point, repeat steps 2- 5.

If you want to add another dividing point, follow the procedure in "Adding a dividing point" (p. 52), starting with step 2. If you want to delete a dividing point, follow the procedure in "Deleting a dividing point" (p. 52), starting with step 2.

7. When you have finished adjusting the location of the dividing points, press [EXIT].

You will be asked whether you want to save the divided samples.

8. To save, press [F1] (YES).

To cancel, press [F2] (NO) or [EXIT].



Never turn off the power while the display indicates "Keep Power On!"

*\* If pad banks 13-14 (Chop banks; p. 29) already contain samples, you will be asked "OK to Overwrite?" If you are sure you want to overwrite the samples of pad banks 13-14, press [F1] (YES). To cancel, press [F2] (NO).*



## Playing pitches with a sample (Pitch)

The "Pitch" function allows you to play pitches using a sample (single note).

- \* It is not possible to assign pitches to a stereo sample.
- \* It is not possible to assign pitches to a sample from one of the Pitch banks.
- \* Even if you have an effect applied when you execute "Pitch," that effect will not be added to the pitched samples.

### MEMO

The samples assigned to pitches will be assigned to the pads of pad banks 15 and 16 ("Pitch banks" 1 and 2).

1. Press the pad that you want to use to play pitches.
2. Press [PITCH].

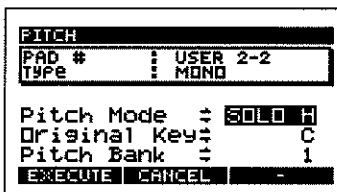

3. Use the VALUE dial to select the mode.

#### Pitch Mode

**SOLO L:** Suitable for single-note samples of low-pitched instruments such as bass.

**SOLO H:** Suitable for single-note samples of high-pitched instruments such as piano or guitar.

**MUSIC:** Suitable for samples of most music.

- \* Pitch assignment may not be successful for some types of samples.

4. Press CURSOR [↓] to move the cursor to "Original Key."

5. Use the VALUE dial to specify the pad from which you want to assign pitches.

**Original Key:** C, C#, D, D#, E, F, F#, G, G#, A, A#, B, C <UP>

The correspondence between pads and keys is as follows.

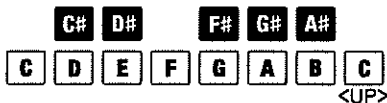

6. Press CURSOR [↓] to move the cursor to "Pitch Bank."

7. Use the VALUE dial to select the pitch bank.

Pitch Bank: 1, 2

8. To execute the Pitch function, press [F1] (EXECUTE). To cancel, press [F2] (CANCEL) or [EXIT].

Pads [2]–[16] will light automatically, and will play the sample at different pitches.

- \* Depending on the volume of the original sample, the sound may distort if you use the Pitch function. In this case, lower the volume of the original sample. (p. 44; "Adjusting the volume of a sample")
- \* If you press [F3] (CANCEL) while the display indicates "Processing Data..." the operation will be aborted.
- \* If the pitch bank (1 or 2) already contains samples, you will be asked "OK to Overwrite?" If you are sure it is ok to overwrite the samples of the pitch bank, press [F1] (YES). To cancel, press [F2] (NO).
- \* When you assign a sample to pitches, unwanted silence may occur at the beginning or end. After the Pitch function is executed, settings will be made automatically, so only the necessary portion is sounded. If you want to make fine adjustments, refer to "Specifying the start/end points of the sound (Omitting unwanted portions)" (p. 46).

# Chapter 7. Playing songs and patterns

## NOTE

When shipped from the factory, the unit contained no songs.

## Adjusting the BPM (tempo) of a song or pattern

1. Press [SONG] or [PTN].

2. Press [BPM/TAP].

The currently specified BPM will be displayed.

### SYNC MODE:

Displays the MIDI sync mode. (p. 72)

### SYNC SOURCE:

If set to "INTERNAL," playback will follow the internal BPM setting. If set to "MIDI," playback will follow the BPM of an external MIDI device.

### PTN BPM:

displays the BPM specified for the pattern.

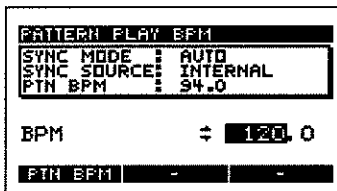

3. Use the VALUE dial to adjust the BPM (40.0- 200.0).

The BPM can be adjusted in units of one BPM.

By pressing CURSOR [→] and turning the VALUE dial you can adjust the BPM in units of 0.1 BPM.

If you press [F1] (PTN BPM), playback will use the BPM setting that is specified for each pattern.

## MEMO

You can press [BPM/TAP] four times or more to set the BPM to the corresponding interval (Tap Tempo function).

\* This cannot be changed if the SP-505 is synchronized to an external MIDI device.

4. Press [EXIT], [SONG], or [EXIT] to return to the Play screen.

\* The sample BPM can be modified by a factor of 0.5–1.3 times the original.

If the BPM of a song or pattern exceeds the allowable BPM range of the sample, the sample BPM will be doubled or halved so that stays within the allowable range.

\* If you change the BPM (tempo) of the sequencer, the samples may sound different. Samples for which Pad Play is set to TRIGGER or GATE may sound shorter if the BPM is speeded up, or longer if the BPM is slowed down. If you want the entire sample to be played to the end, set Pad Play to DRUM. (p. 31)

## Playing a song

\* The SP-505 can store 20 songs.

1. Press [SONG].

2. Use the VALUE dial to select the song.

3. Press [PLAY] to start playback.

The top line of the display will indicate the current measure/beat and BPM. The lower line will indicate the current pattern name.

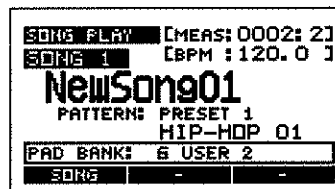

\* It is not possible to switch songs while a song is playing.

4. Press [STOP] to stop playback.

■ Press [RESET] to return to the beginning of the song.

■ Press [BWD] to go back one measure, or [FWD] to go forward one measure.

\* If you move to another measure while the song is playing, you will lose synchronization with the external MIDI device.

7

### Selecting and playing songs from the song list

1. Press [SONG].
2. Press [F1] (SONG).

The song list will be displayed.

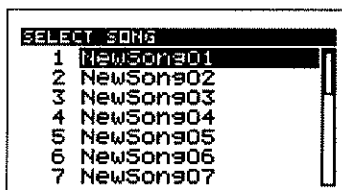

3. Use the VALUE dial to select a song, and [ENTER] to confirm your selection.  
Song nos. 1–16 can be selected directly by pressing a pad [1]–[16].  
To cancel, press [EXIT].
4. Press [PLAY] to begin playback.  
The top line of the screen will indicate the current measure number and beat, and the bottom line will indicate the pattern name.

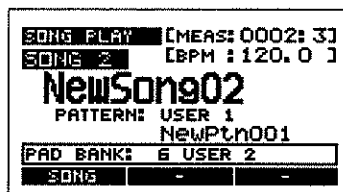

5. Press [STOP] to stop playback.  
*\* It is not possible to switch songs while a song is playing.*

### Playing patterns

*\* In addition to its 40 preset patterns, the SP-505 can store 100 user patterns.*

1. Press [PTN].



2. Use the VALUE dial to select a pattern.
3. Press [PLAY] to begin playback.

If you select a different pattern while a pattern is playing, the name of the newly selected pattern will appear in the lower line of the screen, and it will be reserved as the pattern to be played next. When the currently playing pattern finishes, the reserved pattern will automatically begin playing.



4. Press [STOP] to stop playback.
    - You can press [RESET] to return to the beginning of the pattern.
    - You can press [BWD] to move one measure back, or [FWD] to move one measure ahead.
- \* If you change measures while a pattern is playing, you will lose synchronization with any external MIDI devices.*



## Selecting and playing a pattern from the pattern list

1. Press [PTN].
2. Press [F1] (PRESET) or [F2] (USER).

The preset pattern or user pattern list will appear.

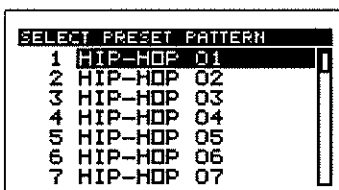

3. Use the VALUE dial to select a pattern, and press [ENTER] to confirm your selection.

Pattern nos. 1–16 can be selected directly by pressing pads [1]–[16].

To cancel, press [EXIT].

4. Press [PLAY] to begin playback.

If you select a different pattern while a pattern is playing, the name of the newly selected pattern will appear in the lower line of the screen, and it will be reserved as the pattern to be played next. When the currently playing pattern finishes, the reserved pattern will automatically begin playing.

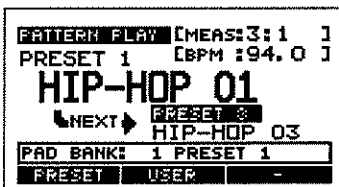

5. Press [STOP] to stop playback.

## Muting individual parts

You can mute specific parts while a song or pattern is playing.

1. Press [SONG] or [PTN].
2. Play [PLAY] to play the song or pattern.
3. Press PART [1]- [4].

Button lit: plays

Button dark: muted

The mute status of each part can be saved in the pattern.

(p. 62)

# Chapter 8. Creating patterns

## About pattern recording

A pattern can be recorded in the following two ways.

### Realtime recording

Realtime recording lets you record by striking pads while you listen to the metronome. The pattern will play back repeatedly, and the data you input will be combined with the existing data.

Even if the timing at which you strike the pads is not perfectly accurate, the Quantize function will correct your timing to accurate intervals. You can also use an external MIDI device for input.

### Microscope editing

In Microscope editing, the performance data that has been recorded will be displayed as a list, allowing you to make detailed edits to the recorded data.

\* *It is not possible to operate Microscope editing from an external MIDI device.*

## Pattern data

### Pattern recording parameters

#### Measure number (Measure)

1-8

#### Time signature (Beat)

1/4, 2/4, 3/4, 4/4, 5/4, 6/4, 7/4, 8/4

#### Part Mute

OFF, ON

#### BPM

40.0-200.0

This sets the BPM of the pattern.

#### QTZ (Quantize)

Quarter note (♩)	quarter note triplet (♩₃)
eighth note (♫)	eight note triplet (♫₃)
sixteenth note (♮)	sixteenth note triplet (♮₃)
32nd note (♯)	32nd note triplet (♯₃)

OFF

In realtime recording, you can set the Quantize interval to correct inaccuracies in the timing at which you strike the pads.

If you turn this "OFF," the data will be recorded at timing intervals of 1/96th of a beat.

## Realtime recording procedure

1. Press [PTN].
2. Press [F2] (USER).  
The user pattern list will be displayed.
3. Use the VALUE dial to select the pattern that you want to record, and press [ENTER] to confirm your selection.  
To cancel, press [EXIT].
4. Press [REC].  
The recording standby screen will appear.  
The metronome will sound at the specified BPM.

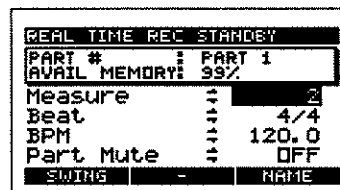

**AVAIL MEMORY: 0-100%**

This indicates the amount of remaining memory for sequencer data (patterns).

- \* *When AVAIL MEMORY reaches 0%, no further pattern recording will be possible. You can delete unneeded patterns (p. 65), or save sequencer data to a memory card (p. 67) before you delete patterns.*
5. Specify the number of measures (Measure), time signature (Beat), and BPM settings of the pattern that you want to record.
    - \* *The Part Mute settings are ignored during recording.*
    - \* *For easier input, you can set a slower BPM during realtime recording, and return to the previous BPM when you are finished recording.*
  6. Press PART [1]- [4] to select the part that you want to input.  
The button of the selected part will blink.
  7. Press [PLAY].

A one-measure count-in (unrecorded area) will be inserted.

Realtime recording will begin after the count-in.

The display will indicate the current measure and beat.

You can also begin recording by sending a Start message from an external MIDI device.

A count-in will not be inserted if recording was started by a Start message from an external MIDI device.

- If you press [F1] (RHR ON), rehearsal mode will be selected. Pressing the pads will produce sound, but nothing will be recorded. Press [F1] (RHR OFF) once again to exit rehearsal mode.

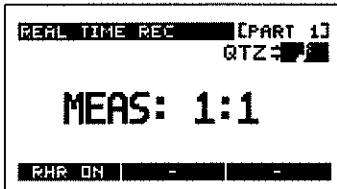

8. While you listen to the metronome, press the pads to record your performance.  
If note messages from an external MIDI device are used to play samples, those messages will be recorded.  
\* When performance data is recorded for a sample whose Play Type is PHRASE, the sample BPM will automatically synchronize to the pattern BPM. If you do not want it to synchronize, set the Play Type to SINGLE. (p. 45)  
To switch the part being recorded, press [PART].  
As necessary, use the VALUE dial to set QTZ (Quantize).  
\* If you want to add dynamics (accents) while you record, change the pad accent. (p. 30)
- If you want to select a pad from a different pad bank, press [PAD BANK] to switch the pad bank. (p. 30)  
\* The pads of a Chop bank cannot be recorded as they are. You must copy them to another bank before recording them. (p. 49–50)
9. When you are finished recording, press [STOP].  
You are returned to the recording standby screen.
10. Press [STOP] once again to stop recording.

**NOTE**

Never turn off the power while the display indicates "Keep Power On!"

**Erasing unwanted performance data (Realtime Recording)**

During realtime recording, you can hold down [DEL] and hold down a pad to erase the performance data for the corresponding pad during the interval that elapses while you continue pressing the pad.

**Microscope editing procedure**

**Input field**

**MEAS (measure: beat: clock)**

This specifies the time location at which pad data is input.  
(Example) 1:3:00 Measure 1, beat 3, clock 00

**QTZ (Quantize)**

Quarter note (♩)	quarter note triplet (♩₃)
eighth note (♩₈)	eight note triplet (♩₈₃)
sixteenth note (♩₁₆)	sixteenth note triplet (♩₁₆₃)
32nd note (♩₃₂)	32nd note triplet (♩₃₂₃)
OFF	

In Microscope edit, you can specify the note value of the distance that you will move forward or backward when [FWD] or [BWD] are pressed.

(Example) QTZ Eighth note

Press pad [1] → press [FWD] → press pad [2] → press [FWD] → press pad [3] → press [FWD] → press pad [4]

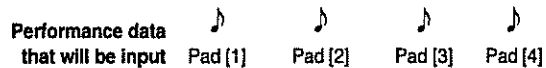

**Event field**

**MEASURE (measure: beat: clock)**

This indicates the performance location.  
(Example) 2:1:48 Measure 1, beat 1, clock 48

**PAD (pad bank - pad number)**

This indicates the pad that was input.  
(Example) 12-3 Pad bank 12, pad number 3

\* In the case of [EXT SOURCE], this will be displayed as "1-17".

**ACC (Accent)**

This indicates the volume. If the event was input via MIDI, this will be the velocity data.

(Example) 100 Pad accent 100 or velocity 100



### GATE (gate time)

This indicates the length that the sound will be heard.

- 384: whole note
- 192: half note
- 96: quarter note
- 48: eighth note
- 24: 16th note
- 12: 32nd note
- 6: 64th note

Press [F1] (MEAS) to move the cursor to the "MEAS" position.

### Viewing the performance data (Microscope Edit)

1. Press [PTN].
  2. Press [F2] (USER).  
The user pattern list will appear.
  3. Use the VALUE dial to select the pattern that you want to record, and press [ENTER] to confirm your selection.
  4. Press [F3] (MICRO).  
The Microscope Edit screen will appear.
- \* [F3] (MICRO) will not be displayed if a pattern is playing.

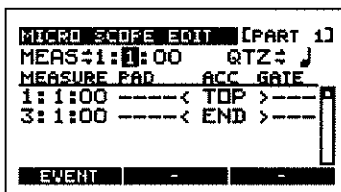

5. Press PART [1]- [4] to select the part that you want to input.  
The button for the selected part begins blinking.
  6. Use CURSOR [←][→] to move the cursor to the indication for MEAS (measure/beat/clock), and use the VALUE dial to specify the measure/beat/clock at which you want to input.
  7. Press pads to input your performance.  
The pad data that you input will be displayed.
- \* When performance data is input for a sample whose Play Type is PHRASE, the sample BPM will automatically synchronize to the pattern BPM. If you do not want it to synchronize, set the Play Type to SINGLE. (p. 45)
- \* Note messages from an external MIDI device cannot be used for input.

8. Press [PLAY] to verify the performance data that you input.  
Press [STOP] to stop playback.
9. Press [EXIT] or [STOP] to exit Microscope Edit.

### NOTE

Never turn off the power while the display indicates "Keep Power On!"

### Deleting unwanted performance data (Microscope Edit)

In step 7 of Microscope Edit (p. 60), press [F1] (EVENT) to move the cursor to the pad performance data (Event field). Move the cursor to the location of the pad data that you want to delete, and press [F3] (DELETE) to delete that performance data.

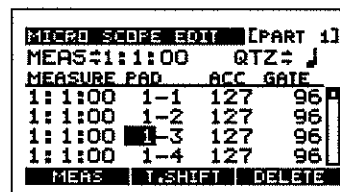

Press [F1] (MEAS) to move the cursor to the "MEAS" position.

### Changing the pad number (Microscope Edit)

In step 7 of Microscope Edit (p. 60), press [F1] (EVENT) to move the cursor to the pad performance data (Event field). Move the cursor to the PAD (pad number) position of the data whose pad number you want to change, and use the VALUE dial to change the pad number.

If you want to change the [EXT SOURCE] pad number, set this to "1-17."

- \* Be aware that there will be no sound if you change to a pad number to which no sample has been assigned.
- \* It is not possible to change this to the pad numbers of the chop banks, and the pad [1], [4], [8] of the pitch bank.

Press [F1] (MEAS) to move the cursor to the "MEAS" position.

## Adjusting the dynamics (accent) of the sound (Microscope Edit)

In step 7 of Microscope Editing (p. 60), press [F1] (EVENT) to move the cursor to the patch performance data (Event field). Move the cursor to the ACC (accent) location of the pad data whose volume you want to adjust, and use the VALUE dial to adjust the accent.

MICROSCOPE EDIT [PART 1]			
MEAS	1:1:00	QTZ	↓
MEASURE	PAD	ACC	GATE
1:1:00	1-1	127	96
1:1:00	1-2	127	96
1:1:00	1-3	117	96
1:1:00	1-4	127	96
MEAS T.SHIFT DELETE			

Press [F1] (MEAS) to move the cursor to the "MEAS" position.

## Changing the length of the sound (Microscope Edit)

In step 7 of Microscope Edit (p. 60), press [F1] (EVENT) to move the cursor to the pad performance data (Event field). Move the cursor to the GATE (gate time) location of the pad data whose length you want to change, and use the VALUE dial to adjust the gate time.

You can use CURSOR [←][→] to move the cursor to the 1's or 10's place of the gate time.

\* In the case of a pad for which Pad Play = DRUM, the gate time will be ignored.

MICROSCOPE EDIT [PART 1]			
MEAS	1:1:00	QTZ	↓
MEASURE	PAD	ACC	GATE
1:1:00	1-1	127	96
1:1:00	1-2	127	96
1:1:00	1-3	117	48
1:1:00	1-4	127	96
MEAS T.SHIFT DELETE			

Press [F1] (MEAS) to move the cursor to the "MEAS" position.

## Moving the timing of the sound (Microscope Edit)

In step 7 of Microscope Edit, press [F1] (EVENT) to move the cursor to the pad performance data (Event field).

Move the cursor to the pad data whose timing you want to change, and press [F2] (T.SHIFT) (Timing Shift).

Use the VALUE dial to set the desired time (measure/beat/clock).

To carry out the Timing Shift operation, press [F1] (EXECUTE). To cancel press [F2] (CANCEL) or [EXIT].

TIMING SHIFT [PART 1]			
MEAS	1:1:00	QTZ	↓
MEASURE	PAD	ACC	GATE
1:1:00	---	< TOP >	
1:1:00	1-1	127	96
1:1:00	1-2	127	96
1:1:00	1-3	117	48
EXECUTE CANCEL			

Press [F1] (MEAS) to move the cursor to the "MEAS" position.

## Changing the rhythmic feel of a pattern (Swing)

You can change the rhythmic feel of the patterns you create.



1. Press [PTN].
2. Press [F2] (USER).  
The user pattern list will be displayed.
3. Use the VALUE dial to select the pattern whose rhythmic feel you want to change, and press [ENTER] to confirm your choice.  
To cancel, press [EXIT].
4. Press [REC].  
The recording standby screen will appear.
5. Press [F1] (SWING).
6. Use the VALUE dial to set each parameter.

### Position:

- Specify the location of the notes to be delayed.
- Eighth note (eighth note backbeats)
- 16th note (16th note backbeats)

### Percentage:

- Specify the amount of time that the sound is to be delayed.
- 50%–100%

### Part 1–4 Swing:

- Specify whether the sound will be delayed for each track.
- ON, OFF

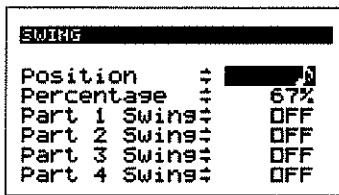

- Press [EXIT].  
You are returned to the recording standby screen.
- Press [STOP] to exit recording.



Never turn off the power while the display indicates "Keep Power On!"

### Assigning a name to a pattern

- Press [PTN].
- Press [F2] (USER).  
The user pattern list will appear.
- Use the VALUE dial to select the pattern that you want to name, and press [ENTER] to confirm your choice.  
To cancel, press [EXIT].
- Press [REC].  
The recording standby screen will appear.
- Press [F3] (NAME).



- Use CURSOR [←][→] to select the character location, and use the VALUE dial to change the character at that location.  
[F1] (CAPS) toggles you between uppercase and lowercase characters.  
[F2] (INSERT) inserts a space.  
[F3] (DELETE) deletes a character.
- Press [EXIT].  
You are returned to the recording standby screen.
- Press [STOP] to exit recording.



Never turn off the power while the display indicates "Keep Power On!"

### Storing the part mute status

The part mute status can be stored for each part.

- Press [PTN].
- Press [F2] (USER).  
The user pattern list will appear.
- Use the VALUE dial to select the pattern whose mute status you want to change, and press [ENTER] to confirm your choice.  
To cancel, press [EXIT].
- Press [REC].  
The recording standby screen will appear.
- Press CURSOR [↓] to move the cursor to "Part Mute."

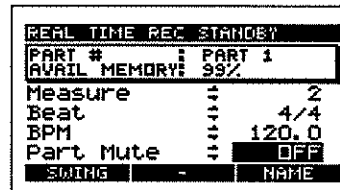

- Use the VALUE dial to specify the mute setting of the currently selected part.  
The button of the selected part will be blinking.  
ON: mute  
OFF: play  
If you want to change the part, press PART [1]-[4] to select the desired part.
- Press [STOP] to return to the Play screen.



Never turn off the power while the display indicates "Keep Power On!"

# Chapter 9. Creating a song

## About song recording

A song is created by connecting patterns that you create. On the SP-505 you can connect a maximum of 999 patterns.

## Making song settings

**Initial BPM:** BPM (tempo) of the song  
40.0–200.0, PTN BPM

If you press [F1] (PTN BPM), this will be set to Pattern BPM, and playback will occur at the BPM specified by each pattern.

## Song recording procedure

1. Press [SONG].
2. Use the VALUE dial to select the song that you want to record.

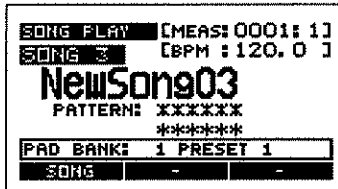

- Alternatively, you can press [F1] (SONG) to display the song list, and use the VALUE dial to select the song that you want to record. After selecting it, press [ENTER] to confirm your selection.

3. Press [REC].  
The song record standby screen will appear.

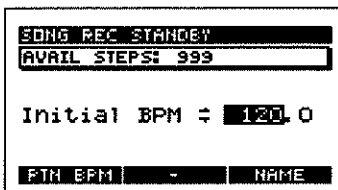

**AVAIL STEPS:** 0–999

For each song, this indicates the remaining number of steps that can be recorded.

\* When AVAIL STEPS reaches 0, no further song recording will be possible.

4. Use the VALUE dial to set the BPM of the song that you will record.

If you press [F1] (PTN BPM), "PTN (Pattern BPM)" will be selected, and playback will use the BPM specified for each pattern.

**Initial BPM:** BPM (tempo) of the song  
40.0–200.0, PTN

5. Press [PLAY].  
Recording will begin.

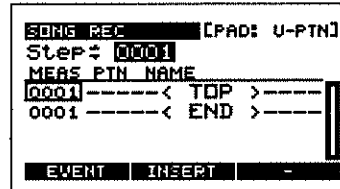

6. Press [F2] (INSERT).  
The pattern list will appear.  
In this screen you can press [PLAY] to hear the selected pattern play back.

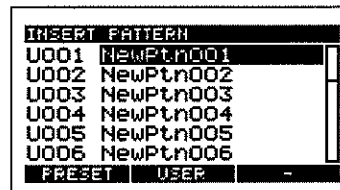

7. Use the VALUE dial to select a pattern, and press [ENTER] to confirm your choice.  
To cancel, press [EXIT].  
The pattern will be input, and you will automatically proceed to the next step.

You can also input a pattern directly by pressing a pad. (Example)

Press pad [1]



Preset pattern 1 or user pattern 1 will be inserted. (User pattern 1 if the previously input pattern was a user pattern, or preset pattern 1 if the previously input pattern was a preset pattern.)

The upper line of the screen indicates whether the previously input pattern is a user or a preset pattern.

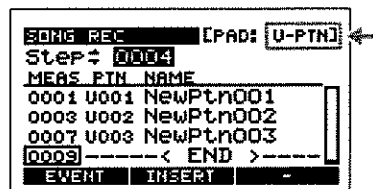

8. Repeats steps 6–7 as necessary.



9. When you are finished inputting patterns, press [STOP].  
You are returned to the song recording standby screen.
10. Press [STOP] to exit recording.



Never turn off the power while the display indicates "Keep Power On!"

### Deleting a pattern

1. In step 6 of song recording, use the VALUE dial to move to the step that you want to delete.
2. Press [F1] (EVENT).
3. Use CURSOR [↓] [↑] to move the cursor to the pattern that you want to delete.  
You can press [PLAY] to hear the selected pattern.
4. Press [F3] (DELETE) to delete the pattern.
5. Press [F1] (STEP) to move the cursor back to the previous location.

### Inserting a pattern

1. In step 6 of song recording, use the VALUE dial to move to the step at which you want to insert a pattern.
2. Press [F1] (EVENT).
3. Use CURSOR [↓] [↑] to move the cursor to the pattern that you want to insert.  
You can press [PLAY] to hear the selected pattern.
4. Press [F2] (INSERT).  
The pattern list will appear.
  - \* If 999 patterns have already been input, "INSERT" will not be displayed above [F2].You can press [PLAY] to hear the selected pattern.
5. Use the VALUE dial to select the pattern that you want to insert, and press [ENTER] to confirm your choice.  
To cancel, press [EXIT].
6. Press [F1] (STEP) to move the cursor back to the previous location.

### Changing a pattern

1. In step 6 of song recording, use the VALUE dial to move to the step of the pattern that you want to change.
2. Press [F1] (EVENT).
3. Use CURSOR [↓] [↑] to move the cursor to the pattern that you want to change.  
You can press [PLAY] to hear the selected pattern.
4. Use the VALUE dial to change the pattern.
5. Press [F1] (STEP) to move the cursor back to the previous location.

### Assigning a name to a song

1. Press [SONG].
2. Use the VALUE dial to select the song that you want to name.
3. Press [REC].  
The recording standby screen will appear.
4. Press [F3] (NAME).

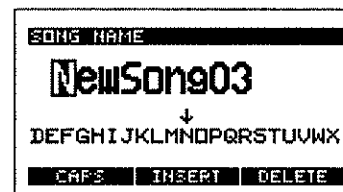

5. Use CURSOR [←] [→] to select the character location, and use the VALUE dial to change the character.  
[F1] (CAPS) toggles you between uppercase and lowercase characters.  
[F2] (INSERT) inserts a space.  
[F3] (DELETE) deletes a character.
6. Press [EXIT].  
You are returned to the recording standby screen.
7. Press [STOP] to exit recording.



Never turn off the power while the display indicates "Keep Power On!"



# Chapter 10. Deleting or copying a pattern or song

## Deleting a pattern or song

1. Press [SONG] or [PTN] to display the Play screen.
2. Press [SYSTEM] to display the System screen.

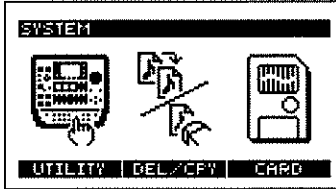

\* It is not possible to display the System screen while a pattern or song is playing.

3. Press [F2] (DEL/CPY).
4. Press [F1] (DELETE).
5. To delete a pattern, press [F1] (PATTERN). To delete a song, press [F2] (SONG).
6. Use the VALUE dial to select the pattern or song that you want to delete.  
\* In the case of a song or pattern that contains performance data, a "\*" will be displayed before the song or pattern number.
7. To execute the deletion, press [F1] (EXECUTE).  
To cancel, press [F2] (CANCEL) or [EXIT].  
If you pressed [F1] (EXECUTE), you will be asked to confirm the deletion.

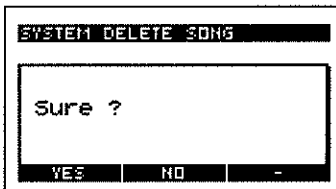

8. To execute the deletion, press [F1] (YES).  
To cancel, press [F2] (NO).

### NOTE

Never turn off the power while the display indicates "Keep Power On!"

9. Press [SONG] or [PTN] to return to the Play screen.

## Copying a pattern or song

1. Press [SONG] or [PTN] to display the Play screen.
2. Press [SYSTEM] to display the System screen

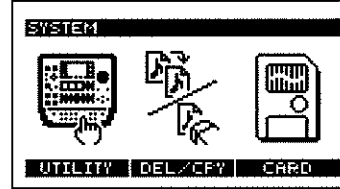

\* It is not possible to display the System screen while a pattern or song is playing.

3. Press [F2] (DEL/CPY).
4. Press [F2] (COPY).
5. To copy a pattern, press [F1] (PATTERN). To copy a song, press [F2] (SONG).
6. Use CURSOR [↑] [↓] to move the cursor, and use the VALUE dial to select the copy source/destination patterns or songs.  
\* In the case of a song or pattern that contains performance data, a "\*" will be displayed before the song or pattern number.
7. To execute the copy, press [F1] (EXECUTE).  
To cancel, press [F2] (CANCEL) or [EXIT].  
If you pressed [F1] (EXECUTE) you will be asked to confirm the copy.

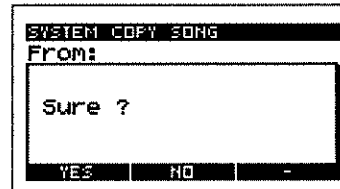

8. To execute the copy, press [F1] (YES).  
To cancel, press [F2] (NO).
9. Press [SONG] or [PTN] to return to the Play screen.

### NOTE

Never turn off the power while the display indicates "Keep Power On!"

# Chapter 11. Using a memory card

## About memory cards

The SP-505 uses commercially available SmartMedia (power supply voltage 3.3 V, capacity: 8 MB–128 MB) as memory cards.

### NOTE

1 MB/2 MB/4 MB SmartMedia cannot be used.

### MEMO

SmartMedia can be purchased at a nearby computer dealer or digital camera dealer.

- \* Please read and observe the instructions included with the SmartMedia.

## Inserting a memory card

### NOTE

Memory cards (SmartMedia) must only be inserted when the SP-505's power is switched OFF. If the power is on when you insert a card, not only the memory card, but also the internal data can be destroyed.

### NOTE

Never turn on the power when a memory card (SmartMedia) is inserted halfway. Doing so will destroy the internal memory data.

If you insert or remove a card with the power turned on, or turn on the power when a card is inserted halfway, a message of "WARNING! Data Maybe Damaged!" will appear, and operation will stop. If this occurs, turn off the power, insert the card all the way or remove it, and then turn the power on once again.

Insert the memory card (SmartMedia) all the way into the slot, making sure that the correct side is facing up, and the correct end is pointing in.

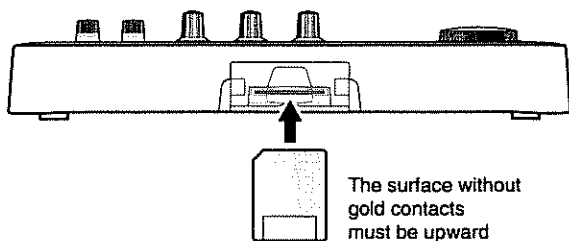

## Formatting a memory card

1. Press [SONG] or [PTN] to display the Play screen.
2. Press [SYSTEM] to display the System screen.

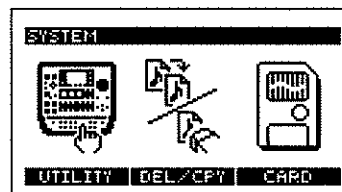

- \* It is not possible to display the System screen while a pattern or song is playing.

3. Press [F3] (CARD).

- \* If a memory card is not inserted, "CARD" will not appear above [F3].

4. Press [F1] (FORMAT).

You will be asked to confirm the Format operation.

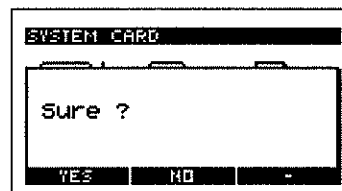

5. To format the card, press [F1] (YES).

To cancel, press [F2] (NO).

- \* When you format a card, all data in the card will be erased.

6. Press [SONG] or [PTN] to return to the Play screen.

### NOTE

Never turn off the power while the display indicates "Keep Power On!"

## Saving data on a memory card (Save)

\* If a write-protect sticker is affixed to the memory card, it will not be possible to save sample or sequencer data.

### Saving sample data

Here's how to save sample data from the SP-505's internal memory to a memory card.

1. Press [SONG] or [PTN] to display the Play screen.
2. Press [SYSTEM] to display the System screen.

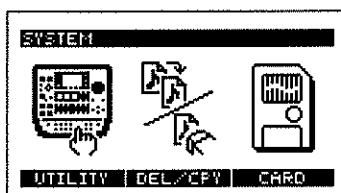

\* It is not possible to display the System screen while a pattern or song is playing.

3. Press [F3] (CARD).
4. Press [F3] (SAVE).

\* If the memory card has been formatted in a format that cannot be used by the SP-505, "SAVE" will not appear above [F3]. Please format the card. (p. 66)

5. Press [F1] (SAMPLE).  
Each pad bank in the SP-505's internal memory will be saved as one set.
6. Use the VALUE dial to select the pad bank that you want to save.

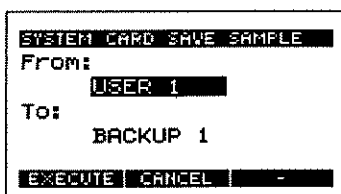

7. Press CURSOR [↓], and use the VALUE dial to select the number of the area in which you want to save.
8. To save the data, press [F1] (EXECUTE).  
To cancel, press [F2] (CANCEL).

\* An asterisk "\*" will be displayed to indicate an area number in which sample data has already been saved. If you select an area number marked by "\*", a message of "OK to Overwrite?" will be displayed. If you are sure this is the area number you want to use, press [F1] (YES). To cancel, press [F2] (NO).

9. Press [SONG] or [PTN] to return to the Play screen.

### NOTE

Never turn off the power while the display indicates "Keep Power On!"

### Saving sequencer data

Here's how to save sequencer data (patterns/songs) from the SP-505's internal memory to a memory card.

1. Press [SONG] or [PTN] to display the Play screen.
2. Press [SYSTEM] to display the System screen.

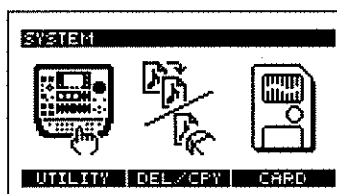

\* It is not possible to display the System screen while a pattern or song is playing.

3. Press [F3] (CARD).
4. Press [F3] (SAVE).

\* If the memory card has been formatted in a format that cannot be used by the SP-505, "SAVE" will not appear above [F3]. Please format the card. (p. 66)

5. Press [F2] (SONG/PTN).  
For sequencer (pattern/song) data, the 100 user patterns and 20 songs in internal memory will be saved as one set.
6. Use the VALUE dial to select the number of the area in which you want to save.

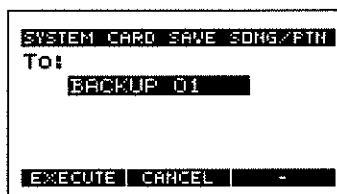

7. To save the data, press [F1] (EXECUTE).  
To cancel, press [F2] (CANCEL).

\* An asterisk "\*" will be displayed to indicate an area number in which sequencer data has already been saved. If you select an area number marked by "\*", a message of "OK to Overwrite?" will be displayed. If you are sure this is the area number you want to use, press [F1] (YES). To cancel, press [F2] (NO).

8. Press [SONG] or [PTN] to return to the Play screen.

### NOTE

Never turn off the power while the display indicates "Keep Power On!"

## Loading memory card data into internal memory (Load)

\* It is not possible to load data into a protected pad bank.

### Loading sample data

Here's how sample data saved on a memory card can be loaded into the SP-505.

1. Press [SONG] or [PTN] to display the Play screen.
2. Press [SYSTEM] to display the System screen.

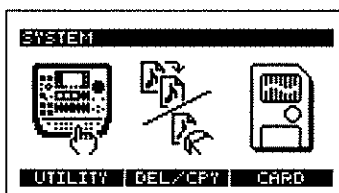

\* It is not possible to display the System screen while a pattern or song is playing.

3. Press [F3] (CARD).

\* If a memory card is not inserted, "CARD" will not appear above [F3].

4. Press [F2] (LOAD).

\* If the memory card has been formatted in a format that cannot be read by the SP-505, "LOAD" will not appear above [F2]. Please format the card. (p. 66)

5. Press [F1] (SAMPLE).

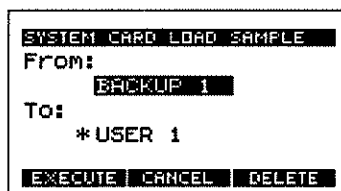

6. Use the VALUE dial to select the number of the area that you want to load.

One bank of the SP-505's internal memory will be loaded as a set.

If no files have been saved, the display will indicate "\*\*\*\*\*".

7. Press CURSOR [↓] to move the cursor to the pad bank display.
8. Use the VALUE dial to select the pad bank that you want to load.
9. To load the data, press [F1] (EXECUTE). To cancel, press [F2] (CANCEL).
10. Press [SONG] or [PTN] to return to the Play screen.

\* When you load, the sample and sequencer data saved in internal memory will be erased. Be sure to save important data on a memory card before you load. (p. 67)

### NOTE

Never turn off the power while the display indicates "Keep Power On!"

## Loading sequencer data

Sample and sequencer (pattern/song) data that you've saved on a memory card can be loaded back into the SP-505 as follows.

1. Press [SONG] or [PTN] to display the Play screen.
2. Press [SYSTEM] to display the System screen.

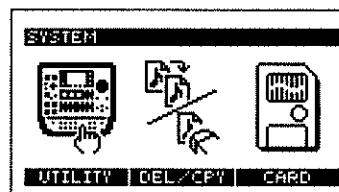

\* It is not possible to display the System screen while a pattern or song is playing.

3. Press [F3] (CARD).

\* If a memory card is not inserted, "CARD" will not appear above [F3].

4. Press [F2] (LOAD).

\* If the memory card has been formatted in a format that cannot be read by the SP-505, "LOAD" will not appear above [F2]. Please format the card. (p. 66)

5. Press [F2] (SONG/PTN).

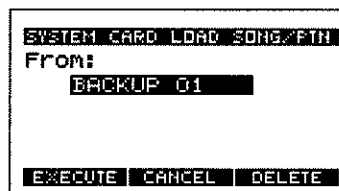

6. Use the VALUE dial to select the number of the area that is to be loaded.

If no files have been saved, the display will indicate "\*\*\*\*\*".

7. To load the data, press [F1] (EXECUTE).  
To cancel, press [F2] (CANCEL).
8. Press [SONG] or [PTN] to return to the Play screen.
  - \* When you load, the sample and sequencer data in internal memory will be erased. Be sure to save important data on a memory card before you load. (p. 67)

### NOTE

Never turn off the power while the display indicates "Keep Power On!"

## Deleting data from a memory card

Here's how to delete sample or sequencer (pattern/song) data from a memory card.

1. Press [SONG] or [PTN] to display the Play screen.
2. Press [SYSTEM] to display the System screen.

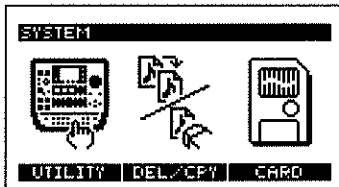

\* It is not possible to display the System screen while a pattern or song is playing.

3. Press [F3] (CARD).
4. Press [F2] (LOAD).
5. To delete sample data, press [F1] (SAMPLE). To delete sequencer (pattern/song) data, press [F2] (SONG/PTN). The file names of sample or sequencer files saved on the memory card will be displayed.

If no files have been saved, the display will indicate "\*\*\*\*\*".



6. Use the VALUE dial to select the file that you want to delete.

7. Press [F3] (DELETE).

You will be asked to confirm that you really want to delete the file.



8. To delete, press [F1] (YES).  
To cancel, press [F2] (NO).
9. Press [SONG] or [PTN] to return to the Play screen.

### NOTE

Never turn off the power while the display indicates "Keep Power On!"

## Loading WAV/AIFF files into the SP-505

Standard waveform data (WAV/AIFF files) saved on a memory card can be loaded into the SP-505.

\* Before you continue, save the WAV/AIFF files from your computer onto a memory card.

1. With the power of the SP-505 turned off, insert the memory card into the memory card slot, then turn on the power switch.
2. Press [SYSTEM] to display the System screen.

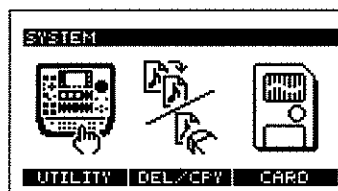

\* It is not possible to display the System screen while a pattern or song is playing.

3. Press [F3] (CARD).
  - \* If a memory card is not inserted, "CARD" will not appear above [F3].
4. Press [F2] (LOAD).
  - \* If the memory card has been formatted in a format that cannot be read by the SP-505, "LOAD" will not appear above [F2]. Please format the card. (p. 66)

### 5. Press [F3] (FILE).

The names of the WAV and AIFF files saved on the card will be displayed.

If no WAV or AIFF files have been saved, the display will indicate "\*\*\*\*\*".

- \* File names longer than eight characters and file names in Japanese will not be displayed correctly.

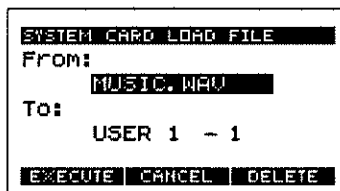

### 6. Use the VALUE dial to select the file that you want to load.

### 7. Press CURSOR [↓], and use the VALUE dial to select the pad to which the file you want to load is to be assigned.

### 8. Press [F1] (EXECUTE) to load the file.

To cancel, press [F2] (CANCEL).

### 9. Press [SONG] or [PTN] to return to the Play screen.

#### NOTE

Never turn off the power while the display indicates "Keep Power On!"

## Precautions concerning the loading of WAV/AIFF files

- The filename extension must be wav for WAV files, and aif for AIFF files. The file cannot be recognized with any other extension.
- Only files with 8 or 16 bit quantization are supported.
- Sample rate conversion is not performed. The data will be loaded as if its sampling rate were 44.1 kHz. If you load a file with a sample rate of anything other than 44.1 kHz, the playback pitch will be incorrect.
- The loop point settings within an AIFF file will be ignored.
- If you attempt to load a WAV/AIFF file in a format that the SP-505 does not support, an error message of "Unsupported Format!" will appear, and it will not be possible to load the file.
- Compressed WAV files or AIFF files cannot be loaded.
- Extremely short waveform data (less than approximately 70 ms) cannot be loaded.

## Deleting a WAV/AIFF file

### 1. Press [SONG] or [PTN] to display the Play screen.

### 2. Press [SYSTEM] to display the System screen.

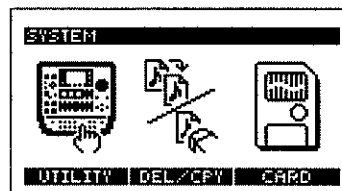

- \* It is not possible to display the System screen while a pattern or song is playing.

### 3. Press [F3] (CARD).

- \* If a memory card is not inserted, "CARD" will not appear above [F3].

### 4. Press [F2] (LOAD).

- \* If the memory card has been formatted in a format that cannot be read by the SP-505, "LOAD" will not appear above [F2]. Please format the card. (p. 66)

### 5. Press [F3] (FILE).

The names of the WAV and AIFF files saved on the card will be displayed. If no WAV or AIFF files have been saved, the display will indicate "\*\*\*\*\*".

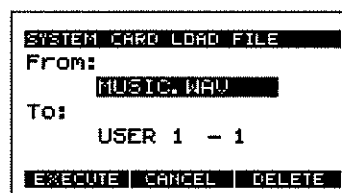

### 6. Use the VALUE dial to select the file that you want to delete.

### 7. Press [F3] (DELETE).

You will be asked to confirm that you really want to delete the file.

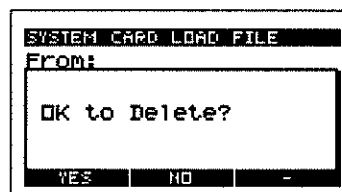

### 8. To delete the file, press [F1] (YES).

To cancel, press [F2] (NO).

### 9. Press [SONG] or [PTN] to return to the Play screen.

#### NOTE

Never turn off the power while the display indicates "Keep Power On!"

# Chapter 12. Using the SP-505 with other MIDI devices

\* Do not use a MIDI cable to directly connect the SP-505's MIDI IN connector to its own MIDI OUT connector (creating a loop). The SP-505 may fail to operate correctly if this is done.

## About MIDI

MIDI stands for Musical Instrument Digital Interface. It is a universal standard, designed to provide for the exchange of performance data among electronic musical instruments, computers, and other devices. The SP-505 supports the use of MIDI, and provides two MIDI connectors: MIDI IN and MIDI OUT. These connectors can be connected to other MIDI devices, thus greatly expanding your performance possibilities.

## About the MIDI connectors

The SP-505 has the following MIDI connectors.

### MIDI IN:

Receives MIDI messages from other MIDI devices.

### MIDI OUT:

Transmits MIDI messages from the SP-505.

## About the MIDI implementation chart

The MIDI implementation chart (p. 87) provides an easy way to view the types of MIDI message that the SP-505 can transmit and receive. Compare the SP-505's MIDI implementation chart with the implementation chart of some other connected MIDI device, and use the MIDI messages that are recognized by both devices.

For details of the SP-505's MIDI functionality, refer to "MIDI implementation."

## Changing the MIDI settings

### MIDI parameters

**Pads Ch:** 1-16, OFF

Specify the channel on which pad performance data will be transmitted and received.

**Part 1-4 Ch:** 1-16, OFF

Specify the channel that will output the parts of the song or pattern.

**Prog Chg SW:** OFF, ON

Specify whether program change messages will be received and transmitted. On the SP-505, program change messages are employed when switching the bank that is to be played by MIDI (note messages).

**Sync Mode:** INT, MIDI, REMOTE, AUTO

Specify the mode used when synchronizing the SP-505's performance with an external MIDI device.

For details refer to "Synchronizing the performance of the SP-505 and an external MIDI device," p. 72.

### Procedure

1. Press [SONG] or [PTN] to display the Play screen.
2. Press [SYSTEM] to display the System screen.

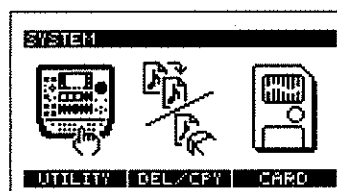

\* It is not possible to display the System screen while a pattern or song is playing.

3. Press [F1] (UTILITY).

4. Press [F2] (MIDI).

The MIDI Settings screen will appear.

5. Press CURSOR [↓] [↑] to select the parameter, and use the VALUE dial to change the setting.

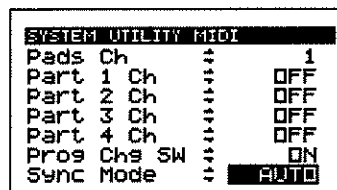

6. Press [PTN] or [SONG] to return to the Play screen.

\* It is not possible to change MIDI settings while the sequencer is playing.

## Chapter 12. Using the SP-505 with other MIDI devices

### NOTE

Never turn off the power while the display indicates "Keep Power On!"

### MEMO

The SP-505 transmits pad performance data as sets consisting of "program change message + note message." If this performance data is overdubbed on an external sequencer, some sequencers may automatically rearrange the overdubbed data, making it impossible for the performance data to be reproduced correctly.

## Synchronizing the performance of the SP-505 and an external MIDI device

In order for the performance to be synchronized with an external MIDI device, you must decide which device (the SP-505 or the external MIDI device) will control start/stop, and which device will determine the BPM (Sync mode).

### Connections for synchronized performance

Use a MIDI cable to connect the MIDI OUT connector of the master device to the MIDI IN connector of the SP-505.

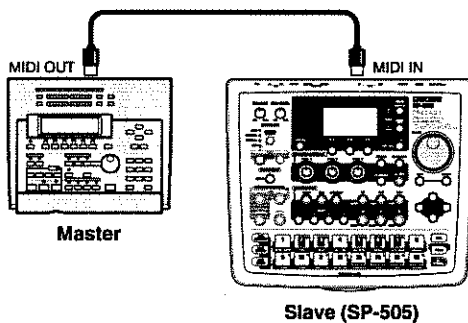

### Sync mode settings

1. Press [SONG] or [PTN] to display the Play screen.
2. Press [SYSTEM] to display the System screen.

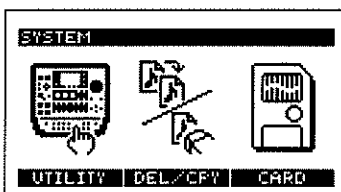

\* It is not possible to display the System screen while a pattern or song is playing.

3. Press [F1] (UTILITY).
4. Press [F2] (MIDI).  
The MIDI Settings screen will appear.
5. Press CURSOR [↓] to select Sync Mode, and use the VALUE dial to change the setting.

SYSTEM UTILITY MIDI		
Pads Ch	↑↓	1
Part 1 Ch	↑↑↑↓	OFF
Part 2 Ch	↑↑↑↓	OFF
Part 3 Ch	↑↑↑↓	OFF
Part 4 Ch	↑↑↑↓	OFF
Prog Chs SW	↑↓	ON
Sync Mode	↑↓	AUTO

	Start/Stop	BPM
INT	Control from SP-505 only	Use SP-505's internal BPM
MIDI	Control from SP-505/ Control from external MIDI device	Use MIDI Clock messages
REMOTE	Control from SP-505/ Control from external MIDI device	Use SP-505's internal BPM
AUTO	Control from SP-505	Use SP-505's Internal BPM
	Control from external MIDI device	Use MIDI Clock messages

\* If the Sync Mode is set to MIDI, playback will not occur unless MIDI Clock messages are received from an external MIDI device.

6. Press [PTN] or [SONG] to return to the Play screen.

### NOTE

Never turn off the power while the display indicates "Keep Power On!"

- \* At the factory settings, this is set to AUTO.
- \* It is not possible to change the MIDI settings while the sequencer is playing.



# Chapter 13. Making system settings

Here's how to make system settings (such as LCD Contrast) for the SP-505.

## About the CONFIG parameters

### LCD Contrast: 1–16

This adjusts the LCD contrast.

### Pad Protect: (BANK 5–16) OFF, ON

For each pad bank, you can apply Protect to prevent the samples from being erased.

### Metronome LV: 0–10

This adjusts the metronome volume during pattern recording.

### Foot SW Asgn: PLAY, SMPL, PAD 1–16, FX

Specify the function of a foot switch connected to the FOOT SW jack.

**PLAY:** Control playback start/stop of a pattern or song.

**SMPL:** Control start/stop of sampling.

**PAD 1–16:** Play the sound of the specified pad number.

**FX ON/OFF:** Switch the effect on/off.

\* When connecting a foot switch (FS-5U; sold separately) to the FOOT SW jack, set the polarity switch as follows.

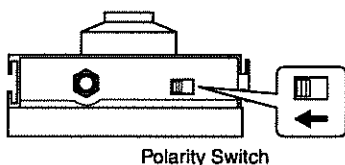

### Chop Demo: OFF, ON

Determines whether a demo sound will be played when the Chop function is used.

### Pitch Demo: OFF, ON

Determines whether a demo sound will be played when the Pitch function is used.

### Power Up PTN: PRESET, USER

Specify the pattern that will be selected when the power is turned on.

**PRESET:** Preset Pattern

**USER:** User Pattern

### Power Up BNK: PRESET, USER

Specify the pad bank that will be selected when the power is turned on.

**PRESET:** Preset Bank

**USER:** User Bank

1. Press [SONG] or [PTN] to display the Play screen.
2. Press [SYSTEM] to display the System screen.

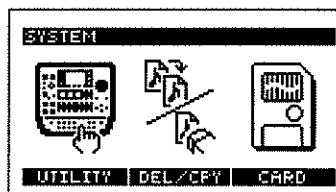

\* It is not possible to display the System screen while a pattern or song is playing.

3. Press [F1] (UTILITY).
4. Press [F1] (CONFIG).  
The system settings screen will appear.
5. Use CURSOR [↑] [↓] to select the parameter, and use the VALUE dial to make the setting.

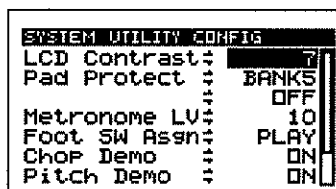

6. Press [PTN] or [SONG] to return to the Play screen.

### NOTE

Never turn off the power while the display indicates "Keep Power On!"

# Chapter 14. Restoring the factory settings

Use the Initialize operation when you want to restore the system and pattern data to the factory settings. You can restore all data to the factory settings at once, or select a specific type of data, such as sequencer settings, to be initialized.

## Factory settings

### Samples

Samples are assigned to pads [1]–[16] of user bank 1.

\* Once you carry out an initialization, these samples will be erased and cannot be recovered.

### Sequencer (songs/patterns)

All songs are empty.

All user patterns are empty.

### System

#### UTILITY CONFIG

LCD Contrast: 6  
Pad Protect: (BANK 5–16), OFF  
Metronome LV: 10  
Foot SW Asgn: PLAY  
Chop Demo: ON  
Pitch Demo: ON  
Power Up PTN: PRESET  
Power Up BNK: PRESET

#### UTILITY MIDI

Pads Ch: 1  
Part 1–4 Ch: OFF  
Prog Chg SW: ON  
Sync Mode: AUTO

## Procedure

1. Press [SONG] or [PTN] to display the Play screen.
2. Press [SYSTEM] to display the System screen.

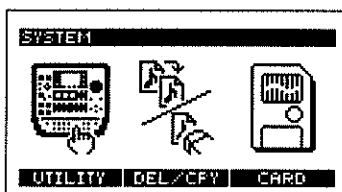

\* It is not possible to display the System screen while a pattern or song is playing.

3. Press [F1] (UTILITY).

4. Press [F3] (INIT).

The Initialize screen will appear.

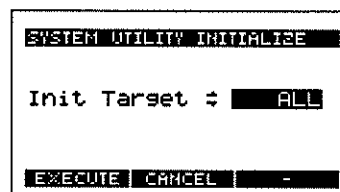

5. Use the VALUE dial to select the type of setting that you want to initialize.

Init Target: ALL, SYSTEM, SAMPLE, SEQ

**ALL:** All system-related parameters will be initialized.  
All pad samples will be erased. (Except for preset samples)  
All songs and all user patterns will be erased.

**SYSTEM:** System-related parameters will be initialized.

**SAMPLE:** All pad samples will be erased. (Except for preset samples)

**SEQ:** All songs and all user patterns will be erased.

6. To initialize the settings you selected, press [F1] (EXECUTE).

To cancel, press [F2] (CANCEL) or [EXIT].

When you press [F1] (EXECUTE), a screen asking you to confirm that you indeed do want to carry out an initialization appears.

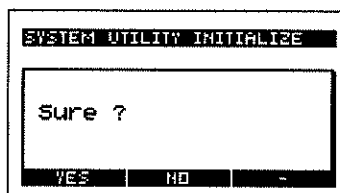

\* If you attempt to initialize SAMPLE when sample memory is protected, the display will ask "Protected! Sure?".

7. To initialize the settings, press [F1] (YES).

To cancel, press [F2] (NO)

8. Press [PTN] or [SONG] to return to the Play screen.

### NOTE

Never turn off the power while the display indicates "Keep Power On!"

# Chapter 15. Appendices

## Troubleshooting

If the SP-505 does not operate as you expect, check the following points.

If this does not resolve the problem, please contact the nearest Roland Service Center or your dealer.

### ■ No sound/volume is too low

- Is the power of the SP-505 and connected devices turned on?
- Are the SP-505 and external devices connected correctly?  
→ Check the connections.
- An audio cable may be broken.
- The cable connected to DIGITAL IN may be broken.
- You may be using an audio cable with a built-in resistor.  
→ Use a connection cable that does not contain a resistor (e.g., Roland PCS series).
- The volume of a connected amp or mixer may be turned down.  
→ Adjust the volume to an appropriate level.
- The volume of SP-505 may be turned down.  
→ Adjust the volume to an appropriate level.
- If you are using a memory card, is the memory card inserted correctly?  
→ Turn off the power, remove the memory card, and then re-insert it correctly all the way.
- If you are attempting to play a sample, is the pad of the sample lit?  
→ When you press a pad that contains a sample, the pad will light and the sample will sound. If the pad does not light when you press it, a sample has not yet been assigned to that pad. Sample a sound for the pad.
- If you are attempting to play a song or pattern, does the song or pattern contain performance data?  
→ Record the song or pattern so that it contains performance data. (p. 63, 58)
- If you are attempting to play a song or pattern, MIDI Sync Mode may be set to MIDI.  
→ If MIDI Sync Mode is set to "MIDI," playback will not occur unless MIDI Clock is being received from an external MIDI device. (p. 72)

### ■ A specific sample does not sound

- The level of that sample may have been lowered.  
→ Check the level of the sample. (p. 44)
- The effect level may have been lowered.  
→ For some types of effect, the level can be adjusted by one of the control knobs.  
For the correspondence between effect types and control knobs, refer to p. 36.

### ■ A sample does not stop sounding

- The Pad Play setting of the sample may be set to DRUM.  
→ Since the sample will continue sounding until the End point, a long sample may give the impression that the sound never stops.  
If you want to change the way that the sample is played, change the setting to something other than DRUM. (p. 44)

### ■ External input sound cannot be heard/volume is too low

- Is [EXT SOURCE] lit?  
→ In order for an external input sound to be heard, you must press [EXT SOURCE] to make the pad light.
- The level of the external input may be lowered.  
→ Adjust the REC LEVEL knob to an appropriate level.
- The volume of the device connected to LINE IN may be lowered.  
→ Adjust it to an appropriate level.
- Are the audio cables connected correctly?  
→ Check the connections.
- An audio cable may be broken.
- The cable connected to DIGITAL IN may be broken.
- Could you be using an audio cable with a built-in resistor?  
→ Use a connection cable that does not contain a resistor (e.g., Roland PCS series).

### ■ External input sound is not stereo/is not monaural

- [EXT SOURCE] may be set to monaural.  
→ Change the [EXT SOURCE] setting Type=STEREO. (p. 33)
- [EXT SOURCE] may be set to stereo.  
→ Change the [EXT SOURCE] setting Type=MONO. (p. 33)

### ■ Mic sound is not output/is too weak

- Is the mic cable connected correctly?  
→ Check the connection.
- The mic cable may be broken.
- The input source may be set to something other than mic.  
→ Press [SOURCE SELECT] to select "MIC."
- The mic level may have been lowered.  
→ Use the REC LEVEL knob to adjust the level appropriately.

### ■ Can't record a sample

- Is there enough memory capacity?  
→ If there is insufficient memory, a message of "Memory Full!" will appear when you attempt to sample. Delete unneeded samples to increase the amount of free space.
- If you are attempting to sample to a memory card, is the memory card inserted correctly?  
→ Turn off the power, remove the memory card, and re-insert the memory card correctly.
- If you are attempting to sample to a memory card, has the memory card been formatted by the SP-505?  
→ Format the memory card. (p. 66)
- Samples may have been assigned to all pads.  
→ Sampling is not possible if there are no vacant pads. Delete unneeded samples to free up one or more pads.
- A song/pattern may currently be playing or recording.  
→ Press [STOP] to stop song/pattern playback or recording.
- Could you currently be deleting or copying a sample?  
→ Sampling cannot be performed while a sample is being deleted or copied.

### ■ Sampled sound contains excessive noise or distortion

- Is the input level appropriate?  
→ If the input level is too high, the sampled sound will be distorted. If it is too low, noise will be heard. Turn the REC LEVEL knob to adjust the level so that the third "□" from the top in the level meter shown in the display becomes black occasionally.
- Are the effect settings appropriate?  
→ Some types of effect may increase the level louder than the original sample, or may intentionally distort the sound. Some effects will also cause noise to be emphasized. Temporarily turn off effects, and check whether the sample itself contains noise or distortion. Then adjust the effect settings appropriately. For the relation between effect types and control knobs, refer to "Effects List" p. 36.
- Are multiple samples being played simultaneously?  
→ Even if the level of each individual sample is appropriate, simultaneously playing multiple samples may cause the overall level to be excessively high, causing distortion. Lower the level of each sample ("Adjusting the settings of a sample," p. 44) so that the sound is not distorted.

## Problems with internal memory

### ■ Data was not saved correctly in internal memory

- It is possible that the power was turned off while data was being written into internal memory (while the "Keep Power On!" message was displayed). The lost data cannot be recovered.  
→ In this case, it is possible that all of the internal memory data may be damaged. If you continue using the SP-505 in this state, further malfunctions may occur. Please initialize the internal memory. When you initialize, all data in internal memory will be lost. (p. 74)

## Problems with a memory card

### ■ Data was not saved correctly in a memory card

- It is possible that the power was turned off while data was being written into the memory card (while the "Keep Power On!" message was displayed). The lost data cannot be recovered.
  - In this case, it is possible that the data of the entire memory card has been damaged. If you continue using the SP-505 in this state, further malfunctions may occur. Please format the memory card. When you format, all data in the memory card will be lost. (p. 66)
- The Protect sticker may be affixed to the memory card.

### ■ An inserted memory card is not detected

### ■ Can't select data from a memory card

- Is the memory card inserted correctly?
  - Turn off the power, remove the memory card, then re-insert the memory card correctly.
- Is the memory card an appropriate type?
  - The SP-505 can use 8 MB–128 MB (3.3V) SmartMedia memory cards. Other types cannot be used.
- Is the memory card formatted correctly?
  - Only memory cards that have been formatted by the SP-505 or SP-303 can be used. Please format the memory card. (p. 66)

## Problems with MIDI or synchronization

### ■ Can't play samples from an external MIDI device

- Is the power of the external MIDI device turned on?
- Are the MIDI cables connected correctly?
  - Check the connections.
- A MIDI cable may be broken.
- Is the MIDI channel set correctly?
  - Set the MIDI channels of the SP-505 and external MIDI device to the same setting. (p. 71)
- Is the external MIDI device set to transmit note messages?
  - Make sure that the note numbers of the note messages are in the range of note numbers that the SP-505 is able to receive. (p. 83)
  - Check the settings of the external MIDI device.
- Is the external MIDI device set to transmit program change messages?
  - The SP-505 uses program change messages to switch pad banks. Make sure that the program numbers of the program change messages are in the range of program numbers that the SP-505 is able to receive. (p. 83)
  - Check the settings of the external MIDI device.

### ■ Pattern sequencer does not synchronize to the BPM of an external MIDI device

- Is the System parameter MIDI Sync Mode set correctly?
  - Check the setting. (p. 72)
- Is the external MIDI device set to transmit MIDI clock messages?
  - Some devices have a MIDI clock transmission on/off setting. Also, some external rhythm machines or external sequencers transmit MIDI clock only while they are playing.
- Is the external MIDI device set to receive MIDI clock messages?
  - Check the setting of the external MIDI device.
- Does the BPM of the external MIDI device exceed the BPM range to which the SP-505 can synchronize?
  - The SP-505 can synchronize to a BPM in the range of 40.0–200.0. Synchronization cannot be guaranteed outside this range of BPM.

### Error message list

---

#### ■ Sampling related

##### Memory Full!

- Sampling is not possible because there is no space in user memory.  
→ Delete unneeded sample data. (p. 49)
- Ran out of user memory during sampling.  
→ Delete unneeded sample data. (p. 49)
- Not enough memory to use the Chop function.  
→ Delete unneeded sample data. (p. 49)
- Not enough memory to use the Scale function.  
→ Delete unneeded sample data. (p. 49)

##### Awaiting Digital Signal

- You are attempting to sample the signal from DIGITAL IN, no signal is detected.  
→ Check whether a digital signal is being output from the connected digital device. (For details, refer to the manual for the connected device.)
- The sampling frequency of the signal from DIGITAL IN is not 44.1 kHz.  
→ Set the sampling frequency to 44.1 kHz. (For details refer to the manual of the connected device.)

##### Not Sampling Bank!

- Sampling is not possible since the Chop bank or the Pitch bank is selected.  
→ Switch to another pad bank.

##### Protected!

- Deletion is not possible because the sample is protected.  
→ Turn off the protect setting of the sample. (p. 73)
- Overwriting is not possible because the sample is protected.  
→ Turn off the protect setting of the sample. (p. 73)

##### Protected! Sure?

- Initialization is not possible because the sample is protected.  
→ To continue with initialization, press [F1] (YES).  
To cancel, press [F2] (NO).

#### Too Busy

- Notes are not sounded in time.  
→ Reduce the number of notes.

#### ■ MIDI related

##### MIDI Off Line!

- There is a problem with the MIDI cable connection.  
→ Check whether the MIDI cable has been disconnected or broken.

##### MIDI Buffer Full!

- Too many MIDI messages were received all at once, and the SP-505 was unable to process all of them.  
→ Reduce the amount of MIDI messages being transmitted to the SP-505.

##### MIDI Error!

- A MIDI message was not received correctly.  
→ Check whether the MIDI cable has been disconnected or broken.  
→ Check whether invalid MIDI messages are being transmitted.

#### ■ Song/pattern recording related

##### Memory Full!

- Song/pattern cannot be saved because there is insufficient space in user memory.  
→ Delete unneeded songs or patterns.

##### Too Much Data!

- Recording/playback is not possible because there is too much performance data, or because the BPM is too fast.  
→ Lower the BPM. Delete unneeded performance data.

##### Pattern REC Full!

- No more data can be recorded in the pattern, since the maximum number of notes that can be recorded has been exceeded.  
→ Delete unneeded data from the pattern being recorded. (p. 59, 60)

### Song REC Full!

- No more can be recorded in this song, since the maximum number of patterns in one song has been exceeded.
  - A maximum of 999 patterns can be registered as part of one song. No further patterns can be registered.

### ■ Card related

#### WARNING! Turn OFF Power Data Maybe Damaged!

- A card was inserted or removed while the power was on, or the power was turned on when a card was inserted halfway.
  - Turn off the power, remove the card or insert it correctly, and then turn the power on once again.

### Memory Full!

- Data cannot be saved, since there is insufficient space remaining on the memory card.
  - Delete unneeded data. (p. 69)
- There is not enough memory to load the WAV/AIFF file.
  - Delete unneeded samples. (p. 49)
  - Reduce the size of the WAV/AIFF file.

### Protected!

- Sampling to a memory card bank is not possible because a write-protect sticker is affixed to the memory card.
  - Remove the write-protect sticker from the memory card.
- Data cannot be saved because a write-protect sticker is affixed to the memory card.
  - Remove the write-protect sticker from the memory card.

### Unsupported Format!

- The format of the inserted memory card is a format that the SP-505 cannot use.
  - The SP-505 is able to use only 8–128 MB Smart Media memory cards with a 3.3 V power supply. Please check the type of card you are using.
- Loading/saving is not possible because the sample or sequencer data is corrupted.
  - Either erase (p. 69) the offending data, or format the memory card (p. 66).

- You are attempting to load a WAV/AIFF file that cannot be loaded into the SP-505.
  - Read the cautionary notes regarding the loading of WAV/AIFF files. (p. 70)

### ■ System related

#### Too Busy

- The data could not be processed fast enough.
  - Operate the buttons or VALUE dial more slowly.

#### Memory Damaged

- The contents of internal memory have been destroyed.
  - Perform the Initialize operation as directed by the display.
  - If this does not resolve the problem, contact a nearby Roland service center.

## Parameter List

Parameter	Display	Value
<b>Sampling</b>		
SOURCE SELECT	SOURCE SELECT	LINE, COAXIAL, OPTICAL, MIC
Type	Type	MONO, STEREO
Grade	Grade	STANDARD, LONG, LO-FI
Auto	Auto	OFF, LEVEL 1-8
With BPM	With BPM	OFF, 40.0-200.0
<b>Resampling</b>		
SOURCE SELECT	SOURCE SELECT	LINE, MIC
Type	Type	MONO, STEREO
Grade	Grade	STANDARD, LONG, LO-FI
Auto	Auto	OFF, ON
<b>Wave Edit</b>		
Level	Level	0-127
Panpot	Panpot	LEFT, CENTER, RIGHT
Pad Play	Pad Play	TRIG, GATE, DRUM
Loop Mode	Loop Mode	OFF, ON
Reverse	Reverse	OFF, ON
Play Type	Play Type	SINGLE, PHRASE
Measure	Measure	1/128-1/2, 1-99998
Beat	Beat	1/4-1/8
Amplify	Amplify	0-400
<b>BPM Adjust</b>		
Play BPM	Play BPM	40.0-200.0
<b>BPM Sync</b>		
SYNC BPM	SYNC BPM	40.0-200.0
<b>Chop</b>		
Resolution	Resolution	1-10
<b>Pitch</b>		
Pitch Mode	Pitch Mode	SOLO L, SOLO H, MUSIC
Original Key	Original Key	C, C#, D, D#, E, F, F#, G, G#, A, A#, B, C <UP>
Pitch Bank	Pitch Bank	1, 2
<b>Pad Accent</b>		
Pad Accent	Pad Accent	1-127
<b>Pad Bank</b>		
Pad Bank	Pad Bank	1-32
<b>Song</b>		
SONG	SONG	1-20
Initial BPM	Initial BPM	PTN, 40.0-200.0
Step	Step	1-999
<b>Pattern</b>		
PATTERN	PATTERN	PRESET 1-40, USER 1-100
Measure	Measure	1-8
Beat	Beat	1/4-4/4
BPM	BPM	40.0-200.0
Part Mute	Part Mute	OFF, ON
Quantize	QTZ	Quarter note, Quarter note triplet, Eighth note, Eighth note triplet, Sixteenth note, Sixteenth note triplet, 32nd note, 32nd note triplet, OFF
Rehearsal	RHR	OFF, ON



Parameter	Display	Value
<b>Position Swing</b>		
Position	Position	Eighth note, 32nd note
Percentage	Percentage	50–100%
Part 1 Swing	Part 1 Swing	OFF, ON
Part 2 Swing	Part 2 Swing	OFF, ON
Part 3 Swing	Part 3 Swing	OFF, ON
Part 4 Swing	Part 4 Swing	OFF, ON
<b>System Utility Configuration</b>		
LCD Contrast	LCD Contrast	1–16
Pad Protect	Pad Protect	BANK5–16: OFF, ON
Metronome Level	Metronome LV	0–10
Foot Switch Assign	Foot SW Asgn	PLAY, SMPL, PAD1–16, FX
Chop Demo	Chop Demo	OFF, ON
Pitch Demo	Pitch Demo	OFF, ON
Power UP Pattern	Power UP PTN	PRESET, USER
Power UP Bank	Power UP BNK	PRESET, USER
<b>System Utility MIDI</b>		
Pads Channel	Pads Ch	1–16, OFF
Part 1 Channel	Part 1 Ch	1–16, OFF
Part 2 Channel	Part 2 Ch	1–16, OFF
Part 3 Channel	Part 3 Ch	1–16, OFF
Part 4 Channel	Part 4 Ch	1–16, OFF
Program Change Switch	Prog Chg SW	OFF, ON
Sync Mode	Sync Mode	INT, MIDI, REMOTE, AUTO
<b>System Utility Initialize</b>		
Initialize Target	Init Target	ALL, SYSTEM, SAMPLE, SEQ
<b>System Delete Pattern</b>		
Target	Target	U001–100
<b>System Copy Pattern</b>		
From	From	P001–040, U001–100
To	To	U001–100
<b>System Delete Song</b>		
Target	Target	U01–20
<b>System Copy Song</b>		
From	From	U01–20
To	To	U01–20
<b>System Card Load Sample</b>		
From	From	BACKUP 1–16
To	To	USER 1–8, CHOP 1–2, PITCH 1–2, CARD 1–16
<b>System Card Load Song/Pattern</b>		
From	From	BACKUP 1–16
<b>System Card Load File</b>		
From	From	*.WAV, *.AIF
To	To	USER 1-1 – 8-16, CARD 1-1 – 16-16
<b>System Card Save Sample</b>		
From	From	PRESET 1–4, USER 1–8, CHOP 1–2, PITCH 1–2, CARD 1–16
To	To	BACKUP 1–16
<b>System Card Save Song/Pattern</b>		
To	To	BACKUP 1–16

**Preset Sample**

PAD BANK	PAD No.	Sample Name
1	1	TR808 Kick 1
	2	TR808Cowbell
	3	TR808 Snr
	4	TR808 Clap
	5	TR909 Snr 3
	6	CR78 Beat
	7	TR808 CHH
	8	TR808 Kick 2
	9	CR78 Guiro
	10	TR808 Conga
	11	TR808 OHH
	12	TR808 Tom
	13	CR78 Tamb
	14	TR606 Cym
	15	Techno Scene
	16	808 Maracas
2	1	Hip Kick
	2	HipJazz Snr
	3	Jazz Snare
	4	Funk Clap
	5	Macho Snare
	6	R&B Snare
	7	Real CHH
	8	Lo-Fi Kick
	9	Pedal Hat
	10	Pop Hat Open
	11	Hip OHH
	12	Philly Hit
	13	Tambourine
	14	NaturalCrash
	15	Pop CHH
	16	Natural Ride

PAD BANK	PAD No.	Sample Name
3	1	TR909 Kick
	2	TR909 Rim
	3	TR909 Snr 1
	4	TR909 Clap 1
	5	TR909 Snr 2
	6	TR909 DstTom
	7	TR909 CHH
	8	TR909 BD9
	9	TechnoShaker
	10	TR727 Agogo
	11	TR909 OHH
	12	TR909 Tom
	13	Finger Snap
	14	TR909 Crash
	15	TR909 Clap 2
	16	TR909 RIDE
4	1	Bass G1
	2	Bass G2
	3	TB303 G1
	4	TB303 G2
	5	Sin Bass G1
	6	Sin Bass G2
	7	Acoustic Bass G1
	8	Acoustic Bass G2
	9	Juno Bass G1
	10	Juno Bass G2
	11	Synth Pad G3
	12	Synth Pad G4
	13	Piano G3
	14	Piano G4
	15	Organ G3
	16	Organ G4

**Preset Pattern**

No.	Pattern Name	BPM	Measure
1	HIP-HOP 01	94	4
2	HIP-HOP 02	92	4
3	HIP-HOP 03	102	4
4	HIP-HOP 04	98	4
5	HIP-HOP 05	99	4
6	HIP-HOP 06	92	4
7	HIP-HOP 07	85	4
8	HIP-HOP 08	87	4
9	HIP-HOP 09	91	4
10	HIP-HOP 10	99	4
11	HIP-HOP 11	93	4
12	HIP-HOP 12	100	4
13	HIP-HOP 13	102	4
14	HIP-HOP 14	97	4
15	HIP-HOP 15	100	4
16	HIP-HOP 16	120	8
17	HIP-HOP 17	120	8
18	HIP-HOP 18	110	8
19	HIP-HOP 19	89	8
20	HOUSE 01	132	4
21	HOUSE 02	132	4
22	HOUSE 03	126	4
23	HOUSE 04	126	4
24	HOUSE 05	126	4
25	HOUSE 06	128	4
26	HOUSE 07	123	4
27	HOUSE 08	118	4
28	HOUSE 09	123	4
29	HOUSE 10	129	4
30	HOUSE 11	120	8
31	TECHNO 01	140	4
32	TECHNO 02	140	4
33	TECHNO 03	136	4
34	TECHNO 04	136	4
35	D&B 01	155	4
36	D&B 02	164	4
37	D&B 03	164	4
38	D&B 04	150	4
39	BigBeat 01	110	8
40	BigBeat 02	120	8

# MIDI Implementation

**Model:** SP-505  
**Date:** Aug. 10, 2001  
**Version:** 1.00

## 1. RECOGNIZED RECEIVE DATA

### ■ Channel Voice Message

#### ● Note On/Off

Receive the note on/off in the MIDI channel number which is designated with "Pads Channel" in the system parameter "SYSTEM/UTILITY/MIDI."

#### ○ Note On

<b>Status</b>	<b>Second</b>	<b>Third</b>
9nH	mmH	llH
9nH	mmH	01H - 7FH
n = MIDI Channel Number:		00H - 0FH (ch.1 - ch.16)
mm = Note Number:		00H - 7FH (0 - 127)
ll = Velocity:		01H - 7FH (1 - 127)

#### ○ Note Off

<b>Status</b>	<b>Second</b>	<b>Third</b>
8nH	mmH	llH
9nH	mmH	00H
n = MIDI Channel Number:		00H - 0FH (ch.1 - ch.16)
mm = Note Number:		00H - 7FH (0 - 127)
ll = Velocity:		00H - 7FH (0 - 127)

After reception of the Program Change (#1 - 12, #17 - 32), note numbers 23H - 33H (35 - 51) are received.

Pad Number	Note Number	
Pad EXT	35 (23H)	---
Pad 1	36 (24H)	GS TONE KICK 1
Pad 2	37 (25H)	GS TONE SIDE STICK
Pad 3	38 (26H)	GS TONE SNARE 1
Pad 4	39 (27H)	GS TONE HAND CLAP
Pad 5	40 (28H)	GS TONE SNARE 2
Pad 6	41 (29H)	GS TONE LOW TOM 2
Pad 7	42 (2AH)	GS TONE CLOSED HH
Pad 8	43 (2BH)	GS TONE LOW TOM 1
Pad 9	44 (2CH)	GS TONE PEDAL HH
Pad 10	45 (2DH)	GS TONE MID TOM 2
Pad 11	46 (2EH)	GS TONE OPEN HH
Pad 12	47 (2FH)	GS TONE MID TOM 1
Pad 13	48 (30H)	GS TONE HI TOM 2
Pad 14	49 (31H)	GS TONE CYMBAL
Pad 15	50 (32H)	GS TONE HI TOM 1
Pad 16	51 (33H)	GS TONE Ride Cymbal 1

After reception of the Program Change (#15, 16), note numbers 23H (35), 3CH - 483H (60 - 72) are received.

Pad Number	Note Number
Pad EXT	35 (23H)
Pad 1	-- (-H)
Pad 2	61 (3DH)
Pad 3	63 (3FH)
Pad 4	-- (-H)
Pad 5	66 (42H)
Pad 6	68 (44H)
Pad 7	70 (46H)
Pad 8	-- (-H)
Pad 9	60 (3CH)
Pad 10	62 (3EH)
Pad 11	64 (40H)
Pad 12	65 (41H)
Pad 13	67 (43H)
Pad 14	69 (45H)
Pad 15	71 (47H)
Pad 16	72 (48H)

After reception of the Program Change (#33 - 36), note numbers 00H - 7FH (0 - 127) are received.

#### ○ After reception of the Program Change #33

Pad Bank	Pad Number	Note Number
Bank 1	Pad 1	0 (00H)
:	:	:
Bank 8	Pad 16	127 (7FH)

#### ○ After reception of the Program Change #34

Bank	Pad	Note
Bank 9	Pad 1	0 (00H)
:	:	:
Bank 12	Pad 16	63 (3FH)
Bank 13	Pad 1	-- (-H)
:	:	:
Bank 14	Pad 16	-- (-H)
Bank 15	Pad 1	95 (5FH)
:	:	:
Bank 16	Pad 16	127 (7FH)

#### ○ After reception of the Program Change #35

Bank	Pad	Note
Bank 17	Pad 1	0 (00H)
:	:	:
Bank 24	Pad 16	127 (7FH)

#### ○ After reception of the Program Change #36

Bank	Pad	Note
Bank 25	Pad 1	0 (00H)
:	:	:
Bank 32	Pad 16	127 (7FH)

\* Not received if the PAD BANK is the CHOP BANK (#13, 14).

#### ● Program Change

Receive the message in the MIDI channel number which is designated with "Pads Channel" in the system parameter "SYSTEM/UTILITY/MIDI".

This message is received when the "Prog Chg SW" of the system parameter "SYSTEM / MIDI PARAMETER" is set at ON.

<b>Status</b>	<b>Second</b>	
CnH	ppH	
n = MIDI Channel Number:		00H - 0FH (ch.1 - ch.16)
pp = Program Number:		00H - 1FH (pad bank 1 - 12, 15 - 32) 20H - 23H (pad bank 1 - 32)

PC#	PAD BANK	PC#	PAD BANK	PC#	PAD BANK
1	PRESET BANK 1	17	CARD BANK 1	33	PRESET BANK 1
2	PRESET BANK 2	18	CARD BANK 2		USER BANK 4
3	PRESET BANK 3	19	CARD BANK 3	34	USER BANK 5
4	PRESET BANK 4	20	CARD BANK 4		PITCH BANK 2
5	USER BANK 1	21	CARD BANK 5	35	CARD BANK 1
6	USER BANK 2	22	CARD BANK 6		CARD BANK 8
7	USER BANK 3	23	CARD BANK 7	36	CARD BANK 9
8	USER BANK 4	24	CARD BANK 8		CARD BANK 16
9	USER BANK 5	25	CARD BANK 9		
10	USER BANK 6	26	CARD BANK 10		
11	USER BANK 7	27	CARD BANK 11		
12	USER BANK 8	28	CARD BANK 12		
--	---	29	CARD BANK 13		
--	---	30	CARD BANK 14		
15	PITCH BANK 1	31	CARD BANK 15		
16	PITCH BANK 2	32	CARD BANK 16		

# Chapter 15. Appendices

## ■ Channel Mode Message

### ● All Sound Off (Controller No.120)

Status	Second	Third
BnH	78H	00H

n = MIDI Channel Number: 00H - 0FH (ch.1 - ch.16)

\* All Current active voice in the specified channel will be shut off.

## ■ System Common Message

### ● Song Position Pointer

If the system parameter "SYSTEM/UTILITY/MIDI" setting "MIDI Sync Mode" is set to "MIDI/AUTO," Song Position Pointer messages are received when stopped.

Status	Second	Third
F2H	mmH	nnH

nn, mm = Song Position Point: 00H-00H - 7FH 7FH

### ● Song Select

Status	Second
F3H	ssH

ss = Song Number: 00H-13H (0-19)

## ■ System Realtime Message

### ● Timing Clock

This message is received when the "MIDI Sync Mode" of the system parameter "SYSTEM/UTILITY/MIDI" is set at "MIDI/AUTO".

Status
F8H

### ● Start

This message is received when the "MIDI Sync Mode" of the system parameter "SYSTEM/UTILITY/MIDI" is set at "MIDI/AUTO/REMOTE".

Status
FAH

### ● Continue

This message is received when the "MIDI Sync Mode" of the system parameter "SYSTEM/UTILITY/MIDI" is set at "MIDI/AUTO/REMOTE".

Status
FBH

### ● Stop

This message is received when the "MIDI Sync Mode" of the system parameter "SYSTEM/UTILITY/MIDI" is set at "MIDI/AUTO/REMOTE".

Status
FCH

### ● Active Sensing

Status
FEH

\* Whenever the SP-505 receives this message, it monitors the interval of the incoming data. If the subsequent message has not arrived within about 400 ms after the previous data it processes all tracks as though it has received All Sound Off, and mutes the sounding voices, then stops monitoring receiving interval.

## ■ System Exclusive Message

Status	Data Bytes	Status
F0H	11H, ddH, ..., eeH	F7H
Byte	Description	
F0H	Status of System Exclusive Message	
ddH	Data: 00H - 7FH (0 - 127)	
:	:	
eeH	Data	
F7H	EOX (End of System Exclusive Message)	

## ● Universal System Exclusive Message

### ○ INQUIRY MESSAGE

#### Identity Request

Status	Data Bytes	Status
F0H	7EH, 7FH, 06H, 01H	F7H
Byte	Description	
F0H	Status of System Exclusive Message	
7EH	Universal System Exclusive Message Non Realtime Header	
7FH	Broadcast	
06H	General Information (sub-ID #1)	
01H	Identity Request (sub-ID #2)	
F7H	EOX (End of System Exclusive Message)	

The message is used to request the particular information of the SP-505.

The SP-505 does not transmit the message.

If the SP-505 received the message, the SP-505 transmits the prescribed Identity Reply message.

## 2. TRANSMITTED DATA

### ■ Channel Voice Message

#### ● Note On/Off

Transmit the note on/off in the MIDI channel number which is designated with "Pads Channel" or "Part1-4 Channel" in the system parameter "SYSTEM/UTILITY/MIDI".

Status	Second	Third
9nH	mmH	11H
n = MIDI Channel Number: 00H - 0FH (ch.1 - ch.16)		
mm = Note Number: 23H - 48H (35 - 72)		
11 = Velocity: 01H - 7FH (1 - 127) / 00H = NOTE OFF		

Pad bank (#1) receive note numbers 23H (35).

Pad Number	Note Number
Pad EXT	35 (23H)

Pad banks (#1-12, #17-32) receive note numbers 23H-33H (35-51).

Pad Number	Note Number	
Pad 1	35 (24H)	GS TONE KICK 1
Pad 2	37 (25H)	GS TONE SIDE STICK
Pad 3	38 (26H)	GS TONE SNARE 1
Pad 4	39 (27H)	GS TONE HAND CLAP
Pad 5	40 (28H)	GS TONE SNARE 2
Pad 6	41 (29H)	GS TONE LOW TOM 2
Pad 7	42 (2AH)	GS TONE CLOSED HH
Pad 8	43 (2BH)	GS TONE LOW TOM 1
Pad 9	44 (2CH)	GS TONE PEDAL HH
Pad 10	45 (2DH)	GS TONE MID TOM 2
Pad 11	46 (2EH)	GS TONE OPEN HH
Pad 12	47 (2FH)	GS TONE MID TOM 1
Pad 13	48 (30H)	GS TONE HI TOM 2
Pad 14	49 (31H)	GS TONE CYMBAL
Pad 15	50 (32H)	GS TONE HI TOM 1
Pad 16	51 (33H)	GS TONE Ride Cymbal 1

If the Pad Bank is the PITCH BANK (#15, 16), note numbers 23H (35) and 3CH-48H (60-72) are transmitted.

Pad Number	Note Number
Pad 1	-- (-H)
Pad 2	61 (3DH)
Pad 3	63 (3FH)
Pad 4	-- (-H)
Pad 5	66 (42H)
Pad 6	68 (44H)
Pad 7	70 (46H)
Pad 8	-- (-H)
Pad 9	60 (3CH)
Pad 10	62 (3EH)
Pad 11	64 (40H)
Pad 12	65 (41H)
Pad 13	67 (43H)
Pad 14	69 (45H)
Pad 15	71 (47H)
Pad 16	72 (48H)

\* Not transmitted if the Pad Bank is the CHOP BANK (#13, 14).

### ● Program Change

Transmit the message in the MIDI channel number which is designated with "Pads Channel" or "Part1-4 Channel" in the system parameter "SYSTEM/UTILITY/MIDI". After the pad bank is switched, this is transmitted as a set together with note data.

This message is transmitted when the "Prog Chg SW" of the system parameter "SYSTEM/UTILITY/MIDI" is set at ON.

Status            Second  
CnH                ppH

n = MIDI Channel Number:            00H - 0FH (ch.1 - ch.16)  
pp = Program Number:                00H - 1FH (pad bank 1 - 12, 15 - 32)

PC#	PAD BANK	PC#	PAD BANK
1	PRESET BANK 1	17	CARD BANK 1
2	PRESET BANK 2	18	CARD BANK 2
3	PRESET BANK 3	19	CARD BANK 3
4	PRESET BANK 4	20	CARD BANK 4
5	USER BANK 1	21	CARD BANK 5
6	USER BANK 2	22	CARD BANK 6
7	USER BANK 3	23	CARD BANK 7
8	USER BANK 4	24	CARD BANK 8
9	USER BANK 5	25	CARD BANK 9
10	USER BANK 6	26	CARD BANK 10
11	USER BANK 7	27	CARD BANK 11
12	USER BANK 8	28	CARD BANK 12
—	—	29	CARD BANK 13
—	—	30	CARD BANK 14
15	PITCH BANK 1	31	CARD BANK 15
16	PITCH BANK 2	32	CARD BANK 16

### ■ System Common Message

This message is transmitted when the "MIDI Sync Mode" of the system parameter "SYSTEM/UTILITY/MIDI" is set at "INT/AUTO/REMOTE".

### ● Song Position Pointer

In Song mode, the current location is transmitted as a Song Position Pointer message when the song is stopped.

Status            Second            Third  
F2H                mmH                nnH

nn, mm = Song Position Point: 00H 00H - 7FH 7FH

### ● Song Select

Transmitted in one of the following operations:

When the Song mode has been selected.

When the song has been selected in the Song mode.

Status            Second  
F3H                ssH

ss = Song Number: 06H-13H (0-19)

### ■ System Realtime Message

This message is transmitted when the "MIDI Sync Mode" of the system parameter "SYSTEM/UTILITY/MIDI" is set at "INT/AUTO/REMOTE".

### ● Timing Clock

Status  
F8H

### ● Start

Status  
FAH

### ● Continue

Status  
FBH

### ● Stop

Status  
FCH

### ● Active Sensing

Status  
FEH

\* Always transmitted at intervals of approximately 250 ms.

### ■ System Exclusive Message

Status            Data Bytes            Status  
F0H                ffH, ddH, ..., eeH    F7H

Byte	Description
F0H	Status of System Exclusive Message
ddH	Data: 00H - 7FH (0 - 127)
:	:
eeH	Data
F7H	EOX (End of System Exclusive Message)

### ○ About Model ID

The SP-505 uses 00H 39H as a Model ID.

### ● Universal System Exclusive Message

#### ○ INQUIRY MESSAGE

#### Identity Reply

Status            Data Bytes            Status  
F0H                7EH, 10FH, 06H, 02H, 41H, 39H, 01H,    F7H  
00H, 00H, 00H, 02H, 00H, 00H

Byte	Description
F0H	Status of System Exclusive Message
7EH	Universal System Exclusive Message Non Realtime Header
10H	Device ID
06H	General Information (sub-ID #1)
02H	Identity Reply (sub-ID #2)
41H	Manufacturer ID (Roland)
39H 01H	Device Family Code (SP-505)
00H 00H	Device family No.
00H	
02H	
00H 00H	Software Revision Level
F7H	EOX (End of System Exclusive Message)

The above Identity Reply message is transmitted when an Identity Request is received.

# Chapter 15. Appendices

## 3. Messages stored in sequencer

### ■ Channel Voice Message

The following channel voice messages on the MIDI channel number specified by the system parameter "SYSTEM/UTILITY/MIDI" setting "Pads Channel" are stored.

#### ● Note On/Off

Status	Second	Third
9nH	mmH	lIH
n = MIDI Channel Number:		00H - 0FH (ch.1 - ch.16)
mm = Note Number:		23H - 33H (35 - 51) / 23H(35), 3CH - 48H (60 - 72)
lI = Velocity:		01H - 7FH (1 - 127) / 00H = NOTE OFF

For Pad Banks (#1-12, #17-32), note numbers 23H-33H (35-51) are stored.

Pad Number	Note Number	
Pad EXT	35 (23H)	—
Pad 1	36 (24H)	GS TONE KICK 1
Pad 2	37 (25H)	GS TONE SIDE STICK
Pad 3	38 (26H)	GS TONE SNARE 1
Pad 4	39 (27H)	GS TONE HAND CLAP
Pad 5	40 (28H)	GS TONE SNARE 2
Pad 6	41 (29H)	GS TONE LOW TOM 2
Pad 7	42 (2AH)	GS TONE CLOSED HH
Pad 8	43 (2BH)	GS TONE LOW TOM 1
Pad 9	44 (2CH)	GS TONE PEDAL HH
Pad 10	45 (2DH)	GS TONE MID TOM 2
Pad 11	46 (2EH)	GS TONE OPEN HH
Pad 12	47 (2FH)	GS TONE MID TOM 1
Pad 13	48 (30H)	GS TONE HI TOM 2
Pad 14	49 (31H)	GS TONE CYMBAL
Pad 15	50 (32H)	GS TONE HI TOM 1
Pad 16	51 (33H)	GS TONE Ride Cymbal 1

If the Pad Bank is the PITCH BANK (#15, 16), note numbers 23H (35) and 3CH-48H (60-72) are stored.

Pad Number	Note Number
Pad EXT	35 (23H)
Pad 1	— (-H)
Pad 2	61 (3DH)
Pad 3	63 (3FH)
Pad 4	— (-H)
Pad 5	66 (42H)
Pad 6	68 (44H)
Pad 7	70 (46H)
Pad 8	— (-H)
Pad 9	60 (3CH)
Pad 10	62 (2EH)
Pad 11	64 (40H)
Pad 12	65 (41H)
Pad 13	67 (43H)
Pad 14	69 (45H)
Pad 15	71 (47H)
Pad 16	72 (48H)

#### ● Program Change

Pad Bank changes are stored.

Status	Second	Third
CnH	ppH	
n = MIDI Channel Number:		00H - 0FH (ch.1 - ch.16)
pp = Program Number:		00H - 1FH (pad bank 1 - 12, 15 - 32)

\* The SP-505s sequencer stores performance data as packages consisting of Note On/Off data and Program Change data. It is not possible to store Program Change data by itself.

## 4. Supplementary material

### ● Decimal/Hexadecimal table

(hexadecimal values are indicated by a following H)

MIDI uses 7-bit hexadecimal values to indicate data values and the address and size of exclusive messages. The following table shows the correspondence between decimal and hexadecimal numbers.

D	H	D	H	D	H	D	H
0	00H	32	20H	64	40H	96	60H
1	01H	33	21H	65	41H	97	61H
2	02H	34	22H	66	42H	98	62H
3	03H	35	23H	67	43H	99	63H
4	04H	36	24H	68	44H	100	64H
5	05H	37	25H	69	45H	101	65H
6	06H	38	26H	70	46H	102	66H
7	07H	39	27H	71	47H	103	67H
8	08H	40	28H	72	48H	104	68H
9	09H	41	29H	73	49H	105	69H
10	0AH	42	2AH	74	4AH	106	6AH
11	0BH	43	2BH	75	4BH	107	6BH
12	0CH	44	2CH	76	4CH	108	6CH
13	0DH	45	2DH	77	4DH	109	6DH
14	0EH	46	2EH	78	4EH	110	6EH
15	0FH	47	2FH	79	4FH	111	6FH
16	10H	48	30H	80	50H	112	70H
17	11H	49	31H	81	51H	113	71H
18	12H	50	32H	82	52H	114	72H
19	13H	51	33H	83	53H	115	73H
20	14H	52	34H	84	54H	116	74H
21	15H	53	35H	85	55H	117	75H
22	16H	54	36H	86	56H	118	76H
23	17H	55	37H	87	57H	119	77H
24	18H	56	38H	88	58H	120	78H
25	19H	57	39H	89	59H	121	79H
26	1AH	58	3AH	90	5AH	122	7AH
27	1BH	59	3BH	91	5BH	123	7BH
28	1CH	60	3CH	92	5CH	124	7CH
29	1DH	61	3DH	93	5DH	125	7DH
30	1EH	62	3EH	94	5EH	126	7EH
31	1FH	63	3FH	95	5FH	127	7FH

D: decimal

H: hexadecimal

- Decimal expressions such as used for MIDI channel, Bank Select, and Program Change will be the value 1 greater than the decimal value given in the above table.
- Since each MIDI byte carries 7 significant data bits, each byte can express a maximum of 128 different values. Data for which higher resolution is required must be transmitted using two or more bytes. For example a value indicated as a two-byte value of aa bbH would have a value of  $aa \times 128 + bb$ .
- For a signed number (+/-), 00H = -64, 40H = +/-0, and 7FH = +63. I.e., the decimal equivalent will be 64 less than the decimal value given in the above table. For a two-byte signed number, 00 00H = -8192, 40 00H = +/-0, and 7F 7FH = +8191. For example the decimal expression of aa bbH would be  $aa \times 128 + bb - 40 \times 00H = (aa \times 128 + bb - 64) \times 128$ .
- Hexadecimal notation in two 4-bit units is used for data indicated as nibbled. The nibbled two-byte value of 0a 0b H would be  $a \times 16 + b$ .

#### <Example1>

What is the decimal equivalent of 5AH?

From the above table, 5AH = 90.

#### <Example2>

What is the decimal equivalent of the 7-bit hexadecimal values 12 34H?

From the above table, 12H = 18 and 34H = 52

Thus,  $18 \times 128 + 52 = 2356$

#### <Example3>

What is the decimal equivalent of the nibbled expression 0A 03 09 0DH?

From the above table, 0AH = 10, 03H = 3, 09H = 9, 0DH = 13

Thus, the result is  $((10 \times 16 + 3) \times 16 + 9) \times 16 + 13 = 41885$

#### <Example4>

What is the nibbled equivalent of the decimal number 1258?

```
16 ) 1258
   78 ... 10
16 ) 4 ... 14
   0 ... 4
```

From the above table, 0=00H, 4=04H, 14=0EH, 10=0AH

Thus the result is 00 04 0E 0AH

Groove Sampling Workstation

Date : Aug. 10, 2001

Model SP-505

**MIDI Implementation Chart**

Version : 1.00

Function...	Transmitted	Recognized	Remarks
Basic Channel : Default Changed	1-16 1-16	1-16 1-16	Memorized
Mode : Default Messages Altered	Mode 3 X *****	Mode 3 X X	
Note Number : True Voice	35-51, 60-72 *****	0-127 0-127	
Velocity : Note On Note Off	1-127 X 9n, v = 0	O X	
After Touch : Key's Channel's	X X	X X	
Pitch Bend	X	X	
Control Change	X	X	
Program Change : True Number	0-31 *1	0-35 *1	Switching Pad Banks
System Exclusive	O	O	
System Common : Song Position : Song Select	O *2 O *2	O *3 O *3	0-19
System Real Time : Clock : Commands	O *2 O *2	O *3 O *4	
Aux Messages : All Sound Off : Reset All Controllers : Local On/Off : All Notes Off : Active Sensing : System Reset	X X X X O X	O X X X O X	
Notes	*1 Transmitted only when MIDI: Prog Chg SW=ON *2 Not transmitted when MIDI: Sync Mode=MIDI *3 Not received when MIDI: Sync Mode=INT, REMOTE *4 Not received when MIDI: Sync Mode=INT		

Mode 1 : OMNI ON, POLY  
Mode 3 : OMNI OFF, POLY

Mode 2 : OMNI ON, MONO  
Mode 4 : OMNI OFF, MONO

O : Yes  
X : No

## Specifications

### SP-505: Groove Sampling Workstation

#### Maximum Polyphony

8 notes

#### Internal Memory

Samples: 250 (16 banks)

#### Expansion Card Memory

Samples: 256 (16 banks)

#### Maximum Sampling Time

Internal (times approximate)

STANDARD	LONG	LO-FI
2 minutes	5 minutes	17 minutes

Memory card (times approximate)

Capacity	STANDARD	LONG	LO-FI
8 MB	4 minutes	8 minutes	24 minutes
16 MB	8 minutes	16 minutes	49 minutes
32 MB	16 minutes	32 minutes	98 minutes
64 MB	32 minutes	64 minutes	197 minutes
128 MB	64 minutes	129 minutes	395 minutes

#### Sampling Frequency

STANDARD: 44.1 kHz

LONG: 22.05 kHz

LO-FI: 11.025 kHz

#### Data Format

SP-505 original format

#### Track Recording Methods

Event recording (Realtime/Microscope Edit)

Audio recording

#### Number of Recordable Events (pad operations)

Approximately 15,000 events

#### Signal Processing

AD conversion: 20 bit

DA conversion: 20 bit

#### Nominal Input Level

Input (line): -10 dBu

Input (mic): -55 to -25 dBu

#### Input Impedance

50 k  $\Omega$  (line)

2 k  $\Omega$  (mic)

#### Nominal Output Level

Output (line): -10 dBu

#### Output Impedance

2 k  $\Omega$

#### Display

128 x 64 pixels

Graphic LCD with backlight

#### Connectors

PHONES jack (Stereo 1/4 inch phone type)

MIC jack (1/4 inch phone type)

LINE OUT jacks L/R (RCA phono type)

LINE IN jacks L/R (RCA phono type)

DIGITAL IN connectors (optical/coaxial)

FOOT SW jack (1/4 inch phone type)

MIDI connectors (IN/OUT)

AC Adaptor jack (AC 14 V)

#### Power Supply

AC Adaptor (BRC series)

#### Current Draw

800 mA

#### Dimensions

298 (W) x 254 (D) x 64 (H) mm

11-3/4 (W) x 10 (D) x 2-9/16 (H) inches

#### Weight

1.4 kg / 3 lbs 2 oz (excluding AC Adaptor)

#### Accessories

AC Adaptor (BRC series)

Owner's Manual

Roland Service (information sheet)

#### Options

Foot Switch: FS-5U

\* 0 dBu = 0.775 Vrms



In the interest of product improvement, the specifications and/or appearance of this unit are subject to change without prior notice.



# Index

## A

Accent .....	61
Add .....	52
Auto .....	42

## B

Beat .....	45
BOTTOM .....	46
BPM .....	24–25, 33, 46, 55
BPM ADJUST .....	24, 33, 46
BPM SYNC .....	25

## C

Card bank .....	29
Card Cover .....	5
CHOP .....	26, 51
Chop bank .....	29
CLIPBOARD .....	49–50
CONFIG parameter .....	73
Copy .....	49–50, 65

## D

DEL .....	49
Delete .....	49, 52, 64–65, 69
Divide .....	26, 51
Dividing Point .....	51–53
DRUM .....	31

## E

Effect .....	19, 21, 34
EFFECTS CONTROL .....	35
End Point .....	31
Erase .....	59
Exchange .....	50
EXT SOURCE .....	32–33, 42–43

## F

FOOT SW .....	29, 73
Foot Switch .....	73
Format .....	66
FX ASSIGN .....	21, 34
FX INFO .....	35
FX ON/OFF .....	21, 35
FX SELECT .....	35

## G

GATE .....	31
------------	----

## H

HOLD .....	30
------------	----

## I

Initialtze .....	74
Insert .....	64

## L

L/R .....	16, 47–48
Level .....	44
Load .....	68–69
Loop .....	44
Loop Mode .....	31, 44

## M

Manual .....	43
Measure .....	45
Memory Card .....	66
Microscope editing .....	58–59
MIDI .....	71
Monaural sampling .....	39
Mute .....	57, 62

## N

Name .....	62, 64
Number of measure .....	45

## P

Pad .....	19
PAD ACCENT .....	30
PAD BANK .....	24–27, 30
Pad Bank .....	29
Pad Ch .....	71
Pad Number .....	60
Pad Play .....	31, 44
PAGE DOWN .....	16
PAGE UP .....	16
Panpot .....	44
Parameter List .....	16
PART .....	57, 59
Part .....	62
Part Ch .....	71
Pattern .....	20, 56–57, 67, 69
Pattern Recording .....	58
PHRASE .....	20, 45
Phrase Sample .....	20
PITCH .....	27, 54
Pitch bank .....	29
Play BPM .....	46
Play screen .....	18
Play Type .....	45
Position .....	44
Preset Pattern .....	18, 20, 56
Preset Sample .....	19, 29
Prog Chg SW .....	71

## R

Realtime recording .....	58
REC LEVEL .....	32, 41
RESAMPLE .....	42–43
Reverse .....	32, 45

## S

Sample .....	19, 29, 67–69
Sampler .....	19
SAMPLING .....	22, 40–43
Sampling .....	22, 39
Sampling Grade .....	39
Save .....	67
Sequencer .....	19, 67–69
Signature .....	45
SINGLE .....	20, 45
Single Sample .....	20
SmartMedia .....	66
Song .....	20, 55–56, 67, 69
Song recording .....	63

## Index

SOURCE SELECT .....	22, 32, 40
SP-303 .....	17, 29
Start Point .....	31
Stereo sampling .....	39
Sub-window .....	16
Swing .....	61
Sync Mode .....	71-72
SYNC SOURCE .....	34
Synchronize .....	25, 72
SYSTEM .....	65-74
<b>T</b>	
Tempo .....	24-25, 46, 55
TOP .....	46
TRIG .....	31
Trigger .....	31
Truncate .....	47
<b>U</b>	
User Pattern .....	18, 20, 56
User Sample .....	19
<b>V</b>	
Volume .....	44
<b>W</b>	
WAV/AIFF file .....	69-70
Wave .....	16, 19
WAVE EDIT .....	31-33, 44, 46-47
Wave Pointer .....	46-47
<b>Z</b>	
ZOOM IN .....	16, 47-48, 51
ZOOM OUT .....	16, 47-48, 51

For the U.K.

**IMPORTANT: THE WIRES IN THIS MAINS LEAD ARE COLOURED IN ACCORDANCE WITH THE FOLLOWING CODE.**

BLUE: NEUTRAL  
BROWN: LIVE

As the colours of the wires in the mains lead of this apparatus may not correspond with the coloured markings identifying the terminals in your plug, proceed as follows:  
The wire which is coloured BLUE must be connected to the terminal which is marked with the letter N or coloured BLACK.  
The wire which is coloured BROWN must be connected to the terminal which is marked with the letter L or coloured RED.  
Under no circumstances must either of the above wires be connected to the earth terminal of a three pin plug.

For EU Countries



This product complies with the requirements of European Directive 89/336/EEC.

For the USA

## FEDERAL COMMUNICATIONS COMMISSION RADIO FREQUENCY INTERFERENCE STATEMENT

This equipment has been tested and found to comply with the limits for a Class B digital device, pursuant to Part 15 of the FCC Rules. These limits are designed to provide reasonable protection against harmful interference in a residential installation. This equipment generates, uses, and can radiate radio frequency energy and, if not installed and used in accordance with the instructions, may cause harmful interference to radio communications. However, there is no guarantee that interference will not occur in a particular installation. If this equipment does cause harmful interference to radio or television reception, which can be determined by turning the equipment off and on, the user is encouraged to try to correct the interference by one or more of the following measures:

- Reorient or relocate the receiving antenna.
- Increase the separation between the equipment and receiver.
- Connect the equipment into an outlet on a circuit different from that to which the receiver is connected.
- Consult the dealer or an experienced radio/TV technician for help.

This device complies with Part 15 of the FCC Rules. Operation is subject to the following two conditions:

- (1) This device may not cause harmful interference, and
- (2) This device must accept any interference received, including interference that may cause undesired operation.

Unauthorized changes or modification to this system can void the users authority to operate this equipment.  
This equipment requires shielded interface cables in order to meet FCC class B Limit.

For Canada

## NOTICE

This Class B digital apparatus meets all requirements of the Canadian Interference-Causing Equipment Regulations.

## AVIS

Cet appareil numérique de la classe B respecte toutes les exigences du Règlement sur le matériel brouilleur du Canada.

 Roland®

11316

UPC 11316

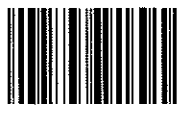

1.0961



 **BOSS**®  
BOSS Corporation

02670412 '01-10-B3-21N