

 Roland®

SH-09

Owner's Manual

The Roland SH-09 Synthesizer is a compact lead synthesizer designed to offer the musician uncompromised sound, performance flexibility and durability at a moderate price. The SH-09's exceptional quality combined with its unique live performance and interfacing features allow it to surpass the capabilities of many larger, more expensive synthesizers.

The VCO section features virtually rigid pitch stability in even the most difficult conditions and produces precise, rich waveforms including: Noise, Sawtooth, Square and variable Pulse Wave with both LFO and Envelope Modulation options. A Sub Oscillator produces any one of three parallel tones that may be mixed with the VCO at the internal Audio Mixer for thickness and extra flexibility without introducing tuning difficulties. Both the VCO and Sub Oscillator may be modulated by the LFO Modulator which includes Square Wave, Delayed Sine Wave or Sample and Hold options.

The VCF section of the SH-09 features the highest quality 24 dB/octave Low Pass Filter available for stability, flexibility and rich, deep tones. The extra flexibility is achieved through the SH-09's modulation options including: a positive or inverted envelope, an envelope follower for processing external instruments, three LFO modulation options, resonance control that may be pushed into self-oscillation for use as an extra sine wave oscillator, and control of the filter from the Bender section.

The VCA may control volume with the Envelope Generator, directly from the Keyboard Gate, or be fully opened with a Hold switch for added flexibility. This control is enhanced by the complete four slider ADSR Envelope Generator which may be activated by either the Keyboard Trigger and Gate, the Keyboard Gate alone, or by the LFO and the

Keyboard Gate together. These options combine with other control possibilities to make the SH-09 an exceptionally sensitive musical instrument.

The LFO Modulator control offers Sine Waves with or without delay, Square Waves, Sample & Hold and a separate Sine Wave without delay for the Pulse Width Modulation section. The LFO speed is fully adjustable and indicated by LED for precise, predictable control.

The SH-09 Bender section is the finest available. The center sprung lever returns to its origin automatically for quick, easy, musically secure playing. The Bender may control pitch through the VCO or tone through the VCF either separately or simultaneously with amounts preset by the performer for exact, predictable control of the synthesizer.

Interface options on the SH-09 include industry standard CV and Gate inputs and outputs for connection with Roland digital sequencers, other Roland synthesizers and with any other equipment offering 1 volt per octave Keyboard Control Voltage and positive voltage Keyboard Gate inputs and outputs.

Other instruments may be processed through the SH-09 using the self contained External Audio Input with the Envelope Follower contained in the VCF section.

The SH-09 is equipped with a ¼ inch phone jack output for connection with any conventional amplification and with a separate ¼ inch stereo phone jack connection for headphone monitoring through self-contained headphone amplifier. A connection cable is included with options for connection to either a ¼ inch phone jack socket or any female RCA jack socket.

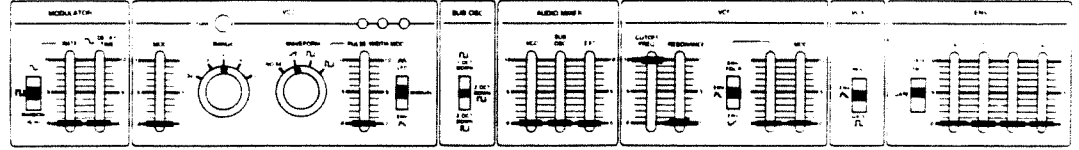

Front and Back Panel Layout

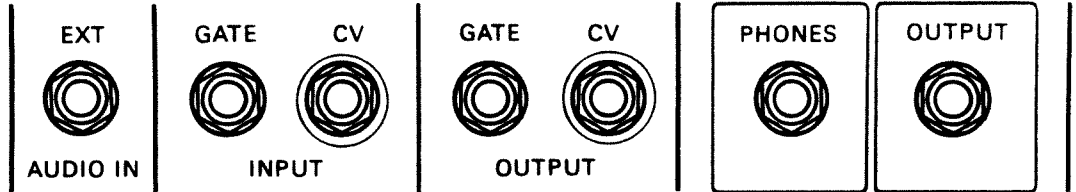
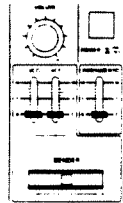

SYNTHESIZER 09 SH-09



Modulator Section The Modulator is a controller used for producing regular changes in pitch and tone in the VCO and VCF sections and for repeatedly triggering the Envelope generator. The Modulator is based on a Low Frequency Oscillator (LFO) producing waveforms with speeds ranging from 0.2 to 25 Hz. The Sample and Hold mode also produces random signals by sampling the output of the noise generator at a rate determined by the LFO.

Mode Switch This switch determines which waveform will be used for VCO and VCF modulation. The three options include:  (sine wave),  (square wave), and Random (S/H) for the Sample and Hold output.

Rate Control The Rate slider controls the frequency or speed of change for all Modulator outputs. Raising the control increases the frequency, which may be monitored with the associated flashing LED.

 **Delay Time Control** When this control is raised, pressing a key on the keyboard will delay the entry of the LFO sine wave to the VCO and VCF. Raising the control increases the delay time, and lowering it fully results in a continuous output with no delay.



VCO (Voltage Controlled Oscillator Section) The VCO is the basic sound source of the SH-09 and is responsible for the pitches produced and the basic tone color used.

Tune Control This small tuning knob controls the overall pitch of the SH-09. The tuning range is ± 65 cents.

Range Switch The rotary Range switch changes the VCO pitch in exact one octave steps from 2' to 32' for a total range change of four octaves.

MOD (Modulator) Control This slider changes the pitch of the VCO with the Modulator output, according to the Rate and Mode shape set in that section. Raising the slider increases the amount of change in pitch.

Control Voltage The SH-09 includes several VCO controls which are internally wired and do not appear on the VCO panel. The most important is the Keyboard control Voltage which permanently controls the VCO pitch in relation to the keys played. The VCO may also be controlled by the Bender section through the associated Bender Sensitivity control.



Waveform Switch	This rotary switch selects the VCO output waveform, providing a basis pure tone for the SH-09 to shape and process. The basic waveforms include Noise (a hiss including all frequencies, for various sound effects), Sawtooth wave (a rich tone for strings, brass and full synthesizer sounds), Square wave (a tone very similar to a clarinet or	xylophone), and Pulse Width Mod (a variable Pulse wave sounding from Square wave to very nasal in tone). The Pulse Width Mod. section includes a three position Mode switch including Manual, LFO and ENV modulation options, and a Pulse Width slider control to manually adjust Pulse Width or the amount of LFO or ENV modulation.
SUB OSC (Sub-Oscillator)	The Sub-Oscillator is actually a part of the VCO and produces any one of three parallel tones including a Square wave at one or two octaves below or a Pulse wave two octaves below the VCO. The Sub-Oscillator follows the VCO pitch in all particulars including LFO and Bender modulation.	
Audio Mixer Section	The Audio Mixer mixes the VCO, Sub-Oscillator and External Input signals in infinitely variable proportions before sending them on for processing.	
VCF (Voltage Controlled Filter Section)	The VCF is used to alter the tone of the Audio Mixer output by cutting or boosting harmonics in that sound. The tone may be altered manually or automatically through voltage control as a note is played. The VCF is a 24 dB/octave Low Pass filter which passes low frequencies and blocks high frequencies.	
Cutoff Frequency Control	The Cutoff Frequency Control determines how much of a tone will be filtered away by the VCF. In its highest position the sound will pass unchanged. As it is lowered the sound will become progres-	sively more mellow until it is filtered away to silence at its lowest position. This control acts as a starting position for all other control functions within the VCF section.
Resonance Control	This control emphasizes the frequencies at the point where the Cutoff Frequency begins to filter a sound. It is most often used to emphasize motion within the filter. At its lowest level it has no effect, increasing as the slider is raised until it begins to	self-oscillate near the top of the slider travel. In this position, the VCF becomes a separate sine wave audio oscillator which is controlled by all the Modulation controls within the VCF section.
Envelope Mode Switch	This three position switch determines the source of Envelope control for modulation of the VCF. In the  (positive Envelope) mode, the filter cutoff frequency will rise and fall following the shape of the Envelope. The tone will become brighter and then more mellow once each time the Envelope Generator is activated, providing the manual Cutoff Frequency control is lowered to make room for this sweep. In the  (Inverted Envelope) mode, the filter cutoff frequency will fall then rise again, following a mirror image of the Envelope pattern set. The tone	heard will begin bright, become more mellow, then more bright again. Beginning and ending tone is determined by the position of the VCF Cutoff slider. The ENV FOL'R (envelope follower) position will use the changing volume of any audio signal appearing at the EXT AUDIO IN jack on the back panel to modulate the VCF cutoff point in a positive direction. In this mode, the filter cutoff will rise and fall as the External Audio Input grows louder and softer, providing the manual Cutoff Frequency control is lowered to allow for this movement.

VCF Envelope Control This control determines the depth to which the Envelope Mode selected will modulate the VCF. With the slider at '0' there is no modulation, increasing gradually as the control is raised to full depth at '10'.

MOD (Modulator) Control This control allows the VCF cutoff to be controlled by the Modulator section output. The slider determines the depth of modulation whose shape and rate was selected in the Modulator section. Modulation increases as the slider control is raised, with no modulation when the control is lowered to '0'.

Control Voltage Inputs The SH-09 includes several VCF controls which are internally hardwired and do not appear on the VCF panel. The Keyboard Control Voltage is permanently fed to the VCF so that the tone may subtly follow the pitch, the way most acoustic instruments do. The VCF may also be controlled by the Bender section through the associated Bender Sensitivity control.

VCA (Voltage Controlled Amplifier Section) The VCA allows the SH-09 output loudness contour to be shaped automatically by a control voltage. There is no increase in volume in the VCA.

VCA Mode Switch The VCA may be switched between three control options. Setting the VCA in HOLD mode holds the VCA wide open so that any sound emerging from the VCF is passed directly to the SH-09 output jacks. The ENV  mode shapes the output volume with the Envelope Generator output. The GATE  mode shapes the output volume directly with the Keyboard Gate, fully '0' when a key is pressed, fully 'off' the next instant all keys are released.

ENV (Envelope Generator) The Envelope Generator produces a shaped control voltage that may be used to control the VCF cutoff frequency point and/or to control the VCA loudness contour.

Envelope Mode Switch The envelope Generator may be activated from the keyboard in three ways, depending on the position of the Envelope Mode Switch. In the Gate and Trigger mode, both the Keyboard Gate and Keyboard Trigger are used to activate the Envelope (this is sometimes referred to as a Multiple trigger). In the Gate mode, only a new Keyboard Gate will activate a new Envelope. The LFO mode activates a new Envelope each time the Modulator LFO begins a new cycle (as indicated by its LED indicator), within a Master Gate command from the keyboard. Specifics on these choices are given in the Operation section of this text.

Envelope Function Sliders The Envelope Generator is often referred to as an ADSR, a term made from the initial letters of the words Attack, Decay, Sustain and Release — the four slider functions within the Envelope Generator.

A (Attack Time)	The Attack slider controls the amount of time required for the Envelope voltage to reach its maximum level after a key is pressed. This Attack time is virtually instantaneous with the slider at '0' and lengthens as the slider is raised.
D (Decay Time)	The Decay slider controls the amount of time required for the voltage to fall from its level at the end of the Attack time to the level set by the Sustain control. Again, Decay time is virtually instantaneous with the slider at '0' and lengthens as the slider is raised.
S (Sustain Level)	This control determines the level to which the voltage will fall at the end of the Decay time. Once this level is reached it will be held until the key is released. A Sustain level of '0' will Decay to and hold at silence, effectively cancelling Sustain. A Sustain level of '10' will not Decay, but will remain at '10', effectively cancelling Decay. Sustain levels between these extremes combine with the various Decay times available to subtly shape notes as they are held.
R (Release Time)	This slider determines the amount of time required for the voltage to fall to minimum level after the release of the key. The Release will begin at any time within the Attack, Decay or Sustain sections of the Envelope as instructed from the keyboard.
Keyboard Control Functions	The keyboard of the SH-09 provides three control functions: the Keyboard Control Voltage, Keyboard Gate and Keyboard Trigger. These are internally hardwired, sometimes appearing as a selectable control and others providing a constant control function.
Keyboard Control Voltage (KCV)	The Keyboard Control Voltage is permanently wired to the VCO and VCF for precise control of pitch and tone in relation to the keys played on the keyboard.
Keyboard Gate	The Keyboard Gate is an on/off switching function used to signal the Modulator for Delayed sine wave output, as a preset Envelope choice for the VCA and/or to initiate Envelope events. Both the KCV and Keyboard Gate are available as inputs and outputs for interfacing on the back panel of the SH-09.
Keyboard Trigger	The Keyboard Trigger is a voltage spike appearing for an instant at the initial pressing of a key. It is used in conjunction with the Keyboard Gate to provide one of the control organs for initiating Envelope events.

Portamento Control The Portamento control determines the time required to change pitches when different keys are pressed. Set at '0', the keyboard will react with instant pitch changes. As the slider is raised, new keys pressed will slide from the last pitch to the new one, taking longer as the control is raised further.

Bender Section The Bender section allows the performer to change pitch and/or tone freely as he performs to add expression and vitality to the sound.

Bender The Bender lever is center-sprung to return to its original setting reliably after each bend for great speed and accuracy. The center position has no effect on the SH-09 sound or settings, while the left and right extremes of movement (– and +) achieve the same amount of bend in opposite directions.

VCO and VCF Bender Sensitivity Controls These two sliders control the exact amount of pitch and/or tone change at the extremes of the Bender travel. These may be set either separately or together to achieve the exact amount of sharp and flat pitch and/or brighter and more mellow tone change with exact predictability and control.

Volume Control The Volume Knob determines the final signal level present at the SH-09 Output jack for standard amplification and at the Headphone output jack for any stereo headphones.

Power On/Off Switch This push-on/push-off switch controls the flow of A.C. power to the SH-09. The power must be switched on for the SH-09 to perform any function. An LED status indicator is provided to allow a visual check of this function.

The Roland SH-09 synthesizer is an exceptionally flexible musical instrument capable of producing a broad range of sounds from gentle to brutally savage in character, over a wide pitch range. The SH-09 may be monitored through any conventional amplification, however individual musical needs should be considered in choosing an ideal amplification setup.

To maximize the SH-09's ultimate sound flexibility, ideal amplification will reproduce all of the synthesizer's sounds faithfully with a minimum of added distortion or coloration. A variety of quality P.A.'s, combo amps and component amplification systems will fill this need, but there are several special items to consider. Synthesizers are capable of producing sudden, high level output signals which may cause distortion in the pre-amplifier section of amps not built to handle them — such as many vocal P.A.'s. Also, avoid equipment or speakers chosen to color the sound to suit a particular instrument such as guitar. Finally, be sure that any effects, whether built-in or outboard, perform well in your particular setup and do not distort. An example of this would be the reverb units contained in many P.A.'s built for vocals that cannot handle synthesizers.

Consideration should also be given to an alternative approach, choosing amplification that will color the sound in a specific way to support a more specific, narrower range of sounds you may wish to pursue with your SH-09. If the SH-09 is primarily used to provide guitar-style lead lines, a guitar amp with its particular distortion and coloration circuitry and speaker choice may be an ideal choice. Likewise, an SH-09 to be used almost exclusively for bass lines could be played through a bass setup. Remember, this approach influences the sound considerably and at the same time limits certain styles while it supports others.

The SH-09 is provided with a connection cord terminating in a ¼ inch phone jack for connection to the synthesizer on one end and with an RCA connection with an adapter to ¼ inch phone jack for output connection at the other end. The ¼ inch phone jack adapter will be used for most amplification connections including combo amps and mixers.

The RCA jack offers access to most hi-fi component systems, a significant advantage when the SH-09 is used for practice at home without the inconvenience of transporting and setting up stage amplification. Connect the SH-09 to an AUX. input or TAPE input, avoiding a PHONO input with its special internal equalization. The SH-09 will appear at one speaker only, unless a 'Y' cable or junction box such as the Roland J-5 is used. **IMPORTANT NOTE:** begin with the volume level on your SH-09 at Zero, and the hi-fi at normal or lower than normal levels. By gradually raising the SH-09 level and using caution as you change patches you can easily avoid high level sounds that might otherwise damage sensitive hi-fi equipment.

The SH-09 provides self-contained headphone amplification for any conventional stereo headphones through a ¼ inch stereo phone jack on the back panel. This is not only convenient when practicing, but allows for fine adjustments to be made to critical patches while on stage. To do this, simply turn the SH-09 output off at the mixer or amplifier input volume control and monitor through headphones during breaks in playing. Return the amplification to normal settings when you are finished making your adjustments.

Other rear panel connections on the SH-09 include an External Audio Input to allow interfacing with other instruments by using the Envelope Follower included in the SH-09, or to allow interfacing with instruments equipped with a positive voltage Gate Output such as the Roland RS-09 Organ Strings or the SA-09 Saturn.

Control Voltage and Gate Inputs and Outputs are provided to allow interfacing with other synthesizers such as the Roland SH-2 or Jupiter-8 or for connection to the Roland CSQ series computer sequencers. These applications are detailed in the Interfacing section of this manual. All interface connections follow the industry standard one volt per octave Keyboard Control Voltage and positive voltage Keyboard Gate to allow for connection to all other major brands, giving the SH-09 the maximum amount of flexibility and potential for growth and innovation.

Blank Interfacing

The easiest way to get familiar with the SH-09 is to systematically explore the controls and their effect on the sound itself. Once the basic exploration is completed, combinations of these controls will be used to piece the information gained into a practical, useful whole.

Connect the SH-09 to suitable amplification and begin your examination with the following settings:

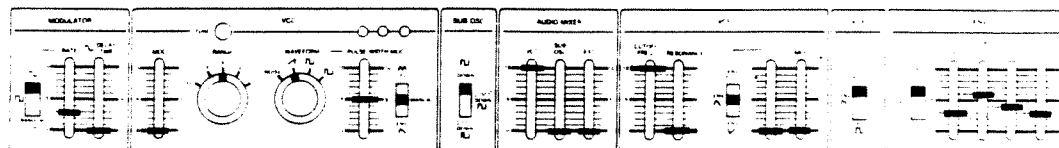

SYNTHESIZER 09 SH-09

Roland



Set the Volume control at Zero, then gradually increase it to a comfortable level. After exploring each control, return it to this basic setting (patch) to assist the rest of your initial examination.

Voltage Controlled Oscillator

The Voltage Controlled Oscillator is the primary sound source of your synthesizer, where the basic pitch range and tone color of your sound must be chosen. The Voltage Controlled Oscillator is the second major section along the top of the SH-09, labelled VCO.

Pitch Control

The pitch you are hearing may be switched up or down manually in single octave increments with the Range selector. The pitch is also automatically controlled by the keyboard — include pressing both extremes of the keyboard with each of the various range selections to get an aural picture of how the SH-09 keyboard can fit into many different instrumental ranges easily and accurately. It is helpful to understand that nearly all instruments have a useful range that falls within a single keyboard length of the SH-09, and by selecting that range thoughtfully your imitations will be more

authentic and your new creations more believable than if those ranges were exceeded. Figure 1 will assist in relating the SH-09 keyboard and range options to other musical references.

The SH-09 is a solo instrument — as are the vast majority of other musical instruments. It will play only one note at a time and its keyboard operates accordingly. The SH-09 keyboard has low note priority — if more than one note is played, the bottom one will be sounded by the VCO. More details on how to make maximum advantage of the SH-09 keyboard will follow.

Keyboard Voltage

The keyboard produces a control voltage which corresponds to the key pressed. This control voltage is most often used to control a VCO so that it produces the pitch related to the key pressed.

The SH-09 uses the relation of 1 volt/1 octave (one volt per octave) which means that a one volt change in the control voltage will produce a one

octave change in pitch.

This relation is very common and is used on most synthesizers and related equipment, including professional studio equipment as, well as stage type equipment. This means that the SH-09 is compatible with most equipment used in all forms of electronics music.

INSTRUMENT RANGES AT CONCERT PITCH

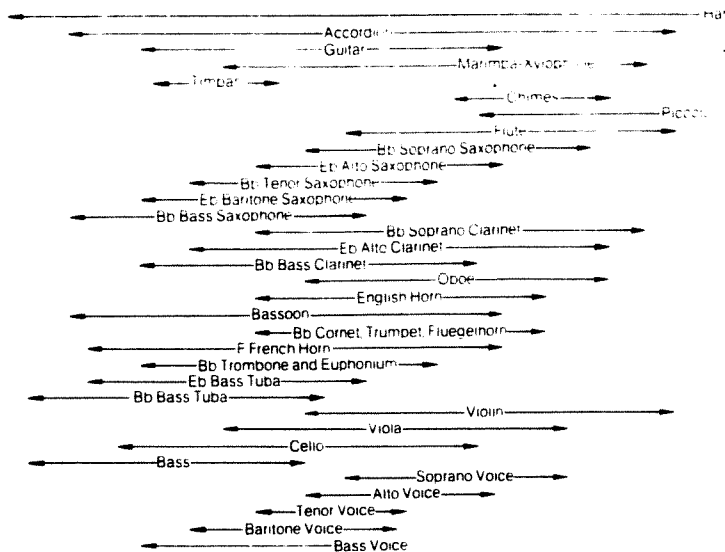

WRITTEN CONCERT PITCH

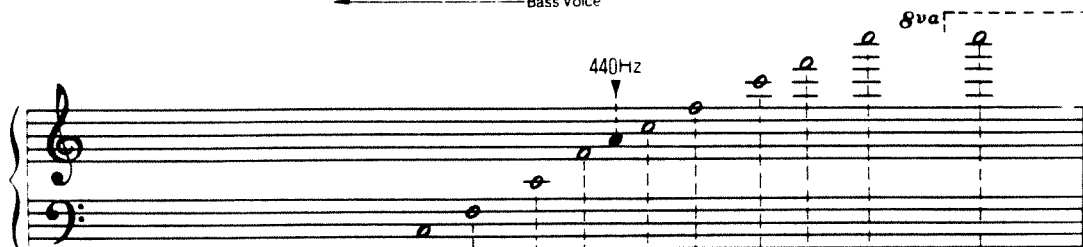

SOUNDING RANGES OF SH-09 KEYBOARD

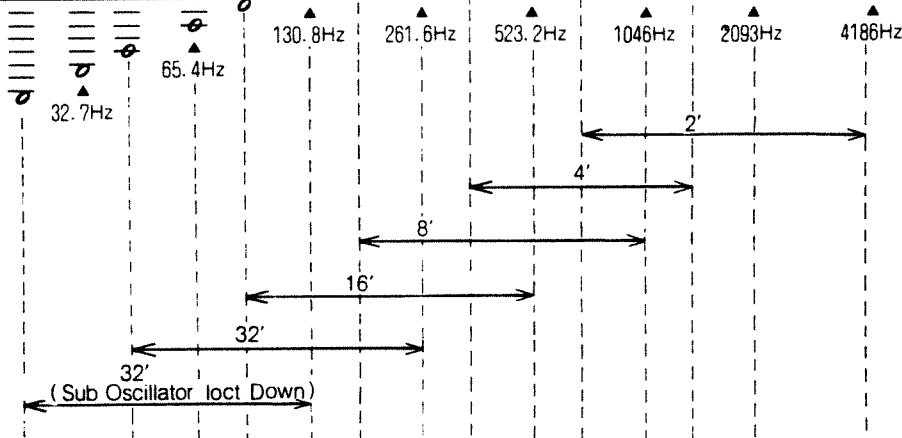

88 KEY PIANO KEYBOARD

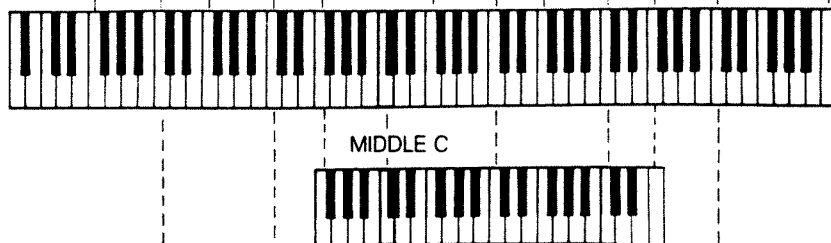

The SH-09 may be fine tuned to any reference by using the small black Tune knob located directly above the Range control in the VCO section. This control is made inconspicuous to avoid throwing out the tuning during a session by grasping the incorrect knob. The SH-09 oscillator is so stable that once it is warmed up for approximately 15 minutes and then tuned, it should remain in perfect tune for the rest of the session regardless of use or outside influence such as the heat generated by stage lighting. You may find the SH-09 is so stable that it often won't need re-tuning at the beginning of a new session.

To tune the SH-09 begin with the setting used here or something similar that will give a long, steady

note. Strike the key for the note you wish to match to another instrument or to a tuner, then match pitches by adjusting the Tune knob.

The pitch being produced by the VCO may be changed automatically by applying the MOD (Modulation) slider within the VCO section. This introduces regular, recurring fluctuations in pitch relating to the shape and speed set in the Modulator section. For now, just use the MOD slider within the VCO for its most common function, vibrato, and as you experiment remember that this slider influences the depth of the pitch change only, not its speed or shape. This is an application of a control, not the control itself. The Modulator control will be covered separately.

Basic Tone Selection

The VCO section's role as a sound source gives control over both the pitch of a note and its basic tone, a tone that may later be modified in other sections. The Waveform selector within the VCO provides us a variety of very distinct, precise tone colors from which to choose. Dial through them as they are discussed.

The Noise waveform is basically a hiss, which may be altered many ways for use in various sounds or effects such as wind, surf or steam locomotive. The second waveform/tone option is the Sawtooth wave, commonly used for string, brass, and rich synthesizer sounds. The third option is the Square wave, very near to the sound of a clarinet or xylophone.

The fourth position labeled Pulse Width Mod. actually provides a variety of tone colors. With its special selector in the Manual position, and the accompanying slider set at '0', you begin with a Square wave. Gradually raising this control up to '10' takes the waveform through a continuously narrowing Pulse Wave, sounding progressively more nasal.

Moving the three position Pulse Width Modulation selector from Manual to either LFO or ENV (Envelope) obtains a tone which is actually in motion within the spectrum of change heard while moving the slider in the Manual mode. Here is a

Voltage Controlled Waveform, beginning with a Square wave and moving automatically through to a narrower, more nasal Pulse Wave and back again.

The LFO position gives a continuously sweeping, smooth tone change pivoting from the basic Square wave. With the accompanying slider at '0', there is no Pulse Width Modulation, no tone change. As the slider is raised, the tone varies correspondingly further away as it swings away from the square wave to the extreme limit set by the slider and back again in a repeated pattern. The speed of modulation is set in the Modulator section, with a fixed smooth Sine wave motion — only the depth of the application is set here. This yields a thickening of the sound, and at a suitable speed and depth is very similar to having a phase effect unit within the synthesizer.

The ENV position gives a single, shaped change in tone moving away from and returning to the Square wave position once each time a key is pressed. The shape and length of this change is determined by the ADSR setting, and how the ADSR itself is manipulated by the keyboard. The slider within the Pulse Width Modulation section determines only how far the Envelope voltage will change the tone from its basic Square wave position. See the Application section for direct examples of Pulse Width Modulation.

Sub-Oscillator and Audio Mixer

The basic setting has already routed the sound from its origin within the VCO through the Audio Mixer by raising the Mixer's VCO slider. The adjacent slider pot mixes in the output of the Sub-Oscillator, located between the VCO and the Audio Mixer on the SH-09 front panel.

The Sub-Oscillator is actually a slave of the VCO, generating another pitch in parallel to the original. Three sound options are available: a square wave tone one or two octaves below, or a fixed pulse wave tone two octaves below whatever pitch is selected within the VCO. By mixing the original VCO output and the selected Sub Oscillator output in various proportions within the Audio Mixer, many new possibilities for thick, rich sound are available with no turning problems between the two sound

sources.

By combining the 'Sub Osc Square Wave 1 Oct Down' with the original VCO sound within the Audio Mixer, it is possible to produce sounds that gain in weight and richness without obviously containing two distinctly separate notes. The Shuffle Bass patch presented later illustrates this point clearly.

Mixing in the square or pulse wave tones 2 octaves down may produce either a single tone sound such as that of a vibraphone or a tone with two distinct notes for heavier synthesizer sounds. Pause here and experiment with mixing the various VCO ranges and waveforms in differing proportions with the three Sub Oscillator options at the Audio Mixer.

The Audio Mixer also contains a slider controlling the amount of input accepted from any electronic instrument signal inserted into the External Audio In jack on the back panel of the SH-09. The SH-09

may be used in several different ways to process external instruments (in contrast to processing its own VCO signal), and these are discussed in this manual's Interfacing section.

Voltage Controlled Filter

The basic VCO sound now passes automatically from the Audio Mixer on through the Voltage Controlled Filter (VCF). Here the tone resulting from choices made within the VCO and Audio Mixer may be finely adjusted and manipulated.

The basic patch passes the VCO sound directly through the VCF unchanged, opened by raising the Cutoff Frequency slider fully. An understanding of the effect of the filter Cutoff is basic to an understanding of the entire VCF section.

The SH-09 VCF is a high quality Low Pass Filter. With the Filter Cutoff slider set at '10', it has no effect on the sound. As this slider is lowered, the tone becomes progressively more mellow as the higher parts of the tone are removed, becoming a pure sine tone just before it is filtered away to silence. Lower and raise this slider at different speeds using each basic waveform from the VCO to obtain an aural picture of the various colors available and also of the effect of motion within the filter.

Motion within the filter, changing the tone during musical notes, is critical to many synthesizer sounds. Some synthesized sounds are based on a 'passive' filter, a fixed Cutoff Frequency setting with no motion or change in tone. Others depend on the tone changing 'actively' during the length of each note, either a repeating change controlled by the LFO Modulator or a single sweep initiated by the Envelope control. The most basic demonstration would be to compare the basic brass and string patches presented in this manual's section on Patches. The prime difference between these two sounds is the 'passive' filter of the string patch as contrasted to the 'active' filter of the brass patch.

Move the Cutoff Frequency slider to '10' while its selector is in the middle, ENV (positive envelope), position. Press any key and the note will change both in volume and tone according to the shape set in the ENV section of our basic patch, getting brighter and louder, then more mellow and soft. The volume level follows the tone just as it did when the slider was manually moved. This experiment moves the filter exactly the way it could be done manually, but with more potential speed, precision and ease through automatic control. Repeat this procedure with different waveforms and different amounts of VCF Envelope Control.

Return the Cutoff Frequency slider to '10', move the selector to ENV (inverted envelope) and move the VCF Envelope Control to '6'. Your effect is now reversed, closing the filter rather than opening it, moving this time from bright and loud to mellow and less loud and back again each time a key is pressed. This inverted envelope is very useful in creating plucked or strong, punching synthesizer sounds with lots of dynamic motion. Experiment here with different waveforms and

different Cutoff Frequency starting points and amounts of Envelope Modulation. Patches are given later for specific applications of this feature.

The ENV FOL'R position on the three position VCF Envelope Mode Selector uses the natural shape of notes introduced at the External Audio In to move the filter, allowing instruments such as electric piano or electric guitar with no Gate Voltage outputs to drive the SH-09. Specifics on this procedure are given in the Interfacing section of this manual.

The MOD slider within the VCF section allows you to change the tone of your note with the IFO Modulator. Begin with your basic patch, lower the Cutoff Frequency slightly to '7', and gradually raise the MOD slider. You will hear a tone/volume tremolo (the speed and shape are determined again in the Modulator section), the depth of tremolo varying with the MOD slider position. It is useful to note here that the tremolo is smoothly, alternately both raising and lowering the Cutoff Frequency (for brighter and more mellow tone, respectively). For this reason the Cutoff Frequency slider has been lowered slightly to make room for both actions. If the Cutoff Frequency slider was in either extreme position, any tremolo would lose its smoothness as only half of its cycle could have any influence on what is heard. Experiment with this now and later check the Vibraphone patch for a specific example.

The Resonance slider in the VCF section emphasizes the tone at the precise edge of the Cutoff Frequency. Place the Cutoff Frequency slider at any point that allows a tone to pass, then add anywhere from '0' to '6' of the Resonance slider and you will hear a slight difference in tone. Leave the Resonance slider at '6' and move the Cutoff Frequency slider. Resonance emphasizes the edge of the Cutoff and when it is moved the motion is emphasized. The prime use of Resonance is to emphasize tone in motion, such as the twang of the bass guitar in the Shuffle Bass patch given later in this manual. You may wish to leave the Resonance slider at '6' or less and repeat the experiments with Envelope or LFO Modulation of the VCF to learn how these automatic changes in tone are emphasized using Resonance.

Once that is completed, push the Resonance slider fully to '10', and again move the Cutoff Frequency slider. You will now hear an extra pitch in addition to that produced by the VCO, one whose pitch is determined by the VCF Cutoff point. Silence the VCO at the Audio Mixer and experiment with various kinds of modulation using the Resonance as an extra oscillator — all functions which altered the tone using the VCF will now move the pitch of the VCF produced note in the same manner. This use of the Resonance as an extra oscillator may be

put to excellent use in patches such as the Tonewheel Organ or the Synth Drum, given later.

During this exercise with Resonance, you may notice that its note will roughly follow the keyboard. This is an indication that the SH-09 Keyboard Control Voltage that the VCO pitch follows is also alter-

ing the tone slightly as you play, brighter for higher notes, more mellow for lower notes. This allows your patches to follow the keyboard for changes in tone following changes in register or pitch just the way most acoustic instruments do, giving added realism and sensitivity to your synthesizer sound.

Voltage Controlled Amplifier

Your sound has originated in the VCO, passed through the Audio Mixer and the Voltage Controlled Filter, and will now pass through the Voltage Controlled Amplifier on its way to the SH-09 output jacks for external amplification and/or headphone monitoring.

The Voltage Controlled Amplifier (VCA) does not actually amplify the sound, but controls the shape of the Volume. Three VCA control options are offered: Hold, Envelope control and Keyboard Gate control.

The Hold position opens the VCA fully, allowing any sound leaving the VCF to pass unchanged

through to the various outputs. As long as a sound is present in the VCF and the filter cutoff is high enough to let that sound pass, the VCA Hold will present a continuous sound at the outputs. This is particularly helpful for continuous sounds such as wind, surf, certain Sample & Hold applications, processing external instruments and for ease in tuning.

The Envelope and Gate options for VCA control allow notes to start and end in silence and be shaped by a preset Gate or adjustable Envelope, both initiated in some way by the keyboard. These options will be detailed in the following Keyboard and Envelope sections.

Keyboard Functions

The keyboard of the SH-09 produces no sound of its own, and functions only to control other sections of the synthesizer. The SH-09 produces three distinct Keyboard Controls, the Keyboard Control Voltage, Keyboard Gates and Keyboard Triggers.

Keyboard Control Voltage

The SH-09 keyboard continuously produces a Keyboard Control Voltage that corresponds directly to the keys played on the keyboard. You have already used the Keyboard Control Voltage (KCV) to automatically control the VCO and Sub-Oscillator pitches from the keyboard. The same KCV is permanently routed to control the VCF cutoff frequency, adjusting the tone brighter for high pitched notes and more mellow for notes pitched lower just as other instruments change tone as they change range or register. This KVC control of the VCF cutoff was illustrated by controlling the pitch of the VCF when it was in self-oscillation.

As mentioned previously, the SH-09 is a solo instrument — as are the vast majority of other musical instruments. Only one note at a time may be produced and the keyboard accordingly produces only one KCV at a time. The SH-09 keyboard has low note priority — if more than one note is played at a time, the bottom one will be

sounded. In legato playing where the playing of keys overlaps, new keys depressed to the left will change the pitch while new keys at the right will not change the pitch until any keys to its left are released.

The Roland SH-09s Keyboard Control Voltage references to a linear one volt per octave, producing exactly one more volt for each octave higher played on the keyboard. Keyboard Control Voltage input and output jacks are available on the SH-09 back panel to allow interfacing with other compatible instruments and equipment such as the Roland CSQ series digital sequencers. Roland features the most comprehensive interfacing alternatives available, some of which are detailed in the Interfacing section of this manual. The linear one volt per octave KCV is an industry standard and is compatible with most other major brands for the ultimate in flexibility and expansion for your SH-09.

Keyboard Gate

Each key on the SH-09 keyboard can produce an on/off signal called a Keyboard Gate. The Keyboard Gate (KG) is a voltage that remains at zero until any key is pressed, jumping instantly to a steady voltage zero again. Legato playing will result in one long gate beginning with the first note played and ending the first moment that no keys are depressed.

Switch the VCA from Hold to the Gate position and familiarize yourself with the low note priority logic for the KCV and with the Keyboard Gate. Pay particular attention to detached and legato playing, these will have a significant influence on your sound.

Keyboard Trigger

Each time a key is depressed on the SH-09, an impulse signal is produced called a Keyboard Trigger. The Trigger is actually a voltage spike that ends virtually the instant it is begun, no matter how long you hold a key. The Keyboard Triggers follow low note priority logic the same way the KCV does — in legato playing, new keys depressed to the left will introduce a new trigger while new keys at the right will not trigger until any keys to its left are released.

The Keyboard Trigger is used only in conjunction with the Keyboard Gate to activate the SH-09 Envelope. To use the Gate and Trigger combination, switch the VCA to Envelope control. Notes now played will have a distinctly different shape than the simple on/off of the Gate position, and legato playing will yield a renewed attack for each note within the logic described above. This technique will be described in more detail in the following Envelope section and in the Application section later in this manual.

Envelope Generator

An Envelope is a control that produces a shaped voltage once each time it is activated, a voltage that is normally used to produce a change in volume, tone, and/or pitch once each time a key is struck. The SH-09 uses a complete four section ADSR Envelope that may be activated three different ways, important features that help make the SH-09 the flexible, sensitive synthesizer that it is.

The Envelope is often referred to as an ADSR, a term made from the initial letters of the words Attack, Decay, Sustain and Release — the four slider functions within the Envelope. Leave the VCA in the Envelope position, lower the ADSR sliders to '0', and experiment with pressing a single key for

short and long notes as you proceed through the Envelope section. (In this application the ADSR is responsible for the shape of the volume of the note only, and all descriptions will fit this frame of reference.)

With all four Envelope sliders at '0', you will hear a 'click' as you press a key — the sound of the Envelope acting too quickly for a note to be heard. This click is also heard at the beginning of any notes with an Attack of '0', and is essential to sound such as Vibes or Guitar where the impact of the mallet or the plucking of the string is actually a part of the sound. Examples of this may be found in the Application and Patch sections of this manual.

ATTACK

The Attack slider controls the time needed for the beginning of a note to grow from silence to full volume. The Attack functions from the instant a key is depressed until the note reaches full volume or the key is released. Move the Attack slider to '10' and hold any key down — the sound will build gradually from silence to full volume, cutting instantly back to silence the moment that full volume is reached. If you pick up the key before the Attack has reached full volume, it will end at that point. This allows you to control volume, phrasing, bow-

ing, etc. from the keyboard for any notes with a gradual attack such as strings or brass. Experiment with this principle and check the Application section for more specifics.

Lower the Attack slider to '5' and notice that the note reaches full volume much faster. Experiment with various Attack speeds and note lengths, noticing that the Attack setting does not directly alter the volume of any note — just the amount of time needed to reach the maximum.

Decay

The Decay slider controls the time needed for a note to diminish from full volume at the end of the Attack to silence or the level set by the Sustain function. Move the Attack slider to '0', raise the Decay slider to '10', and play a long note. The note will begin at full volume instantly as dictated by the Attack slider, then fade smoothly, gradually to

silence as long as your finger is held on the key. The Decay is once again only responsible for the note until the key is released, and raising all keys before the Decay is complete will again end in abrupt silence with our settings. Experiment with various combinations of Attack and Decay lengths, ending with settings of '3' for each.

Sustain

The Sustain slider has already been referred to in the Decay section, and is not a time function but the level to which the Decay will fall while any key is still held down. With the Sustain at '0', any Attack/Decay combination will end in silence no matter how long a key is held. With the Sustain level set at '10', a note will stay at full volume from the instant the Attack is complete until the key is released — virtually cancelling the Decay function and giving the note no 'internal' change in shape during its length.

By using different combinations of the Attack and Decay lengths and Sustain level, sophisticated shaped notes are possible such as the extra emphasis at the beginning of a string down bow, held brass notes, or the burst at the beginning of percussive instrument notes such as piano. See the Application and Patch sections for specific uses of the Sustain function.

Release

The Release slider control is responsible for the note from the instant the key is released — taking over from the Attack, Decay and Sustain which end at the point, as we have seen. Leave the A, D & S all set at about '3' and set the Release at '10'.

Hold a note long enough so that the Attack and Decay are completed and your note is resting on the Sustain level. When the key is released the note will continue, gradually fading to silence. Repeat this procedure, lowering the Release time in several steps until you are down to the abrupt, instant Release at '0' that we experienced before.

Leave the Release slider at '2' or so for a pleasing, relatively short Release, set the Attack and Decay

sliders at '6' and experiment with short notes, interrupting the Attack and Decay cycles at various points. Here you will discover the full extent of the extra keyboard control mentioned at the end of the Attack description. Pressing and releasing a single key produces a Gate beginning and ending at those respective moments. The Release function will begin when the Gate ends — regardless of when it ends. The Release, then, will follow the Gate logic as described — in legato playing, the Gate will begin at the first note and end the first instant that all keys are raised. Practice with this principle and patches presented within this manual to play the SH-09's keyboard to a major advantage for added realism and control.

Envelope Modes

The SH-09 Envelope may be activated by the keyboard in three different ways, each with its own advantages. The Envelope Mode switch lets you choose between Gate and Trigger, Gate, and LFO options. Your SH-09 gives you this choice to give you the ultimate in flexibility and expression in all applications.

With the Envelope mode selector in the Gate & Trigger position, individual spaced notes will each have a complete envelope shape of its own. When legato playing is used (overlapping the playing of two or more keys) new notes will re-attack from whatever point they had reached in the notes they are interrupting. This principle follows the Trigger logic: new keys pressed on the left will re-attack while new keys to the right will not until any keys to the left are released. This type of playing allows very fast playing in which totally clean keyboard technique is not absolutely necessary, and is particularly useful for sounds with a quick attack and a relatively low sustain level. Check the Sustained Guitar patch give later for a typical example.

Placing the Envelope mode selector in the Gate position offers a second option. Individually spaced notes will each have a complete envelope shape. Legato playing will produce new pitches (according to the KCV logic described earlier), but the envelope will continue on as if it were one long note. In a patch such as the Shuffle Bass shown later, this allows you to produce the sound of re-fretting notes without re-plucking them. When you

place a clean break between notes they will re-attack. Legato playing will allow the series of notes to continue to fade. Practice using this technique will give good control and a sound with variety and interest — an area where most other synthesizers fall short.

Some sounds will need a detached keyboard technique to sound their best. In a string instrument patch, for instance, either the Gate or the Gate and Trigger positions played legato will lose the realism that would be generated by a fresh release and attack from detached playing. Also, in legato playing a 'click' will be heard as the notes switch instantly to new pitches. Experience will show you which of these two mode options to choose, but there is no substitute for developing a keyboard technique where light playing and at least a minimum separation between notes is possible.

The Envelope mode labelled LFO is controlled both from the Keyboard Gate and the Modulator LFO. When a key is depressed, the Keyboard Gate will allow the Modulator LFO to repeatedly activate the Envelope at the speed set by the Modulator Rate control, and indicated on the associated LED indicator. This repeating Envelope will continue as long as any key is held down, ending the instant that all keys are released according to the Keyboard Gate logic explained earlier. This mode is especially useful for instruments needing fast, continuous repeating notes such as the mandolin, banjo or marimba.

Control Options

The creative control of the SH-09 includes Portamento, LFO Modulator, and Bender section control options. These controls are simple to operate, yet add much to the expressive control of the synthesizer in performance. Return all controls to the basic patch and proceed to explore these controls.

Portamento

Portamento is a slide from one pitch to another, much as a trombone might. The Portamento control determines the time required to change pitches when different keys are pressed. The Portamento slider is found directly to the left of the keyboard, and is actually a function of the Keyboard Control Voltage and its control of pitch.



Set the slider at '0' and the keyboard will react to the keyboard with instant pitch changes. As the slider is raised, new keys pressed will slide from the last pitch to the new one, taking longer as the control is raised further. If you strike the same key

twice in a row, there will be no slide since Portamento works between the last note struck and the new one — in this case the same note.

Portamento stops when the key is released, and is best used in melodic situations with a quick slide that will allow the melody to sound clearly. Longer portamentos are best used carefully for single notes or for effects — experience is your best guide. Portamento may be introduced or changed at any time during performance, adding variety and interest.

Modulator Section

The Modulator control section is located at the upper left hand corner of the SH-09 control panel and is used for producing regular changes in pitch and tone such as vibrato, tremolo, trills and effects. The Modulator section includes a Low Frequency Oscillator (LFO) and a Sample & Hold circuit. The output of the Modulator can be used for modulating (changing) pitch through the VCO, tone by varying the Pulse Width in the VCO, tone and/or pitch within the VCF, and for repeated gating of the Envelope.

The Modulator Mode switch determines which waveform will be used for VCO and VCF modulation. The three options include:  (sine wave),  (square wave) and Random (S/H) for the Sample and Hold output.

The Rate slider controls the frequency or speed of change for all Modulator outputs. Raising the control increases the frequency, which may be monitored with the associated flashing LED.

Using the basic patch, experiment with the three Modulator Mode switch options at various rates by raising the VCO and VCF sliders singly and together in various amounts. The sine wave output will give smooth pitch or tone changes usually used for vibrato and tremolo. The square wave output gives steady, rhythmic up/down pitch and tone changes most commonly used for trills with the VCO.

The S/H output produces regular rhythmic changes in pitch or tone of a random depth. The S/H effect is a characteristic of synthesizers most often applied as VCF MOD with a generous amount of Resonance — this gives a pronounced effect without disrupting the identity of pitches being played. All three Modes have their shape and rate determined in the Modulator section, their application and depth determined with the VCO and VCF MOD sliders.

When the  Delay Time control slider is raised, pressing a key on the keyboard will delay the effect of the Modulator sine wave output on the VCO and VCF. This Delay follows Keyboard Trigger logic with separated notes having delay, while in legato playing new keys depressed to the left will introduce a new delay but a new key to the right will delay only as keys to the left are released. Raising this slider increases the delay time, lowering it fully results in a continuous output with no delay. You may wish to experiment with this function using different amounts of VCO and VCF Modulation and various delay lengths. Notice that the Delay control has no effect on the Square wave and Random S/H outputs of the Modulator.

The Modulator has a smooth, regular output which is internally wired into the Pulse Width Modulation section of the VCO as discussed earlier. This output is not effected by the Delay time control or the Modulator Mode switch. LFO Pulse Width Modulation usually uses an LFO rate between '0' and '3' and a moderate amount of Pulse Width Modulation depth. This depth is determined by the Pulse Width slider control and has noticeably more effect on low pitched notes than on high notes, so set your patches accordingly.

The LFO within the Modulator section may also be used for repeated gating of the Envelope section as described earlier. This output is hardwired to the Envelope Mode switch and only the Modulator Rate control and its associated LED indicator have any bearing upon it. It is useful to note that all Modulator section outputs including VCO and VCF modulation in all three modes, Pulse Width Modulation and repeated Envelope gating are all linked to the same LFO to allow coordination and control over those effects.

Bender Section

The Bender section allows you to change pitch and/or tone freely as you perform to add expression and spontaneity. The Bender lever itself is center-sprung to return to its original setting reliably after each bend for great speed and accuracy. The center position has no effect on the SH-09 sound or settings, while the left and right extremes of movement (labelled - and +) achieve the same amount of bend in opposite directions.

The effect of the Bender is determined by the VCO and VCF Bender Sensitivity slider controls. These may be set either separately or together to achieve the exact amount of sharp or flat pitch and/or brighter and more mellow tone change with exact predictability and control.

VCO bend will always change pitch. It is convenient to have the extreme limits of the bend control stop at the musical interval most useful to your patches, usually a half-step, stop or an octave. Using your basic patch for now, try this procedure to set the VCO bend easily and accurately: hold any note with your right hand, hold the Bender lightly at its most positive position with your left thumb, then slide the VCO Sensitivity control slowly upwards. You will hear the pitch of your note

rise—tune it to the desired interval above the note you began with. To check yourself, release the bender and press the note on the keyboard that you were aiming for. Check this against your original note with bender and repeat if necessary. You will find that you usually use the same bend for most patches and that the adjustable bender makes this possible with 100% accuracy.

The VCF Bender Sensitivity control will change the tone of the Audio Mixer output as it passes through the VCF. By combining VCO and VCF bend, a pitch bend becomes more dynamic by becoming brighter as it bends sharp, more mellow as it bends flat. Remember that if the VCF Cutoff is fully open either manually or through other controls that it cannot be bent in the positive, brighter direction. The same applies to the reverse—you can only bend the filter down to the extent that it is open.

It should also be noted that VCF bending will change the pitch of any notes produced by pushing the VCF Resonance into self-oscillation. The various uses of the Bender section are best practiced using patches presented later in this manual and by listening to examples in live performance or on record or tape.

You are now ready to piece the aural and technical information gained in the last section into a practical, useful whole. Two approaches are necessary to achieve the greatest success: an examination of the basic approach to learning/playing synthesizer, and a study of specific musical applications aimed at giving a mastery of synthesis in general and of the specific advantages of the SH-09 in particular.

Basic Patch Position

When pursuing any sound on a synthesizer, it is usually best to start from a standard basic position or patch, a setting which pre-supposes as little as possible by leaving control sliders closed and switches or sliders which are always active in the position most commonly used. This beginning point will avoid having remainders of the last patch confuse the building of the new one, and will lead to quick troubleshooting since you will be totally familiar with your starting point and each variation you have chosen to make. This approach will not

cramp your creativity by imposing decisions upon a sound that you have not specifically chosen.

Such a setting is presented here. As you become more familiar with the SH-09 and it becomes more of an extension of yourself, you may wish to modify this basic starting position or even eliminate it. For now, try returning to it each time you begin to patch—it will only take a moment and can save much frustration.

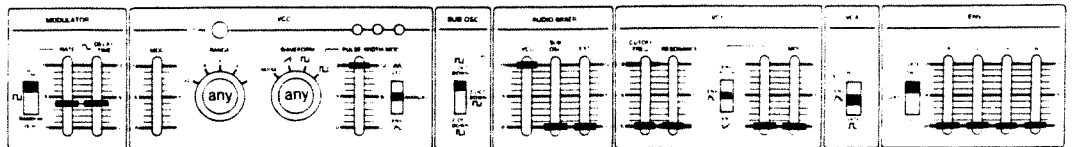

SYNTHESIZER 09 SH-09

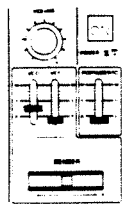

Methodical Practice

It is important to understand the musical uses of each SH-09 control in as many different situations as possible. Try each patch given in this manual, regardless of your personal musical preferences. Understand the main points of each, then spend time to adjust each control and discover the various options available.

This methodical approach has many advantages. Each musician has different personal preferences, is dealing with different amplification and acoustic environments, and not every SH-09 will react to the same patch in exactly the same way (just as other fine musical instruments all have their own individual character). You will develop variations on

each patch, or entirely new patches, which may be memorized or notated on a blank patch sheet for future reference. Most important, you will learn how to manipulate the SH-09 quickly and with real understanding.

The SH-09 has the simplicity, sound quality and subtle control options to allow you to achieve a new level of musical expression and freedom. With practice you will get to the point where the SH-09 becomes an extension of your musician ship, when you will instinctively know how to get a sound you hear or image, or how to alter a patch to suit your needs exactly.

Real-Time Patch Changes

To get the most musical vitality out of your SH-09, alter its sound while you are actually playing to add interest and remove predictability. Change the sound as you play by adding/removing/or altering Portamento. Change waveforms or envelope shapes. Discover useful variations of patches or different patches which are very close in settings and may evolve from one to the other as you play. The concept of 'evolving' one patch to another is

also useful for developing speed and accuracy for on-stage patching. You can find 'chains' of patches which require only simple changes to move from one to the next, yet give significant new sounds and a large change from the beginning of the chain to the end. Basic String to Brass to Tuba to Bass Guitar is a good example—changing VCF Cutoff and Envelope Mod, then Range and finally the ADSR settings through the chain and find adjusting other controls as you go

Custom Patches

Making your own patches to match a sound you have heard or are imaging is very rewarding, but often avoided as 'too difficult'. Many musicians just 'fiddle' until they get what they want or what they are willing to settle for, play patches out of books without tailoring them to suit, or play the same sound all the time. Mastering your own patches is not all that difficult—only requiring a certain amount of experience and practice, and a logical approach. A summary of one such approach is presented at the end of the Patches section of this manual. Work your way through the Patches given, try customizing them to your own needs, then try creating your own sounds and you will get the most out of the SH-09's vast potential.

There are several pitfalls or traps which are common with synthesists working on new patches. Awareness of them can eliminate several and minimize others.

Sounds created in your imagination present special problems. These totally abstract ideas are hard to hold on to, and tend to fade away or evolve into other ideas. Your mind has a tendency to accept your new patch as 'correct' when you know that it isn't—the idea you are trying to hold in your mind slips over and becomes the sound it hears. The only answers are concentration to hold the idea and speed to complete the patch while your idea is still clear in your mind. Set up basic parameters before you listen and work quickly to give your ear the least temptation be distracted and change.

Listen carefully to any sound you wish to copy. Do not be fooled by an emotional reaction to the effect of the sound, listen to the sound itself. A Violin may sound rich and sweet to a listener according to his emotional response, but the sound itself is very

bright, with a bit of a buzz in the tone color. Learn to analyse sounds quickly and accurately. Reference to a record or tape will help keep you on the right track and is good practice, but don't get too hung up with absolute precision—your audience won't be making side-by-side comparisons as you play.

No sound created by a synthesizer is actually complete until it reaches the ear of the listener. You must not only consider your own amplification, effects and room acoustics but listen for those same things in instruments or sounds you wish to imitate. Listen for reverb, phasing or flanging, wash pedals, or any other influences over a sound including specialised amplification such as over-driving a small amp to get a particularly hot lead sound.

Pay particular attention to reverb. Acoustic instruments are played in settings with varying amounts of natural reverberation—the time it takes a sound to die away to silence as it bounces around the room. This effectively extends the 'Release' time of those instruments. Many electric/electronic instrumentalists achieve this 'room' effect with a reverb unit within their amplification equipment or as an extra in their amplification chain. If you have no reverb available, your sound may seem flat and two dimensional. To compensate, add just a touch of extra Release length to your settings — this will simulate the extra 'ring' of room acoustics. Listen to sounds you wish to use on your synthesizer as they appear on records. Sounds like Strings are usually recorded in or simulate the sound of a large hall (lots of reverb), and many synthesizer sounds recorded by the great players use large amounts of reverb in the studio — your sound won't measure up to theirs unless you take reverb into account.

STYLE

One last but very important note: every patch is created with a certain musical or performance style in mind and will sound its best only when played in a similar style. A wind instrument patch will sound odd if you do not put rests in at regular intervals for the 'player' to 'breathe'. The listener may not know what is wrong, but often will sense the omission when he should be subconsciously appreciating the extra attention to detail. A lead

solo patch intended for lyric music lines with subtle pitch bending will sound entirely different if played in a ripping fast line with wild pitch bending. Copying other sounds and styles need not be negative or un-creative — many new styles are born from an understanding of previous work and borrow from others. If you admire a particular performer or sound, don't just go after the sound, you must study the style.

The patches presented in this section present both quick access to useful sounds from your SH-09 and a way to study specific applications of the principles and techniques discussed earlier. An approach to setting up your own patches is given at the end of this section, and blank patch sheets are supplied for you to photocopy and use to notate your own patches or any modified version of those presented here.

Set up the patches as marked, using the text given as a further guide. There are only two rules to follow in using these patches: all unmarked sliders should be left fully down, and any unmarked switches may remain in any position. To avoid confusion, return to the basic starting position each time you begin a new patch. That patch is repeated here for your convenience.

'Zipper' Lead (with Portamento)

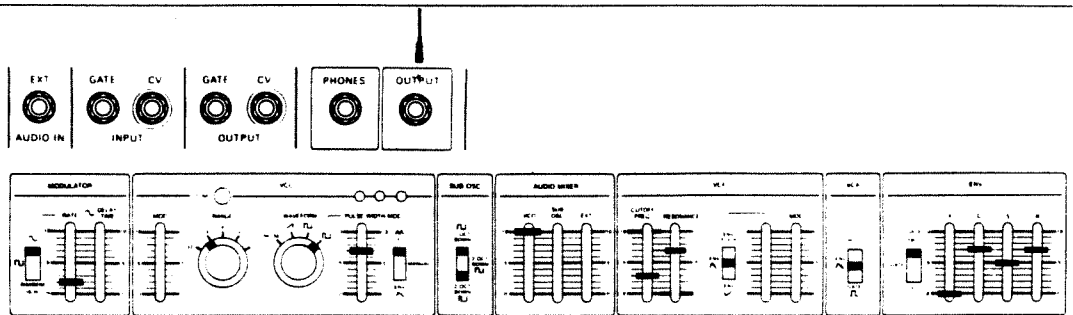

SYNTHESIZER 09 SH-09

Roland

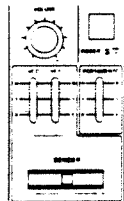

Thick synthesizer lead sound with long, resonant release.

Sub Oscillator is optional for a heavier sound.

Portamento should be set according to the speed of playing and the size of any jumps in the musical line. Keep Portamento fast enough to identify each note clearly.

Sustained Guitar

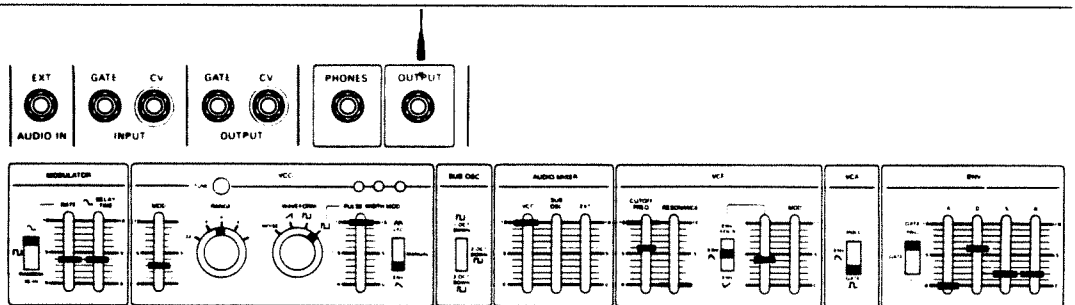

SYNTHESIZER 09 SH-09

Roland

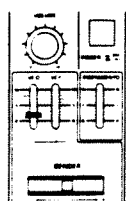

Increase the volume during long sustains using a volume pedal between the output and amplification, or by adjusting the SH-09 volume knob with your left hand.

Pitch bend a whole or half step, as a guitarist would. Put at least a short space before notes bent flat.

Lead Line in Motion

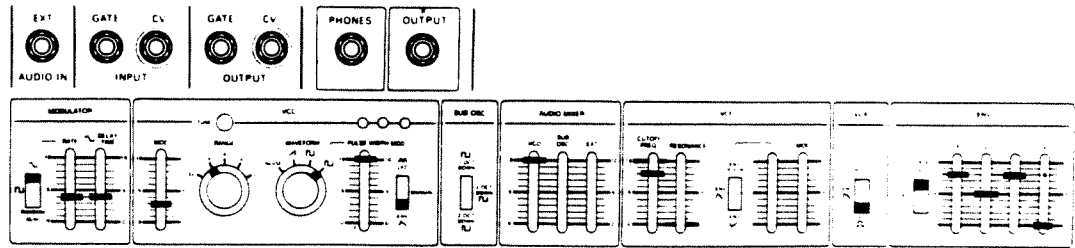

SYNTHESIZER 09 SH-09

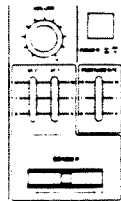

A good lead sound with narrowing pulse wave changing the tone of longer notes. Delayed vibrato enters at end of tone sweep.

Pitch bend a half-step or step. Vibrato will enter at end of bend if you time your playing that way.

A good patch for fast playing — instant attack and release (Gate) give speed and clarity regardless of keyboard technique.

NOTE: Optional Sub-Oscillator two octaves away lends weight and thickness. Use the Audio Mixer carefully — if too much Sub-Oscillator is mixed against the VCO the Pulse Width sweep will be obscured.

Flexible Lead Line

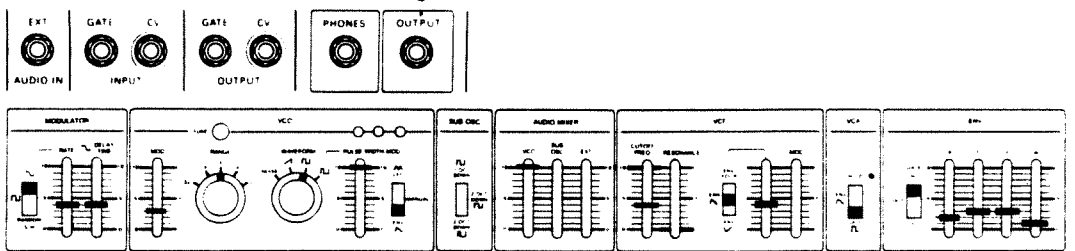

SYNTHESIZER 09 SH-09

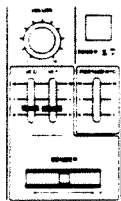

Great for subtle melody work. Try pitch bending away-and-back from notes held, or begin above or below pitch by bending in rest immediately before. Use reverb if available.

OPTIONS:

1) Switch VCO Waveform selector to

for a brass sound.

2) Switch VCO Waveform selector to Pulse Width Mod. for a more aggressive, synthesized sound.

These options make this patch very flexible for switching sounds during a piece or quickly between numbers.

'Chick Corea' Lead Line

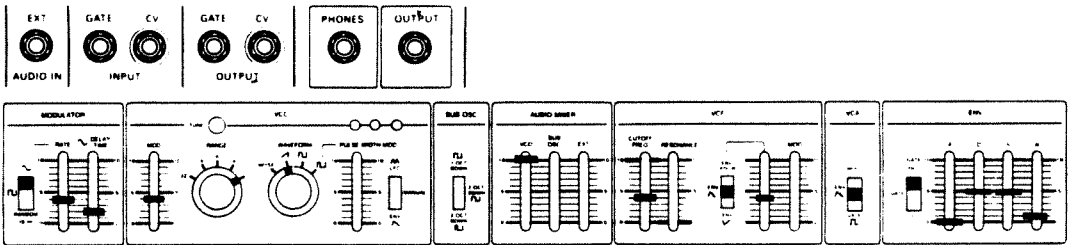

SYNTHESIZER 09 SH-09

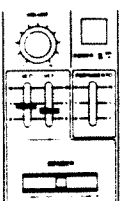

Play both legato and very short staccato styles.

Use pitch bend — small, subtle bends in mid-phrase, full octave bends quickly at the beginning of a note and springing back at the end of a note, and slower full octave bends on longer notes. NOTE: tone

changes with pitch bend for a more aggressive sound.

Use a LOT of reverb if it is available.

NOTE: the Gate and Trigger Envelope Mode is used so that notes will speak clearly in fast playing. NOTE: deeper delayed vibrato than normal.

Telstar'

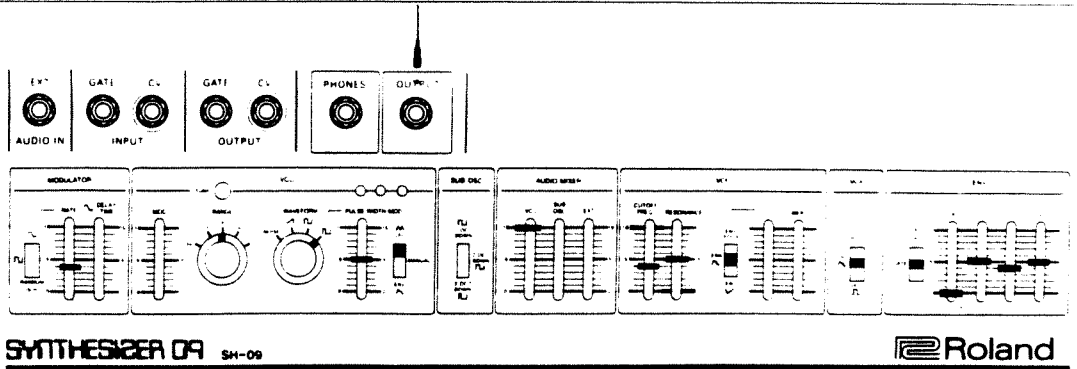

SYNTHESIZER 09 SH-09

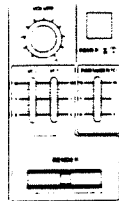

A good lead sound, reminiscent of that song from the sixties'.
Use reverb if available.

Electric Clavichord

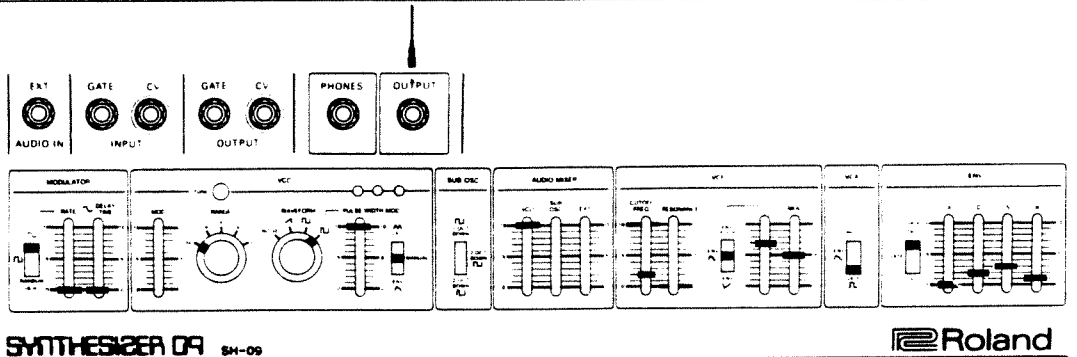

SYNTHESIZER 09 SH-09

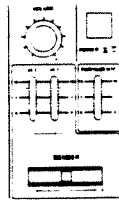

Play SHORT notes — don't hold keys for long.
Useful for 'funky' backing — think in style.
MOD in VCF alters sound slightly as played, adds variety and interest.

Use reverb if available.
A chorus pedal is useful as an optional effect.

Funky Lead with Wah Bend

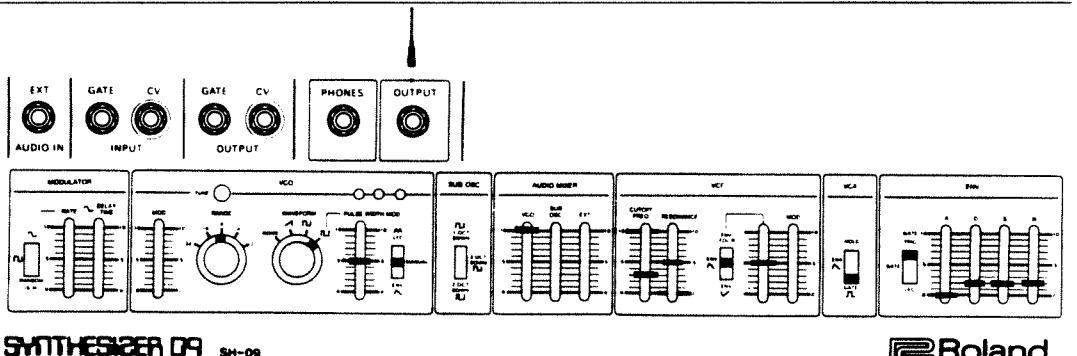

SYNTHESIZER 09 SH-09

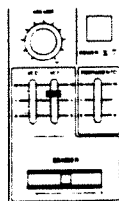

Similar to Electric Clavichord but more capable of carrying a lead line.
Use positive and negative bend for Wah-Wah control.

'Waw' Lead

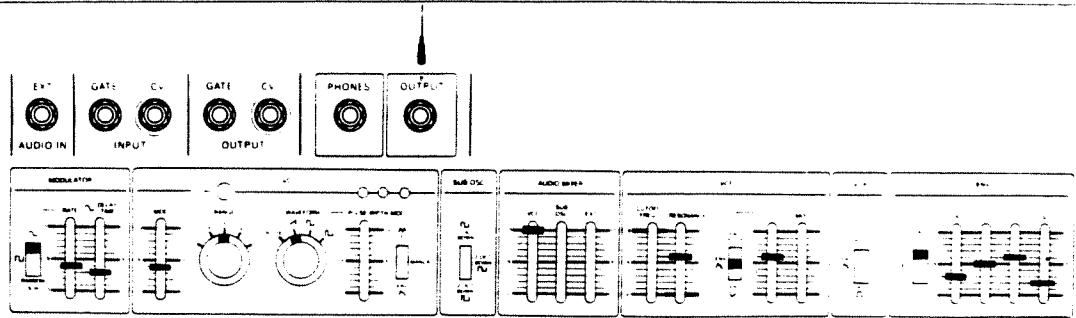

SYNTHESIZER 09 SH-09

Roland

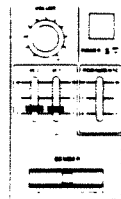

Bender controls pitch and 'Wah'.

Tone is bright at top of keyboard to 'cut through' and be heard through the sound of a band.

Flexible Bass

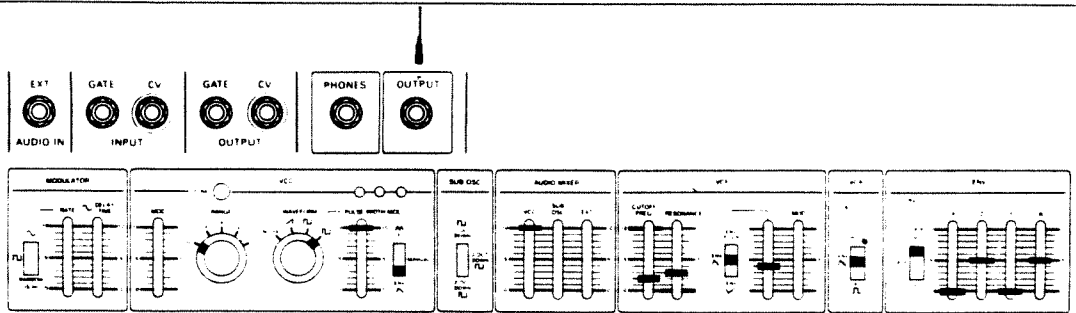

SYNTHESIZER 09 SH-09

Roland

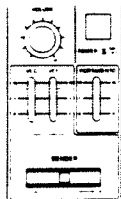

This bass patch uses the Gate and Trigger Envelope Mode and identical Decay and Release times for playing ease.

OPTIONS:

1) As marked for a 'fuzzy' rough rock n' roll sound.

2) Switch Pulse Width Mode to manual for a more clear, precise sound. Suitable for Country & Western.

3) Switch to the  waveform for a simple walking bass style.

Shuffle Bass

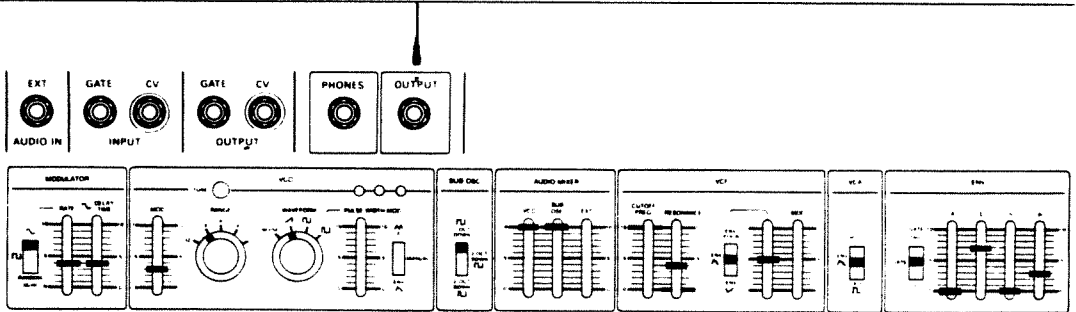

SYNTHESIZER 09 SH-09

Roland

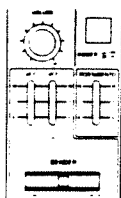

A very round, full sound — best at the middle and bottom of keyboard.

TECHNIQUE: Use of Gate Envelope Mode allows legato playing to give a new pitch without a new attack — as if the string was refretted to a new pitch without being plucked again. Detached playing gives a fresh attack for each note. Practice to gain

control over which notes get a fresh attack and which ones don't to add to the variety and flexibility of the sound.

NOTE: The Release time is shorter than the Decay time for further control. from the keyboard. NOTE: Sub-Oscillator adds thickness without tuning.

Compressed Bass

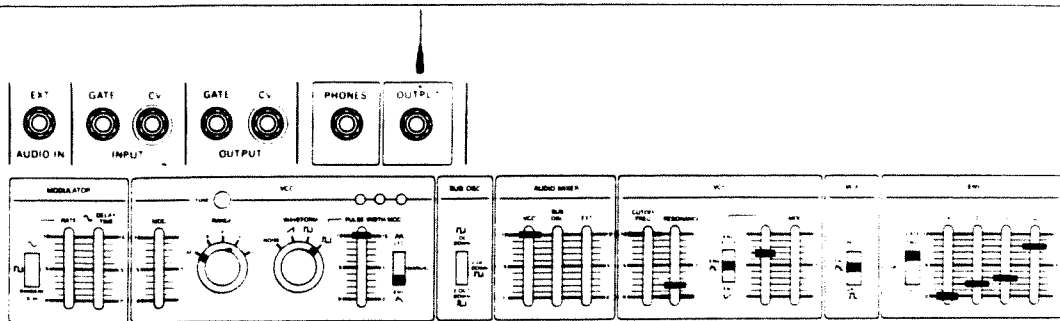

SYNTHESIZER 09 SH-09

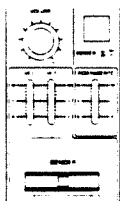

This patch gives two distinct bass sounds from one patch, determined by keyboard technique. Keyboard technique here is opposite to 'normal': notes held longer sound short and 'compressed', notes played very short with a 'plucking' action ring long and bright. Think in terms of the key being a string that will ring if plucked and

stop short if dampened with your hand and this should come easily. Practice to control how each note will sound.

NOTE: this patch is excellent to add a dynamic 'live feel' to sequenced bass patterns using a Roland CSQ digital sequencer. Record slow, playback fast

Growling Bass

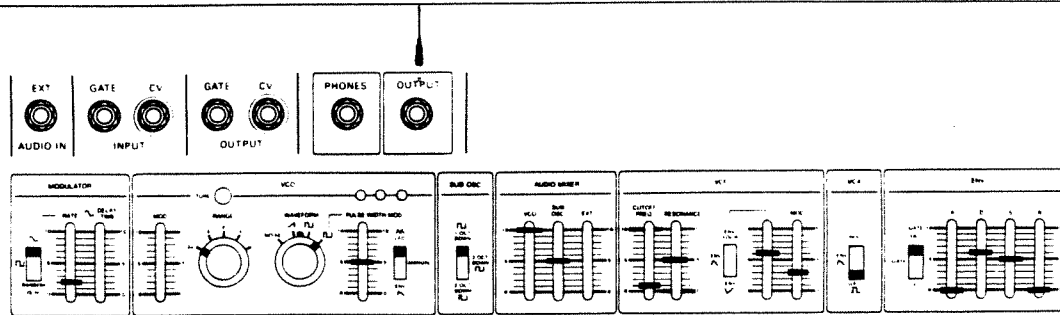

SYNTHESIZER 09 SH-09

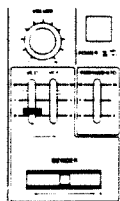

A more synthesized bass sound with a thick, growling tone and an instant attack and release.

Funk Bass

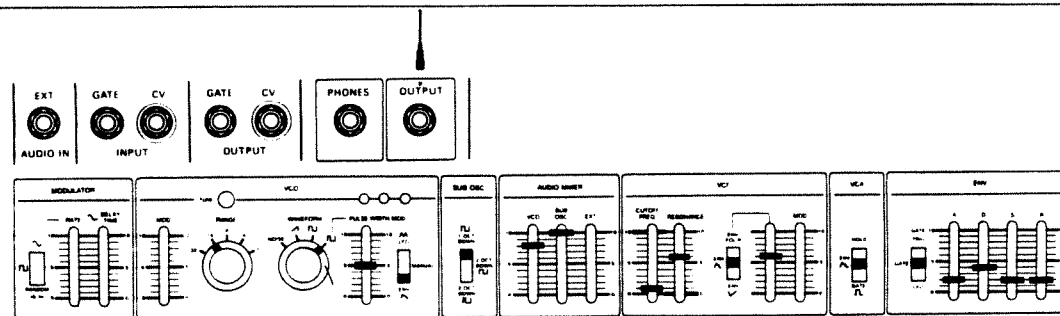

SYNTHESIZER 09 SH-09

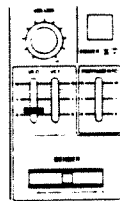

A funky synthesized bass sound. Good with pitch bend. Try bending during a rest before long notes, bending back into the note as it begins. Try the keyboard technique described for Shuffle Bass patch.

Experiment with other envelope shapes such as 'O' Attack and Release times or an occasional longer Attack time adjusted as you play.

Inverted Punch Bass

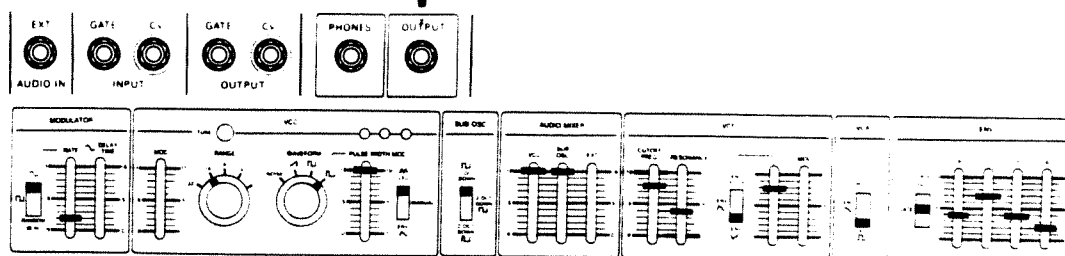

SYNTHESIZER 09 SH-09

Roland

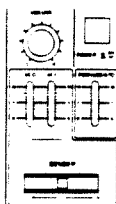

A synthesized bass with an initial 'punch' followed by a rise in tone and volume. Allows fast playing with clear attacks and the dynamic forward motion you would get

with a slow attack. Use a detached keyboard technique to get the 'punch' — legato technique gives an alternative growing bass without the 'punch'.

Tonewheel Organ

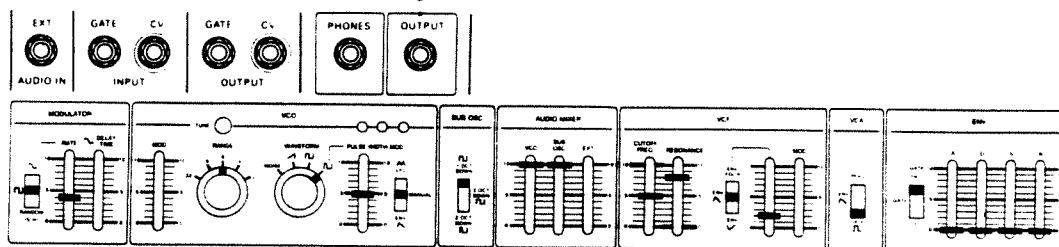

SYNTHESIZER 09 SH-09

Roland

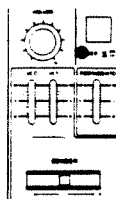

There are many good variations on this one:

- 1) The 'key click' is brought in with the VCF Envelope slider — it can be removed or altered to taste.
- 2) The 'drawbar' sound may be altered by

lowering the VCF cutoff to taste.

- 3) Experiment with other waveforms and Sub-Oscillator settings.
- 4) Vibrato may be introduced with the VCO MOD slider at different Modulator rates.

Upper and Lower Register Flute

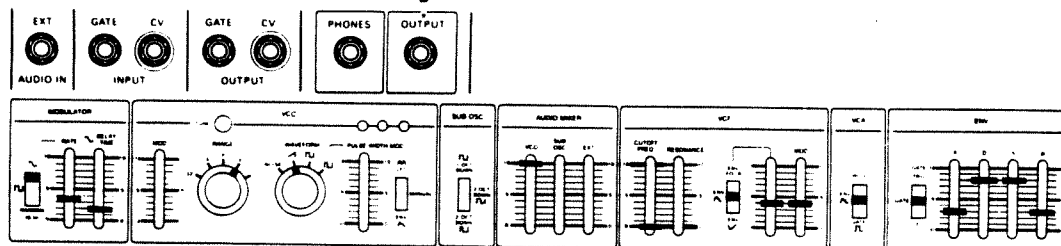

SYNTHESIZER 09 SH-09

Roland

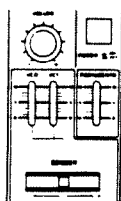

Play with a detached keyboard technique except for scale runs and trills — this is in character and avoids 'clicks' between notes.

Upper register (shown) is best played on the keyboards top end.

Switch to 8' VCO range for lower register and play the lower end of the keyboard. This gives a good breathy sound for slow passages.

When playing remember to put in rests for 'breathing'.

Adjust volume when switching registers as needed. Changing volume during playing adds expression — try a volume pedal between the SH-09 and amp.

Use reverb if available. Echo is also very effective with flute.

Jazz Trumpet

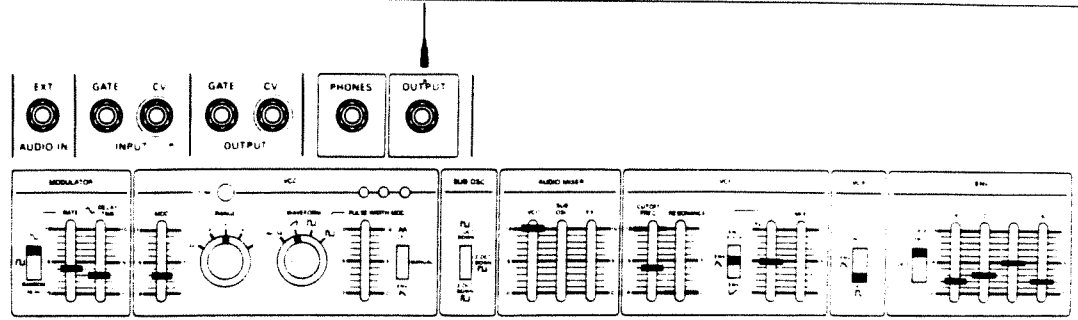

SYNTHESIZER 09 SH-09

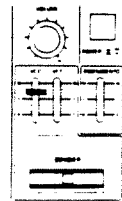

Notice the biting attack, the brass tonguing effect that a short attack gives. Longer attacks give wah-wah mute or french horn options. Gate and Trigger Envelope Mode gives accurate attacks to all notes. Quickly chipping the VCO bend one

octave at the very beginning and end of notes gives a jazz/rock 'pinch' for the high notes, the lack of stability from reaching for those 'impossible' notes. Use reverb if available.

Sax

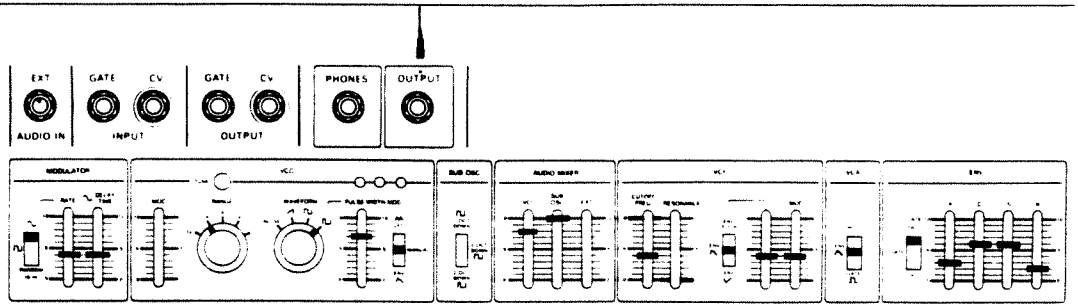

SYNTHESIZER 09 SH-09

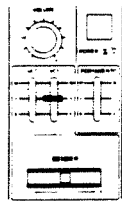

Sax is difficult to synthesize because it sounds many different ways, even within one solo, and because its technique offers very fast and technical playing ability. For best results use the flexibility of this patch, practice, and listen to sax players. Legato and detached playing sounds different — use both.

Bend the VCF before a note or passage to add variety while playing. Move the Modulator Rate to '10' to get a growling tone which may be used as shown or with '0' Delay. You may also bring the VCF MOD slider in only as needed with your left hand.

Clarinet

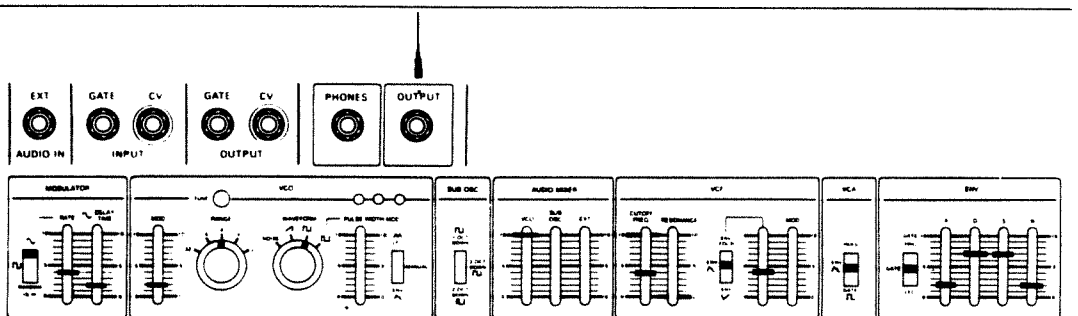

SYNTHESIZER 09 SH-09

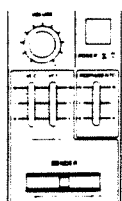

This patch is a good, simple example of combining a manual VCF cutoff setting with ADSR modulation of the VCF. Both legato and detached keyboard techni-

ques sound correct, each contributing a different Clarinet playing style. Practice both so that you may alternate between them to get the most out of this patch.

Violin/Viola

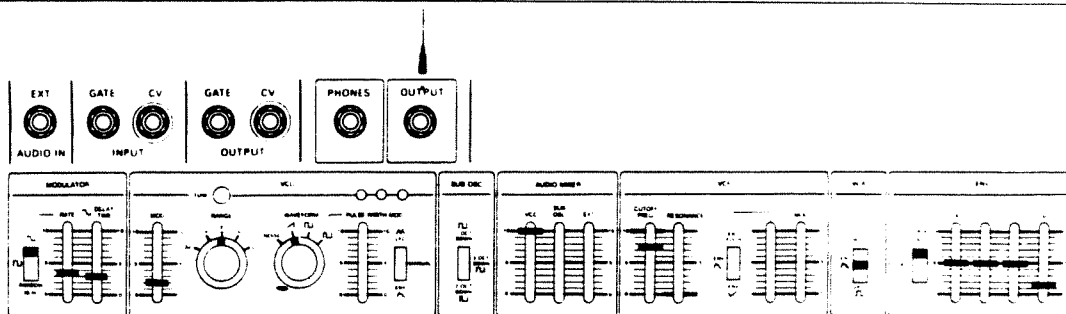

SYNTHESIZER 09 SH-09

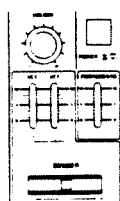

Play with a detached keyboard technique. Short notes will be softer and lighter than longer notes.

Set the Release time just long enough to sound natural. Use reverb if at all possible.

Bassoon

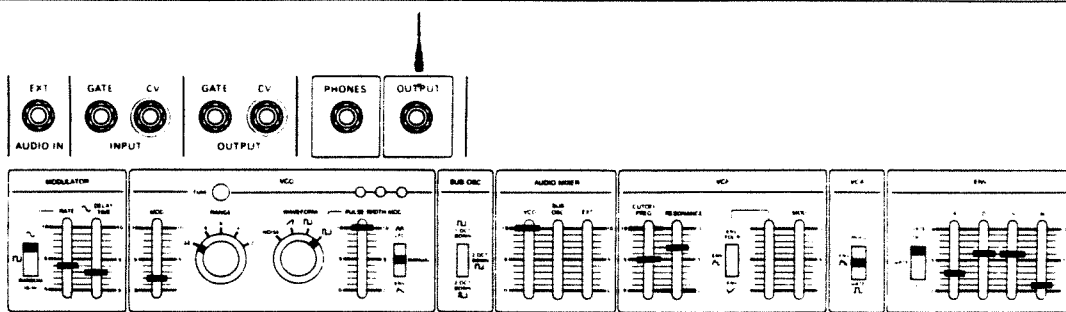

SYNTHESIZER 09 SH-09

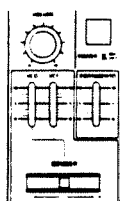

This patch is a good example of using Resonance to change tone instead of emphasising motion within the filter.

For best results play in the middle and bottom end of the keyboard. Use reverb if available.

Xylophone

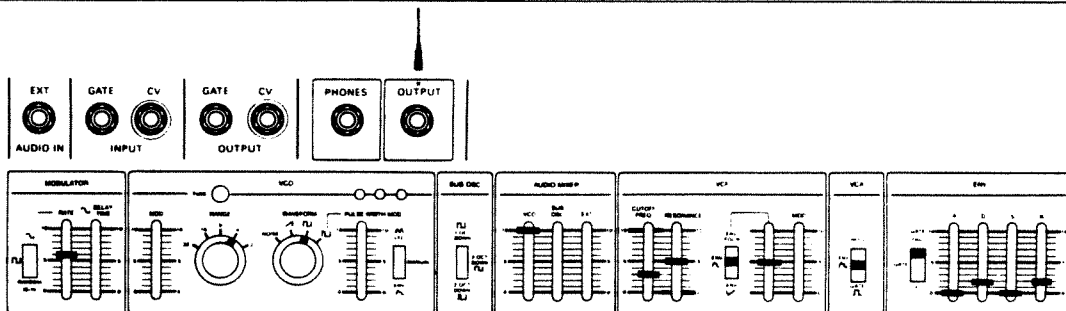

SYNTHESIZER 09 SH-09

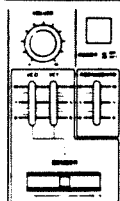

Try switching to the Envelope Mode labelled LFO and Xylophone rolls on any key, at a speed determined by the Modulator Rate. You may choose either the Gate

and Trigger or LFO Mode, or switch between them with your left hand as you play. Use reverb if available.

Vibraphone

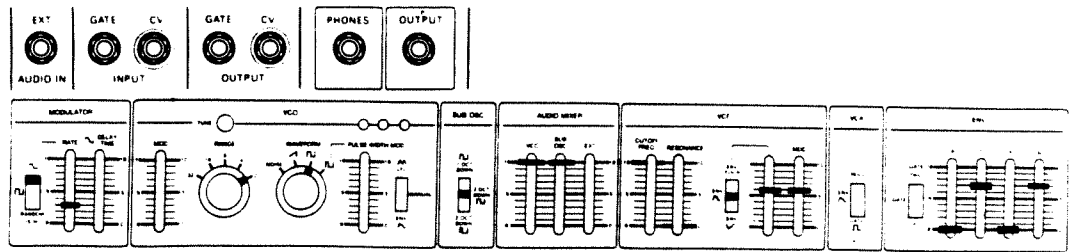

SYNTHESIZER 09 SH-09

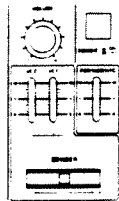

This patch is a good example of combining the VCO and the Sub-Oscillator square wave two octaves down to produce the

sound of one single with a complex tone color.

Best played in a slower, melodic style.

Female Voice

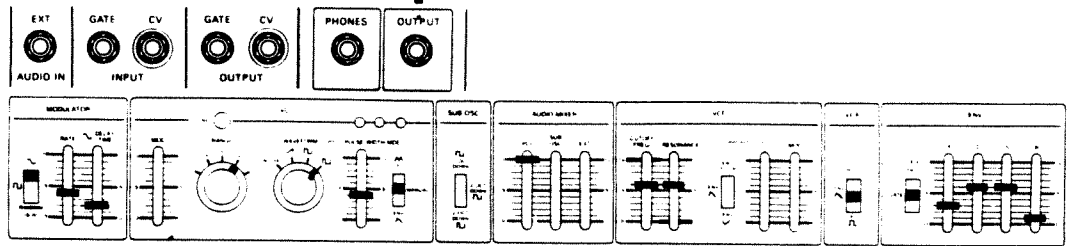

SYNTHESIZER 09 SH-09

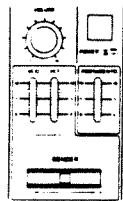

Careful settings and slow, lyric melody lines will yield an 'aw' sound. Pay particular attention to the Cutoff and Resonance settings — experiment around

'5' and '6'.

Try a small amount of portamento.

Use reverb if available.

Chirping Birds

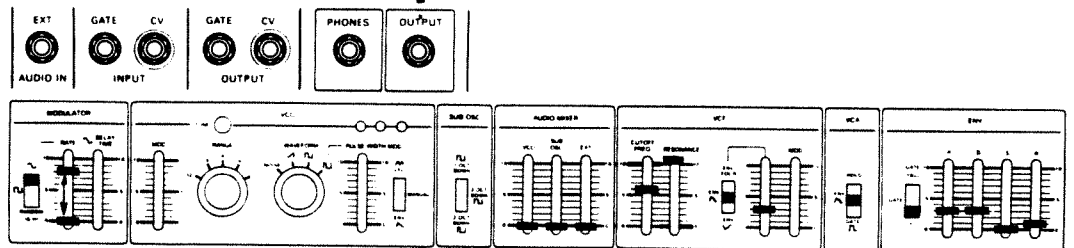

SYNTHESIZER 09 SH-09

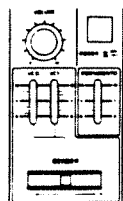

This patch is a good example of both LFO gating of the Envelope and of using the VCF as an oscillator.

Press different keys for different lengths of time, changing the Modulator Rate between notes.

Wind

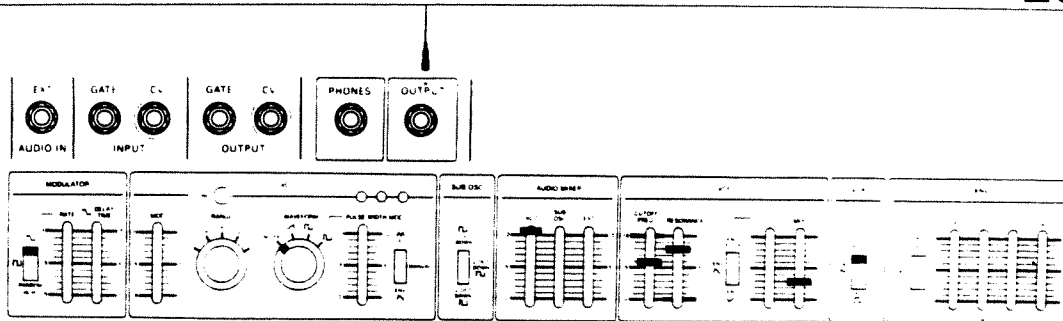

SYNTHESIZER DA SH-09

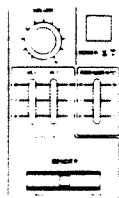

Press the release the bottom key. A good example of the Noise waveform, and the Hold function.

Resonance is responsible for the howling of the wind — raise it slightly to increase

the howling (raising it too far will result in a screeching sound).

Lowering the Resonance completely eliminates the howling of the wind and gives a sound similar to rolling surf

Synth Drum

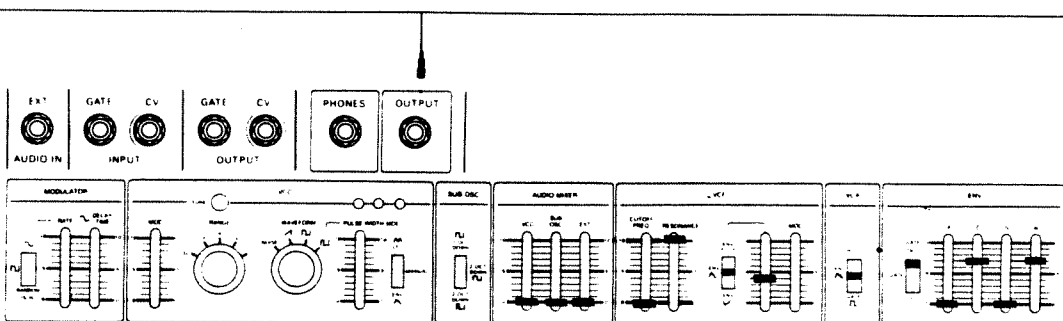

SYNTHESIZER DA SH-09

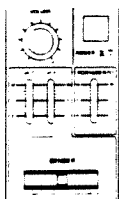

Different pitches are available from different keys.

Play rhythms and short rolls on keys — the

Gate and Trigger Envelope Mode will allow fast playing.

Inverted Synth Drum

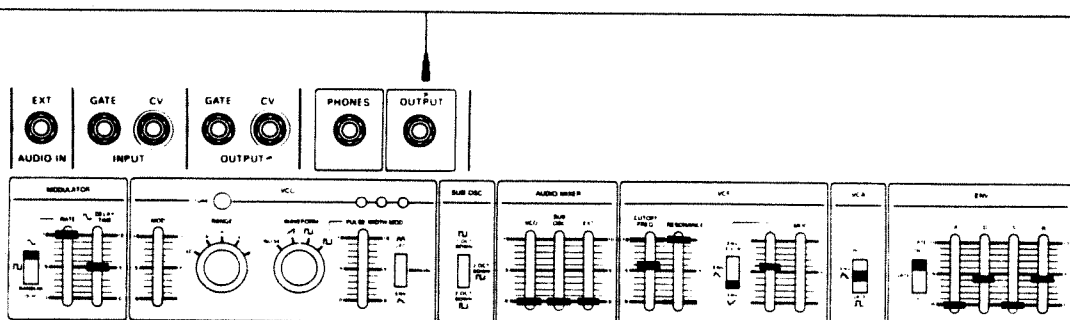

SYNTHESIZER DA SH-09

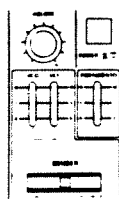

Different pitches are available from different keys.

Play rhythms and short rolls on keys — the Gate and Trigger Envelope Mode will allow

fast playing.

Raise the VCF MOD slider to '7' for delayed special effect.

Bass Drum

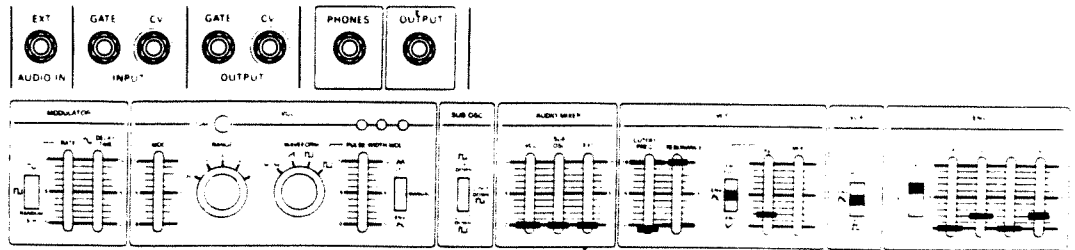

SYNTHESIZER DR SH-09

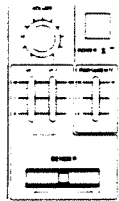

Strike a key in the middle of the keyboard — different keys will change the sound
Experiment with different drum sounds as an extension of the Roland CR rhythm units, and especially the Boss DR-55 Dr.

Rhythm unit with its programmable trigger output. Simply plug the rhythm units Trigger Output into the SH-09 Gate Input and you have added a custom drum, Synth-Drum or other effect.

Driving Random Pitches

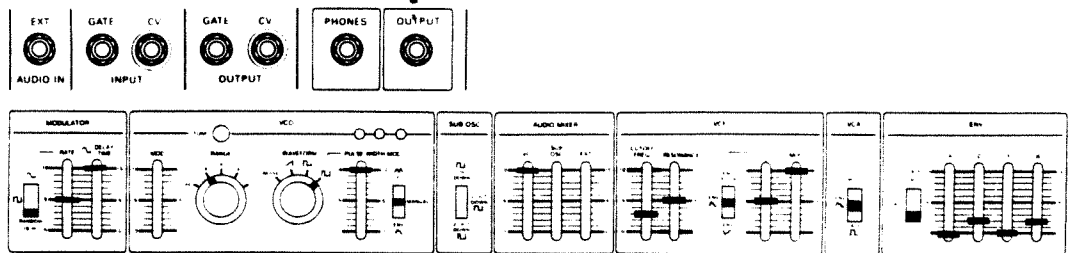

SYNTHESIZER DR SH-09

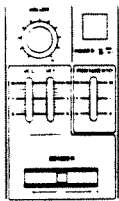

Play any key on the upper end of the keyboard. The Sample and Hold will give both random pitch and tone changes while the LFO gating of the Envelope repeats a steady, driving beat.
To use this sound without the pitch

changes, lower the VCO MOD slider to '0', switch the VCO Range to '32', and raise the VCF Resonance to '7' — you will get the driving rhythm and tone change without losing the identity of your musical line.

Heavy Random Tone Colors

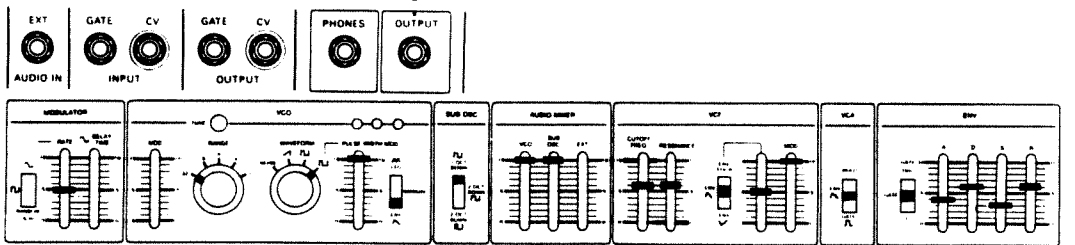

SYNTHESIZER DR SH-09

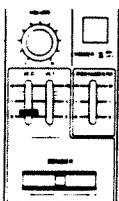

A heavy bass synthesizer patch using Sample and Hold to provide a rhythmic change in tone color during the Sustain

and Release of each note. Pitched are not effected so the musical line does not lose its identity.

Designing your own patches is very rewarding and not all that difficult. You should always begin by listening carefully to any sound you wish to synthesize, clearly visualizing in your mind any sound you wish to create. Once you have a strong enough idea about the sound you are seeking that you can base decisions upon it, building a patch for that sound can follow a logical process.

Figure 2 represents one such process, building a synthesizer sound as you would a pyramid — beginning with a solid foundation, adding building blocks, and tying it all together with a capstone. If your foundation blocks are not correct or at least relatively close no degree of subtlety with other building blocks can correct the error.

Foundation decisions concern basic pitch, tone and volume. Decide on a basic pitch range, selecting exact octave and keyboard use as you proceed. Next, select a basic waveform for one oscillator (do you need the buzz of sawtooth, the hollow clarinet quality of square, or the nasal quality of pulse?) and make a preliminary guess concerning whether the VCF is 'active' (raise the Envelope slider) or 'passive' (raise the Cutoff slider). Your final basic

foundation decision is the basic ADSR shape — play long and short notes on the keyboard as you set these controls. Keep your mind open about these settings and adjust them as you proceed, adding an extra oscillator or mixing VCF controls as needed.

Once you are satisfied with your basic Foundation decisions, proceed through the finer points. These are basically self-explanatory, but remember to keep your basic sound firmly in mind and pay attention to your keyboard technique — it has an influence on many parts of your sound.

Again, the final major consideration is the Style with which you perform the patch. If you are imitating a sound, study the style. If you are creating a sound, decide upon one style and stick to it.

This discussion on designing your own patches shows only one of many approaches. As you use it, backtrack and change anything you discover is faulty. Go back through this manual and study the text and the patches. The aural lessons learned there will make patching easier as you recognise patterns in sound.

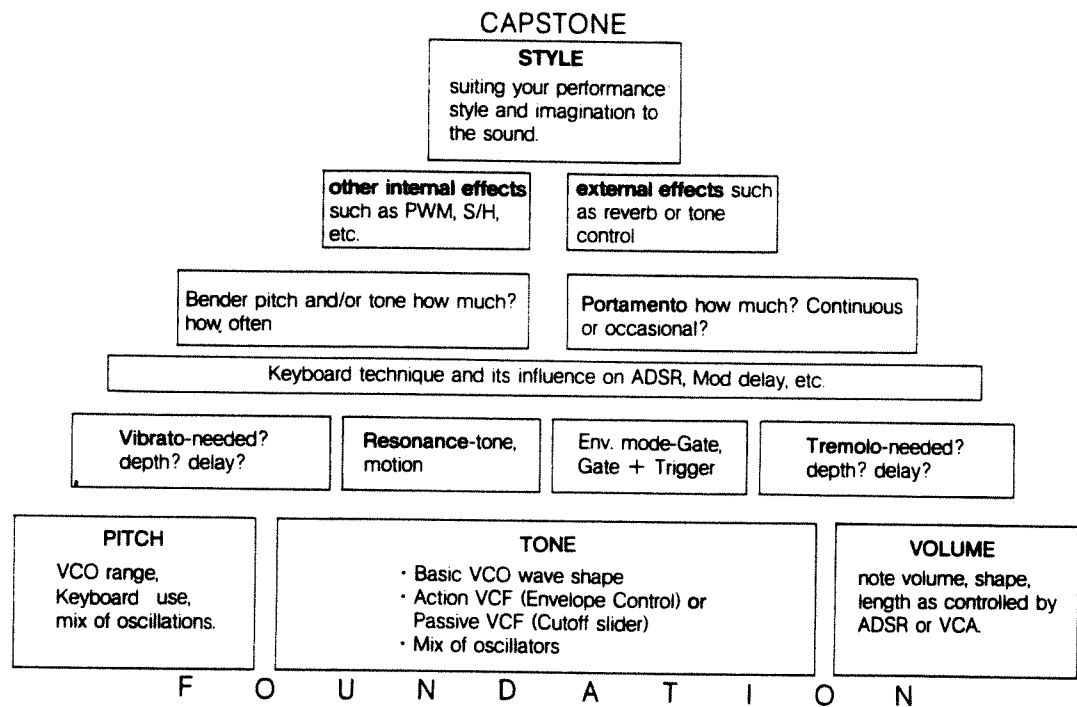

Interfacing capability is perhaps the SH-09's most striking advantage, an ability to expand in many directions and to virtually customize itself to a performer's needs. An instrument such as electric piano or guitar may be processed through the SH-09 for synthesizer style effects, any polyphonic instrument with a gate output may be linked through the SH-09 to achieve polyphonic synthesizer sounds and the SH-09 control inputs and outputs allow it to be used with other synthesizers or with units such as the Roland CSQ digital sequencers for flexibility and freedom to create.

Combining the SH-09 with another instrument gives much greater flexibility than using the two instruments independently. Either or both may still be played independently, switched to play as a single new instrument, or used both for the sounds of the external instrument and of the SH-09 combination at the same time for orchestration style layering. Using a Roland CSQ Digital Sequencer with the SH-09 allows musical lines either pre-programmed or programmed as you play to be automatically repeated or altered at will, expanding the talents and capabilities of a player beyond his normal hands-and-feet limitations. These abilities

are very helpful in the studio, but virtually essential in live performance where a keyboard player must in one playing recreate the thick, complex sounds his audience expects — sounds originally created through multitrack recording and/or the use of many session musicians.

Interfacing capability not only allows great artistic freedom and choice, but allows an involved keyboard setup to be built gradually as money becomes available. Building a system this way provides the performer with an instrument immediately, lets him become more familiar with each instrument as he builds gradually, and allows him to purchase absolute top quality instruments such as the SH-09 at each step of the way instead of buying a more expensive instrument which compromises quality and flexibility in order to be more comprehensive. You may feel confident that the SH-09 quality and extensive expansion options will not lock you into a closed concept that must be traded in and changed completely each time your musical needs change or expand.

Interfacing External Instrument Without Gates

An external source with no Gate output such as a microphone, an electric piano or electric guitar may be processed through the SH-09 using the Audio Mixer, VCF and Modulator sections. The VCO, Envelope and Delay Time functions of the SH-09 cannot be used in this application because there are no Control Voltage or Gate commands for them to follow.

Example 1 uses the natural volume shape of the Roland MP-600 Electronic Piano to modulate or move the filter using the SH-09's self-contained Envelope Follower. The Envelope Follower in the VCF raises and lowers the Cutoff Frequency in direct proportion to increasing and decreasing volume levels from any incoming external signal. The MP-600 is an ideal instrument for this application because its touch sensitive dynamics let you control the depth of the SH-09 filter sweep from the piano keyboard, it has an adjustable Decay

time to shape the filter sweep, and includes both mixable Tone sliders and a six band Graphic Equalizer to control the sound presented to the SH-09 for processing. Block chords or unison rhythms work best with this patch because there is only one set of synthesizer components to process the summed output of the piano. The same process will work with other external instruments, using the natural note shape and tone for a basic starting point.

Examples 2 and 3 continuously pass the external instrument signal through the SH-09, adding either a constant Wah-Wah or Sample and Hold effect to the sound as it passes through the VCF, acting as a sophisticated effect device. You may find the Sample and Hold patch the most effective, since that effect is exclusive to synthesizers and therefore unexpected and unusual on other instruments.

Interfacing External Instruments With Gate Outputs

The most popular application of SH-09 interfacing is with polyphonic keyboard instruments that have Keyboard Gate outputs such as the Roland RS-09 Organ/Strings and the Roland SA-09 Saturn. In this application the SH-09 controls function normally with the exceptions that the pitches, basic tone selection and the Keyboard Gate are provided by the external instrument (the SH-09 VCO and keyboard are not used). When the two instruments are linked, the combined instrument is played from the external instrument keyboard using the SH-09 controls as an extension of the external instrument. The great advantage of connecting an instrument

possessing a Gate output to the SH-09 is that the Envelope may now be used to sweep the filter — a critical element in many synthesized sounds. The gate will also initiate the delayed LFO output of the SH-09 modulator, although you are restricted to applying it as Tremolo within the VCF since you are not using the SH-09 VCO. Instead use the delayed Vibrato available on both the RS-09 Organ/Strings and the SA-09 Saturn oscillators. Standard Keyboard Gate logic is followed and the most successful keyboard technique is usually to play in block chords or with unison, separated rhythms.

The RS-09 Organ/Strings has a special Raw Organ Output, making it ideal for synthesizer interfacing.

This output is a straight mix of the oscillators before any Chorus Ensemble or Tone Selectors, allowing the RS-09 String and Organ sounds to be used normally while providing the SH-09 with a pure sound as a basis for poly-synthesizer sounds.

Both the RS-09 and SA-09 provide Drawbar Mixing control over the output that you will process with the SH-09. Each has four parallel octave tones at 8', 4', 2', and 1' pitches which may be mixed in a form of additive synthesis to provide different waveforms for the SH-09 to work with. The RS-09/SH-09 Woodwind patch provided here uses

one slider to provide a Square wave. The RS-09/SH-09 Brass patch combines four sliders to provide a Staircase wave, very similar to the Sawtooth wave normally used for synthesizer brass patches. Each RS-09 drawbar slider provides a pure Square wave on its own, while the SA-09 has four Tone Selectors which can alter the tones from the basic square wave before they are mixed and sent for processing.

Four examples each are presented for interfacing the RS-09/SH-09 and the SA-09/SH-09 combinations. Carefully study the diagram and the accompanying text to fully understand the principles behind interfacing external instruments possessing gate outputs.

Interfacing Digital Sequencers

A digital sequencer may be interfaced with the SH-09 to actually play the synthesizer for you, according to your instruction. A Roland CSQ Digital Sequencer may be connected directly to your SH-09 as diagrammed in the examples given, actually placing it within the synthesizer between the keyboard and the rest of the instrument. No patch cord changes are necessary to bring the sequencers into work — they can be loaded, played back, or return your SH-09 to normal keyboard control with no hesitation or interruption of the musical line.

Both the CSQ-100 and CSQ-600 Digital Sequencers are loaded and manipulated from the synthesizer keyboard. The CSQ's memorize exactly how you play the SH-09's keyboard: pitches, rhythms, and the exact length of each note or rest for every nuance and subtle change in tempo or style. Since the CSQ's memorize the performance and not the sound itself, the sound patch of the SH-09 may be altered before or even during performance.

The CSQ Digital Sequencers can be loaded during

live performance or prepared beforehand. Any musical line loaded can be played back exactly as originally performed, as notes of equal value no matter what the original rhythm, or with the original pitches over a different rhythm rewritten from the synthesizer keyboard. Tempo may be adjusted over a wide range, sequences may be played once or repeated automatically, and may be transposed from the keyboard of the synthesizer.

Two examples are given here, each interfaced one step further by linking the CSQ sequencers with a Roland Rhythm unit so that they will run together in rhythmic sync. In Example 1 the smaller CSQ-100 is actually being driven rhythmically by the gate output of the DR-55 programmable rhythm unit. Example 2 shows the larger CSQ-600 driving the internal clock of the more flexible CR-78 Programmable Rhythm unit so that each has total rhythmic flexibility, yet will run in perfect tempo with one another. Only the jack connections are shown here, for further information refer to a CSQ owners manual or your Roland dealer.

Patches

A blank patch sheet is provided for each of the interfacing combinations discussed. Photocopy them for use with the actual instrument combination or to work out in advance which combination of interfacing suits you best.

Intertacing External Instrument Without Gates

Example 1

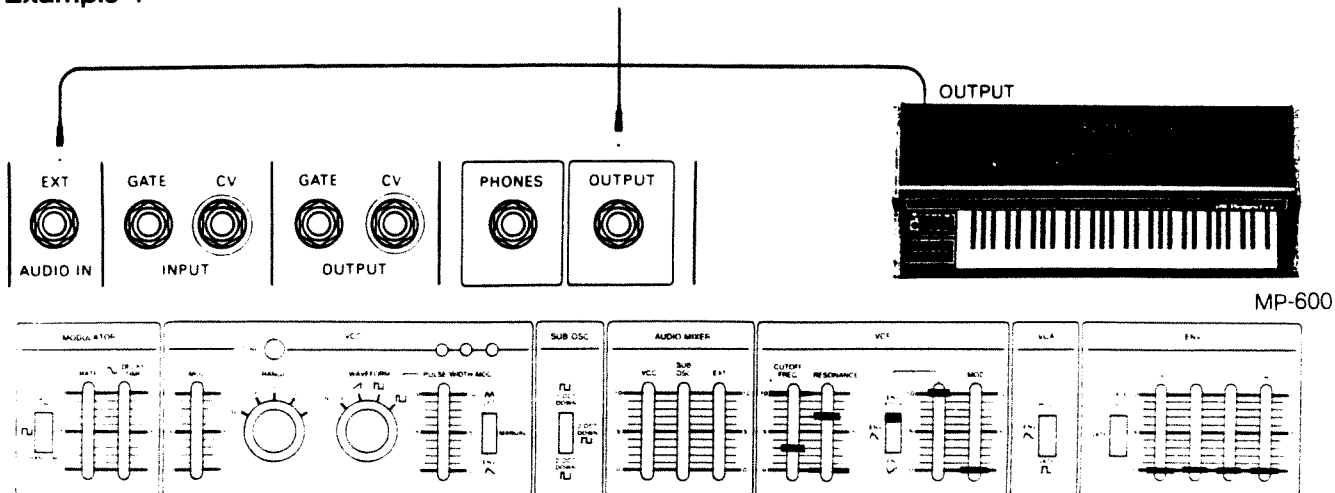

SYNTHESIZER 09 SH-09

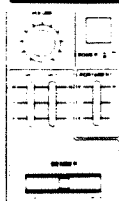

A touch-sensitive wah effect for external instruments.

Instruments such as guitar and the Roland MP-600 Electric Piano are "touch-sensitive" and can increase and decrease wah depth by accenting or playing softer.

Instruments that are not touch-sensitive can vary the wah depth by carefully choosing the number of notes played at once — more notes give greater wah depth.

For Bass instruments, lower the VCF Cutoff slightly.

Example 2

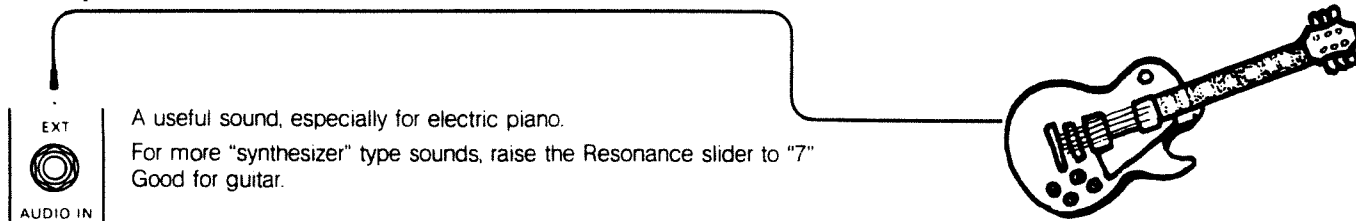

A useful sound, especially for electric piano.

For more "synthesizer" type sounds, raise the Resonance slider to "7"
Good for guitar.

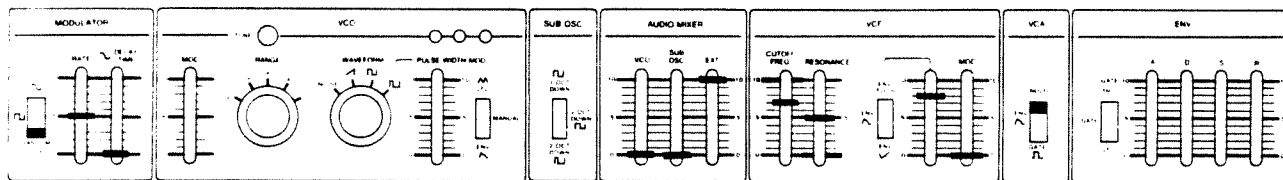

Example 3

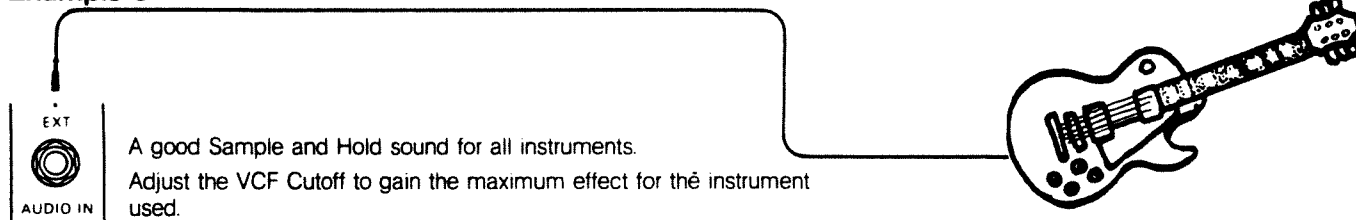

A good Sample and Hold sound for all instruments.

Adjust the VCF Cutoff to gain the maximum effect for the instrument used.

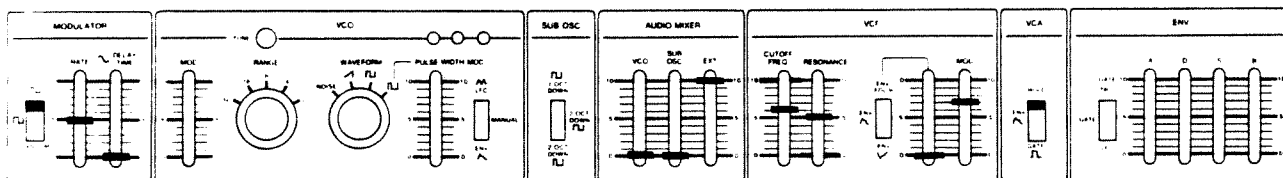

WOODWIND & STRINGS

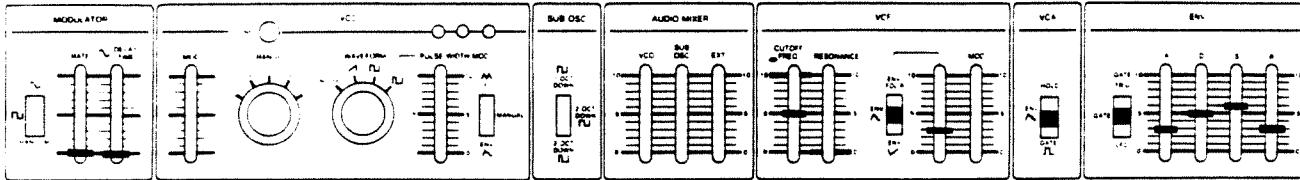
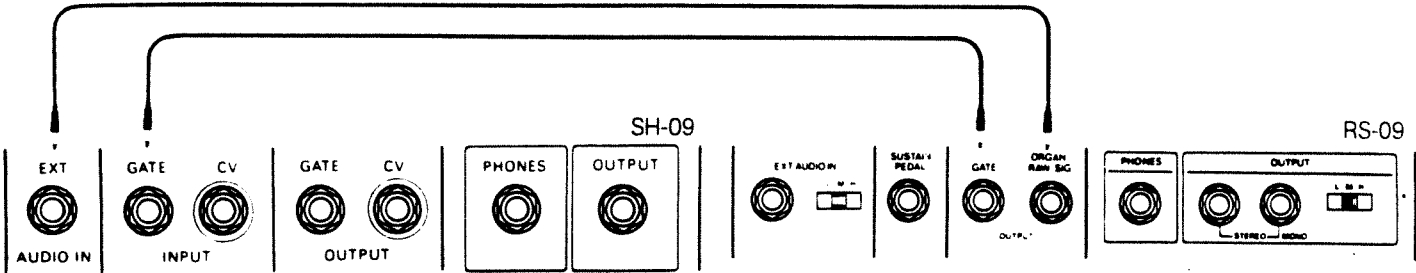

SYNTHESIZER 09 SH-09

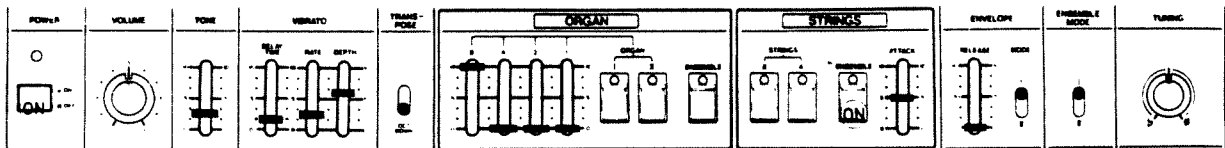
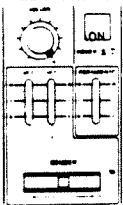

Woodwinds alone.

Use reverb if available.

To add strings, press the RS-09 4' String switch.

BRASS & STRINGS

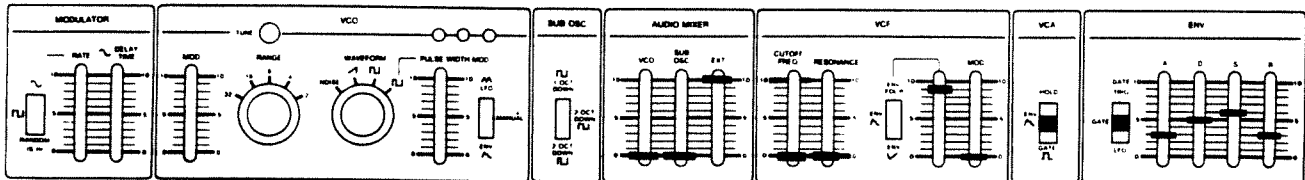
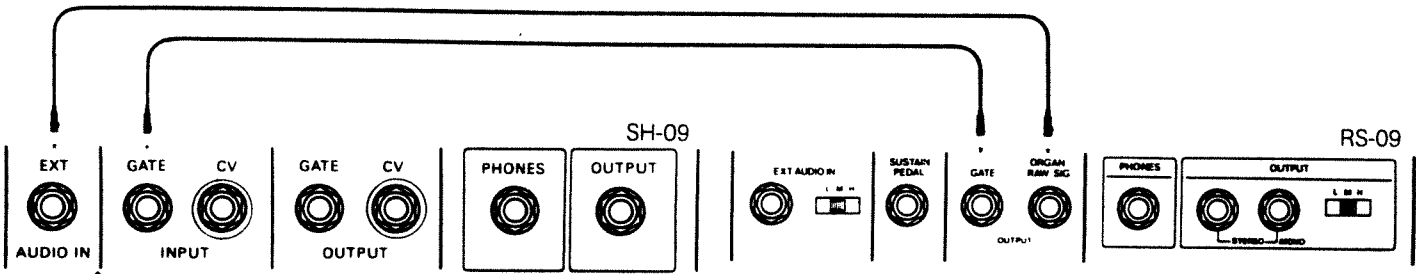

SYNTHESIZER 09 SH-09

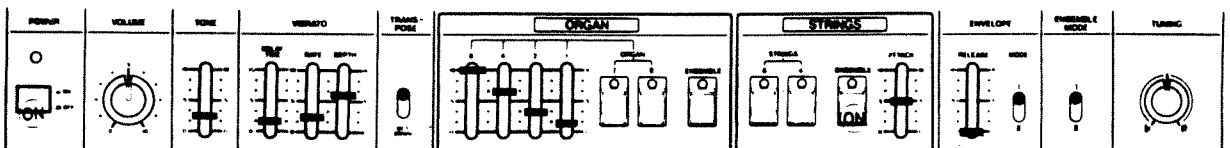
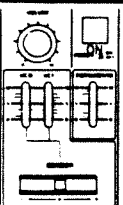

For lower Brass, transpose RS-09 down one octave.

Longer chords or notes let strings rise to stronger volume.

Add Strings by pressing the RS-09 4' string button.

Use reverb if available.

Short block chords or solo notes will de-emphasize strings.

ELECTRIC PIANO

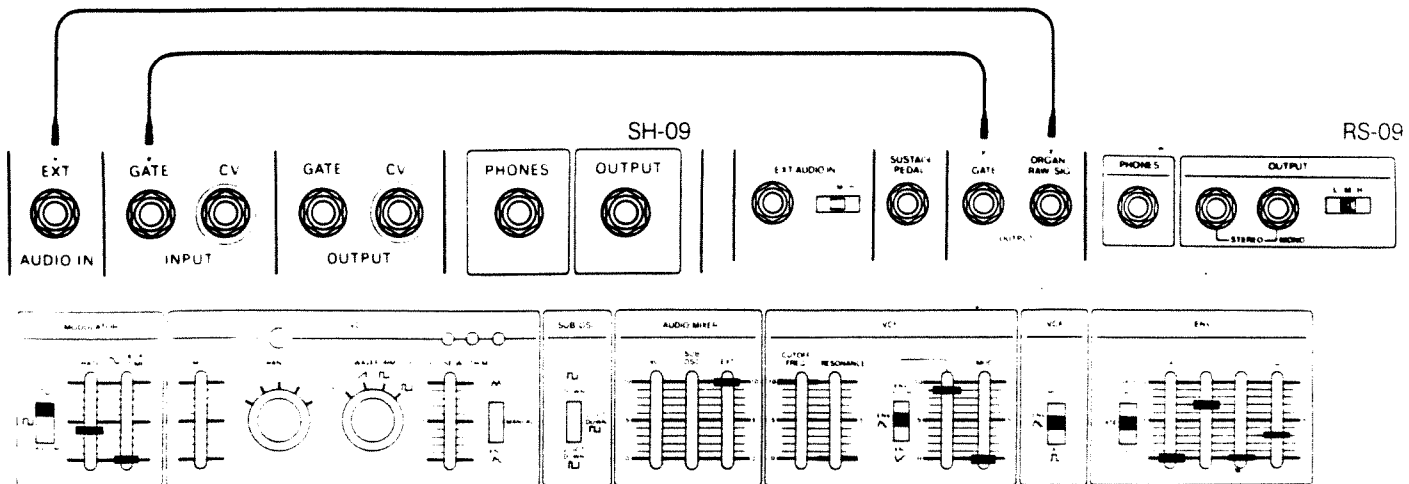

SYNTHESIZER 09

SH-09

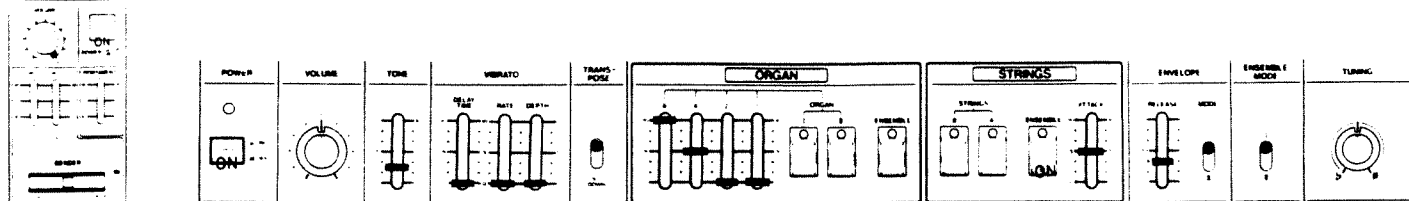

Play detached chords and solo lines.
Try transposing the RS-09 one octave down.

Try adding a "tine" sound by adding the RS-09 Organ 2' slider to "5".
Try adding tremolo by raising the SH-09 VCF Mod slider to "4".

POLY SYNTH & STRINGS

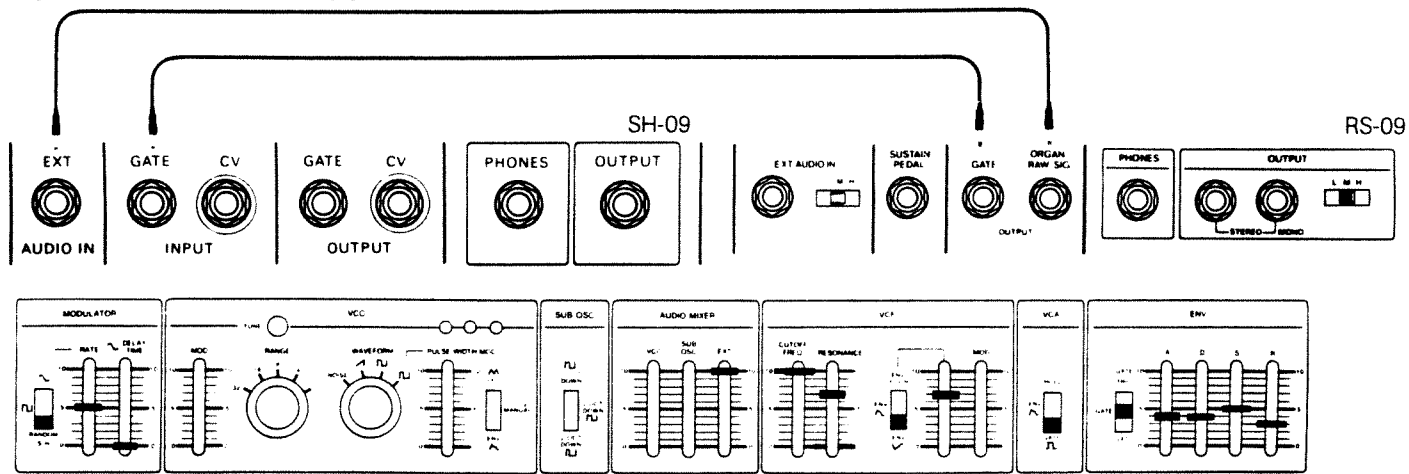

SYNTHESIZER 09

SH-09

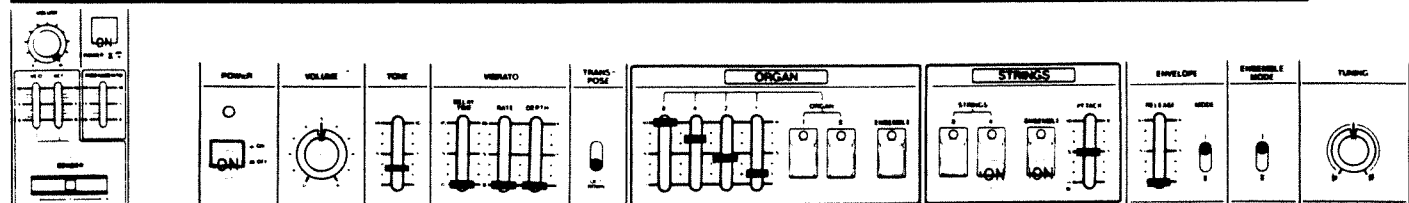

Inverted poly-synth sound with delayed strings.
Best with block-chord comping; holding some chords to hear delayed effect.

Try adding Sample and Hold by raising the SH-09 VCF Mod slider to "7".
Add strings by pressing 4' string button on the RS-09.
Use reverb if available.

WOODWINDS

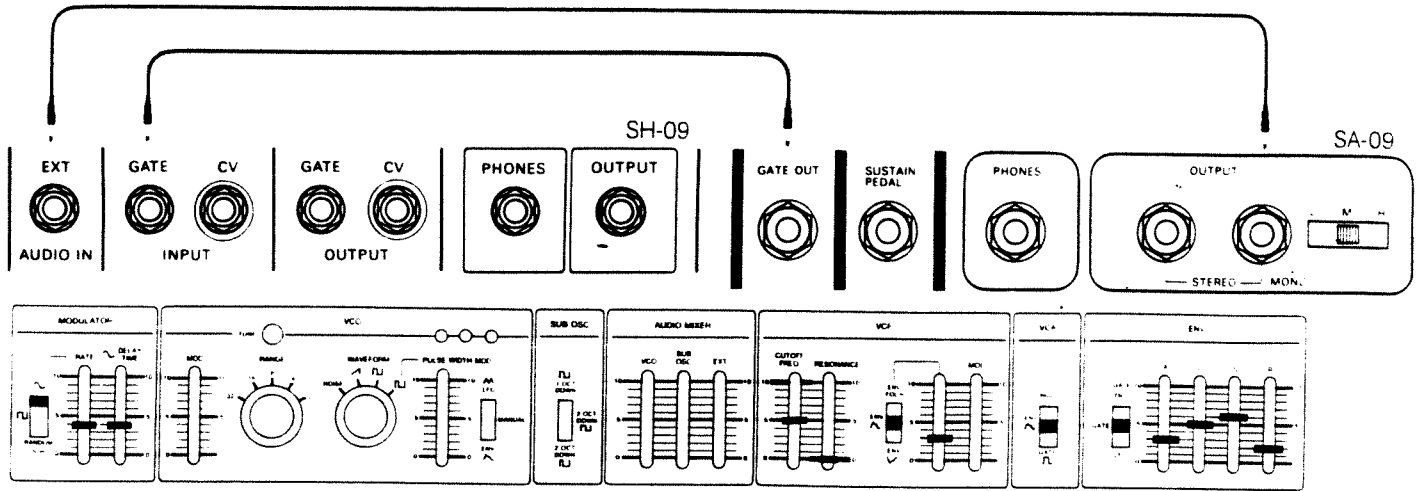

SYNTHESIZER 09 SH-09

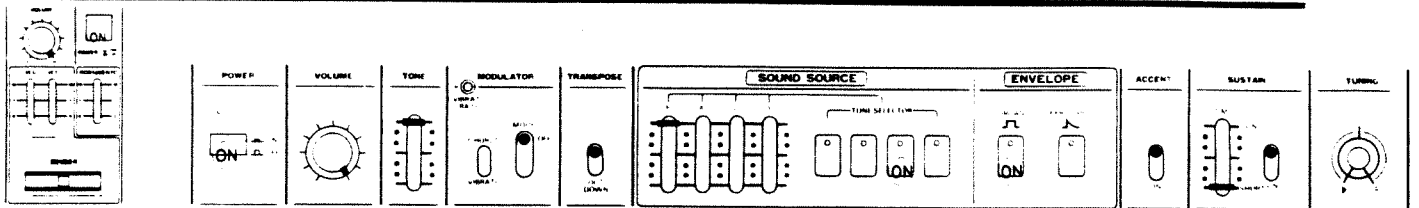

Woodwinds alone.

Play with detached chords and melody styles.

Use reverb if available.

TREMOLO VIBES

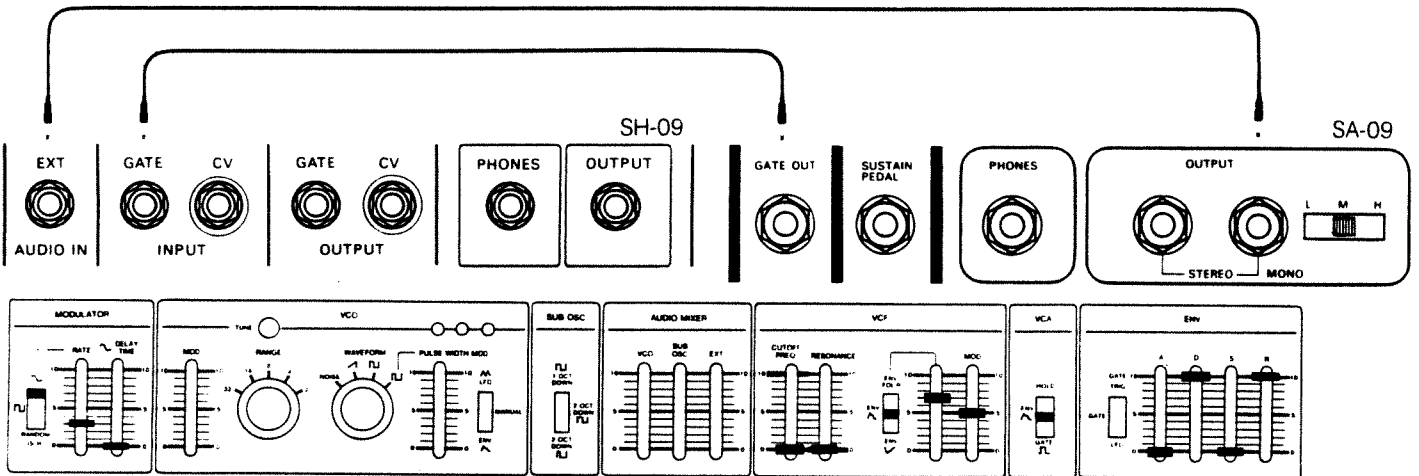

SYNTHESIZER 09 SH-09

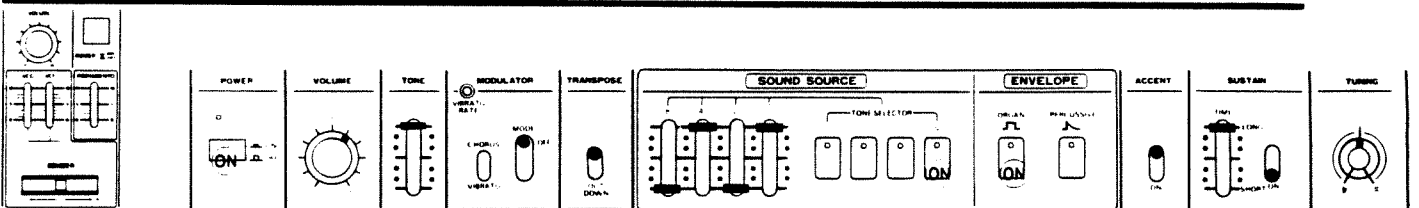

Strong vibes tremolo effect.

Freely polyphonic.

For ultimate control, use DP-2 sustain pedal and alternate sustain lengths.

Use reverb if available.

POLY SYNTH

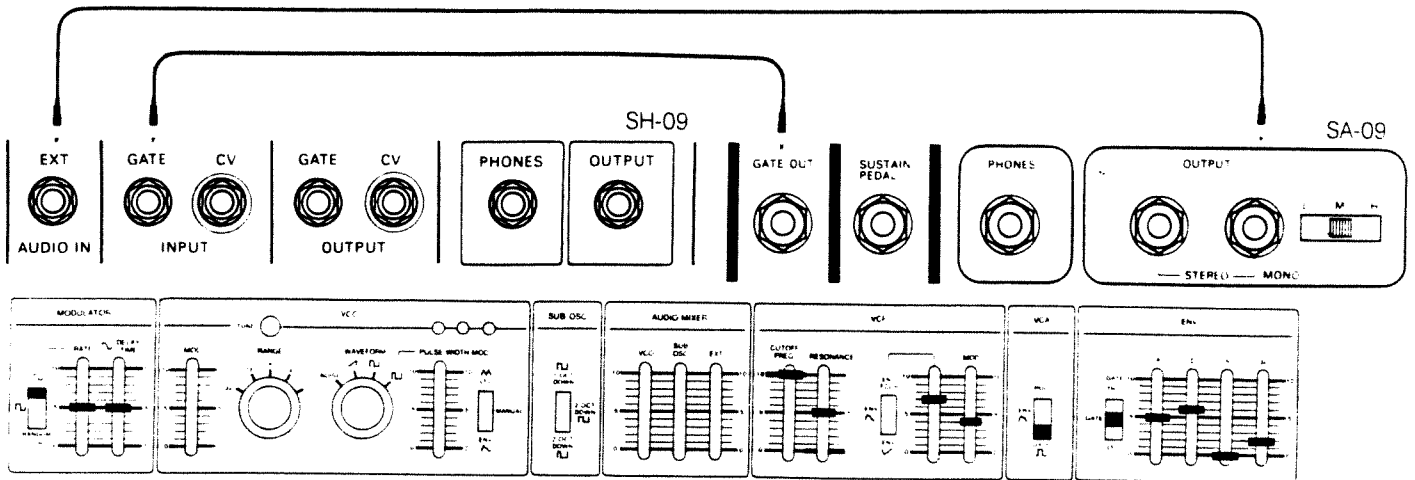

SYNTHESIZER 09 SH-09

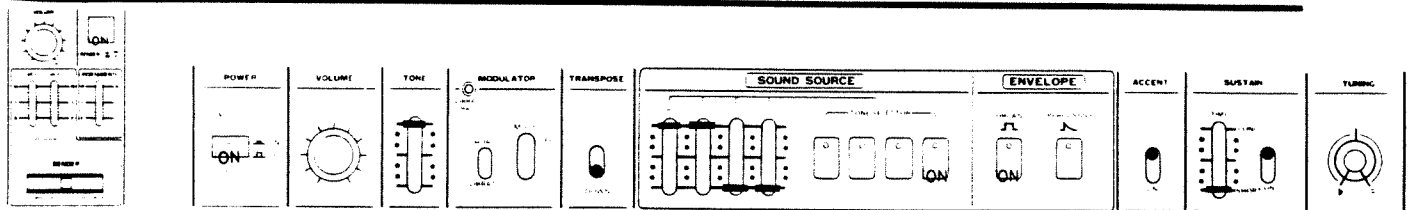

"Comp" chords, holding some long enough for the delayed effects. Normally play with a detached style, but also try changing the bass while holding a right hand-chord.

Try cancelling the SH-09 VCF Mod and adding SA-09 Chorus.

BRASS CHORUS

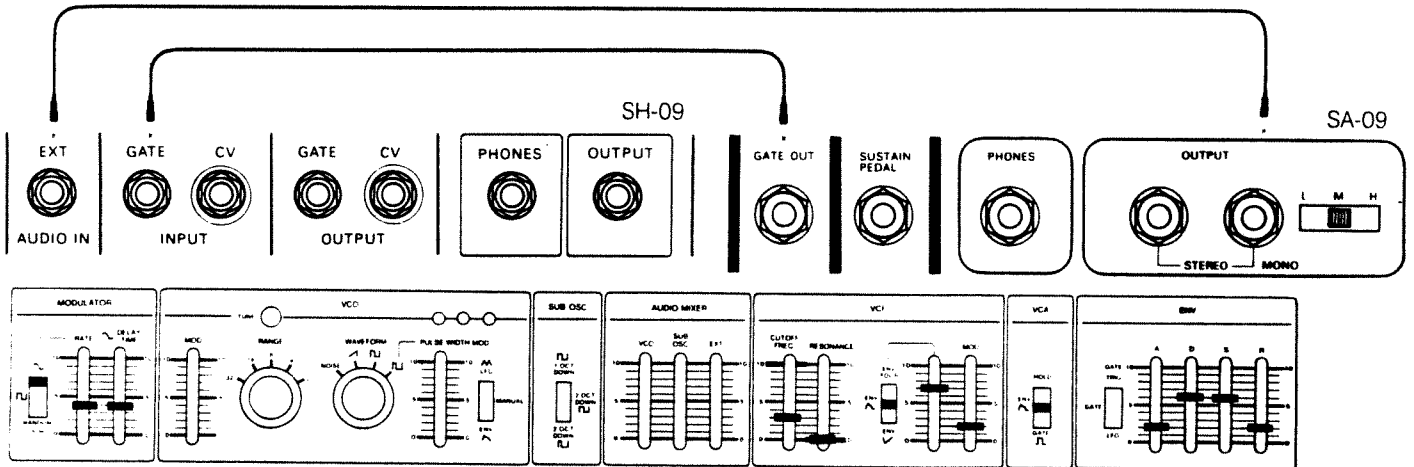

SYNTHESIZER 09 SH-09

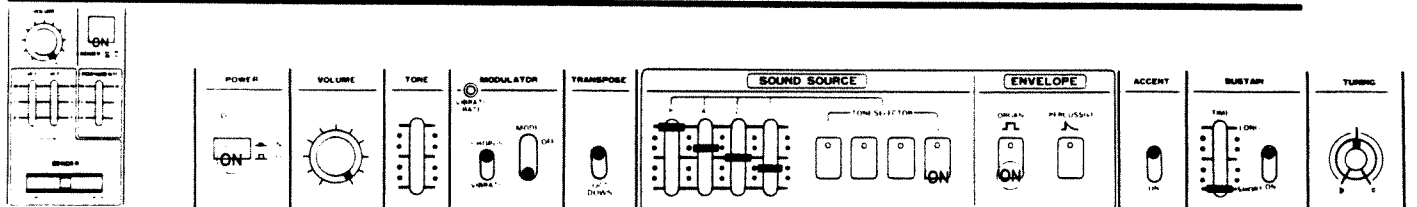

For true brass, switch SA-09 Chorus "Off"
For brighter brass, switch SA-09 Tone Selector to III.

Use reverb if available.
For lower pitches, switch SA-09 Transpose one Octave Down.

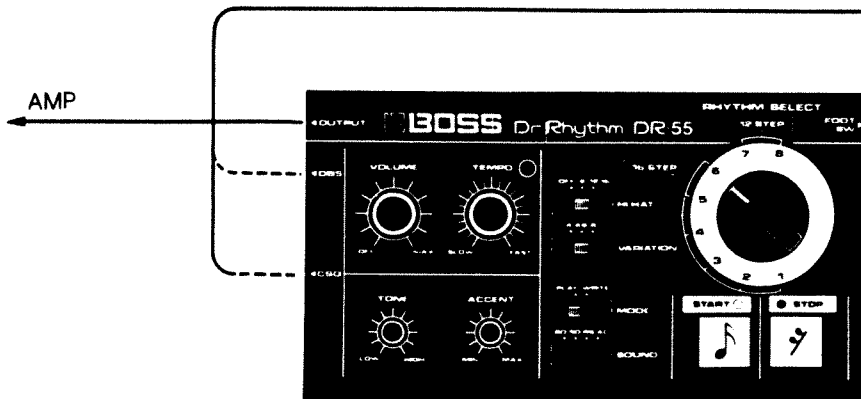
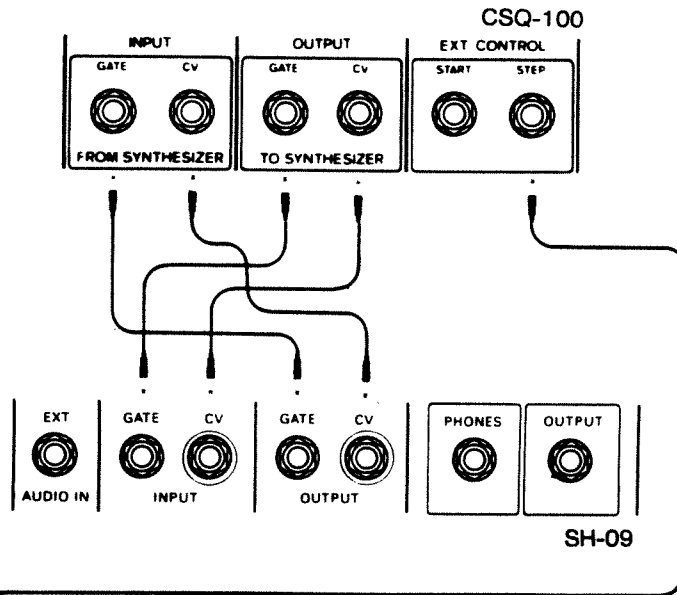
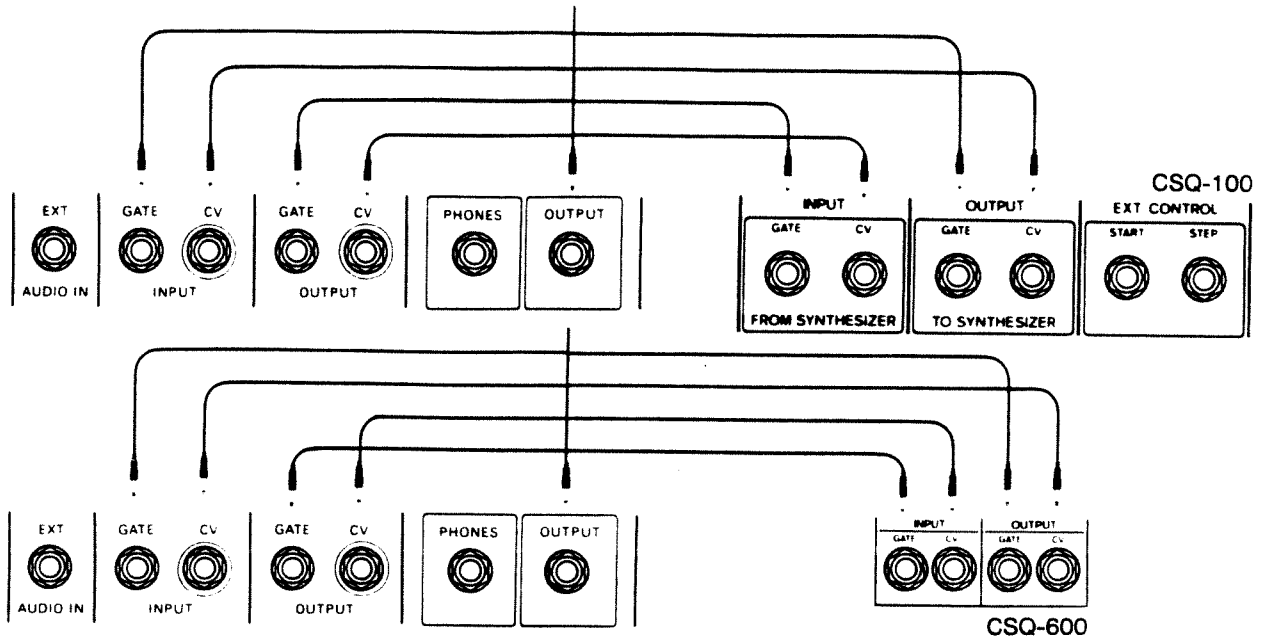

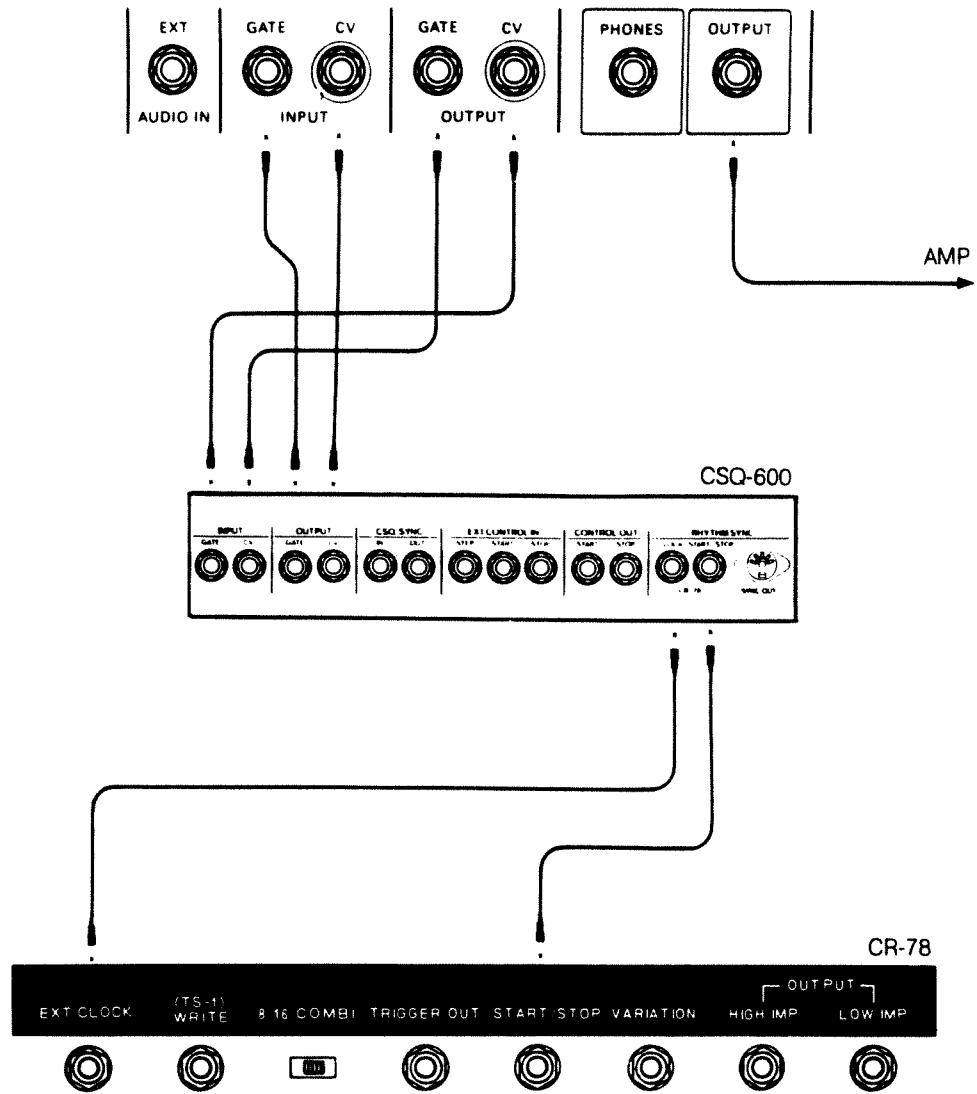

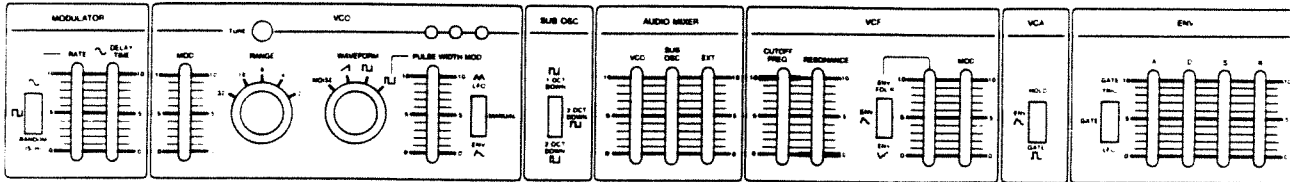
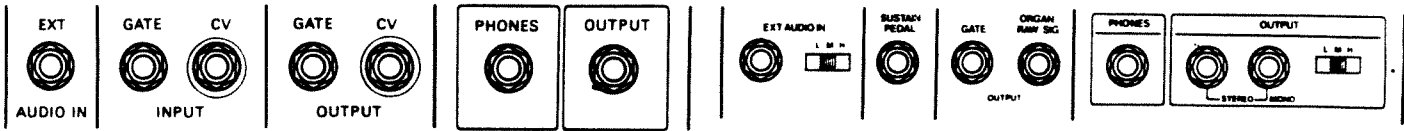

SYNTHESIZER 09 SH-09

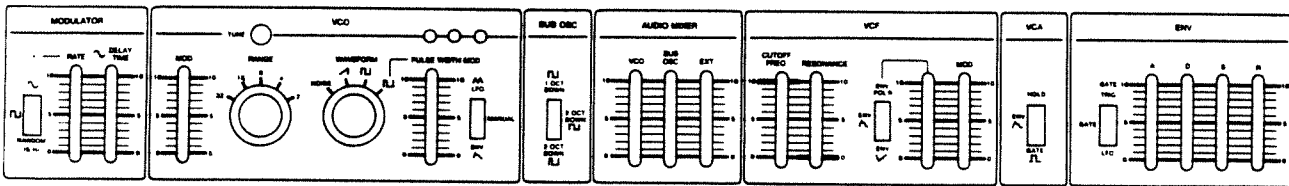
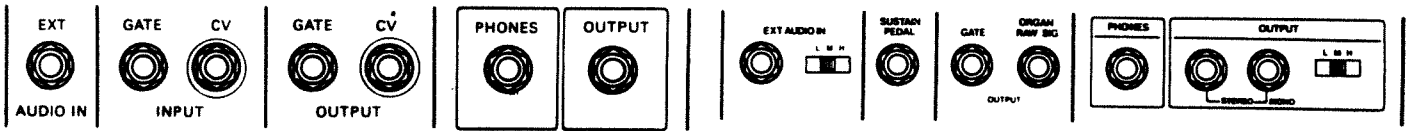
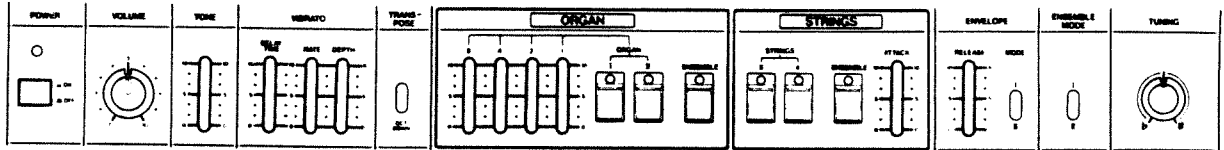
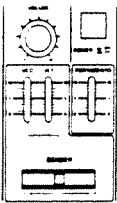

SYNTHESIZER 09 SH-09

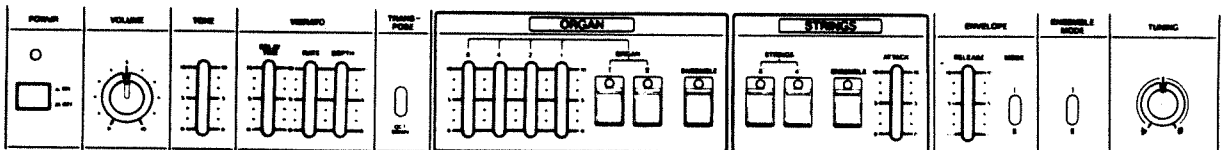
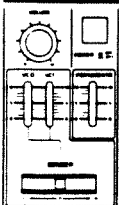

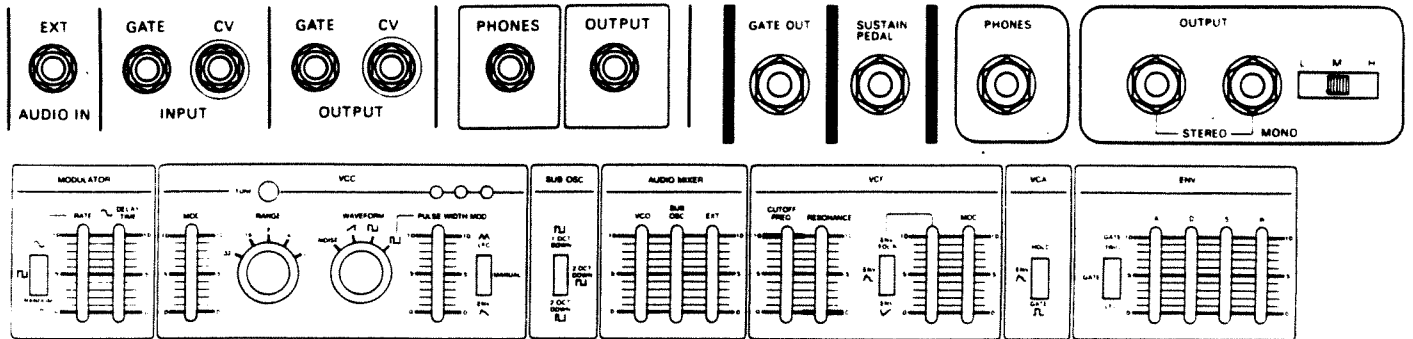

SYNTHESIZER 09 SH-09

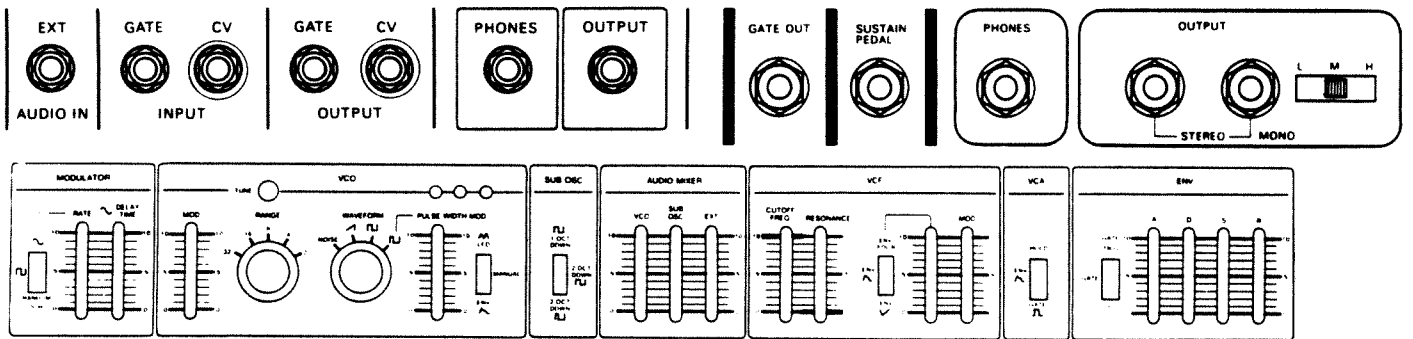
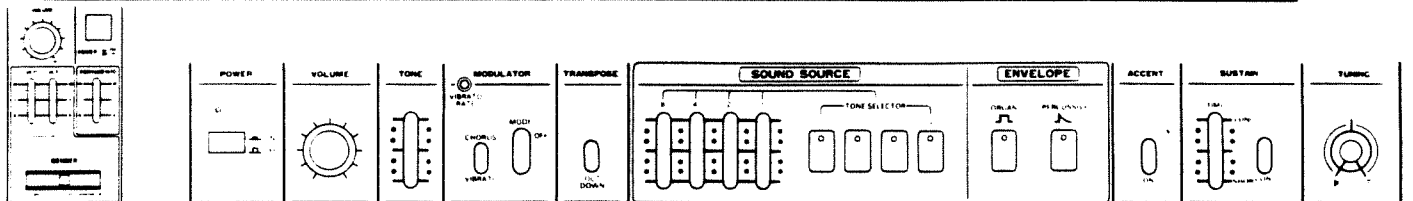

SYNTHESIZER 09 SH-09

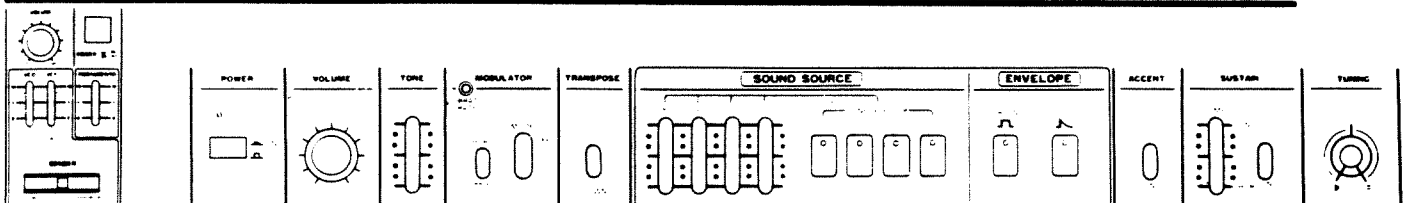

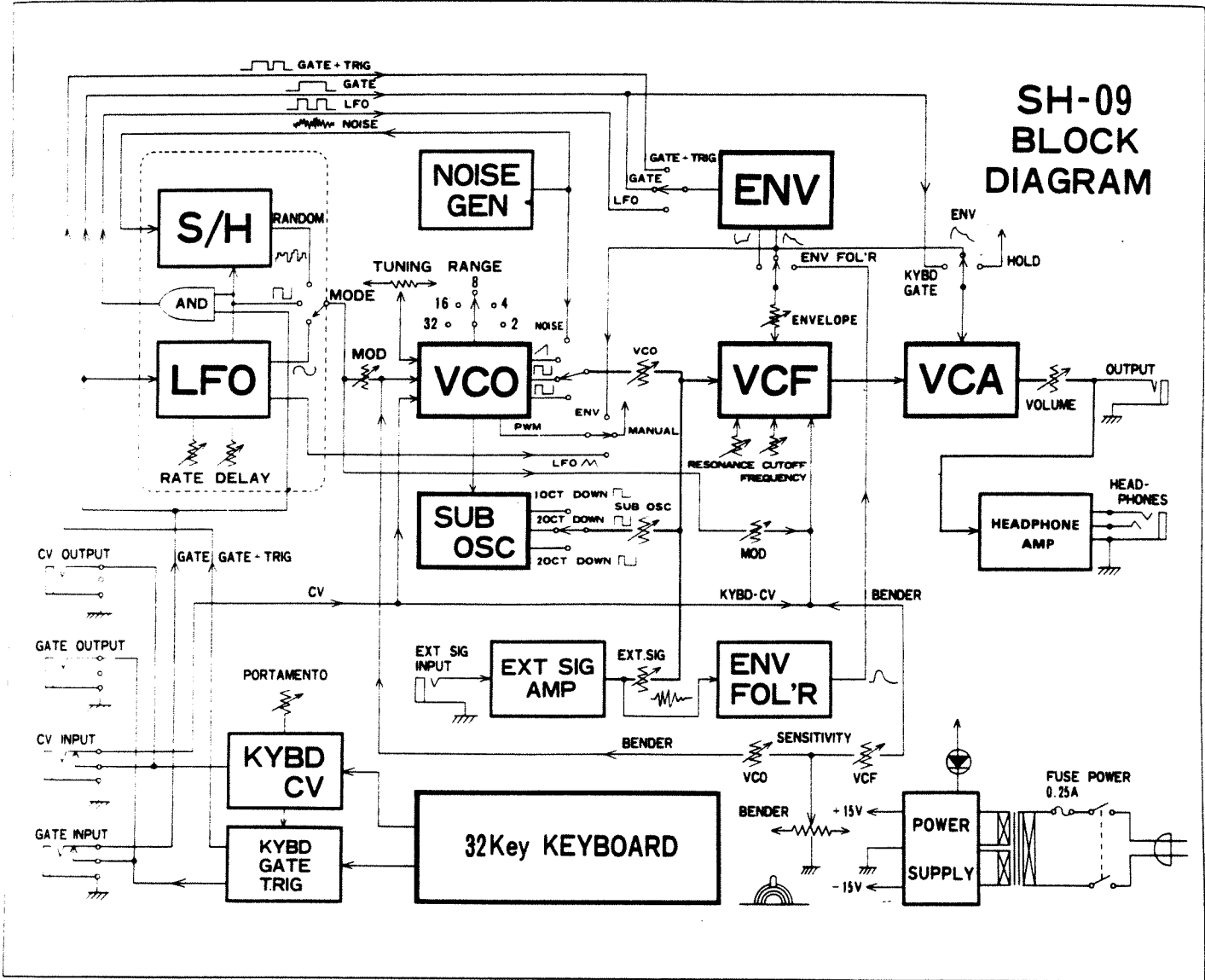



SH-09
BLOCK
DIAGRAM



SH-09 Specification

Keyboard 32 keys, 2-1/2 octaves

VCO
(Voltage Controlled Oscillator)



AUTO BEND
Modulation depth
Tune (± 65 cent)
Wave form (, , , NOISE)
Pulthwidth Modulation (Min-50%)
PWM Mode Switch (Env/Manual/LFO)

SUB OSC
(Sub-oscillator)



IOCT DOWN , 2OCT DOWN ,
2OCT DOWN 

AUDIO MIXER VCO/SUB OSC/EXT SIG

VCF
(Voltage Controlled Filter)

Cutoff Frequency Control
(10Hz - 20kHz)
Resonance (Min-Self Oscillation)
ENV Switch (ENV FOL'R, ENV , ENV )
ENV Control
MOD Control



VCA
(Voltage Controlled Amplifier)

Envelope Switch
(Hold, Env , Kybd gate )

ENVELOPE GENERATOR

Attack Time (1ms - 2.5s)
Decay Time (2ms - 10s)
Sustain Level (0 - 100%)
Release Time (2ms - 10s)
Gate Trigger Selector Switch
(Gate-Trig/Gate/LFO)

Modulator

Modulation Mode Switch
(Randum/ , )
Rate (0.2Hz - 25Hz)
Delay Time (0 - 1.5s)
Rate Indicator

PORTAMENTO (0 - 5s)

VOLUME

BENDER	Bender Lever Bender Sensitivity (VCO, VCF)
--------	--

POWER SWITCH	Power Indicator
--------------	-----------------

CONNECTION JACKS	Output Jacks Phones Jack (8 Ω Stereo) External Control Input Jack (1V/oct) External Gate Voltage Input Jack (ON with +7.5V or over) Keyboard Gate Output Jack (OFF-0V, ON-+14V) External Signal Input Jack
------------------	---

POWER CONSUMPTION	8W
-------------------	----

DIMENSIONS	605(w) x 305(d) x 100(h) mm
------------	-----------------------------

WEIGHT	6.1 kg
--------	--------

ACCESSORIES	2.5m connection cord
-------------	----------------------

Specifications are subject to change without notice.

OPTIONAL ACCESSORIES

CASE CB-100

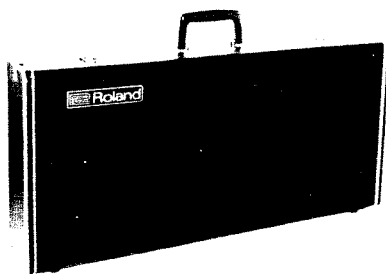

STAND KS-1

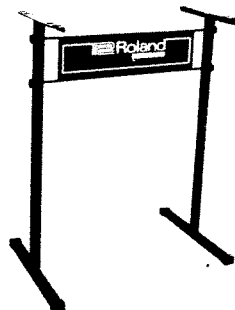

HEADPHONE RH-10



ORGAN/STRING RS-09

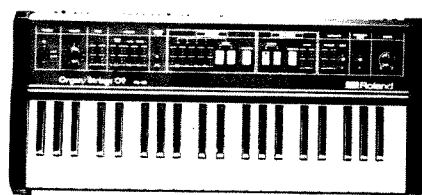

REVERB RV-100

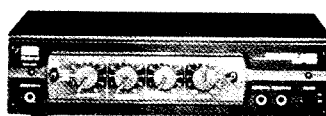

ECHO CHAMBER RE-150

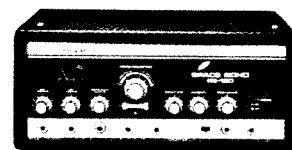

Roland®

10522

UPC

10522



12981

Roland®