

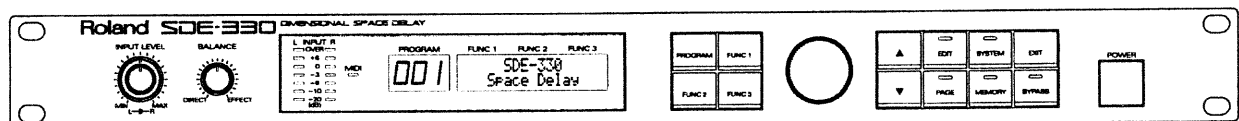

Roland

DIMENSIONAL SPACE DELAY

SDE-330

Owner's Manual



	CAUTION RISK OF ELECTRIC SHOCK DO NOT OPEN	
ATTENTION: RISQUE DE CHOC ELECTRIQUE NE PAS OUVRIIR		
CAUTION: TO REDUCE THE RISK OF ELECTRIC SHOCK, DO NOT REMOVE COVER (OR BACK). NO USER-SERVICEABLE PARTS INSIDE. REFER SERVICING TO QUALIFIED SERVICE PERSONNEL.		



The lightning flash with arrowhead symbol, within an equilateral triangle, is intended to alert the user to the presence of uninsulated "dangerous voltage" within the product's enclosure that may be of sufficient magnitude to constitute a risk of electric shock to persons.



The exclamation point within an equilateral triangle is intended to alert the user to the presence of important operating and maintenance (servicing) instructions in the literature accompanying the product.

INSTRUCTIONS PERTAINING TO A RISK OF FIRE, ELECTRIC SHOCK, OR INJURY TO PERSONS.

IMPORTANT SAFETY INSTRUCTIONS SAVE THESE INSTRUCTIONS

WARNING - When using electric products, basic precautions should always be followed, including the following:

1. Read all the instructions before using the product.
2. Do not use this product near water — for example, near a bathtub, washbowl, kitchen sink, in a wet basement, or near a swimming pool, or the like.
3. This product should be used only with a cart or stand that is recommended by the manufacturer.
4. This product, either alone or in combination with an amplifier and headphones or speakers, may be capable of producing sound levels that could cause permanent hearing loss. Do not operate for a long period of time at a high volume level or at a level that is uncomfortable. If you experience any hearing loss or ringing in the ears, you should consult an audiologist.
5. The product should be located so that its location or position does not interfere with its proper ventilation.
6. The product should be located away from heat sources such as radiators, heat registers, or other products that produce heat.
7. The product should be connected to a power supply only of the type described in the operating instructions or as marked on the product.
8. The power-supply cord of the product should be unplugged from the outlet when left unused for a long period of time.
9. Care should be taken so that objects do not fall and liquids are not spilled into the enclosure through openings.
10. The product should be serviced by qualified service personnel when:
 - A. The power-supply cord or the plug has been damaged; or
 - B. Objects have fallen, or liquid has been spilled onto the product; or
 - C. The product has been exposed to rain; or
 - D. The product does not appear to operate normally or exhibits a marked change in performance; or
 - E. The product has been dropped, or the enclosure damaged.
11. Do not attempt to service the product beyond that described in the user-maintenance instructions. All other servicing should be referred to qualified service personnel.

For the USA

This product may be equipped with a polarized line plug (one blade wider than the other) . This is a safety feature. If you are unable to insert the plug into the outlet, contact an electrician to replace your obsolete outlet. Do not defeat the safety purpose of the plug.

For Canada

For Polarized Line Plug

CAUTION: TO PREVENT ELECTRIC SHOCK, MATCH WIDE BLADE OF PLUG TO WIDE SLOT, FULLY INSERT.

ATTENTION: POUR ÉVITER LES CHOCS ÉLECTRIQUES, INTRODUIRE LA LAME LA PLUS LARGE DE LA FICHE DANS LA BORNE CORRESPONDANTE DE LA PRISE ET POUSSER JUSQU' AU FOND.

For the U.K.

WARNING: THE APPARATUS MUST BE EARTHED

IMPORTANT: THE WIRES IN THIS MAINS LEAD ARE COLOURED IN ACCORDANCE WITH THE FOLLOWING CODE.
GREEN-AND-YELLOW: EARTH, BLUE: NEUTRAL, BROWN: LIVE

As the colours of the wires in the mains lead of this apparatus may not correspond with the coloured markings identifying the terminals in your plug, proceed as follows:

The wire which is coloured GREEN-AND-YELLOW must be connected to the terminal in the plug which is marked by the letter E or by the safety earth symbol  or coloured GREEN or GREEN-AND YELLOW.

The wire which is coloured BLUE must be connected to the terminal which is marked with the letter N or coloured BLACK.

The wire which is coloured BROWN must be connected to the terminal which is marked with the letter L or coloured RED.

The product which is equipped with a THREE WIRE GROUNDING TYPE LINE PLUG must be grounded.

Thank you, and congratulations on your choice of the Roland SDE-330 Dimensional Space Delay. Before starting out, please take the time to read through this manual. Doing so will ensure proper operation and years of trouble-free service.

Features

•High Quality Effects

The effects produced by this unit can rival those of much costlier devices (often found in professional studios). This is because the SDE-330 uses 16-bit, 44.1 kHz digital processing, and was designed as a result of painstaking efforts directed at redefining and redeveloping all the essential features that a professional-quality, dedicated reverb should have.

•RSS Technology

The SDE-330 provides newly developed algorithms which can deliver effects that are quite revolutionary such as a delay which results in sounds that seem to fly around the listener. New effects such as these can be provided thanks to the technological expertise accumulated through Roland's development of the RSS (Roland Sound Space) system.

•Full Stereo Support

With every stereo algorithm, the internal processing of the left and right channels is done independently. This assures that every detail of spatial localization contained in the input signals is retained even after effects have been applied.

•Dedicated Effects

Provides a wide variation of algorithms that are ready for almost any situation where you may wish to use delay.

•Real-Time Parameter Control

The effects you obtain can easily and conveniently be altered while a performance takes place. Either pedals, or MIDI messages can be used to control specified parameters.

How To Use This Manual

This manual is broadly divided into four chapters. Together, they explain the available functions, and how they are used for everyday performance. Also provided are instructions on how to make all the possible settings. The Table of Contents should be referred to when necessary. In addition, an alphabetical index is provided at the back, making it convenient for you to look up any items you have trouble understanding while operating the unit.

** The separate "Algorithm Guide" provides detailed explanation of all the algorithms and the parameters that comprise them. Please refer to it when making settings for Effects Programs or Control Assign.*

Chapter contents:

CHAPTER I : PRODUCING SOUND

This chapter explains how to connect the unit with your other equipment, how to select effects, and most of the other basic procedures you need to know.

CHAPTER II : EDITING EFFECTS PROGRAMS

This chapter explains how to edit the settings for effects stored in 'Program Numbers' in memory, and alter settings for Control Assign and the Effect Name.

CHAPTER III : USING MIDI

This chapter explains how to use an external MIDI device to change and control the SDE-330's effects, and other information about MIDI functions.

CHAPTER IV : REFERENCE

This chapter lists the factory default settings, and contains useful information about what to do when the unit is not responding as expected.

CONTENTS

IMPORTANT NOTES	5
PANEL DESCRIPTIONS	6
Chapter I : PRODUCING SOUND	
Making the Connections	8
Setup Using a Mixer's Send/Return	8
Setup Using a Keyboard	8
Setup Using Pedals	9
Turning ON Power — Standby	10
Selecting Effects Programs	11
Turning Bypass ON/OFF	12
Choosing What Is Shown In the Display	13
Chapter II : EDITING EFFECTS PROGRAMS	
Before Beginning to Create Your Own Effects	16
User Area and Preset Area	16
Programmable Functions	16
Procedure for Sound Creation	16
Making Settings for the Effects	17
Making Settings for Control Assign	20
Setting the Effect Name	25
Selecting Parameters Displayed in Top Screen	28
Altering the Order Parameters Are Displayed	30
Comparing Sounds	32
Storing Edited Changes (Write Procedure)	33
Making Copies	34
System Function Settings	35
Chapter III : USING MIDI	
MIDI Applications	38
About the MIDI Indicator	38
MIDI System Function Settings	39
MIDI Program Change Map Settings	42
MIDI Data Transfer	43
Chapter IV : REFERENCE	
The Exchange of MIDI Data	48
Troubleshooting	51
Error Messages	52
Restoring the Factory Default Settings (Initialization)	53
MIDI Implementation Chart	54
Specifications	55
Index	56

IMPORTANT NOTES

In addition to the items listed under Safety Precautions on page 2, please read and adhere to the following:

(Power Supply)

- When making any connections with other devices, always turn off the power to all equipment first; this will help prevent damage or malfunction.
- Do not use this unit on the same power circuit with any device that will generate line noise, such as a motor or variable lighting system.

(Placement)

- Using the unit near power amplifiers (or other equipment containing large transformers) may induce hum.
- This unit may interfere with radio and television reception. Do not use this unit in the vicinity of such receivers.

(Maintenance)

- For everyday cleaning wipe the unit with a soft, dry cloth (or one that has been slightly dampened with water). To remove stubborn dirt, use a mild neutral detergent. Afterwards, be sure to wipe the unit thoroughly with a soft, dry cloth.
- Never use benzene, thinners, alcohol or solvents of any kind, to avoid the risk of discoloration and/or deformation.

(Memory Backup)

- The unit contains a battery which maintains the contents of memory while the main power is off. The expected life of this battery is 5 years or more. However, to avoid the unexpected loss of memory data, it is strongly recommended that you change the battery every 5 years.
Please be aware that the actual life of the battery will depend on the physical environment (especially temperature) in which the unit is used. When it is time to change the battery, consult with qualified service personnel.

- When the battery becomes weak, the following message will appear in the display. Please change the battery as soon as possible to avoid the loss of memory data.

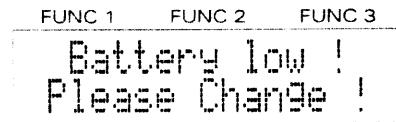

- Please be aware that the contents of memory may at times be lost; when the unit is sent for repairs or when by some chance a malfunction has occurred. Important data should be stored in another MIDI device (eg. a sequencer), or settings written down on paper. During repairs, due care is taken to avoid the loss of data. However, in certain cases (such as when circuitry related to memory itself is out of order), we regret that it may be impossible to restore the data.

(Additional Precautions)

- Protect the unit from strong impact.
- Never strike or apply strong pressure to the display.
- A small amount of heat will radiate from the unit during normal operation.
- Before using the unit in a foreign country, consult with qualified service personnel.

PANEL DESCRIPTIONS

Front Panel

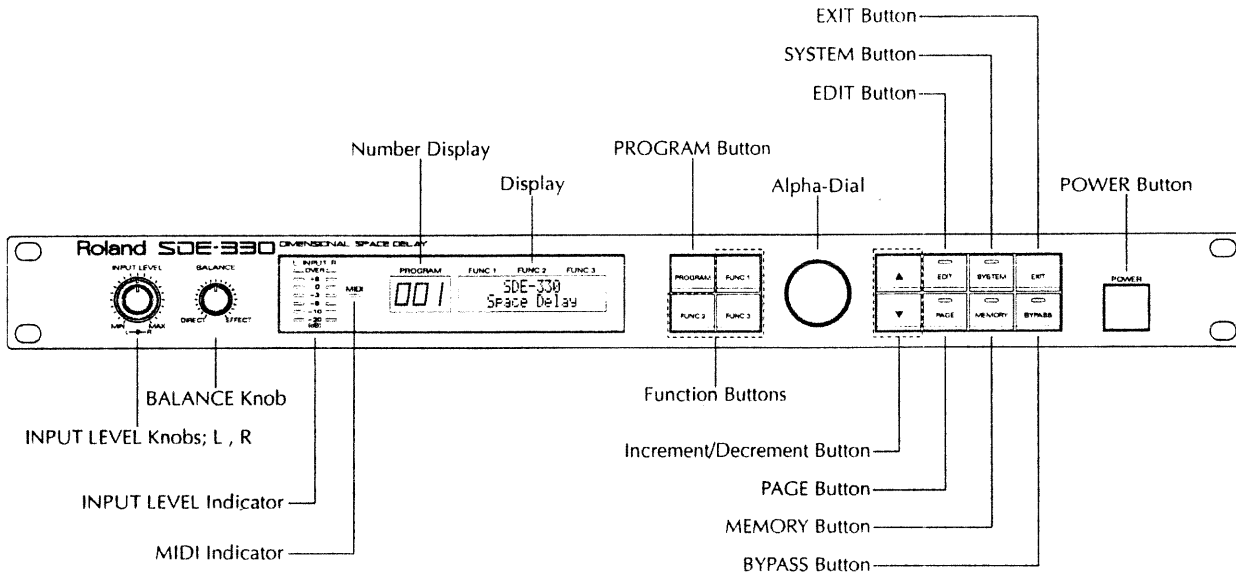

Rear Panel

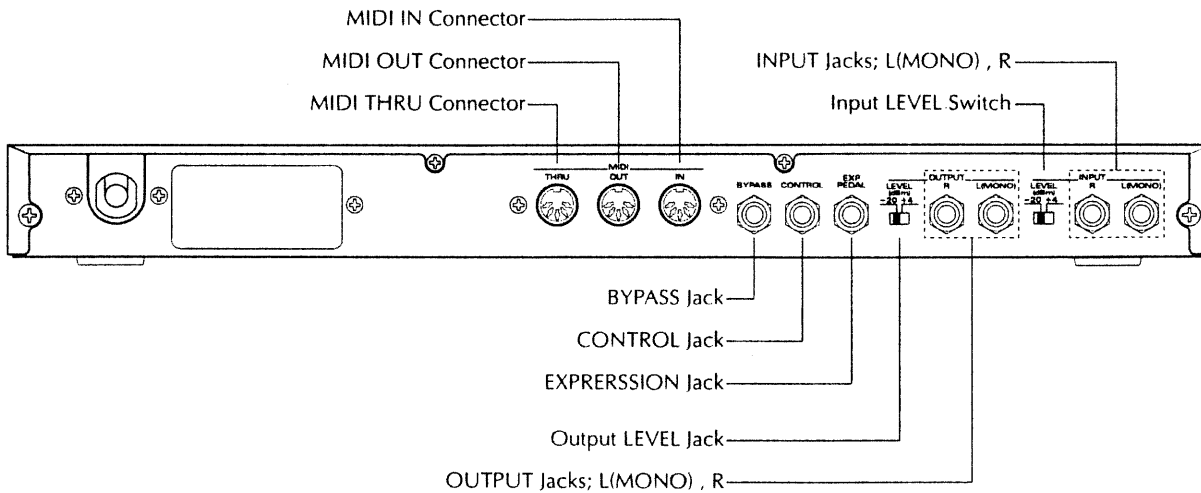

Chapter 1

PRODUCING SOUND

Making the Connections

Make the connections following one of the examples below, depending on the application you have in mind.

** Always have the volume on your amplifier turned down, and make sure power to all devices is OFF before inserting or pulling out any cords. If you attempt to make connections while power is ON, damage or malfunction could result.*

** When connecting monaural devices, use the L (MONO) jack.*

Setup Using a Mixer's Send/Return

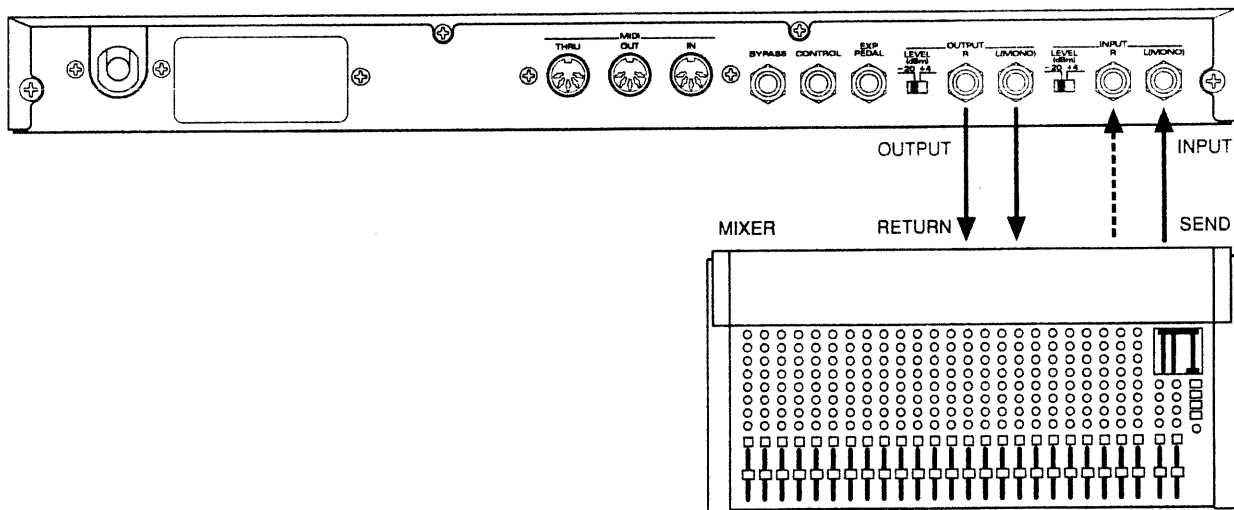

** The Level Switch settings on the SDE-330 and mixer must match.*

Setup Using a Keyboard

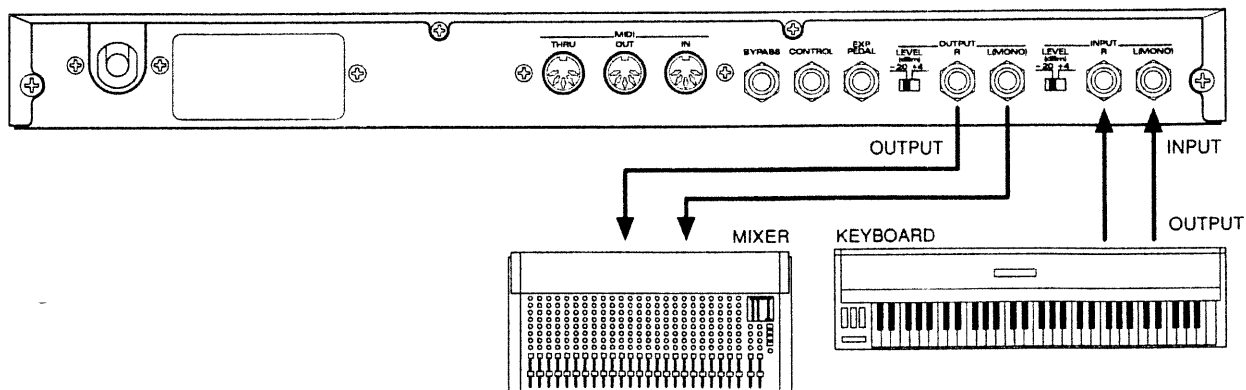

** Ordinarily, the Level Switch should be set at -20 dBm.*

Setup Using Pedals

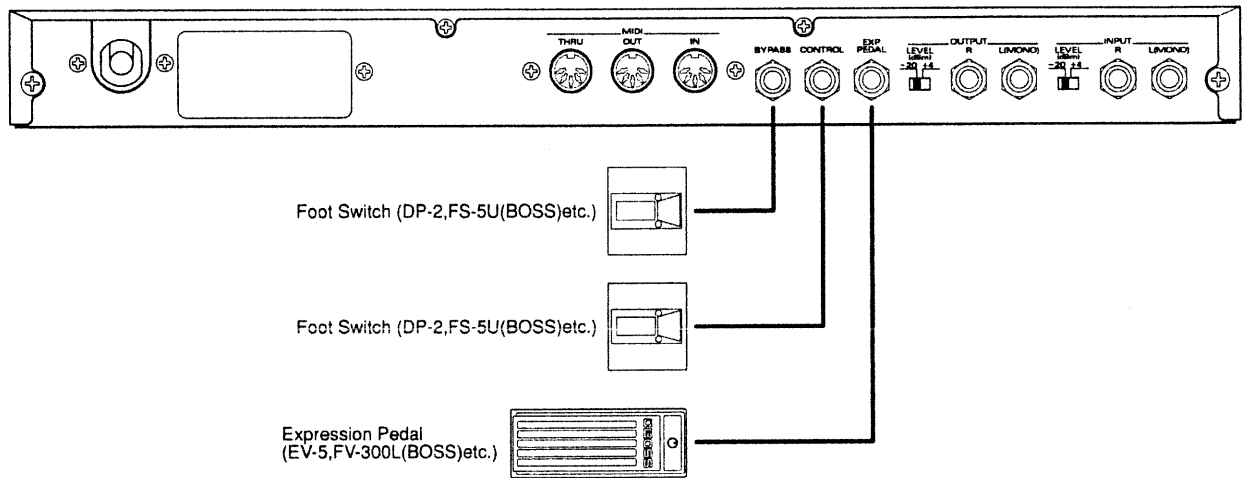

* When connecting an (optional) expression pedal to the EXP. PEDAL jack, set the pedal's "minimum volume" to the lowest setting possible.

* When connecting a BOSS FS-5U to the CONTROL and BYPASS jacks, set the polarity switch on the pedal as shown below:

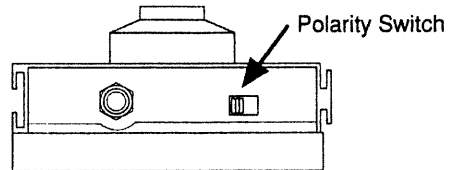

Turning ON Power — Standby

Turn ON Power

Once you are sure all connections with external units have been made properly, turn the SDE-330 ON.

The following displays will appear as the Play Mode is selected:

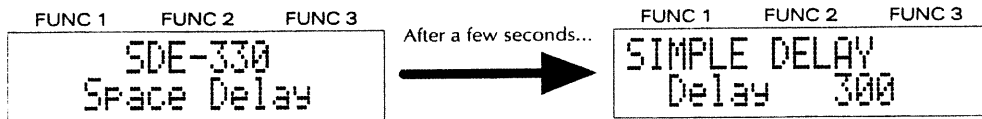

- * The volume on your amplifier should be raised only after the power on every connected unit has been turned on.
- * The SDE-330 is equipped with a circuit protection device. A brief interval after power up is required before the unit will operate.
- * Each time power is turned on, the Program Number that was last selected will be selected again.
- * If the unit's display is difficult to read, adjust the contrast (p. 36).

Adjusting the Input Level

Use the Input Level knob to adjust the level of the input signals. You will know you have the correct level if the "OVER" segments of the level meter do not light (even at the moments of peak input).

- * The Input Level can be set independently for the left and right channels.

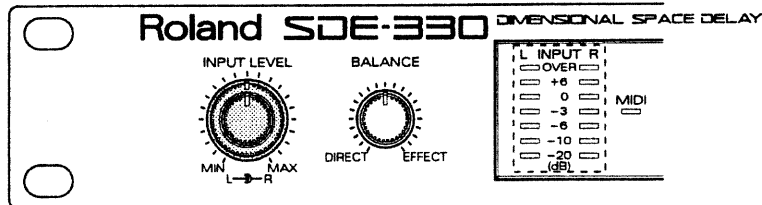

CAUTION: Distortion may be produced if the "OVER" segments of the level meter light.

Adjusting the Balance for Direct/Effect Sounds

To obtain the desired sound, use the Balance knob to adjust the amount of direct signal in relation to the effect sound.

By rotating the knob to either the left or right extremes, you can choose to have only the direct, or only the effect sound output.

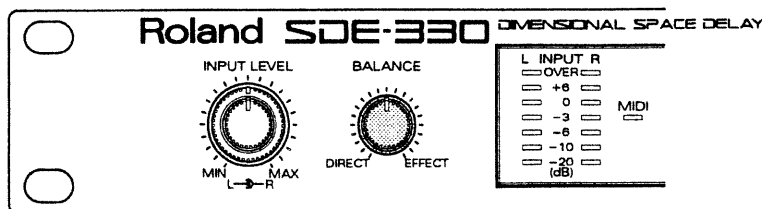

Selecting Effects Programs

All the Effects Programs are contained within their own storage location, each of which is given a 'Program Number.' Whenever you need to switch to a specific Effects Program, you use the panel to specify the Program Number.

* You can also use an external MIDI device to switch Effects Programs. For details, refer to "Switching Program Numbers" (p. 38).

Switching Effects Programs from the Panel

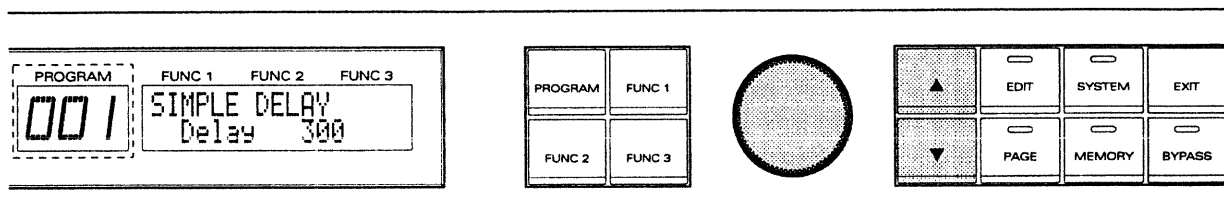

Select the Program Number by rotating the ALPHA DIAL.

The [▲] and [▼] buttons can also be used to select the Program Number. Each press of [▲] increases the Program Number by one. Similarly, each press of [▼] decreases the Program Number by one. Hold down either [▲] or [▼] while you press the other button to obtain a more rapid change in the number.

The currently selected Program Number will be shown in the PROGRAM display.

Turning Bypass ON/OFF

When you wish to have only the direct sound output, turn Bypass ON. Bypass can be turned ON/OFF either from the panel, or using a pedal.

* By turning Bypass ON, the direct sound will be output even if you have the Balance knob set so only the effect sound is to be output.

* The Bypass function can be changed to work as a Mute ON/OFF control if required. For details, refer to "Function Selection for Bypass" (p. 36).

Switching From the Panel

Bypass is turned ON and OFF by pressing the panel's BYPASS button. Bypass is ON when the button's indicator is lit.

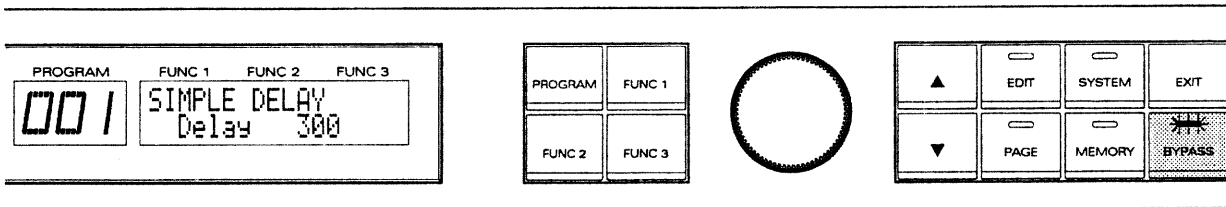

Switching By Means of a Pedal

After you have connected a pedal switch (optional DP-2, or FS-5U; BOSS) Bypass can be turned ON and OFF with the pedal.

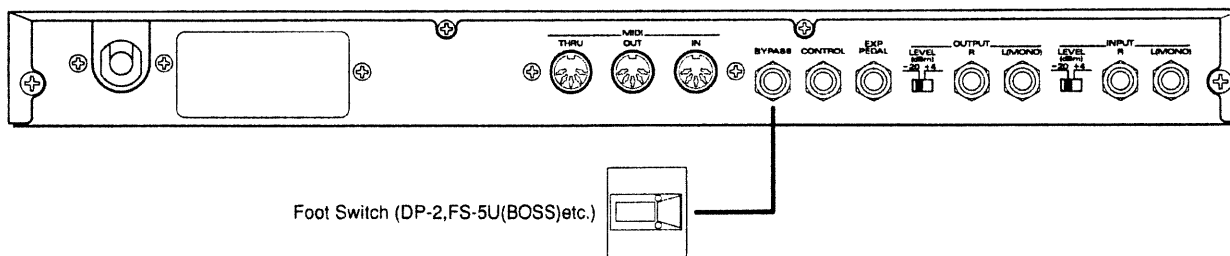

* When using an FS-5U (BOSS) the polarity switch should be set as shown below:

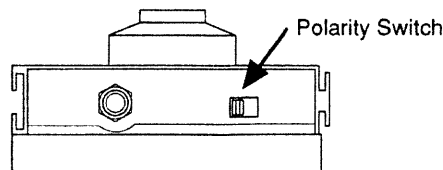

Choosing What Is Shown In the Display

The SDE-330 allows you to select the type of information you wish to have displayed (along with the name of the currently selected Effects Program) while in the Play mode. The two choices are as follows:

Specified Parameter Name and Value of Setting:

With this setting, the names of the parameters (and values) that have been specified for each of the Program Numbers will be shown in the display. This allows you to distinguish among Program Numbers even if they have been given the same Effects name.

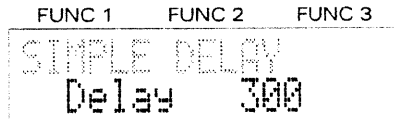

* To select the parameters that will be displayed, refer to "Selecting Parameters Displayed in Top Screen" (p. 28).

Algorithm Number:

The algorithm number (and type) being used is displayed.

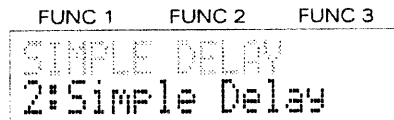

(PROCEDURE)

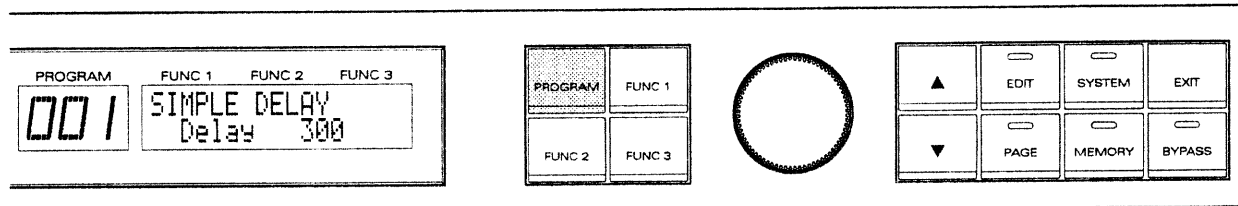

You can switch between the two choices by pressing [PROGRAM] while in the Play mode.

MEMO

Chapter II

EDITING EFFECTS PROGRAMS

Before Beginning to Create Your Own Effects

The following explains some of the basics you should know before you begin creating your own Effects Programs.

User Area and Preset Area

The 300 Program numbers of the SDE-330 are divided into two areas; User Area and Preset Area.

User Area (Program Numbers 1—200):

The Program Numbers in the User Area can be used to store effects you create.

Preset Area (Program Numbers 201—300):

The Program Numbers in the Preset Area contain preprogrammed effect sounds. Effects you create cannot be stored here. However, you can copy an effect from the Preset Area into the User Area and then edit it.

Programmable Functions

The Program Numbers in the User Area can contain the following data:

- Effect Sounds (the relevant parameters will differ depending on the algorithm)
- Control Assign (3 types: settings for these are made when you wish to use a pedal connected to the SDE-330, or an external MIDI device to control parameters.)
- Effect Name
- Parameters displayed on the top line of the display
- Order in which parameters are displayed

What is an Algorithm?

An algorithm is a unit which contains information that decides which effectors are to be used, and provides a configuration for all the parameters (basic elements) that go toward creating a desired effect. A selection of 19 such algorithms are contained in the SDE-330.

Since each algorithm was carefully designed for a practical musical situation, with settings that have proved to be the most effective, they can save you a lot of time and effort when creating the effects you need.

Procedure for Sound Creation

First of all, select the Program Number that is similar to the effect sound you wish to create. Next, determine the algorithm type and the parameters used in the effect sound, using the "Algorithm Guide." Next, edit the parameters as you listen to the sound. Store the finished effect in a Program Number in the User Area using the Write procedure. (Note that this will automatically erase any data previously stored in that Program Number.)

- * *All changes made in settings are only temporary. They will revert to their original values if you turn the power off, switch to a different Program Number or switch to the Play mode. In order to make your changes permanent, you must perform the 'Write Procedure' ('Write Procedure,' p. 33), and store the effect in memory.*
- * *When you purchase the SDE-330, the effect sounds from the Preset Area have initially been written into the User Area. You can write your original sound in any Program Number in the User Area.*

Making Settings for the Effects

Although the types of parameters that are provided (and the way they are organized) can vary considerably depending on the algorithm, the basic procedures that you should follow when creating sounds are the same. The following explains how to make settings for the parameters.

** For information on the content of each of the algorithms (and how their parameters work) refer to the "Algorithm Guide."*

(PROCEDURE)

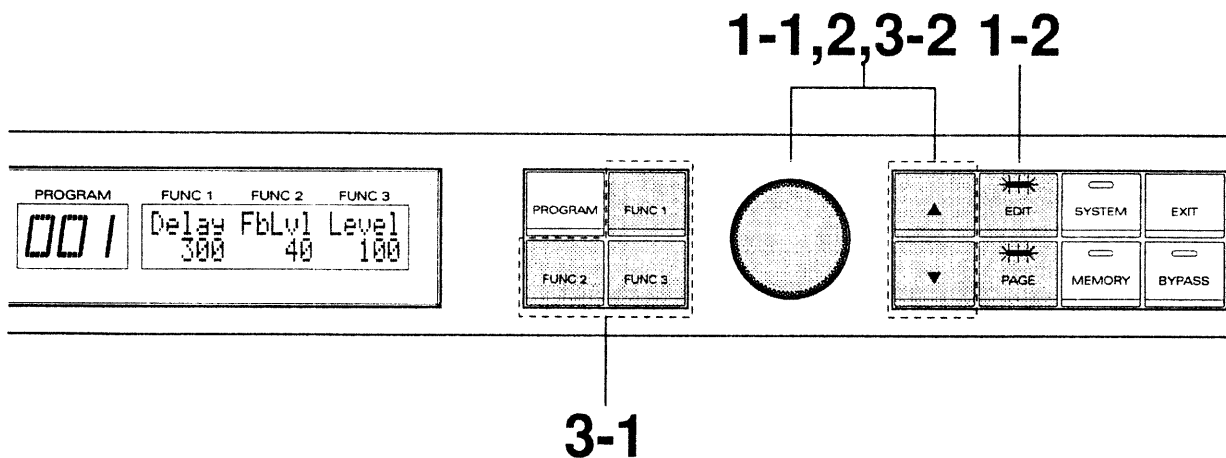

1. Get into the Parameter Edit mode.

Once in the Parameter Edit mode, you will be able to make changes in the contents that are stored at each Program Number.

** This step is, of course, unnecessary if you are already in the Parameter Edit mode (making Control Assign settings, etc.).*

- 1-1. Select the Program Number (algorithm) that you are going to use as the basis for your new sound.
- 1-2. Press [EDIT].

The indicators on both the EDIT and PAGE buttons will light, showing that you are in the Parameter Edit mode.

(If Memory Protect is ON)

When Memory Protect is ON, it protects the current settings you have stored from being lost. For this reason, you cannot write anything new into memory. If you press [EDIT] while Memory Protect is ON, the indicator on the EDIT button will begin to flash, and the message below will appear in the display:

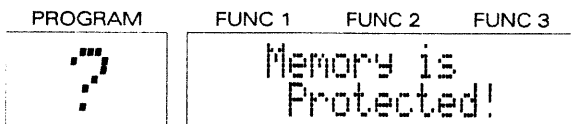

If you wish to store the setting changes you have made, you need to first press [EXIT] to quit editing, then turn Memory Protect OFF. For details, refer to "Memory Protect" (p. 36).

If don't intend to store your changes in memory, you can simply go ahead by pressing [EDIT] again. You then will be in the Parameter Edit mode. In this case you will need to press [EXIT] when you're through editing.

If you attempt to perform a Write while Memory Protect is ON, the message shown above will appear in the display.

2. Select the parameter you wish to change.

** This step is, of course, not necessary if the parameter is already selected.*

Select the parameter you wish to make changes in using the ALPHA DIAL or the [▲] / [▼] buttons.

(NOTE)

When selecting parameters using the ALPHA DIAL:
Parameters are displayed one at a time while being scrolled horizontally across the screen.

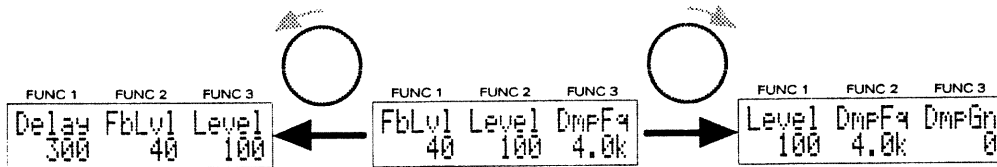

When selecting parameters using [▲] / [▼]:
Three parameters are shown at one time.

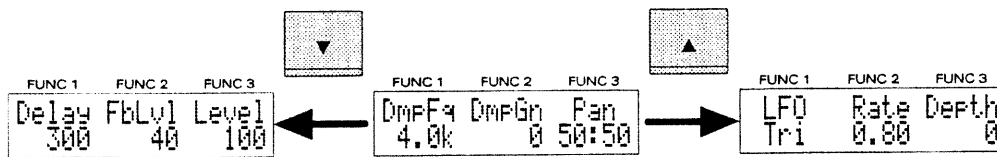

3. Make the changes in the value of the parameter.

3-1. Use [FUNC 1-3] to select the parameter you wish to change.

The indicator on the PAGE button will go out, and the parameter name will start flashing. Changes can now be made in the value of the parameter.

(NOTE)

For example, with the setting for the Delay Time (as shown below), you would press [FUNC 1]. Depending on the position (as shown in the display) of the parameter you wish to set, you need to press the appropriate function button.



** If you wish to see the Effector Name and Parameter Name of the parameter currently selected, as shown below, press [FUNC 1-3] again. To retrieve the previous display, press [EXIT].*

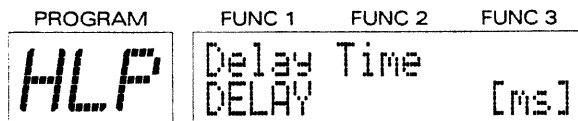

3-2. Set the new value by rotating the ALPHA DIAL.

The [▲] and [▼] buttons can also be used to change the value. Press [▲] to increase the value, and [▼] to decrease it. Hold down either [▲] or [▼] while you press the other button to obtain a more rapid change in the value.

3-3. If you wish to change the values for any of the other parameters that appear in the display, repeat Steps 3-1 and 3-2.

If you wish to set other parameters that are not displayed, press the PAGE button (to turn the indicator on), and then go back to Step 2 and start again from there.

(NOTE)

Depending on whether the indicator on the PAGE button is lit or not, the changes obtained using the ALPHA DIAL or [▲] and [▼] buttons will be different:

When the indicator is lit:

Changes in the page (parameters) are made. Every item in the display is lit.

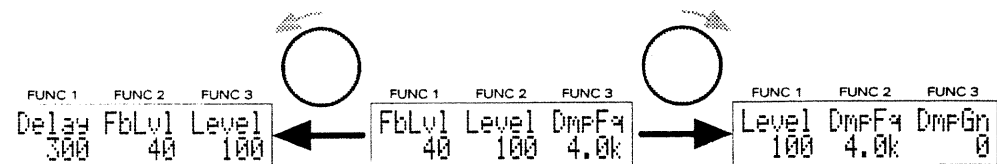

When the indicator is dark:

Changes in the value are made. The name of the specific parameter that can have its value changed (by rotating the ALPHA DIAL or pressing the [▲] and [▼] buttons) will be flashing.

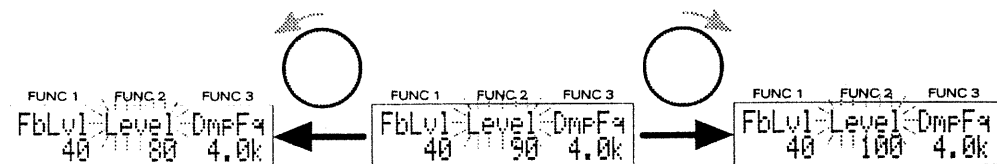

4. When Finished Making Settings

Should you wish to continue, and make settings for other items (Control Assign, Name, etc.), select each item as required. For details about how to make specific settings, refer to the section explaining the particular item.

If you wish to store your new settings in memory, carry out the Write Procedure (p. 33).

(To Cancel Settings You Have Made)

While in the process of making setting changes, you can always decide to cancel everything you have done up to that point by pressing [EXIT]. This will take you back to the mode you were in originally (the indicator on the EDIT button will be flashing).

At this point, if you are sure you do not need any of the settings changes you were making, you can press [EXIT] again. The indicator on the EDIT button will go out, and all your temporarily revised settings will be discarded. (Note that switching to a different Program Number is viewed as an “exit” as well, so your settings will be discarded even without pressing [EXIT] the second time.)

If you still haven’t pressed [EXIT] (the indicator on the EDIT button is still flashing), you can go back again and continue with your revisions by pressing [EDIT]. The indicator on the EDIT button will light, and you will be back where you were before pressing the EXIT button.

Making Settings for Control Assign

Settings for Control Assign are made when you wish to use a pedal connected to the SDE-330, or an external MIDI device, to control parameter settings. Control Assign settings are concerned with which controllers are to be used to control which parameters. Up to 3 of these assignments (Assign Numbers 1—3) can be made for each Program Number.

* The page in which settings for Control Assign are made is located within the [CTL] parameters. To call up this page, refer to "Making Settings," P.22.

Pedal Switch Setting

This setting allows you to select what kind of change in the value will occur as a result of the pedal action. (When using a momentary-type pedal switch (such as the DP-2 or BOSS FS-5U) connected to the CONTROL jack.)

FUNC 1	FUNC 2	FUNC 3
SwMod	C1Src	C1Tr9
NORML	ExpPd1	OutLv

Ordinarily the value will be at its minimum. When the pedal is depressed, the value goes to the maximum.

FUNC 1	FUNC 2	FUNC 3
SwMod	C1Src	C1Tr9
TOGGL	ExpPd1	OutLv

With each press of the pedal, you can switch between the minimum and maximum values.

- * If the pedal switch is of the latch type, set it to "NORML(Normal)."
- * If you haven't made any setting which specifies that a pedal switch is to be used as a controller, it does not matter whether you have "MOMENTARY" or "LATCH" selected.

Source: Controllers which can be specified.

The controllers listed below can be used to control parameters.

FUNC 1	FUNC 2	FUNC 3
SwMod	C1Src	C1Tr9
NORML	ExpPd1	OutLv

An expression pedal connected to the EXP. PEDAL jack (such as an optional EV-5 or FV-300L (BOSS) + PCS-33)

FUNC 1	FUNC 2	FUNC 3
SwMod	C1Src	C1Tr9
NORML	Ct1SW	OutLv

A pedal switch connected to the CONTROL jack (such as an optional DP-2, FS-5U or FS-5L (BOSS)).

FUNC 1	FUNC 2	FUNC 3
SwMod	C1Src	C1Tr9
NORML	PtBnd	OutLv

Pitch Bend messages received from an external MIDI device: Action of a Pitch Bend Lever (Wheel).

FUNC 1	FUNC 2	FUNC 3
SwMod	C1Src	C1Tr9
NORML	AfTch	OutLv

Aftertouch messages received from an external MIDI device: Pressure applied to keyboard keys.

FUNC 1	FUNC 2	FUNC 3
EuMod	C1Src	C1Tr9
NORML	Note#	OutLv

Note Number messages received from an external MIDI device: Location of keys pressed on a keyboard.

FUNC 1	FUNC 2	FUNC 3
SuMod	C1Src	C1Tr9
NORML	Veloc	OutLv

Velocity messages received from an external MIDI device: Force applied to keyboard keys.

FUNC 1	FUNC 2	FUNC 3
SuMod	C1Src	C1Tr9
NORML	C#008	OutLv

Control Change messages received from an external MIDI device (0—31, 64—95): Operations performed using sliders, pedals, etc.

FUNC 1	FUNC 2	FUNC 3
SuMod	C1Src	C1Tr9
NORML	...	OutLv

No controller: Values will not be altered under the control of an external device.

* Note that if you do not intend to use any of the 3 assignments that can be made for each Program Number, you must set such unused control numbers to "No Controller" (indicated in the display as "...").

* For details about MIDI messages, refer to "About MIDI" (p. 48).

Target: Parameter to be controlled.

All of the parameters that make up an algorithm, and Bypass ON/OFF can be controlled.

FUNC 1	FUNC 2	FUNC 3
C1Src	C1Tr9	C1Min
ExPd1	OutLv	0

All of the parameters that make up an algorithm.

FUNC 1	FUNC 2	FUNC 3
C1Src	C1Tr9	C1Min
ExPd1	BYPAS	OFF

Bypass ON/OFF

* Although you can use a multiple number of controllers to control the same target, you must avoid instances where controllers are operated at the same time (and simultaneous requests for changes in the parameter occur). This could cause noise to be produced.

(NOTE)

Whenever you switch to a Program Number that carries control assignments, the normal effect sound (that which is not affected by the control assignments) will be produced initially. The effect sound will reflect the operations of the controllers after they have been operated, and their data has arrived at the SDE-330.

Value Range

Parameters which have been targeted by Control Assign settings will have their values changed within a range that is set in terms of "Minimum Value" and "Maximum Value" settings made on the SDE-330.

When using controllers (such as a foot switch) which turn something On/Off, OFF (CLOSED) results in the minimum value, and ON (OPEN) produces the maximum value.

With controllers (such as an expression pedal or a pitch bend lever) that produce continuous changes, the parameter value will change incrementally within the range delimited by the "Minimum Value" and "Maximum Value."

In cases where the parameter value acts simply as an ON/OFF switch, the function is turned ON if the value of the data received is greater than the median value; otherwise it is turned OFF.

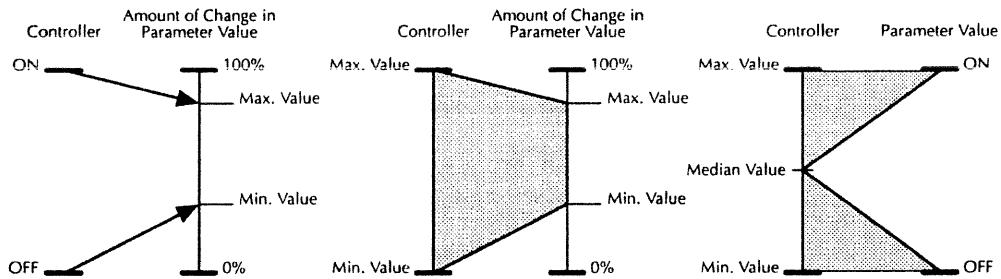

- * If you change the target after the settings for "Minimum Value" and "Maximum Value" have been made, you may find that these values have changed. To avoid problems, always redo the settings for "Minimum Value" and "Maximum Value" each time you select a new target.
- * If you set a "Minimum Value" that is higher than the "Maximum Value," the changes in the parameter occur in the opposite direction.
- * Any alterations made in parameter values during performance are temporary. If you change to a different Program Number, the settings will revert to their original values.

(Making Settings)

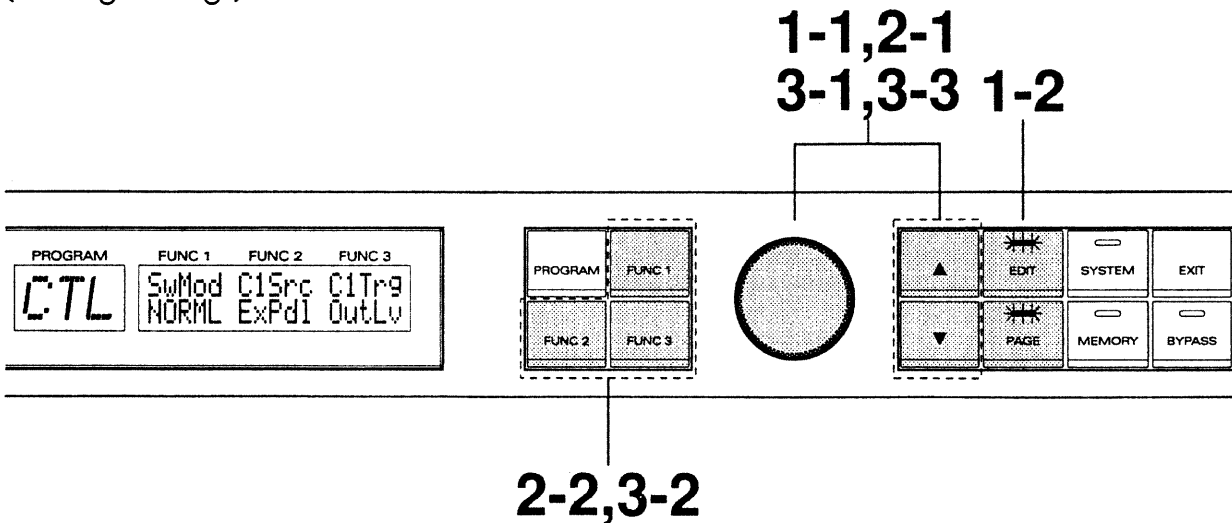

1. Get into the Parameter Edit mode.

Once in the Parameter Edit mode, you will be able to make changes in the contents that are stored at each Program Number.

** This step is, of course, unnecessary if you are already in the Parameter Edit mode (you were previously making settings for Effects Programs, etc.).*

- 1-1. Select the Program Number (algorithm) for which you wish to make Control Assign settings.
- 1-2. Press [EDIT].
The indicators on the EDIT button and PAGE button will light, showing that you are in the Parameter Edit mode.

2. Select the parameter you wish to target for control assignment.

** This step is, of course, not necessary if the parameter is already selected.*

- 2-1. Get the parameter shown below to appear in the display using the ALPHA DIAL or [▲] / [▼].



- 2-2. Use [FUNC 1-3] to select the [CTL].
The indicator on the PAGE button will blink, and display will show the Control Assign page.

3. Make the changes in the value.

- 3-1. Get the parameter shown below to appear in the display using the ALPHA DIAL or [▲] / [▼].

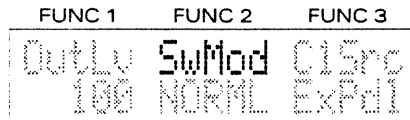

Setting for action obtained with Pedal Switch



Source: controllers which can be specified



Target: parameter which is to be controlled

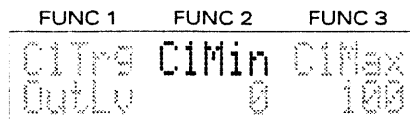

Range of change in values (min. value)



Range of change in values (max. value)

- 3-2. Use [FUNC 1-3] to select the parameter you wish to change.
The indicator on the PAGE button will go out, and the parameter name will start flashing. This means that changes in the setting can now be made.
- 3-3. Change the setting using the ALPHA DIAL or [▲] / [▼].
- 3-4. If you wish to make settings for any of the other parameters that appear in the display, repeat Steps 3-2 and 3-3.
If you wish to set other parameters that are not displayed, press the PAGE button (so the button indicator flashes), and then go back to Step 3-1 and start again from there.

4. When Finished Making Settings

Press [PAGE] to exit the Control Assign page. You will then be in the mode where parameters can be selected.

Should you wish to continue, and make settings for other items (Parameter settings, Name, etc.) select each as required. For details about how to make specific settings, refer to the section explaining the particular item.

If you wish to have your setting changes stored in memory, carry out the Write Procedure (p.33).

Setting the Effect Name

A name of up to 17 characters can be created for each Program Number. The name could be anything that is convenient for you, such as one that calls to mind the type of sound it creates, or one similar to the name of a song you intend to use it with.

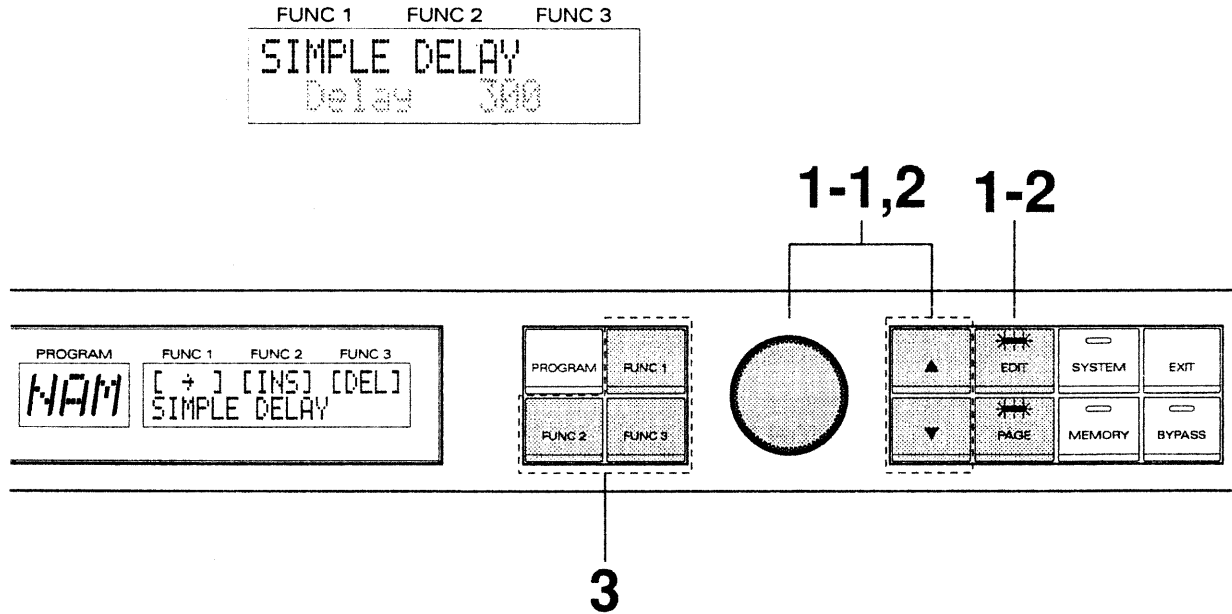

(How to Make the Settings)

1. Get into the Parameter Edit mode.

Once in the Parameter Edit mode, you will be able to make changes in the contents that are stored at each Program Number.

** This step is, of course, unnecessary if you are already in the Parameter Edit mode (you were previously making settings for Effects Programs, etc.).*

1-1. Select the Program Number (algorithm) to which you wish to assign an Effect Name.

1-2. Press [EDIT].

The indicators on both the EDIT and PAGE buttons will light, showing that you are in the Parameter Edit mode.

2. Select the Effect Name parameter.

** This step is, of course, not necessary if the parameter is already selected.*

Get the parameter shown below to appear in the display using the ALPHA DIAL or [▲] / [▼].



3. Switch to the page where Effect Names are created.

Use [FUNC 1-3] to select the page where you can create the name.
 The indicator on the PAGE button will go out, and the display will then show the page where you can enter the name.

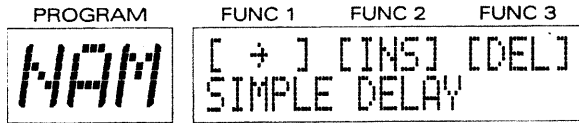

(NOTE)

When the Effect Name setting appears as shown below, you would press [FUNC 2]. However, depending on the position at which the Effect Name setting appears, you need to press the appropriate function button.

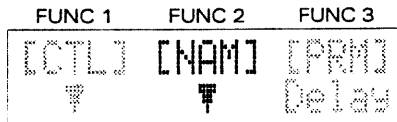

4. Create the Effect Name.

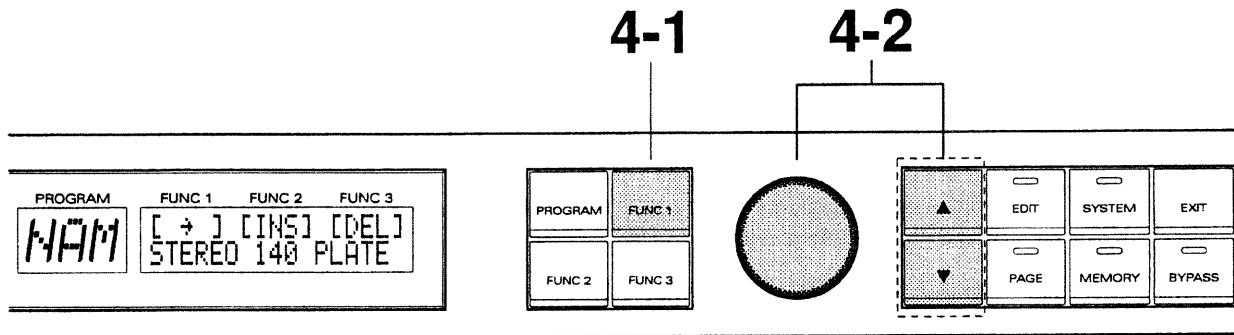

4-1. Move the flashing cursor to the first character position using [FUNC 1 (->)].

4-2. Change the character using the ALPHA DIAL or [▲] / [▼].

- * At this point, you can insert the blank that is flashing by pressing [FUNC 2].
- * At this point, you can delete the character that is flashing by pressing [FUNC 3].
- * The characters which are available for use are as shown below:
 ABCDEFGHIJKLMNOPQRSTUVWXYZ
 0123456789
 abcdefghijklmnopqrstuvwxyz
 !"#%&'()*+,-./:;<=>?@[¥]^_`{|}~+.

4-3. To alter each of the other characters, repeat the steps starting at Step 4-1.

5. When Finished Making Settings

Press [EXIT] to leave the Effect Name page. You will then be in the mode where parameters can be selected.

Should you wish to continue, and make settings for other items (Parameter settings, Control Assign, etc.), select each item as required. For details about how to make specific settings, refer to the section explaining the particular item.

If you wish to have your setting changes stored in memory, carry out the Write Procedure (p.33).

Selecting Parameters Displayed in Top Screen

The SDE-330 allows you to have a specified parameter name (and its value) displayed along with the name of the Effects Program while in the Play mode. Using this feature, you can distinguish among Program Numbers even if they have been given the same name.

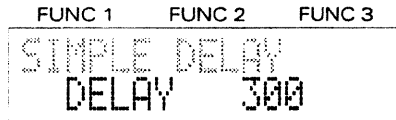

(How to Make the Settings)

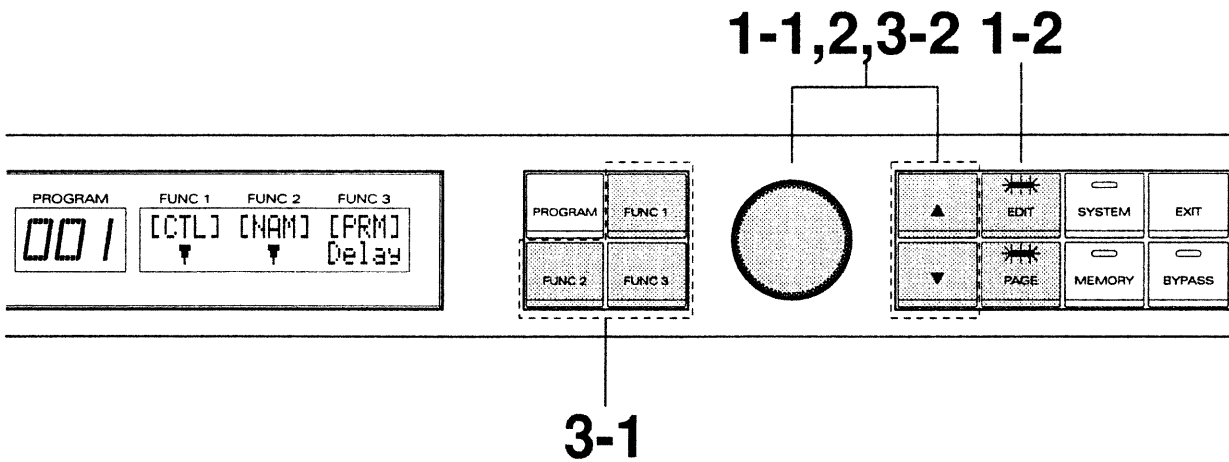

1. Get into the Parameter Edit mode.

Once in the Parameter Edit mode, you will be able to make changes in the contents that are stored at each Program Number.

** This step is, of course, unnecessary if you are already in the Parameter Edit mode (you were previously making settings for Effects Programs, etc.).*

- 1-1. Select the Program Number (algorithm) for which you wish to make Control Assign settings.
- 1-2. Press [EDIT].
The indicators on both the EDIT and PAGE buttons will light, showing that you are in the Parameter Edit mode.

2. Select the 'Top Screen' display parameter.

** This step is, of course, not necessary if the parameter is already selected.*

Get the parameter shown below to appear in the display using the ALPHA DIAL or [▲] / [▼].



3. Change the parameter that is to be displayed on the Top Line of the Screen.

3-1. Use [FUNC 1-3] to select what is displayed.

The indicator on the PAGE button will go out, and the parameter name will start flashing. This means that changes in what will be displayed can now be made.

3-2. Change the parameter that will be displayed in the Top Screen using the ALPHA DIAL or [▲] / [▼].

4. When Finished Making Settings

Should you wish to continue, and make settings for other items (Parameter settings, Name, etc.), select each item as required. For details about how to make specific settings, refer to the section explaining the particular item.

If you wish to have your setting changes stored in memory, carry out the Write Procedure (p.33).

(To Cancel Settings You Have Made)

While in the process of making setting changes, you can press [EXIT] to go back to the mode you were in originally. The indicator on the EDIT button will begin flashing.

With the EDIT button flashing, you can press [EXIT] or switch to a different Program Number, and the indicator on the EDIT button will go out. At this point, all your temporary settings will revert to their original settings.

If you still haven't pressed [EXIT] (the indicator on the EDIT button is still flashing), you can go back again and continue with your revisions by pressing [EDIT]. The indicator on the EDIT button will light, and you will be back where you were before pressing the EXIT button.

Altering the Order Parameters Are Displayed

The SDE-330 allows you to specify any order for the display of parameters. This conveniently allows you, for example, to have parameters that you adjust often be displayed first.

(How to Make the Settings)

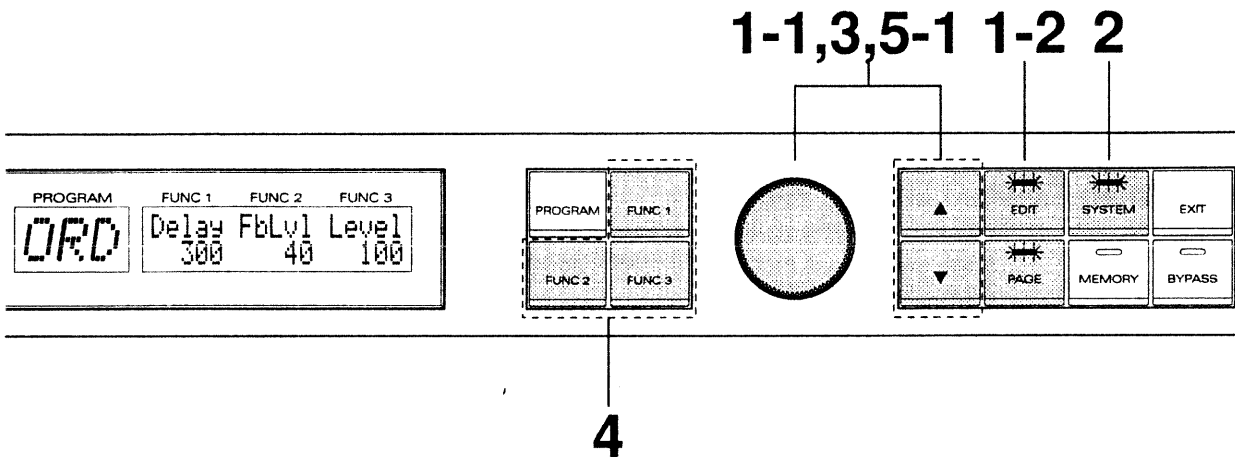

1. Get into the Parameter Edit mode.

Once in the Parameter Edit mode, you will be able to make changes in the contents that are stored at each Program Number.

** This step is, of course, unnecessary if you are already in the Parameter Edit mode (you were previously making settings for Effects Programs, etc.).*

- 1-1. Select the Program Number for which you wish to change the display order.
- 1-2. Press [EDIT].
The indicator on the EDIT button will light, showing that you are in the Parameter Edit mode.

2. Select the mode where the display order can be changed.

Press [SYSTEM].

The indicator on the SYSTEM button will light. You are now in the mode where the display order can be changed.

3. Select the 'display order' parameter.

** This step is, of course, not necessary if the parameter is already selected.*

Select the parameter using the ALPHA DIAL or [▲] / [▼].

4. Specify the parameter that you wish to change the order for.

Use [FUNC 1-3] to select the parameter you wish to change.
 The indicator on the PAGE button will go out, and the selected parameter will start flashing.

5. Change the display order.

5-1. Move the parameter to the desired position using the ALPHA DIAL or [▲] / [▼].

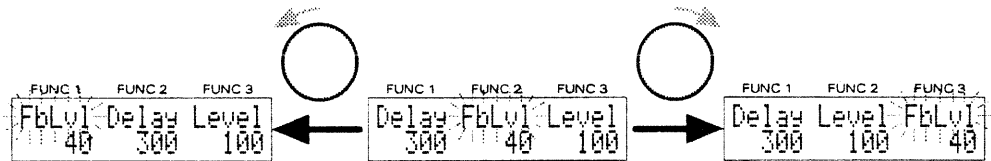

5-2. If you wish to make changes for any of the other parameters that appear in the display, repeat the above from Step 4.
 If you wish to make changes for any other parameters that do not appear in the display, press the PAGE button (so the button indicator lights), and then repeat the above from Step 3.

6. When Finished Making Settings

Press [SYSTEM] to exit the display order setting page.

Should you wish to continue, and make settings for other items (Parameter settings, Control Assign, etc.), select each item as required. For details about how to make specific settings, refer to the section explaining the particular item.
 If you wish to have your setting changes stored in memory, carry out the Write Procedure (p.33).

(To Cancel Settings You Have Made)

While in the process of changing the order parameters are displayed, you can press [EXIT] to cancel, and go back to the mode where parameters can be selected.

Comparing Sounds

The SDE-330 allows you to listen to (and thereby compare) the edited and original sounds. It also allows you to make a comparison with sound produced by other Program Numbers.

(How to Make the Settings)

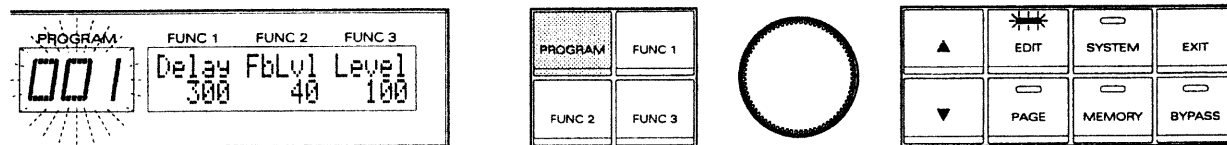

1. From the Parameter Edit mode (where the indicator on the EDIT button is lit), press [PROGRAM].
The Program Number shown in the display will begin flashing, and the unit changes to the sound as it was before you began editing.

2. Press [PROGRAM] again to return to editing.
While the Program Number is flashing, you can use the ALPHA DIAL or the [▲] / [▼] buttons to switch to some other Program Number, allowing you to listen to the sound as it would be produced by an Effects Program other than the one you are working on.

Storing Edited Changes (Write Procedure)

All changes made while in the Parameter Edit mode are only temporary. They will be discarded if you turn the power off, or terminate a procedure by switching to the Play mode. In order to make your changes permanent, they must be stored in memory using the Write Procedure.

(Procedure)

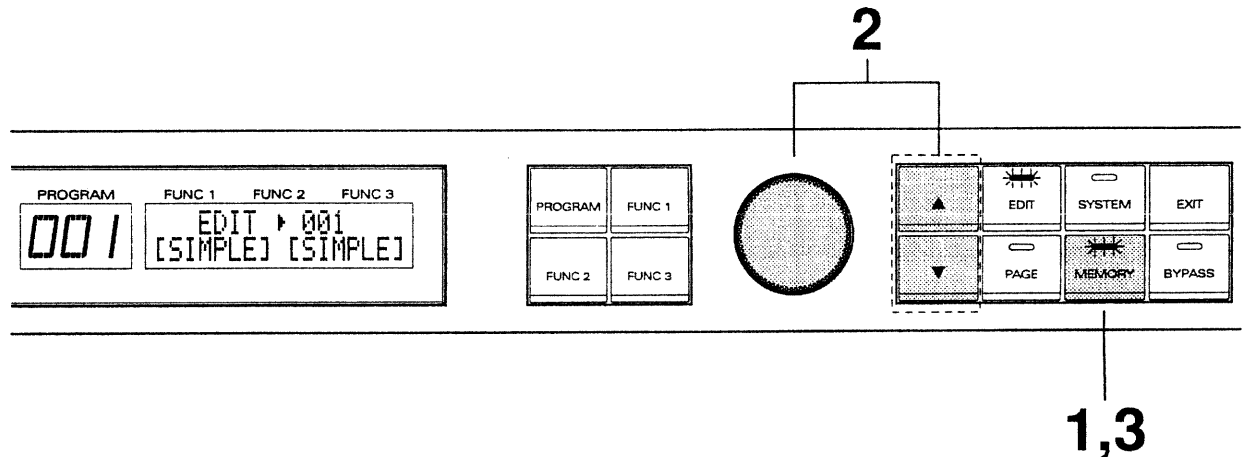

1. After you have completed making all your settings, press [MEMORY]. The indicator on the MEMORY button will light, and the following will appear in the display:



2. Use the ALPHA DIAL or [▲] / [▼] buttons to select the Program Number where you wish to store your settings. Once the target Program Number has been specified, your settings will become the Effects Program stored at that Program Number.



* If you are storing settings back into the same Program Number you do not need to perform the Program Number selection above.

* Program Numbers 201—300 form the Preset Area. Nothing new can be stored in this area. If you have made changes in the settings for a program from the Preset Area, they must be stored in the User Area (Program Numbers 1—200).

* At this point, you can press [EXIT] to terminate the Write Procedure and return to the mode where setting changes are made.

3. Press [MEMORY] and your collection of settings will be stored into the Program Number location specified in Step 2. Once the program has been stored successfully, you are returned to the Play mode.

Making Copies

Copies can be made whenever you wish to make a new Effects Program that is similar to an existing one, or when you wish to rearrange the order of Effects Programs. You can also use the copy procedure to copy an Effects Program from the Preset Area into the User Area (where it can then be edited).

(Procedure)

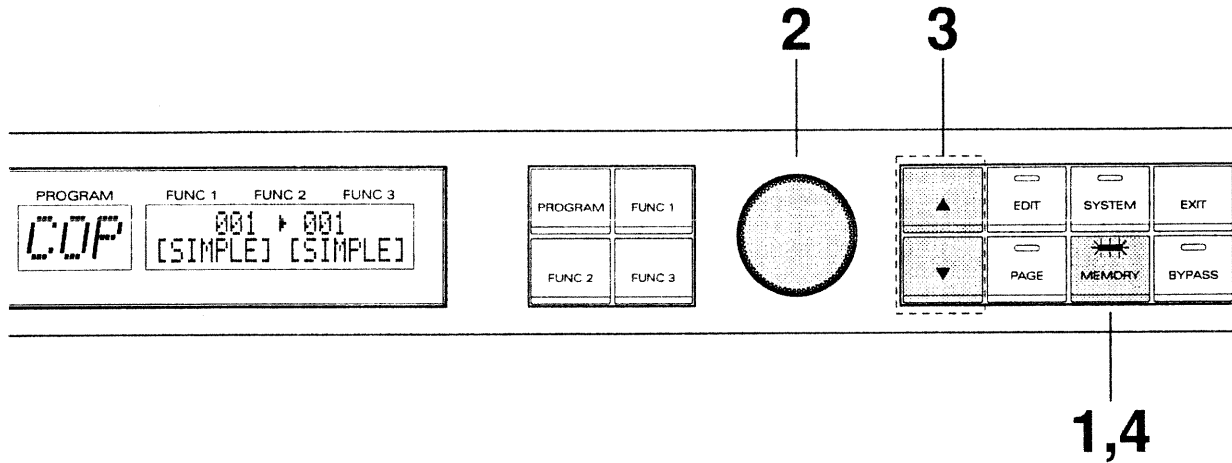

1. Press [MEMORY].
The indicator on the MEMORY button will light, and the following will appear in the display:

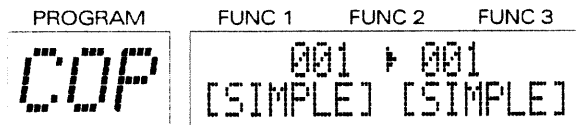

2. Use the ALPHA DIAL to specify the Program Number which contains the material you are going to be copying (the SOURCE).

** If you wish to place the contents of all the Program Numbers with their factory defaults, refer to "Reverting to the Factory Defaults (Initialization)" (p. 53).*

3. Using [▲] / [▼], select the Program Number where you want the copy to be placed (the DESTINATION).

** At this point, you can press [EXIT] to cancel the copying operation and return to the Play mode.*

4. Press MEMORY, and the copy will be performed.
Once the copy has been completed, you are returned to the Play mode.

(If Memory Protect is ON)

When Memory Protect is ON, you will not be able to make any copies. If you press [MEMORY] while Memory Protect is ON, the indicator on the MEMORY button will begin flashing, and the message below will appear in the display:

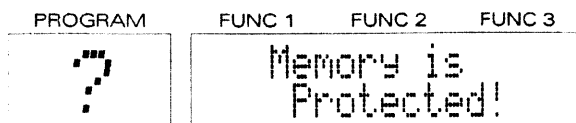

To continue and make the copy, you must first press [EXIT] to quit the copying procedure, then turn OFF Memory Protect. For details, refer to "Memory Protect" (p. 36).

System Function Settings

The following describes the System Functions available on the SDE-330. These settings allow you to better configure the unit for your needs.

The System Functions are as follows:

- MIDI Omni Mode
- MIDI Reception Channel
- MIDI Transmission Channel
- On/Off Switch for Reception of MIDI Program Change Messages
- On/Off Switch for Transmission of MIDI Expression Pedal Messages
- On/Off of MIDI Soft Thru
- MIDI Program Change Map
- Transmission of Data Using MIDI (Bulk Load)
- Reception of Data Using MIDI (Bulk Dump)
- Memory Protect
- Function Selection for Bypass
- Adjustment of Display Contrast

* For information on settings related to MIDI functions, refer to "MIDI System Function Settings" (p.39).

(Procedure)

You can change the settings for any of the System Functions by carrying out the following steps.

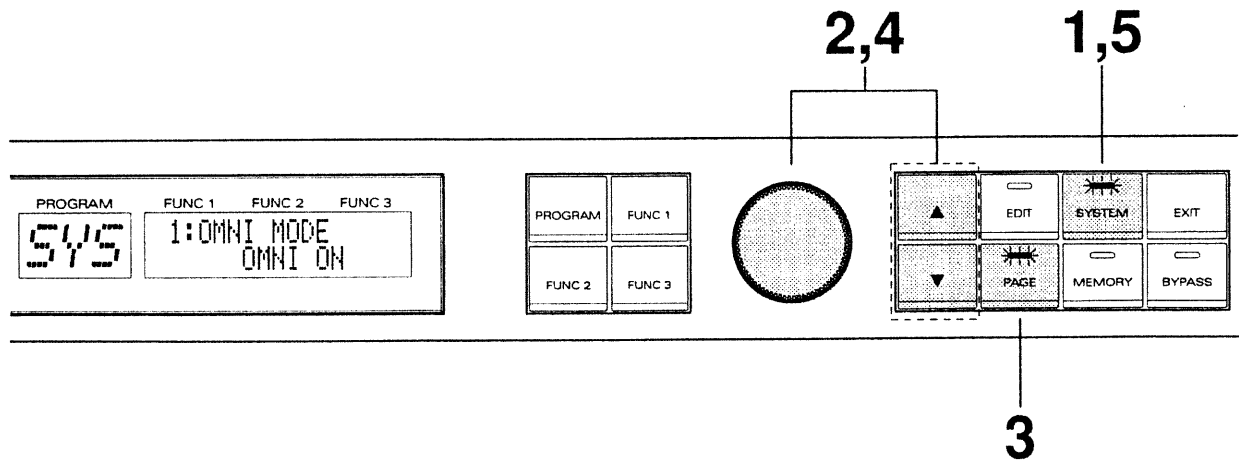

1. Press [SYSTEM] to get into the System mode.
The indicators on both the SYSTEM and PAGE buttons will light.
2. Select the function you wish to make settings for using the ALPHA DIAL or the [▲] / [▼] buttons.
3. Press [PAGE].
The indicator on the PAGE button will go out, and the item that is to be changed will begin to flash.

4. Use the ALPHA DIAL or [▲] / [▼] buttons to make the change in the setting.
** If you press PAGE after making the setting, you will be returned to the place you were in Step 2 (where you can select other settings if needed).*
5. Press [SYSTEM] (or [EXIT]) to return to the Play mode.
 The indicator on the SYSTEM button will go out.

Memory Protect (ON/OFF)

Memory Protect is a switch which serves to protect all the settings you store at the Program Numbers from being accidentally overwritten. Ordinarily it is left ON, but whenever you wish to perform a procedure such as Write or Copy, it needs to be turned OFF.

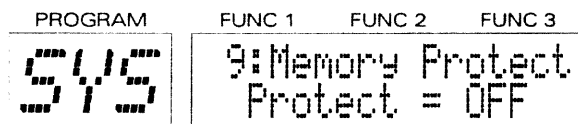

Function Selection for Bypass (BYPASS/MUTE)

The function provided by the Bypass button can be changed:

BYPASS:

When Bypass is turned ON, the effect sound is not output; only the direct sound is heard.

** When Bypass is ON, the direct sound will be output even if you have the Balance knob set so only the effect sound is to be output.*

MUTE:

When Bypass is turned ON, no sound at all will be output from the output jacks.

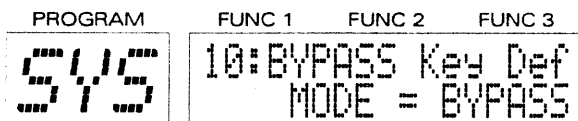

Adjusting the Display Contrast (0—100)

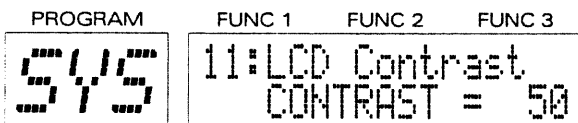

There may be times (because of poor lighting conditions, unit location etc.) when the display is difficult to read. To improve readability, adjust the display contrast.

Chapter III

USING MIDI

MIDI Applications

The SDE-330 allows for the following types of control using MIDI.

Changing Program Numbers

Through the use of Program Change 'messages' (received from an external MIDI unit) you can change the SDE-330's Program Numbers without having to press any of its panel buttons. The correspondence that will exist between specific MIDI Program Change Numbers and the SDE-330's Program Numbers can be altered by changing the "Program Change Map" (p. 42). This feature is convenient when you wish to use an external MIDI device to select Program Numbers above 129, or when you want to match up Effects Programs with sounds on a keyboard.

Controlling Specified Parameters

Aftertouch, Pitch Bend, or Control Change messages can be used during performance to control specified parameters.

Transmission of Data

Exclusive messages can be used to transmit the data stored in the SDE-330 (such as the settings for all Effects Programs) to another MIDI device. If you have a second SDE-330, such transmission allow you to set both units to the same settings. You can also send the contents of settings for all Effects Programs to a sequencer for storage.

About the MIDI Indicator

The SDE-330 is equipped with a MIDI indicator which will light whenever MIDI messages are received from an external device.

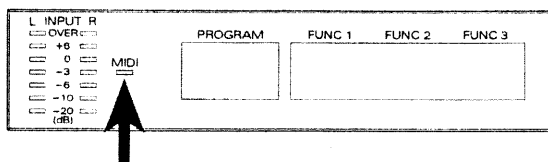

MIDI System Function Settings

The following describes the MIDI System Functions available on the SDE-330. These settings allow you to configure the unit for the MIDI setup you intend to use.

The MIDI System Functions are as follows:

- MIDI Omni Mode
- MIDI Reception Channel
- MIDI Transmission Channel
- On/Off Switch for Reception of MIDI Program Change Messages
- On/Off Switch for Transmission of MIDI Expression Pedal Messages
- On/Off of MIDI Soft Thru
- MIDI Program Change Map
- MIDI Data Transfer
 - Data Transmission (Bulk Dump)
 - Data Reception (Bulk Load)

(Procedure)

** Note, however, that different procedures apply to the two items below. Refer to the specific section where they appear for the appropriate steps to take.
MIDI Program Change Map and MIDI Data Transfer*

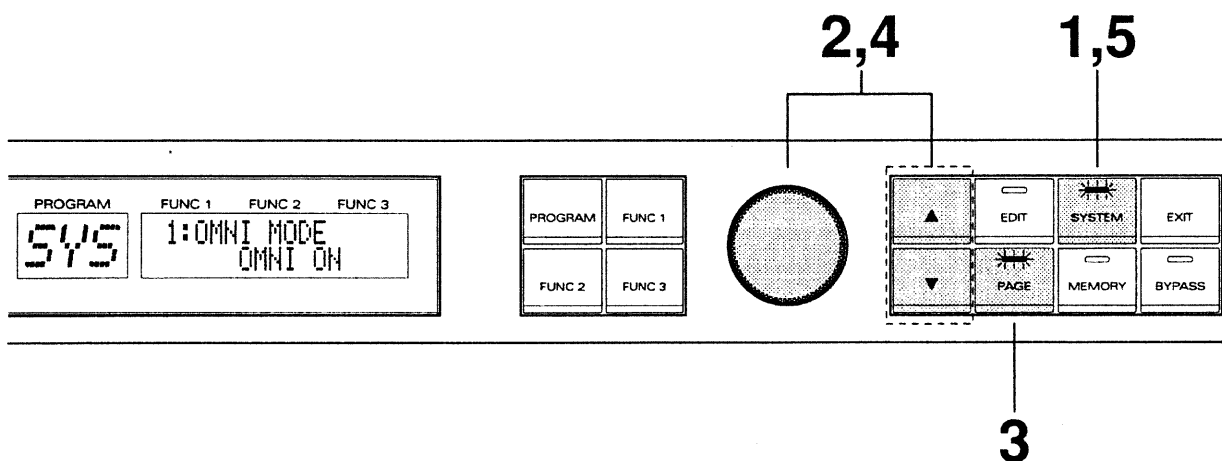

1. Press [SYSTEM] to get into the System mode.
The indicators on both the SYSTEM and PAGE buttons will light.
 2. Select the function you wish to make settings for using the ALPHA DIAL or the [▲] / [▼] buttons.
 3. Press [PAGE].
The indicator on the PAGE button will go out, and the item that is to be changed will begin flashing.
 4. Use the ALPHA DIAL or the [▲] / [▼] buttons to change the setting.
- * If you press [PAGE] after making the setting, you will be returned to the place you were in Step 2 (where you can select other settings if needed).*
5. Press [SYSTEM] (or [EXIT]) to return to the Play mode.
The indicator on the SYSTEM button will go out.

MIDI Omni Mode (ON/OFF)

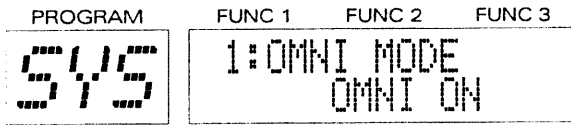

When the Omni Mode is set to ON, MIDI data arriving on any channel will be received; regardless of the setting for the MIDI reception channel.

** Even with Omni Mode set to ON, only data on the specified reception channel (that matches the device ID) can be received when exchanging Exclusive messages.*

MIDI Reception Channel (1—16)

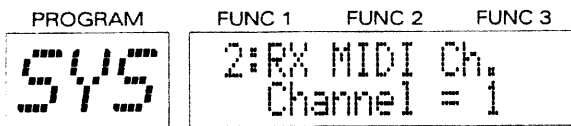

This setting determines the channel that will be used to receive MIDI messages. The SDE-330 will respond to only the messages that arrive on this channel.

MIDI Transmission Channel (1—16)

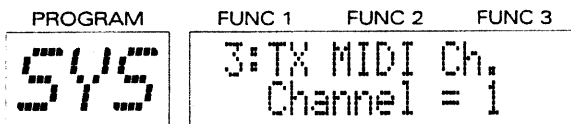

This setting determines the channel that will be used to transmit MIDI messages. The SDE-330 will send out all its MIDI messages on this channel.

MIDI Program Change Message Reception (ON/OFF)

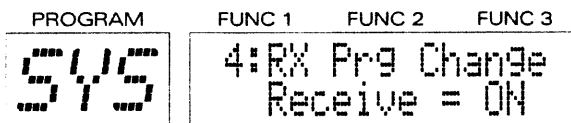

This setting determines whether or not the SDE-330 will change Program Numbers when Program Change messages are received. When set to "OFF," the SDE-330 will ignore all received Program Change messages.

MIDI Expression Pedal Message Transmission (OFF, 0—31/64—95)

PROGRAM	FUNC 1	FUNC 2	FUNC 3
SYS	5:TX Exp. Pedal Transmit = OFF		

This setting allows you to determine the Control Number that will be used for sending out Expression Pedal messages (MIDI Control Changes) generated by an expression pedal connected to the SDE-330's EXP. PEDAL jack. This function allows you to use the expression pedal to remotely control parameters in an external MIDI device.

- * As a factory default, this function is set to "OFF." If left at OFF, no Control Change messages will be sent out by the SDE-330.
- * The appropriate Control Number will differ depending on the particular unit that will be receiving these messages. When making this setting, please refer to the MIDI Implementation Chart that was supplied with the external MIDI unit.

MIDI Soft Thru Switch (ON/OFF)

PROGRAM	FUNC 1	FUNC 2	FUNC 3
SYS	6:MIDI THRU Soft Thru OFF		

This setting determines whether or not you wish to have the full stream of MIDI data that arrives at the SDE-330's MIDI IN connector to be sent out from its MIDI OUT connector. When set to "ON," all data arriving at MIDI IN will be re-transmitted from the MIDI OUT connector.

MIDI Program Change Map Settings

This function allows you to change the correspondence between the MIDI Program Change messages that are received and the actual Program Numbers in the SDE-330. This ability to 'map' your own correspondence between these numbers can be invaluable when wishing to have incoming Program Change messages select specific Program Numbers on the SDE-330.

(Procedure)

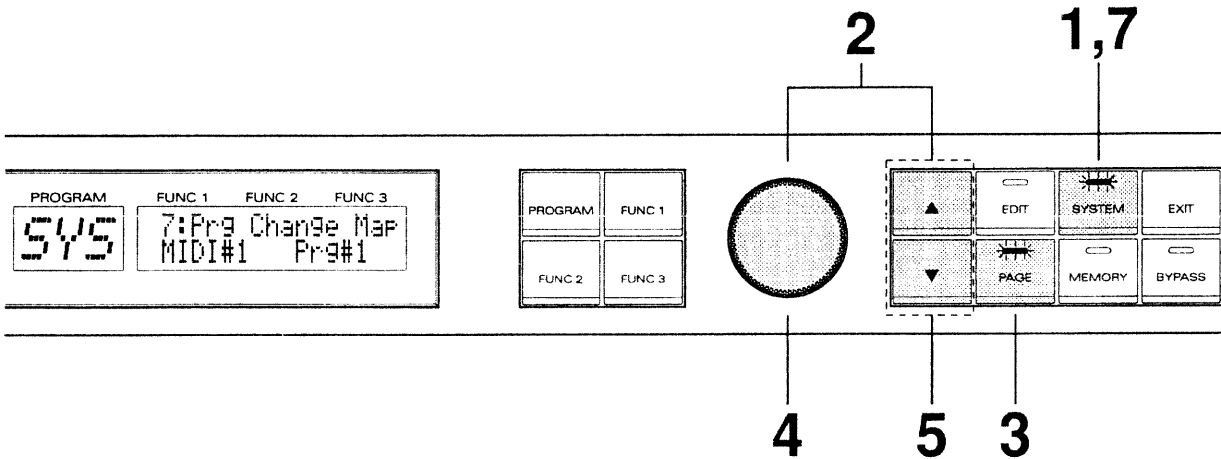

1. Press [SYSTEM] to get into the System mode.
The indicators on both the SYSTEM and PAGE buttons will light.
2. Select the Program Change Map function using the ALPHA DIAL or the [▲] / [▼] buttons.

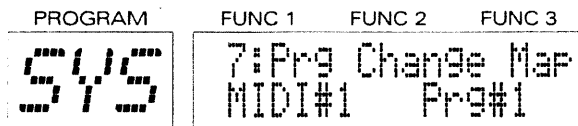

3. Press [PAGE].
The indicator on the PAGE button will go out, indicating you are in the mode where setting changes can be made.
4. Use the ALPHA DIAL to select the Program Change number (message) you wish to receive.
5. Use [▲] / [▼] to select the Program Number on the SDE-330 that will be selected as a result of receiving the above Program Change number (message).
6. Repeat Steps 4 and 5 until you have the desired correspondence between the MIDI Program Change numbers (messages) and the SDE-330's Program Numbers.

* Press [PAGE] after making the settings to be returned to the place you were in Step 2 (where you can change other settings if you so desire).

7. Press [SYSTEM] (or [EXIT]) to return to the Play mode.
The indicator on the SYSTEM button will go out.

MIDI Data Transfer

The SDE-330 can use Exclusive messages to send all internal data to a second SDE-330, thus having the same settings in both units. You can also send the contents of settings for all Effects Programs to a sequencer for storage. The sending of Exclusive messages (for the above purposes) is referred to as a "Bulk Dump." Reception is known as a "Bulk Load."

(Data Which Can be Transferred)

The types of data which can be transferred between two devices is as shown below. When carrying out such exchanges of data, the unit allows you to transfer only specific 'packages' of data (identified in terms of a start point and an end point).

<u>Display Shows</u>	<u>Data Transferred</u>
SYSTEM	System Function Settings
No. 1—200	Settings for Program No. 1—200

Data Transmission (Bulk Dump)

(How to Make the Connections)

Transferring Data to a Sequencer

Make the connections as shown below, and have your sequencer set so it is ready and waiting to receive Exclusive data.

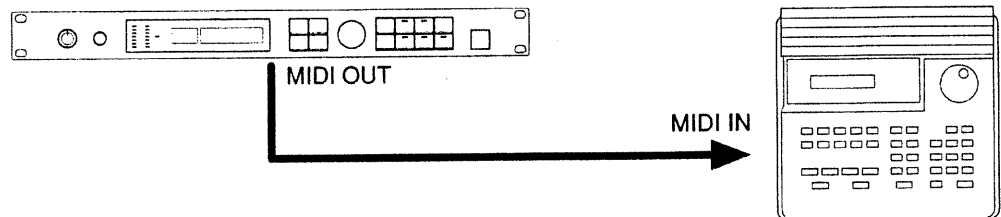

** Refer to your sequencer manual for details on how to receive Exclusive data.*

Copying Data to Another SDE-330

Make the connections as shown below, and have the MIDI channel on the transmitting unit match the channel on the receiving unit.

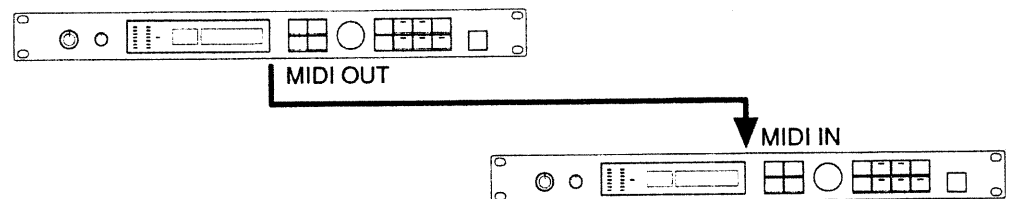

(Carrying Out Transmission)

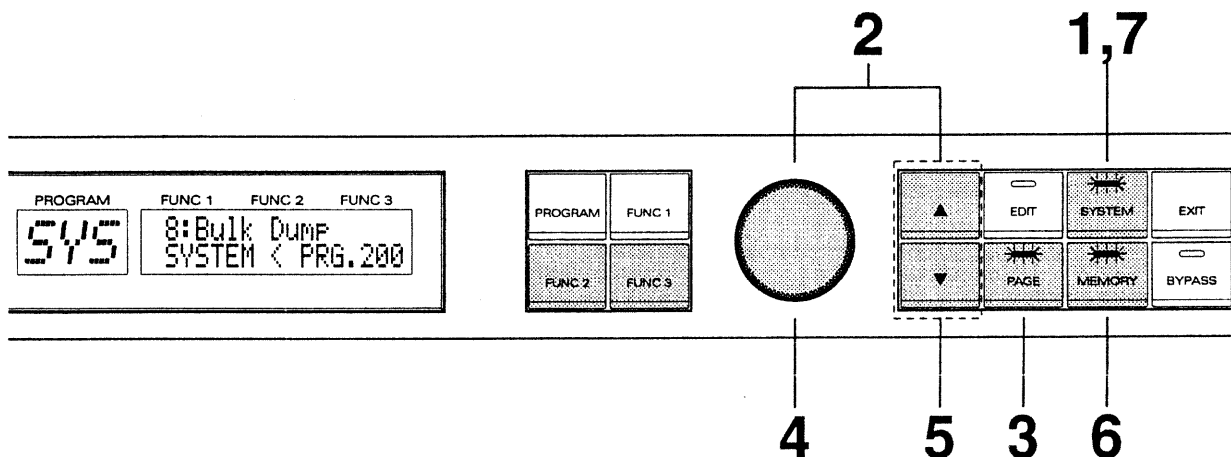

1. Press [SYSTEM] to get into the System mode.
The indicators on both the SYSTEM and PAGE buttons will light.
2. Select the Bulk Dump function using the ALPHA DIAL or the [▲] / [▼] buttons.

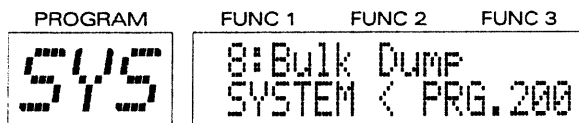

3. Press [PAGE].
The indicator on the PAGE button will go out, and the current content of the settings will be displayed.
4. Use the ALPHA DIAL to specify the START point for the data that is to be transmitted.
5. Use [▲] / [▼] buttons to specify the END point for the data that is to be transmitted.

** The END point must never be set to a value that is smaller than the START point.*

6. Press [MEMORY] and the data will be transmitted.

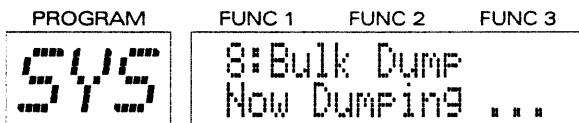

Once all the data has been transferred, you are returned to the screen you were in before the transmission began.

** Press [PAGE] to be returned to Step 2 (where you can select other procedures if necessary).*

7. Press [SYSTEM] (or [EXIT]) to return to the Play mode.
The indicator on the SYSTEM button will go out.

Data Reception (Bulk Load)

(The Connections)

Transferring Data Stored in a Sequencer Back to the SDE-330

Make the connections as shown below, and have the SDE-330 set to the same MIDI channel that it was set to when you originally transferred the data to the sequencer.

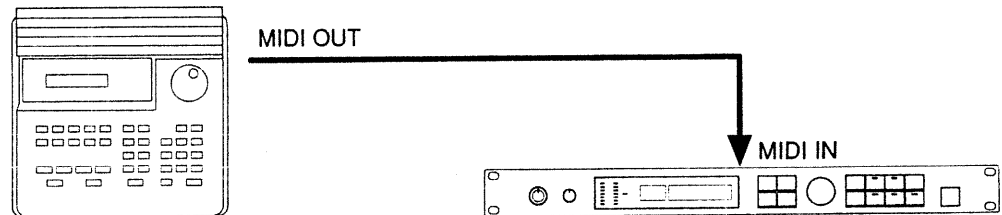

** Refer to your sequencer manual for instructions on how to transfer Exclusive data.*

(Carrying Out Reception)

The unit is ready to receive Exclusive data from an external MIDI device. Whenever Bulk Data has been received, the following will appear in the display:

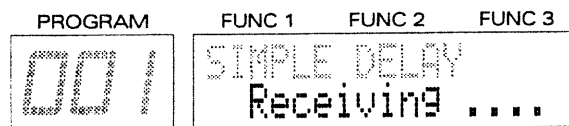

MEMO

Chapter IV

REFERENCE

The Exchange of MIDI Data

MIDI is the acronym for "Musical Instrument Digital Interface." It is an industry-wide standard that allows for data (such as that representing the music played, or for changes in sounds used) to be exchanged among various instruments and computers. As long as they are MIDI compatible, all devices, regardless of model or manufacturer, can exchange whatever performance data they are both equipped to 'understand.'

MIDI converts every 'performance event' into MIDI data. When received by another instrument, this stream of MIDI data can be used to "play" it, as if that instrument itself were being played.

The Exchange of MIDI Data

About MIDI Connectors

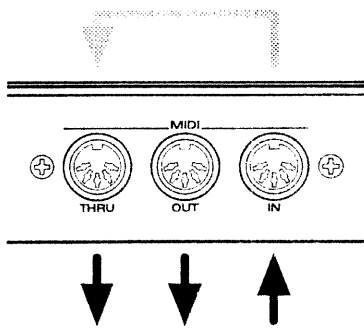

In carrying out the exchange of MIDI data, the three connectors shown below are used. MIDI cables can be routed from these connectors in varying ways depending on the kind of setup you have in mind.

MIDI IN: Receives data from another MIDI device.

MIDI OUT: Transmits data originating in the unit.

MIDI THRU: Sends out an exact copy of the data received at MIDI IN.

** In theory, any number of MIDI devices could be connected together using MIDI THRU connectors, but it is best to consider 4 or 5 devices as being the practical limit. This is because the further down the line a device is located, the greater the likelihood of signal deterioration or delay.*

MIDI Channels

In MIDI communications, a single cable simultaneously carries different streams of performance information for a multiple number of MIDI devices. This is possible thanks to the concept of MIDI channels.

MIDI channels are in some ways similar to the channels on a television set. On a TV, a variety of programs broadcast from different stations can be viewed by switching channels. This is because the information on any particular channel is conveyed only when the receiver is set to the same channel that is being used for transmission.

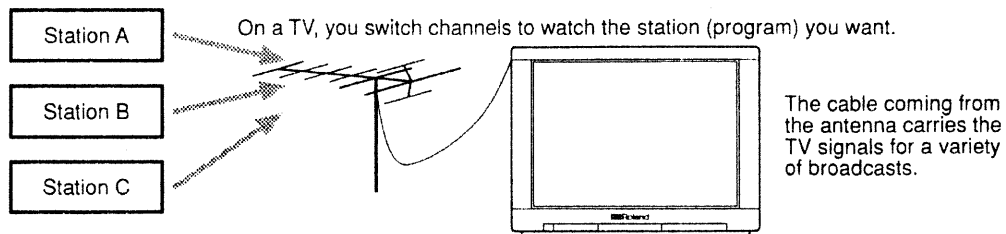

The channels available with MIDI range from 1 through 16. When a musical instrument (the receiver) is set so its channel matches the MIDI channel used by the transmitting device, the MIDI data is successfully 'communicated.'

** When the Omni Mode is set to ON, MIDI data arriving on any channel will be received, regardless of any MIDI channel settings that exist. If you do not need to have channel-specific MIDI control over anything, the Omni Mode can be set to ON.*

MIDI Messages Recognized by the SDE-330

In order to convey the great variety of expression possible with music, the MIDI standard contains a large range of data 'types' (messages). MIDI messages can be divided into two main types: messages that are handled on each channel (Channel messages); and messages that are handled independently of channels (System messages).

CHANNEL MESSAGES

These messages are used to convey the events of a performance. In most circumstances, they alone are sufficient for providing the range of control needed. The specific results obtained by the various MIDI message of this type are determined by the settings on the unit receiving them.

- **Program Change Messages**

These messages are used for conveying information about changes to another sound. Sounds are changed using Program Change Numbers, numbered from 1 through 128. The Program Numbers on the SDE-330 correspond numerically with MIDI Program Change Numbers. Through settings for the Program Change Map function, you can change the correspondence between MIDI Program Change Numbers and Program Numbers on the SDE-330. This feature becomes very useful when you wish to use an external MIDI device to select Program Numbers above 129, or when you want to match Effects Programs with sounds on a keyboard.

- **Control Change Messages**

Control Change messages serve in enhancing the expressiveness of a performance. Every available function can be identified by its own Control Number. The functions which are available for control can vary widely depending on the MIDI device being used. On the SDE-330, these messages are used to control selected parameters.

- **Aftertouch Messages**

These messages convey the ongoing changes in the value of 'Aftertouch.' They contain information about the amount of pressure applied to keys on a keyboard, and usually are used to cause a change in the nuance of the sound. There are two types of Aftertouch; Channel and Polyphonic.

Channel Aftertouch provides control based on individual MIDI channels. No matter which specific keys are pressed more firmly, the effect is applied equally to all notes on the same MIDI channel.

Polyphonic Aftertouch provides control on an individual key (note) basis. Even though it may share the same MIDI channel with other notes, any particular key that has more pressure put on it will produce a unique effect.

The SDE-330 responds to Channel Aftertouch messages which can be assigned to control a selected parameter.

- **Pitch Bend Messages**

These messages convey the action of a Pitch Bend Lever (Wheel) that is found on many synthesizers. On the SDE-330, these messages can be used to control selected parameters.

- **Note Messages**

Note messages convey the musical notes produced during a performance. On the SDE-330, Note On/Off messages (press/release of keys) for specific Note Numbers (position on the keyboard), as well as Velocity messages (force applied when pressing a key) can be used to control selected parameters.

SYSTEM MESSAGES

System messages include Exclusive messages, messages used for synchronizing the performance of multiple units, and other messages employed for diagnostic purposes. The SDE-330 supports the use of Exclusive messages.

- Exclusive Messages

Exclusive messages handle information related to a unit's own unique sounds, or other device-specific information. Generally, such messages can only be exchanged between devices of the same model by the same manufacturer.

Exclusive messages can be employed to save the settings for Effects Programs into a sequencer, or for transferring such data to another SDE-330.

Whenever Exclusive messages are to be used for communication, both devices must be set to the same Unit Number. On the SDE-330, the Unit Number is the same as the MIDI channel number.



MIDI Implementation Chart

MIDI has made it possible for a wide range of musical instruments to communicate with each other, but that doesn't necessarily mean that the many types of data will all be understood. If communication between two connected MIDI devices is to be successful, it must take place using only the types of data that they have in common.

It is for this reason that every owner's manual — for all kinds of MIDI devices — always includes a MIDI Implementation Chart as a quick reference to the types of MIDI messages it is capable of handling. You should compare the MIDI Implementation Charts for any two devices in order to find out which types of data can be exchanged. Since these charts are standardized, you can place them so they overlap. This way you can easily compare the receiving device with the transmitting device.

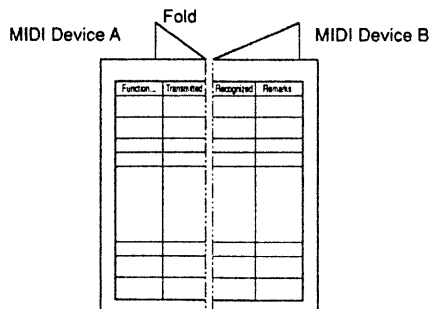

**For detained information on MIDI data of the SDE-330, a separate "MIDI Implementation document" is available at any Roland Service Station.*

Troubleshooting

If for some reason you do not hear the sound you expect to, or suspect that something is wrong with the way the unit is operating, first check through the items that follow. If you are still unable to correct the problem, consult your retailer or contact the nearest Roland Service Station.

** If an unfamiliar message appears in the display during use, check "Error Messages" (p. 52) for an explanation.*

No Sound Produced/Level Too Low

- Are you sure connections with all other devices have been made properly?
- Have you checked the amplifier and/or mixer you are using to make sure that power is ON and the volume is at a suitable level?
- Are you sure the INPUT LEVEL knob is not set too low?
- Do you have Bypass turned ON?
If Bypass is set at "Output Mute" and you then turn Bypass ON, not even the direct sound will be heard (p. 36).
- Is the sound produced normally if you switch to a different Program Number, and then come back and select the one in question?
If so, it means that the volume was being suppressed temporarily due to a change in the value of a parameter specified for Control Assign.
If sound is not produced normally after trying the above, you should recheck every setting that pertains to volume for that Program Number (Total Level, Control Assign, etc.).
- Have you checked for damaged cables?
Replace any damaged cables.

Sound is Distorted (The "OVER" segments in the Level Meter light frequently)

- Do you have the INPUT LEVEL knob at an appropriate level? (p. 10)
- Do you have the INPUT/OUTPUT LEVEL switch on the rear panel set to the position appropriate for the devices you have connected?
- Could the output level be too great on the external unit you have connected?
- Is the distortion eliminated when you try switching to another Program Number?
If so, you should recheck every setting that pertains to volume for the Program Number in question (Total Level, Control Assign, etc.).

Cannot Obtain Expected Control Over Parameter Specified for Control Assign

- Have you checked to make sure the settings made for the parameter to be controlled were correct?
Make sure the specified range of change is not too narrow.
Recheck to make sure the MIDI channels on both units match if expecting to use MIDI messages received from an external device to control a parameter.

Cannot Obtain Expected Changes in Program Numbers

- First make sure the MIDI channels on your units match.
If changes to unintended Program Numbers occur, recheck the settings for the Program Change Map (p. 42).

Error Messages

An error message will appear in the display whenever an error has been made during operation, or when the unit is incapable of completing a task. Please take note of the displayed message and correct the cause of the error.



The lithium battery (essential for maintaining parameter settings) is nearly exhausted. Have the battery replaced by your retailer or at the nearest Roland Service Station.

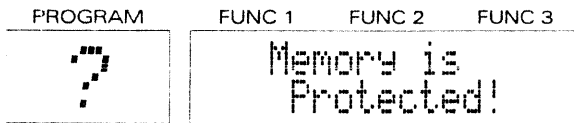

Although settings for Effects Programs can be made, they cannot be stored in memory because Memory Protect is "ON."

Exclusive messages could not be received because Memory Protect is "ON." Try the procedure again after turning memory protection "OFF."

Restoring the Factory Default Settings (Initialization)

To restore the SDE-330's factory default settings ("Initialization"), follow the steps below. In addition to initializing all settings, you can also choose to initialize only the User Area or System settings.

With the factory default settings, Program Numbers 201—300 in the Preset Area will be duplicated at Program Numbers 1—200 in the User Area.

Initialization can be carried out with respect to the following groups of data:

- PROGRAM : Only data in the User Area will be restored to the factory default settings.
 SYSTEM : Only settings for the System will be restored to the factory default settings.
 PROGRAM+SYSTEM : All settings will be restored to the factory default settings.

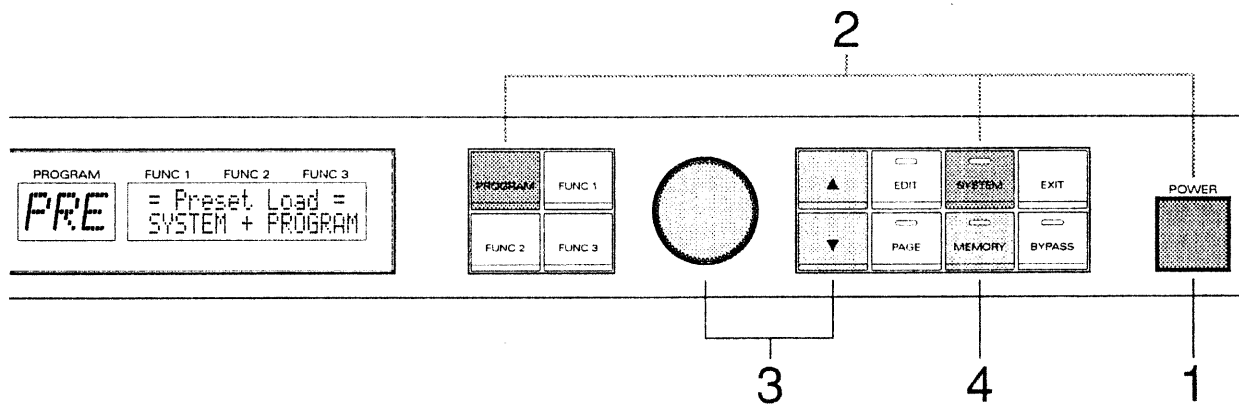

1. Turn the power OFF.
2. While holding down both [PROGRAM] and [SYSTEM], turn the power ON.
The page in which you specify the group(s) of data to be initialized appears:

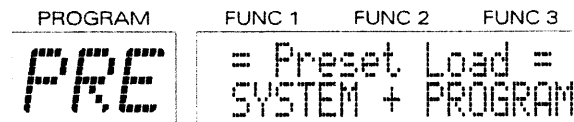

3. Use the ALPHA DIAL or the [▲] / [▼] buttons to specify the group(s) of data to be initialized.

** At this point, you can press [EXIT] to cancel the initialization and return to the Play mode.*

4. Press [MEMORY], and the initialization will begin.
Once the data has been initialized, you are returned to the Play mode.

MIDI Implementation Chart

Function...		Transmitted	Recognized	Remarks
Basic Channel	Default Changed	1 - 16 1 - 16	1 - 16 1 - 16	Memorized
Mode	Default Messages Altered	x x *****	OMNI ON/OFF x x	Memorized
Note Number	True Voice	x *****	o *1 x	*2
Velocity	Note ON Note OFF	x x	o *1 x	*2
After Touch	Key's Ch's	x x	x o *1	*2
Pitch Bend		x	o *1	*2
Control Change	0 - 31	o *3	o *1	*2
	32 - 63	x	o *1	*2 *4
	64 - 95	o *3	o *1	*2
Prog Change	True #	x *****	o *1 0 - 127	Program Number 1 - 128
System Exclusive		o	*1	
System Common	Song Pos Song Sel True	x x x	x x x	
System Real Time	Clock Commands	x x	o *1 x	
AUX Messages	Local ON/OFF All Notes OFF Active Sense Reset	x x x x	x x x x	
Notes	*1:Can be set manually to o/x, and permanently memorized. *2:Made controllable by specifying one particular parameter. *3:Transmit Expression Pedal value. *4:LSB of Control Change #0 — #31			

Mode 1 : OMNI ON, POLY
Mode 3 : OMNI OFF, POLY

Mode 2 : OMNI ON, MONO
Mode 4 : OMNI OFF, MONO

o : Yes
x : No

Specifications

SDE-330 :DIMENSIONAL SPACE DELAY

Signal Processing

AD Conversion :16bit, $\Delta\Sigma$ modulation
 DA Conversion :16bit, $\Delta\Sigma$ modulation

Sampling Frequency

44.1kHz

Program Memories

User Area :1 to 200
 Preset Area :201 to 300

Frequency Response

5Hz to 70kHz -3/+0.1dB (Direct)
 20Hz to 20kHz -3/+0.3dB (Effect)

Nominal Input Level

-20/+4dBm (selectable with Input LEVEL Switch)

Input Impedance

300k Ω (Input LEVEL Switch: -20dBm)
 10k Ω (Input LEVEL Switch: +4dBm)

Nominal Output Level

-20/+4dBm (selectable with Output LEVEL Switch)

Output Impedance

1.5k Ω (Output LEVEL Switch: -20dBm)
 9k Ω (Output LEVEL Switch: +4dBm)

Total Harmonic Distortion

0.012% or less (Direct, 1kHz at nominal output level)
 0.02% or less (Effect, 1kHz at nominal output level)

Dynamic Range

100dB or greater (Direct)
 90dB or greater (Effect)

Controls

INPUT LEVEL Knobs (L, R)
 BALANCE Knob
 PROGRAM Button
 Function Buttons (1, 2, 3)
 Alpha-Dial
 Increment/Decrement Buttons
 EDIT Button
 PAGE Button
 SYSTEM Button
 MEMORY Button
 EXIT Button
 BYPASS Button
 POWER Button
 Input LEVEL Switch
 Output LEVEL Switch

Display

3 characters, 1 lines (backlit LCD)
 17 characters, 2 lines (backlit LCD)

Indicators

Input Level Indicator
 MIDI Indicator

Connectors

INPUT Jacks (L (MONO), R)
 OUTPUT Jacks (L (MONO), R)
 EXPRESSION Pedal Jack
 CONTROL Jack
 BYPASS Jack
 MIDI Connectors (In, Out, Thru)

Power Supply

AC117V, AC230V or AC240V

Power Consumption

25W

Dimensions

482 (W) x 307 (D) x 44 (H) mm
 19 (W) x 12-1/8 (D) x 1-3/4 (H) inches
 (EIA-1U rack mount type)

Weight

3.8kg/ 8 lbs 7 oz

Accessories

Owner's Manual
 Algorithm Guide

**0dBm=0.775Vrms*

**The specifications for this product are subject to change without prior notice.*

Index

Adjusting the Balance	10	Selecting Effects Programs	11
Aftertouch messages	20, 49	Specifications	55
Algorithm	16	System Function	35, 39
Bypass	12, 21, 36	To Cancel Settings You Have Made	19,
Choosing What Is Shown In the Display	13	Troubleshooting	51
Comparing Sounds	32	User Area	16
Contrast	36	Value Range	22
Control Assign	20	Velocity messages	21
Control Change messages	21, 49	Write Procedure	33
CONTROL Jack	20		
Control Source	20		
Control Target	21		
Data Reception (Bulk Load)	45		
Data Transmission (Bulk Dump)	38, 43		
Effect Name	25		
Effector Name	18		
Error Messages	52		
EXP. PEDAL jack	20		
Exclusive messages	50		
Initialization	53		
Input Level	10		
Making Copy	34		
Making the Connections	8		
Making Settings for the Effects	17		
Memory Protect	17, 34, 36		
MIDI Channels	48		
MIDI Expression Pedal Message Transmission	41		
MIDI Implementation Chart	54		
MIDI Indicator	38		
MIDI Omni Mode	40		
MIDI Program Change Map	42		
MIDI Program Change Message Reception	40		
MIDI Reception Channel	40		
MIDI Soft Thru	41		
MIDI Transmission Channel	40		
MUTE	36		
Note Number messages	21, 49		
Order Parameters	30		
PANEL DESCRIPTION	6		
Parameter	16, 18		
Parameter Displayed in Top Screen	28		
Parameter Edit mode	17		
Pitch Bend messages	20, 49		
Preset Area	16		
Program Change messages	49		
Program Number	11, 38		

■ MEMO

Information

When you need repair service, call your local Roland Service Station or the authorized Roland distributor in your country as shown below.

U. S. A.

Roland Corporation US
7200 Dominion Circle
Los Angeles, CA. 90004-
3696, U. S. A.
TEL: (213) 685-5141

CANADA

Roland Canada Music Ltd.
(Head Office)
5480 Parkwood Way
Richmond B. C., V6V 2M4
CANADA
TEL: (604) 270-6626

Roland Canada Music Ltd.

(Montreal Office)
9425 Transcanadienne
Service Rd. N., St Laurent,
Quebec H4S 1V3, CANADA
TEL: (514) 335-2009

Roland Canada Music Ltd.

(Toronto Office)
346 Watline Avenue,
Mississauga, Ontario L4Z
1X2, CANADA
TEL: (416) 890-6488

AUSTRALIA

Roland Corporation Australia Pty. Ltd.
38 Campbell Avenue
Dee Why West. NSW 2099
AUSTRALIA
TEL: (02) 982-8266

NEW ZEALAND

Roland Corporation (NZ) Ltd.
97 Mt. Eden Road, Mt. Eden,
Auckland 3, NEW ZEALAND
TEL: (09) 3098-715

UNITED KINGDOM

Roland (U.K.) Ltd.
Rye Close Ancells Business
Park Fleet, Hampshire GU13
8UY, UNITED KINGDOM
TEL: 0252-816181

Roland (U.K.) Ltd.,

Swansea Office
Atlantic Close, Swansea
Enterprise Park, Swansea,
West Glamorgan SA79FJ,
UNITED KINGDOM
TEL: (0792) 700-139

ITALY

Roland Italy S. p. A.
Viale delle Industrie 8 20020
ARESE MILANO ITALY
TEL: 02-93581311

SPAIN

Roland Electronics de España, S. A.
Calle Bolivia 239 08020
Barcelona, SPAIN
TEL: 93-308-1000

GERMANY

Roland Elektronische Musikinstrumente Handelsgesellschaft mbH.
Oststrasse 96, 2000
Norderstedt, GERMANY
TEL: 040/52 60 090

FRANCE

Musikengro
102 Avenue Jean-Jaures
69007 Lyon Cedex 07
FRANCE
TEL: (7) 858-54 60

Musikengro (Paris Office)

Centre Region Parisienne 41
rue Charles-Fourier, 94400
Vitry SUR/SEINE FRANCE
TEL: (1) 4680 86 62

BELGIUM/HOLLAND/LUXEMBOURG

Roland Benelux N. V.
Houstraat 1 B-2260 Oevel-
Westerlo BELGIUM
TEL: (0032) 14-575811

DENMARK

Roland Scandinavia A/S
Langebrogade 6 Box 1937
DK-1023 Copenhagen K.
DENMARK
TEL: 31-95 31 11

SWEDEN

Roland Scandinavia A/S
Danvik Center 28 A, 2 tr.
S-131 30 Nacka SWEDEN
TEL: 08-702 00 20

NORWAY

Roland Scandinavia Avd. Kontor Norge
Lilleakerveien 2 Postboks 95
Lilleaker N-0216 Oslo 2
NORWAY
TEL: 22-73 00 74

FINLAND

Fazer Musik Inc.
Länsituulentie POB 169,
SF-02101 Espoo FINLAND
TEL: 0-43 50 11

SWITZERLAND

Musitronic AG
Gerberstrasse 5, CH-4410
Istetal, SWITZERLAND
TEL: 061/921 16 15

Roland CK (Switzerland) AG

P.O.Box Landstrasse 5
CH-4452 Itingen (BL)
SWITZERLAND
TEL: (61) 971 80 80
Repair Service by Musitronic AG

AUSTRIA

E. Dematte & Co.
Neu-Rum Siemens-Strasse 4
6021 Innsbruck P.O.Box 83
AUSTRIA
TEL: (0512) 26 44 260

GREECE

V. Dimitriadis & Co. Ltd.
20, Alexandras Avn., GR
10682 Athens, GREECE
TEL: 01-8232415

PORTUGAL

Casa Caius Instrumentos Musicais Lda.
Rua de Santa Catarina 131
4000 Porto, PORTUGAL
TEL: 02-38 44 56

HUNGARY

Intermusica Ltd.
Warehouse Area 'DEPO'
Torokbalint, Budapest
HUNGARY
TEL: (1) 1868905

ISRAEL

D.J.A. International Ltd.
11 Bar Gyiara St., Tel Aviv
ISRAEL
TEL: 972-3-5283329

CYPRUS

Radex Sound Equipment Ltd.
17 Diagorou St., P.O.Box
2046, Nicosia CYPRUS
TEL: 453426, 466423

U.A.E

Zak Electronics & Musical Instruments Co.
P.O. Box 8050
DUBAI, U.A.E
TEL: 695774

SAUDI ARABIA

Omar Badoghaish Trading Corp.
P.O. Box 5980
Jeddah, SAUDI ARABIA
TEL: 966-02-6607038

KUWAIT

Easa Husain Al-Yousifi
P.O. Box 126 Safat 13002
KUWAIT
TEL: 965-5719499

LEBANON

A. Chahine & Fils
P.O. Box 16-5857
Beirut, LEBANON
TEL: 335799

TURKEY

Barkat Sanayi ve Ticaret
Siraselviler Cad. 86/6 Taksim
Istanbul, TURKEY
TEL: 149 93 24

EGYPT

Al Fanny Trading Office
9, Ebn Hagar Ai Askalany
Street, Ard El Golf,
Heliopolis, Cairo, 11341
EGYPT
TEL: 2917803-665918

QATAR

Badie Studio & Stores
P.O.Box 62,
DOHA Qatar
TEL: 974 423554

BAHRAIN

Moon Stores
Bad Al Bahrain Road,
P.O.Box 20077
State of Bahrain
TEL: (0973) 211 005

BRAZIL

Roland Brasil Ltda.
R. Alvarenga 591 CEP-05509
Sao Paulo BRAZIL
TEL: (011) 210-7266
Repair Service for Roland and
Rhodes products

Oliver do Brasil S.A.

Instrumentos Musicais
Rua Botuoca. 198/206
CEP 05586-010 Vila Indiana
Butanta Sao Paulo-SP BRAZIL
TEL: (011) 814-1344
Repair Service for BOSS products

MEXICO

Casa Veerkamp, s.a. de c.v.
Mesones No. 21 Col. Centro
MEXICO D.F. 06080
TEL: (5) 709-3716

La Casa Wagner de Guadalajara s.a. de c.v.

Av. Corona No. 202 S.J.
C.P.44100 Guadalajara,
Jalisco MEXICO
TEL: (36) 13-1414

VENEZUELA

Musicland Digital C.A.
Av. Francisco De Miranda,
Centro Parque Cristal, Nivel
C2 Local 20 Caracas
VENEZUELA
TEL: (2)2844497

PANAMA

Productos Superiores, S.A.
Apartado 655 - Panama 1
REP. DE PANAMA
TEL: 26-3322

ARGENTINA

Instrumentos Musicales S.A.
Florida 638
(1005) Buenos Aires
ARGENTINA
TEL: (1)394-4029

HONG KONG

Tom Lee Music Co., Ltd. Service Division
22-32 Pun Shan Street, Tsuen
Wan, New Territories,
HONG KONG
TEL: 415-0911

KOREA

Cosmos Corporation Service Station
261 2nd Floor Nak-Won
Arcade Jong-Ro ku, Seoul,
KOREA
TEL: (02) 742 8844

SINGAPORE

Swee Lee Company
BLOCK 231,
Bain Street #03-23
Bras Basah Complex,
Singapore 0718
TEL: 3367886

PHILIPPINES

G.A. Yupangco & Co. Inc.
339 Gil J. Puyat Avenue
Makati, Metro Manila 1200,
PHILIPPINES
TEL: 02 (817) 0013

THAILAND

Theera Music Co., Ltd.
330 Verng Nakorn Kasem,
Soi 2, Bangkok 10100,
THAILAND
TEL: 2248821

VIETNAM

Saigon Music Distributor
383A Dien Bien Phu St.
3rd. District
Ho Chi Mink City, Vietnam
TEL: 84-8-391395/332674

MALAYSIA

Syarikat Bentley
No.142, Jalan Bukit Bintang
55100 Kuala Lumpur,
MALAYSIA
TEL: (03) 2443333

INDONESIA

PT Citrarama Belantika
JL Alaydrus 84 B
Jakarta 10130
INDONESIA
TEL: (021) 3802638,
3802639

TAIWAN

Siruba Enterprise (Taiwan) Co., LTD.
Room. 5, 9fl. No. 112 Chung
Shan N.Road Sec.2 Taipei,
TAIWAN, R.O.C.
TEL: (02) 571-5860

SOUTH AFRICA

That Other Music Shop (PTY) Ltd.
11 Melle Street (Cnr Melle
and Juta Street)
Braamfontein 2001
Republic of South Africa
TEL: 27 11 403-4105

Paul Bothner (PTY) Ltd.
17 Werdmuller Centre
Claremont 7700
Republic of South Africa
TEL: 021-64-4030

As of Jun. 28. 1993

 **Roland**

Printed in Japn

Apparatus containing Lithium batteries

ADVARSEL!

Lithiumbatteri - Eksplosjonsfare ved feilagtig håndtering.
Udskiftning må kun ske med batteri af samme fabrikat og type.
Levér det brugte batteri tilbage til leverandøren.

VARNING!

Explosionsfara vid felaktigt batteribyte. Använd samma batterityp eller en ekvivalent typ som rekommenderas av apparattillverkaren.
Kassera använt batteri enligt fabrikantens instruktion.

ADVARSEL!

Lithiumbatteri - Eksplosjonsfare. Ved utskifting benyttes kun batteri som anbefalt av apparatfabrikanten.
Brukt batteri returneres apparatleverandøren.

VAROITUS!

Paristo voi räjähtää, jos se on virheellisesti asennettu.
Vaihda paristo ainoastaan laitevalmistajan suosittelemaan tyyppiin. Hävitä käytetty paristo valmistajan ohjeiden mukaisesti.

Bescheinigung des Herstellers / Importeurs

Hiermit wird bescheinigt, daß der/die/das
DIMENSIONAL SPACE DELAY SDE-330
(Gerät, Typ, Bezeichnung)

in Übereinstimmung mit den Bestimmungen der
Amtsbl. Vfg 1046 / 1984
(Amtsblattverfügung)

funk-entstört ist.

Der Deutschen Bundespost wurde das Inverkehrbringen dieses Gerätes angezeigt und die Berechtigung zur Überprüfung der Serie auf Einhaltung der Bestimmungen eingeräumt.

Roland Corporation Osaka / Japan

Name des Herstellers/Importeurs

FEDERAL COMMUNICATIONS COMMISSION RADIO FREQUENCY INTERFERENCE STATEMENT

This equipment has been tested and found to comply with the limits for a Class B digital device, pursuant to Part 15 of the FCC Rules. These limits are designed to provide reasonable protection against harmful interference in a residential installation. This equipment generates, uses, and can radiate radio frequency energy and, if not installed and used in accordance with the instructions, may cause harmful interference to radio communications. However, there is no guarantee that interference will not occur in a particular installation. If this equipment does cause harmful interference to radio or television reception, which can be determined by turning the equipment off and on, the user is encouraged to try to correct the interference by one or more of the following measures:

- Reorient or relocate the receiving antenna.
- Increase the separation between the equipment and receiver.
- Connect the equipment into an outlet on a circuit different from that to which the receiver is connected.
- Consult the dealer or an experienced radio/TV technician for help.

Unauthorized changes or modification to this system can void the users authority to operate this equipment.

CLASS B

This digital apparatus does not exceed the Class B limits for radio noise emissions set out in the Radio Interference Regulations of the Canadian Department of Communications.

NOTICE

CLASSE

Cet appareil numérique ne dépasse pas les limites de la classe B au niveau des émissions de bruits radioélectriques fixés dans le Règlement des signaux parasites par le ministère canadien des Communications.

BAVIS

 Roland®

26050944

UPC

26050944



18981

SDE-330

 Roland

26050944 937 GA1-12SE