

RD-300SX

Owner's Manual

Thank you, and congratulations on your choice of the Roland Digital Piano RD-300SX.

Before using this unit, carefully read the sections entitled: "USING THE UNIT SAFELY" and "IMPORTANT NOTES" (p. 2; p. 4). These sections provide important information concerning the proper operation of the unit. Additionally, in order to feel assured that you have gained a good grasp of every feature provided by your new unit, Owner's Manual should be read in its entirety. The manual should be saved and kept on hand as a convenient reference.

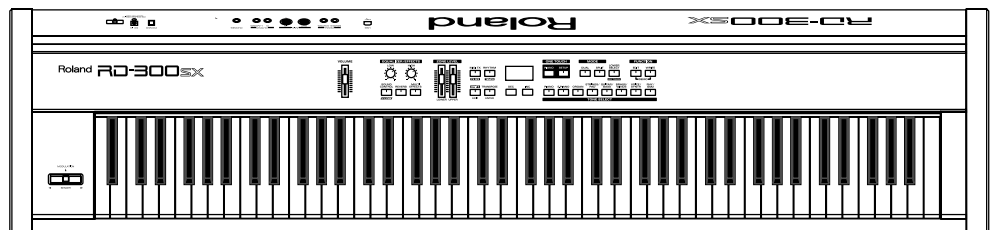

USING THE UNIT SAFELY

INSTRUCTIONS FOR THE PREVENTION OF FIRE, ELECTRIC SHOCK, OR INJURY TO PERSONS

About ⚠ WARNING and ⚠ CAUTION Notices

⚠ WARNING	Used for instructions intended to alert the user to the risk of death or severe injury should the unit be used improperly.
⚠ CAUTION	Used for instructions intended to alert the user to the risk of injury or material damage should the unit be used improperly. * Material damage refers to damage or other adverse effects caused with respect to the home and all its furnishings, as well to domestic animals or pets.

About the Symbols

	The ⚠ symbol alerts the user to important instructions or warnings. The specific meaning of the symbol is determined by the design contained within the triangle. In the case of the symbol at left, it is used for general cautions, warnings, or alerts to danger.
	The ⓧ symbol alerts the user to items that must never be carried out (are forbidden). The specific thing that must not be done is indicated by the design contained within the circle. In the case of the symbol at left, it means that the unit must never be disassembled.
	The ⚡ symbol alerts the user to things that must be carried out. The specific thing that must be done is indicated by the design contained within the circle. In the case of the symbol at left, it means that the power-cord plug must be unplugged from the outlet.

ALWAYS OBSERVE THE FOLLOWING

⚠ WARNING

- Before using this unit, make sure to read the instructions below, and the Owner's Manual.

- Do not open (or modify in any way) the unit or its AC adaptor.

- Do not attempt to repair the unit, or replace parts within it (except when this manual provides specific instructions directing you to do so). Refer all servicing to your retailer, the nearest Roland Service Center, or an authorized Roland distributor, as listed on the "Information" page.

- Never use or store the unit in places that are:
 - Subject to temperature extremes (e.g., direct sunlight in an enclosed vehicle, near a heating duct, on top of heat-generating equipment); or are
 - Damp (e.g., baths, washrooms, on wet floors); or are
 - Humid; or are
 - Exposed to rain; or are
 - Dusty; or are
 - Subject to high levels of vibration.

- This unit should be used only with a rack or stand that is recommended by Roland.

- When using the unit with a rack or stand recommended by Roland, the rack or stand must be carefully placed so it is level and sure to remain stable. If not using a rack or stand, you still need to make sure that any location you choose for placing the unit provides a level surface that will properly support the unit, and keep it from wobbling.

⚠ WARNING

- Be sure to use only the AC adaptor supplied with the unit. Also, make sure the line voltage at the installation matches the input voltage specified on the AC adaptor's body. Other AC adaptors may use a different polarity, or be designed for a different voltage, so their use could result in damage, malfunction, or electric shock.

- Use only the attached power-supply cord. Also, the supplied power cord must not be used with any other device.

- Do not excessively twist or bend the power cord, nor place heavy objects on it. Doing so can damage the cord, producing severed elements and short circuits. Damaged cords are fire and shock hazards!

- This unit, either alone or in combination with an amplifier and headphones or speakers, may be capable of producing sound levels that could cause permanent hearing loss. Do not operate for a long period of time at a high volume level, or at a level that is uncomfortable. If you experience any hearing loss or ringing in the ears, you should immediately stop using the unit, and consult an audiologist.

- Do not allow any objects (e.g., flammable material, coins, pins); or liquids of any kind (water, soft drinks, etc.) to penetrate the unit.

⚠ WARNING

- Immediately turn the power off, remove the AC adaptor from the outlet, and request servicing by your retailer, the nearest Roland Service Center, or an authorized Roland distributor, as listed on the “Information” page when:
 - The AC adaptor, the power-supply cord, or the plug has been damaged; or
 - If smoke or unusual odor occurs
 - Objects have fallen into, or liquid has been spilled onto the unit; or
 - The unit has been exposed to rain (or otherwise has become wet); or
 - The unit does not appear to operate normally or exhibits a marked change in performance.
- In households with small children, an adult should provide supervision until the child is capable of following all the rules essential for the safe operation of the unit.
- Protect the unit from strong impact. (Do not drop it!)
- Do not force the unit’s power-supply cord to share an outlet with an unreasonable number of other devices. Be especially careful when using extension cords—the total power used by all devices you have connected to the extension cord’s outlet must never exceed the power rating (watts/amperes) for the extension cord. Excessive loads can cause the insulation on the cord to heat up and eventually melt through.
- Before using the unit in a foreign country, consult with your retailer, the nearest Roland Service Center, or an authorized Roland distributor, as listed on the “Information” page.
- DO NOT play a CD-ROM disc on a conventional audio CD player. The resulting sound may be of a level that could cause permanent hearing loss. Damage to speakers or other system components may result.

⚠ CAUTION

- The unit and the AC adaptor should be located so their location or position does not interfere with their proper ventilation.
- This (RD-300SX) for use only with Roland stand KS-12. Use with other stands (or carts) is capable of resulting in instability causing possible injury.
- Always grasp only the plug on the AC adaptor cord when plugging into, or unplugging from, an outlet or this unit.
- At regular intervals, you should unplug the AC adaptor and clean it by using a dry cloth to wipe all dust and other accumulations away from its prongs. Also, disconnect the power plug from the power outlet whenever the unit is to remain unused for an extended period of time. Any accumulation of dust between the power plug and the power outlet can result in poor insulation and lead to fire.
- Try to prevent cords and cables from becoming entangled. Also, all cords and cables should be placed so they are out of the reach of children.
- Never climb on top of, nor place heavy objects on the unit.
- Never handle the AC adaptor or its plugs with wet hands when plugging into, or unplugging from, an outlet or this unit.
- Before moving the unit, disconnect the AC adaptor and all cords coming from external devices.
- Before cleaning the unit, turn off the power and unplug the AC adaptor from the outlet (p. 11, p. 13).
- Whenever you suspect the possibility of lightning in your area, disconnect the AC adaptor from the outlet.
- Should you remove ground terminal screw, keep them in a safe place out of children’s reach, so there is no chance of them being swallowed accidentally.

IMPORTANT NOTES

In addition to the items listed under “USING THE UNIT SAFELY” on page 2, please read and observe the following:

Power Supply

- Do not connect this unit to same electrical outlet that is being used by an electrical appliance that is controlled by an inverter (such as a refrigerator, washing machine, microwave oven, or air conditioner), or that contains a motor. Depending on the way in which the electrical appliance is used, power supply noise may cause this unit to malfunction or may produce audible noise. If it is not practical to use a separate electrical outlet, connect a power supply noise filter between this unit and the electrical outlet.
- The AC adaptor will begin to generate heat after long hours of consecutive use. This is normal, and is not a cause for concern.
- Before connecting this unit to other devices, turn off the power to all units. This will help prevent malfunctions and/or damage to speakers or other devices.

Placement

- Using the unit near power amplifiers (or other equipment containing large power transformers) may induce hum. To alleviate the problem, change the orientation of this unit; or move it farther away from the source of interference.
- This device may interfere with radio and television reception. Do not use this device in the vicinity of such receivers.
- Noise may be produced if wireless communications devices, such as cell phones, are operated in the vicinity of this unit. Such noise could occur when receiving or initiating a call, or while conversing. Should you experience such problems, you should relocate such wireless devices so they are at a greater distance from this unit, or switch them off.
- Do not expose the unit to direct sunlight, place it near devices that radiate heat, leave it inside an enclosed vehicle, or otherwise subject it to temperature extremes. Excessive heat can deform or discolor the unit.
- When moved from one location to another where the temperature and/or humidity is very different, water droplets (condensation) may form inside the unit. Damage or malfunction may result if you attempt to use the unit in this condition. Therefore, before using the unit, you must allow it to stand for several hours, until the condensation has completely evaporated.
- Do not allow objects to remain on top of the keyboard. This can be the cause of malfunction, such as keys ceasing to produce sound.

Maintenance

- For everyday cleaning wipe the unit with a soft, dry cloth or one that has been slightly dampened with water. To remove stubborn dirt, use a cloth impregnated with a mild, non-abrasive detergent. Afterwards, be sure to wipe the unit thoroughly with a soft, dry cloth.
- Never use benzine, thinners, alcohol or solvents of any kind, to avoid the possibility of discoloration and/or deformation.

Repairs and Data

- Please be aware that all data contained in the unit’s memory may be lost when the unit is sent for repairs. Important data should always be backed up in another MIDI device (e.g., a sequencer), or written down on paper (when possible). During repairs, due care is taken to avoid the loss of data. However, in certain cases (such as when circuitry related to memory itself is out of order), we regret that it may not be possible to restore the data, and Roland assumes no liability concerning such loss of data.

Additional Precautions

- Please be aware that the contents of memory can be irretrievably lost as a result of a malfunction, or the improper operation of the unit. To protect yourself against the risk of losing important data, we recommend that you periodically save a backup copy of important data you have stored in the unit’s memory in another MIDI device (e.g., a sequencer).
- Unfortunately, it may be impossible to restore the contents of data that was stored in another MIDI device (e.g., a sequencer) once it has been lost. Roland Corporation assumes no liability concerning such loss of data.
- Use a reasonable amount of care when using the unit’s buttons, sliders, or other controls; and when using its jacks and connectors. Rough handling can lead to malfunctions.
- When connecting / disconnecting all cables, grasp the connector itself—never pull on the cable. This way you will avoid causing shorts, or damage to the cable’s internal elements.
- To avoid disturbing your neighbors, try to keep the unit’s volume at reasonable levels. You may prefer to use headphones, so you do not need to be concerned about those around you (especially when it is late at night).
- When you need to transport the unit, package it in the box (including padding) that it came in, if possible. Otherwise, you will need to use equivalent packaging materials.
- Use only the specified expression pedal (EV-5, EV-7; sold separately). By connecting any other expression pedals, you risk causing malfunction and/or damage to the unit.

Handling CD-ROMs

- Avoid touching or scratching the shiny underside (encoded surface) of the disc. Damaged or dirty CD-ROM discs may not be read properly. Keep your discs clean using a commercially available CD cleaner.

Contents

Main Features	8
Panel Descriptions	9
Front Panel.....	9
Rear Panel.....	10
Getting Ready	11
Making Connections.....	11
Connecting the RD-300SX to External Equipment.....	12
Connecting Pedals.....	12
Turning the Power On and Off.....	13
Adjusting the Volume.....	14
Tuning to Other Instruments' Pitches (Master Tune).....	15
Overview of the RD-300SX	16
Basic Organization of the RD-300SX.....	16
Units of Sound.....	16
Basic Operation of the RD-300SX.....	16
Changing the Settings Values.....	16
Listening to the Demo (Demo Play)	17
Performing with the Keyboard	18
Piano Performances (ONE TOUCH [PIANO]).....	18
Performing with a Variety of Tones.....	19
Playing Multiple Tones with the Keyboard.....	20
Switching to Single Mode.....	20
Performing with Two Layered Tones ([DUAL]).....	21
Playing Different Tones in Two Different Sections of the Keyboard ([SPLIT]).....	22
Changing the Tone for a Zone.....	24
Adjust the Volume Level for Individual Zones (ZONE LEVEL sliders).....	24
Transposing the Key of the Keyboard ([TRANSCOPE]).....	25
Changing the Keyboard's Touch.....	26
Changing the Velocity When the Key Touch Is Set to "Fixed".....	26
Adding Reverberation to Sounds ([REVERB]).....	27
Changing the Reverb Effect Type.....	27
Changing the Depth of Reverb Effect (Reverb Depth).....	27
Adding a Variety Effects to the Sound ([MULTI EFFECTS]).....	28
Changing the Depth of Effect.....	28
Changing the Multi-effects Type.....	29
Adding a Spinning Sound to Organ Tones (Rotary Effect).....	29
Changing the Sound's Pitch in Real Time (Bender/Modulation Lever).....	30
Making a More Consistent Sound ([SOUND CONTROL]).....	30
Adjusting the Level of the Sound's Low and High-Frequency Ranges (EQUALIZER).....	31
Using the Convenient Functions in Performances	32
Playing Rhythm ([RHYTHM]).....	32
Changing the Rhythm Pattern.....	32
Changing Rhythm Tempos.....	33
Changing the Rhythm Volume.....	33
Selecting Stored Settings ([SETUP]).....	34
Storing Settings to Setups ([WRITE]).....	35
Disabling the Buttons (Panel Lock).....	36

Settings for Each Function ([EDIT])	37
Parameters That Can Be Set	37
Making System Settings (System)	37
How to Make Settings	37
Tuning to Other Instruments' Pitches (Master Tuning)	38
Adjusting the Tuning (Temperament, Key)	38
Precise Modification of Chord Sonorities (Stretch Tune)	38
Switching the Pedal's Polarity (Damper Pedal Polarity)	38
Switching the Pedal's Polarity (Control Pedal Polarity)	39
Using Program Change Messages to Switch Setups (Setup Control Channel)	39
Using the Pedal to Switch Setup (Setup Pedal Shift)	39
Making the Settings for the USB Driver	39
Setup-Related Settings (Common)	40
How to Make Settings	40
Setting the Zone to which Multi Effects are Added (MFX Zone)	40
Changing the Pedal Function (Control Pedal Function)	40
Tone Settings (Tone Parameter)	41
How to Make Settings	41
Changing Tone Elements (Cutoff/Resonance/Attack Time/Decay Time/Release Time)	41
Setting the Amount of Reverb Applied to Each Tone (Reverb Send Level)	41
Changing the Pitch (Fine Tune)	42
Changing the Bend Range (Bend Range)	42
Making the Settings for Each Zone Individually (Zone Parameter)	42
How to Make Settings	42
Changing the pitch of the tone in semitone steps (Key Transpose)	43
Setting the Pan	43
Turning Each Controller On and Off	43
Part On/Off (Part)	43
Utility Settings (Utility)	44
Transferring Setups to External Devices (Setup Bulk Dump)	44
Restoring the settings to the factory condition (Factory Reset)	45
Setting the MIDI Tx Mode	46
Switching Local Control On and Off	46
Connecting External MIDI Devices	47
What's MIDI?	47
About MIDI Connectors	47
Connecting to External MIDI Sound Generators	47
Using the RD-300SX As a Master Keyboard	47
Selecting Sounds on an External MIDI Device	47
Recording RD-300SX Performances to an External MIDI Sequencer	48
Connecting to an External Sequencer	48
Settings for Recording	48
Recording the Performance	48
Playing the RD-300SX's Internal Sound Generator from an External MIDI Device	49
Selecting RD-300SX Sounds from an External MIDI Device	49
Switching Setups	49
Connecting to Your Computer via USB (USB Mode)	50
Switching USB Drivers	50
Exchanging MIDI Messages with Your Computer	50
About V-LINK	51
How to Use the V-LINK	51

Troubleshooting.....	52
Effects List.....	55
Error Messages	59
Tone List	60
Rhythm Set List.....	62
Rhythm Pattern List.....	65
Setup List.....	66
Shortcut List.....	66
MIDI Implementation Chart	67
Main Specifications	68
Index.....	69

** All product names mentioned in this document are trademarks or registered trademarks of their respective owners.*

Main Features

Refined Design and a Compact, Lightweight Body

The RD-300SX's black alumite body not only looks great on stage, it's also compact and lightweight, for an instrument that is easy to carry wherever you are performing.

88-Key Multi-Sampled Piano

Those same piano sounds, created through 88-key sampling, which won wide acclaim when they made their debut in the Fantom-X series of instruments (the ultimate in synthesizers), are provided onboard the RD-300SX. The only difference is that they have been arranged so they more aptly suit their new role as the sounds produced by a dedicated stage piano. This gives you the kind of expressiveness available only with 88-key multisampled sounds, expressive power unequalled by any other synthesizer.

Additionally, you can take the piano wave forms that make your band sound great and store them in the instrument, and use two types of piano sounds to enjoy performances in a variety of genres.

This instrument also features a full line of important stage piano tones including electric piano, organ, strings, synth pad, and more.

A Full 128 Voices

The RD-300SX features 128-voice polyphony, with all sounds available in every performance mode. Enjoy natural performances even when layering multiple sounds.

Compact Hammer Action Keyboard and Half-Pedal Capability

The RD-300SX incorporates a hammer action keyboard using absolutely no springs, which is even capable of reproducing the subtle changes in touch that are normally experienced when you move from the lower to the higher registers. Additionally, a half-pedal capable pedal (DP-8) is also included, enabling authentic pedal performance.

Simple Push-Button Operation

You can access Split and Dual modes and carry out other main operations simply by pressing a single button (p. 20). Furthermore, pressing the ONE TOUCH [PIANO] button lets you immediately switch to the settings most suited for piano performances, regardless of the mode or settings currently in effect (p. 18).

High-Quality Effects

The RD-300SX also includes 78 types of multi-effects, for example sympathetic resonance that simulates the resonance of the piano strings when the pedal is pressed, a rotary speaker effect, distortion, and more. The instrument also provides a wide variety of tone adjustment capabilities including a two-band digital equalizer and a Sound Control function that helps check inconsistencies in the sound.

A Variety of Functions Available Only with a Stage Piano

This instrument features not only the standard controls you would expect on a stage piano, such as the bender/modulation lever, it also includes a [SETUP] button that allows you to call up a variety of stored settings instantly and a [MIDI TX] button that gives you simplified control of external sound modules.

This stage piano provides rapid, intuitive control of your sounds.

Rhythm Function

You can play rhythm patterns with the touch of a single button. This enables you to back up your performances with realistic drum sounds, improvise with a true jam session feel, and use the metronome to practice grooves you are not yet familiar with.

USB and GM/GM2 Compatible

The RD-300SX comes equipped with a USB port and GM2 sound module that can be utilized when you use the RD-300SX as an input keyboard in composing songs with a computer or when using the instrument as a sound module.

* Only MIDI messages are handled with the USB function.

Convention Used in This Manual

- Words enclosed in square brackets [] indicate panel buttons.
Example: [SPLIT] indicates the SPLIT button.
- (p. **) indicates a reference page.
- The explanations in this manual include illustrations that depict what should typically be shown by the display. Note, however, that your unit may incorporate a newer, enhanced version of the system (e.g., includes newer sounds), so what you actually see in the display may not always match what appears in the manual.

Panel Descriptions

Front Panel

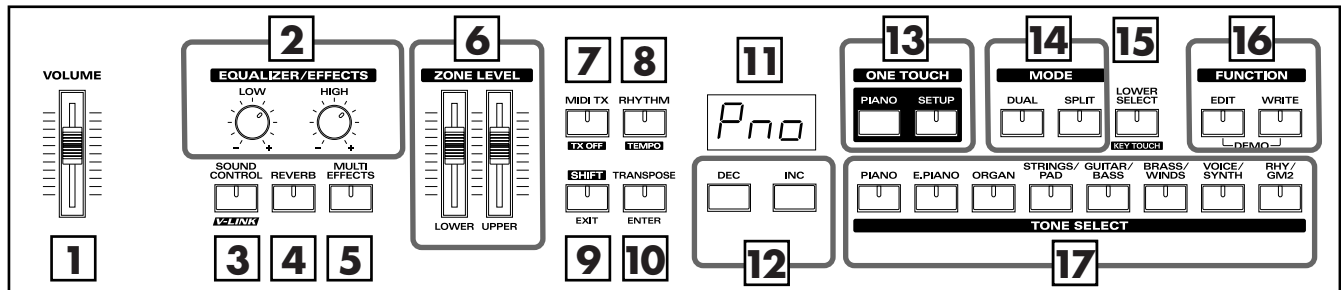

1. VOLUME slider

Adjusts the overall volume that is output from the rear panel OUTPUT jacks and PHONES jack (p. 14).

2. EQUALIZER/EFFECTS

[LOW] knob

Adjusts the sound's low-frequency range.

[HIGH] knob

Adjusts the sound's high-frequency range.

3. [SOUND CONTROL/V-LINK]

[SOUND CONTROL] switches SOUND CONTROL on/off (p. 30).

[V-LINK] switches the V-LINK function on/off (p. 51).

4. [REVERB]

Switches REVERB on/off (p. 27).

5. [MULTI EFFECTS]

Switches the multi-effects on/off (p. 28).

6. ZONE LEVEL sliders

Adjusts the volume level in each zone (p. 24).

7. [MIDI TX]

Enables control of external MIDI sound modules from the RD-300SX (p. 46, p. 47, p. 48).

8. [RHYTHM/TEMPO]

[RHYTHM] is used to turn the rhythm performance on and off (p. 32).

[TEMPO] is used to change the rhythm tempo (p. 33).

9. [SHIFT/EXIT]

[SHIFT] is pressed simultaneously with other buttons to execute various functions.

[EXIT] is pressed to return to previous screens.

10. [TRANSPOSE/ENTER]

[TRANSPOSE] sets the range of the keyboard to transposed (p. 25).

[ENTER] is used to finalize a value or execute an operation.

11. DISPLAY

This shows the Tone numbers and the values of various settings, etc.

12. [DEC], [INC]

This is used to modify values.

If you keep on holding down one button while pressing the other, the value change accelerates.

13. ONE TOUCH

[PIANO]

Selects the optimum settings for piano performances (p. 18).

[SETUP]

Calls up the stored settings (Setup) (p. 34).

14. MODE

[DUAL]

Switches the RD-300SX to "Dual Mode," which enables performances with two separate tones layered together (p. 21).

[SPLIT]

Puts the keyboard in "Split mode," wherein you can use more than one tone by having different tones play in different parts of the keyboard (p. 22).

15. [LOWER SELECT/KEY TOUCH]

When this is switched to on, you can select the LOWER ZONE tone with the TONE SELECT buttons (p. 24). This button is also used to change the keyboard touch (p. 26).

16. FUNCTION

[EDIT]

Press this button when you wish to adjust various settings (p. 37).

In addition, you can listen to the demo songs by simultaneously pressing this button and [WRITE] (DEMO PLAY) (p. 17).

[WRITE]

Stores the current settings to "Setup" (p. 35).

17. TONE SELECT buttons

Pressed to select a tone's category (p. 19).

Pitch Bend/Modulation lever

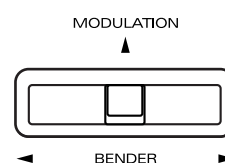

This allows you to control pitch bend or apply vibrato (p. 30).

Rear Panel

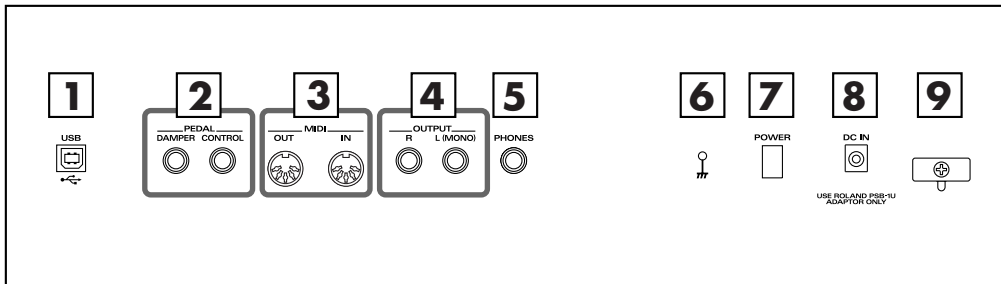

1. USB connector

This connector lets you use a USB cable to connect your computer to the RD-300SX (p. 50).

2. PEDAL jacks (DAMPER, CONTROL)

Connecting the pedal switch (DP series) provided with the RD-300SX to the DAMPER jack allows you to use the switch as a damper pedal.

With an optional expression pedal (such as the EV series or other model) connected to the CONTROL jack, you can then assign a variety of functions to the pedal (p. 39, p. 40).

3. MIDI connectors (IN, OUT)

Used for connecting external MIDI devices and for transmission of MIDI messages (p. 12, p. 47).

4. OUTPUT L(MONO)/R jacks

Provide output of the audio signals. These are connected to an amp or other device. For monaural output use the L/MONO jack (p. 12).

5. PHONES jack

A set of headphones can be connected to this jack (p. 12). Even when headphones are connected, sound will still be output from the output jacks.

6. Ground terminal

Depending on the circumstances of a particular setup, you may experience a discomforting sensation, or perceive that the surface feels gritty to the touch when you touch this device, microphones connected to it, or the metal portions of other objects, such as guitars. This is due to an infinitesimal electrical charge, which is absolutely harmless. However, if you are concerned about this, connect the ground terminal (p. 11) with an external ground. When the unit is grounded, a slight hum may occur, depending on the particulars of your installation. If you are unsure of the connection method, contact the nearest Roland Service Center, or an authorized Roland distributor, as listed on the "Information" page.

Unsuitable places for connection

- Water pipes (may result in shock or electrocution)
- Gas pipes (may result in fire or explosion)
- Telephone-line ground or lightning rod (may be dangerous in the event of lightning)

7. [POWER]

Turns the power on/off (p. 13).

8. DC In jack

Connect the included AC adaptor here (p. 11).

9. Cord hook

Anchor the included power cord here (p. 11).

Getting Ready

Making Connections

- 1** Before you begin making connections, confirm the following.

Is the volume level of the RD-300SX turned all the way down?

Is the power to the RD-300SX turned off?

- 2** Connect the supplied power cord to the supplied AC adaptor.

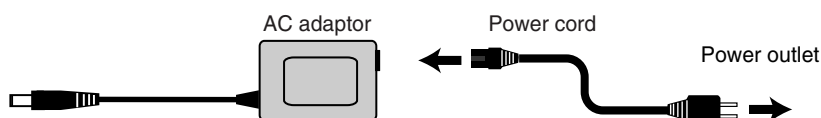

- 3** Connect the supplied AC adaptor to the RD-300SX, and then plug its other end into a power outlet.

- 4** Loop the AC adaptor cord around the cord hook to fasten it in place.

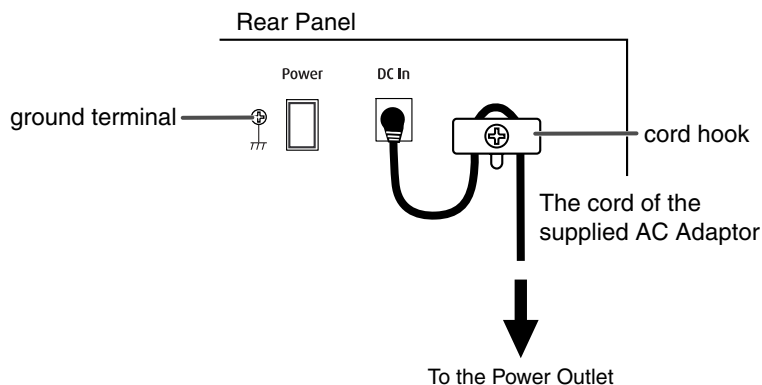

* To prevent the inadvertent disruption of power to your unit (should the plug be pulled out accidentally), and to avoid applying undue stress to the AC adaptor jack, anchor the power cord using the cord hook, as shown in the illustration.

* Depending on the circumstances of a particular setup, you may experience a discomforting sensation, or perceive that the surface feels gritty to the touch when you touch this device, microphones connected to it, or the metal portions of other objects, such as guitars. This is due to an infinitesimal electrical charge, which is absolutely harmless. However, if you are concerned about this, connect the ground terminal (see figure) with an external ground. When the unit is grounded, a slight hum may occur, depending on the particulars of your installation. If you are unsure of the connection method, contact the nearest Roland Service Center, or an authorized Roland distributor, as listed on the "Information" page.

Unsuitable places for connection

- Water pipes (may result in shock or electrocution)
- Gas pipes (may result in fire or explosion)
- Telephone-line ground or lightning rod (may be dangerous in the event of lightning)

Connecting the RD-300SX to External Equipment

The RD-300SX is not equipped with an amplifier or speakers. In order to produce sound, you need to hook up audio equipment such as a monitor speaker or a stereo set, or use headphones.

* Audio cables, MIDI cables, USB cables, headphones, and expression pedals are not included. Consult your Roland dealer if you need to purchase accessories such as these.

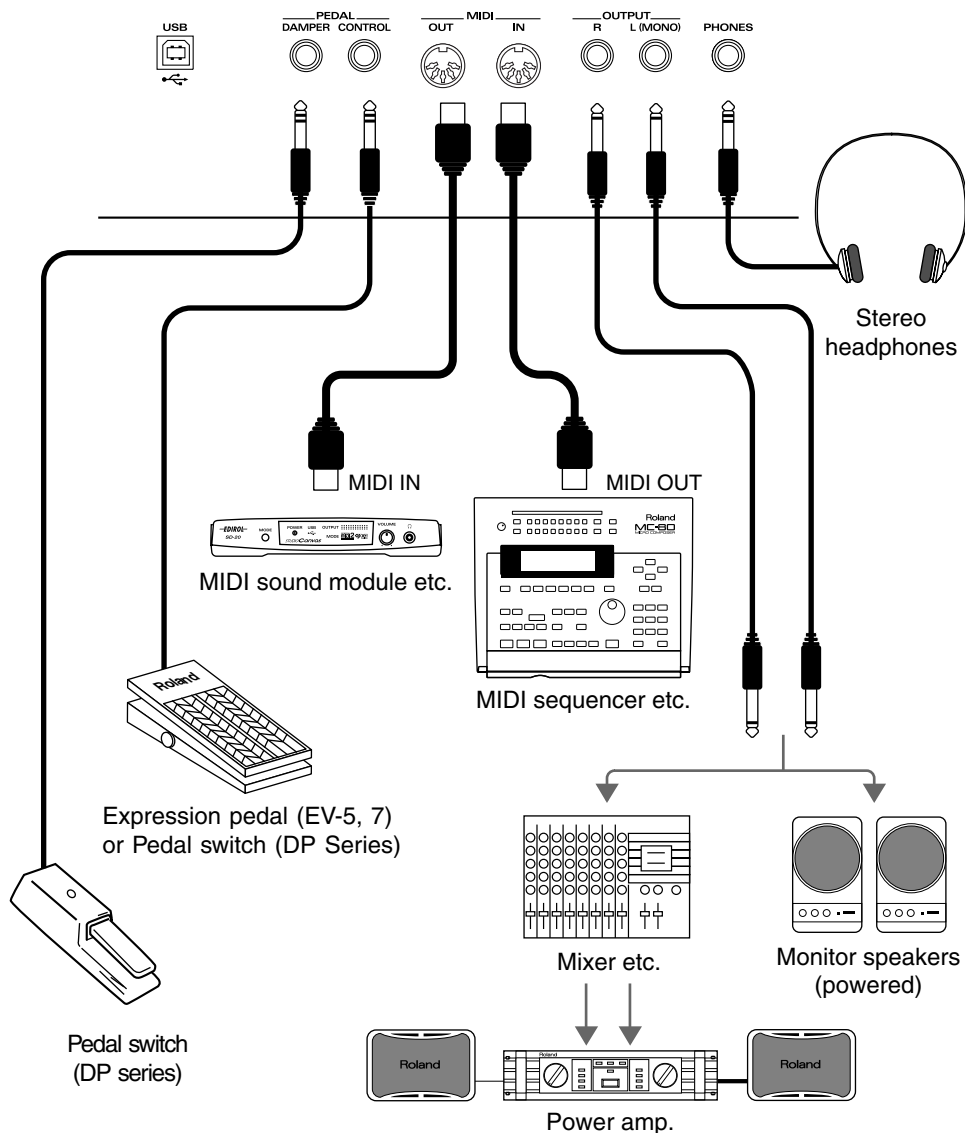

NOTE

To prevent malfunction and/or damage to speakers or other devices, always turn down the volume, and turn off the power on all devices before making any connections.

NOTE

Use Stereo headphones.

NOTE

Use only the specified expression pedal (EV-5, EV-7; sold separately). By connecting any other expression pedals, you risk causing malfunction and/or damage to the unit.

MEMO

Set the switch on the included pedal to "Continuous" when the pedal is connected.

1

Before you begin making connections, confirm the following.

Is the volume level of the RD-300SX or connected amp turned all the way down?

Is the power to the RD-300SX or connected amp turned off?

Connecting Pedals

Connect the pedal included with the RD-300SX to one of the PEDAL jacks.

When connected to the DAMPER jack, the pedal can be used as a damper pedal.

Connecting the pedal to the CONTROL jack allows you to assign a variety of functions to the pedal (p. 40).

Turning the Power On and Off

Once the connections have been completed, turn on power to your various devices in the order specified. By turning on devices in the wrong order, you risk causing malfunction and/or damage to speakers and other devices.

Turning On the Power

1

Before you switch on the power, turn the volume down all the way using the **VOLUME** slider.

Also completely turn down the volume of any connected audio device and other equipment.

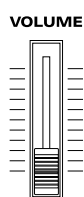

2

Press the **[POWER]** switch on the back of the unit.

The power will turn on, and “Pno” appears in the display.

Rear Panel

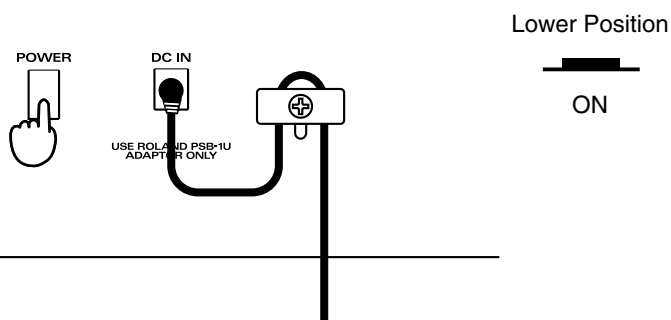

3

Turn on the power to connected external devices.

4

Adjust the volume of the connected external device.

5

Adjust the RD-300SX's volume to obtain the proper volume level.

NOTE

To prevent incorrect functioning of the Pitch Bend Lever (p. 30), refrain from touching the lever when you turn on the power.

NOTE

This unit is equipped with a protection circuit. A brief interval (a few seconds) after power up is required before the unit will operate normally.

Turning Off the Power

1

Before you turn off the power, turn the volume down all the way using the **VOLUME** slider.

Also completely turn down the volume of any connected audio device and other equipment.

2

Turn off the power to connected external devices.

3

Press the [Power] switch on the back of the unit.

The power is switched off.

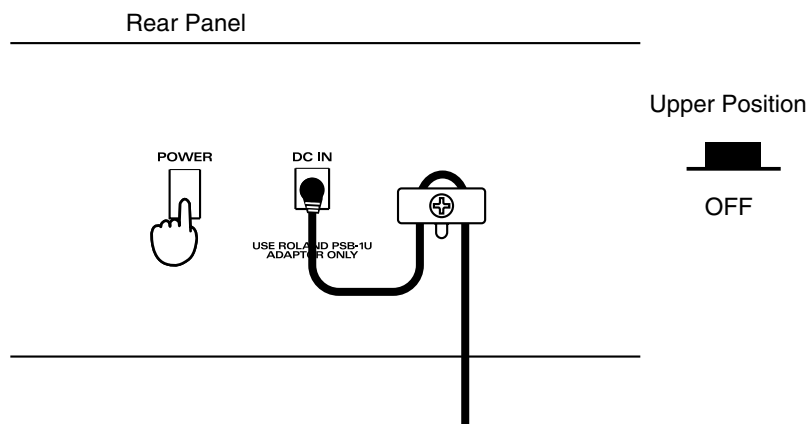

Adjusting the Volume

VOLUME

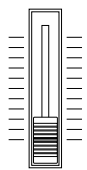

1

Adjust the volume using the **VOLUME** slider.

Move the slider up to increase the volume, or down to lower it.

Also adjust the volume of the connected device to an appropriate level.

Tuning to Other Instruments' Pitches (Master Tune)

For a cleaner ensemble sound while performing with one or more other instruments, ensure that each instrument's standard pitch is in tune with that of the other instruments. In general, the tuning of an instrument is indicated by the pitch in Hertz (Hz) of the middle "A" note.

This matching of other instruments' basic reference pitches is called "tuning."

When the instrument is turned on, the standard pitch is set to "440.0 Hz."

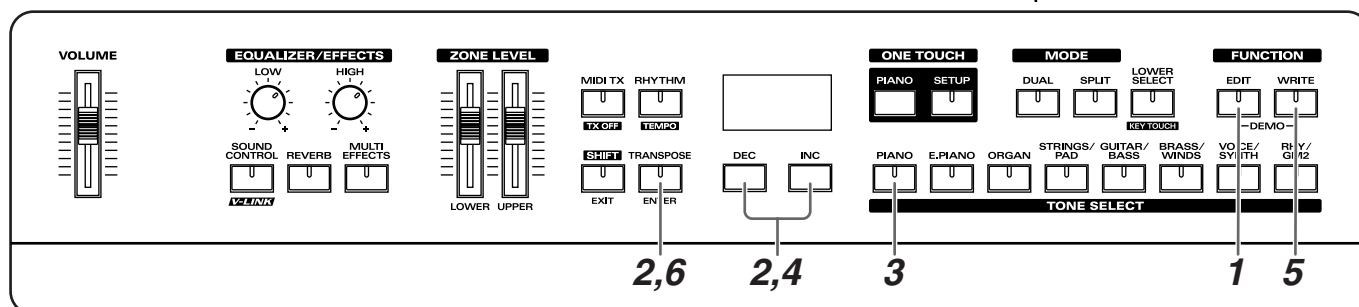

1

Press [EDIT], getting the indicator to light.

The Edit Menu screen appears.

2

Press [INC] or [DEC] to select "System," then press [ENTER].

The TONE SELECT button blinks.

545

3

Press [PIANO].

The parameter name (tun) appears in the display while [PIANO] is held down.

When the button is released, the last three digits of the currently set basic reference pitch are shown in the display.

4

Press [INC] or [DEC] to change the standard pitch.

You can set the standard pitch anywhere in a range of 415.3 Hz to 466.2 Hz.

The pitch is lowered 0.1 Hz each time [DEC] is pressed. When the button is held down, the pitch drops continuously.

The pitch is raised 0.1 Hz each time [INC] is pressed. When the button is held down, the pitch rises continuously.

To return to the original pitch, press [DEC] and [INC] simultaneously.

5

If you want to save the settings, press [WRITE].

A confirmation screen appears.

5ur

6

If you want to continue with the save, press [ENTER].

You can return to Step 2.

MEMO

For faster value increases, keep [INC] pressed down and press [DEC]. For decreasing value faster, keep [DEC] pressed down and press [INC].

MEMO

If this setting has not been saved, it is lost when the power is turned off.

Overview of the RD-300SX

Basic Organization of the RD-300SX

The RD-300SX can be divided into two sections: a keyboard controller section and a sound generator section. The two sections are connected internally by means of MIDI.

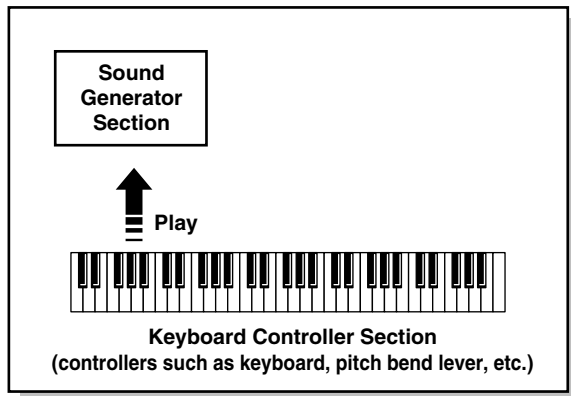

Keyboard Controller Section

This section includes the keyboard, the Pitch Bend/Modulation lever, the panel knobs, and any pedal connected to the rear panel. Actions such as pressing and releasing of keys on the keyboard, depressing a pedal, and so forth, are converted to MIDI messages and sent to the sound generator section, or to an external MIDI device.

Sound Generator Section

The sound generator section produces the sound. Here, MIDI messages received from the keyboard controller section or external MIDI device are converted to musical signals, which are then output as analog signals from the OUTPUT and PHONES jacks.

Units of Sound

Tone

The individual sounds used when playing the RD-300SX are referred to as "Tones."

The RD-300SX has 340 individual tones, and a variety of tones can be used in performances.

Part

A sound generator of this type which can control multiple sounds using one device is referred to as a multitimbral sound generator. The RD-300SX contains a multitimbral sound generator capable of playing sixteen Tones simultaneously.

"Parts" are where Tones that are created when the RD-300SX is used as a sound generator are assigned. Different Tones can be assigned to each of the Parts and controlled individually.

* As these are performances with 16 parts, they require control from external devices via MIDI or USB.

Zone

With the RD-300SX, you can freely control two of the above-mentioned parts using the RD-300SX's buttons and keys; these two parts are referred to as the UPPER zone and LOWER zone. You can layer each zone (Dual Play; p. 21) or play them in different ranges of the keyboard (Split Play; p. 22).

Basic Operation of the RD-300SX

Changing the Settings Values

When changing settings values, you can use [DEC] and [INC].

[DEC], [INC]

Pressing [INC] increases the value, and [DEC] decreases it. Keep the button pressed for continuous adjustment. For faster value increases, keep [INC] pressed down and press [DEC]. For decreasing value faster, keep [DEC] pressed down and press [INC].

Listening to the Demo (Demo Play)

Here's how to listen to the demo songs.

The RD-300SX comes with a total of eleven internal demo songs, including demo songs that utilize and demonstrate the instrument's special qualities, and others that introduce you to the instrument's tones.

No.	Song Name	Composer/Copyright
d-1.	Let's Hang Out	Scott Tibbs © 2004 Roland Corporation
d-2.	RD-300SX Piano	Scott Tibbs © 2004 Roland Corporation
d-3.	Stay Tuned	Scott Tibbs © 2004 Roland Corporation
d-4.	Tone Preview	Scott Tibbs © 2004 Roland Corporation

* With d-4, there is one song in each of the tone categories for a total of eight demo songs.

NOTE

All rights reserved.
Unauthorized use of this material for purposes other than private, personal enjoyment is a violation of applicable laws.

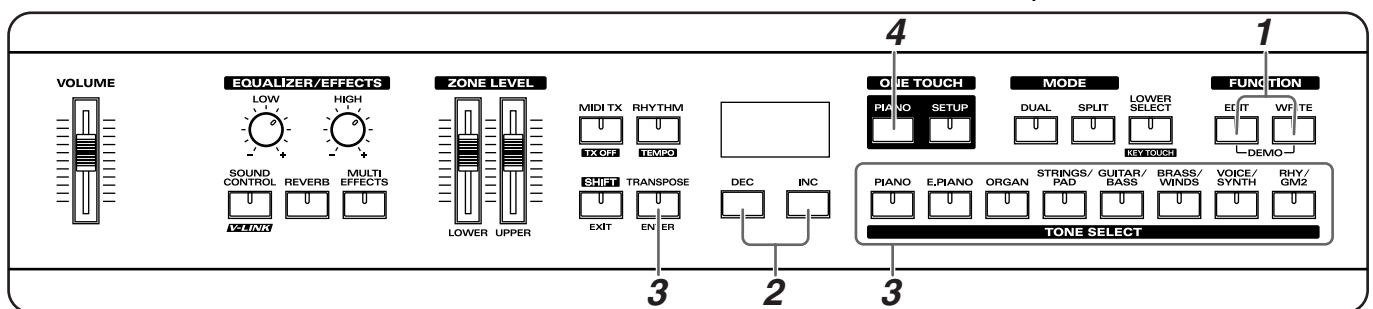

* The current settings are erased when demo song is played. Be sure that any settings you want to keep are saved to a Setup (p. 35).

- 1 Hold down [EDIT] and press [WRITE].

The Demo screen appears.

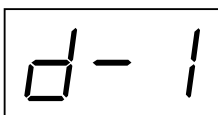

- 2 Press [INC] or [DEC] to select the song you want to hear.

- 3 Press [ENTER] to start the playback of the song.

Playback of all the songs is repeated.

When you press the TONE SELECT button, d-4 is selected, and the demo song using the tone from the category corresponding to the pressed button begins to play.

The selected TONE SELECT button lights up in red.

- 4 To stop a song while it is playing, press ONE TOUCH [PIANO].

NOTE

No data for the music that is played will be output from MIDI OUT.

NOTE

While the demo songs are playing back, playing the keyboard will not produce sound.

Performing with the Keyboard

Piano Performances (ONE TOUCH [PIANO])

Now, try performing with the piano.

With the RD-300SX, you can call up the optimal settings for piano performances with the press of a single button.

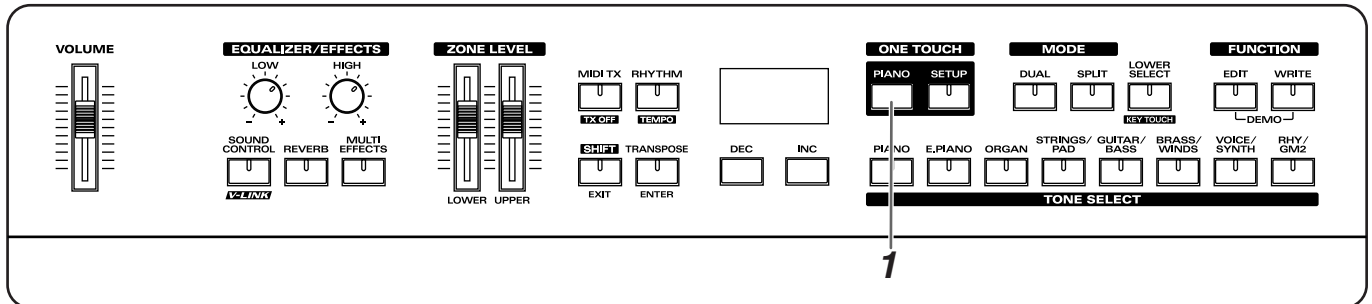

1

Press ONE TOUCH [PIANO].



Pressing ONE TOUCH [PIANO] sets the entire keyboard to play with the piano tone.

With the RD-300SX, you can adjust the keyboard touch to suit your own style of piano performance. For more detailed information, refer to “**Changing the Keyboard’s Touch**” (p. 26).

NOTE

Pressing ONE TOUCH [PIANO] restores all of the settings to their status at the time the power was turned on. If you want to save the settings, store them to a Setup (p. 35).

Performing with a Variety of Tones

The RD-300SX provides 340 types of Tones.

Each one of these individual sounds is called a tone.

Tones are assigned to the TONE SELECT buttons according to the tone category selected.

Try selecting and performing with a number of different tones.

MEMO

For more on the RD-300SX's internal tones, refer to the "Tone List" (p. 60).

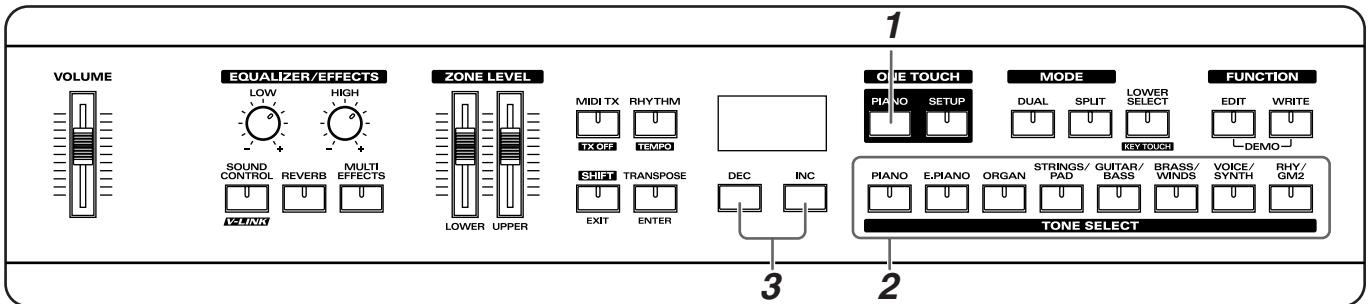

1

Press ONE TOUCH [PIANO].

This selects a single tone to be played over the entire keyboard.

2

Press any of the TONE SELECT buttons to select the tone category.

3

Press [INC] or [DEC] to select the tone.

The TONE SELECT button for the selected category lights.

NOTE

Tones selected with [RHY/GM2] are registered in the following order: "Rhythm Sets," "GM2 Rhythm Sets," and "GM2 Tones." Refer to the "Rhythm Set List" (p. 62).

Playing Multiple Tones with the Keyboard

The RD-300SX features four Internal zones (UPPER and LOWER), and one tone can be assigned to each of these zones.

In each zone used, you can have multiple tones layered and played simultaneously or have different tones played in the left and right parts of the keyboard.

These different ways of using tones are referred to as “keyboard modes.” There are three keyboard modes.

- **Single:** One tone is played for the entire keyboard.
- **Dual:** Two tones are layered and played together.
- **Split:** The keyboard is divided into two separate ranges at a certain key (the split point), with different tones played in the left and right ranges.

The two layered parts played in Dual mode are called the UPPER and LOWER parts. In Split mode, UPPER refers to the part played in the right section of the keyboard, while LOWER refers to the part played in the left section of the keyboard.

UPPER is played over the entire keyboard when the RD-300SX is set to Single mode.

Dual mode

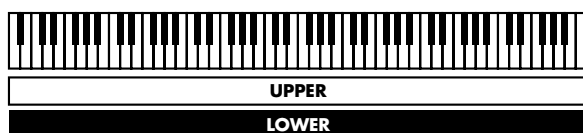

Split mode

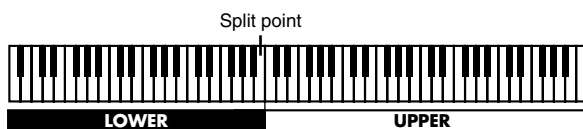

Switching to Single Mode

There are two methods you can use to switch from the multiple-tone modes, Dual and Split mode, to Single mode, in which a single tone is used throughout the entire keyboard.

- **Pressing ONE TOUCH [PIANO]**

This applies the piano tone to the entire keyboard, setting the optimal conditions for piano performances.

However, pressing ONE TOUCH [PIANO] disables any settings made up to that point. Be sure to save any settings you want to keep to a Setup (p. 35) before pressing ONE TOUCH [PIANO].

- **Turning [DUAL] or [SPLIT] off (turning the indicator off)**

In this case, the UPPER tone is applied to the entire keyboard.

Performing with Two Layered Tones ([DUAL])

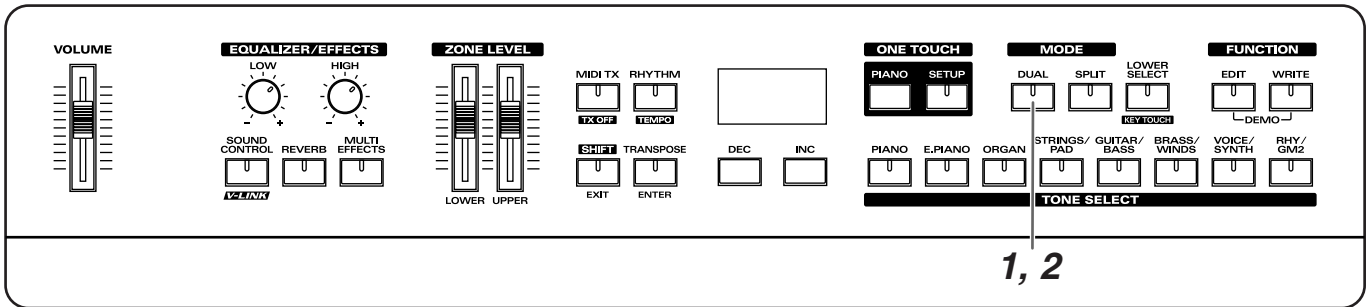

1 Press [DUAL], getting the indicator to light.

Try fingering the keyboard.



The tones for UPPER and LOWER are layered and played.

When you press [DUAL], the [LOWER SELECT] indicator automatically light up, and the LOWER tone number appears in the display. You can display the UPPER TONE number by pressing [LOWER SELECT] so its indicator goes out.

2 Press [DUAL] once more, and the indicator light goes out.

The tone for UPPER played.

Pressing Two TONE SELECT buttons Simultaneously

You can layer two tones by pressing two TONE SELECT buttons simultaneously. For example, if you want to layer a piano sound with strings, together press both [PIANO] and [STRINGS].

[DUAL] starts to flash and when you begin playing the keyboard, the piano and strings sounds are layered together.

When this is done, the tone for the button that is pressed down first (indicator lit in red) is assigned to UPPER, and the other tone (indicator lit in orange) is assigned to LOWER.

Once you have selected two TONE SELECT buttons, pressing either TONE SELECT button then selects that tone as the [UPPER] tone, and the LOWER tone stops playing.

* You cannot layer two tones when [SPLIT] is set to ON.



“Changing the Tone for a Zone” (p. 24)



“Adjust the Volume Level for Individual Zones (ZONE LEVEL sliders)” (p. 24)

Playing Different Tones in Two Different Sections of the Keyboard ([SPLIT])

Such a division of the keyboard into right- and left-hand sections is called a “Split,” and the key where the division takes place is called the “Split Point.” The split-point key is included in the LOWER section.

The Split Point has been set at the factory to “B3.”

MEMO

You can change the split point. Please refer to “**Changing the Keyboard’s Split Point**” (p. 23).

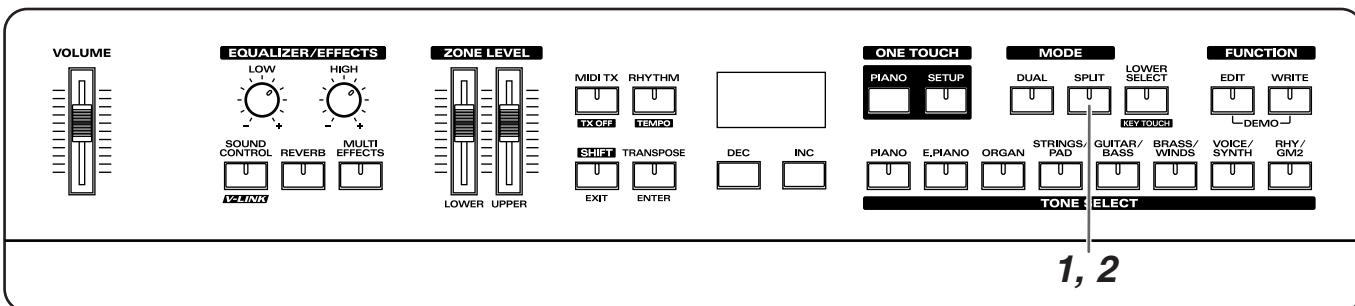

1

Press [SPLIT], getting the indicator to light.

[LOWER SELECT] lights.

Try fingering the keyboard.

The UPPER tone plays in the right-hand section of the keyboard, and the LOWER tone plays in the left-hand section.

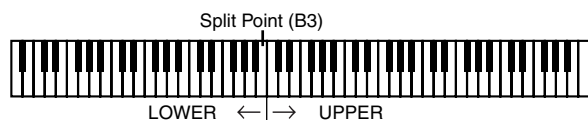

2

To exit Split mode, press [SPLIT] once more, and the indicator light goes out.



“**Changing the Tone for a Zone**” (p. 24)



“**Adjust the Volume Level for Individual Zones (ZONE LEVEL sliders)**” (p. 24)

Changing the Keyboard's Split Point

You can change the point at which the keyboard is divided (the Split Point) in Split mode.

1

Hold down [SPLIT] for several seconds.

A screen such as the following appears, and the current value of the setting is displayed.

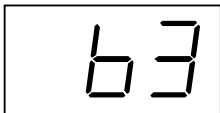

2

While holding down [SPLIT], press the key that you want to use as the split point.

You can adjust the split point in semitone increments.

When you release [SPLIT], the previous display will reappear.

* The split-point key is included in the LOWER section.

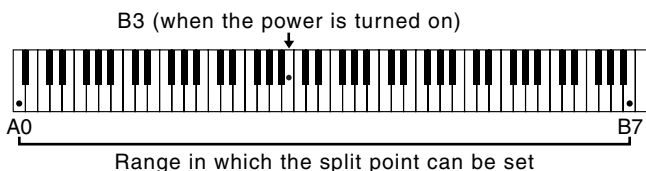

MEMO

You can also change the split point by holding down [SPLIT] and pressing [INC] or [DEC].

MEMO

The key for the split point appears in the display as shown below.

Display	C	C^{\flat}	d	E_{-}
Letter name	C	C#	D	E \flat
Display	E	F	F^{\flat}	G
Letter name	E	F	F#	G
Display	A_{-}	A	b_{-}	b
Letter name	A \flat	A	B \flat	B

Changing the Tone for a Zone

When changing the tone assigned to a zone in Dual or Split mode, use [LOWER SELECT] to specify the zone with the tone you want to change.

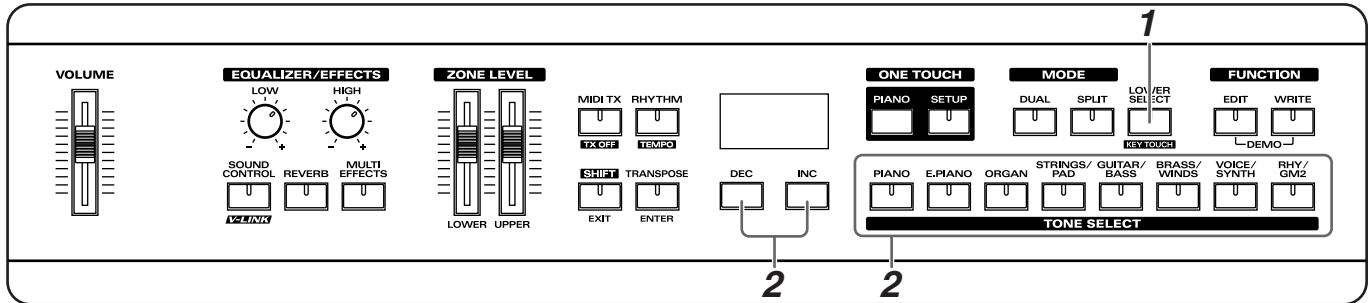

1

If you want to select UPPER, press [LOWER SELECT] until the indicator is off. When you want to select LOWER, press [LOWER SELECT] until the indicator is green.

When selecting the UPPER zone

When selecting the LOWER zone



The TONE SELECT button indicators are red when the UPPER zone is selected and green when the LOWER zone is selected. In either zone, if tones from the same category are selected, the button's indicator lights in orange.

2

Select the tone category with a TONE SELECT button, then select the tone with [INC] or [DEC].



[LOWER SELECT] is disabled when [DUAL] or [SPLIT] is switched off.

Adjust the Volume Level for Individual Zones (ZONE LEVEL sliders)

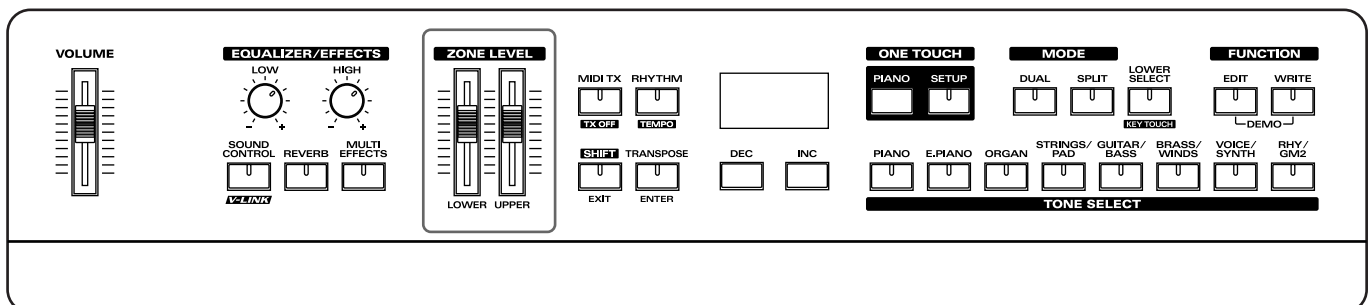

The RD-300SX features two parts you can freely control using the instrument's buttons and keys; these two parts are called the UPPER zone and LOWER zone. You can adjust the volume for each zone using the ZONE LEVEL sliders.

Transposing the Key of the Keyboard ([TRANSCOPE])

You can transpose performances without changing the keys you are playing, as well as change the pitch by an octave. This feature is called "Transpose."

This is a convenient feature to use when you want to match the pitch of the keyboard performance to a vocalist's pitch, or perform using the printed music for trumpets or other transposed instruments.

The reference Transpose setting is C4, and the setting can be adjusted in semitone units in a range of -48-0- +48.

NOTE

Note messages from MIDI IN will not be transposed.

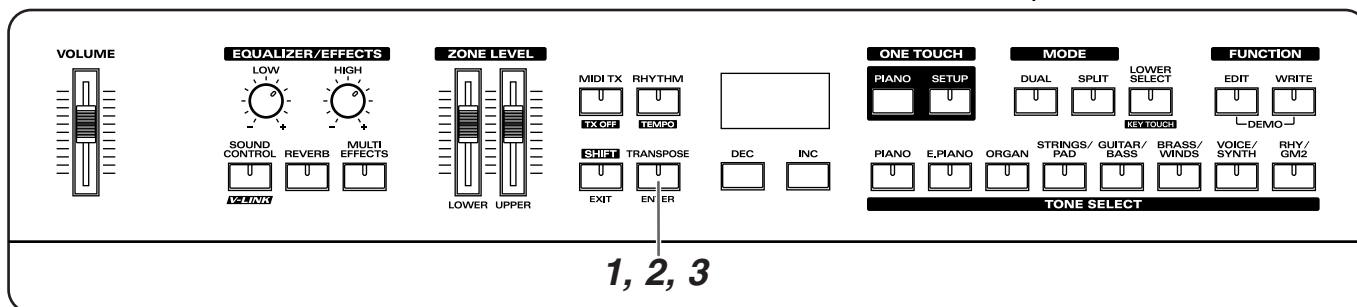

1

Hold down [TRANSCOPE] for several seconds.

A screen such as the following appears, and the current value of the setting is displayed.

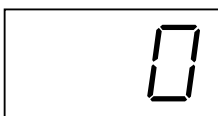

2

Hold down [TRANSCOPE] and press a key.

For example, to have "E" sound when you play "C" on the keyboard, hold down [TRANSCOPE] and press the E4 key. The degree of transposition then becomes "+4." When you release [TRANSCOPE], the previous display will reappear.

When the amount of transposition is set, the Transpose function switches on, and [TRANSCOPE] lights up.

3

To turn off Transpose, press [TRANSCOPE] so that its indicator goes off.

The next time [TRANSCOPE] is pressed, the sound is transposed by an amount corresponding to the value set here.

MEMO

Even when the Transpose function is turned on, the Split Point (p. 23) remains unchanged.

MEMO

You can also change a key by holding down [TRANSCOPE] and pressing [INC] or [DEC].

MEMO

You can make different Key Transpose settings for each zone. Refer to "Changing the pitch of the tone in semitone steps (Key Transpose)" (p. 43).

Changing the Keyboard's Touch

You can change the touch sensitivity, or response of the keys.
When the instrument is turned on, this is set to "M (Medium)."

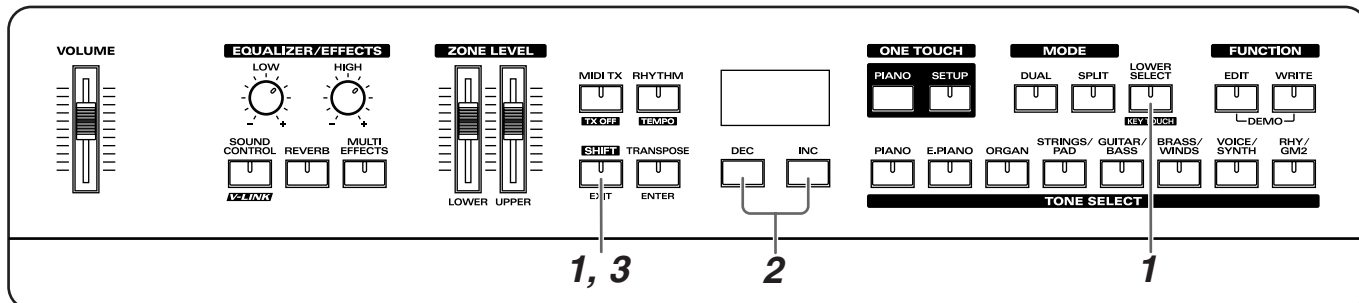

1 Hold down [SHIFT] and press [LOWER SELECT].

[SHIFT] blinks.

The currently selected keyboard touch appears in the display.

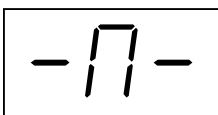

2 Press [INC] or [DEC] to select the touch.

Indicate		Description
	Fixed	The sound plays at one set volume, regardless of the force used to play the keys.
	Light	A light keyboard touch is selected. You can achieve fortissimo (ff) play with a less forceful touch than usual, so the keyboard feels lighter. This setting makes it easy to play, even for children.
	Medium	This sets the standard keyboard touch. You can play with the most natural touch. This is the closest to the touch of an acoustic piano.
	Heavy	Here, a heavy keyboard touch is selected. You have to finger the keyboard more forcefully than usual in order to play fortissimo (ff), so the keyboard touch feels heavier. Dynamic fingering adds even more feeling to what you play.

3 Press [SHIFT], and the indicator light goes out.

NOTE

With certain sounds, the touch may not change.

Changing the Velocity When the Key Touch Is Set to "Fixed"

This sets the velocity the sound will have when the keyboard touch is set to "Fixed."

1 When "OFF" is selected in Step 2 above, holding down [LOWER SELECT] and pressing [INC] or [DEC] changes the velocity of the sound.

You can set this to any value from 1 to 127.

Adding Reverberation to Sounds ([REVERB])

You can apply a reverb effect to the notes you play on the keyboard. With the reverb effect, you obtain a pleasant reverberation, making it sound as if you were performing in a concert hall or similar space.

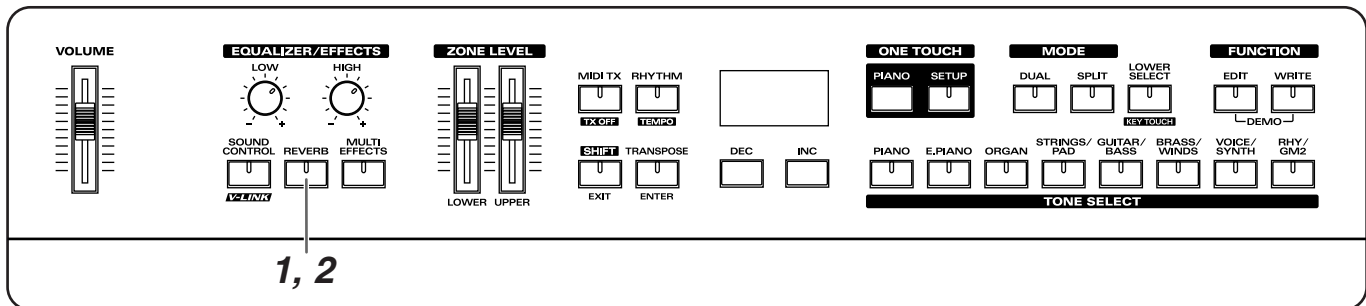

- 1 Press [REVERB], getting its indicator to light.
Try fingering the keyboard.
The reverb effect is applied to the entire tone.

- 2 To eliminate the Reverb effect, press [REVERB] once more, extinguishing the indicator.

Changing the Reverb Effect Type

You can select from four different reverb effect types.

- 1 While holding down [SHIFT], press [REVERB].
- 2 Press [INC] or [DEC] to switch the reverb type.

Displayed	Description
ROOM	Reverb present in normal rooms
HALL	Reverb found in larger halls
CATHEDRAL	Reverb of church cathedrals
GM REVERB	Reverb for use with GM2

- 3 After determining the type, press [SHIFT] to return to the previous screen.

Changing the Depth of Reverb Effect (Reverb Depth)

You can select from 127 levels of depth for the reverb effect.

- 1 Hold down [REVERB] and press [INC] or [DEC] to change the depth of the reverb effect.

MEMO

Reverb depth settings can be made independently for each zone (p. 41).

Adding a Variety Effects to the Sound ([MULTI EFFECTS])

In addition to reverb (p. 27), you can apply a variety of changes to the RD-300SX's sounds. These are referred to as "multi effects." With the RD-300SX, you can select from 78 different effect types.

With the factory default settings, effects have been preselected for each tone.



Effects may not be applied with some of sounds.

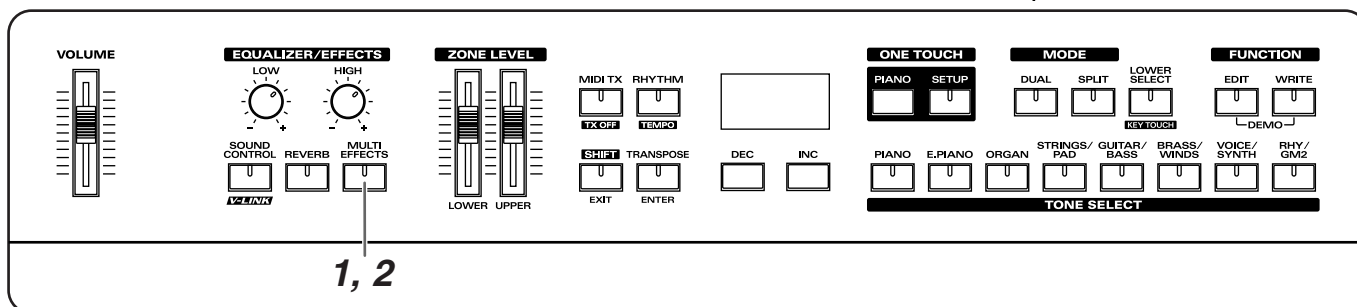

1

Press [MULTI EFFECTS], getting its indicator to light.

Try fingering the keyboard.

The effect is applied to the currently selected tone.

2

To remove the effect, press [MULTI EFFECTS] once more, extinguishing the indicator.



You can specify which zone is to have priority when the effects assigned to the Upper zone and the Lower zone differ. Refer to "Setting the Zone to which Multi Effects are Added (MFX Zone)" (p. 40).

Changing the Depth of Effect

You can change the levels of depth for the effect.

The content and range vary according to the MFX type. For more detailed information, refer to "Effects List" (p. 55).

1

Hold down [MULTI EFFECTS] and press [INC] or [DEC].

The depth for the effect being applied to the currently selected tone appears in the display.

The next time you choose the same tone, the effect with the depth you've selected here is applied.



You can change the effect type. Refer to "Changing the Multi-effects Type" (p. 29).

Changing the Multi-effects Type

- 1** While holding down [SHIFT], press [MULTI EFFECTS].
The effect number appears in the display.
- 2** Press [INC] or [DEC] to select the effect type.
- 3** After determining the type, press [SHIFT] to return to the previous screen.

MEMO

For more on the RD-300SX's internal effect types, refer to the "Effects List" (p. 55).

Adding a Spinning Sound to Organ Tones (Rotary Effect)

The Rotary effect is applied to some Organ tones you can select with the [ORGAN] button. When one of these tones is selected, you can use the [MULTI EFFECTS] button to change the speed of the rotary effect.

What the rotary effect does is to add a "spinning" effect similar to the sound of an organ using a rotating speaker.

- 1** Press [ORGAN] and select the organ tone.
When a tone that has the Rotary effect added is selected, the [MULTI EFFECTS] button's indicator flashes.
- 2** Each time pressing [MULTI EFFECTS], switch the speed of the rotary effect between fast and slow rotation.
When the [MULTI EFFECTS] button's indicator flashes, a more fast rotary effect is applied.
When the [MULTI EFFECTS] button's indicator blinks, a slower rotary effect is applied.

MEMO

To prevent the Rotary effect from being applied, select an effect type other than the Rotary effect and then remove the effect (p. 29).

MEMO

You can apply the rotary effect to tones other than the organ tones as well.

Changing the Sound's Pitch in Real Time (Bender/Modulation Lever)

While playing the keyboard, move the lever to the left to lower the pitch, or to the right to raise the pitch. This is known as Pitch Bend.

You can also apply vibrato by manipulating the lever away from you. This is known as Modulation.

If you move the lever away from you and at the same time move it to the right or left, you can apply both effects simultaneously.

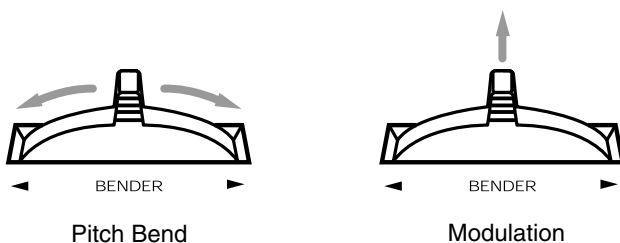

NOTE

The effect obtained when you move the lever may differ according to the tone being used. Additionally, the effect applied by moving the lever is predetermined for each tone, and cannot be changed.

Making a More Consistent Sound ([SOUND CONTROL])

Switching on the Sound Control function suppresses differences in volume for a more consistent sound.

1 Press [SOUND CONTROL], getting its indicator to light.

2 While holding down [SOUND CONTROL], press [INC] or [DEC] to change the type.

Displayed	Description
Hrd Hard Comp	Applies strong compression.
SoF Soft Comp	Applies mild compression.
LoB Low Boost	Boosts the low end.
Mid Mid Boost	Boosts the midrange.
HiB High Boost	Boosts the high end.

3 To remove this function, press [SOUND CONTROL] once more, extinguishing the indicator.

NOTE

Sounds may become distorted with certain tones. In such instances, lower the zone volume.

Adjusting the Level of the Sound's Low and High-Frequency Ranges (EQUALIZER)

The RD-300SX is equipped with a two-band equalizer.

You can adjust the levels of the low-frequency and high-frequency ranges using the EQUALIZER [LOW] and [HIGH] knobs, respectively.

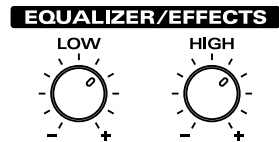
**1**

Turn the EQUALIZER knobs to adjust the levels in each range.

Turning a knob towards the minus (-) sign cuts the level of that frequency range; turn the knob towards the plus (+) sign to boost the level of that range.

NOTE

Equalization is applied to the overall sound output from the OUTPUT jacks.

NOTE

Sounds may distort at certain knob settings. If this occurs, lower the volume level in the zones using the respective ZONE LEVEL sliders.

Using the Convenient Functions in Performances

Playing Rhythm ([RHYTHM])

The RD-300SX features internally programmed drum patterns in a variety of musical genres, including jazz, rock, and more, that you can use as accompaniment for your performances on the RD-300SX. These drum patterns are known as “rhythms.”

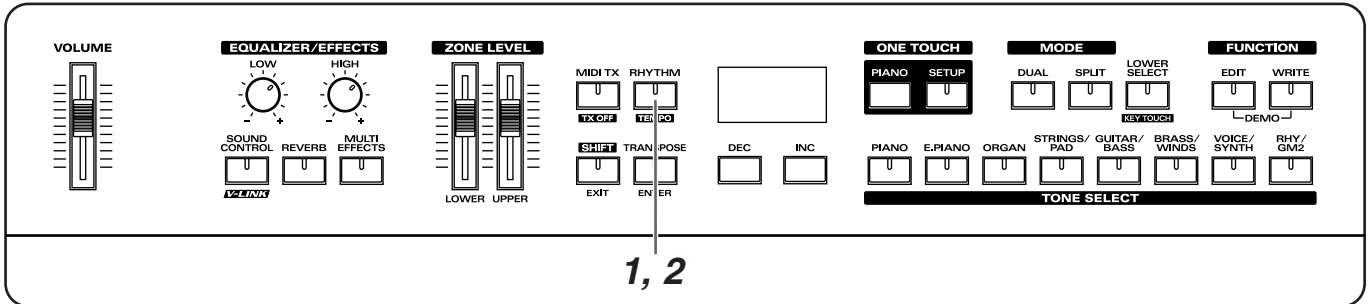

1 Press [RHYTHM] to make the button indicator light.

The Rhythm begins playing.

2 Press [RHYTHM] once more; the indicator goes out, and the Rhythm stops playing.

Changing the Rhythm Pattern

You can select the way a Rhythm is played (the pattern) to match a variety of different musical genres.

1 Press [RHYTHM] to make the button indicator light.

The Rhythm begins playing.

2 While holding down [RHYTHM], press [INC] or [DEC] to select a pattern.
The Rhythm’s pattern changes.

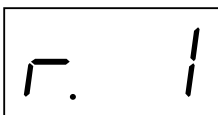

3 If you press [RHYTHM] once more, the indicator light goes out, and the Rhythm stops playing.

MEMO

For more information about the kind of Rhythm Patterns, please refer to “Rhythm Pattern List” (p. 65).

MEMO

Rhythm pattern performance data is not output from the MIDI OUT connector nor the USB connector when MIDI Tx Mode (p. 46) is set to Mode 1.

Changing Rhythm Tempos

- 1** While holding down [SHIFT], press [RHYTHM].
The rhythm tempo is displayed.
- 2** Press [INC] or [DEC] to change the tempo.
The Rhythm are played at the selected tempo.
- 3** Press [SHIFT] to return to the previous screen.

MEMO

The way Rhythm is played and the tempo display may differ with some Rhythm Patterns.

Changing the Rhythm Volume

- 1** While holding down [RHYTHM], move the ZONE LEVEL slider.
The volume of the rhythm changes.

Selecting Stored Settings ([SETUP])

The RD-300SX's tone settings, effect settings, and other such settings are collectively referred to as a "Setup."

Once you've stored your preferred settings, and settings for the songs to be performed as a Setup, you can then switch whole groups of settings during a performance just by switching Setups.

You can store up to 32 different Setups.

The RD-300SX is shipped from the factory with recommended Setups already prepared.

Now try actually calling up a Setup.

NOTE

The current settings are erased when a Setup is called up. Be sure to save any Setup you would like to keep first before calling up another Setup (p. 35).

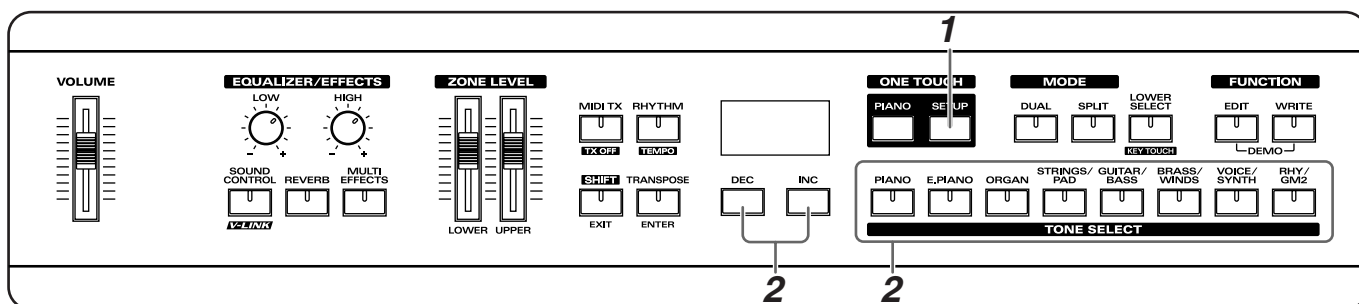

- 1 Press [SETUP], getting the indicator to light.

The Setup screen, shown below, appears in the display.

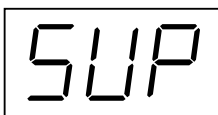

- 2 Press [INC] or [DEC], or TONE SELECT buttons to select a Setup.

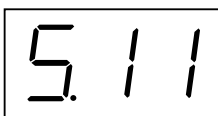

	PIANO	E.PIANO	ORGAN	STRINGS/ PAD	GUITAR/ BASS	BRASS/ WINDS	VOICE/ SYNTH	RHY/ GM2
Setup Number	S.11	S.21	S.31	S.41	S.51	S.61	S.71	S.81
	S.12	S.22	S.32	S.42	S.52	S.62	S.72	S.82
	S.13	S.23	S.33	S.43	S.53	S.63	S.73	S.83
	S.14	S.24	S.34	S.44	S.54	S.64	S.74	S.84

When Selecting with the TONE SELECT Buttons

- 3 Try playing the keyboard.

The settings are switched to those of the Setup that has been called up.



"Setup List" (p. 66)

Storing Settings to Setups ([WRITE])

If you want to use the changed content as a new Setup, use the following procedure to save the settings to a Setup.

You can store 32 Setups on the RD-300SX.

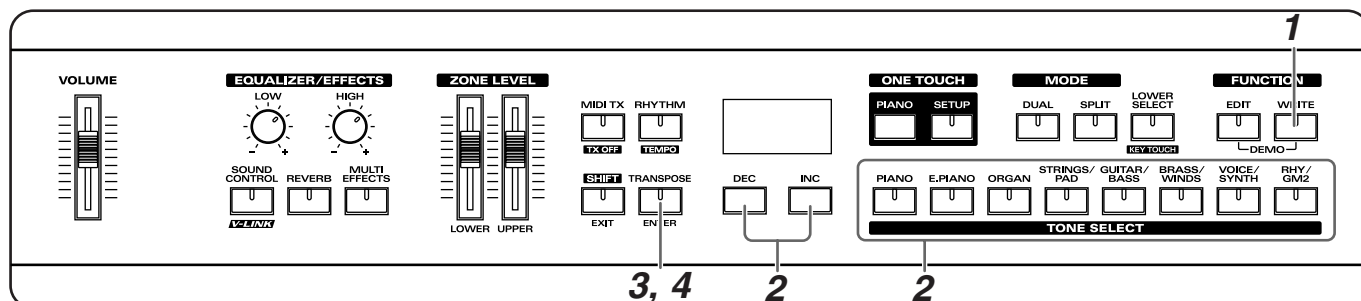

1 Press [WRITE], getting the indicator to light.
The Setup screen appears.

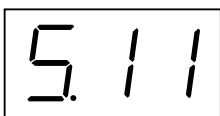

2 Select the save-destination Setup, either by pressing [INC] or [DEC], or TONE SELECT buttons.

3 Press [ENTER].

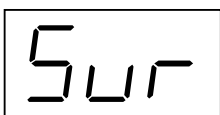

A confirmation screen (Sure?) appears.

If you do not want to save the Setup, press [EXIT] or [WRITE].

The operation is cancelled, and you are returned to the Tone screen.

4 When [ENTER] is pressed, saving of the Setup begins.

When you have finished saving the Setup, the [WRITE] indicator goes out.

You are returned to the Tone screen.

Settings Not Saved in a Setup

The following settings cannot be saved to a Setup.

- System settings (p. 37)
- SOUND CONTROL settings (p. 30)
- EQUALIZER Knob Position (p. 31)
- V-LINK settings (p. 51)
- Transpose (p. 25)

Disabling the Buttons (Panel Lock)

Once Panel Lock is engaged, all buttons (except for the VOLUME slider, ONE TOUCH [PIANO], and the [EXIT] button) will not function. This prevents settings from being changed inadvertently on stage or in other such situations.

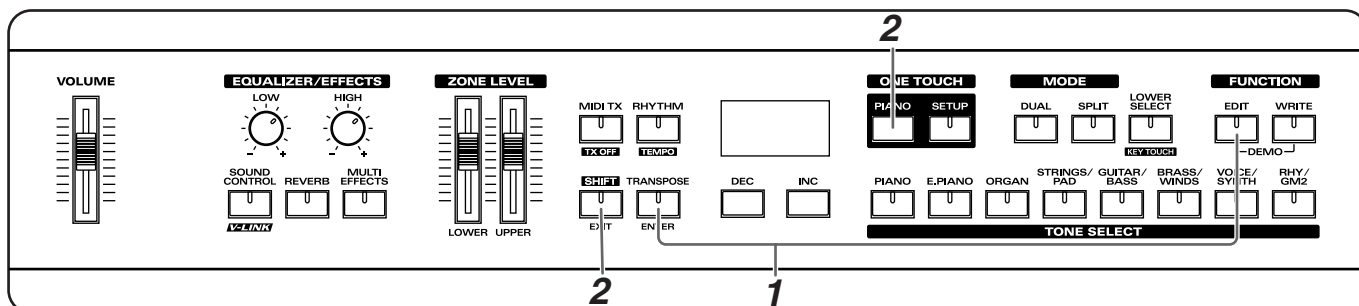

- 1 While holding down [EDIT], press [ENTER].

Then, continue to hold down these two buttons by following display will appear.

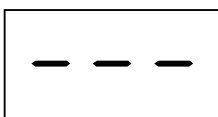

- 2 Press ONE TOUCH [PIANO] or [EXIT] to cancel Panel Lock.

Settings for Each Function ([EDIT])

The process of changing tone parameters to create the tones you like, and changing the settings for various functions is known as “editing.”

When [EDIT] is pressed and the indicator is lit, the RD-300SX switches to “Edit mode.”

You can save edited settings to Setups.

Edited settings are discarded when the RD-300SX’s power is turned off, so be sure that any settings you want to keep are saved to a Setup. For details, refer to “**Storing Settings to Setups ([WRITE])**” (p. 35).

However, you cannot save System content to the Setups. If you want to save changes made to the system, perform the Write procedure separately (p. 37).

Parameters That Can Be Set

You can set the following parameters in Edit mode.

System: Settings related to the functioning of the entire instrument (p. 37)

Master Tune
 Temperament, Key
 Stretch Tune
 Damper Pedal Polarity
 Control Pedal Polarity
 Setup Control Channel
 Setup Pedal Shift
 USB Driver

Common: Settings for pedal functions and other such functions (p. 40)

MFx Zone
 Control Pedal Function

Tone: Tone settings (p. 41)

Cutoff
 Resonance
 Attack Time
 Decay Time
 Release Time
 Reverb Send Level
 Fine Tune
 Bend Range

Upper, Lower Zone: Zone settings (p. 42)

Key Transpose
 Pan
 Damper Pedal Switch
 Control Pedal Switch
 Bender Switch
 Modulation Switch

Part: Part On/Off (p. 43)

1–16

Utility: Settings for backing up, Factory Reset, etc. (p. 44)

Bulk Dump Temporary
 Bulk Dump Setup
 Factory Reset
 TX Mode
 Local Control

* Some tones are set so no effects are applied.

Making System Settings (System)

Functions that affect the RD-300SX’s overall operating environment are called “System functions.”

How to Make Settings

1. Press [EDIT].

The indicator lights, and the RD-300SX switches to Edit mode.

2. Press [INC] or [DEC] to select “System,” then press [ENTER].

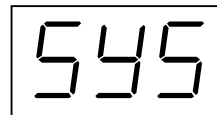

3. Referring to the following, press the TONE SELECT button to which the parameter you want to change is assigned.

The parameter name appears in the display while the button is held down. When the button is released, the value for the parameter is shown in the display.

TONE SELECT button	Indication	Parameter
PIANO		Master Tune (p. 38)
E.PIANO		Temperament, Key (p. 38)
ORGAN		Stretch Tune (p. 38)
STRINGS/ PAD		Damper Pedal Polarity (p. 38)
GUITAR/ BASS		Control Pedal Polarity (p. 39)
BRASS/ WINDS		Setup Control Channel (p. 39)
VOICE/ SYNTH		Setup Pedal Shift (p. 39)
RHY/GM2		USB Driver (p. 39)

4. Press [INC] or [DEC] to set the value.

5. If you want to save the setting, press [WRITE]. Then, press [ENTER].

MEMO

You can return to Step 2 by pressing [EXIT].

NOTE

Unless they have been saved, these settings are lost when the power is turned off.

Settings for Each Function ([EDIT])

Tuning to Other Instruments' Pitches (Master Tuning)

For a cleaner ensemble sound while performing with one or more other instruments, ensure that each instrument's standard pitch is in tune with that of the other instruments. In general, the tuning of an instrument is indicated by the pitch in Hertz (Hz) of the middle "A" note.

The last three digits of the current standard pitch setting appear in the display.

Value
415.3Hz – 466.2Hz (0.1 Hz increments)

Adjusting the Tuning (Temperament, Key)

This sets the tuning and keynote (tonic) for entire parts.

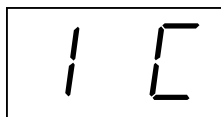

Temperament Keynote

Most modern songs are composed and played with the assumption that equal temperament will be used, but when classical music was composed, there were a wide variety of other tuning systems in existence. Playing a composition with its original tuning lets you enjoy the sonorities of the chords that the composer originally intended.

You can select from eight tunings.

Indication	Tuning	Description
1	Equal Temperament	This tuning divides an octave into 12 equal parts. Every interval produces about the same amount of slight dissonance.
2	Just (Major)	This scale eliminates dissonance in fifths and thirds. It is unsuited to playing melodies and cannot be transposed, but is capable of beautiful sonorities.
3	Just (Minor)	The scales of the major and minor just intonations are different. You can get the same effect with the minor scale as with the major scale.
4	Pythagorean	This scale devised by the philosopher Pythagoras eliminates dissonance in fourths and fifths. Dissonance is produced by third-interval chords, but melodies are euphonious.
5	Kirnberger	This scale is a modification of the meantone and just intonations that permits greater freedom in transposition to other keys. Performances are possible in all keys (III).
6	Mean Tone	This scale makes some compromises in just intonation, enabling transposition to other keys.
7	Werckmeister	This is a combination of the mean tone and Pythagorean scales. Performances are possible in all keys (first technique, III).
8	Arabic	Arabic Scale. This scale is suitable for Arabic music.

Selecting the Keynote

When playing with tuning other than equal temperament, you need to specify the keynote for tuning the song to be performed (that is, the note that corresponds to C for a major key or to A for a minor key). (If you choose an equal temperament, there's no need to select a keynote.)

Set the keynote by holding down [E.PIANO] and pressing [INC] or [DEC].

The selected keynote appears in the display as shown below.

Display	C	D _b	D	E _b	E	F	F [#]	G	A _b	A	B _b	B
Letter name	C	D _b	D	E _b	E	F	F [#]	G	A _b	A	B _b	B

* When performing in ensemble with other instruments, be aware that depending on the key, there may be some shifting of the pitch. Tune the RD-300SX to the fundamental pitch of the other instruments.

Precise Modification of Chord Sonorities (Stretch Tune)

Changes the pitch using the "stretch tuning" method typically used on acoustic pianos. This makes high-range sounds slightly higher in pitch, and low-range sounds slightly lower in pitch.

Indication	Value
OFF	OFF
ON	ON

Switching the Pedal's Polarity (Damper Pedal Polarity)

This switches the polarity of the pedal connected to the PEDAL (DAMPER) jack on the rear panel.

On some pedals, the electrical signal output by the pedal when it is pressed or released is the opposite of other pedals. If your pedal has an effect opposite of what you expect, set this parameter to REVERSE. If you are using a Roland pedal (that has no polarity switch), set this parameter to STANDARD.

Indication	Value
Std	STANDARD
rEu	REVERSE

Switching the Pedal's Polarity (Control Pedal Polarity)

This switches the polarity of the pedal connected to the PEDAL (CONTROL) jack on the rear panel.

On some pedals, the electrical signal output by the pedal when it is pressed or released is the opposite of other pedals. If your pedal has an effect opposite of what you expect, set this parameter to REVERSE. If you are using a Roland pedal (that has no polarity switch), set this parameter to STANDARD.

Indication	Value
STd	STANDARD
rEv	REVERSE

Using Program Change Messages to Switch Setups (Setup Control Channel)

You can switch the RD-300SX's Setups with MIDI messages from an external MIDI device.

Set the MIDI Receive channel for receiving the MIDI messages (Program Changes) from the external MIDI device to be used for switching Setups.

When not switching Setups from an external MIDI device, set this to OFF.

Value
1-16, OFF

NOTE

When the Control Channel settings are transmitted along with the part's MIDI receive channel, switching of Setups takes priority over the switching of tones. For more on program changes for switching Setups, refer to "Switching Setups" (p. 49).

Using the Pedal to Switch Setup (Setup Pedal Shift)

You can use the pedal which is connected to the PEDAL (CONTROL) jack on the rear panel as a dedicated switch for selecting Setup in order.

Indication	Value	Description
OFF	OFF	You can use the pedal function set with Control Pedal Function (p. 40).
ON	ON	This becomes a dedicated switch for switching Setups.

MEMO

The function set with Control Pedal Function (p. 40) cannot be used when this is switched to ON.

Making the Settings for the USB Driver

If you intend to connect to a computer using the USB connector, you need to make the following setting before you make the connection.

NOTE

After changing settings, turn the power off and then on again.

MEMO

There is no need to use the Write procedure for the USB Driver settings.

Indication	Value	Description
OrG	Original	Select this when using the supplied driver with a USB connection.
GEr	Generic	Select this when using a generic USB driver included with the OS with a USB connection.

Settings for Each Function ([EDIT])

Setup-Related Settings (Common)

How to Make Settings

1. Press [EDIT].
The indicator lights, and the RD-300SX switches to Edit mode.
2. Press [INC] or [DEC] to select "Common," then press [ENTER].



3. Referring to the following, press the TONE SELECT button to which the parameter you want to change is assigned.
The parameter name appears in the display while the button is held down. When the button is released, the value for the parameter is shown in the display.

TONE SELECT button	Indication	Parameter
PIANO		MFX Zone (p. 40)
E.PIANO		Control Pedal Function (p. 40)
ORGAN	—	—
STRINGS/ PAD	—	—
GUITAR/ BASS	—	—
BRASS/ WINDS	—	—
VOICE/ SYNTH	—	—
RHY/GM2	—	—

MEMO

Only the indicators of buttons to which a parameter is assigned blink.

4. Press [INC] or [DEC] to set the value.
5. Press [EDIT] to turn off the indicator and quit editing.

MEMO

You can return to Step 2 by pressing [EXIT].

Setting the Zone to which Multi Effects are Added (MFX Zone)

This specifies which zone is to have priority when the effects assigned to the Upper Tone and Lower Tone differ in Split mode or Dual mode (p. 20).

Indication	Description
	UPPER
	LOWER

* If same effects are assigned to the Upper Tone and Lower Tone, the same effects are added to both of Tones.

Changing the Pedal Function (Control Pedal Function)

This sets the function of the pedal switch or expression pedal (such as the optional EV-5) connected to the CONTROL jack on the rear panel.

MEMO

This function cannot be used when Setup Pedal Shift is switched to ON (p. 39).

Indication	Description
	Soft (Default)
	Sostenuto
	Expression
	Rhythm Start/Stop
	Multi-effects ON/OFF
	Modulation

Tone Settings (Tone Parameter)

How to Make Settings

1. Press [EDIT].
The indicator lights, and the RD-300SX switches to Edit mode.
2. Press [INC] or [DEC] to select "Tone," then press [ENTER].

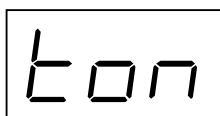

3. Referring to the following, press the TONE SELECT button to which the parameter you want to change is assigned.
The parameter name appears in the display while the button is held down. When the button is released, the value for the parameter is shown in the display.

MEMO

When setting the LOWER zone, set [LOWER SELECT] to ON.

TONE SELECT button	Indication	Parameter
PIANO		Cutoff (p. 41)
E.PIANO		Resonance (p. 41)
ORGAN		Attack Time (p. 41)
STRINGS/ PAD		Decay Time (p. 41)
GUITAR/ BASS		Release Time (p. 41)
BRASS/ WINDS		Reverb Send Level (p. 41)
VOICE/ SYNTH		Fine Tune (p. 42)
RHY/GM2		Bend Range (p. 42)

MEMO

Only the indicators of buttons to which a parameter is assigned blink.

4. Press [INC] or [DEC] to set the value.
5. Press [EDIT] to turn off the indicator and quit editing.

MEMO

You can return to Step 2 by pressing [EXIT].

Changing Tone Elements (Cutoff/Resonance/Attack Time/ Decay Time/Release Time)

You can make changes in tones by adjusting the settings of the following five elements.

- Cutoff:** Adjusts how much the filter is opened.
- Resonance:** This boosts the portions in the region around the cutoff frequency, lending a particular quality to the sound. Excessively high settings can produce oscillation, causing the sound to distort.
- Attack Time:** The time it takes after the key is pressed for a sound to reach full volume.
- Decay Time:** The time it is to take following the attack for the volume to decrease.
- Release Time:** The time it takes after the key is released for a sound to become inaudible.

NOTE

Making abrupt changes in the settings values may cause the sound to become distorted or overly loud. Carefully monitor volume levels while making the settings.

Parameter	Value	Description
Cutoff	-64-0- +63	Higher values brighten the sound; lower values make the sound seem darker.
Resonance	-64-0- +63	Higher value makes the special quality of the sound stronger; lower value reduce these characteristics.
Attack Time	-64-0- +63	Higher values produce a milder attack; lower values produce a sharper attack.
Decay Time	-64-0- +63	The time it takes for the volume to fall increases as the value is raised; lowering the value decreases the decay time.
Release Time	-64-0- +63	Higher values produce longer decay; set lower values for a clear-cut sound.

NOTE

The effect may not be apparent with some tones, even when the value is changed.

Setting the Amount of Reverb Applied to Each Tone (Reverb Send Level)

This sets the depth of the reverb effect for each tone.

NOTE

When this value is set to "0," no effect is applied even when [REVERB] is pressed.

MEMO

You can also make the setting by holding down [REVERB] and adjusting the ZONE LEVEL slider.

Value
0-127

Settings for Each Function ([EDIT])

Changing the Pitch (Fine Tune)

Adjusts the pitch of the tone's sound up or down in 1-cent steps (+/-50 cents).

Value
-50 – 50 (cent)

MEMO

One cent is 1/100th of a semitone.

Changing the Bend Range (Bend Range)

This sets the amount of pitch change that will occur when you move the Pitch Bend lever in semitone increments (+/-2 octaves).

Value
0–24

Making the Settings for Each Zone Individually (Zone Parameter)

How to Make Settings

1. Press [EDIT].
The indicator lights, and the RD-300SX switches to Edit mode.
2. Press [INC] or [DEC] to select "U-L," then press [ENTER].

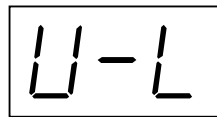

3. Referring to the following, press the TONE SELECT button to which the parameter you want to change is assigned.

The parameter name appears in the display while the button is held down. When the button is released, the value for the parameter is shown in the display.

MEMO

When setting the LOWER zone, set [LOWER SELECT] to ON.

TONE SELECT button	Indication	Parameter
PIANO		Key Transpose
E.PIANO		Pan
ORGAN		Damper Pedal Switch
STRINGS/ PAD		Control Pedal Switch
GUITAR/ BASS		Bender Switch
BRASS/ WINDS		Modulation Switch
VOICE/ SYNTH	—	—
RHY/GM2	—	—

MEMO

Only the indicators of buttons to which a parameter is assigned blink.

4. Press [INC] or [DEC] to set the value.
5. Press [EDIT] to turn off the indicator and quit editing.

MEMO

You can return to Step 2 by pressing [EXIT].

Changing the pitch of the tone in semitone steps (Key Transpose)

Value
-48—0—48

Setting the Pan

The Pan setting localizes the sound image of each part when the output is in stereo. With an increase in the value for L, more of the sound will be heard as coming from the left side. Similarly, more of the sound will originate at the right if the value of R is increased. When set to 0, the sound is heard as coming from the center.

Value
L64—0—R63

Turning Each Controller On and Off

These settings determine whether each individual part is controlled (ON), or not (OFF) by the pedals connected to each PEDAL jack (DAMPER, CONTROL), the Modulation lever, and the Bender.

Parameter	Value
Damper Pedal Switch	OFF, ON
Control Pedal Switch	
Pitch Bender Switch	
Modulation Switch	

Part On/Off (Part)

You can choose whether or not to have messages from external MIDI devices be received by each individual part.

1. Press [EDIT].
The indicator lights, and the RD-300SX switches to Edit mode.
2. Press [INC] or [DEC] to select "Part," then press [ENTER].

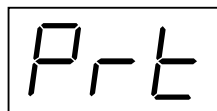

3. Referring to the following, press the TONE SELECT button to which the part number you want to change is assigned. Press [LOWER SELECT] so that the indicator lights to select Part 9–16.

The channel number appears in the display while the button is held down. When the button is released, the status of the channel (on/off) is shown in the display.

TONE SELECT button	Part	Part
	LOWER SELECT=OFF	LOWER SELECT=ON
PIANO	1	9
E.PIANO	2	10
ORGAN	3	11
STRINGS/PAD	4	12
GUITAR/BASS	5	13
BRASS/WINDS	6	14
VOICE/SYNTH	7	15
RHY/GM2	8	16

4. Press [INC] or [DEC] to switch the setting to ON or OFF.

MEMO

The indicator for the currently selected part flashes, while the indicator for a part that is ON lights steadily.

5. Press [EDIT] to turn off the indicator and quit editing.

MEMO

You can return to Step 2 by pressing [EXIT].

NOTE

On the RD-300SX, UPPER is fixed as Part 1 (Ch 1), while LOWER is fixed as Part 2 (Ch 2). Note that the keyboard won't produce sound if Parts 1 and 2 are set to OFF.

Settings for Each Function ([EDIT])

Utility Settings (Utility)

Transferring Setups to External Devices (Setup Bulk Dump)

You can transfer the contents of Setups to an external MIDI device. This operation is called “bulk dump.”

Use this procedure to save the data to an external MIDI device in situations such as when you want to perform by connecting another RD-300SX with the same settings, or to prevent your Setups from corruption.

1. **Connect the RD-300SX and the external sequencer, using an optional MIDI or USB cable (sold separately).**
2. **Press [EDIT].**
The indicator lights, and the RD-300SX switches to Edit mode.
3. **Press [INC] or [DEC] to select “Utility,” then press [ENTER].**



4. **Referring to the following, press the TONE SELECT button to which the parameter you want to change is assigned, then select the parameter.**

TONE SELECT button	Indication	Description
PIANO		Bulk Dump Temporary (p. 44).
E.PIANO		Bulk Dump Setup (p. 44).
ORGAN		Factory Reset (p. 45).
STRINGS/ PAD		TX Mode (p. 46)
GUITAR/ BASS		Local Control (p. 46)
BRASS/ WINDS	—	—
VOICE/ SYNTH	—	—
RHY/GM2	—	—

MEMO

Only the indicators of buttons to which a parameter is assigned light.

NOTE

Stop the rhythms and do not touch the keys or controllers when performing the Bulk Dump procedure.

Bulk Dump Temporary

The content of the currently selected Setup is transmitted.

5. **Press [PIANO].**

The following screen appears, and [PIANO] flashes.



6. **Put the external sequencer in record mode.**
7. **Press [ENTER].**
A confirmation screen (Sure?) appears.
If you do not want to transmit the settings, press [EXIT].
8. **Press [ENTER] again to transmit the settings.**
When the transfer is completed, you can return to Step 3.
9. **Stop the external sequencer.**

Bulk Dump Setup

The content of all Setups is transmitted.

5. **Press [E.PIANO].**

The following screen appears, and [E.PIANO] flashes.

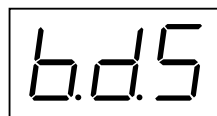

6. **Put the external sequencer in record mode.**
7. **Press [ENTER].**
A confirmation screen (Sure?) appears.
If you do not want to transmit the settings, press [EXIT].
8. **Press [ENTER] again to transmit the settings.**
When the transfer is completed, you can return to Step 3.
9. **Stop the external sequencer.**

Restoring Saved Settings to the RD-300SX

When returning settings saved to an external sequencer back to the RD-300SX, an Exclusive message is transmitted from the external sequencer, then the data is received by the RD-300SX.

NOTE

Be aware that when you restore Setups data to the RD-300SX, the data in the RD-300SX will be overwritten and lost.

- 1. Connect the RD-300SX and the external sequencer, using an optional MIDI or USB cable (sold separately).**
- 2. Make sure that [EDIT] indicator is extinguished.**
If the [EDIT] indicator is lit, press [EDIT] to turn the indicator light off and put the RD-300SX in normal performance mode.
- 3. Transmit (play back) the data from the external sequencer.**

NOTE

After playback of the Bulk Dump Setup data, the RD-300SX writes the data to the internal memory. Be sure never to turn off the power while this data is being written.

MEMO

For details on transmitting exclusive data, refer to the owner's manual for your sequencer.

Restoring the settings to the factory condition (Factory Reset)

The settings stored in the RD-300SX can be returned to their factory settings.

NOTE

Executing "Factory Reset" results in deletion of the Setups (p. 34) and the System (p. 37). If you want to keep any data you have stored, use the "Bulk Dump Setup" operation to save the data to an external sequencer (p. 44).

* *You cannot save the System settings by Bulk Dump.*

- 1. Press [EDIT].**
The indicator lights, and the RD-300SX switches to Edit mode.
- 2. Press [INC] or [DEC] to select "Utility," then press [ENTER].**

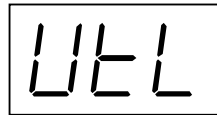

- 3. Press [ORGAN].**

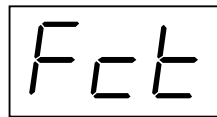

- 4. Press [ENTER].**
A confirmation screen (Sure?) appears.
To cancel the Factory Reset, press [EXIT].
- 5. Press [ENTER] again to start the Factory Reset operation.**
When the Factory Reset is completed, you can return to Step 2.

NOTE

Never turn off the power during Factory Reset.

Settings for Each Function ([EDIT])

Setting the MIDI Tx Mode

By setting the MIDI Tx Mode, you can select to have a more suitable (to the external MIDI device) selection of MIDI data be output from the RD-300SX when you make tone changes on the RD-300SX.

"Mode 1" is the power-up default setting.

Indication	Value	Description
<code>nd.1</code>	Mode1	This setting is suited for connecting to a sound module. The MIDI information (for example: Program change) is not output from the RD-300SX when you make a tone change on the RD-300SX.
<code>nd.2</code>	Mode2	This setting is suitable for the connection of sequencers. The MIDI information (for example: Bank select, Program Change, Settings of Effects, and so on) is output from the RD-300SX when you make a tone change on the RD-300SX.

NOTE

The MIDI Tx button is disabled in Mode 2.

Switching Local Control On and Off

When connecting a MIDI sequencer, set Local Control to "Off."

When the instrument is turned on, this is set to "On."

As illustrated, information describing what has been played on the keyboard is passed to the internal sound generator over two different routes, (1) and (2). As a result, you hear overlapping or intermittent sounds. To prevent this from happening, route (1) must be severed, by setting the unit to what is known as "Local Off."

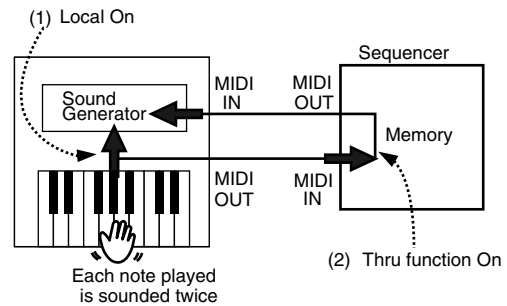

Local Control ON: The keyboard and the internal sound generator are in a linked state.

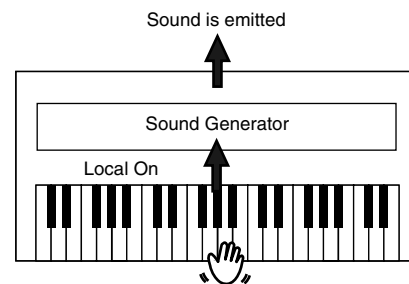

Local Control OFF: The keyboard and the internal sound generator are in an unlinked state. No sound will be produced by the keyboard when it is played.

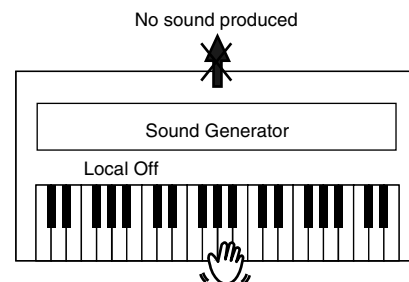

Indication	Value
<code>off</code>	OFF
<code>on</code>	ON

Connecting External MIDI Devices

What's MIDI?

MIDI (Musical Instrument Digital Interface) is a standard specification that allows musical data to be exchanged between electronic musical instruments and computers. By using a MIDI cable to connect devices that have MIDI connectors, you can create an ensemble in which a single MIDI keyboard can play multiple instruments, or change settings automatically as the song progresses.

About MIDI Connectors

The RD-300SX has the following two types of MIDI connector. Their functions differ as described below.

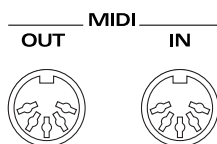

MEMO

For instructions on connecting the external devices, refer to "Connecting the RD-300SX to External Equipment" (p. 12).

MIDI IN Connector

Performance messages from an external MIDI device are received here. These incoming messages may instruct the RD-300SX to play sounds or switch tones.

MIDI OUT Connector

MIDI messages are transmitted from this connector to external MIDI devices. The RD-300SX's MIDI OUT connector is used for sending the performance data of the keyboard controller section as well as data used for saving various settings and patterns (Bulk Dump → p. 44).

Connecting to External MIDI Sound Generators

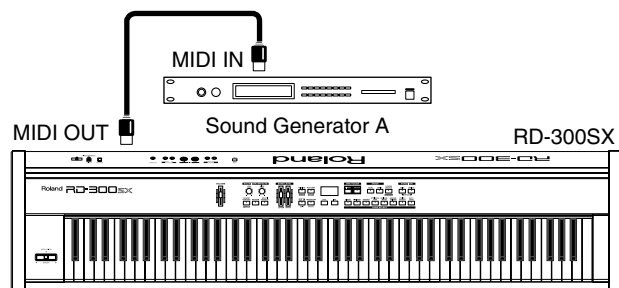

Using the RD-300SX As a Master Keyboard

By connecting an external MIDI device to the MIDI OUT connector on the RD-300SX's rear panel, you can then control the external MIDI device with the RD-300SX.

Normally, the RD-300SX transmits Note messages from the MIDI OUT connector, but you can control not only Note messages, but a variety of other external MIDI device settings as well.

Make the following settings if you do not want to have MIDI messages transmitted.

1. Hold down [SHIFT] and press [MIDI Tx].
2. Press [INC] or [DEC] to switch the setting to ON or OFF.

* To enable transmission, set this to ON.

NOTE

This button is disabled when Tx Mode is set to Mode 2.

Selecting Sounds on an External MIDI Device

To switch the tones of an external MIDI device, enter the program number and the MSB/LSB of the Bank Select message as numerical values on the RD-300SX.

1. Press [MIDI Tx].
2. Referring to the following, press the TONE SELECT button to which the parameter you want to change is assigned, then select the parameter.

If you want to change the sounds, press [ORGAN] first to send the Program Change message.

TONE SELECT button	Indication	Parameter
PIANO	MSb	Bank Select MSB
E.PIANO	LSb	Bank Select LSB
ORGAN	PC	Program Change
STRINGS/ PAD	Pan	Pan
GUITAR/ BASS	rEv	Reverb Send
BRASS/ WINDS	Cho	Chorus Send
VOICE/ SYNTH	trd	Key Transpose
RHY/GM2	Ch	MIDI Ch

NOTE

If the RD-300SX transmits a Program number or a Bank number for which no Tone has been assigned, an alternate Tone may be selected, or in some cases, there may be no sound played. If you do not want to transmit the Program number or Bank Select, set the MSB/LSB to "--- (OFF)."

Connecting External MIDI Devices

3. Press [INC] or [DEC] to change the parameter values.

Pressing [INC] and [DEC] simultaneously switches the settings value to “--- (OFF).” When this setting is “--- (OFF),” program numbers or bank select messages will not be transmitted.

MEMO

When setting the LOWER zone, set [LOWER SELECT] to ON.

Parameter	Tx	Value
Bank Select MSB	CC 00	0-127, --- (OFF)
Bank Select LSB	CC 32	0-127, --- (OFF)
Program Change	Program Change	0-127, --- (OFF)
Pan	CC10	L64-0-63R, --- (OFF)
Reverb Send	CC91	--- (OFF), 0-127
Chorus Send	CC93	--- (OFF), 0-127
Key Transpose	---	-48-0- +48
MIDI Ch	---	1-16

Recording RD-300SX Performances to an External MIDI Sequencer

Now, try using an external sequencer to record your music onto multiple tracks, and then play back the recorded performance.

Connecting to an External Sequencer

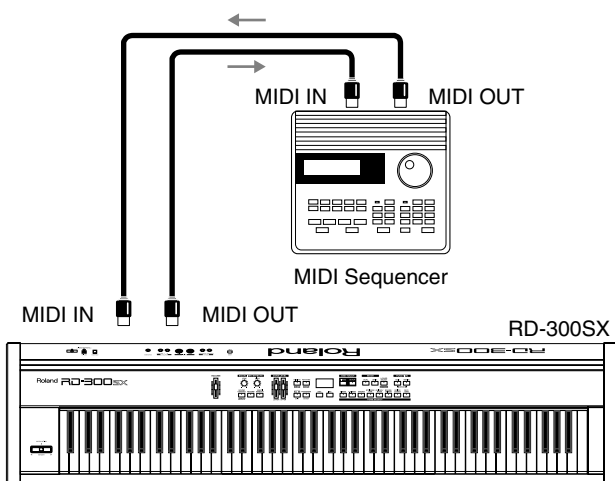

1. Before starting the connection procedure, make sure that the power to all devices has been turned off.
2. After reading “Connecting the RD-300SX to External Equipment” (p. 12), connect an audio device/system or headphones.
3. Connect the external MIDI sequencer with the MIDI cable as shown in the figure above.
4. As described in “Turning On the Power” (p. 13), turn on the power of each device.

Settings for Recording

When recording to an external sequencer, it is convenient if you set MIDI TX Mode to Mode2. When using this function, you can get the most suitable settings for recording the RD-300SX’s data to an external sequencer, without having to make all the Part and channel settings.

For more detailed information on how to make the settings, refer to “Setting the MIDI Tx Mode” (p. 46).

Recording the Performance

Use the following procedure when recording to an external sequencer.

1. Turn on the external sequencer’s Thru function and turn off the RD-300SX’s local control.
For details, refer to the section “Switching Local Control On and Off” (p. 46).
Refer to your sequencer owner’s manual for instructions on how to carry out this procedure.
2. Select the Setup for the performance to be recorded.
For instructions on selecting the Setup, refer to p. 34.
3. Use the procedure described in the previous section “Settings for Recording” to make the MIDI Tx Mode settings to Mode2.
4. Begin recording with the external sequencer.
5. Bulk Dump the Setup.
Transmit the contents of the selected Setup to the external sequencer.
For instructions on carrying out this operation, refer to “Transferring Setups to External Devices (Setup Bulk Dump)” (p. 44).
6. Perform on the RD-300SX.
7. When the performance is finished, stop recording with the external sequencer.
Recording is now complete.
You can then listen to the recorded performance by playing it back on the external sequencer.

Playing the RD-300SX's Internal Sound Generator from an External MIDI Device

Try Playing the RD-300SX from an External MIDI Device.

Making Connections

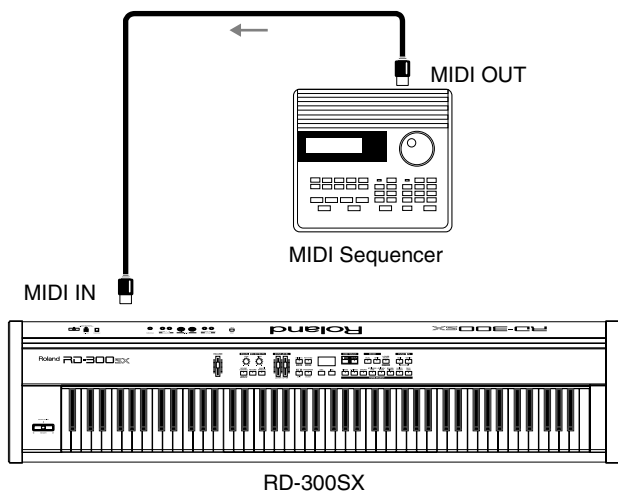

1. Before starting the connection procedure, make sure that the power to all devices has been turned off.
2. After reading “Connecting the RD-300SX to External Equipment” (p. 12), connect an audio device/system or headphones.
3. Connect the external MIDI device with the MIDI cable as shown in the figure above.
4. As described in “Turning the Power On and Off” (p. 13), turn on the power of each device.

Selecting RD-300SX Sounds from an External MIDI Device

Transmitting Bank Select (Controller Number 0, 32) and Program Change messages from the external MIDI device to the RD-300SX allows you to switch Setups and Tones.

cf.

Switching Tones (p. 19, p. 60)

Switching Setups

The MIDI messages transmitted by the external MIDI device will be received by the RD-300SX to select Setups as shown in the following table.

Number	Bank Select		Program Change Number
	MSB	LSB	
1–32	85	0	1–32

When switching Setups, the MIDI channel of the transmitting device must be matched to the RD-300SX's controller channel (p. 39).

When switching individual parts, match the MIDI channel of the transmitting device to the RD-300SX's receive channel. However, if the same channel is set for both the control channel and receive channel, the control channel takes priority, resulting in Setups being switched.

Connecting to Your Computer via USB (USB Mode)

Switching USB Drivers

What is the USB MIDI Driver?

The USB MIDI Driver is a software which passes data between the RD-300SX and the application (sequencer software, etc.) that is running on the USB-connected computer.

The USB MIDI Driver sends data from the application to the RD-300SX, and passes data from the RD-300SX to the application.

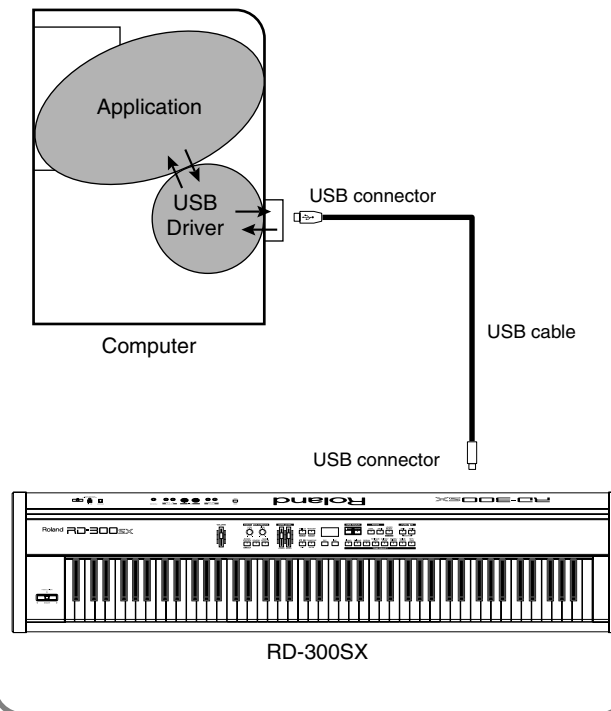

When a computer is connected to the USB connector, you can determine the USB driver to be used as follows:

1. Press [EDIT].
The indicator lights, and the RD-300SX switches to Edit mode.
2. Press [INC] or [DEC] to select "System," then press [ENTER].

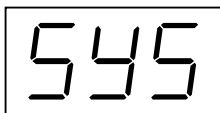

3. Press [RHY/GM2].

4. Press [INC] or [DEC] to set the value.

Display	Value	Description
	Original	Select this when using the supplied driver with a USB connection.
	Generic	Select this when using a generic USB driver included with the OS with a USB connection.

5. After changing settings, turn the power off and then on again.

MEMO

There is no need to use the Write procedure for the USB Driver settings.

Exchanging MIDI Messages with Your Computer

You can use a USB connector to connect the RD-300SX to your computer. For more details, refer to the separate "USB Installation Guide."

- * Connecting your computer to the RD-300SX for the first time requires installation of the "USB Driver" (on the included CD-ROM) to the computer. For more details, refer to the separate "USB Installation Guide."
- * Only MIDI data can be transmitted using USB.
- * To prevent malfunction and/or damage to speakers or other devices, always turn down the volume, and turn off the power on all devices before making any connections.
- * USB cables are not included. Consult your Roland dealer if you need to purchase.
- * Use a USB cable no longer than 3 meters.
- * Turn on the power to the RD-300SX before starting up MIDI applications on the computer. Do not turn the RD-300SX on or off while any MIDI application is running.
- * Do not connect or disconnect the USB cable while the RD-300SX's power is on.
- * If not using USB, disconnect the USB cable from the RD-300SX.
- * If, during the transmission/reception of data, the computer switches to energy-saving mode or suspended mode, or if the RD-300SX's power is switched on or off, the computer may freeze, or the RD-300SX's operation may become unstable.
- * When using your computer's sequencer software to record RD-300SX performances, we recommend setting the sequencer software's Soft Thru to "OFF."

About V-LINK

V-LINK (**V-LINK**) is a function that provides for the play of music and visual material. By using V-LINK-compatible video equipment, visual effects can be easily linked to, and made part of the expressive elements of a performance.

(Examples)

By using the RD-300SX and Edirol DV-7PR together, you can:

- Make Edirol DV-7PR playback settings remotely from the RD-300SX.
- Use the RD-300SX's keyboard to switch the Edirol DV-7PR's images (clips/palettes).

* *In order to use V-LINK with the RD-300SX and Edirol DV-7PR, you will need to make connections using an USB-MIDI Interface (sold separately).*

NOTE

Before connecting this unit to other devices, turn off the power to all units. This will help prevent malfunctions and/or damage to speakers or other devices.

How to Use the V-LINK

1. Hold down [SHIFT] and press [SOUND CONTROL].

The display changes as shown below, and the RD-300SX switches to image control mode.

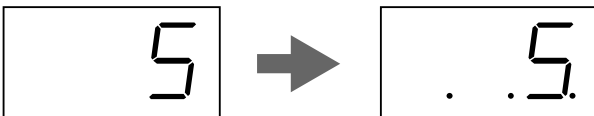

You can control images using the twelve keys at the left end of the keyboard.

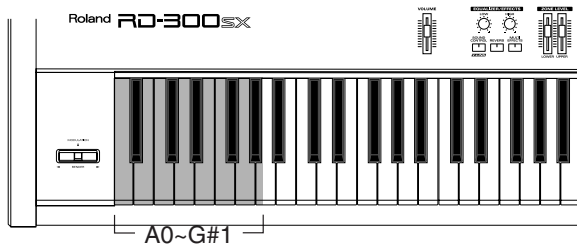

* *While V-LINK is switched on, no sound is produced when you press any of the twelve keys at the left end of the keyboard.*

2. Hold down [SHIFT] and press [SOUND CONTROL] once again to exit.

The display returns to its normal state, and the V-LINK setting is switched off.

Troubleshooting

If the RD-300SX does not function in the way you expect, first check the following points. If this does not resolve the problem, consult your dealer or a nearby Roland Service Station.

Problem	Check/Solution
Power Not Coming On	Is the power cord properly connected? (p. 11)
No Sound	Is the volume level of the RD-300SX (p. 14) or connected device turned all the way down?
	Are all connections properly made? <ul style="list-style-type: none"> When using the RD-300SX as a stand-alone instrument, be sure to connect with audio cables or use headphones (p. 12).
	Are sounds audible with headphones connected? <ul style="list-style-type: none"> If sounds are audible through headphones, it may indicate that there is a short in an audio cable or some sort of amp or mixer problem. Check the cables and equipment once again.
	Is a zone level turned off with the ZONE LEVEL sliders? (p. 24)
	Is the Part setting set to OFF (p. 43)?
	If the sound for a pressed key is not being played, is the Local Switch set to OFF? <ul style="list-style-type: none"> Set the Local Control to ON (p. 46).
	Are the effect settings correct? <ul style="list-style-type: none"> Check the ON/OFF settings for MULTI EFFECTS [ON/OFF] (p. 28), MFX Zone (p. 40) and level settings (p. 28).
	Has the volume been lowered by pedal operations or by MIDI messages (volume messages or expression messages) received from an external MIDI device?
No Sound for Specific Zone	Is the zone's volume level turned down? <ul style="list-style-type: none"> Check the ZONE LEVEL sliders (p. 24).
No Sound From the Connected MIDI Device	Is the device enabled to transmit MIDI messages? <ul style="list-style-type: none"> Set [MIDI TX] to ON (p. 47). MIDI messages cannot be transmitted if [MIDI TX] is set to OFF.

Problem	Check/Solution
No Sound From the Connected MIDI Device	Is the RD-300SX's keyboard controller section MIDI Transmit channel matched to the connected MIDI device's MIDI Receive channel? <ul style="list-style-type: none"> Make the Ch settings screen (p. 47).
No Sound (With a MIDI Device Connected)	Is the power to all devices turned on?
	Is the MIDI cable connected and plugged in correctly? <p>Does the MIDI channel match the connected instrument? (p. 47)</p>
No Sound From the Left Side	Is V-LINK switched on (p. 51)? <p>When V-LINK is switched on, the twelve keys at the left end of the keyboard are used to control images, and no sounds are played with these keys.</p>
No Sound in a Specific Range	With certain Tones, for example Rhythm Sets, bass Tones, Timpani, and other Tones will not sound if a portion of the Tone falls outside the recommended range.
Not All Sounds Are Played	The RD-300SX has a maximum polyphony of 128 voices. When playing together with a song or Rhythm along with heavy use of the damper pedal, the performance data may exceed the number of available voices, and as a result, some notes or sounds played on the keyboard may not sound.
Tones Are Altered	Did you call up a Setup? <ul style="list-style-type: none"> When a Setup is called up, the current Tone, effect, and other settings are disabled, and the selected Setup goes into effect (p. 34). Save the required settings to a Setup (p. 35).
	Did you press ONE TOUCH [PIANO]? <ul style="list-style-type: none"> When ONE TOUCH [PIANO] is pressed, the current Tone, effect, and other settings are disabled, and settings for use in piano performances go into effect (p. 18). Save the required settings to a Setup (p. 35). <p>When a mono connection is used, the tone quality of some sounds may change, depending on the type of sound and the register in which it is used. To enjoy the best quality when listening to such sounds, we recommend connecting in stereo.</p>

Problem	Check/Solution
Two Sounds are Produced When the Keyboard is Played	Is the RD-300SX in Dual Play? (p. 21)
	When the RD-300SX is connected to an external sequencer, set it to the Local OFF mode (p. 46). Alternatively, set SOFT THRU on the sequencer to "OFF."
Tone Doesn't Change	Is [MIDI TX] set to ON? <ul style="list-style-type: none"> When [MIDI TX] is set to ON, the external sound generator is controlled. To change the RD-300SX's tones, set [MIDI TX] to OFF (p. 47).
	Are the LOWER SELECT settings correct? (p. 28)
Effects Not Applied/ Effects Sound Wrong	Is [MULTI EFFECTS] set to OFF (p. 28)?
	Could the Effect Type be set to 0? (p. 29)
	Could the Effect Level be set to 0? (p. 28)
	When the zone to which the effects are applied is assigned to the Lower Tone, the effects are then not applied to the Upper Tone (p. 40).
Reverb Remains Even After Reverb is Lifted	As the RD-300SX piano sounds faithfully reproduce the depth and reverberation of actual acoustic pianos, reverberation may still be audible even after the reverb effect is removed from sounds.
Sound Suddenly Changes at Key in Upper Octaves	With the acoustic piano settings, sounds in the upper 1 1/2-octave range are extended to the end regardless of the damper pedal actions. The tone is also different in this range. Roland's pianos faithfully reproduce the sonic qualities of acoustic pianos. Furthermore, you can use the instrument's Key Transpose setting to change that range over which the damper pedal has no effect.
Sounds Come From Left or Right Each Time Key is Pressed (Panned)	In some Tones, the settings are such that sounds randomly play from the left or right side (are panned) each time the keys are pressed. These settings cannot be changed.
Sound is Distorted	Sounds can be distorted due to equalizer, multi-effect, and Part volume settings. Adjust the ZONE LEVEL sliders (p. 24).
	Is a distortion-type effect being applied to the sound (p. 28)?

Problem	Check/Solution
Pitch is Odd	Depending on the Tone selected, pitches played in certain registers will be changed and played at other pitches.
	Have you set Transpose? (p. 25, p. 55)
	Has the RD-300SX gone out of tune? <ul style="list-style-type: none"> Check the System Master Tune settings in Edit mode (p. 38).
	Has the pitch been changed by pedal operations or by Pitch Bend messages received from an external MIDI device?
Sound is Cut Off	When you try playing more than the maximum 128 voices simultaneously, sounds currently being played may be cut out.
Sound Keeps Playing When Key is Pressed	Is the hold pedal polarity reversed? <ul style="list-style-type: none"> Check the System Damper Pedal Polarity settings in Edit mode (p. 38).
Pedal Has No Effect, or Effect "Sticks"	Is the pedal connected correctly? <ul style="list-style-type: none"> Connect the pedal securely to the PEDAL jack (p. 12).
	Are you using a pedal made by another manufacturer? <ul style="list-style-type: none"> Use the pedal included with the RD-300SX or an optional DP Series or similar pedal.
	Unplugging a pedal cord from the unit while the power is on may cause the pedal's effect to be applied nonstop. Be sure to switch off the power to the unit before attempting to disconnect or connect a pedal cord (p. 12).
	When Setup Pedal Shift is set to ON and the pedal is being used as a dedicated Setup switch (p. 39), the control pedal function cannot be used (p. 40).

Troubleshooting

Problem	Check/Solution
High-Pitched Whine is Produced	<p>When listening through headphones:</p> <p>Certain piano tones that feature vibrant, sparkling sounds contain a large high-frequency component, which may make it appear that a metallic reverberation has been applied. This faithfully reproduces the characteristics of acoustic pianos, and does not indicate any malfunction. Since this reverberation becomes particularly audible when supplemented by heavy reverb, you may be able to diminish the problem by reducing the amount of reverb applied to the sound.</p> <p>When listening through speakers:</p> <p>Here, a different cause (such as resonance produced by the RD-300SX) would be suspect. Consult your Roland dealer or nearest Roland Service Center.</p>

Effects List

Indicated number	Effect name	Overview	Effect parameter name when changed by holding down [MULTI EFFECTS] and pressing [INC] or [DEC] (p. 29): An overview thereof (Value)
00	THRU		
01	EQUALIZER	Amplifies the low and high ends for a noticeably striking tone.	EQ Gain: Gain of the low and high range (0–30)
02	MID CUT	Cuts the midrange for a clean, refreshing tone.	Mid Gain: Gain of the middle range (0–30)
03	LOW CUT	Reduces the volume of the low end.	Low Gain: Gain of the low range (0–64)
04	LOW BOOST	Boosts the volume of the lower range, creating powerful lows.	Boost Gain: Amount by which the lower range will be boosted (0–12)
05	NOTCH FILTER	This filter cuts specific frequencies.	Filter Cutoff: Cutoff frequency of the filter (0–127)
06	STEP FILTER	This filter changes the cutoff frequency in a stepped fashion.	Rate: Rate of modulation (0–21)
07	ENHANCER	Controls the overtone structure of the high frequencies, adding sparkle and tightness to the sound.	Sens: Sensitivity of the enhancer (0–127)
08	AUTO WAH	Cyclically controls a filter to create cyclic change in timbre.	Manual: Adjusts the center frequency at which the effect is applied (0–127)
09	HUMANIZER	Adds a vowel character to the sound, making it similar to a human voice.	Rate: Frequency at which the two vowels switch (0–21)
10	SPEAKER SIMULATOR	Simulates the large triple stack speaker	Direct Level: Volume of the direct sound (0–127)
11	PHASER	This is a stereo phaser. A phase-shifted sound is added to the original sound and modulated.	Rate: Frequency of modulation (0–21)
12	STEP PHASER	This is a stereo phaser. The phaser effect will be varied gradually.	Step Rate: Frequency of modulation (0–21)
13	MULTI PHASER	Extremely high settings of the phase difference produce a deep phaser effect.	Rate: Frequency of modulation (0–21)
14	INFINITE PHASER	A phaser that continues raising/lowering the frequency at which the sound is modulated.	Speed: Speed at which to raise or lower the frequency at which the sounds modulated (0–200)
15	RING MODULATOR	This is an effect that applies amplitude modulation (AM) to the input signal, producing bell-like sounds.	Frequency: Adjusts the frequency at which modulation is applied (0–127)
16	STEP RING MODULATOR	A ring modulator that cyclically changes the modulated frequencies.	Rate: Rate of modulation (0–21)
17	TREMOLO	Cyclically modulates the volume to add tremolo effect to the sound.	Rate: Frequency of the change (0–21)
18	AUTO PAN	Cyclically modulates the stereo location of the sound.	Rate: Frequency of the change (0–21)
19	STEP PAN	Cyclically modulates the stereo location of the sound.	Rate: Frequency of the change (0–21)
20	SLICER	By applying successive cuts to the sound, this effect turns a conventional sound into a sound that appears to be played as a backing phrase. This is especially effective when applied to sustain-type sounds.	Rate: Frequency of the change (0–21)
21	ROTARY	The Rotary effect simulates the sound of the rotary speakers often used with the electric organs of the past.	Speed: Rotational speed of the rotating speaker (0–1)
22	VK ROTARY	This type provides modified response for the rotary speaker, with the low end boosted further.	Speed: Rotational speed of the rotating speaker (0–1)
23	CHORUS	This is a stereo chorus.	Depth: Depth of modulation (0–127)
24	FLANGER	This is a stereo flanger. It produces a metallic resonance that rises and falls like a jet airplane taking off or landing.	Depth: Depth of modulation (0–127)

Effects List

Indicated number	Effect name	Overview	Effect parameter name when changed by holding down [MULTI EFFECTS] and pressing [INC] or [DEC] (p. 29): An overview thereof (Value)
25	STEP FLANGER	This is a flanger in which the flanger pitch changes in steps.	Step Rate: Rate of pitch change (0–21)
26	HEXA-CHORUS	Uses a six-phase chorus to give richness and spatial spread to the sound.	Balance: Volume balance between the direct sound and the chorus sound (0–100)
27	TREMOLO CHORUS	This is a chorus effect with added Tremolo (cyclic modulation of volume).	Balance: Volume balance between the direct sound and the tremolo chorus sound (0–100)
28	SPACE-D	This is a multiple chorus that applies two-phase modulation in stereo. It gives no impression of modulation, but produces a transparent chorus effect.	Balance: Volume balance between the direct sound and the chorus sound (0–100)
29	3D CHORUS	This applies a 3D effect to the chorus sound. The chorus sound will be positioned 90 degrees left and 90 degrees right.	Balance: Volume balance between the direct sound and the chorus sound (0–100)
30	3D FLANGER	This applies a 3D effect to the flanger sound. The flanger sound will be positioned 90 degrees left and 90 degrees right.	Balance: Volume balance between the direct sound and the flanger sound (0–100)
31	3D STEP FLANGER	This applies a 3D effect to the step flanger sound. The flanger sound will be positioned 90 degrees left and 90 degrees right.	Step Rate: Rate of pitch change (0–21)
32	2BAND CHORUS	A chorus effect that lets you apply an effect independently to the low-frequency and high-frequency ranges.	Balance: Volume balance of the original sound and chorus sound (0–100)
33	2BAND FLANGER	A flanger that lets you apply an effect independently to the low-frequency and high-frequency ranges.	Balance: Volume balance of the original sound and flanger sound (0–100)
34	2BAND STEP FLANGER	A step flanger that lets you apply an effect independently to the low-frequency and high-frequency ranges.	Balance: Volume balance of the original sound and flanger sound (0–100)
35	OVERDRIVE	Creates a soft distortion similar to that produced by vacuum tube amplifiers.	Level: Output Level (0–127)
36	DISTORTION	Produces a more intense distortion than Overdrive.	Level: Output Level (0–127)
37	VS OVERDRIVE	This is an overdrive that provides heavy distortion.	Level: Output Level (0–127)
38	VS DISTORTION	This is a distortion effect that provides heavy distortion.	Level: Output Level (0–127)
39	GUITAR AMP SIMULATOR	This is an effect that simulates the sound of a guitar amplifier.	Pre Amp Master: Volume of the entire pre-amp (0–127)
40	COMPRESSOR	Flattens out high levels and boosts low levels, smoothing out fluctuations in volume.	Threshold: Adjusts the volume at which compression begins (0–127)
41	LIMITER	Compresses signals that exceed a specified volume level, preventing distortion from occurring.	Threshold: Adjusts the volume at which compression begins (0–127)
42	GATE	Cuts the reverb's delay according to the volume of the sound sent into the effect. Use this when you want to create an artificial-sounding decrease in the reverb's decay.	Threshold: Volume level at which the gate begins to close (0–127)
43	DELAY	This is a stereo delay.	Balance: Volume balance between the direct sound and the delay sound (0–100)
44	LONG DELAY	A delay that provides a long delay time.	Balance: Volume balance between the direct sound and the delay sound (0–100)
45	SERIAL DELAY	This delay connects two delay units in series.	Balance: Volume balance between the direct sound and the delay sound (0–100)
46	MODULATION DELAY	Adds modulation to the delayed sound.	Balance: Volume balance between the direct sound and the delay sound (0–100)

Indicated number	Effect name	Overview	Effect parameter name when changed by holding down [MULTI EFFECTS] and pressing [INC] or [DEC] (p. 29): An overview thereof (Value)
47	3TAP PAN DELAY	Produces three delay sounds; center, left and right.	Balance: Volume balance between the direct sound and the delay sound (0–100)
48	4TAP PAN DELAY	This effect has four delays.	Balance: Volume balance between the direct sound and the delay sound (0–100)
49	MULTI TAP DELAY	This effect provides four delays with feedback.	Balance: Volume balance between the direct sound and the delay sound (0–100)
50	REVERSE DELAY	This is a reverse delay that adds a reversed and delayed sound to the input sound.	Balance: Volume balance between the direct sound and the delay sound (0–100)
51	SHUFFLE DELAY	Adds a shuffle to the delay sound, giving the sound a bouncy delay effect with a swing feel.	Balance: Volume balance between the direct sound and the delay sound (0–100)
52	3D DELAY	This applies a 3D effect to the delay sound. The delay sound will be positioned 90 degrees left and 90 degrees right.	Balance: Volume balance between the direct sound and the delay sound (0–100)
53	TIME CONTROL DELAY	A stereo delay in which the delay time can be varied smoothly.	Balance: Volume balance between the direct sound and the delay sound (0–100)
54	LONG TIME CONTROL DELAY	A delay in which the delay time can be varied smoothly, and allowing an extended delay to be produced.	Balance: Volume balance between the direct sound and the delay sound (0–100)
55	TAPE ECHO	A virtual tape echo that produces a realistic tape delay sound.	Echo Level: Volume of the echo sound (0–127)
56	LOFI NOISE	In addition to a Lo-Fi effect, this adds various types of noise such as white noise and disc noise.	Balance: Volume balance between the direct sound and the effect sound (0–100)
57	LOFI COMPRESSOR	This is an effect that intentionally degrades the sound quality for creative purposes.	Balance: Volume balance between the direct sound and the effect sound (0–100)
58	LOFI RADIO	In addition to a Lo-Fi effect, this effect also generates radio noise.	Balance: Volume balance between the direct sound and the effect sound (0–100)
59	TELEPHONE	This applies a telephone sound.	Balance: Volume balance between the direct sound and the effect sound (0–100)
60	PHONOGRAPH	Simulates a sound recorded on an analog record and played back on a record player.	Balance: Volume balance between the direct sound and the effect sound (0–100)
61	PITCH SHIFTER	A stereo pitch shifter.	Fine: Adjusts the pitch of the pitch shifted sound (0–100)
62	2VOICE PITCH SHIFTER	Shifts the pitch of the original sound. This 2-voice pitch shifter has two pitch shifters, and can add two pitch shifted sounds to the original sound.	Balance: Volume balance between the Pitch Shift 1 and Pitch Shift 2 sounds (0–100)
63	STEP PITCH SHIFTER	This pitch shifter changes the shift volume of the pitch shift sound in a stepped fashion.	Rate: Rate of modulation (0–21)
64	REVERB	Adds reverberation to the sound, simulating an acoustic space.	Time: Time length of reverberation (0–127)
65	GATED REVERB	This is a special type of reverb in which the reverberant sound is cut off before its natural length.	Balance: Volume balance between the direct sound and the reverb sound (0–100)
66	OVERDRIVE →CHORUS	This effect connects an overdrive and a chorus in series.	Chorus Balance: Adjusts the volume balance between the sound that is sent through the chorus and the sound that is not sent through the chorus (0–100)
67	OVERDRIVE →FLANGER	This effect connects an overdrive and a flanger in series.	Flanger Balance: Adjusts the volume balance between the sound that is sent through the flanger and the sound that is not sent through the flanger (0–100)

Effects List

Indicated number	Effect name	Overview	Effect parameter name when changed by holding down [MULTI EFFECTS] and pressing [INC] or [DEC] (p. 29): An overview thereof (Value)
68	OVERDRIVE →DELAY	This effect connects an overdrive and a delay in series.	Delay Balance: Adjusts the volume balance between the sound that is sent through the delay and the sound that is not sent through the delay (0–100)
69	DISTORTION →CHORUS	This effect connects a distortion and a chorus in series.	Chorus Balance: Adjusts the volume balance between the sound that is sent through the chorus and the sound that is not sent through the chorus (0–100)
70	DISTORTION →FLANGER	This effect connects a distortion and a flanger in series.	Flanger Balance: Adjusts the volume balance between the sound that is sent through the flanger and the sound that is not sent through the flanger (0–100)
71	DISTORTION →DELAY	This effect connects a distortion and a delay in series.	Delay Balance: Adjusts the volume balance between the sound that is sent through the delay and the sound that is not sent through the delay (0–100)
72	ENHANCER →CHORUS	This effect connects an enhancer and a chorus in series.	Chorus Balance: Adjusts the volume balance between the sound that is sent through the chorus and the sound that is not sent through the chorus (0–100)
73	ENHANCER →FLANGER	This effect connects an enhancer and a flanger in series.	Flanger Balance: Adjusts the volume balance between the sound that is sent through the flanger and the sound that is not sent through the flanger (0–100)
74	ENHANCER →DELAY	This effect connects an enhancer and a delay in series.	Delay Balance: Adjusts the volume balance between the sound that is sent through the delay and the sound that is not sent through the delay (0–100)
75	CHORUS →DELAY	This effect connects a chorus and a delay in series.	Delay Balance: Adjusts the volume balance between the sound that is sent through the delay and the sound that is not sent through the delay (0–100)
76	FLANGER →DELAY	This effect connects a flanger and a delay in series.	Delay Balance: Adjusts the volume balance between the sound that is sent through the delay and the sound that is not sent through the delay (0–100)
77	CHORUS →FLANGER	This effect connects a chorus and a flanger in series.	Flanger Balance: Adjusts the volume balance between the sound that is sent through the flanger and the sound that is not sent through the flanger (0–100)
78	SYMPATHETIC RESONANCE	On an acoustic piano, holding down the damper pedal allows other strings to resonate in sympathy with the notes you play, creating rich and spacious resonances. This effect simulates these sympathetic resonances.	Depth: Depth of the effect (0–10)

Error Messages

Display	Meaning
E.40	Too much MIDI data was sent from the external MIDI instrument at one time, and the unit could not process the data. Reduce the amount of MIDI data being sent to the RD-300SX.
E.41	A problem such as a loose MIDI cable or computer cable occurred. Make sure the MIDI cables and computer cables are correctly hooked up.
E.51	A system error has occurred. Try performing the procedure over again. Should this message continue to appear even after repeated attempts, please consult the nearest Roland Service Center.

Tone List

MSB: Bank Select MSB (Control Number: 0)

LSB: Bank Select LSB (Control Number: 32)

PC: Program Change

[PIANO]

No.	Tone Name	MSB	LSB	PC
001	X-Ultimate	087	064	001
002	Grand RD	087	064	002
003	X-Pure Grand	087	064	003
004	Mellow Piano	087	064	004
005	X-PureMellow	087	064	005
006	Piano+Strings	087	064	006
007	Rock Piano	087	064	007
008	Honky-tonk	087	064	008
009	X-Pure Mono	087	064	009
010	GrandRD Mono	087	064	010

[E.PIANO]

No.	Tone Name	MSB	LSB	PC
001	Vintage EP 1	087	065	001
002	Vintage EP 2	087	065	002
003	70's E.Piano	087	065	003
004	60's E.Piano	087	065	004
005	FM E.Piano	087	065	005
006	Clav	087	065	006
007	Natural Hps.	087	065	007
008	Vibraphone	087	065	008
009	Marimba	087	065	009
010	Morning Lite	087	065	010

[ORGAN]

No.	Tone Name	MSB	LSB	PC
001	Zepix Organ	087	066	001
002	FullDraw Org	087	066	002
003	X Perc Organ	087	066	003
004	Gospel Spin	087	066	004
005	Mellow Bars	087	066	005
006	Rock Organ	087	066	006
007	Massive Pipe	087	066	007

[STRINGS/PAD]

No.	Tone Name	MSB	LSB	PC
001	SX Strings	087	067	001
002	Studio Sect.	087	067	002
003	OrchestraPad	087	067	003
004	ChmbrStrings	087	067	004
005	Pizzicato	087	067	005
006	JP Strings	087	067	006
007	Soft Pad	087	067	007
008	Silky Way	087	067	008
009	Nu Epic Pad	087	067	009
010	Strings Pad	087	067	010
011	Flange Dream	087	067	011
012	InfinitePhsr	087	067	012

[GUITAR/BASS]

No.	Tone Name	MSB	LSB	PC
001	Dyna Nylon	087	068	001
002	Steel Gtr	087	068	002
003	Jz Gtr Hall	087	068	003
004	Blusey OD	087	068	004
005	Punker	087	068	005
006	SX Ac.Bass	087	068	006
007	FingerMaster	087	068	007
008	SX Fretnot	087	068	008
009	Slap Bass	087	068	009
010	Bass+RideCym	087	068	010
011	Punch MG	087	068	011
012	101 Bass	087	068	012
013	Synth Bass	087	068	013

[BRASS/WINDS]

No.	Tone Name	MSB	LSB	PC
001	StackTp Sect	087	069	001
002	VoyagerBrass	087	069	002
003	Wood Symphny	087	069	003
004	Bigband Sax	087	069	004
005	Soprano Sax	087	069	005
006	Tenor Sax	087	069	006
007	Flute	087	069	007
008	Bend SynBrS	087	069	008
009	Jump For KY	087	069	009
010	Afro Horns	087	069	010

[VOICE/SYNTH]

No.	Tone Name	MSB	LSB	PC
001	Jazz Scat	087	070	001
002	Morning Star	087	070	002
003	Choir Aahs	087	070	003
004	Female Aahs	087	070	004
005	Galactic SX	087	070	005
006	Saw Lead	087	070	006
007	Square Lead	087	070	007
008	SuperSawSlow	087	070	008

[RHYTHM/GM2]

No.	Tone Name	MSB	LSB	PC
001	SX Pop Kit	086	064	001
002	SX Rock Kit	086	064	002
003	SX Jazz Kit	086	064	003
004	SX R&B Kit	086	064	004
005	SX House Kit	086	064	005

<GM2 Rhythm Sets>

No.	Tone Name	MSB	LSB	PC
006	GM2 STANDARD	120	000	001
007	GM2 ROOM	120	000	009
008	GM2 POWER	120	000	017
009	GM2 ELECTRIC	120	000	025
010	GM2 ANALOG	120	000	026
011	GM2 JAZZ	120	000	033
012	GM2 BRUSH	120	000	041
013	GM2 ORCHESTRA	120	000	049
014	GM2 SFX	120	000	057

<GM2 Tones>

No.	Tone Name	MSB	LSB	PC
015	Piano 1	121	000	001
016	Piano 1w	121	001	001
017	European Pf	121	002	001
018	Piano 2	121	000	002
019	Piano 2w	121	001	002
020	Piano 3	121	000	003
021	Piano 3w	121	001	003
022	Honky-tonk	121	000	004
023	Honky-tonk 2	121	001	004
024	E.Piano 1	121	000	005
025	St.Soft EP	121	001	005
026	FM+SA EP	121	002	005
027	60's E.Piano	121	003	005
028	E.Piano 2	121	000	006
029	Detuned EP 2	121	001	006
030	St.FM EP	121	002	006
031	EP Legend	121	003	006
032	EP Phase	121	004	006
033	Harpsichord	121	000	007
034	Coupled Hps.	121	001	007
035	Harpsi.w	121	002	007
036	Harpsi.o	121	003	007
037	Clav.	121	000	008
038	Pulse Clav	121	001	008
039	Celesta	121	000	009
040	Glockenspiel	121	000	010
041	Music Box	121	000	011
042	Vibraphone	121	000	012
043	Vibraphone w	121	001	012
044	Marimba	121	000	013
045	Marimba w	121	001	013
046	Xylophone	121	000	014
047	Tubular-bell	121	000	015
048	Church Bell	121	001	015
049	Carillon	121	002	015
050	Santur	121	000	016
051	Organ 1	121	000	017
052	Trem. Organ	121	001	017
053	60's Organ 1	121	002	017
054	70's E.Organ	121	003	017
055	Organ 2	121	000	018
056	Chorus Or.2	121	001	018
057	Perc. Organ	121	002	018
058	Organ 3	121	000	019
059	Church Org.1	121	000	020
060	Church Org.2	121	001	020
061	Church Org.3	121	002	020
062	Reed Organ	121	000	021
063	Puff Organ	121	001	021
064	Accordion Fr	121	000	022
065	Accordion It	121	001	022
066	Harmonica	121	000	023
067	Bandoneon	121	000	024
068	Nylon-str.Gt	121	000	025
069	Ukulele	121	001	025
070	Nylon Gt.o	121	002	025
071	Nylon Gt.2	121	003	025
072	Steel-str.Gt	121	000	026
073	12-str.Gt	121	001	026
074	Mandolin	121	002	026
075	Steel + Body	121	003	026

Tone List

076	Jazz Gt.	121	000	027	146	Brass 2	121	001	062	216	Shanai	121	000	112
077	Pedal Steel	121	001	027	147	Synth Brass1	121	000	063	217	Tinkle Bell	121	000	113
078	Clean Gt.	121	000	028	148	Pro Brass	121	001	063	218	Agogo	121	000	114
079	Chorus Gt.	121	001	028	149	Oct SynBrass	121	002	063	219	Steel Drums	121	000	115
080	Mid Tone GTR	121	002	028	150	Jump Brass	121	003	063	220	Woodblock	121	000	116
081	Muted Gt.	121	000	029	151	Synth Brass2	121	000	064	221	Castanets	121	001	116
082	Funk Pop	121	001	029	152	SynBrass sfz	121	001	064	222	Taiko	121	000	117
083	Funk Gt.2	121	002	029	153	Velo Brass 1	121	002	064	223	Concert BD	121	001	117
084	Jazz Man	121	003	029	154	Soprano Sax	121	000	065	224	Melo. Tom 1	121	000	118
085	Overdrive Gt	121	000	030	155	Alto Sax	121	000	066	225	Melo. Tom 2	121	001	118
086	Guitar Pinch	121	001	030	156	Tenor Sax	121	000	067	226	Synth Drum	121	000	119
087	DistortionGt	121	000	031	157	Baritone Sax	121	000	068	227	808 Tom	121	001	119
088	Feedback Gt.	121	001	031	158	Oboe	121	000	069	228	Elec Perc	121	002	119
089	Dist Rtm GTR	121	002	031	159	English Horn	121	000	070	229	Reverse Cym.	121	000	120
090	Gt.Harmonics	121	000	032	160	Bassoon	121	000	071	230	Gt.FretNoise	121	000	121
091	Gt. Feedback	121	001	032	161	Clarinet	121	000	072	231	Gt.Cut Noise	121	001	121
092	Acoustic Bs.	121	000	033	162	Piccolo	121	000	073	232	String Slap	121	002	121
093	Fingered Bs.	121	000	034	163	Flute	121	000	074	233	Breath Noise	121	000	122
094	Finger Slap	121	001	034	164	Recorder	121	000	075	234	Fl.Key Click	121	001	122
095	Picked Bass	121	000	035	165	Pan Flute	121	000	076	235	Seashore	121	000	123
096	Fretless Bs.	121	000	036	166	Bottle Blow	121	000	077	236	Rain	121	001	123
097	Slap Bass 1	121	000	037	167	Shakuhachi	121	000	078	237	Thunder	121	002	123
098	Slap Bass 2	121	000	038	168	Whistle	121	000	079	238	Wind	121	003	123
099	Synth Bass 1	121	000	039	169	Ocarina	121	000	080	239	Stream	121	004	123
100	SynthBass101	121	001	039	170	Square Wave	121	000	081	240	Bubble	121	005	123
101	Acid Bass	121	002	039	171	MG Square	121	001	081	241	Bird	121	000	124
102	Clavi Bass	121	003	039	172	2600 Sine	121	002	081	242	Dog	121	001	124
103	Hammer	121	004	039	173	Saw Wave	121	000	082	243	Horse-Gallop	121	002	124
104	Synth Bass 2	121	000	040	174	OB2 Saw	121	001	082	244	Bird 2	121	003	124
105	Beef FM Bass	121	001	040	175	Doctor Solo	121	002	082	245	Telephone 1	121	000	125
106	RubberBass 2	121	002	040	176	Natural Lead	121	003	082	246	Telephone 2	121	001	125
107	Attack Pulse	121	003	040	177	SequencedSaw	121	004	082	247	DoorCreaking	121	002	125
108	Violin	121	000	041	178	Syn.Calliope	121	000	083	248	Door	121	003	125
109	Slow Violin	121	001	041	179	Chiffer Lead	121	000	084	249	Scratch	121	004	125
110	Viola	121	000	042	180	Charang	121	000	085	250	Wind Chimes	121	005	125
111	Cello	121	000	043	181	Wire Lead	121	001	085	251	Helicopter	121	000	126
112	Contrabass	121	000	044	182	Solo Vox	121	000	086	252	Car-Engine	121	001	126
113	Tremolo Str	121	000	045	183	5th Saw Wave	121	000	087	253	Car-Stop	121	002	126
114	PizzicatoStr	121	000	046	184	Bass & Lead	121	000	088	254	Car-Pass	121	003	126
115	Harp	121	000	047	185	Delayed Lead	121	001	088	255	Car-Crash	121	004	126
116	Yang Qin	121	001	047	186	Fantasia	121	000	089	256	Siren	121	005	126
117	Timpani	121	000	048	187	Warm Pad	121	000	090	257	Train	121	006	126
118	Orche str	121	000	049	188	Sine Pad	121	001	090	258	Jetplane	121	007	126
119	Orchestra	121	001	049	189	Polysynth	121	000	091	259	Starship	121	008	126
120	60s Strings	121	002	049	190	Space Voice	121	000	092	260	Burst Noise	121	009	126
121	Slow Strings	121	000	050	191	Itopia	121	001	092	261	Applause	121	000	127
122	Syn.Strings1	121	000	051	192	Bowed Glass	121	000	093	262	Laughing	121	001	127
123	Syn.Strings3	121	001	051	193	Metal Pad	121	000	094	263	Screaming	121	002	127
124	Syn.Strings2	121	000	052	194	Halo Pad	121	000	095	264	Punch	121	003	127
125	Choir Aahs	121	000	053	195	Sweep Pad	121	000	096	265	Heart Beat	121	004	127
126	Chorus Aahs	121	001	053	196	Ice Rain	121	000	097	266	Footsteps	121	005	127
127	Voice Oohs	121	000	054	197	Soundtrack	121	000	098	267	Gun Shot	121	000	128
128	Humming	121	001	054	198	Crystal	121	000	099	268	Machine Gun	121	001	128
129	SynVox	121	000	055	199	Syn Mallet	121	001	099	269	Lasergun	121	002	128
130	Analog Voice	121	001	055	200	Atmosphere	121	000	100	270	Explosion	121	003	128
131	OrchestraHit	121	000	056	201	Brightness	121	000	101					
132	Bass Hit	121	001	056	202	Goblin	121	000	102					
133	6th Hit	121	002	056	203	Echo Drops	121	000	103					
134	Euro Hit	121	003	056	204	Echo Bell	121	001	103					
135	Trumpet	121	000	057	205	Echo Pan	121	002	103					
136	Dark Trumpet	121	001	057	206	Star Theme	121	000	104					
137	Trombone	121	000	058	207	Sitar	121	000	105					
138	Trombone 2	121	001	058	208	Sitar 2	121	001	105					
139	Bright Tb	121	002	058	209	Banjo	121	000	106					
140	Tuba	121	000	059	210	Shamisen	121	000	107					
141	MutedTrumpet	121	000	060	211	Koto	121	000	108					
142	MuteTrumpet2	121	001	060	212	Taisho Koto	121	001	108					
143	French Horns	121	000	061	213	Kalimba	121	000	109					
144	Fr.Horn 2	121	001	061	214	Bagpipe	121	000	110					
145	Brass 1	121	000	062	215	Fiddle	121	000	111					

* Some tones sound for only one pressed key (mono tones).

Rhythm Set List

* [EXC]: will not sound simultaneously with other percussion instruments of the same number.

	SX Pop Kit	SX Rock Kit	SX Jazz Kit	SX R&B Kit	SX House Kit
21	Rock Kick	Old Kick	Old Kick	Analog Kick 2	Dance Kick
22	Pop Kick	Pop Kick	Pop Kick	TR909 Kick 1	Lo-Bit CHH [EXC1]
23	Analog Kick 1	Analog Kick 1	Analog Kick 1	TR909 Kick 2	Techno Kick 2
24	Hush Kick	Rock Kick	Jazz Swish	R&B CHH 2 [EXC1]	Concert Snare
25	Pop CHH 1 [EXC1]	Rock CHH1 [EXC1]	Jazz Tap 1	R&B CHH 3 [EXC1]	Snare Roll
26	Reg. Snare 1	Rock Snare 1	Jazz Tap 2	R&B CHH 4 [EXC1]	Finger Snap
27	Finger Snap	Finger Snap	Finger Snap	Finger Snap	High-Q
28	707 Claps	707 Claps	707 Claps	707 Claps	Slap
29	Hand Clap 1	Hand Clap 1	Hand Clap 1	Hand Clap 1	Scratch Push
30	Hand Clap 2	Hand Clap 2	Hand Clap 2	Gospel Hand Clap 2	Scratch Pull
31	Hand Clap 3	Hand Clap 3	Hand Clap 3	Hand Clap 2	Sticks
32	Pop PHH [EXC1]	Pop PHH [EXC1]	Pop PHH [EXC1]	R&B CHH 5 [EXC1]	Square Click
33	Hand Clap 4	Hand Clap 4	Pop Hand Clap	Gospel Hand Clap	Metro Click
34	Snare Roll	Snare Roll	Snare Roll	Lo-Bit CHH [EXC1]	Metro Bell
35	Old Kick	Old Kick	Pop Kick	Analog Kick 1	House Kick 1
C2 36	Hush Kick	Rock Kick	Jazz Kick 2	R&B Kick	House Kick 2
37	Reg. Stick	Rock Side Stick	Jazz Snare Swing	R&B Side Stick 1	R&B Side Stick 1
38	Reg. Snare	Rock Snare 1	Jazz Snare 1	R&B Snare 1	House Snare 1
39	Reg. Snare Ghost	Snare Ghost	Pop Snare Swing	R&B Snare 2	House Snare 2
40	Titan Snare	Rock Snare 2	Jazz Snare 2	R&B Snare 3	House Snare 3
41	Reg. Low Tom Flm	Rock Low Tom Flm	Jazz Low Tom Flm	Sharp Low Tom 6	House Low Tom 1
42	Pop CHH 1 [EXC1]	Rock CHH 1 [EXC1]	Pop CHH 1 [EXC1]	R&B CHH 1 [EXC1]	House CHH [EXC1]
43	Reg. Low Tom	Rock Low Tom	Jazz Low Tom	Sharp Low Tom 5	House Low Tom 2
44	Pop CHH 2 [EXC1]	Rock CHH 2 [EXC1]	Pop CHH 2 [EXC1]	R&B CHH 1 [EXC1]	House PHH [EXC1]
45	Reg. Mid Tom Flm	Rock Mid Tom Flm	Jazz Mid Tom Flm	Sharp Low Tom 4	House Mid Tom 1
46	Pop OHH [EXC1]	Rock OHH [EXC1]	Pop OHH [EXC1]	R&B OHH [EXC1]	House OHH [EXC1]
47	Reg. Mid Tom	Rock Mid Tom	Jazz Mid Tom	Sharp High Tom 3	House Mid Tom 2
C3 48	Reg. High Tom Flm	Rock High Tom Flm	Jazz High Tom Flm	Sharp High Tom 2	House High Tom 1
49	Pop Crash Cymbal 1	Rock Crash Cymbal	Jazz Crash Cymbal	R&B Crash Cymbal	House Crash Cymbal
50	Reg. High Tom	Rock High Tom	Jazz High Tom	Sharp High Tom 1	House High Tom 2
51	Pop Ride Cymbal 1	Rock Ride Cymbal 2	Jazz Ride Cymbal 1	Pop Ride Cymbal 1	House Ride Cymbal
52	Pop Chinese Cymbal	Rock Chinese Cymbal	Jazz Chinese Cymbal	R&B Chinese Cym	Reverse Cymbal
53	Pop Ride Bell	Rock Ride Bell	Jazz Ride Cymbal 2	R&B Ride Bell	House Ride Bell
54	Tambourine	Tambourine	Tambourine	Tambourine	Shake Tambourine
55	Pop Splash Cymbal	Rock Splish Cymbal	Pop Splish Cymbal	TR909 Ride	House Splash Cymbal
56	Cha Cha Cowbell	Cha Cha Cowbell	Cha Cha Cowbell	Cha Cha Cowbell	House Cowbell
57	Pop Crash Cymbal 2	Rock Chinese Cymbal 2	Jazz Crash Cymbal 2	House Crash Cymbal	House Crash Cymbal
58	Vibraslap	Vibraslap	Vibraslap	Vibraslap	Vibraslap
59	Pop Ride Cymbal 2	Pop Ride Cymbal 1	Pop Ride Cymbal 1	Pop Ride Cymbal 2	Pop Ride Cymbal 2
C4 60	Bongo Hi	Bongo Hi	Bongo Hi	House Bongo Hi	House Bongo Hi
61	Bongo Lo	Bongo Lo	Bongo Lo	House Bongo Lo	House Bongo Lo
62	Conga Mute	Conga Mute	Conga Mute	House Conga Hi	House Conga Hi
63	Conga Hi	Conga Hi	Conga Hi	House Conga Mt	House Conga Mt
64	Conga Lo	Conga Lo	Conga Lo	House Conga Lo	House Conga Lo
65	Timbale Hi	Timbale Hi	Timbale Hi	Timbale Hi	Timbale Hi
66	Timbale Lo	Timbale Lo	Timbale Lo	Timbale Lo	Timbale Lo
67	Agogo Bell Hi	Agogo Bell Hi	Agogo Bell Hi	Agogo Bell Hi	Agogo Bell Hi
68	Agogo Bell Lo	Agogo Bell Lo	Agogo Bell Lo	Agogo Bell Lo	Agogo Bell Lo
69	Shaker 2	Shaker 2	Shaker 2	Cabasa	Cabasa
70	Shaker 3	Shaker 3	Shaker 3	House Maracas	House Maracas
71	Whistle Short [EXC2]	Whistle Short [EXC2]	Whistle Short [EXC2]	Whistle Short [EXC2]	Whistle Short [EXC2]
C5 72	Whistle Long [EXC2]	Whistle Long [EXC2]	Whistle Long [EXC2]	Whistle Long [EXC2]	Whistle Long [EXC2]
73	Guiro Short [EXC3]	Guiro Short [EXC3]	Guiro Short [EXC3]	Guiro Short [EXC3]	Guiro Short [EXC3]
74	Guiro Long [EXC3]	Guiro Long [EXC3]	Guiro Long [EXC3]	Guiro Long [EXC3]	Guiro Long [EXC3]
75	Claves	Claves	Claves	House Claves	House Claves
76	Wood Block Hi	Wood Block Hi	Wood Block Hi	Wood Block Hi	Wood Block Hi
77	Wood Block Lo	Wood Block Lo	Wood Block Lo	Wood Block Lo	Wood Block Lo
78	Cuica Mute [EXC4]	Cuica Mute [EXC4]	Cuica Mute [EXC4]	Hoo Hi [EXC4]	Hoo Hi [EXC4]
79	Cuica Open [EXC4]	Cuica Open [EXC4]	Cuica Open [EXC4]	Hoo Lo [EXC4]	Hoo Lo [EXC4]
80	Triangle Mt [EXC5]	Triangle Mt [EXC5]	Triangle Mt [EXC5]	Triangle Mt [EXC5]	Electric Triangle Mt [EXC5]
81	Triangle Op [EXC5]	Triangle Op [EXC5]	Triangle Op [EXC5]	Triangle Op [EXC5]	Electric Triangle Op [EXC5]
82	Cabasa	Cabasa	Cabasa	Shaker	Shaker
83	Jingle Bell	Jingle Bell	Jingle Bell	Jingle Bell	Jingle Bell
C6 84	Wind Chime	Wind Chime	Wind Chime	Wind Chime	Wind Chime
85	Castanets	Castanets	Castanets	Castanets	Castanets
86	Surdo Mute [EXC6]	Surdo Mute [EXC6]	Surdo Mute [EXC6]	Surdo Mute [EXC6]	Surdo Mute [EXC6]
87	Surdo Open [EXC6]	Surdo Open [EXC6]	Surdo Open [EXC6]	Surdo Open [EXC6]	Surdo Open [EXC6]
88	Cana	Cana	Cana	Tambourine	Cana
89	Flamenco Timbale Hi	Flamenco Timbale Hi	Flamenco Timbale Hi	Tambourine	Flamenco Timbale Hi
90	Flamenco Timbale Lo	Flamenco Timbale Lo	Flamenco Timbale Lo	Cabasa Up	Flamenco Timbale Lo
91	Flamenco Timbale Flam	Flamenco Timbale Flam	Flamenco Timbale Flam	Cabasa Down	Flamenco Timbale Flam
92	Shaker 1	Shaker 1	Shaker 1	Shaker 1	Shaker 1
93	Shaker 2	Shaker 2	Shaker 2	Shaker 2	Shaker 2
94	Bongo Lo Mt	Bongo Lo Mt	Bongo Lo Mt	Bongo Lo Mt	Bongo Lo Mt
95	Grit Snare	LoFi Snare	Jazz Snare 1	Grit Snare	LoFi Snare
C7 96	Jungle Snare 1	Jungle Snare 1	Jazz Snare 2	Jungle Snare 1	Jungle Snare 1
97	Reg. Stick	Rock Side Stick	Jazz Snare Swing	R&B Side Stick 2	R&B Side Stick 2
98	Titan Snare	Rock Snare 2	Jazz Swish	Analog Snare	Analog Snare
99	Old Kick	Old Kick	Old Kick	HipHop Kick	TR808 Kick 1
100	Pop Kick	Pop Kick	Pop Kick	TR808 Kick 1	TR808 Kick 2
101	Rock Kick	Rock Kick	Jazz Kick 1	TR808 Kick 2	Jungle Kick
102	Analog Kick 1	Analog Kick 1	Jazz Kick 2	TR808 Kick 2	Techno Kick
103	Rock Snare Dry	Rock Snare Dry	Analog Kick 1	Techno Kick	Rock Snare Dry
104	Electric Snare	Electric Snare	Jazz Tap 1	Rock Snare Dry	Rock Snare Dry
105	Reg. Snare Ghost	Rock Snare Ghost	Jazz Tap 2	Electric Snare	Electric Snare
106	Slappy	Slappy	Pop Snare Swing	Jungle Snare 2	Jungle Snare 2
107	Wah Gtr Noise 1	Wah Gtr Noise 1	Slappy	Vinyl Noise	Slappy
108	Wah Gtr Noise 2	Wah Gtr Noise 2	Wah Gtr Noise 1	Wah Gtr Noise 1	Wah Gtr Noise 1
C8	Wah Gtr Noise 2	Wah Gtr Noise 2	Wah Gtr Noise 2	Wah Gtr Noise 2	Wah Gtr Noise 2

Rhythm Set List

* ----: No sound.

* [EXC]: will not sound simultaneously with other percussion instruments of the same number.

	GM2 STANDARD	GM2 ROOM	GM2 POWER	GM2 ELECTRIC
21	----	----	----	----
22	----	----	----	----
23	----	----	----	----
24	----	----	----	----
25	----	----	----	----
26	----	----	----	----
27	High-Q	High-Q	High-Q	High-Q
28	Slap	Slap	Slap	Slap
29	ScratchPush [EXC7]	ScratchPush [EXC7]	ScratchPush [EXC7]	ScratchPush [EXC7]
30	ScratchPull [EXC7]	ScratchPull [EXC7]	ScratchPull [EXC7]	ScratchPull [EXC7]
31	Sticks	Sticks	Sticks	Sticks
32	SquareClick	SquareClick	SquareClick	SquareClick
33	Mtrnm.Click	Mtrnm.Click	Mtrnm.Click	Mtrnm.Click
34	Mtrnm. Bell	Mtrnm. Bell	Mtrnm. Bell	Mtrnm. Bell
35	Jazz Kick 1	Mix Kick	Standard KK1	Power Kick1
C2 36	Mix Kick	Standard KK1	Power Kick1	Elec Kick 1
37	Side Stick	Side Stick	Side Stick	Side Stick
38	Standard SN1	Standard SN2	Dance Snare1	Elec. Snare
39	909 HandClap	909 HandClap	909 HandClap	909 HandClap
40	Elec Snare 3	Elec Snare 7	Elec Snare 4	Elec Snare 2
41	Real Tom 6	Room Tom 5	Room Tom 5	Synth Drum 2
42	Close HiHat2 [EXC1]	Close HiHat2 [EXC1]	Close HiHat2 [EXC1]	Close HiHat2 [EXC1]
43	Real Tom 6	Room Tom 6	Room Tom 6	Synth Drum 2
44	Pedal HiHat2 [EXC1]	Pedal HiHat2 [EXC1]	Pedal HiHat2 [EXC1]	Pedal HiHat2 [EXC1]
45	Real Tom 4	Room Tom 2	Room Tom 2	Synth Drum 2
46	Open HiHat2 [EXC1]	Open HiHat2 [EXC1]	Open HiHat2 [EXC1]	Open HiHat2 [EXC1]
47	Real Tom 4	Room Tom 2	Room Tom 2	Synth Drum 2
C3 48	Real Tom 1	Rock Tom 1	Rock Tom 1	Synth Drum 2
49	Crash Cym.1	Crash Cym.1	Crash Cym.1	Crash Cym.1
50	Real Tom 1	Rock Tom 1	Rock Tom 1	Synth Drum 2
51	Ride Cymbal	Ride Cymbal	Ride Cymbal	Ride Cymbal
52	ChinaCymbal	ChinaCymbal	ChinaCymbal	ReverseCymbal
53	Ride Bell	Ride Bell	Ride Bell	Ride Bell
54	Tambourine	Tambourine	Tambourine	Tambourine
55	Splash Cym.	Splash Cym.	Splash Cym.	Splash Cym.
56	Cowbell	Cowbell	Cowbell	Cowbell
57	Crash Cym.2	Crash Cym.2	Crash Cym.2	Crash Cym.2
58	Vibraslap	Vibraslap	Vibraslap	Vibraslap
59	Ride Cymbal4	Ride Cymbal4	Ride Cymbal4	Ride Cymbal4
C4 60	Bongo High	Bongo High	Bongo High	Bongo High
61	Bongo Lo	Bongo Lo	Bongo Lo	Bongo Lo
62	Mute H.Conga	Mute H.Conga	Mute H.Conga	Mute H.Conga
63	Conga Hi Opn	Conga Hi Opn	Conga Hi Opn	Conga Hi Opn
64	Conga Lo Opn	Conga Lo Opn	Conga Lo Opn	Conga Lo Opn
65	High Timbale	High Timbale	High Timbale	High Timbale
66	Low Timbale	Low Timbale	Low Timbale	Low Timbale
67	Agogo	Agogo	Agogo	Agogo
68	Agogo	Agogo	Agogo	Agogo
69	Cabasa	Cabasa	Cabasa	Cabasa
70	Maracas	Maracas	Maracas	Maracas
71	ShrtWhistle [EXC2]	ShrtWhistle [EXC2]	ShrtWhistle [EXC2]	ShrtWhistle [EXC2]
C5 72	LongWhistle [EXC2]	LongWhistle [EXC2]	LongWhistle [EXC2]	LongWhistle [EXC2]
73	Short Guiro [EXC3]	Short Guiro [EXC3]	Short Guiro [EXC3]	Short Guiro [EXC3]
74	Long Guiro [EXC3]	Long Guiro [EXC3]	Long Guiro [EXC3]	Long Guiro [EXC3]
75	Claves	Claves	Claves	Claves
76	Woodblock	Woodblock	Woodblock	Woodblock
77	Woodblock	Woodblock	Woodblock	Woodblock
78	Mute Cuica [EXC4]	Mute Cuica [EXC4]	Mute Cuica [EXC4]	Mute Cuica [EXC4]
79	Open Cuica [EXC4]	Open Cuica [EXC4]	Open Cuica [EXC4]	Open Cuica [EXC4]
80	MuteTriangl [EXC5]	MuteTriangl [EXC5]	MuteTriangl [EXC5]	MuteTriangl [EXC5]
81	OpenTriangl [EXC5]	OpenTriangl [EXC5]	OpenTriangl [EXC5]	OpenTriangl [EXC5]
82	Shaker	Shaker	Shaker	Shaker
83	Jingle Bell	Jingle Bell	Jingle Bell	Jingle Bell
C6 84	Bell Tree	Bell Tree	Bell Tree	Bell Tree
85	Castanets	Castanets	Castanets	Castanets
86	Mute Surdo [EXC6]	Mute Surdo [EXC6]	Mute Surdo [EXC6]	Mute Surdo [EXC6]
87	Open Surdo [EXC6]	Open Surdo [EXC6]	Open Surdo [EXC6]	Open Surdo [EXC6]
88	----	----	----	----

Rhythm Set List

* ----: No sound.

* [EXC]: will not sound simultaneously with other percussion instruments of the same number.

	GM2 ANALOG	GM2 JAZZ	GM2 BRUSH	GM2 ORCHSTRA	GM2 SFX
21	----	----	----	----	----
22	----	----	----	----	----
23	----	----	----	----	----
24	----	----	----	----	----
25	----	----	----	----	----
26	----	----	----	----	----
27	High-Q	High-Q	High-Q	Close HiHat2 [EXC1]	----
28	Slap	Slap	Slap	Pedal HiHat2 [EXC1]	----
29	ScratchPush [EXC7]	ScratchPush [EXC7]	ScratchPush [EXC7]	Open HiHat2 [EXC1]	----
30	ScratchPull [EXC7]	ScratchPull [EXC7]	ScratchPull [EXC7]	Ride Cymbal3	----
31	Sticks	Sticks	Sticks	Sticks	----
32	SquareClick	SquareClick	SquareClick	SquareClick	----
33	Mtrnm.Click	Mtrnm.Click	Mtrnm.Click	Mtrnm.Click	----
34	Mtrnm. Bell	Mtrnm. Bell	Mtrnm. Bell	Mtrnm. Bell	----
35	TR-808 Kick2	Jazz Kick 2	Jazz Kick 2	Concert BD	----
C3 36	TR-808 Kick	Jazz Kick 1	Jazz Kick 1	Mix Kick	----
37	808 Rimshot	Side Stick	Side Stick	Side Stick	----
38	808 Snare 1	Standard SN3	Brush Swirl	Concert Snr	----
39	909 HandClap	909 HandClap	Brush Slap1	Castanets	High-Q
40	Elec Snare 6	Elec Snare 5	Brush Swirl	Concert Snr	Slap
41	808 Tom 2	Real Tom 6	Brash Tom 2	Timpani	ScratchPush [EXC7]
42	TR-808 CHH [EXC1]	Close HiHat2 [EXC1]	Close HiHat3 [EXC1]	Timpani	ScratchPull [EXC7]
43	808 Tom 2	Real Tom 6	Brash Tom 2	Timpani	Sticks
44	808_chh [EXC1]	Pedal HiHat2 [EXC1]	Pedal HiHat3 [EXC1]	Timpani	SquareClick
45	808 Tom 2	Real Tom 4	Brash Tom 2	Timpani	Mtrnm.Click
46	TR-808 OHH [EXC1]	Open HiHat2 [EXC1]	Open HiHat3 [EXC1]	Timpani	Mtrnm. Bell
47	808 Tom 2	Real Tom 4	Brash Tom 2	Timpani	Gt.FretNoiz
C3 48	808 Tom 2	Real Tom 1	Brash Tom 2	Timpani	Gt.CutNoise
49	808 Crash	Crash Cym.1	Crash Cym.3	Timpani	Gt.CutNoise
50	808 Tom 2	Real Tom 1	Brash Tom 2	Timpani	String Slap
51	Ride Cymbal	Ride Cymbal	Ride Cymbal2	Timpani	Fl.KeyClick
52	ChinaCymbal	ChinaCymbal	ChinaCymbal	Timpani	Laughing
53	Ride Bell	Ride Bell 3	Ride Bell 2	Timpani	Screaming
54	Tambourine	Tambourine	Tambourine	Tambourine	Punch
55	Splash Cym.	Splash Cym.	Splash Cym.	Splash Cym.	Heart Beat
56	808cowbe	Cowbell	Cowbell	Cowbell	Footsteps
57	Crash Cym.2	Crash Cym.2	Crash Cym.2	Con.Cymbal2	Footsteps
58	Vibraslap	Vibraslap	Vibraslap	Vibraslap	Applause
59	Ride Cymbal4	Ride Cymbal4	Ride Cymbal4	Concert Cym.	Creaking
C4 60	Bongo High	Bongo High	Bongo High	Bongo High	Door
61	Bongo Lo	Bongo Lo	Bongo Lo	Bongo Lo	Scratch
62	808 Conga	Mute H.Conga	Mute H.Conga	Mute H.Conga	Wind Chimes
63	808 Conga	Conga Hi Opn	Conga Hi Opn	Conga Hi Opn	Car-Engine
64	808 Conga	Conga Lo Opn	Conga Lo Opn	Conga Lo Opn	Car-Stop
65	High Timbale	High Timbale	High Timbale	High Timbale	Car-Pass
66	Low Timbale	Low Timbale	Low Timbale	Low Timbale	Car-Crash
67	Agogo	Agogo	Agogo	Agogo	Siren
68	Agogo	Agogo	Agogo	Agogo	Train
69	Cabasa	Cabasa	Cabasa	Cabasa	Jetplane
70	808marac	Maracas	Maracas	Maracas	Helicopter
71	ShrtWhistle [EXC2]	ShrtWhistle [EXC2]	ShrtWhistle [EXC2]	ShrtWhistle [EXC2]	Starship
C5 72	LongWhistle [EXC2]	LongWhistle [EXC2]	LongWhistle [EXC2]	LongWhistle [EXC2]	Gun Shot
73	Short Guiro [EXC3]	Short Guiro [EXC3]	Short Guiro [EXC3]	Short Guiro [EXC3]	Machine Gun
74	Long Guiro [EXC3]	Long Guiro [EXC3]	Long Guiro [EXC3]	Long Guiro [EXC3]	Lasergun
75	808clave	Claves	Claves	Claves	Explosion
76	Woodblock	Woodblock	Woodblock	Woodblock	Dog
77	Woodblock	Woodblock	Woodblock	Woodblock	HorseGallop
78	Mute Cuica [EXC4]	Mute Cuica [EXC4]	Mute Cuica [EXC4]	Mute Cuica [EXC4]	Bird
79	Open Cuica [EXC4]	Open Cuica [EXC4]	Open Cuica [EXC4]	Open Cuica [EXC4]	Rain
80	MuteTriangl [EXC5]	MuteTriangl [EXC5]	MuteTriangl [EXC5]	MuteTriangl [EXC5]	Thunder
81	OpenTriangl [EXC5]	OpenTriangl [EXC5]	OpenTriangl [EXC5]	OpenTriangl [EXC5]	Wind
82	Shaker	Shaker	Shaker	Shaker	Seashore
83	Jingle Bell	Jingle Bell	Jingle Bell	Jingle Bell	Stream
C6 84	Bell Tree	Bell Tree	Bell Tree	Bell Tree	Bubble
85	Castanets	Castanets	Castanets	Castanets	----
86	Mute Surdo [EXC6]	Mute Surdo [EXC6]	Mute Surdo [EXC6]	Mute Surdo [EXC6]	----
87	Open Surdo [EXC6]	Open Surdo [EXC6]	Open Surdo [EXC6]	Open Surdo [EXC6]	----
88	----	----	----	Applause	----

Rhythm Pattern List

No.	Rhythm Pattern				
001	R&B Pop 1	066	R&B 9	131	Rhumba
002	R&B Pop 2	067	R&B 10	132	Mambo 1
003	R&B 1	068	R&B 11	133	Mambo 2
004	R&B 2	069	R&B 12	134	Merengue
005	Shuffle Pop 1	070	R&B 13	135	Power Fusion 1
006	Shuffle Pop 2	071	R&B 14	136	Power Fusion 2
007	Latin Pop 1	072	R&B 15	137	Rock 3
008	Latin Pop 2	073	R&B 16	138	Rock 4
009	Jazz Brush 1	074	R&B 17	139	Rock 5
010	Jazz Waltz	075	R&B 18	140	Rock 6
011	Ballad 1	076	Funk 1	141	Rock 7
012	Ballad 2	077	Funk 2	142	Rock 8
013	Rock 1	078	Funk 3	143	Rock 9
014	Rock 2	079	8Beat Rock 1	144	Rock 10
015	Back Beat 1	080	8Beat Rock 2	145	Rock 11
016	Back Beat 2	081	8Beat Rock 3	146	Rock 12
017	Elec Dance 1	082	16Beat Rock 1	147	Rock 13
018	Elec Dance 2	083	16Beat Rock 2	148	Rock 14
019	Pop 1	084	Ballad 3	149	Rock 15
020	Pop 2	085	Piano Ballad	150	Rock 16
021	Pop 3	086	Rockaballad	151	Rock 17
022	Pop 4	087	Blue Grass	152	Rock 18
023	8Beat Pop 1	088	Combo 1	153	Rock 19
024	8Beat Pop 2	089	Combo 2	154	Rock 20
025	8Beat Pop 3	090	Fast Swing 1	155	Progressive
026	8Bt Fusion 1	091	Fast Swing 2	156	Elec Dance 3
027	8Bt Fusion 2	092	Swing 1	157	Elec Dance 4
028	Pop Funk 1	093	Swing 2	158	Elec Dance 5
029	Pop Funk 2	094	Swing 3	159	Elec Dance 6
030	Pop Funk 3	095	Jazz Brush 2	160	Elec Dance 7
031	Pop Funk 4	096	Free Jazz	161	Elec Dance 8
032	Pop Funk 5	097	Jazz 1	162	Elec Dance 9
033	Pop Funk 6	098	Jazz 2	163	Elec Dance 10
034	Pop Funk 7	099	Jazz 3	164	Acid Jazz
035	Pop Funk 8	100	Jazz 4	165	Techno
036	16Beat Pop 1	101	Jazz 5	166	Hip Hop
037	16Beat Pop 2	102	Jazz 6	167	House
038	16Beat Pop 3	103	Jazz 7	168	Jungle
039	16Bt Fusion 1	104	Jazz 8	169	Dance
040	16Bt Fusion 2	105	Jazz 9	170	Pop Waltz 1
041	16Bt Fusion 3	106	Jazz 10	171	Pop Waltz 2
042	Shuffle Pop 3	107	Blues 1	172	Pop Waltz 3
043	Shuffle Pop 4	108	Blues 2	173	Pop Waltz 4
044	Shuffle Pop 5	109	Gospel 1	174	Simple Waltz 1
045	Shuffle Pop 6	110	Gospel 2	175	Simple Waltz 2
046	Shuffle Pop 7	111	Polka 1	176	3/4 Brush
047	West Coast	112	Polka 2	177	5/4 Fusion
048	Motown	113	Latin Pop 3	178	5/4 Swing
049	R&B Pop 3	114	Latin Pop 4	179	5/8 Progress
050	R&B Pop 4	115	Latin Pop 5	180	6/4 Fusion
051	R&B Pop 5	116	Latin Pop 6	181	6/8 Progress
052	Back Beat 3	117	Latin Pop 7	182	6/8 Swing
053	Back Beat 4	118	Latin Pop 8	183	7/4 Swing
054	Back Beat 5	119	Latin Pop 9	184	7/4 Swing
055	Back Beat 6	120	Latin Pop 10	185	7/8 Progress
056	Back Beat 7	121	Latin Pop 11		
057	Back Beat 8	122	Bossa Nova 1		
058	Back Beat 9	123	Bossa Nova 2		
059	Back Beat 10	124	Bossa Nova 3		
060	R&B 3	125	Fast Bossa		
061	R&B 4	126	Pop Bossa		
062	R&B 5	127	Salsa 1		
063	R&B 6	128	Salsa 2		
064	R&B 7	129	Samba 1		
065	R&B 8	130	Samba 2		

Setup List

cf.

Selecting Stored Settings ([SETUP]) (p. 34)

“RHY:”

These Setups let you enjoy performing with a session-like feel while playing a Rhythm.

Be sure to check it out. For more on Rhythms, refer to **Playing Rhythm ([RHYTHM])** (p. 32).

[PIANO]

- S.11 Piano&Pad 1
- S.12 RHY:Jazz Trio1
- S.13 Bright Pad
- S.14 3D Effect

[STRINGS/PAD]

- S.41 Phaser Pad
- S.42 RHY:Bigband
- S.43 Strings&Winds
- S.44 RHY:Swing Vibe

[VOICE/SYNTH]

- S.71 RHY:Trance
- S.72 Large Choir
- S.73 RHY:Piano/EP
- S.74 Humanizer

[E.PIANO]

- S.21 RHY:Jazz Trio2
- S.22 Harpsi/Strings
- S.23 RHY:Latin
- S.24 Piano&Pad 2

[GUITAR/BASS]

- S.51 RHY: Rock
- S.52 Synth Brass
- S.53 RHY:Jazz Trio3
- S.54 Warm Pad

[RHY/GM2]

- S.81 RD SETUP
- S.82 RD SETUP
- S.83 RD SETUP
- S.84 RD SETUP

[ORGAN]

- S.31 Organ Split
- S.32 RHY:Jazz Funk
- S.33 Cathedral
- S.34 RHY: R&B Groove

[BRASS/WINDS]

- S.61 Orchestra
- S.62 Flute/E.Piano
- S.63 RHY:SwingPop
- S.64 Comp Piano

* Setup No. 81–84 (RD SETUP) include the “Basic Setup.” Use this when creating Setups from scratch.

Shortcut List

You can easily change settings for the following functions using a number of related buttons.

* “[A] + [B]” indicates that you are to hold down [A] and press [B].

What to do	Operation	Page
Changing the Sound Controller Type	[SOUND CONTROL] + [INC/DEC]	p. 30
Changing the Reverb Depth	[REVERB] + [INC/DEC]	p. 27
Changing the Reverb Depth for Each Tone	[REVERB] + [ZONE LEVEL SLIDER]	p. 41
Changing the Amount of Multi-effects Applied	[MULTI EFFECTS] + [INC/DEC]	p. 28
Changing the Amount of Transposition	[TRANSCOPE] + [INC/DEC] [TRANSCOPE] + Key	p. 25
Changing Rhythm Patterns	[RHYTHM] + [INC/DEC]	p. 32
Changing the Rhythm Pattern Volume Level	[RHYTHM] + [ZONE LEVEL SLIDER]	p. 33
Changing the Split Point Key	[SPLIT] + [INC/DEC] [SPLIT] + Key	p. 23

Switching V-LINK On and Off	[SHIFT] + [SOUND CONTROL]	p. 51
Changing the Reverb Type	[SHIFT] + [REVERB]	p. 27
Changing the Multi-effects Type	[SHIFT] + [MULTI EFFECTS]	p. 29
Switching MIDI TX On and Off	[SHIFT] + [MIDI TX]	p. 47
Changing the Rhythm Tempo	[SHIFT] + [RHYTHM]	p. 33
Changing the Key Touch	[SHIFT] + [LOWER SELECT]	p. 26

Main Specifications

RD-300SX: Digital Piano (Conforms to General MIDI 2 System)

● Keyboard

88 keys (Compact Progressive Hammer Action Keyboard)

● Part

16 Parts

● Maximum Polyphony

128 voices

● Wave Memory

64 M bytes (16-bit linear equivalent)

● Tones

Normal Tones: 70
General MIDI 2 Tones: 256
Rhythm Sets: 5
General MIDI 2 Rhythm Sets: 9

● Setups

32

● Effects

Multi-Effects: 78 types
Reverb: 4 types
Sound Control
2-band Digital Equalizer

● Rhythm Pattern

185 styles

● Controllers

Zone Level slider x 2
Equalizer knobs
Pitch Bend/Modulation lever

● Display

7 segments, 3 characters (LED)

● Connectors

Headphones Jack: Stereo 1/4 inch phone type
Output Jacks (L/MONO, R): 1/4 inch phone type
Pedal Jacks (DAMPER, CONTROL): 1/4 inch TRS phone type
MIDI Connectors (IN, OUT)
USB Connector (MIDI)
DC IN Jack

● Power Supply

DC 9 V (AC adaptor)

● Power Consumption

11 W

● Dimensions

1,408 (W) x 336 (D) x 134 (H) mm
55-7/16 (W) x 13-1/4 (D) x 5-5/16 (H) inches

● Weight

15.5 kg / 34 lbs 3 oz

● Accessories

Owner's Manual
USB Installation guide
CD-ROM (Roland Digital USB Driver)
Damper Pedal (DP-8)
AC Adaptor (PSB-1U)
Power Cord

● Options

Keyboard Stand: KS-12
Pedal Switch: DP-2
Damper Pedal: DP-8
Foot Switch: BOSS FS-5U,
FS-6 (TRS phone jacks cannot be used.)
Expression Pedal: EV-5, EV-7
MIDI Implementation

* In the interest of product improvement, the specifications and/or appearance of this unit are subject to change without prior notice.

Index

- A**
Attack Time 41
- B**
Bend Range 42
Bender Lever 30
Bulk Dump
 Setup 44
 Temporary 44
- C**
Common 40
Connecting
 Computer 50
 External Equipment 12
 External MIDI Sound Generators 47
 External Sequencer 48
 Pedals 12
 Power Cord 11
CONTROL 10
Control Pedal Function 40
Control Pedal Polarity 39
Control Pedal Switch 43
Cord Hook 10
Cutoff 41
- D**
DAMPER 10
Damper Pedal Polarity 38
Damper Pedal Switch 43
DC In jack 10
DEC 9, 16
Decay Time 41
Demo Play 17
DISPLAY 9
DUAL 9, 21
Dual Mode 20–21
- E**
EDIT 9, 37
Edit
 Common 40
 Part 43
 System 37
 Tone Parameter 41
 Utility 44
 Zone Parameter 42
Effects List 55
ENTER 9
EQUALIZER 9, 31
Error Messages 59
EXIT 9
- F**
Factory Reset 45
Fine Tune 42
FUNCTION 9
- G**
Ground Terminal 10
- H**
HIGH Knob 9
- I**
INC 9, 16
- K**
Key 38
KEY TOUCH 9
Key Transpose 43
Keyboard Controller Section 16
Keyboard Modes 20
Keyboard's Touch 26
Keynote 38
- L**
Local Control 46
Lock
 Panel 36
LOW Knob 9
LOWER SELECT 9, 24
- M**
Master Keyboard 47
Master Tune 15
Master Tuning 38
MFX Zone 40
MIDI 47
MIDI Connectors 10
MIDI Implementation Chart 67
MIDI TX 9
MIDI Tx Mode 46
MODE 9
Modulation Lever 9, 30
Modulation Switch 43
MULTI EFFECTS 9, 28
Multi Effects 40
 Depth 28
 Rotary Effect 29
 Type 29
- O**
ONE TOUCH 9
OUTPUT R/L(MONO) Jacks 10

P	
Pan	43
Panel Lock	36
Part	16, 43
Pedal Function	40
PEDAL Jacks	10
PHONES Jack	10
ONE TOUCH	9, 18
Pitch	30, 38
Pitch Bend Lever	9
Pitch Bender Switch	43
Polarity	
Control Pedal	39
Damper Pedal	38
POWER	10
Program Change Messages	39
R	
Recording	48
Release Time	41
Resonance	41
Restoring	45
Factory Reset	45
REVERB	9, 27
Reverb Effect	
Depth	27
Type	27
Reverb Send Level	41
RHYTHM	9, 32
Rhythm	
Pattern	32
Tempo	33
Volume	33
Rhythm Pattern List	65
Rhythm Set List	62
Rotary Effect	29
S	
Setup	34
Setup Bulk Dump	44
Setup Control Channel	39
Setup Pedal Shift	39
SHIFT	9
Shortcut List	66
Single Mode	20
SOUND CONTROL	9, 30
Sound Generator Section	16
SPLIT	9, 22
Split Mode	20, 22
Split Point	23
Stretch Tune	38
System	37
T	
Temperament	38
TEMPO	9
Tempo	
Rhythm	33
Tone	16
Tone List	60
Tone Parameter	41
TONE SELECT Buttons	9
Tonic	38
Touch	26
Transferring	
Setups	44
TRANSPOSE	9, 25
Troubleshooting	52
Tuning	15, 38
U	
USB Connector	10
USB Driver	39, 50
USB Mode	50
Utility	44
V	
Velocity	26
V-LINK	9, 51
VOLUME Slider	9, 14
W	
WRITE	9, 35
Z	
Zone	16, 24
ZONE LEVEL Sliders	9, 24
Zone Parameter	42

For the U.K.

IMPORTANT: THE WIRES IN THIS MAINS LEAD ARE COLOURED IN ACCORDANCE WITH THE FOLLOWING CODE.

BLUE: NEUTRAL
BROWN: LIVE

As the colours of the wires in the mains lead of this apparatus may not correspond with the coloured markings identifying the terminals in your plug, proceed as follows:

The wire which is coloured BLUE must be connected to the terminal which is marked with the letter N or coloured BLACK.
The wire which is coloured BROWN must be connected to the terminal which is marked with the letter L or coloured RED.
Under no circumstances must either of the above wires be connected to the earth terminal of a three pin plug.

For EU Countries



This product complies with the requirements of European Directive 89/336/EEC.

For the USA

FEDERAL COMMUNICATIONS COMMISSION RADIO FREQUENCY INTERFERENCE STATEMENT

This equipment has been tested and found to comply with the limits for a Class B digital device, pursuant to Part 15 of the FCC Rules. These limits are designed to provide reasonable protection against harmful interference in a residential installation. This equipment generates, uses, and can radiate radio frequency energy and, if not installed and used in accordance with the instructions, may cause harmful interference to radio communications. However, there is no guarantee that interference will not occur in a particular installation. If this equipment does cause harmful interference to radio or television reception, which can be determined by turning the equipment off and on, the user is encouraged to try to correct the interference by one or more of the following measures:

- Reorient or relocate the receiving antenna.
- Increase the separation between the equipment and receiver.
- Connect the equipment into an outlet on a circuit different from that to which the receiver is connected.
- Consult the dealer or an experienced radio/TV technician for help.

This device complies with Part 15 of the FCC Rules. Operation is subject to the following two conditions:

- (1) This device may not cause harmful interference, and
- (2) This device must accept any interference received, including interference that may cause undesired operation.

Unauthorized changes or modification to this system can void the users authority to operate this equipment.
This equipment requires shielded interface cables in order to meet FCC class B Limit.

For Canada

NOTICE

This Class B digital apparatus meets all requirements of the Canadian Interference-Causing Equipment Regulations.

AVIS

Cet appareil numérique de la classe B respecte toutes les exigences du Règlement sur le matériel brouilleur du Canada.

For the USA

DECLARATION OF CONFORMITY Compliance Information Statement

Model Name : RD-300SX
Type of Equipment : Digital Piano
Responsible Party : Roland Corporation U.S.
Address : 5100 S. Eastern Avenue, Los Angeles, CA 90040-2938, U. S. A.
Telephone : (323) 890 3700

Information

When you need repair service, call your nearest Roland Service Center or authorized Roland distributor in your country as shown below.

AFRICA

EGYPT

Al Fanny Trading Office
9, EBN Hagar A1 Askalany Street,
ARD E1 Golf, Heliopolis,
Cairo 11341, EGYPT
TEL: 20-2-417-1828

REUNION

Maison FO - YAM Marcel
25 Rue Jules Hermann,
Chaudron - BP79 97 491
Ste Clotilde Cedex,
REUNION ISLAND
TEL: (0262) 218-429

SOUTH AFRICA

That Other Music Shop(Pty)Ltd.
11 Melle St., Braamfontein,
Johannesburg,
SOUTH AFRICA
TEL: (011) 403 4105
FAX: (011) 403 1234

Paul Bothner(Pty)Ltd.
Royal Cape Park, Unit 24
Londonderry Road, Ottery 7800
Cape Town, SOUTH AFRICA
TEL: (021) 799 4900

ASIA

CHINA

Roland Shanghai Electronics Co.,Ltd.
5F, No.1500 Pingliang Road
Shanghai 200090, CHINA
TEL: (021) 5580-0800

Roland Shanghai Electronics Co.,Ltd.
(BEIJING OFFICE)
10F, No.18 3 Section Anhuaxili
Chaoyang District Beijing
100011 CHINA
TEL: (010) 6426-5050

Roland Shanghai Electronics Co.,Ltd.
(GUANGZHOU OFFICE)
2/F, No.30 Si You Nan Er Jie
Yi Xiang, Wu Yang Xin Cheng,
Guangzhou 510600, CHINA
TEL: (020) 8736-0428

HONG KONG

Tom Lee Music Co., Ltd.
Service Division
22-32 Pun Shan Street, Tsuen
Wan, New Territories,
HONG KONG
TEL: 2415 0911

Parsons Music Ltd.

8th Floor, Railway Plaza, 39
Chatham Road South, T.S.T,
Kowloon, HONG KONG
TEL: 2333 1863

INDIA

Rivera Digitec (India) Pvt. Ltd.
409, Nirman Kendra
Mahalaxmi Flats Compound
Off. Dr. Edwin Moses Road,
Mumbai-400011, INDIA
TEL: (022) 2493 9051

INDONESIA

PT Citra IntiRama
J1. Cideng Timur No. 15J-150
Jakarta Pusat
INDONESIA
TEL: (021) 6324170

KOREA

Cosmos Corporation
1461-9, Seocho-Dong,
Seocho Ku, Seoul, KOREA
TEL: (02) 3486-8855

MALAYSIA

Roland Asia Pacific Sdn. Bhd.
45-1, Block C2, Jalan PJU 1/39,
Dataran Prima, 47301 Petaling
Jaya, Selangor, MALAYSIA
TEL: (03) 7805-3263

PHILIPPINES

G.A. Yupangco & Co. Inc.
339 Gil J. Puyat Avenue
Makati, Metro Manila 1200,
PHILIPPINES
TEL: (02) 899 9801

SINGAPORE

SWEE LEE MUSIC COMPANY PTE. LTD.
150 Sims Drive,
SINGAPORE 387381
TEL: 6846-3676

TAIWAN

ROLAND TAIWAN ENTERPRISE CO., LTD.
Room 5, 9fl. No. 112 Chung
Shan N.Road Sec.2, Taipei,
TAIWAN, R.O.C.
TEL: (02) 2561 3339

THAILAND

Theera Music Co., Ltd.
330 Soi Veng NakornKasem,
New Road, Sumpantawongse,
Bangkok 10100, THAILAND
TEL: (02) 224-8821

VIETNAM

SAIGON MUSIC DISTRIBUTOR (TAN DINH MUSIC)
138 Tran Quang Khai Street
Dist. 1, Ho Chi Minh City
VIETNAM
TEL: (08) 848-4068

AUSTRALIA/ NEW ZEALAND

AUSTRALIA/ NEW ZEALAND

Roland Corporation Australia Pty.,Ltd.
38 Campbell Avenue
Dee Why West. NSW 2099
AUSTRALIA

For Australia
Tel: (02) 9982 8266
For New Zealand
Tel: (09) 3098 715

CENTRAL/LATIN AMERICA

ARGENTINA

Instrumentos Musicales S.A.
Av.Santa Fe 2055
(1123) Buenos Aires
ARGENTINA
TEL: (011) 4508-2700

BARBADOS

A&B Music Supplies LTD
12 Webster Industrial Park
Wildest, St.Michael, Barbados
TEL: (246)430-1100

BRAZIL

Roland Brasil Ltda.
Rua San Jose, 780 Sala B
Parque Industrial San Jose
Cotia - Sao Paulo - SP, BRAZIL
TEL: (011) 4615 5666

CHILE

Comercial Fancy II S.A.
Rut.: 96.919.420-1
Nataliel Cox #739, 4th Floor
Santiago - Centro, CHILE
TEL: (02) 688-9540

COLOMBIA

Centro Musical Ltda.
Cra 43 B No 25 A 41 Bododega 9
Medellin, Colombia
TEL: (574)3812529

COSTA RICA

JUAN Bansbach Instrumentos Musicales
Ave.1. Calle 11, Apartado 10237,
San Jose, COSTA RICA
TEL: 258-0211

CURACAO

Zeelandia Music Center Inc.
Orionweg 30
Curacao, Netherland Antilles
TEL:(305)5926866

DOMINICAN REPUBLIC

Instrumentos Fernando Giraldez
Calle Proyecto Central No.3
Ens.La Esperilla
Santo Domingo,
Dominican Republic
TEL:(809) 683 0305

ECUADOR

Mas Musica
Rumichaca 822 y Zaruma
Guayaquil - Ecuador
TEL:(593-4)2302364

EL SALVADOR

OMNI MUSIC
75 Avenida Norte y Final
Alameda Juan Pablo II,
Edificio No.4010 San Salvador,
EL SALVADOR
TEL: 262-0788

GUATEMALA

Casa Instrumental
Calzada Roosevelt 34-01,zona 11
Ciudad de Guatemala
Guatemala
TEL:(502) 599-2888

HONDURAS

Almacén Pajaro Azul S.A. de C.V.
BO.Paz Barahona
3 Ave.11 Calle S.O
San Pedro Sula, Honduras
TEL: (504) 553-2029

MARTINIQUE

Musique & Son
Z.Les Mangle
97232 Le Lamantin
Martinique F.W.I.
TEL: 596 596 426860

Gigamusic SARL

10 Rte De La Folie
97200 Fort De France
Martinique F.W.I.
TEL: 596 596 715222

MEXICO

Casa Veerkamp, s.a. de c.v.
Av. Toluca No. 323, Col. Olivar
de los Padres 01780 Mexico
D.F. MEXICO
TEL: (55) 5668-6699

NICARAGUA

Bansbach Instrumentos Musicales Nicaragua
Altamira D'Este Calle Principal
de la Farmacia 5ta.Avenida
1 Cuadra al Lago.#503
Managua, Nicaragua
TEL: (505)277-2557

PANAMA

SUPRO MUNDIAL, S.A.
Boulevard Andrews, Albrook,
Panama City, REP. DE
PANAMA
TEL: 315-0101

PARAGUAY

Distribuidora De Instrumentos Musicales
J.E. Olear y ESQ. Manduivira
Asuncion PARAGUAY
TEL: (595) 21 492147

PERU

Audionet
Distribuciones Musicales SAC
Juan Fanning 530
Miraflores
Lima - Peru
TEL: (511) 4461388

TRINIDAD

AMR Ltd
Ground Floor
Maritime Plaza
Barataria Trinidad W.I.
TEL: (868) 638 6385

URUGUAY

Todo Musica S.A.
Francisco Acuna de Figueroa
1771
C.P.: 11.800
Montevideo, URUGUAY
TEL: (02) 924-2335

VENEZUELA

Instrumentos Musicales Allegro,C.A.
Av.las industrias edf.Guitar
import
#7 zona Industrial de Turumo
Caracas, Venezuela
TEL: (212) 244-1122

EUROPE

AUSTRIA

Roland Elektronische Musikinstrumente HmbH.
Austrian Office
Eduard-Bodem-Gasse 8,
A-6020 Innsbruck, AUSTRIA
TEL: (0512) 26 44 260

BELGIUM/FRANCE/ HOLLAND/ LUXEMBOURG

Roland Central Europe N.V.
Houtstraat 3, B-2260, Oevel
(Westerlo) BELGIUM
TEL: (014) 575811

CZECH REP.

K-AUDIO
Kardasovska 626.
CZ-198 00 Praha 9,
CZECH REP.
TEL: (2) 666 10529

DENMARK

Roland Scandinavia A/S
Nordhavnsvej 7, Postbox 880,
DK-2100 Copenhagen
DENMARK
TEL: 3916 6200

FINLAND

Roland Scandinavia As, Filial Finland
Elannontie 5
FIN-01510 Vantaa, FINLAND
TEL: (09) 68 24 020

GERMANY

Roland Elektronische Musikinstrumente HmbH.
Oststrasse 96, 22844
Norderstedt, GERMANY
TEL: (040) 52 60090

GREECE

STOLLAS S.A.
Music Sound Light
155, New National Road
Patras 26442, GREECE
TEL: 2610 435400

HUNGARY

Roland East Europe Ltd.
Warehouse Area 'DEPO' Pf.83
H-2046 Torokbalint,
HUNGARY
TEL: (23) 511011

IRELAND

Roland Ireland
G2 Calmount Park, Calmount
Avenue, Dublin 12
Republic of IRELAND
TEL: (01) 4294444

ITALY

Roland Italy S. p. a.
Viale delle Industrie 8,
20020 Arese, Milano, ITALY
TEL: (02) 937-78300

NORWAY

Roland Scandinavia Adv. Kontor Norge
Lilleakerveien 2 Postboks 95
Lilleaker N-0216 Oslo
NORWAY
TEL: 2273 0074

POLAND

MX MUSIC SP.Z.O.O.
UL. Gibraltarska 4.
PL-03664 Warszawa POLAND
TEL: (022) 679 44 19

PORTUGAL

Roland Iberia, S.L. Portugal Office
Cais das Pedras, 8/9-1 Dto
4050-465, Porto, PORTUGAL
TEL: 22 608 00 60

ROMANIA

FBS LINES
Piata Libertatii 1,
535500 Gheorgheni,
ROMANIA
TEL: (266) 364 609

RUSSIA

MuTek
Dorozhnaya ul.3,korp.6
117 545 Moscow, RUSSIA
TEL: (095) 981-4967

SPAIN

Roland Iberia, S.L.
Paseo Garcia Faria, 33-35
08005 Barcelona SPAIN
TEL: 93 493 91 00

SWEDEN

Roland Scandinavia A/S SWEDISH SALES OFFICE
Danvik Center 28, 2 tr.
S-131 30 Nacka SWEDEN
TEL: (08) 702 00 20

SWITZERLAND

Roland (Switzerland) AG
Landstrasse 5, Postfach,
CH-4452 Itingen,
SWITZERLAND
TEL: (061) 927-8383

UKRAINE

TIC-TAC
Mira Str. 19/108
P.O. Box 180
295400 Munkachevo,
UKRAINE
TEL: (03131) 414-40

UNITED KINGDOM

Roland (U.K.) Ltd.
Atlantic Close, Swansea
Enterprise Park, SWANSEA
SA7 9FJ,
UNITED KINGDOM
TEL: (01792) 702701

MIDDLE EAST

BAHRAIN

Moon Stores
No.16, Bab Al Bahrain Avenue,
P.O.Box 247, Manama 304,
State of BAHRAIN
TEL: 17 211 005

CYPRUS

Radex Sound Equipment Ltd.
17, Diagorou Street, Nicosia,
CYPRUS
TEL: (022) 66-9426

IRAN

MOCO INC.
No.41 Nike St., Dr.Shariyati Ave.,
Roberoye Cerah Mirdamad
Tehran, IRAN
TEL: (021) 285-4169

ISRAEL

Halilit P. Greenspoon & Sons Ltd.
8 Retzif Ha'aliya Hashnya St.
Tel-Aviv-Yafo ISRAEL
TEL: (03) 6823666

JORDAN

MUSIC HOUSE CO. LTD.
FREDDY FOR MUSIC
P. O. Box 922846
Amman 11192 JORDAN
TEL: (06) 5692696

KUWAIT

EASA HUSAIN AL-YOUSIFI & SONS CO.
Abdullah Salem Street,
Safat, KUWAIT
TEL: 243-6399

LEBANON

Chahine S.A.L.
Gerge Zeidan St., Chahine
Bldg., Achrafieh, P.O.Box: 16-
5857
Beirut, LEBANON
TEL: (01) 20-1441

OMAN

TALENTZ CENTRE L.L.C.
Malatan House No.1
Al Noor Street, Ruwi
SULTANATE OF OMAN
TEL: 2478 3443

QATAR

Al Emadi Co. (Badie Studio & Stores)
P.O. Box 62, Doha, QATAR
TEL: 4423-554

SAUDI ARABIA

aDawlah Universal Electronics APL
Corniche Road, Aldossary
Bldg., 1st Floor, Alkhobar,
SAUDI ARABIA

P.O.Box 2154, Alkhobar 31952
SAUDI ARABIA
TEL: (03) 898 2081

SYRIA

Technical Light & Sound Center
Rawda, Abdul Qader Jazairi St.
Bldg. No. 21, P.O.BOX 13520,
Damascus, SYRIA
TEL: (011) 223-5384

TURKEY

ZUHAL DIS TICARET A.S.
Galip Dede Cad. No.37
Beyoglu - Istanbul / TURKEY
TEL: (0212) 249 85 10

U.A.E.

Zak Electronics & Musical Instruments Co. L.L.C.
Zabeel Road, Al Sherooq Bldg.,
No. 14, Grand Floor, Dubai,
U.A.E.
TEL: (04) 3360715

NORTH AMERICA

CANADA

Roland Canada Music Ltd.
(Head Office)
5480 Parkwood Way
Richmond B. C., V6V 2M4
CANADA
TEL: (604) 270 6626

Roland Canada Music Ltd.

(Toronto Office)
170 Admiral Boulevard
Mississauga On L5T 2N6
CANADA
TEL: (905) 362 9707

U. S. A.

Roland Corporation U.S.
5100 S. Eastern Avenue
Los Angeles, CA 90040-2938,
U. S. A.
TEL: (323) 890 3700

As of December 10, 2005 (ROLAND)



03785945

'06-1-4N