

 Roland

MIDI DIGITAL PIANO

RD-1000

Owner's Manual

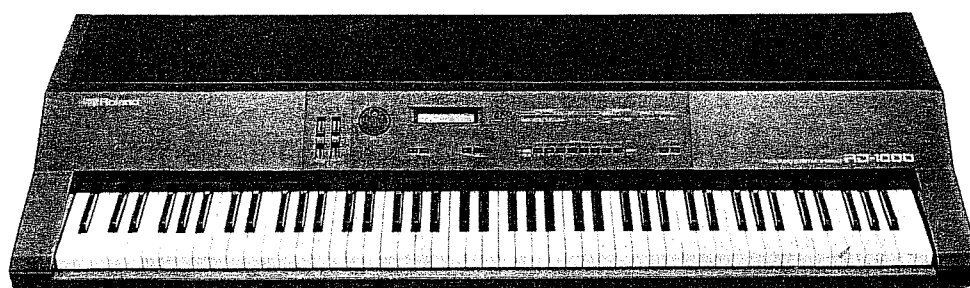

Roland has succeeded in the development of the Structured Adaptive System which is a digital technology that analyzes and extracts the acoustic sound then synthesizes highly expressive sounds.

The Roland Structured Adaptive System makes it possible to analyze and extract the tone color alteration of the acoustic piano sound in each note caused by the difference of the key touch pressure, then reproduces the most natural tone color alteration, according to the note played and its key pressure.

Before this owner's manual, please read the separate book "MIDI".

FEATURES

- The Roland RD-1000 MIDI Digital Piano features highly expressive sounds owing to its SA sound source.
- The RD-1000 includes the Chorus and the Tremolo effects and an equalizers which serves to make wider variation of sounds.
- The RD-1000's memory capacity is 8 preset voices which cannot be rewritten and 56 which can be programmed as your like.
- The 64 original voices of the RD-1000 can be saved on the Memory Cartridge (M-16C).
- The back-lighted LCD (Liquid Crystal Display) makes the operation on a dark stage easier.
- The XLR (Balanced type) connectors allow setup with professional equipment.
- The RD-1000 can be used as a perfect MIDI keyboard controller.

Bescheinigung des Herstellers /Importeurs
Hiermit wird bescheinigt, daß der/die/das ROLAND DIGITAL PIANO RD-1000 <small>(Gerät. Typ. Bezeichnung)</small>
in Übereinstimmung mit den Bestimmungen der Amtsbl. Vfg 1046 / 1984 <small>(Amtsblattverfügung)</small>
funk-entstört ist. Der Deutschen Bundespost wurde das Inverkehrbringen dieses Gerätes angezeigt und die Berechtigung zur Überprüfung der Serie auf Einhaltung der Bestimmungen eingeräumt.
Roland Corporation Osaka / Japan <small>Name des Herstellers/Importeurs</small>

CONTENTS

1	PANEL DESCRIPTION	3
	IMPORTANT NOTES	3
2	KEY LOCK AND CONNECTIONS	5
	1. How to unlock the Key Lock	5
	2. How to connect the Pedal Unit to the Main Unit	6
	3. How to set up the amplifier	6
3	OPERATION	7
	1. Basic Operation	7
	a. Voice Selection	7
	1) Voice Preserve Function	8
	b. Tuning	9
	c. Damper Pedal/Soft Pedal	9
	d. Chorus/Tremolo	10
	e. Key Transpose	10
	2. Sound Editing	12
	a. About Bank	12
	b. About Functions	12
	1) Voice Functions	12
	2) System Functions	12
	c. Calling a Parameter	13
	d. Edit	13
	e. Parameters	14
	1) Voice Level	14
	2) Equalizer Section	14
	Bass Equalizer	14
	Middle Equalizer	14
	Treble Equalizer	14
	3) Chorus	15
	4) Tremolo	15
	f. Memory Cartridge	15
	1) Saving	15
	2) Loading	16
	g. Touch Response	17
4	MIDI	18
	1. MIDI Connectors	18
	2. RD-1000 as a MIDI Keyboard Controller	18
	a. Setting Transmit Channel	18
	b. Transmitting Program Change	19
	3. RD-1000 as a MIDI Sound Module	22
	a. Setting Receive Channel	22
	b. Setting Program Change	22
	4. MIDI Functions	22
5	SPECIFICATIONS	29

Please read the separate volume "MIDI", before reading this owner's manual.

Copyright © 1986 by ROLAND CORPORATION

All rights reserved. No part of this publication may be reproduced in any form without the written permission of ROLAND CORPORATION.

1 PANEL DESCRIPTION

<Front Panel>

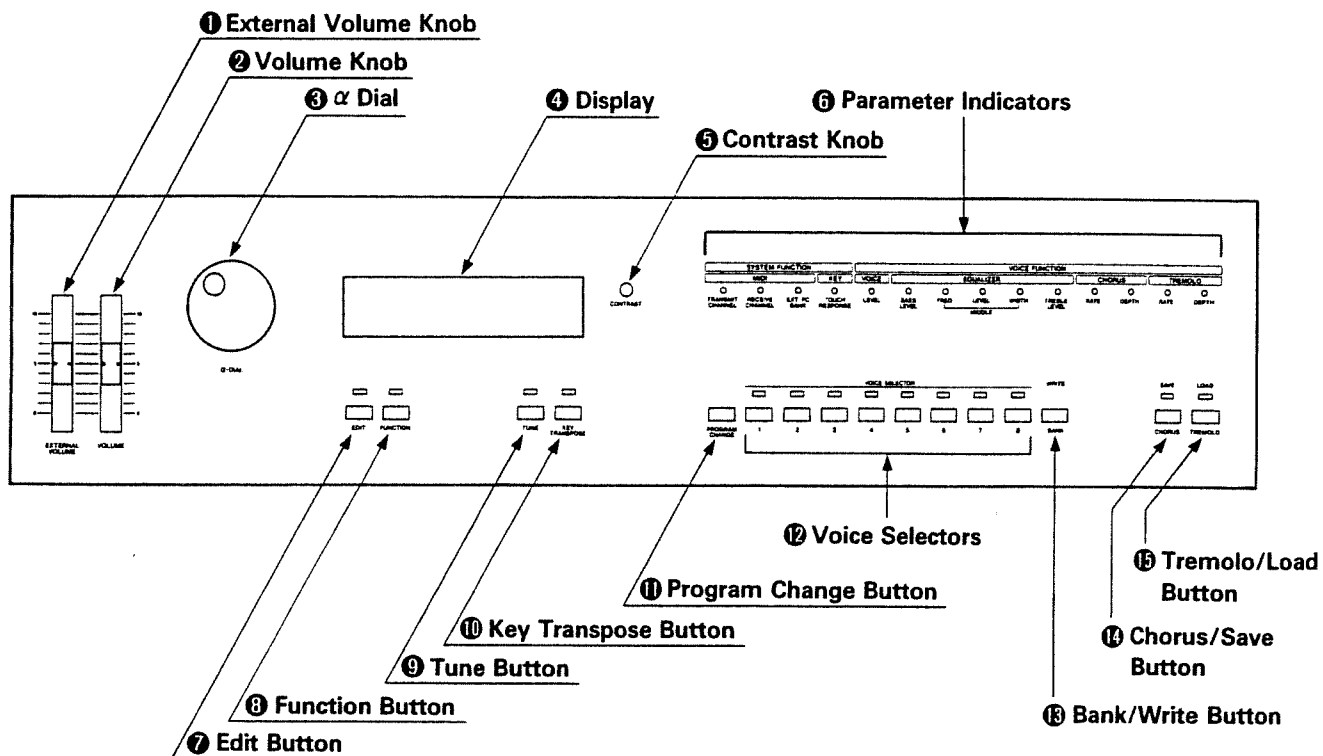

IMPORTANT NOTES

Power Supply

- The appropriate voltage to be used is shown on the name plate on the rear panel. Be sure that the requirement meets the voltage system in your country.
- Do not use the same socket that is used for any noise generating device, such as a motor, or variable lighting system.
- When setting up the RD-1000, be sure that all the units are turned off.
- This unit might not work properly if the power cable is plugged in with the unit turned on. If this happens, simply turn the unit off, and turn it on again in a few seconds.
- This unit might slightly generate heat while operating, but there is nothing to worry about it.

Power Cord

When disconnecting the power cord from the socket, do not hold the cord but the plug. When the unit is not to be used for a long period, disconnect the power cord.

Location

- Operating the RD-1000 near a neon or fluorescent lamp may cause noise interference. If so, change the angle or position of the RD-1000.
- Avoid using the RD-1000 in extreme heat or humidity or where it may be affected by dust.

<Rear Panel>

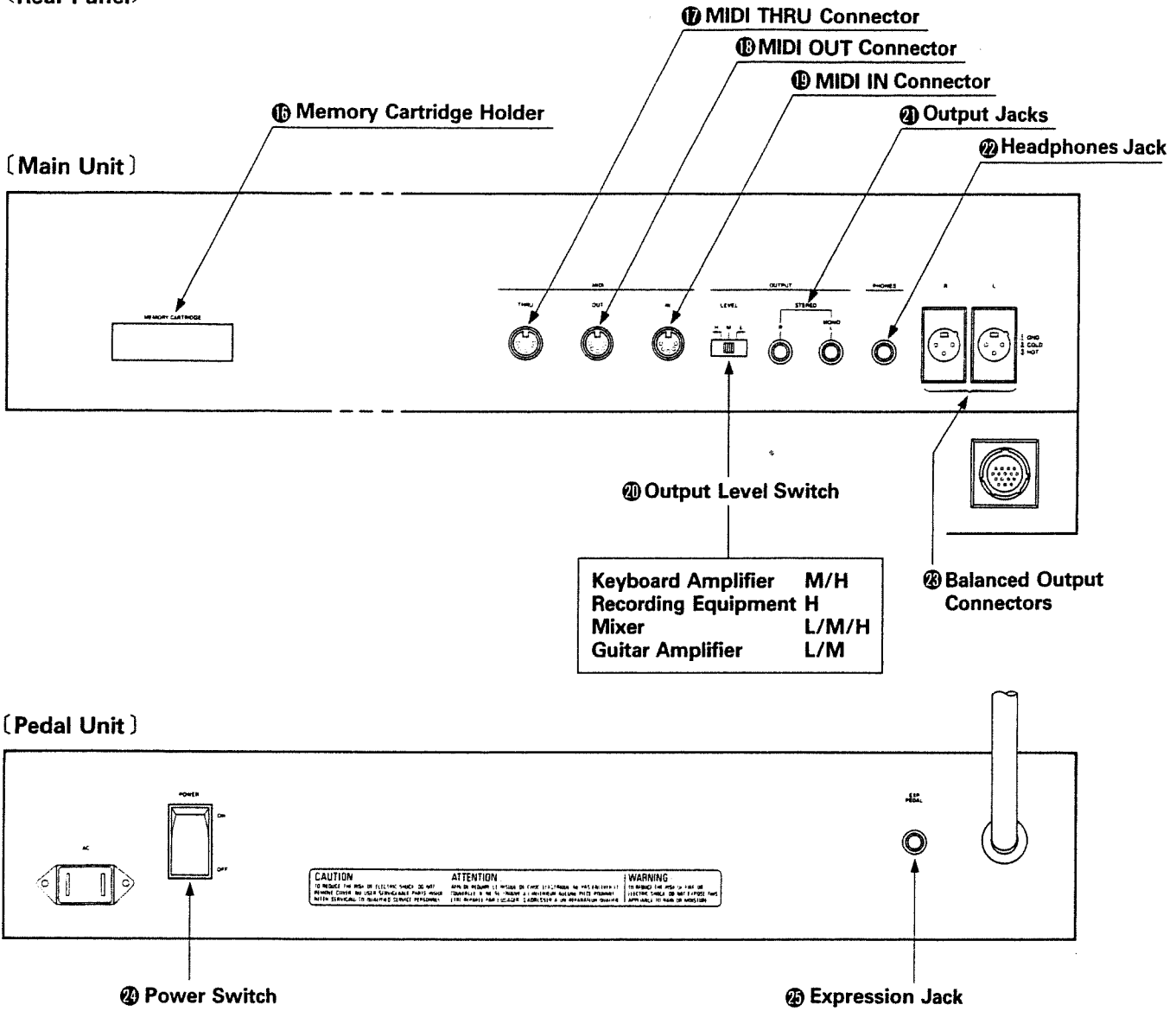

Cleaning

- Use a soft cloth and clean only with a mild detergent.
- Do not use solvents such as paint thinner.

Memory Backup

- The RD-1000's memory back-up system is fully supported by a battery. Normally, the battery replacement is required every five years, but the first replacement may be needed even before that depending how many months had passed before you bought it. Please ask for your local Roland dealer for replacement. Save the data in memory onto a cartridge or make a synthesis memo of each sound, before having the RD-1000 repaired. The data may be accidentally lost during repairing process, and if it happens, there is no way to retrieve it.

2 KEY LOCK AND CONNECTIONS

Before using the RD-1000, be sure to unlock the Key-lock and connect the Pedal Unit to the Main Unit.

1. How to unlock the Key Lock

The RD-1000 features the Key Lock system to prevent key action disorder caused in transit. When the RD-1000 is released from the manufacturer, it is locked (with the two levers on the bottom of the body). You are required to unlock them before using the RD-1000 as shown below. Also, be sure to lock the RD-1000 again when transporting.

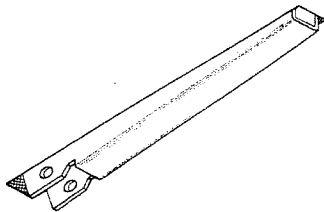
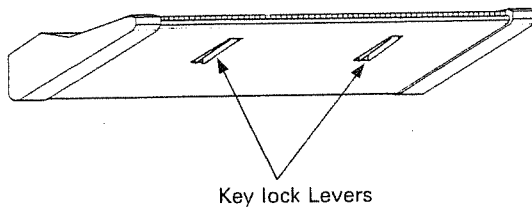

- ① Straighten the lever to the vertical position.

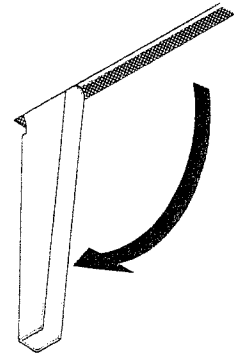

- ② Rotate the lever half circle. (Either clockwise or counterclockwise will do.)

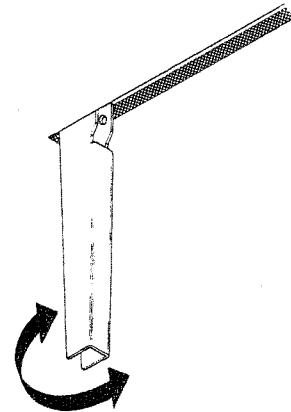

- ③ Return the lever to the horizontal position.

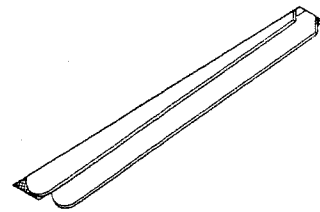

To lock the Key Lock, take the reverse procedure.

2. How to connect the Pedal Unit to the Main Unit

The Pedal Unit is a damper pedal and a soft pedal with a built-in power supply unit. That is, the RD-1000 does not operate without the Pedal Unit connected.

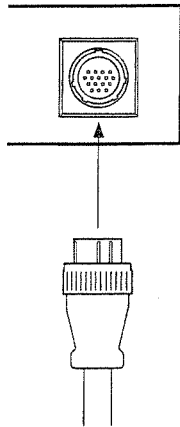

- ① Connect the cable of the Pedal Unit to the Cable Socket on the rear panel of the RD-1000.

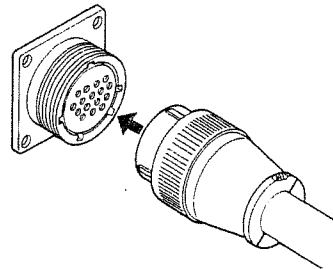

- ② Tighten the ring of the receptacle.

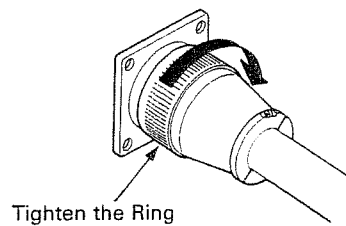

To disconnect the Pedal Unit, take the reverse procedure with the RD-1000 turned off.

3. How to setup the amplifier

The Output Level Switch ⑭ does not work on the balanced output (XLR Output Connectors ⑮) but on the unbalanced output (Output Jacks ⑯).

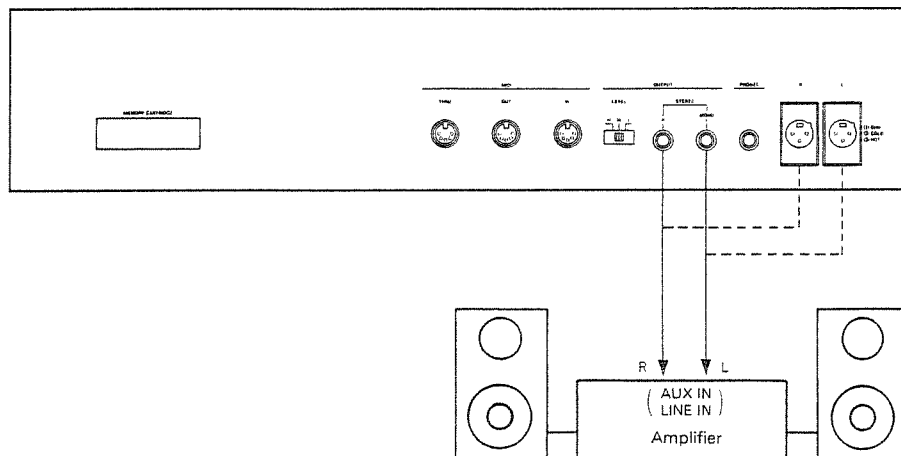

3 OPERATION

The RD-1000 has mainly two modes, Function and Edit. In the Function mode, you can call a voice or a parameter, and in the Edit mode, the value of the parameter you have called can be edited. To change the modes, use the Function Button **Ⓒ** and Edit Button **Ⓓ**. The corresponding indicator lights up to tell you which mode is currently selected.

1. Basic Operation

After making all the necessary connections, turn the amplifier's volume to zero, then switch on the Power Switch **Ⓔ** on the Pedal Unit.

The Display **Ⓕ** will react as shown below.

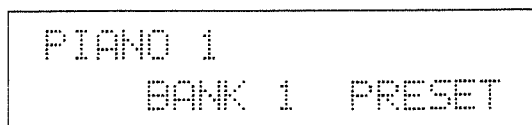

If you find it difficult to see the Display, adjust the contrast with the Contrast Knob **Ⓖ**.

a. Voice Selection

The RD-1000 retains 64 tone colors: 8 basic voices and other 7 variations for each voice. To call a voice you like, use the Voice Selector Buttons 1 to 8 and the Bank Button.

- VOICE 1 PIANO 1
- VOICE 2 PIANO 2
- VOICE 3 PIANO 3
- VOICE 4 HARPSICHORD
- VOICE 5 CLAVI
- VOICE 6 VIBRAPHONE
- VOICE 7 E. PIANO 1
- VOICE 8 E. PIANO 2

8 different sounds are preprogrammed in the voices 1 to 8 of Bank 1. Each voice has another 7 variations (Bank 2 to 8). That is, there are altogether 8 variations for one voice.

To select the basic voice 1 to 8 in the Bank 1, push the relevant Voice Selector **Ⓗ**.

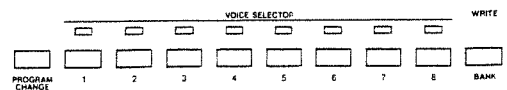

Push the appropriate Voice Selector

To select other variation of that voice, hold the Bank Button **Ⓗ** down and push the corresponding Voice Selector Button. Here, the Voice Selector Buttons 1 to 8 correspond to the bank numbers.

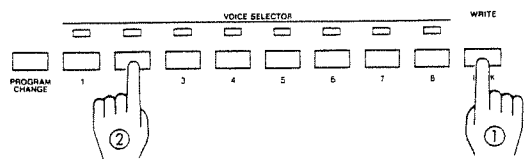

- ① While holding the Bank Button
- ② Push the appropriate Voice Selector (1 to 8)

e.g.) **Selecting the sound of Voice 3 (Piano 3) in Bank 7**

- 1) **Push the Voice Selector Button 3.**

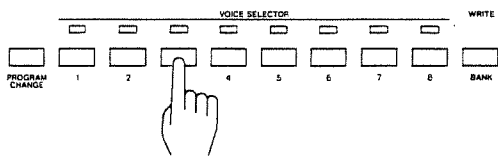

Push the Voice Selector 3

The Display responds with:

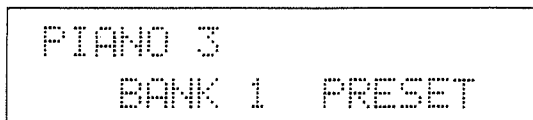

- 2) **While holding the Bank Button down, press the Voice Selector Button 7. This procedure selects the Bank 7.**

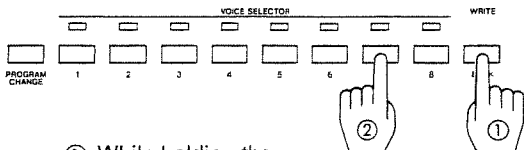

- 1) While holding the Bank Button
- 2) Push the Voice Selector 7.

The Piano 3 of Bank 7 is selected.

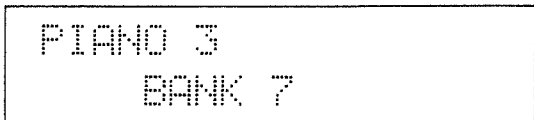

1) Voice Preserve Function

The RD-1000 features the Voice Preserve function, that is, while you are playing the keyboard using a certain voice, you can assign the next voice to be used, without changing the sounds until you release all the keys.

Even if you select a new voice while playing the keyboard or Damper ON, the sound does not change. (The Voice Indicator of the corresponding voice.) To actually change the sounds, release all the keys on the keyboard and turn the Damper off. (Now, the Voice Indicator of the new voice glows steadily.)

e.g.) **Changing from Piano 1 to Clavi**

- 1) **While playing the keyboard, push the Voice Selector 5 (Bank-1/Clavi).**

The indicator of the Voice 5 (Clavi) flashes. The Piano 1 still remains.

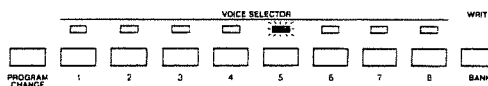

The indicator of the Voice Selector 5 flashes.

- 2) **When you wish to change to Clavi, release all the keys and turn the Damper off.**

The indicator of Voice 5 stops flashing and glows steadily.

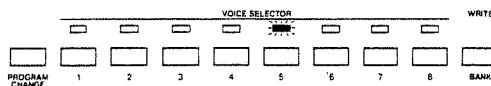

The flashing indicator now glows steadily

The Voice Preserve function works on the sounds which are selected by the MIDI program change messages sent from the external device.

b. Tuning

Procedure

- ① Push the Tune Button .

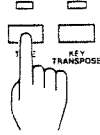

Push the Tune Button

The Tune Indicator lights up showing that the RD-1000 is in the Tune mode.

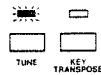

The Tune Indicator lights up

While in the Tuning mode, the Chorus and Tremolo effects are turned off.

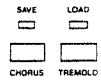

Chorus and Tremolo are turned off.

- ② Using the α Dial, tune the RD-1000.

The RD-1000's Tuning mode allows the tuning in the range of A=438 to 446Hz in 0.1Hz steps. The value is shown in the Display.

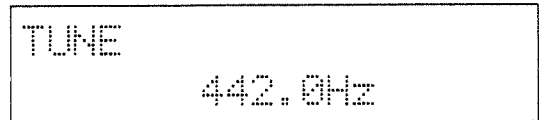

- ③ When the tuning is completed, push the Tune Button.

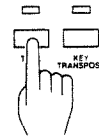

Push the Tune Button

Now the Tuning mode is cancelled and the Chorus and Tremolo effects set before entering the Tuning mode are returned.

c. Damper Pedal/Soft Pedal

The Damper and the Soft Pedals of the Pedal Unit work just like those of an acoustic piano.

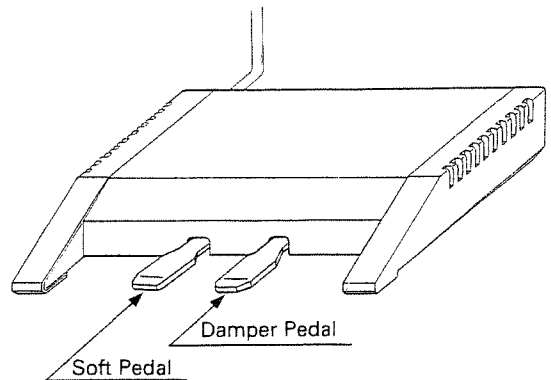

d. Chorus/Tremolo

The RD-1000 contains the Chorus and Tremolo effects.

1) Chorus

Push the Chorus Button **14**, and the indicator lights up showing the Chorus effect is turned on.



The Chorus Indicator lights up.

To turn the Chorus effect off, simply push the Chorus Button again. The indicator goes out.

2) Tremolo

Push the Tremolo Button **15**, and the indicator lights up showing the Tremolo effect is turned on.



The Tremolo Indicator lights up.

To turn the Tremolo effect off, simply push the Tremolo Button again. The indicator goes out.

e. Key transpose

By using the appropriate key, you can shift the pitch of the entire keyboard.

Push the Key Transpose Button **10**, and the Display will respond with as shown below.

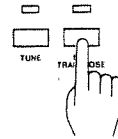

Push the Key Transpose Button

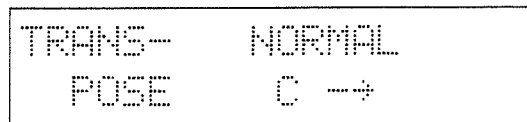

While holding the Transpose Button down, press the key to which you wish to transpose. If you make a mistake, repeat the same procedure.

When the key other than C is set, the indicator of the Key Transpose will glow.

The Key transpose operation cannot be done if any key is pressed on the keyboard. Be sure no key is pushed when you are transposing the key. While you are taking the transposing operation, the RD-1000 cannot be played.

e.g.) Transposing to F#

- ① With all keys are released, press the Key Transpose Button. And without releasing it, push any F# key on the keyboard.

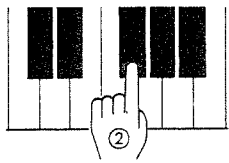
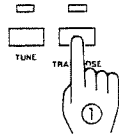

- ① While holding the Key Transpose Button down.
- ② Press any F# key.

The Display shows:

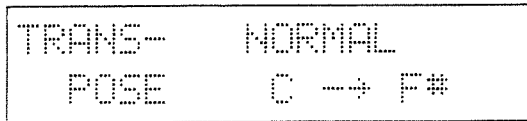

- ② Release the Key Transpose Button and the key you are pressing.

The indicator of the Key Transpose lights up.



The indicator of the Key Transpose lights up.

Now, the transposition is completed.

e.g.) Transposing from F# to D

- ① Push the Key Transpose Button.

The Display shows as follows. This is the key currently set.

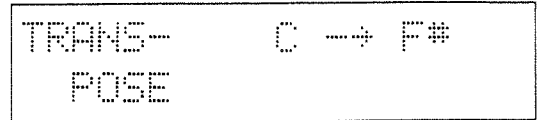

Keep pressing the Key Transpose Button, and the Display responds with:

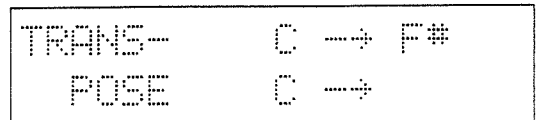

- ② Press any D key on the keyboard while holding the Key Transpose Button down.

The Display shows:

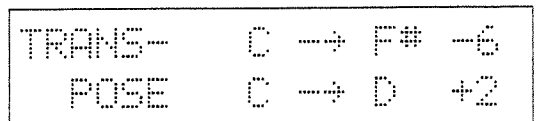

The key you are pressing (D) is shown in the lower line of the Display. The number shown at the right of the Display represents how many semi-tones are transposed from "C".

- ③ Release the key and the Key Transpose Button.

Now, transposed F# to D.

e.g.) Returning from D to C

- ① Press any C key on the keyboard while holding the Key Transpose Button down.

The Display responds with:

```
TRANS-   C → D   +2  
POSE     C → NORMAL
```

- ② Release the key and the Key Transpose Button.

The Display responds with;

```
TRANS-   C → D   +2  
POSE     NORMAL  0
```

When returned to normal, the indicator of the Key Transpose Button does not light.

2. Sound Editing

All the 64 tone colors in memory can be edited with the α Dial.

a. About Bank

When you select the sound of the Bank 1 and it is not edited at all, "PRESET" will be shown at the lower right of the Display.

```
PIANO 1  
      BANK 1  PRESET
```

If the same sound is even slightly edited, "PRESET" goes away and does not appear unless the unit is turned off and on again.

The sounds in Bank 1 (=basic voices) are non-volatile, that is, it can be edited but the edited sound is erased when the unit is turned off. On the other hand, any of the voices in Banks 2 to 8 can be edited and retained by battery backup even after the unit is turned off.

b. About Functions

The parameters in the RD-1000 are divided into two sections; Voice and System.

1) Voice Functions

These are the functions that are related to the parameters for the sound itself.

2) System Functions

These are the functions for setting the Touch Response and the MIDI messages.

c. Calling a Parameter

- ① Make sure that the indicator of the Function Button is lighted.

If it is not lighted, push the Function Button.

The Display shows the name and the value of the parameter previously selected.



Make sure that the Function Indicator is lighted.

- ② Call the parameter you wish to edit by rotating the α Dial.

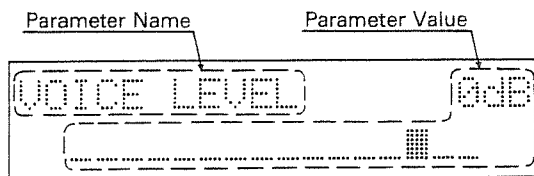

If you wish to return the Display to Bank/Voice indication, simply push any Voice Selector Button or the Bank Button ⑩.

d. Edit

- ① Call the parameter you wish to edit as explained in "Calling a Parameter".

- ② Push the Edit Button ⑦.

The Edit Indicator lights up showing that now the RD-1000 is in the Edit mode.

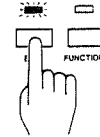

Push the Edit Switch, and the Edit Indicator lights up.

- ③ Change the value of the parameter by rotating the α Dial.

e. Parameters

1) Voice Level

16 different voice levels are available for each tone color from -13 to +2dB in 1dB step.

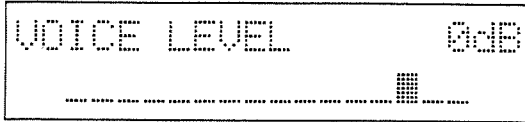

The level based on (0 dB) is the that of the voices in Bank 1.

2) Equalizer Section

This is the programmable equalizer. Each sound can individually have its own equalizing.

■ Bass Equalizer

This is the shelving type equalizer with 100Hz cutoff frequency.

● Bass Level

15 different levels are available for boosting or cutting the cutoff frequency from -10.5 to +10.5dB in 1.5dB steps.

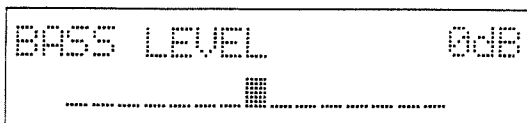

■ Middle Equalizer

This is a parametric equalizer that allows to change the cutoff frequency from 400Hz to 4kHz.

● Frequency

The center frequency of each band is 400Hz, 560Hz, 770Hz, 1kHz, 1.4kHz, 2kHz, 2.8kHz or 4kHz.

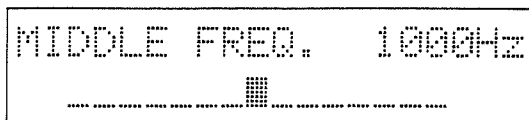

● Middle Level

The frequency selected with the "Frequency" can be boosted or cut in 1.5dB steps from -10.5 to +10.5dB.



● Band Width (Q)

This determines the intensity of the equalizing. 1 to 8 are available, and at 8, the bigger number makes the slope of the boosting or cuttin steeper.

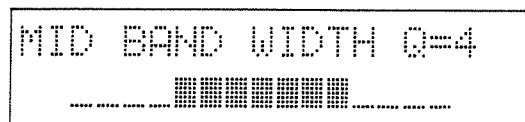

■ Treble Equalizer

This is the shelving type equalizer with 10kHz cutoff frequency.

● Treble Level

15 different levels are available for boosting or cutting the cutoff frequency from -10.5dB to +10.5dB in 1.5 steps.

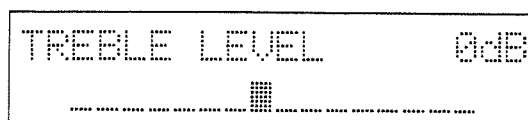

3) Chorus

The On/Off setting, rate and depth of the Chorus effect can be set.

■ Rate

15 levels are available for the rate of the Chorus effect.

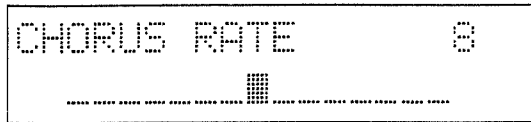

■ Depth

15 levels are available for the depth of the Chorus effect.



4) Tremolo

The On/Off setting, Rate and Depth of the Tremolo effect can be set.

■ Rate

15 levels are available for the rate of the Tremolo effect.



■ Depth

15 levels are available for the depth of the tremolo effect.



f. Memory Cartridge

Using the Memory Cartridge (M-16C), the edited data of all the banks (1 to 8) on the RD-1000 can be saved. The saved data can be loaded back to the RD-1000 at any time.

1) Saving

- ① Make sure the Protect Switch on the Memory Cartridge is set to the ON position.
- ② Securely connect the Memory Cartridge to the Memory Cartridge Holder ⑩ on the front panel with the Protect switch side facing upward.

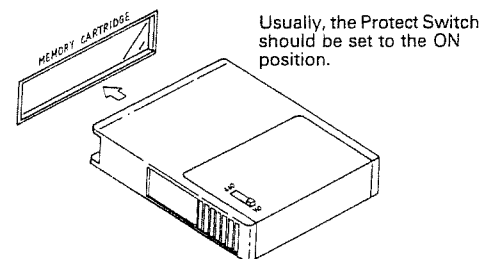

- ③ Set the Protect Switch on the Memory Cartridge to the OFF position.

Now, the Memory Cartridge is ready to accept the data from the RD-1000's memory.

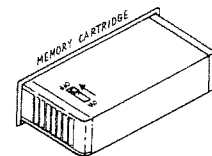

Set the Protect Switch on the Memory Cartridge to the OFF position.

- ④ While holding the Save Button ⑭ down, push the Write Button ⑮.

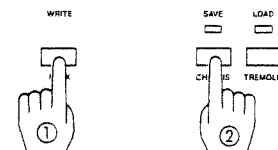

- ① While holding the Write Button down.
- ② Push the Save Button.

When the saving is completed, the Display responds with:

SAVE COMPLETE

- ⑤ Return the Memory Protect Switch on the Memory Cartridge to the ON position.

If the Memory Protect Switch has not been set to the OFF position, the Display will react as shown below and the saving cannot be done.

MEMORY PROTECTED

If this happens, set the Protect Switch on the Memory Cartridge to the OFF position, then repeat the saving procedure.

2) Loading

- ① Securely connect the Memory Cartridge to the Memory Cartridge Holder ⑩ on the front panel with the Protect Switch side facing upward.

* The loading procedure should be done with the Protect Switch on the Memory Cartridge set to the ON position.

- ② While holding the Load Button ⑬ down, push the Write Button.

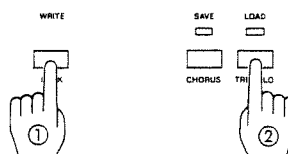

- ① While holding the Write Button down.
- ② Push the Load Button.

When the loading is completed, the Display responds with:

LOAD COMPLETE

If you want the Preset voices at this stage, turn the RD-1000 off, then on. The Preset sounds will be called in the Bank 1.

If you try to save or load without the Memory Cartridge connected, the Display will react as shown below.

INSERT CARTRIDGE

NOTE

When connecting or disconnecting the Memory Cartridge, be sure that its Protect Switch is set to the ON position. If not, the data saved on the memory Cartridge may be erased.

g. Touch Response

Touch Response Curve is the curve that shows how the key touch velocity affects the tone color and the volume of the sound.

Four different Touch Response Curves are optional on the RD-1000.

How to select a Touch Response Curve

① Call "Touch Response" as shown in "Calling a Parameter".

② Push the Edit Button.

The Display responds with:

③ Using the α Dial, select the Touch Response Curve you like.

```
TOUCH RESPONSE
TYPE(A,B,C,D,)
```

RD-1000 TOUCH RESPONSE

"B" is set at the manufacturer.

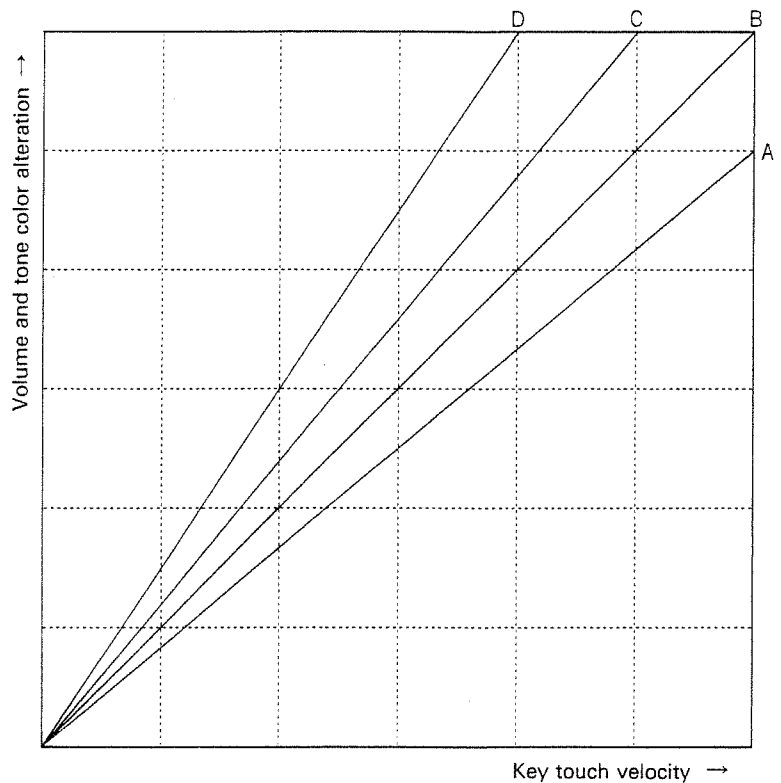

The Touch Response Curve is the function that is transmitted when the RD-1000 is used as a keyboard controller, but is not sent when used as a sound module.

4 MIDI

1. MIDI Connectors

The RD-1000 has MIDI IN, MIDI OUT and MIDI THRU Connectors on the rear panel.

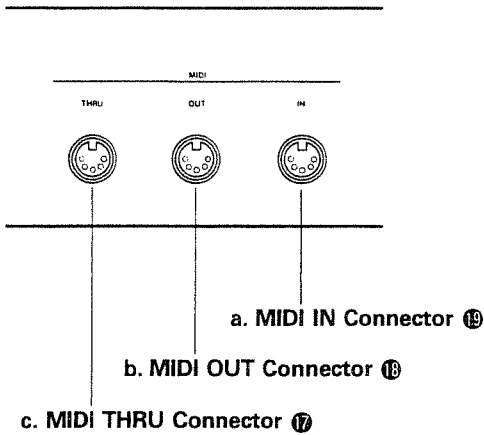

a. MIDI IN Connector 19

When using the RD-1000 as a MIDI sound module controlled by the external MIDI device, connect the MIDI IN Connector to the MIDI OUT or MIDI THRU on the external device.

b. MIDI OUT Connector 18

When using the RD-1000 as a keyboard controller that drives the external device, connect the MIDI OUT Connector to the MIDI IN on the external device.

c. MIDI THRU Connector 17

Through this, the exact copy of the signal fed into the MIDI IN is sent out.

2. RD-1000 as a MIDI Keyboard Controller

a. Setting Transmit Channel

To use the RD-1000 as a MIDI keyboard controller, it is necessary to set the transmit channel to the same number as the receive channel of the external device.

- 1 Call "Transmit Channel" as shown in "Calling a Parameter".

The Display responds with:

```
MIDI Transmit ch 1
```

- 2 Push the Edit Button, and set the Transmit channel by rotating the α Dial.

Regarding the messages to be sent, refer to "MIDI Functions".

b. Transmitting Program Change

The RD-1000 can transmit the program numbers from 1 to 128.

The table below shows how the Group/Bank/Voice numbers on the RD-1000 correspond to the Program numbers.

Group	Bank \ Voice	1	2	3	4	5	6	7	8
	A	1	1	2	3	4	5	6	7
2		9	10	11	12	13	14	15	16
3		17	18	19	20	21	22	23	24
4		25	26	27	28	29	30	31	32
5		33	34	35	36	37	38	39	40
6		41	42	43	44	45	46	47	48
7		49	50	51	52	53	54	55	56
8		57	58	59	60	61	62	63	64
B	1	65	66	67	68	69	70	71	72
	2	73	74	75	76	77	78	79	80
	3	81	82	83	84	85	86	87	88
	4	89	90	91	92	93	94	95	96
	5	97	98	99	100	101	102	103	104
	6	105	106	107	108	109	110	111	112
	7	113	114	115	116	117	118	119	120
	8	121	122	123	124	125	126	127	128

- 1 Call "External Program Change Bank (EXT. PC BANK)" as shown in "Calling a Parameter".

The Display responds with:

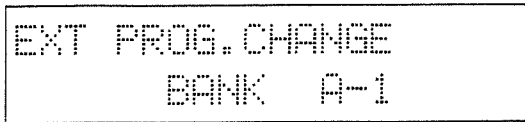

- 2 Push the Edit Button, and select the Group and the Bank using the α Dial.
- 3 While holding the Program Change Button down, push the appropriate Voice Selector (1 to 8) selecting the program number you want.

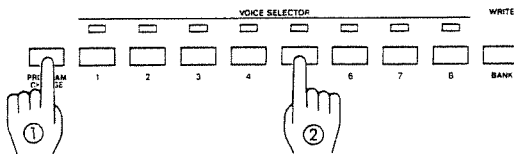

- 1 While holding the Program Change Button down.
- 2 Push the appropriate Voice Selector.

The Voice Selectors 1 to 8 correspond to the Numbers 1 to 8 in each Bank.

e.g.) Transmitting the program change 123

- 1 Call the External Program Change Bank as shown in "Calling a Parameter".
- 2 Push the Edit Button, and set B-8 by rotating the α Dial.

The Display responds with:

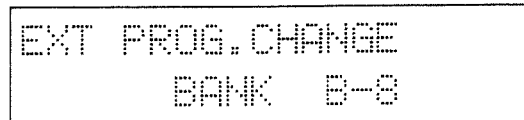

- 3 While holding the Program Change Button down, push the Voice Selector 3.

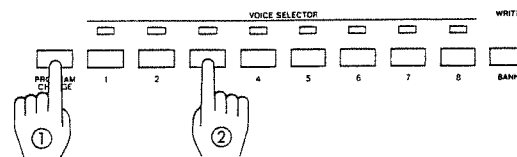

- 1 While holding the Program Change button down.
- 2 Push the Voice Selector 3.

The Display responds with:

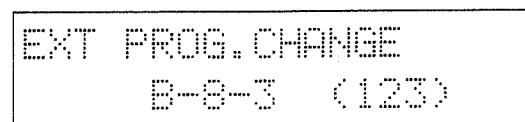

The program number is shown in ().

Now, the program change 123 is transmitted.

c. Transmitting Control Change

Some control change messages can be assigned to the External Volume and Expression Pedal. Six different combinations of the assignments are programmed in the RD-1000 as shown below.

E.VOL → VOLUME	7
E.PED → EXP	11

E.VOL → VOLUME	7
E.PED → FOOT CTRL	4

E.VOL → EXP	11
E.PED → FOOT CTRL	4

E.VOL → EXP	11
E.PED → VOLUME	7

E.VOL → FOOT CTRL	4
E.PED → VOLUME	7

E.VOL → FOOT CTRL	4
E.PED → EXP	11

The number shown at the right end of the Display is the control change number.

- ① While holding the Bank Button down, press the Program Change Button.

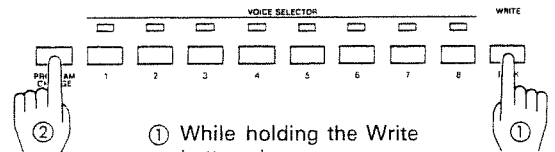

- ① While holding the Write button down.
- ② Push the Program Change Button

The Control Change messages assigned to the External Volume and the Expression Pedal are shown in the Display.

E.VOL → VOLUME	7
E.PED → EXP	11

- ② With still holding the Bank Button down, push the Program Change Button.

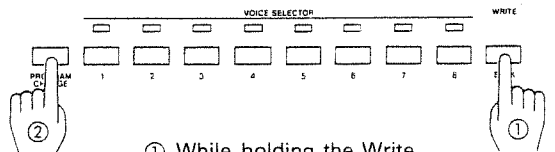

- ① While holding the Write button down.
- ② Push the Program Change Button

Now, the Display shows the different combinations of Control Change assignment.

Likewise, keep pushing the Program Change Button while holding the Bank Button down until the control change assignment you want is shown in the Display.

3. RD-1000 as a Sound Module

To use the RD-1000 as a sound module, it is critical to set the MIDI channel number of the RD-1000 to the same one as the transmit channel of the external device that controls the RD-1000.

a. Setting Receive Channel

- ① Call "Receive Channel" of the System Functions, as shown in "Calling a Parameter".

The Display responds with:

```
MIDI Receive ch 1
                OMNI-ON
```

- ② Push the Edit Button, and set the number you want by rotating the α Dial.

b. Setting Program Change

The RD-1000 receives the program change numbers 1 to 64 but ignores 65 to 128.

Regarding the Program Change messages, see "4. MIDI Functions".

4. MIDI Functions

The RD-1000 can select any of the following three modes that decide how the messages are received and transmitted.

- (I) Note On/Off, Program Change and Control Change are transmitted and received.
- (II) Note On/Off, Program Change and Control Change are transmitted and received. The moment a new voice is selected on the RD-1000, the corresponding program change number is transmitted. The chorus or tremolo On/Off is transmitted as a control change message. This setting may be used when recording the data into a MIDI keyboard recorder and play it back.
- (III) Note On/Off, Program Change and Control Change are transmitted. Program Change, Chorus On/Off and Tremolo On/Off cannot be received.

How to select the above communication mode

- Mode (I):** Turning the RD-1000 on will automatically select this mode.
- Mode (II):** Turn the RD-1000 on while holding the Program Change Button down.
- Mode (III):** Turn the RD-1000 on while holding the Voice Selector 1.

<<Sound Samples>>

● VOICE 1 : PIANO 1

BANK NO.	VOICE	EQUALIZER					EFFECT						MEMO
		BASS	MIDDLE		TREBLE	CHORUS			TREMOLO				
		LEVEL	FREQ	LEVEL	Q	LEVEL	RATE	DEPTH	ON/OFF	RATE	DEPTH	ON/OFF	
1	0	0	1000	0	1	0	3	10	OFF	10	3	OFF	
2	0	0	1000	0	1	0	1	2	ON	8	8	OFF	
3	0	0	1000	0	1	0	1	8	ON	2	3	ON	
4	0	-1.5	2000	+4.5	3	7.5	6	5	OFF	8	8	OFF	
5	2	0	770	-6.0	1	-10.5	4	8	OFF	8	8	OFF	
6	-4	0	770	+10.5	1	0	4	8	OFF	8	8	OFF	
7	0	0	1000	-7.5	4	+4.5	3	3	OFF	4	4	OFF	
8	0	0	2800	+3.0	4	+3.0	1	1	ON	8	8	OFF	

● VOICE 2 : PIANO 2

BANK NO.	VOICE	EQUALIZER					EFFECT						MEMO
		BASS	MIDDLE		TREBLE	CHORUS			TREMOLO				
		LEVEL	FREQ	LEVEL	Q	LEVEL	RATE	DEPTH	ON/OFF	RATE	DEPTH	ON/OFF	
1	0	0	1000	0	1	0	3	10	OFF	10	3	OFF	
2	0	0	1000	0	1	0	1	2	ON	8	8	OFF	
3	0	0	1000	0	1	0	1	8	ON	2	3	ON	
4	0	-1.5	2000	+4.5	3	+7.5	6	5	OFF	8	8	OFF	
5	2	0	560	-3.0	1	-10.5	4	8	OFF	8	8	OFF	
6	2	0	1000	+9.0	1	0	4	8	OFF	8	8	OFF	
7	0	+3.0	1000	-10.5	5	+6.0	3	3	OFF	4	4	OFF	
8	0	0	400	-1.5	1	+1.5	1	1	ON	8	8	OFF	

● VOICE 3 : PIANO 3

BANK NO.	VOICE	EQUALIZER					EFFECT						MEMO
		BASS	MIDDLE		TREBLE	CHORUS			TREMOLO				
		LEVEL	FREQ	LEVEL	Q	LEVEL	RATE	DEPTH	ON/OFF	RATE	DEPTH	ON/OFF	
1	0	0	1000	0	1	0	3	10	OFF	10	3	OFF	
2	0	0	1000	0	1	0	1	2	ON	8	8	OFF	
3	0	0	1000	0	1	0	1	1	ON	10	5	ON	
4	-3	+1.5	2800	+10.5	1	+10.5	6	5	OFF	8	8	OFF	
5	0	0	1000	0	1	-10.5	4	8	OFF	8	8	OFF	
6	0	0	1400	+7.5	1	0	8	8	OFF	8	8	OFF	
7	2	0	770	-7.5	3	+9.0	3	3	OFF	4	4	OFF	
8	0	0	2800	+4.5	5	0	8	8	OFF	8	8	OFF	

● VOICE 4 : HARPSICHORD

BANK NO.	VOICE	EQUALIZER					EFFECT						MEMO
		BASS	MIDDLE		TREBLE	CHORUS			TREMOLO				
		LEVEL	FREQ	LEVEL	Q	LEVEL	RATE	DEPTH	ON/OFF	RATE	DEPTH	ON/OFF	
1	0	0	1000	0	1	0	3	10	OFF	10	3	OFF	
2	0	0	1000	0	1	0	1	3	ON	8	8	OFF	
3	0	0	1000	0	1	0	1	1	ON	10	3	ON	
4	2	-3.0	4000	+3.0	1	+6.0	5	6	OFF	8	8	OFF	
5	2	+1.5	4000	-6.0	1	-10.5	4	12	OFF	8	8	OFF	
6	0	0	1400	+9.0	1	0	8	8	OFF	8	8	OFF	
7	2	+3.0	1400	-10.5	4	0	1	15	OFF	8	2	OFF	
8	0	-6.0	560	+4.5	6	0	8	8	OFF	8	8	OFF	

● VOICE 5 : CLAVI

BANK NO.	VOICE	EQUALIZER					EFFECT						MEMO
		BASS	MIDDLE		TREBLE	CHORUS			TREMOLO				
		LEVEL	FREQ	LEVEL	Q	LEVEL	RATE	DEPTH	ON/OFF	RATE	DEPTH	ON/OFF	
1	0	0	1000	0	1	0	3	10	OFF	10	3	OFF	
2	0	0	1000	0	1	0	3	3	ON	8	8	OFF	
3	0	0	1000	0	1	0	1	1	ON	10	5	ON	
4	0	-6.0	4000	+6.0	1	+10.5	8	8	OFF	8	8	OFF	
5	2	0	2800	-6.0	1	-10.5	4	4	OFF	8	8	OFF	
6	0	0	770	+10.5	1	0	8	8	OFF	8	8	OFF	
7	2	+4.5	1000	-6.0	1	+4.5	1	13	OFF	8	4	OFF	
8	0	0	2000	+10.5	3	+6.0	1	8	ON	8	8	OFF	

● VOICE 6 : VIBRAPHONE

BANK NO.	VOICE	EQUALIZER					EFFECT						MEMO
		BASS	MIDDLE		TREBLE	CHORUS			TREMOLO				
		LEVEL	FREQ	LEVEL	Q	LEVEL	RATE	DEPTH	ON/OFF	RATE	DEPTH	ON/OFF	
1	0	0	1000	0	1	0	3	10	OFF	9	4	OFF	
2	0	0	1000	0	1	0	3	4	ON	8	8	OFF	
3	0	0	1000	0	1	0	8	8	ON	8	8	ON	
4	-3	0	2000	+7.5	1	+6.0	8	8	OFF	8	8	OFF	
5	2	0	2800	-6.0	1	-10.5	8	8	OFF	8	8	OFF	
6	0	0	560	+10.5	1	0	8	8	OFF	8	8	OFF	
7	1	+3.0	2000	-10.5	3	+6.0	8	8	OFF	8	8	OFF	
8	0	0	1000	0	1	0	7	8	ON	8	4	ON	

● VOICE 7 : E. PIANO 1

BANK NO.	VOICE	EQUALIZER					EFFECT						MEMO
		BASS	MIDDLE		TREBLE	CHORUS			TREMOLO				
		LEVEL	FREQ	LEVEL	Q	LEVEL	RATE	DEPTH	ON/OFF	RATE	DEPTH	ON/OFF	
1	0	0	1000	0	1	0	3	10	OFF	2	14	OFF	
2	0	0	1000	0	1	0	3	4	ON	8	8	OFF	
3	0	0	1000	0	1	0	8	4	ON	8	4	ON	
4	-2	+3.0	2800	+10.5	1	+7.5	8	8	OFF	8	8	OFF	
5	+2	-7.5	4000	-10.5	1	-10.5	4	12	OFF	4	12	OFF	
6	0	0	770	+10.5	1	0	8	8	OFF	3	8	OFF	
7	+2	-3.0	1000	-10.5	4	+6.0	4	12	OFF	6	4	OFF	
8	0	-4.5	2800	+4.5	4	+6.0	2	14	ON	2	14	ON	

● VOICE 8 : E. PIANO 2

BANK NO.	VOICE	EQUALIZER					EFFECT						MEMO
		BASS	MIDDLE		TREBLE	CHORUS			TREMOLO				
		LEVEL	FREQ	LEVEL	Q	LEVEL	RATE	DEPTH	ON/OFF	RATE	DEPTH	ON/OFF	
1	0	0	1000	0	1	0	3	10	OFF	2	14	OFF	
2	0	0	1000	0	1	0	3	4	ON	8	8	OFF	
3	0	0	1000	0	1	0	8	4	ON	8	4	ON	
4	0	+4.5	2800	+10.5	1	+7.5	8	8	OFF	8	8	OFF	
5	2	-6.0	4000	-10.5	1	-10.5	4	12	OFF	4	12	OFF	
6	0	0	400	+10.5	1	0	8	8	OFF	3	8	OFF	
7	1	0	2000	-7.5	3	0	4	12	OFF	6	4	OFF	
8	0	-3.0	1000	0	1	0	2	14	ON	2	14	ON	

<<Data Sheet>>

BANK NO.	VOICE	EQUALIZER					EFFECT						MEMO	
		BASS	MIDDLE		TREBLE	CHORUS			TREMOLO					
		LEVEL	LEVEL	FREQ	LEVEL	Q	LEVEL	RATE	DEPTH	ON/OFF	RATE	DEPTH		ON/OFF
1														
2														
3														
4														
5														
6														
7														
8														

BANK NO.	VOICE	EQUALIZER					EFFECT						MEMO	
		BASS	MIDDLE		TREBLE	CHORUS			TREMOLO					
		LEVEL	LEVEL	FREQ	LEVEL	Q	LEVEL	RATE	DEPTH	ON/OFF	RATE	DEPTH		ON/OFF
1														
2														
3														
4														
5														
6														
7														
8														

BANK NO.	VOICE	EQUALIZER					EFFECT						MEMO	
		BASS	MIDDLE		TREBLE	CHORUS			TREMOLO					
		LEVEL	LEVEL	FREQ	LEVEL	Q	LEVEL	RATE	DEPTH	ON/OFF	RATE	DEPTH		ON/OFF
1														
2														
3														
4														
5														
6														
7														
8														

BANK NO.	VOICE	EQUALIZER					EFFECT						MEMO	
		BASS	MIDDLE		TREBLE	CHORUS			TREMOLO					
		LEVEL	LEVEL	FREQ	LEVEL	Q	LEVEL	RATE	DEPTH	ON/OFF	RATE	DEPTH		ON/OFF
1														
2														
3														
4														
5														
6														
7														
8														

BANK NO.	VOICE	EQUALIZER					EFFECT						MEMO	
		BASS	MIDDLE		TREBLE	CHORUS			TREMOLO					
		LEVEL	LEVEL	FREQ	LEVEL	Q	LEVEL	RATE	DEPTH	ON/OFF	RATE	DEPTH		ON/OFF
1														
2														
3														
4														
5														
6														
7														
8														

BANK NO.	VOICE	EQUALIZER					EFFECT						MEMO	
		BASS	MIDDLE		TREBLE	CHORUS			TREMOLO					
		LEVEL	LEVEL	FREQ	LEVEL	Q	LEVEL	RATE	DEPTH	ON/OFF	RATE	DEPTH		ON/OFF
1														
2														
3														
4														
5														
6														
7														
8														

BANK NO.	VOICE	EQUALIZER					EFFECT						MEMO	
		BASS	MIDDLE		TREBLE	CHORUS			TREMOLO					
		LEVEL	LEVEL	FREQ	LEVEL	Q	LEVEL	RATE	DEPTH	ON/OFF	RATE	DEPTH		ON/OFF
1														
2														
3														
4														
5														
6														
7														
8														

BANK NO.	VOICE	EQUALIZER					EFFECT						MEMO	
		BASS	MIDDLE		TREBLE	CHORUS			TREMOLO					
		LEVEL	LEVEL	FREQ	LEVEL	Q	LEVEL	RATE	DEPTH	ON/OFF	RATE	DEPTH		ON/OFF
1														
2														
3														
4														
5														
6														
7														
8														

BANK NO.	VOICE	EQUALIZER					EFFECT						MEMO	
		BASS	MIDDLE		TREBLE	CHORUS			TREMOLO					
		LEVEL	LEVEL	FREQ	LEVEL	Q	LEVEL	RATE	DEPTH	ON/OFF	RATE	DEPTH		ON/OFF
1														
2														
3														
4														
5														
6														
7														
8														

7 SPECIFICATIONS

RD-1000: 16 polyphonic SA System Digital Piano

Keyboard: 88 Keys

Memory: Preset 8 Voices (in Bank 1)

Users Perprogrammable 56 Voices (in Bank 2 to 8)

[Main Unit]

• Front Panel

Buttons

Edit
Function
Tune
Key Transpose
Program Change
Voice Selector (1 to 8)
Bank/Write
Chorus/Save
Tremolo/Load

Controllers

External Volume
Volume
 α Dial
Contrast

Display

20 Character 2 line, Backlighted LCD
(liquid crystal display)

Indicators

Edit
Function
Tune
Key Transpose
Voice Selector
Chorus
Tremolo

Parameters

Transmit Channel
Receive Channel
External Program Change
Touch Response
Voice Level
Bass Level
Middle Frequency
Level
Band Width
Treble Level
Chorus: Rate
Depth
Tremolo: Rate
Depth

• Rear Panel

Output Jacks (L/R)
XLR Output Connectors (L/R: 600 Ω)
Headphones Jack (Stereo)
MIDI Connectors (IN/OUT/THRU)
Memory Cartridge Holder
Pedal Unit Cable Connector

[Pedal Unit]

Controllers

Damper Pedal
Soft Pedal

Rear Panel

Power Switch
AC Inlet
Expression Jack

Dimensions

Main Unit: 1352(W) \times 557(D) \times 154(H) mm
53 $\frac{1}{4}$ "(W) \times 21 $\frac{15}{16}$ "(D) \times 6 $\frac{1}{16}$ "(H)

Pedal Unit: 600(W) \times 333(D) \times 98(H) mm
23 $\frac{5}{8}$ "(W) \times 13 $\frac{1}{8}$ "(D) \times 3 $\frac{7}{8}$ "(H)

Weight

Main Unit : 43.5kg/95 lb 14 oz

Pedal Unit : 8.5kg/18 lb 12 oz

Consumption: 25W

Accessories: Connection Cord (LP-25) \times 2
Powr Cord \times 1
Owner's Manual
Guide Book for "MIDI".

OPTIONS

Stand: KS-11, KS-1100
Stereo Headphones: RH-10
Memory Cartridge: M-16C
Expression Pedal: EV-5
MIDI Cabel: MSC-07, 15, 25, 50, 100

MODEL RD-1000 MIDI Implementation Chart

Date : Dec.20 1985
Version : 1.0

Function.....		Transmitted	Recognized	Remarks
Basic Channel	Default Changed	1 - 16 1 - 16	1 - 16 1 - 16	memorized
Mode	Default Messages Altered	3 POLY, OMNI OFF *****	1,3 POLY, OMNI ON/OFF MONO(M≠1)→1, (M=1)→3	memorized
Note Number	True voice	15 - 113 *****	0 - 127 15 - 113	
Velocity	Note ON Note OFF	○ × (9n v=0)	○ ×	v=1-127
After Touch	Key's Ch's	× ×	× ×	
Pitch Bender		×	×	
Control Change	4 7 11 64 67 92 93	○ ○ ○ ○ ○ ○ ○	○ ○ ○ ○ ○ ○ ○	Foot control Volume Expression Damper pedal Soft pedal Tremolo } * Chorus } * * can be ignored by power-up setting
Prog Change	True #	○ (0-127) *****	○ (0-63) 0 - 63	can be ignored by power-up setting
System Exclusive		×	×	
System Common	Song Pos Song Sel Tune	× × ×	× × ×	
System Real Time	Clock Commands	× ×	× ×	
Aux Messages	Local ON/OFF All Notes OFF Active Sense Reset	× ○ (123) ○ ×	○ ○ (123 - 127) ○ ×	memorized
Notes	When power up, OMNI OFF, POLY ON are sent in memorized transmitter's channel.			

Mode 1 : OMNI ON, POLY
Mode 3 : OMNI OFF, POLY

Mode 2 : OMNI ON, MONO
Mode 4 : OMNI OFF MONO

○ : Yes
× : No

MODEL RD-1000 MIDI Implementation

Date : Dec.20 1985
Version : 1.0

1. TRANSMITTED DATA

Status	Second	Third	Description
1001 nnnn	0kkk kkkk	0000 0000	Note OFF
1001 nnnn	0kkk kkkk	0vvv vvvv	Note ON kkkkkkk = 15 - 113 vvvvvvv = 1 - 127
1011 nnnn	0000 0100	0vvv vvvv	Foot control vvvvvvv = 0 - 127
1011 nnnn	0000 0111	0vvv vvvv	Volume vvvvvvv = 0 - 127
1011 nnnn	0000 1011	0vvv vvvv	Expression vvvvvvv = 0 - 127
1011 nnnn	0100 0000	0111 1111	Damper ON
1011 nnnn	0100 0000	0000 0000	Damper OFF
1011 nnnn	0100 0011	0111 1111	Soft ON
1011 nnnn	0100 0011	0000 0000	Soft OFF
1011 nnnn	0101 1100	0111 1111	Tremolo ON
1011 nnnn	0101 1100	0000 0000	Tremolo OFF
1011 nnnn	0101 1101	0111 1111	Chorus ON
1011 nnnn	0101 1101	0000 0000	Chorus OFF
1100 nnnn	0ppp pppp		Program Change ppppppp = 0 - 127
1011 nnnn	0111 1011	0000 0000	ALL NOTES OFF
1011 nnnn	0111 1100	0000 0000	OMNI OFF
1011 nnnn	0111 1111	0000 0000	POLY ON
1111 1110			Active Sensing

Notes :

nnnn : MIDI Channel number (0000 - 1111), ch-1 = 0000
The transmitter's Basic Channel can be changed by the panel operation, and memorized.

- *1 The range may be changed by the transposition. Refer to Section 3.
- *2 Refer to Section 4.
- *3 Refer to Section 5.
- *4 Refer to Section 6.
- *5 When all keys on the keyboard are released, the ALL NOTES OFF (\$Bn, \$7B, 0) is sent.
- *6 When power is first applied, OMNI OFF and POLY ON are sent in the Basic Channel. When Basic Channel changed, OMNI OFF and POLY ON are sent in the new Basic Channel.

2. RECOGNIZED RECEIVE DATA

Status	Second	Third	Description
1000 nnnn	0kkk kkkk	0vvv vvvv	Note OFF, velocity ignored
1001 nnnn	0kkk kkkk	0000 0000	Note OFF kkkkkkk = 0 - 127 (15 - 113)
1001 nnnn	0kkk kkkk	0vvv vvvv	Note ON kkkkkkk = 0 - 127 (15 - 113) vvvvvvv = 1 - 127
1011 nnnn	0000 0100	0vvv vvvv	Foot control vvvvvvv = 0 - 127
1011 nnnn	0000 0111	0vvv vvvv	Volume vvvvvvv = 0 - 127
1011 nnnn	0000 1011	0vvv vvvv	Expression vvvvvvv = 0 - 127
1011 nnnn	0100 0000	0vvv vvvv	Damper OFF vvvvvvv = 0 - 63 Damper ON vvvvvvv = 64 - 127
1011 nnnn	0100 0011	0vvv vvvv	Soft OFF vvvvvvv = 0 - 63 Soft ON vvvvvvv = 64 - 127
1011 nnnn	0101 1100	0vvv vvvv	Tremolo OFF vvvvvvv = 0 - 63 *4 Tremolo ON vvvvvvv = 64 - 127 *4
1011 nnnn	0101 1101	0vvv vvvv	Chorus OFF vvvvvvv = 0 - 63 *4 Chorus ON vvvvvvv = 64 - 127 *4
1100 nnnn	0ppp pppp		Program Change ppppppp = 0 - 63
1011 nnnn	0111 1011	0000 0000	ALL NOTES OFF
1011 nnnn	0111 1010	0vvv vvvv	Local OFF vvvvvvv = 0 - 63 *7 Local ON vvvvvvv = 64 - 127 *7
1011 nnnn	0111 1100	0000 0000	OMNI OFF
1011 nnnn	0111 1101	0000 0000	OMNI ON
1011 nnnn	0111 1110	0000 mmmm	MONO ON
1011 nnnn	0111 1111	0000 0000	POLY ON
1111 1110			Active Sensing

Notes :

- *1 Note numbers outside of the range 15 - 113 are transposed to the nearest octave inside this range. The transposition function does not affect the recognized NOTE numbers.
- *2 Foot control is regarded as Volume.
- *3 Expression is regarded as Volume.
- *4 If the power has been applied while the VOICE 1 switch being held down, this message is ignored.
- *5 If the power has been applied while the VOICE 1 switch being held down, this message is ignored.

The assignment of received Program Change messages are as follows:

Voice	Internal bank number							
	1	2	3	4	5	6	7	8
	Program change numbers							
PIANO 1	0	8	16	24	32	40	48	56
PIANO 2	1	9	17	25	33	41	49	57
PIANO 3	2	10	18	26	34	42	50	58
HARPSICHORD	3	11	19	27	35	43	51	59
CLAVI	4	12	20	28	36	44	52	60
VITRAPHONE	5	13	21	29	37	45	53	61
E.PIANO 1	6	14	22	30	38	46	54	62
E.PIANO 2	7	15	23	31	39	47	55	63

The program change numbers 64 - 127 are ignored. When the Program Change message is recognized, the VOICE will be not change to the new VOICE until all the notes are turned OFF and Damper is turned OFF.

*6 When the ALL NOTES OFF is recognized, all the notes which have been turned ON only by MIDI IN note ON messages are turned OFF. However, if the damper pedal is pressed or the damper ON message has been recognized, these ON notes will be not turned OFF until the damper pedal is released or the Damper OFF message is received.

*7 When the power is first applied and when the receiver's Basic Channel changed by the panel operation, Local control will be set to ON.

*8 These Mode Messages (2nd byte = 123 - 127) are also recognized as ALL NOTES OFF.

Mode Messages are recognized as follows:

	POLY ON (127)	MONO ON (126)	MONO ON (125)
OMNI OFF (124)	OMNI = OFF	OMNI = OFF	OMNI = ON
OMNI ON (125)	OMNI = ON	OMNI = ON	OMNI = ON

* By the panel operation, the receiver's Basic Channel can be set to Channel 1 - 15 and MODE 3 (OMNI OFF, POLY), or Channel 1 and MODE 1 (OMNI ON, POLY). And these settings are memorized.

3. TRANSPOSE

When the power is first applied, the default transposition is set at 0. The following chart shows the relation of the key position and transposed value. (While the TRANSPOSE switch being held down.)

Key	Transposed value (semi tones)	Transmitted note range
power-up	0	21 - 108
F#	-6	15 - 102
G	-5	16 - 103
F	-4	17 - 104
A	-3	18 - 105
A#	-2	19 - 106
B	-1	20 - 107
C	0	21 - 108
C#	+1	22 - 109
D	+2	23 - 110
D#	+3	24 - 111
E	+4	25 - 112
F	+5	26 - 113

4. CONTROLLER'S NUMBER ASSIGNMENT

The Controller's number can be changed by the panel operation.

controller	combination
EXTERNAL VOLUME	7 : 7 : 11 : 11 : 4 : 4
EXP PEDAL	11 : 4 : 4 : 7 : 7 : 11

4 : Foot control, 7 : Volume, 11 : Expression

The current Controller's number is memorized.

5. TREMOLO, CHORUS TRANSMISSION

When the CHORUS switch or the TREMOLO switch is pressed while the PROGRAM CHANGE switch being held down, the function's ON or OFF message is sent. And also, if the power has been applied while the PROGRAM CHANGE switch being held down, the function's ON or OFF message can be sent by only pressing the TREMOLO switch or the CHORUS switch.

6. PROGRAM CHANGE TRANSMISSION

When one of the following VOICE SELECTOR switches is pressed while the PROGRAM CHANGE switch being held down, the PROGRAM CHANGE message is sent as follows.

The BANK can be changed by the panel operation, and memorized.

BANK	VOICE switch							
	1	2	3	4	5	6	7	8
	Program change numbers							
A - 1	0	1	2	3	4	5	6	7
A - 2	8	9	10	11	12	13	14	15
A - 3	16	17	18	19	20	21	22	23
A - 4	24	25	26	27	28	29	30	31
A - 5	32	33	34	35	36	37	38	39
A - 6	40	41	42	43	44	45	46	47
A - 7	48	49	50	51	52	53	54	55
A - 8	56	57	58	59	60	61	62	63
B - 1	64	65	66	67	68	69	70	71
B - 2	72	73	74	75	76	77	78	79
B - 3	80	81	82	83	84	85	86	87
B - 4	88	89	90	91	92	93	94	95
B - 5	96	97	98	99	100	101	102	103
B - 6	104	105	106	107	108	109	110	111
B - 7	112	113	114	115	116	117	118	119
B - 8	120	121	122	123	124	125	126	127

And also, if the power has been applied while the PROGRAM CHANGE switch being held down, the PROGRAM CHANGE message can be sent by changing the VOICE or the internal BANK as follows.

Internal BANK	VOICE							
	1	2	3	4	5	6	7	8
	Program change numbers							
0	1	2	3	4	5	6	7	
8	9	10	11	12	13	14	15	
16	17	18	19	20	21	22	23	
24	25	26	27	28	29	30	31	
32	33	34	35	36	37	38	39	
40	41	42	43	44	45	46	47	
48	49	50	51	52	53	54	55	
56	57	58	59	60	61	62	63	

 Roland®

10940

UPC

10940

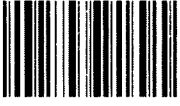

10940

RD-1000

 Roland

86-2-A3-1