



PQ-50 PARAMETRIC EQUALIZER

Owner's Manual

1. The PQ-50 Parametric Equalizer is designed to provide a wide range of frequency response adjustments. It features four parametric equalizers (PEQs) and an input level control. The PEQs are designed to provide a wide range of frequency response adjustments, from 20 Hz to 20 kHz. The input level control is designed to provide a wide range of input level adjustments, from -20 dB to +20 dB.

2. The PQ-50 Parametric Equalizer is designed to provide a wide range of frequency response adjustments. It features four parametric equalizers (PEQs) and an input level control. The PEQs are designed to provide a wide range of frequency response adjustments, from 20 Hz to 20 kHz. The input level control is designed to provide a wide range of input level adjustments, from -20 dB to +20 dB.

3. The PQ-50 Parametric Equalizer is designed to provide a wide range of frequency response adjustments. It features four parametric equalizers (PEQs) and an input level control. The PEQs are designed to provide a wide range of frequency response adjustments, from 20 Hz to 20 kHz. The input level control is designed to provide a wide range of input level adjustments, from -20 dB to +20 dB.

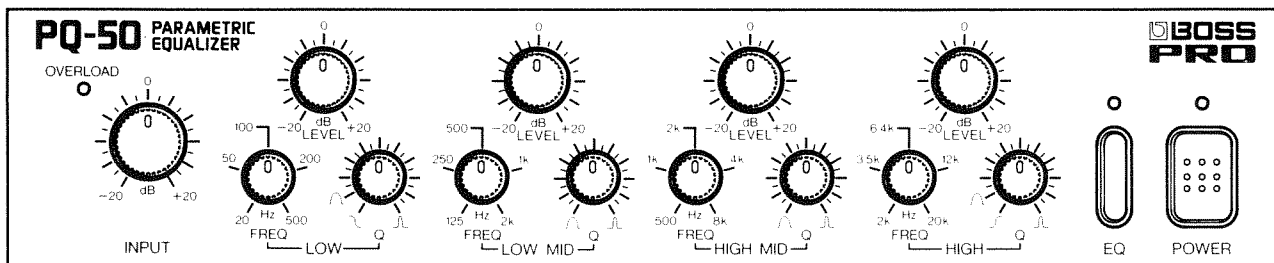

Thank you, and congratulations on your choice of the BOSS PQ-50 Parametric Equalizer.

To make sure you enjoy the complete range of functions the PQ-50 provides, and to ensure satisfaction for years to come, please take the time to completely read this Owner's Manual before starting out.

■ Features

- The PQ-50 is a 4-band parametric equalizer that allows individual control of the frequency, Q curve and level of each band.
- When the Low/High Band is being used, either the Peak or Shelving type filter can be selected.
- The Equalizer Switch allows you to select the Equalizer In or Out mode. The mode can also be changed using a pedal switch.
- The Overload Indicator is provided for setting appropriate signal levels (without distortion).
- Using the Rack Mount Adaptor RAD-50 (optional), the PQ-50 can be mounted in a standard 19 inch rack (EIA).

■ IMPORTANT NOTES

When using an AC adaptor, be sure that it is one supplied by the manufacturer. Use of any other power adaptor could result in damage, malfunction, or electric shock.

Power Supply

- When making any connections with other devices, always turn off the power to all equipment first; this will help prevent damage or malfunction.
- Do not use this unit on the same power circuit with any device that will generate line noise, such as a motor or variable lighting system.
- The power supply required for this unit is shown on its nameplate. Ensure that the line voltage of your installation meets this requirement.
- Avoid damaging the power cord; do not step on it, place heavy objects on it etc.
- When disconnecting the AC adaptor from the outlet, grasp the plug itself; never pull on the cord.
- If the unit is to remain unused for a long period of time, unplug the power cord.

Placement

- Do not subject the unit to temperature extremes (eg. direct sunlight in an enclosed vehicle). Avoid using or storing the unit in dusty or humid areas or areas that are subject to high vibration levels.
- Using the unit near power amplifiers (or other equipment containing large transformers) may induce hum.
- This unit may interfere with radio and television reception. Do not use this unit in the vicinity of such receivers.

Maintenance

- For everyday cleaning wipe the unit with a soft, dry cloth (or one that has been slightly dampened with water). To remove stubborn dirt, use a mild neutral detergent. Afterwards, be sure to wipe the unit thoroughly with a soft, dry cloth.
- Never use benzine, thinners, alcohol or solvents of any kind, to avoid the risk of discoloration and/or deformation.

Additional Precautions

- Protect the unit from strong impact.
- Do not allow objects or liquids of any kind to penetrate the unit. In the event of such an occurrence, discontinue use immediately. Contact qualified service personnel as soon as possible.
- Should a malfunction occur (or if you suspect there is a problem) discontinue use immediately. Contact qualified service personnel as soon as possible.
- To prevent the risk of electric shock, do not open the unit or its AC adaptor.

PANEL DESCRIPTIONS

< Front Panel >

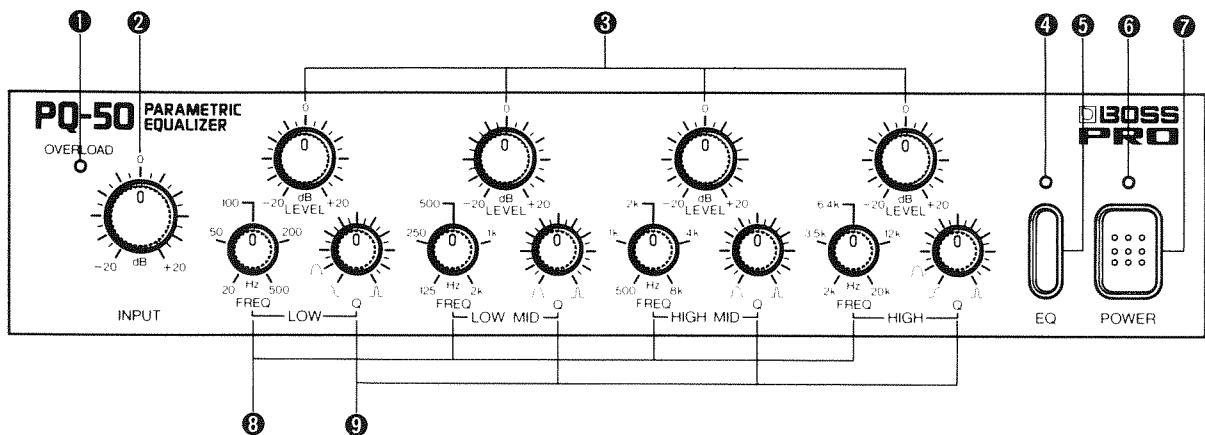

1 Overload Indicator

This indicator lights when the level of the input or output signal is too high.

* **The indicator actually lights when the level of the signal is 6dB below the clipping point (where the signal is distorted).**

If the indicator lights frequently, adjust the level as follows so that it flashes only on the highest input peaks.

- Lower the output level on the device connected to the Input Jack (14).
- Lower the input level with the Input Level Knob (2).
- Change the Level Switch (18) to the "+4dBm" position.

2 Input Level Knob

This knob controls the input level. Normally, it should be set to the "0" position. When the Overload Indicator lights frequently, rotate the knob counterclockwise (←) so that the light flashes only on the highest input peaks.

3 Level Control Knobs

These knobs control the level (boosting/cutting) of each band (Low, Low Middle, High Middle, High).

* **When a Level Control Knob is set to the "0dBm" (click) position, a flat characteristic is created. That is, the sound is not altered, even by moving the Frequency Control or Q Control knob.**

4 Equalizer Indicator

This indicator lights when the unit is set to the Equalizer In mode.

5 Equalizer Switch

This switch selects the Equalizer In or Out mode. When it is set to the In position, the input signal is filtered by the equalizer, then output. When it is set to the Out position, the input signal is output directly (bypass).

This switch can be used for comparing the equalized and un-equalized sounds or adjusting the level difference between the two.

6 Power Indicator

This indicator lights when the Power Switch is turned on.

7 Power Switch

This switches the unit on and off.

- * **Before switching the unit on and off, be sure to set the volume of the amplifier to zero.**
- * **Muting circuits function for a few seconds after the unit is switched on. No sound will be heard during this time.**

8 Frequency Control Knobs

These knobs control the filter's center frequency around which signals are boosted or cut.

9 Q Control Knobs

These knobs control the width of the frequency band. Rotating the knob clockwise makes the filter sharper.

* **When the Low or High band is being used, setting a Q Control Knob to the " ∞ , ∞ " position will automatically select the Shelving type filter.**

< Rear Panel >

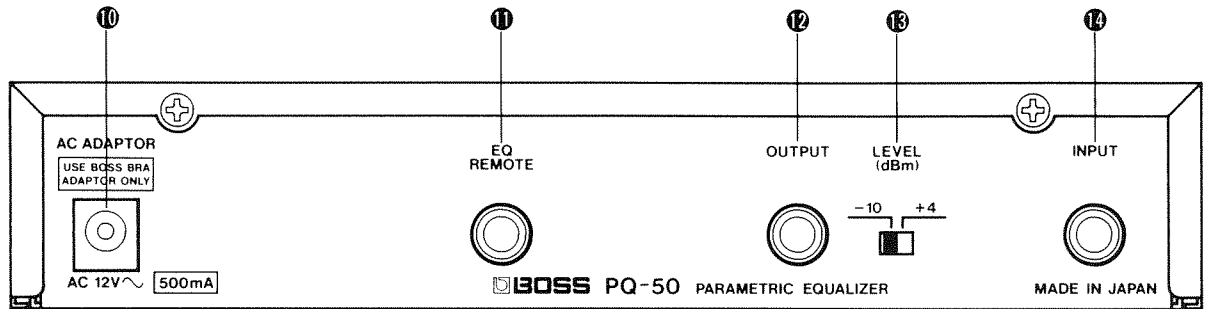

⑩ AC Adaptor Jack

Connect the supplied AC adaptor (BOSS BRA-120, 220 or 240) to this jack.

⑪ Equalizer Remote Jack

By connecting a footswitch (FS-5L : optional) to this jack, you can select the Equalizer In or Out mode with the footswitch. The Equalizer Indicator shows which mode is currently selected.

* **When using a footswitch, be sure to set the Equalizer Switch on the unit to the IN position.**

⑫ Output Jack

Signals are output from this jack.

⑬ Level Switch

This is a selector switch for the rated input or output level. Set it to either the "−10dBm" or "+4dBm" position depending on the instrument you are using. Normally, when you use a guitar or electronic musical instrument, set it to the "−10dBm" position.

* **The volume of sound is not altered by changing the position of the Level Switch.**

⑭ Input Jack

Connect the instrument/device to this jack.

When using the unit without the optional Rack Mount Adaptor RAD-50, please attach the rubber feet as shown below.

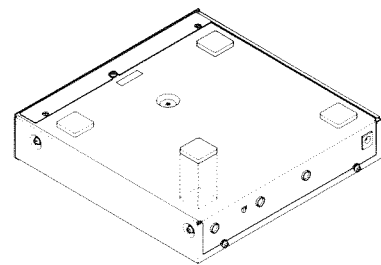

■ Functions of the PQ-50

The PQ-50 is a 4-band parametric equalizer. It allows you to control the frequency, Q curve and level of each individual band and adjust the frequency characteristic of input signals.

◀ Frequency Control ▶

The PQ-50 allows you to control the center frequency of the individual filters around which signals are boosted or cut.

The variable frequency ranges are as follows:

LOW BAND : 20Hz to 500 Hz

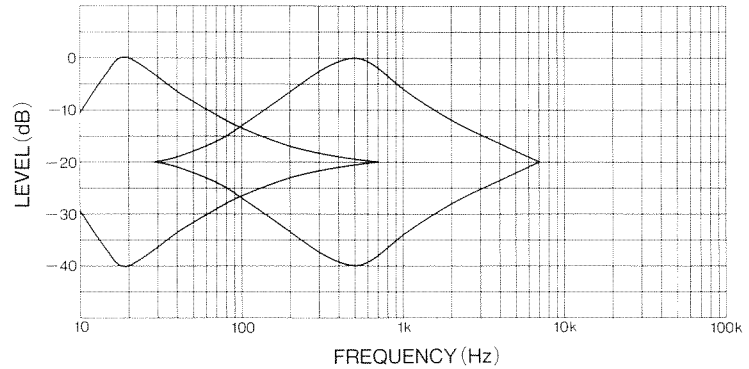

LOW MIDDLE BAND : 125Hz to 2kHz

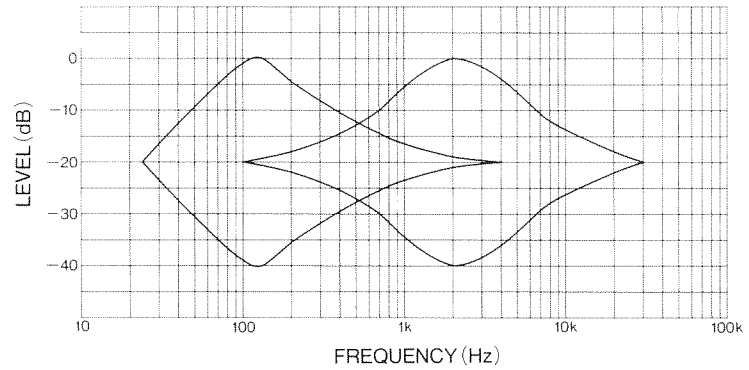

HIGH MIDDLE BAND : 500Hz to 8kHz

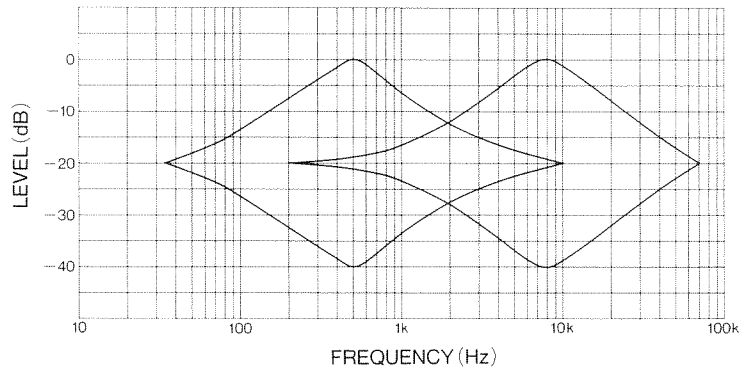

HIGH BAND : 2kHz to 20kHz

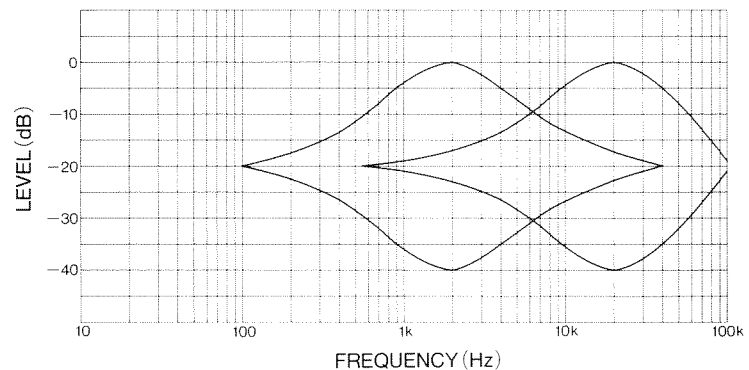

* When the Low or High band is being used, setting the Q Control Knob to the " \ , / " position will automatically select the Shelving type filter and the characteristic of the filter changes as follows.

LOW BAND

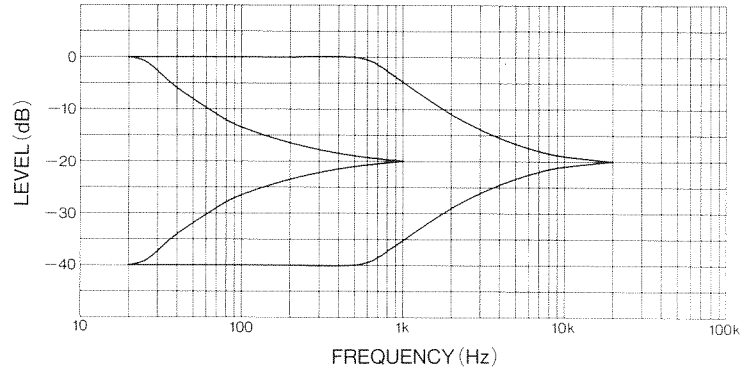

HIGH BAND

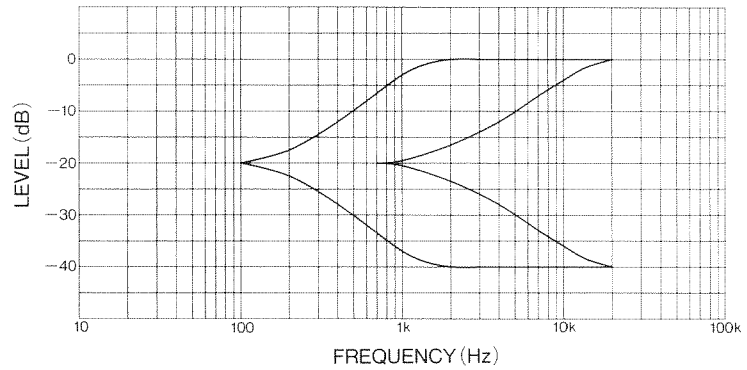

« Q Control »

The Q Control allows you to change the width of the frequency band. Rotating it clockwise makes the filter sharper.

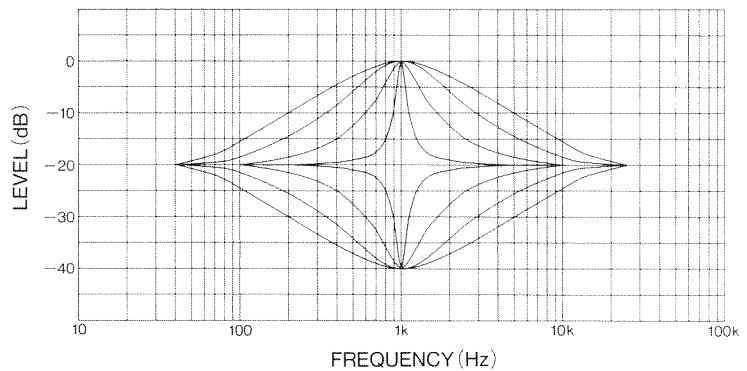

* When the Low or High band is being used, setting the knob to the " \ , / " position will automatically select the Shelving type filter.

« Level Control »

The Level Control Knobs control the levels (boosting/cutting) of each band (Low, Low Middle, High Middle, High).

The variable range is ± 20 dB for all four bands.

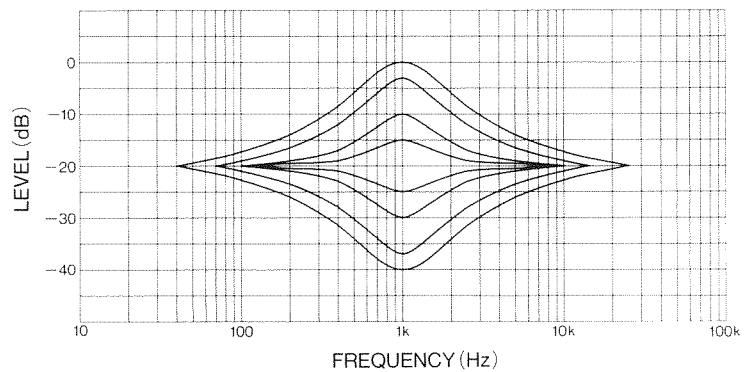

MAKING CONNECTIONS

Connection Example 1: For obtaining compensation for the overall tone and sound field.

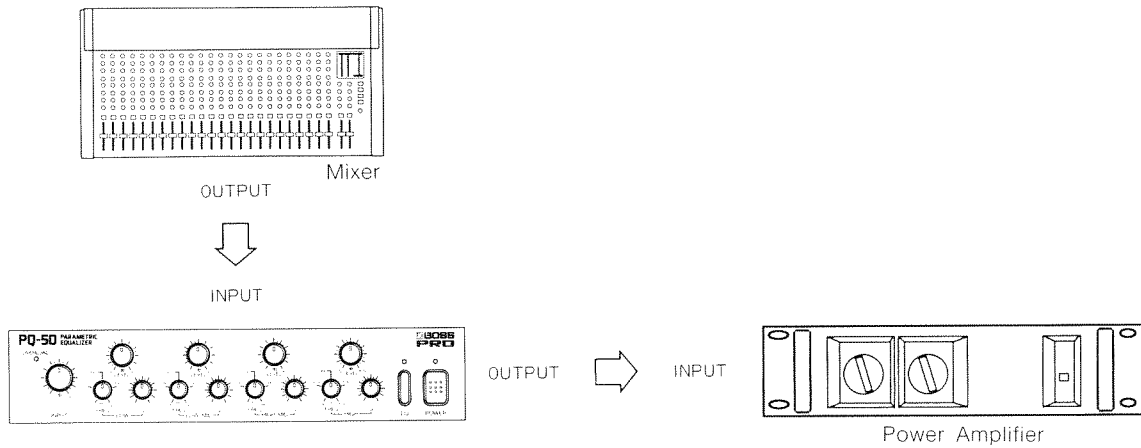

Connection Example 2: To connect to a Channel Insert on a mixer.

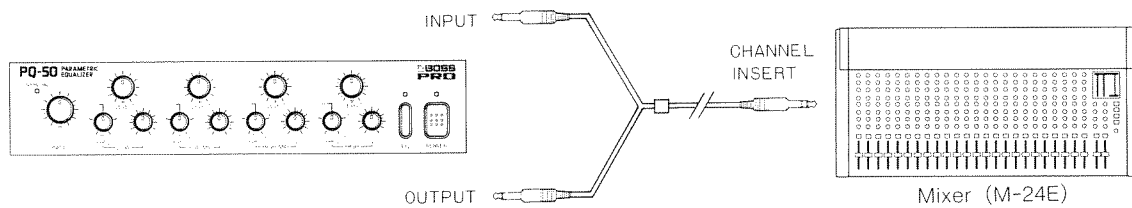

* For making the connection an "insert" cable is needed (PCS-31).

Connection Example 3: For connecting a keyboard, electric guitar, or other instrument.

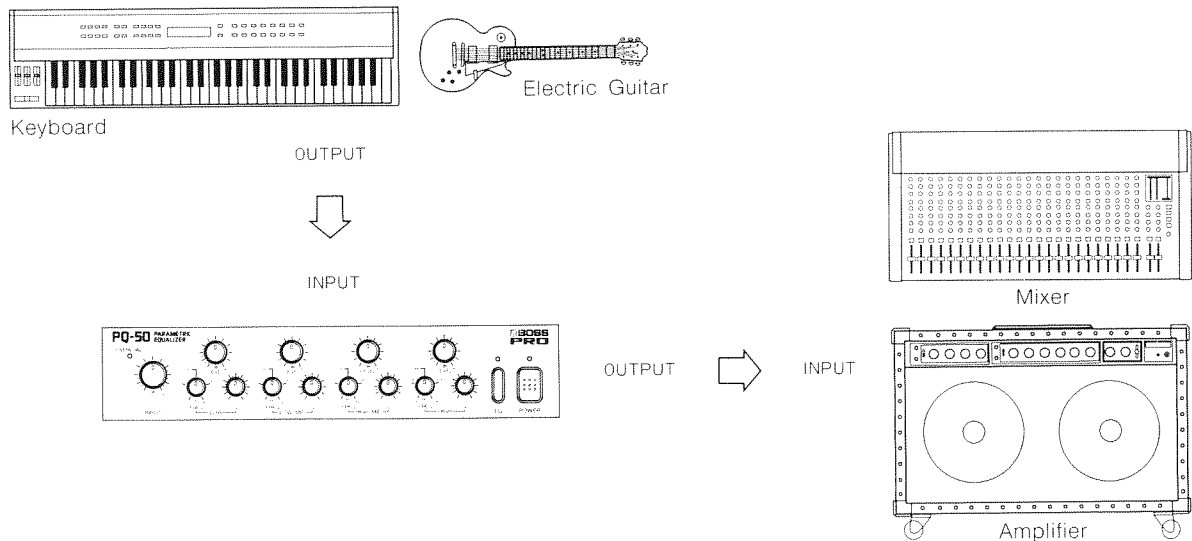

■ BLOCK DIAGRAM

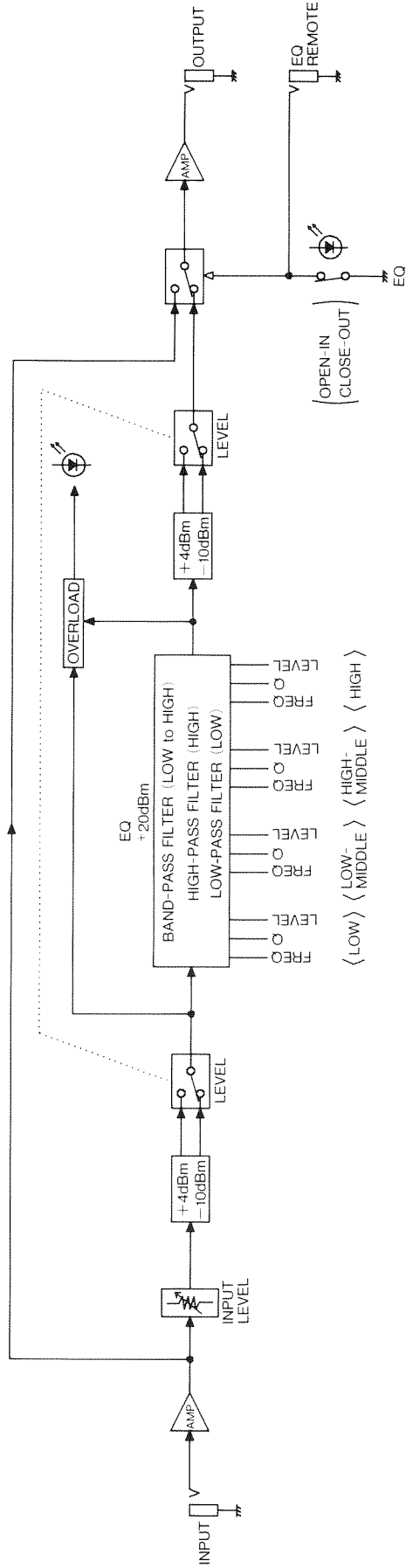

■ SPECIFICATIONS

Frequency Response:

10Hz to 30kHz +1/−0.5dB
(Flat, Level Switch:−10dBm)

Nominal Input Level:

−10dBm/+4dBm
(selectable with Level Switch)

Input Impedance:

1MΩ

Nominal Output Level:

−10dBm/+4dBm (same as Nominal Input Level)

Recommended Load Impedance:

50kΩ or greater

Total Harmonic Distortion:

0.03% or less (IHF-A, Flat, Level Switch: −10dBm)

Residual Noise Level:

−97dBm or less (IHF-A, Flat, Level Switch: −10dBm)

Equalizer Control:

Center Frequency	Low: 20Hz to 500Hz Low Mid: 125Hz to 2kHz High Mid: 500Hz to 8kHz High: 2kHz to 20kHz
Q	0.8 to 14
Variable Range	±20dB

0dBm=0.775Vrms

Controls:

Input Level Knob
Frequency Control Knob × 4
Q Control Knob × 4
Level Control Knob × 4
Equalizer Switch
Power Switch
Level Switch

Indicators:

Power Indicator
Equalizer Indicator
Overload Indicator

Connectors:

Input Jack(1/4 inch phone type)
Output Jack(1/4 inch phone type)
Equalizer Remote Jack
AC Adaptor Jack(AC 12V)

Power Supply:

AC12V : AC Adaptor BRA-120, 220, 240

Current Draw:

500mA

Dimensions:

218(W)×234(D)×44(H) mm
8−5/8"(W)×9−1/4"(D)×1−3/4"(H) inches

Weight:

1.2 kg / 2 lbs 11 oz

Accessories:

AC Adaptor BRA-120, 220, 240
Foot Rubber ×4
Owner's Manual

Options:

Rack mount Adaptor RAD-50
※ Not attachable to Rack Mount Adaptor RAD-10.
Foot Switch FS-5L

* In the interest of product improvement, the specifications of this unit are subject to change without prior notice.

Information

● When you need repair service, call your local Roland Service Station or the authorized Roland distributor in your country as shown below.

U. S. A.

Roland Corp US
7200 Dominion Circle
Los Angeles, CA. 90040 - 3647
U. S. A.
☎ (213)685 - 5141

CANADA

Roland Canada Music Ltd.
(Head Office)
5480 Parkwood
Richmond B. C., V6V 2M4
CANADA
☎ (604)270 - 6626

Roland Canada Music Ltd.
9425 Transcanadienne
Service Rd. N.,
St Laurent, Quebec H4S 1V3
CANADA
☎ (514)335 - 2009

Roland Canada Music Ltd.
346 Watline Avenue,
Mississauga, Ontario L4Z 1X2
CANADA
☎ (416)890 - 6488

AUSTRALIA

Roland Corporation
(Australia) Pty. Ltd.
(Head Office)
38 Campbell Avenue
Dee Why West. NSW 2099
AUSTRALIA
☎ (02)982 - 8266

Roland Corporation
(Australia) Pty. Ltd.
(Melbourne Office)
50 Garden Street
South Yarra, Victoria 3141
AUSTRALIA
☎ (03)241 - 1254

NEW ZEALAND

Roland Corporation (NZ) Ltd.
97 Mt. Eden Road, Mt. Eden,
Auckland 3
NEW ZEALAND
☎ (09)3098 - 715

UNITED KINGDOM

Roland(UK)Ltd.
Rye Close
Ancells Business Park
Fleet
Hampshire GU13 8UY
UNITED KINGDOM
☎ 0252 - 816181

GERMANY

Roland Elektronische
Musikinstrumente
Handelsgesellschaft mbH.
Oststrasse 96,
2000 Norderstedt
GERMANY
☎ 040/52 60 090

BELGIUM/HOLLAND/ LUXEMBOURG

Roland Benelux N. V.
Houtstraat 1
B - 2260 Oevel - Westerlo
BELGIUM
☎ (0032)14 - 575811

DENMARK

Roland Scandinavia as
Langebrogade 6
Box 1937
DK - 1023 Copenhagen K.
DENMARK
☎ 31 - 95 31 11

SWEDEN

Roland Scandinavia as
DanvikCenter 28 A, 2 tr.
S - 131 30 Nacka,
SWEDEN
☎ 08 - 702 00 20

NORWAY

Roland Scandinavia
Avd. Norge
Lilleakerveien 2
Postboks 95 Lilleaker
N - 0216 Oslo 2
NORWAY
☎ 02 - 73 00 74

FINLAND

Fazer Musik Inc.
Länsituulentie
POB 169
SF - 02101 Espoo
FINLAND
☎ 0 - 43 50 11

ITALY

Roland Italy S. p. A.
Viale delle Industrie 8
20020 ARESE MILANO
ITALY
☎ 02 - 93581311

SPAIN

Roland Electronics
de España, S. A.
Calle Bolivia 239
08020 Barcelona
SPAIN
☎ 93 - 308 - 1000

SWITZERLAND

Musitronic AG
Gerberstrasse 5, CH - 4410
Liestal
SWITZERLAND
☎ 061/921 16 15

Roland CK (Switzerland) AG
Hauptstrasse 21/Postfach
CH - 4456 Tenniken
SWITZERLAND
☎ 061/98 60 55
Repair Service by Musitronic AG

FRANCE

Musikengro
102 Avenue Jean - Jaures
69007 Lyon Cedex 07
FRANCE
☎ (7)858 - 54 60

Musikengro
(Paris Office)
Centre Region Parisienne
41 rue Charles - Fourier,
94400 Vitry s/Seine
FRANCE
☎ (1)4680 86 62

AUSTRIA

E. Dematte & Co.
Neu - Rum Siemens - Strasse 4
A - 6021 Innsbruck Box 591
AUSTRIA
☎ (0512)63 451

GREECE

V. Dimitriadis & Co. Ltd.
2 Phidiou Str., GR 106 78
Athens
GREECE
☎ 1 - 3620130

PORTUGAL

Casa Caius Instrumentos
Musicais Lda.
Rua de Santa Catarina 131
Porto
PORTUGAL
☎ 02 - 38 44 56

HUNGARY

Intermusica Ltd.
Warehouse Area 'DEPO'
Budapest. P.O. Box 3,
2045 Torokbalint
HUNGARY
☎ (1)1868905

ISRAEL

D.J.A. International Ltd.
25 Pinsker St.,
Tel Aviv
ISRAEL
☎ 03 - 283015

BRAZIL

FORESIGHT Corporation
R. Alvarenga 591
CEP - 05509 Sao Paulo
BRAZIL
FAX: (011)210 - 0286

HONG KONG

Tom Lee Music Co., Ltd.
Service Division
22 - 32 Pun Shan Street,
Tsuen Wan,
New Territories,
HONG KONG
☎ 415 - 0911

SINGAPORE

Swee Lee Company
Bras Basah Complex #03 - 23
Singapore 0178
SINGAPORE
☎ 3367886

THAILAND

Theera Music Co., Ltd.
330 Verng Nakorn Kasem, Soi 2
Bangkok 10100,
THAILAND
☎ 2248821

MALAYSIA

Syarikat Bentley
No. 142, Jalan Bukit Bintang
55100 Kuala Lumpur
MALAYSIA
☎ 2421288

INDONESIA

PT Galestra Inti
Kompleks Perkantoran
Duta - Merlin Blok C/59
Jl. Gajah mada No.3 - 5
Jakarta 10130
INDONESIA
☎ (021) 354604, 354606

TURKEY

Barkat Sanayi ve Ticaret
Siraselviler Cad. 86/6 Taksim
Istanbul
TURKEY
☎ 149 93 24

CYPRUS

Radex Sound Equipment Ltd.
17 Panteli Katelari Str.
P.O.Box 2046, Nicosia
CYPRUS
☎ 453426, 466423

As of JUL 7, 1991

 Roland®

2603025300

UPC 2603025300



18981

 **BOSS**
Products of Roland