

Roland® V-Pad PD-80/PD-80R

Owner's Manual



Thank you, and congratulations on your choice of the Roland PD-80/PD-80R V-Pad.

Before using this unit, carefully read the sections entitled: "USING THE UNIT SAFELY" (p. 3-4) and "IMPORTANT NOTES" (p. 4). These sections provide important information concerning the proper operation of the unit. Additionally, in order to feel assured that you have gained a good grasp of every feature provided by your new unit, Owner's manual should be read in its entirety. The manual should be saved and kept on hand as a convenient reference.

Before using the PD-80/PD-80R, you need to make the following settings.

- Head tension adjustment (p. 5)
- Settings for the percussion sound module (p. 2)

Contents of the Package

- PD-80 or PD-80R (pad unit)
- Connection Cable
- Tuning Key
- Owner's Manual (this manual)

Names of Components

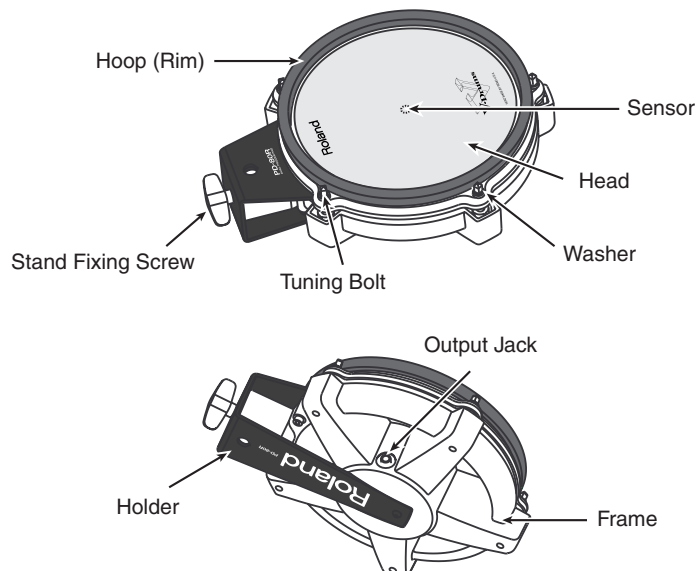

Copyright © 2003 ROLAND CORPORATION

All rights reserved. No part of this publication may be reproduced in any form without the written permission of ROLAND CORPORATION.

Recommended Settings for the Percussion Sound Module

Recommended settings for the trigger parameters when using the PD-80/PD-80R with various percussion sound modules.

- When used with a percussion sound module capable of positional sensing, you can obtain tonal changes by varying the location at which the pad is struck.
- You can perform rim shots and cross-sticking with the PD-80R. For information on sound generator and trigger input combinations, refer to p. 6.
- The trigger parameters should be adjusted as necessary to match the actual state of your configuration, and the environment in which it is being used.
- For information on how to change the parameters for a percussion sound module. Refer to the documentation for the percussion sound module you're using.

TD-10 (TDW-1 V-Cymbal Control, TDW-1)

Trigger Type	PD-80: 8 A or 8 B, PD-80R: 8RA or 8RB
Sensitivity	5
Threshold	2
Curve	Linear
Scan Time (*1)	1.8
Retrigger Cancel (*1)	4
Mask Time (*1)	8
Xtalk Cancel (*1)	50
Mount Type (*1)	PadMount
Xstick Thrshld	75 (PD-80R only)
Rim Sens	8 (PD-80R only)

TD-10 (Non expanded)

Trigger Type	12A
Sensitivity	3
Threshold	1
Curve	Linear
Scan Time (*1)	1.8
Retrigger Cancel (*1)	3
Mask Time (*1)	12
Xtalk Cancel (*1)	OFF
Rim Sens	8 (PD-80R only)

TD-8

TRIGGER TYPE	PD-80: 8 A or 8 B, PD-80R: 8RA or 8RB
SENSITIVITY	7
THRESHOLD	3
CURVE	LINEAR
RIM SENS	8 (PD-80R only)
SCAN TIME	PD-80R: 2, PD-80: 1
RETRIGCANCL	3
MASK TIME	0
CROSSTALK	45
CROSS STICK	5 (PD-80R only)

TD-6V

TrigType	PD-80: PD80/100, PD-80R: PD80R
Sensitivity	8
Threshold	PD-80R: 3, PD-80: 1
TrigCurve	LINEAR
Xtalk Cancel	40
Scan Time	1.0
Retrig Cancel	3
Mask Time	4
Rim Sens	11 (PD-80R only)

TD-7(*2)

Cross Talk Group	OFF
Velocity Curve	Norm3
Choke	OFF
Max Dyna	5
MIn Dyna	9
Min Velo	1
Mask Time	0
Threshold	1

TD-5

TRIGGER TYPE	P1
SENSITIVITY	4
THRESHOLD	1
CURVE	Lnr

SPD-20

TRIG SENS	8
TRIG THRESHOLD	0840
TRIG TYPE	120
TRIG CURVE	1
RIM SENS	1 (PD-80R only)

SPD-11

Trig Sens	8
Trig Threshold	1
Trig Mask Time	0
Trig Scan Time	20

SPD-S

Input Mode	PD-80: TRIGx2, PD-80R: HD/RM
Trigger Type	PD-80: PD-80/100, PD-80R: PD-80R
Sensitivity	8
Threshold	PD-80: 3, PD-80R: 2
Velocity Curve	LINEAR
Scan Time	1.0
Retrigger Cancel	PD-80: 4, PD-80R: 3
Mask Time	4
Xtalk Cancel	30
Rim Sensitivity	11 (PD-80R only)
Rim Gain	1.2 (PD-80R only)

HPD-15

Input Mode	PD-80: TRIGx2, PD-80R: HD/RM
Trig Type	PD-80: PD-80, PD-80R: PD-80R
Trig Sens	8
Curve	Linear
Threshold	2
Scan Time	1ms
Retrig Cancel	2
Mask Time	2ms
X-Talk Rate	50%
Rim Sens	8 (PD-80R only)

*1: You need to set each advanced trigger parameter after setting the trigger type.

*2: Each trigger parameter can be set independently for the "head-side" and "rim-side." Set to the same value for the head and rim. Trigger parameters can be set individually for each patch.

USING THE UNIT SAFELY

INSTRUCTIONS FOR THE PREVENTION OF FIRE, ELECTRIC SHOCK, OR INJURY TO PERSONS

About ⚠ WARNING and ⚠ CAUTION Notices

⚠ WARNING	Used for instructions intended to alert the user to the risk of death or severe injury should the unit be used improperly.
⚠ CAUTION	Used for instructions intended to alert the user to the risk of injury or material damage should the unit be used improperly. * Material damage refers to damage or other adverse effects caused with respect to the home and all its furnishings, as well to domestic animals or pets.

About the Symbols

	The ⚠ symbol alerts the user to important instructions or warnings. The specific meaning of the symbol is determined by the design contained within the triangle. In the case of the symbol at left, it is used for general cautions, warnings, or alerts to danger.
	The ⚡ symbol alerts the user to items that must never be carried out (are forbidden). The specific thing that must not be done is indicated by the design contained within the circle. In the case of the symbol at left, it means that the unit must never be disassembled.
	The ● symbol alerts the user to things that must be carried out. The specific thing that must be done is indicated by the design contained within the circle. In the case of the symbol at left, it means that the power-cord plug must be unplugged from the outlet.

ALWAYS OBSERVE THE FOLLOWING





⚠ WARNING

- Before using this unit, make sure to read the instructions below, and the Owner's Manual.
- Do not open or perform any internal modifications on the unit. (The only exception would be where this manual provides specific instructions which should be followed in order to put in place user-installable options; see p. 7.)
- Do not attempt to repair the unit, or replace parts within it (except when this manual provides specific instructions directing you to do so). Refer all servicing to your retailer, the nearest Roland Service Center, or an authorized Roland distributor, as listed on the "Information" page.
- Never use or store the unit in places that are:
 - Subject to temperature extremes (e.g., direct sunlight in an enclosed vehicle, near a heating duct, on top of heat-generating equipment); or are
 - Damp (e.g., baths, washrooms, on wet floors); or are
 - Humid; or are
 - Exposed to rain; or are
 - Dusty; or are
 - Subject to high levels of vibration.
- This unit should be used only with a rack or stand that is recommended by Roland.



⚠ WARNING

- When using the unit with a rack or stand recommended by Roland, the rack or stand must be carefully placed so it is level and sure to remain stable. If not using a rack or stand, you still need to make sure that any location you choose for placing the unit provides a level surface that will properly support the unit, and keep it from wobbling.
- Do not allow any objects (e.g., flammable material, coins, pins); or liquids of any kind (water, soft drinks, etc.) to penetrate the unit.
- In households with small children, an adult should provide supervision until the child is capable of following all the rules essential for the safe operation of the unit.
- Protect the unit from strong impact. (Do not drop it!)
- To avoid personal injury and/or damage to the unit, do not touch anything inside the frame of the PD-80 and PD-80R.

⚠ CAUTION

- Try to prevent cords and cables from becoming entangled. Also, all cords and cables should be placed so they are out of the reach of children. 
- Never climb on top of, nor place heavy objects on the unit. 
- Should you remove lock-nut, spacer, rubber spacer, washer, or tuning bolt, etc., make sure to put them in a safe place out of children's reach, so there is no chance of them being swallowed accidentally. 
- Do not apply excessive force to the sensor located below the center of the head. Doing so can interfere with accurate detection, and may damage it. 
- Due to the nature of the materials used in the sensor, changes in room temperature may affect the sensitivity of the sensor. 

⚠ CAUTION

- Brushes can be used to play the PD-80 and PD-80R when the TD-8 and TD-10 are used as the sound module. When using brushes, be sure to use nylon brushes. Using metal brushes will not only scratch the head, but can also be hazardous, since the tip of the brush may catch in the mesh of the net. 
- The PD-80 and PD-80R are shipped from the factory with the head tension loosened. Be sure to tighten the tension before use. Striking the head when the head tension is loose may damage the sensor and head. 
- The hoop's rubber portion is one component that eventually wears out (the more so if numerous rim shots are performed), and will require replacement. Rim shots may not be performed correctly when the rubber portion is worn out. If this occurs, replace the hoop rubber. Consult Roland Service for more on replacing the hoop rubber. 

IMPORTANT NOTES

In addition to the items listed under "USING THE UNIT SAFELY" on page 3–4, please read and observe the following:

Placement

- Do not expose the unit to direct sunlight, place it near devices that radiate heat, leave it inside an enclosed vehicle, or otherwise subject it to temperature extremes. Also, do not allow lighting devices that normally are used while their light source is very close to the unit (such as a piano light), or powerful spotlights to shine upon the same area of the unit for extended periods of time. Excessive heat can deform or discolor the unit.
- Do not allow rubber, vinyl, or similar materials to remain on the unit for long periods of time. Such objects can discolor or otherwise harmfully affect the finish.

Maintenance

- For everyday cleaning wipe the unit with a soft, dry cloth or one that has been slightly dampened with water. To remove stubborn dirt, use a cloth impregnated with a mild, non-abrasive detergent. Afterwards, be sure to wipe the unit thoroughly with a soft, dry cloth.
- Never use benzine, thinners, alcohol or solvents of any kind, to avoid the possibility of discoloration and/or deformation.

Additional Precautions

- Use a reasonable amount of care when using the unit's buttons, sliders, or other controls; and when using its jacks and connectors. Rough handling can lead to malfunctions.
- When connecting / disconnecting all cables, grasp the connector itself—never pull on the cable. This way you will avoid causing shorts, or damage to the cable's internal elements.
- This instrument is designed to minimize the extraneous sounds produced when it's played. However, since sound vibrations can be transmitted through floors and walls to a greater degree than expected, take care not to allow these sounds to become a nuisance to neighbors, especially when performing at night and when using headphones.

Features

- Snare/tom pad with embedded-mesh head for superior playing feel, and quiet response.
- Compact, eight-inch pad allows for greater versatility when setting up.
- The PD-80R incorporates a rim sensor, for expressive capabilities rivaling an acoustic snare drum.
- Once you connect the PD-80 or PD-80R to Trigger Input 3 (SNARE) on a TD-8 Percussion Sound Module, you will be able to enjoy enhanced capabilities, as follows.
 - Tonal changes can be expressed by varying the location at which the pad is struck.
 - Brushes (nylon) can be used for brush playing.
 - On the PD-80R you can use cross-stick (closed rim shot), and rim shot playing techniques.

Adjusting the Head

Adjusting the Head Tension

When adjusting, use the included tuning key.

The PD-80 and PD-80R are shipped from the factory with the head tension loosened. Be sure to adjust the tension before use.

In general, a tension that produces a strike response approximately the same as an acoustic drum will be appropriate.

NOTE

- Striking the head when the head tension is loose may damage the sensor and head.
- Should you neglect to make the appropriate settings, you could likely experience the following problems:
Sometimes it does not sound (uneven volume).
The volume is too low (reduced sensitivity).



7mm

The band has a width of 7 mm.
Use this for adjusting the head tension.

MEMO

- On the PD-80/80R, adjusting the head tension affects only the head response, and does not change the pitch of the sound, as it would on an acoustic drum.
- The head tension will change as the instrument is used, so you should readjust when necessary.
- The head stretches when used for extended periods, so even when this is adjusted to 7 mm in the following procedure, you may not achieve the same degree of tension as when the head was initially adjusted. Strike the head to check the feel and response as you adjust the tension.

1. Use the included tuning key to tighten the tuning bolts.

Tighten the bolts until there is a space of approximately 7 mm between the frame and the hoop.

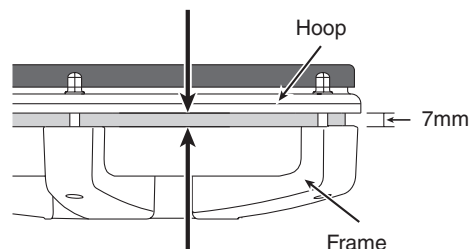

HINT

A black, 7 mm strip is printed at the edge of this page. Use this as a reference when making the adjustment.

NOTE

Tighten each tuning bolt one by one, observing the numerical order shown in the diagram. Do not firmly tighten a single tuning bolt by itself. Doing so will make it impossible to tension the head evenly, and will cause malfunctions such as failure to accurately detect the striking location.

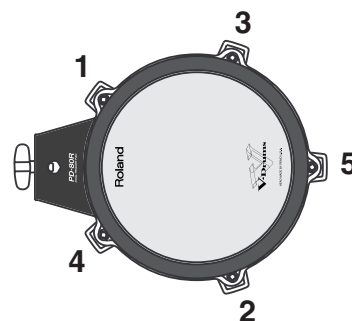

2. Fine-tune the adjustment while continuing to check the pad feel and response.

Adjustment for Positional Sensing with the TD-8 or the TD-10

When the TD-8 or the TD-10 is used as the sound module, the location at which the pad is struck can be varied to produce tonal changes. In this case, it is important to adjust the head so the tension is evenly distributed, so the striking location can be detected accurately. For details on adjustments, refer to the TD-8 or the TD-10 owner's manual.

MEMO

The TD-10 owner's manual assumes use of the PD-100 and PD-120 pads in its explanation. If you are using the PD-80 or PD-80R, however, make adjustments while striking them 1 inch (3 cm) from the rim.

Sound Module	Trigger inputs that allow positional sensing
TD-8	3 (SNARE)
TD-10	2 (SNARE)

Attaching the Pad to a Stand

Attach the PD-80 or PD-80R to a stand (MDS series).

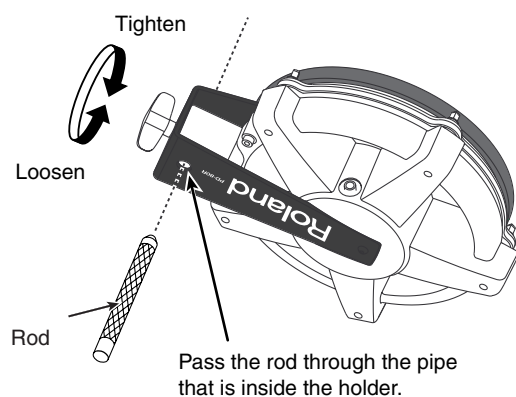

MEMO

When attaching the PD-80/80R to a tom stand, check the dimensions of the rod. Depending on the dimensions of the rod, it may not be possible to attach the pad to the stand.

Acceptable rod diameters:
8.5–11.5 mm (3/8 to 1/2 inch)

Connecting to the Percussion Sound Module

NOTE

To prevent malfunction and/or damage to speakers or other devices, always turn down the volume, and turn off the power on all devices before making any connections.



When you have finished connecting to your drum sound module, refer to the recommended parameters on p. 2, and make the settings for the sound module.

Connecting to the TD-6V, TD-8, TD-10, HPD-15, SPD-20, or SPD-S

NOTE

- Use the included cable to make connections.
- With the PD-80R, make sure to use the supplied stereo cable when connecting it. Otherwise (if you use a monaural cable), you won't be able to employ striking location detection, rim shot, and cross stick playing techniques.
- Connect the L-shaped plug of the included cable to the PD-80/80R. This will prevent strain from being applied to the PD-80/80R.

Correspondences Between Playing Techniques and Percussion Sound Modules

Sound Module	Trigger Input	Rim Shot	Cross Stick	Positional Sensing
TD-6V	2 (SNARE)	o	o	–
TD-8	3 (SNARE)	o	o	o
TD-10	2 (SNARE)	o	–	o
TD-10 (TDW-1)	2 (SNARE)	o	o	o
HPD-15	1, 2	o	–	–
SPD-20	1, 2	o	–	–
SPD-S	1, 2	o	–	–

* Rim shots and cross-stick performances can be made only with the PD-80R.

Connecting to the TD-5, TD-7 or SPD-11

NOTE

- Use the included cable to make connections.
- Connect the L-shaped plug of the included cable to the PD-80/80R. This will prevent strain from being applied to the PD-80/80R.
- It is not possible to play rim shots even if you connect the PD-80R to the TD-5, TD-7, or SPD-11.

Replacing the Head

When the Head Should Be Replaced

The head is an expendable item that eventually will wear out and need to be replaced. Replace the head when the following occurs:

- The head surface is torn
- Striking points are no longer detected correctly, even when the head tension is properly adjusted.
- Slack portions remain in the head even after the head tension is properly adjusted.

Replacement heads (optional)

MH-8 Mesh Head: for either PD-80 or PD-80R

Replacing the Head

1. Remove all tuning bolts and washers.



If using the PD-80R, press the lock bushing (in figure below) in place with your finger as you remove each tuning bolt, to prevent the bushings from being pulled off the frame.

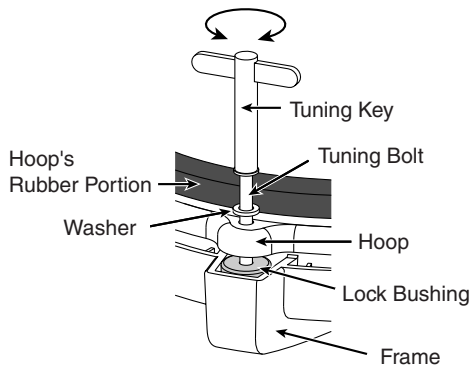

For more on the lock bushings, refer to the following section, "About the PD-80R's Lock Bushings."

- 2. Remove the hoop.**
- 3. Remove the old head.**
- 4. Place the new head on the frame.**
- 5. Place the hoop onto the head.**
- 6. Pass the tuning bolts through the washers, then attach them to the hoop and frame.**
- 7. Next, adjust the tension of the head. Refer to "Adjusting the Head Tension" (p. 5).**



Do not firmly tighten a single tuning bolt by itself. Doing so will make it impossible to tension the head evenly, and will cause malfunctions such as failure to accurately detect the striking location.

About the PD-80R's Lock Bushings

The PD-80R is provided with lock bushings to prevent rotation and loosening of the tuning bolts caused by vibration transmitted from the hoop, as the result of using rim shots or other performance techniques.

If a lock bushing happens to become separated from the frame while the head is being replaced, position the bushing so its four slots are aligned with the corresponding ridges in the frame, then press down firmly on the bushing.

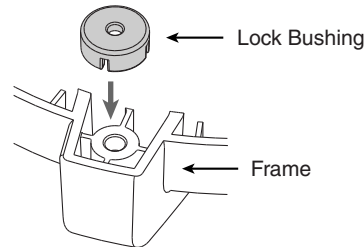

Specifications

PD-80 (Pad)

Pad Size: 8 inches
Trigger: 1 (Head)
Dimensions: 245 (W) x 310 (D) x 95 (H) mm
9-11/16 (W) x 12-1/4 (D) x 3-3/4 (H) inches
Weight: 1.6 kg
3 lbs 8 oz
Accessories: Owner's Manual, Connection Cable, Tuning Key
Options: Mesh Head (MH-8),
Pad Mounts (MDH-7U, MDH-10),
Drum Stands (MDS-3C, MDS-6, MDS-8C,
MDS-10, MDS-20)

PD-80R (Pad)

Pad Size: 8 inches
Triggers: 2 (Head, Rim)
Dimensions: 245 (W) x 310 (D) x 95 (H) mm
9-11/16 (W) x 12-1/4 (W) x 3-3/4 (H) inches
Weight: 1.7 kg
3 lbs 12 oz
Accessories: Owner's Manual, Connection Cable, Tuning Key
Options: Mesh Head (MH-8),
Pad Mounts (MDH-7U, MDH-10),
Drum Stands (MDS-3C, MDS-6, MDS-8C,
MDS-10, MDS-20)



In the interest of product improvement, the specifications and/or appearance of this unit are subject to change without prior notice.

Information

When you need repair service, call your nearest Roland Service Center or authorized Roland distributor in your country as shown below.

AFRICA

EGYPT

Al Fanny Trading Office
9, EBN Hagar A1 Askalany Street,
ARD E1 Golf, Heliopolis,
Cairo 11341, EGYPT
TEL: 20-2-417-1828

REUNION

Maison FO - YAM Marcel
25 Rue Jules Hermann,
Chaudron - BP79 97 491
Ste Clotilde Cedex,
REUNION ISLAND
TEL: (0262) 218-429

SOUTH AFRICA

**That Other Music Shop
(PTY) Ltd.**
11 Melle St., Braamfontein,
Johannesburg, SOUTH AFRICA
P.O.Box 32918, Braamfontein 2017
Johannesburg, SOUTH AFRICA
TEL: (011) 403-4105

Paul Bothner (PTY) Ltd.
17 Werdmuller Centre,
Main Road, Claremont 7708
SOUTH AFRICA

P.O.BOX 23032, Claremont 7735,
SOUTH AFRICA
TEL: (021) 674-4030

ASIA

CHINA

**Roland Shanghai Electronics
Co., Ltd.**
5F, No.1500 Pingliang Road
Shanghai 200090, CHINA
TEL: (021) 5580-0800

**Roland Shanghai Electronics
Co., Ltd.**
(BEIJING OFFICE)
10F, No.18 Anhuaxili
Chaoyang District, Beijing 100011
CHINA
TEL: (010) 6426-5050

**Roland Shanghai Electronics
Co., Ltd.**
(GUANGZHOU OFFICE)
2/F, No.30 Si You Nan Er Jie Yi
Xiang, Wu Yang Xin Cheng,
Guangzhou 510600, CHINA
Tel: (020) 8736-0428

HONG KONG

Tom Lee Music Co., Ltd.
Service Division
22-32 Fun Shan Street, Tsuen
Wan, New Territories,
HONG KONG
TEL: 2415 0911

Parsons Music Ltd.
8th Floor, Railway Plaza, 39
Chatham Road South, T.S.T.,
Kowloon, HONG KONG
TEL: 2333 1863

INDIA

Rivera Digitec (India) Pvt. Ltd.
409, Nirman Kendra Mahalaxmi
Flats Compound Off. Dr. Edwin
Moses Road, Mumbai-400011,
INDIA
TEL: (022) 2493 9051

INDONESIA

PT Citra Inti Rama
Jl. Cideng Timur No. 15J-150
Jakarta Pusat
INDONESIA
TEL: (021) 63241170

KOREA

Cosmos Corporation
1461-9, Seocho-Dong,
Seocho Ku, Seoul, KOREA
TEL: (02) 3486-8855

MALAYSIA

BENTLEY MUSIC SDN BHD
140 & 142, Jalan Bukit Bintang
55100 Kuala Lumpur, MALAYSIA
TEL: (03) 2144-3333

PHILIPPINES

G.A. Yupangco & Co. Inc.
339 Gil J. Puyat Avenue
Makati, Metro Manila 1200,
PHILIPPINES
TEL: (02) 899 9801

SINGAPORE

Sweet Lee Company
150 Sims Drive,
SINGAPORE 387381
TEL: 6846-3676

CRISTOFORI MUSIC PTE LTD

Blk 3014, Bedok Industrial Park E,
#02-2148, SINGAPORE 489980
TEL: 6243-9555

TAIWAN

**ROLAND TAIWAN
ENTERPRISE CO., LTD.**
Room 5, 9th. No. 112 Chung Shan
N.Road Sec.2, Taipei, TAIWAN,
R.O.C.
TEL: (02) 2561 3339

THAILAND

Theera Music Co., Ltd.
330 Veeng NakhomKasem, Soi 2,
Bangkok 10100, THAILAND
TEL: (02) 2248821

VIETNAM

Saigon Music
Suite DP-8
40 Ba Huyen Thanh Quan Street
Hochiminh City, VIETNAM
Tel: (08) 930-1969

AUSTRALIA/ NEW ZEALAND

AUSTRALIA

**Roland Corporation
Australia Pty., Ltd.**
38 Campbell Avenue
Dee Why West. NSW 2099
AUSTRALIA
TEL: (02) 9982 8266

NEW ZEALAND

Roland Corporation Ltd.
32 Shaddock Street, Mount Eden,
Auckland, NEW ZEALAND
TEL: (09) 3098 715

CENTRAL/LATIN AMERICA

ARGENTINA

Instrumentos Musicales S.A.
Av.Santa Fe 2055
(1123) Buenos Aires
ARGENTINA
TEL: (011) 4508-2700

BRAZIL

Roland Brasil Ltda
Rua San Jose, 780 Sala B
Parque Industrial San Jose
Cofia - Sao Paulo - SP, BRAZIL
TEL: (011) 4615 5666

COSTA RICA

**JUAN BANSBACH
Instrumentos Musicales**
Ave.1, Calle 11, Apartado 10237,
San Jose, COSTA RICA
TEL: 258-0211

CHILE

Comercial Fancy II S.A.
Rut.: 96.919.420-1
Nataniele Cox #739, 4th Floor
Santiago - Centro, CHILE
TEL: (02) 688-9540

EL SALVADOR

OMNI MUSIC
75 Avenida Norte y Final
Alameda Juan Pablo II,
Edificio No.4010 San Salvador,
EL SALVADOR
TEL: 262-0788

MEXICO

Casa Veerkamp, s.a. de c.v.
Av. Toluca No. 323, Col. Olivar
de los Padres 01780 Mexico D.F.
MEXICO
TEL: (55) 5668-6699

PANAMA

SUPRO MUNDIAL, S.A.
Boulevard Andrews, Albrook,
Panama City, REP. DE PANAMA
TEL: 315-0101

PARAGUAY

**Distribuidora De
Instrumentos Musicales**
J.E. Olear y ESQ. Manduvira
Asuncion PARAGUAY
TEL: (021) 492-124

URUGUAY

Todo Musica S.A.
Francisco Acuna de Figueroa 1771
C.P.: 11.800
Montevideo, URUGUAY
TEL: (02) 924-2335

VENEZUELA

Musicaland Digital C.A.
Av. Francisco de Miranda,
Centro Parque de Cristal, Nivel
C2 Local 20 Caracas
VENEZUELA
TEL: (212) 285-8586

EUROPE

AUSTRIA

Roland Austria GES.M.B.H.
Siemensstrasse 4, P.O. Box 74,
A-6063 RUM, AUSTRIA
TEL: (0512) 26 44 260

BELGIUM/HOLLAND/ LUXEMBOURG

Roland Benelux N. V.
Houtstraat 3, B-2260, Oevel
(Westerlo) BELGIUM
TEL: (014) 575811

CZECH REP.

K-AUDIO
Kardasovska 626,
CZ-198 00 Praha 9,
CZECH REP.
TEL: (2) 666 10529

DENMARK

Roland Scandinavia A/S
Nordhavnsvej 7, Postbox 880,
DK-2100 Copenhagen
DENMARK
TEL: 3916 6200

FRANCE

Roland France SA
4, Rue Paul Henri SPAAK,
Parc de l'Esplanade, F 77 462 St.
Thibault, Lagny Cedex FRANCE
TEL: 01 600 73 500

FINLAND

**Roland Scandinavia As,
Filial Finland**
Elannontie 5
FIN-01510 Vantaa, FINLAND
TEL: (09) 68 24 020

GERMANY

**Roland Elektronische
Musikinstrumente HmbH.**
Oststrasse 96, 22844 Norderstedt,
GERMANY
TEL: (040) 52 60090

GREECE

STOLLAS S.A.
Music Sound Light
155, New National Road
Patras 26442, GREECE
TEL: 2610 435400

HUNGARY

Roland East Europe Ltd.
Warehouse Area 'DEPO' Pf.83
H-2046 Torokbalint, HUNGARY
TEL: (23) 511011

IRELAND

Roland Ireland
G2 Calmount Park, Calmount
Avenue, Dublin 12
Republic of IRELAND
TEL: (01) 4294444

ITALY

Roland Italy S. p. A.
Viale delle Industrie 8,
20020 Arese, Milano, ITALY
TEL: (02) 937-78300

NORWAY

**Roland Scandinavia Avd.
Kontor Norge**
Lilleakerveien 2 Postboks 95
Lilleaker N-0216 Oslo
NORWAY
TEL: 2273 0074

POLAND

MX MUSIC SP.Z.O.O.
Ul. Gibraltarska 4,
PL-03664 Warszawa POLAND
TEL: (022) 679 44 19

PORTUGAL

**Tecnologias Musica e Audio,
Roland Portugal, S.A.**
Cais Das Pedras, 8/9-1 Dto
4050-465 PORTO
PORTUGAL
TEL: (022) 608 00 60

ROMANIA

FBS LINES
Piata Libertatii 1,
535500 Gheorgheni, ROMANIA
TEL: (266) 364 609

RUSSIA

MuTek
3-Bogatyrskaya Str. 1.k.1
107 564 Moscow, RUSSIA
TEL: (095) 169 5043

SPAIN

**Roland Electronics
de España, S. A.**
Calle Bolivia 239, 08020
Barcelona, SPAIN
TEL: (93) 308 1000

SWEDEN

**Roland Scandinavia A/S
SWEDISH SALES OFFICE**
Danvik Center 28, 2 tr.
S-131 30 Nacka SWEDEN
TEL: (08) 702 00 20

SWITZERLAND

Roland (Switzerland) AG
Landstrasse 5, Postfach,
CH-4452 Ittingen,
SWITZERLAND
TEL: (061) 927-8383

UKRAINE

TIC-TAC
Mira Str. 19/108
P.O. Box 180
295400 Munkachevo, UKRAINE
TEL: (03131) 414-40

UNITED KINGDOM

Roland (U.K.) Ltd.
Atlantic Close, Swansea
Enterprise Park, SWANSEA
SA7 9FJ,
UNITED KINGDOM
TEL: (01792) 702701

MIDDLE EAST

BAHRAIN

Moon Stores
No.16, Bab Al Bahrain Avenue,
P.O.Box 247, Manama 304,
State of BAHRAIN
TEL: 211 005

CYPRUS

Radex Sound Equipment Ltd.
17, Diagorou Street, Nicosia,
CYPRUS
TEL: (022) 66-9426

IRAN

MOCO, INC.
No.41 Nike St., Dr.Shariyati Ave.,
Roberoye Cerahe Mirdamad
Tehran, IRAN
TEL: (021) 285-4169

ISRAEL

**Halilit P. Greenspoon &
Sons Ltd.**
8 Reizif Ha'aliya Hashnya St.
Tel-Aviv-Yafo ISRAEL
TEL: (03) 6823666

JORDAN

AMMAN Trading Agency
245 Prince Mohammad St.,
Amman 1118, JORDAN
TEL: (06) 464-1200

KUWAIT

Easa Husain Al Yousifi Est.
Abdullah Salem Street,
Safat, KUWAIT
TEL: 243-6399

LEBANON

Chahine S.A.L.
Gerge Zeidan St., Chahine Bldg.,
Achrafieh, P.O.Box: 16-5857
Beirut, LEBANON
TEL: (01) 20-1441

QATAR

**Al Emadi Co. (Badie Studio &
Stores)**
P.O. Box 62, Doha, QATAR
TEL: 4423-554

SAUDI ARABIA

**aDawlah Universal
Electronics APL**
Corniche Road, Aldossary Bldg.,
1st Floor, Alkhobar,
SAUDI ARABIA

P.O.Box 2154, Alkhobar 31952
SAUDI ARABIA
TEL: (03) 898 2081

SYRIA

**Technical Light & Sound
Center**
Khaled Ebn Al Walid St.
Bldg. No. 47, P.O. BOX 13520,
Damascus, SYRIA
TEL: (011) 223-5384

TURKEY

**Ant Muzik Aletleri Ithalat
Ve Ihracat Ltd Sti**
Siraselviler Caddesi Siraselviler
Pasaji No:74/20
Taksim - Istanbul, TURKEY
TEL: (0212) 2499324

U.A.E.

**Zak Electronics & Musical
Instruments Co. L.L.C.**
Zabeel Road, Al Sherooq Bldg.,
No. 14, Grand Floor, Dubai, U.A.E.
TEL: (04) 3360715

NORTH AMERICA

CANADA

**Roland Canada Music Ltd.
(Head Office)**
5480 Parkwood Way Richmond
B. C., V6V 2M4 CANADA
TEL: (604) 270 6626

Roland Canada Music Ltd. (Toronto Office)

170 Admiral Boulevard
Mississauga On L5T 2N6
CANADA
TEL: (905) 362 9707

U. S. A.

Roland Corporation U.S.
5100 S. Eastern Avenue
Los Angeles, CA 90040-2938,
U. S. A.
TEL: (323) 890 3700

As of November 1, 2003 (Roland)

Roland Corporation