

 Roland

MIDI **OCTAPAD**

PAD-8

Owner's Manual

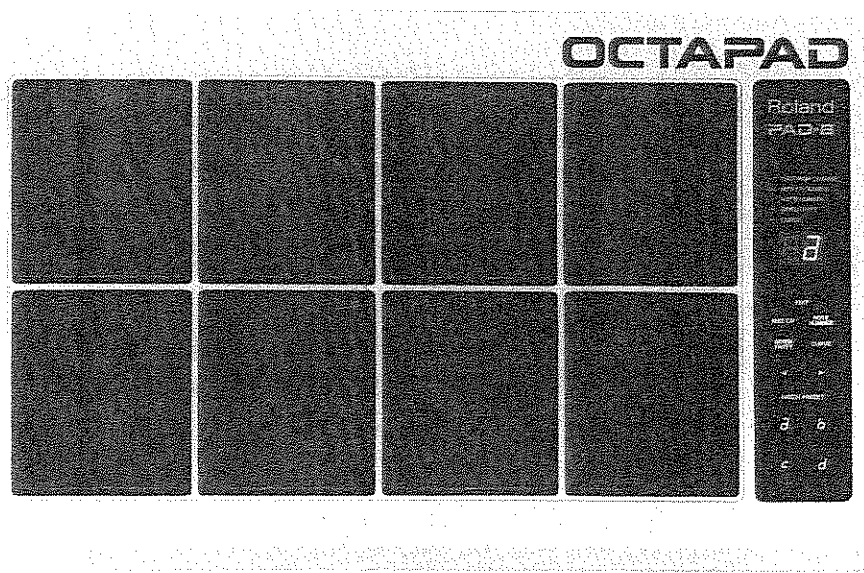

Contents

1	PANEL DESCRIPTION	3
2	OUTLINE	5
3	BASIC CONNECTION	6
4	USING THE TR-909, TR-707 OR TR-727	7
5	OPERATION	10
1.	Setting MIDI Channels	10
2.	Assigning a sound source to each pad	11
3.	Editing Other Parameters	12
4.	Patch Preset	14
5.	Individual Edit	15
6	OTHER USEFUL FUNCTIONS	16
1.	Program Change	16
2.	Adding External Pads	18
3.	MIDI IN	18
7	SPECIFICATIONS	20

Important

- This unit might not work properly if turned on immediately after turned off. If this happens, simply turn it off and turn it on again in a few seconds later.
- This unit might get hot while operating, but there is no need to worry about it.
- Be sure to use the supplied AC Adaptor. Using any other adaptor may cause trouble. Do not use the supplied adaptor with any other device, either.
- Do not switch the unit on without the AC Adaptor connected.
- Operating the PAD-8 near a neon or fluorescent lamp may cause noise interference. If so, change the angle of the unit.
- Avoid using the unit in excessive heat or humidity or where it may be affected by direct sunlight or dust.
- Use a soft cloth and clean only with mild detergent.
- Do not use solvents such as paint thinner.

Battery Backup

The PAD-8 features battery backup system that retains the data in memory even when turned off. This is fully supported by a battery which is to last more than 5 years, but it depends on how many months had been passed before it was purchased. Also, please have your local Roland dealer do the job.

Before reading this owner's manual, please read the separate book "MIDI".

Copyright © 1985 by ROLAND CORPORATION

All rights reserved. No part of this publication may be reproduced in any form without the written permission of ROLAND CORPORATION.

1 PANEL DESCRIPTION

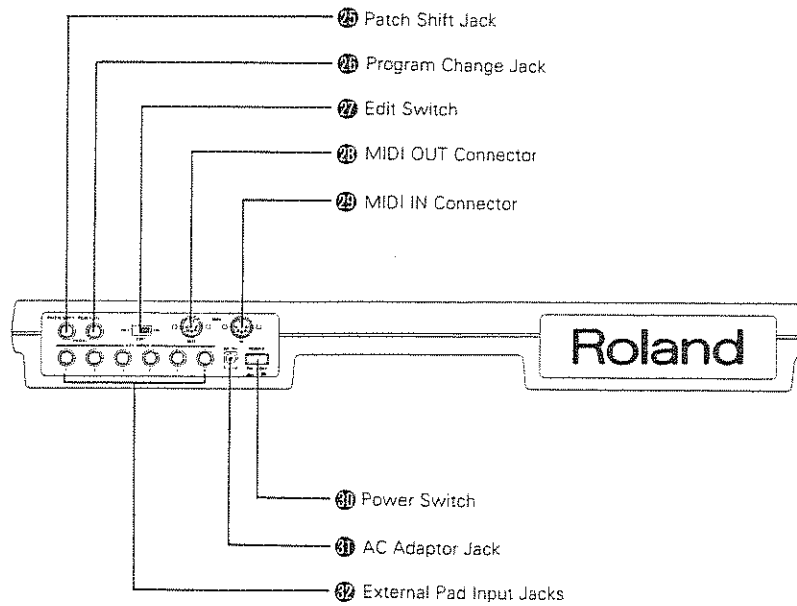
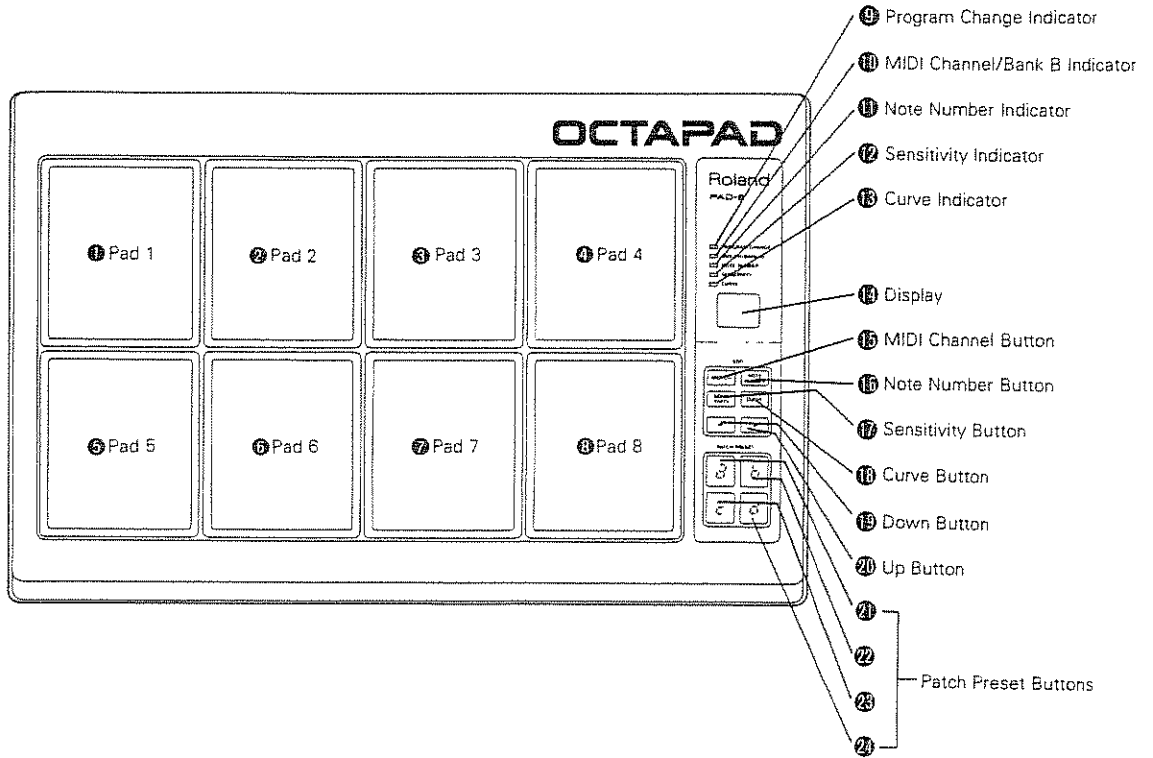

Radio and television interference

"Warning — This equipment has been verified to comply with the limits for a Class B computing device, pursuant to Subpart J, of Part 15, of FCC rules. Operation with non-certified or non-verified equipment is likely to result in interference to radio and TV reception."

The equipment described in this manual generates and uses radio-frequency energy. If it is not installed and used properly, that is, in strict accordance with our instructions, it may cause interference with radio and television reception.

This equipment has been tested and found to comply with the limits for a Class B computing device in accordance with the specifications in Subpart J, of Part 15, of FCC Rules. These rules are designed to provide reasonable protection against such an interference in a residential installation.

However, there is no guarantee that the interference will not occur in a particular installation. If this equipment does cause interference to radio or television reception, which can be determined by turning the equipment on and off, the user is encouraged to try to correct the interference by the following measure:

- Disconnect other devices and their input/output cables one at a time. If the interference stops, it is caused by either the other device or its I/O cable.

These devices usually require Roland designated shielded I/O cables. For Roland devices, you can obtain the proper shielded cable from your dealer. For non Roland devices, contact the manufacturer or dealer for assistance.

If your equipment does cause interference to radio or television reception, you can try to correct the interference by using one or more of the following measures:

- Turn the TV or radio antenna until the interference stops.
- Move the equipment to one side or the other of the TV or radio.
- Move the equipment farther away from the TV or radio.
- Plug the equipment into an outlet that is on a different circuit than the TV or radio. (That is, make certain the equipment and the radio or television set are on circuits controlled by different circuit breakers or fuses.)
- Consider installing a rooftop television antenna with coaxial cable lead-in between the antenna and TV.

If necessary, you should consult your dealer or an experienced radio/television technician for additional suggestions. You may find helpful the following booklet prepared by the Federal Communications Commission:

"How to Identify and Resolve Radio-TV Interference Problems"

This booklet is available from the U.S. Government Printing Office, Washington, D.C., 20402, Stock No. 004-000-00345-4.

Bescheinigung des Herstellers /Importeurs
Hiermit wird bescheinigt, daß der/die/das
ROLAND DRUM PAD PAD-8
<small>(Gerat. Typ. Bezeichnung)</small>
in Übereinstimmung mit den Bestimmungen der
Amtsbl. Vfg 1046 / 1984
<small>(Amtsblattverfügung)</small>
funk-entstört ist.
Der Deutschen Bundespost wurde das Inverkehrbringen dieses Gerätes angezeigt und die Berechtigung zur Überprüfung der Serie auf Einhaltung der Bestimmungen eingeräumt.
Roland Corporation Osaka / Japan
<small>Name des Herstellers/Importeurs</small>

2 OUTLINE

The PAD-8 Octapad is a dynamically sensitive MIDI compatible eight-pad controller with memory. Any MIDI sound sources from synthesizers to drum machines can be assigned to any of the eight pads. Parameters such as MIDI channel and Sensitivity are adjustable for each pad. Up to four different patches can be memorized with the Patch Preset function.

Program Change messages can also be sent from the PAD-8. In addition to the eight pads, six inputs are provided for expansion to using other external pad controllers.

If you have completed setting up the PAD-8 and a sound module, go to the following steps.

- a. Set the MIDI channels of both units to the same numbers.**

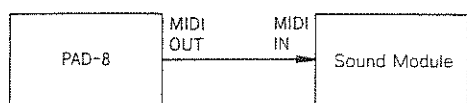

MIDI Transmit Channel — MIDI Receive channel

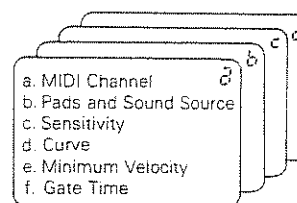

- b. Assign a sound source you like to each pad of the PAD-8.**

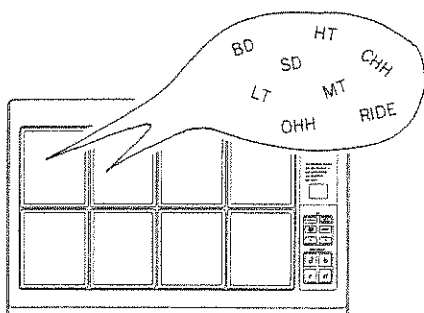

Parameter "b" is always set for each pad, but regarding other parameters, it is optional whether one value is used for all pads (Edit), or different values are used for each pad (Individual Edit).

		Pad							
		1	2	3	4	5	6	7	8
Parameter	a	(One for all pads)							
	b								
	c	(One for all pads)							
	d	(")							
	e	(")							
	f	(")							

Edit Mode

		Pad							
		1	2	3	4	5	6	7	8
a									
b									
c									
d									
e									
f									

Individual Edit Mode

Now, you can play the pads. If you wish to change the nuance of the sound, adjust the following parameters in each pad:

- c. Sensitivity of each pad**
- d. Curve (of the volume altered by the hitting strength)**
- e. Minimum Velocity (Minimum Volume)**
- f. Gate Time (How long a note lasts)**

Up to four different settings of the parameters "a" to "f" (4 Patch Presets) can be memorized and instantly recalled at any time you like. This Patch Preset function is extremely useful for when using various sound modules at a time, or using different sound sources within one module.

* When using TR-707, TR-909 or TR-727, however, the above procedures can be replaced with much simpler action of "Initialization".

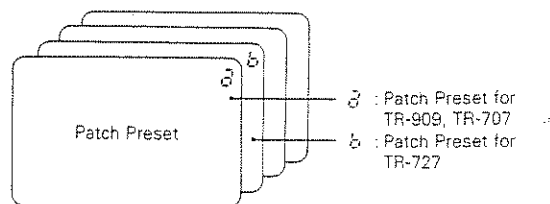

3 BASIC CONNECTION

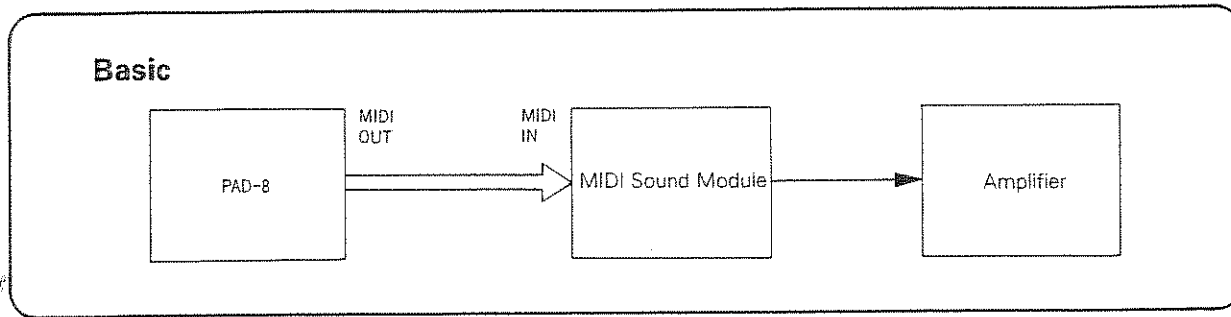

● Setup with a Rhythm Machine

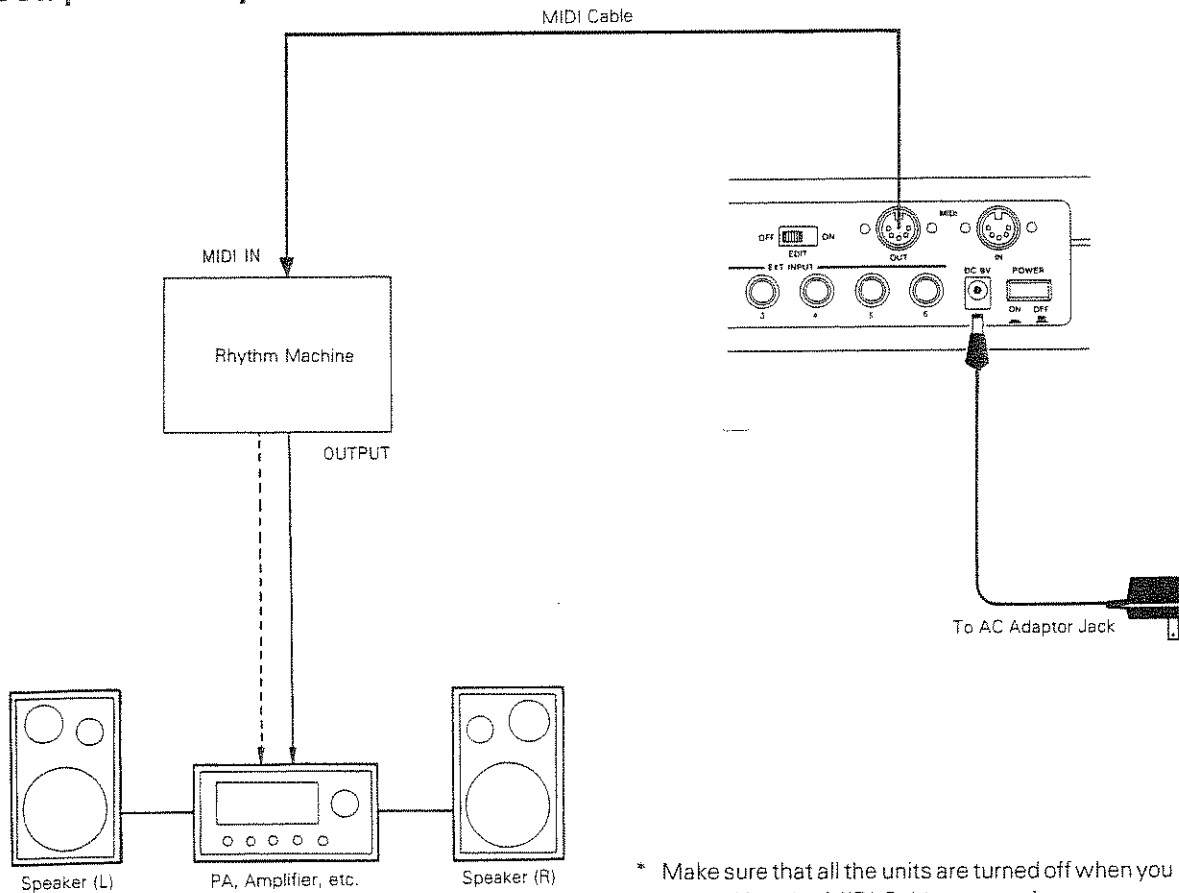

* Make sure that all the units are turned off when you are making the MIDI Cable connection.

4 USING THE TR-909, TR-707 OR TR-727

When using the TR-909, TR-707 or TR-727 as sound sources of the PAD-8, you can make the system ready to be played by taking the following simple operation. (This is called "Initialization".)

OPERATION

① Initialize the PAD-8.

Switch the PAD-8 on while holding down both the MIDI Channel Button (1) and the Note Number Button (2). Then turn the unit off.

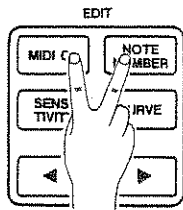

While holding these buttons down,

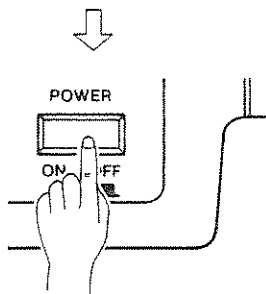

Switch on!

* In a few seconds, the PAD-8 is initialized and the Display shows "0".

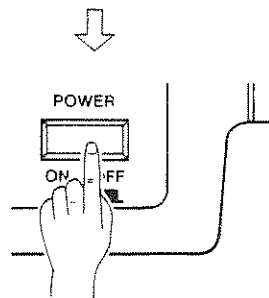

Switch Off!

② Initialize the rhythm machine TR-707/727.

As instructed in the owner's manual of the rhythm machine on page 43 and 44, set it to OMNI ON mode and initialize it.

* The TR-909 will be automatically initialized when switched on.

③ Select the Patch Preset you like on the PAD-8

Turn the PAD-8 on. Make sure that the Edit Switch (3) is set to the OFF position, then push the Patch Preset Button (4) (5 on the TR-727).



TR-707, 909
PATCH PRESET

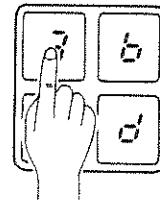

TR-727
PATCH PRESET

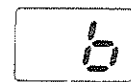
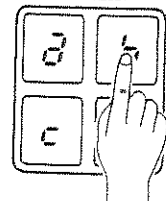

* The Display (6) will show "a" ("b" on the TR-727).

Now, playing the pads will output the sound sources of the rhythm machine.

TR-707/909 (Patch Preset **d**)

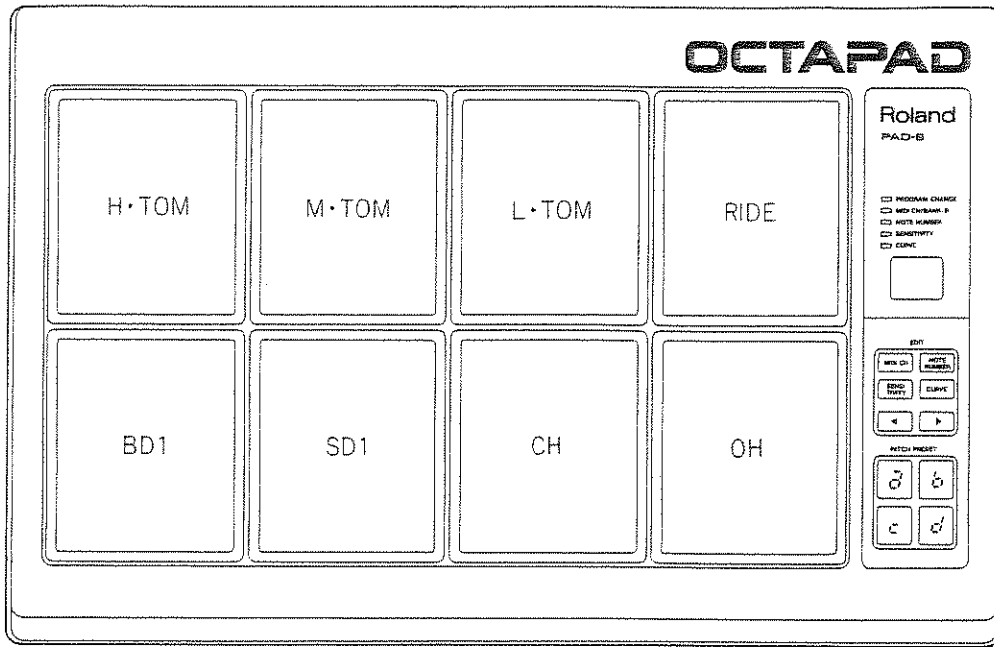

TR-727 (Patch Preset **b**)

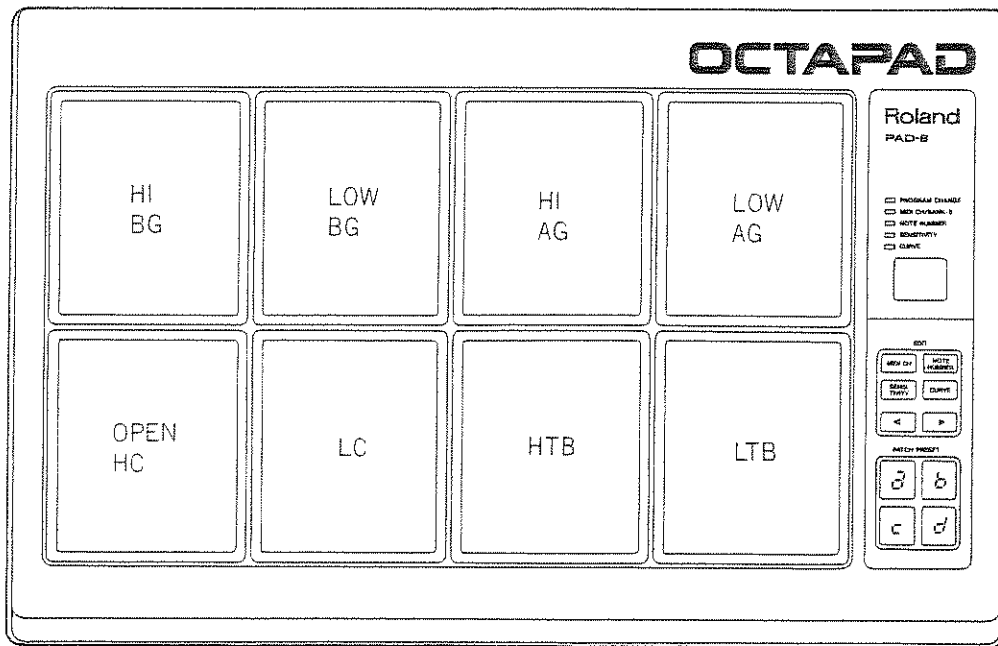

■ How to change the combinations of the Note Numbers and sound sources

By changing the combinations of the Note Numbers and the sound sources, hitting the same pad will output a different sound source.

OPERATION

- ① Set the Edit Switch  on the rear panel of the PAD-8 to the ON position.



* The Display  will flash.

- ② Push the Note Number Button .

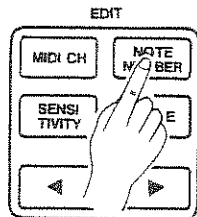

- ③ Slightly hard hit the pad whose sound source you wish to change.

- ④ Assign the Note Number (0 to 99) of the relevant sound source by using the Up Button and the Down button .

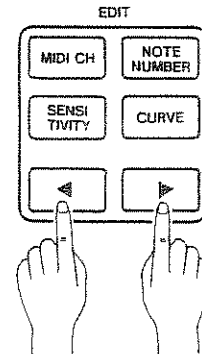

* If you cannot remember the correct Note Number, keep playing the same pad as the step ③ and call the sound source one by one by using the Up and the Down Buttons until you find the one you like.

- ⑤ If you wish to change the sounds of other pads, repeat the steps ③ and ④ as many times as necessary.

- ⑥ Set the Edit Switch  to the OFF position.



The PAD-8 features 5 more parameters which are adjustable for each pad. See the following section "⑤ Operation".

5 OPERATION

The PAD-8 is compatible with any sound module as well as the rhythm machines and the drum modules. The 6 parameters which are adjustable for each pad are;

- a. **MIDI channels**
- b. **Assignment of a sound source to each pad.**
- c. **Sensitivity of each pad.**
- d. **Curve (of the volume altered by hitting strength)**
- e. **Minimum Velocity (Minimum volume)**
- f. **Gate Time (How long a note lasts)**

Except for when using the TR-707, 727 and 909, the parameters "a" and "b" should be first set properly.

In this section, we explain how to set or change all the 6 parameters. We call this mode of adjusting the parameters "Edit mode" in this manual. The mode for playing the pads is called "Play mode". These Play and Edit modes can be selected with the Edit Switch ⑫ which is located on the rear panel. When this switch is set to the ON position, the Edit mode is selected and the Display flashes.

* In this section, however, the PAD-8 is setup with a single sound module. If you wish to know how to use several modules at a time, go to the next section "4. Patch Preset".

1. Setting MIDI Channels

(Set the Edit Switch to ON)

Take the following operation to match the transmit channel of the PAD-8 and the receive channel of the sound module.

* When the sound module is set to the OMNI ON, omit this operation.

OPERATION

- ① Push the MIDI Channel Button ⑩.

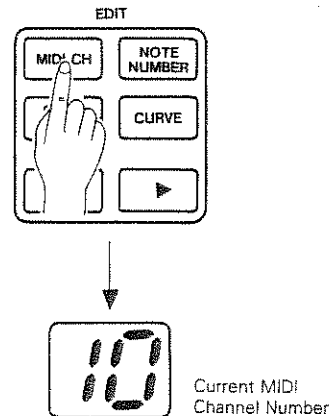

* The MIDI Channel Indicator ⑪ will light up, and the Display ⑬ will show the current MIDI channel number.

- ② With the aid of the Display, set a new MIDI Channel by pressing the Up Button ⑭ or Down Button ⑮.

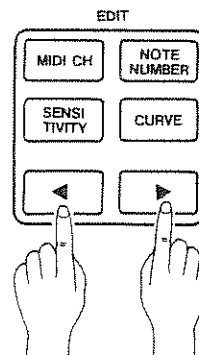

2. Assigning a sound source to each pad

(Set the Edit Switch to ON.)

A different sound source can be assigned to each pad. Each sound source has a MIDI Note Number which can be effectively used to simplify the assigning operation.

OPERATION

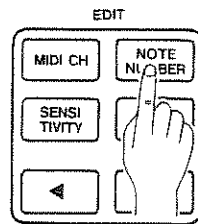

- ① Push the Note Number Button .

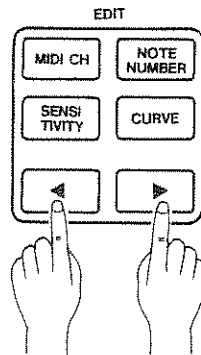

- ② Slightly hard hit the pad whose sound source you wish to change.

* In the Edit mode, the sensitivity of the pad is purposely lowered for security, so hit the pad hard enough.



- ③ Assign the Note Number (0 to 99) of the relevant sound source by using the Up Button  and the Down Button .

* If you cannot remember the correct Note Number, keep playing the same pad as the step ② and call the sound source one by one by using the Up and the Down Buttons until you find the one you like.

- ④ If you wish to change the sounds for other pads, repeat the steps ② and ③ as many times as necessary.

3. Editing other parameters

(Set the Edit Switch to ON.)

There are some more parameters adjustable;

c. Sensitivity of each pad

Increasing the value will emphasize the sensitivity.

d. Curve (of the volume altered by hitting strength)

This changes the curve which determines how the volume alters by the strength of hitting.

e. Minimum Velocity (Minimum volume)

This sets the minimum volume which is obtained when the pad is hit most gently.

f. Gate Time (How long a sound lasts)

When using a synthesizer as a sound module, sustained sound can be obtained. This sets the time the sound stays at its sustain level.

The above parameters change the nuance of the performance. Try adjusting them as you actually play the pads.

OPERATION

- ① Push the button of the parameter you wish to adjust.

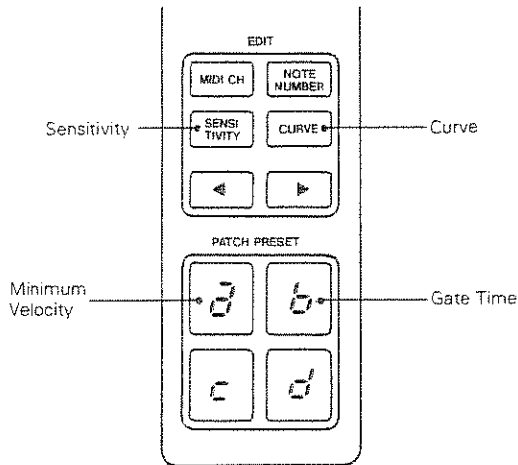

- * The corresponding indicator lights up and the Display shows the current value of the selected parameter.

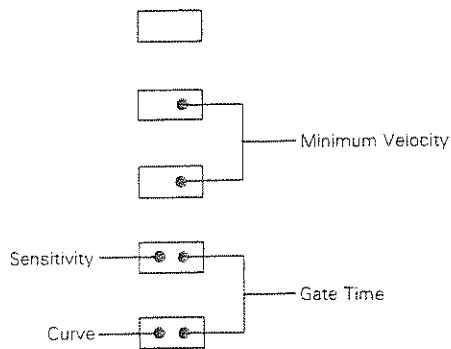

- ② As you play the pad, set a new value by using the Up Button and the Down Button.

Parameter	Variable Range	Standard Value
c. Sensitivity	1 to 16	8
d. Curve	0 to 5	3
e. Minimum Velocity	0 to 64	0
f. Gate Time	1 to 60	10

Skip Function

You may want to forward or back up the value of the parameter quicker. The Skip value is, however, different in each parameter. (See page 13.)

Pressing while holding down

- Increase the parameter value as much as the set Skip value

Pressing while holding down

- Decrease the parameter value as much as the set Skip value

Operation Table

Parameter	Operation (In Edit Mode)	Value Range	Skip Value	Indicator which lights up.
MIDI Channel	Push the MIDI Channel Button 15 .	1 thru 16	4	11
Note Number	Push the Note Number Button 16 .	0 thru 99	12	11
Sensitivity	Push the Sensitivity Button 17 .	1 thru 16	4	12
Curve	Push the Curve Button 18 .	1 thru 5	2	13
Minimum Velocity	Push the Patch Preset Button 20 .	0 thru 64	4	10 and 14
Gate Time	Push the Patch Preset Button 20 .	1 thru 60	10	12 and 14

4. Patch Preset

Up to four different settings of the parameters set in "1. to 3." in this section "Operation" can be memorized and instantly recalled at any time you like simply by pressing the Patch Preset Buttons \bar{a} to \bar{d} (① to ④). This Patch Preset function is extremely useful for when using various sound modules at a time, or using different sound sources within one module.

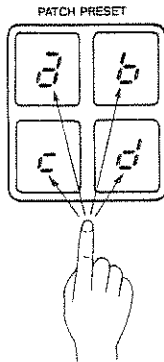

Calling a patch preset can be done in the Play mode, therefore, to edit the patch preset other than \bar{a} , first call the patch preset you like in the Play mode, then change to the Edit mode (set the Edit Switch ⑤ to ON position.)

a. Changing the Sound Source

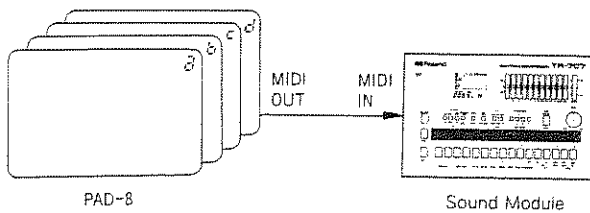

b. Changing the System

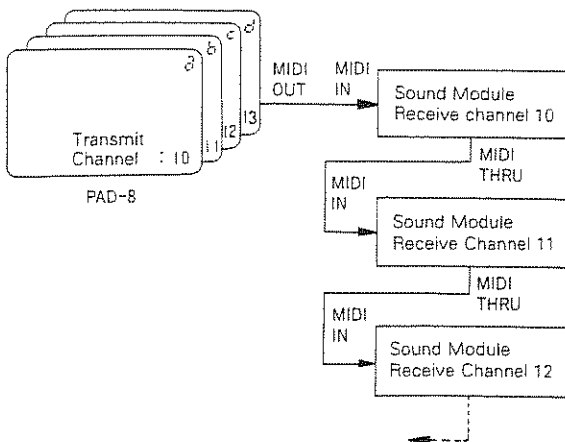

Patch Shift Function

By connecting the optional pedal switch DP-2 to the Patch Shift Jack ⑥ on the rear panel, the four Patch Presets can be sequentially called by depressing the pedal, like a → b → c → d → a → b

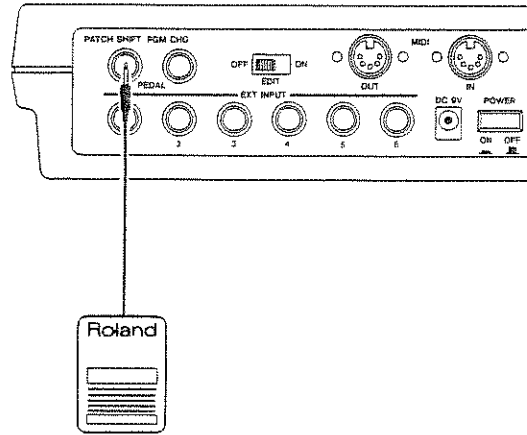

Pedal Switch DP-2
(Optional)

5. Individual Edit

So far, except for "Sound Source (Note Number) Assignment", we have set one value of each parameter for all the pads. It is, however, also possible to set a different value individually for each pad.

OPERATION

- ① Press the MIDI Channel Button , make sure that the Display shows glowing *id*, then without releasing the button, set the Edit Switch to the ON position.

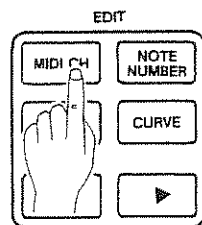

While holding the button down.

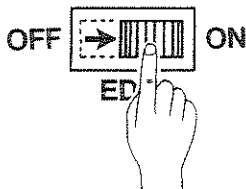

Set the Edit Switch to the ON position.

* The Display flashes quickly showing now it is in the Individual Edit mode.

- ② Adjust the parameter in the exactly same way as "Assigning a sound source to each pad". (See page11.)

6 Other Useful Functions

1. Program Change

MIDI Program Change can be used to change the sounds of a sound module such as programmable synthesizers.

OPERATION (First set to the Play mode)

Connect the optional pedal switch DP-2 to the Program Change Jack (16) on the rear panel.

① By using the Program Change Number Table shown in the owner's manual of the sound module, find out the program change number of the patch program you want to send from the PAD-8 to the sound module. Then using the table below, find out the Bank Group, Bank Number and Patch Number corresponding to the program change number.

② Depress the pedal (and do not release it until the step ④ is completed.)

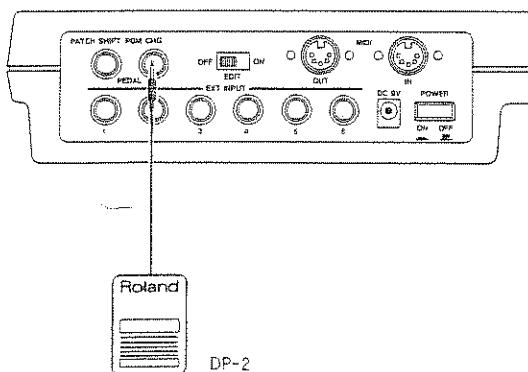

* The Program Change Indicator (17) lights up and the Display (18) shows the Bank number (left figure) and Patch number (right figure) previously transmitted. When it is in the Bank Group B, the Bank B Indicator (19) will light up.

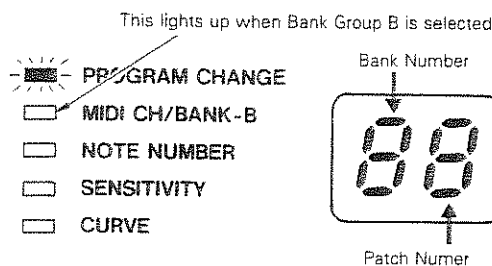

③ By using the Up Button (20) and the Down Button (21), set the new Bank Group and the Bank number you have found in the step ①.

Bank	Operation	Indication	Program Change Numbers
A	1	18	0 ~ 7
	2	28	8 ~ 15
	3	38	16 ~ 23
	4	48	24 ~ 31
	5	58	32 ~ 39
	6	68	40 ~ 47
	7	78	48 ~ 55
	8	88	56 ~ 63
B	1	18	64 ~ 71
	2	28	72 ~ 79
	3	38	80 ~ 87
	4	48	88 ~ 95
	5	58	96 ~ 103
	6	68	104 ~ 111
	7	78	112 ~ 119
	8	88	120 ~ 127

Bank Group A

Bank \ Patch	1	2	3	4	5	6	7	8
1	0	1	2	3	4	5	6	7
2	8	9	10	11	12	13	14	15
3	16	17	18	19	20	21	22	23
4	24	25	26	27	28	29	30	31
5	32	33	34	35	36	37	38	39
6	40	41	42	43	44	45	46	47
7	48	49	50	51	52	53	54	55
8	56	57	58	59	60	61	62	63

Bank Group B

Bank \ Patch	1	2	3	4	5	6	7	8
1	64	65	66	67	68	69	70	71
2	72	73	74	75	76	77	78	79
3	80	81	82	83	84	85	86	87
4	88	89	90	91	92	93	94	95
5	96	97	98	99	100	101	102	103
6	104	105	106	107	108	109	110	111
7	112	113	114	115	116	117	118	119
8	120	121	122	123	124	125	126	127

- ④ Slightly hard, hit the Pad that corresponds to the Patch number which you have found in the step ①.

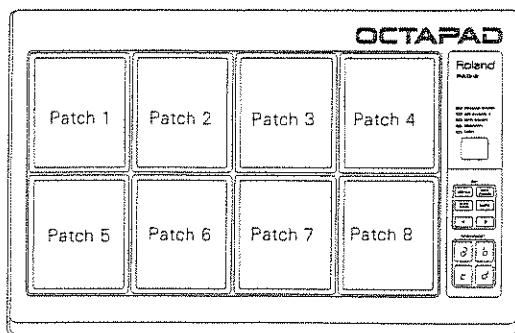

- * Now, the relevant Program Change message is transmitted, changing the sounds of the sound module. The Display ⑩ now shows the Bank and Patch numbers. When it is in the Bank Group B, the indicator ⑪ lights up.

- ⑤ Release the pedal.

- * The Display ⑩ is now returned to the Patch Preset display.

When using external pads

The external pads 1 to 6 correspond to the Patch numbers 1 to 6. In other words, the Patch numbers 1 to 6 can be assigned by both the PAD-8's pads and external pads.

NOTE

- * If the Program Change does not function properly, check if the MIDI Channels of the transmitter and the receiver are set to the same number. Also, make sure that the sound module does not select the mode that ignores the program change messages.
- * When the Patch Preset is programmed in the Individual Edit mode, each Pad may have a different MIDI Channel number. Program Change messages from the PAD-8 are transmitted on one MIDI Channel, so, before taking the operation for Program Change, you have to set an appropriate MIDI Channel on which the Program Change is transmitted.

How to set the MIDI Channel on which the Program Change is transmitted

- ① Change to the Edit mode (set the Edit Switch ⑦ to ON).
 - * The Display ⑩ flashes.
- ② Depress the Program Change pedal.
 - * The Program Change Indicator ⑨ will light up and the Display ⑩ will show the number of the MIDI transmit channel.
- ③ As you watch the Display ⑩, set the new channel number by pushing the Up Button ⑫ and the Down Button ⑬.
- ④ Change to the Play mode (set the Edit Switch ⑦ to OFF).

2. Adding External Pads

Use the optional pads PD-10 and PD-20 to extend the pads. These external pads can be used in exactly the same way as the PAD-8's pads.

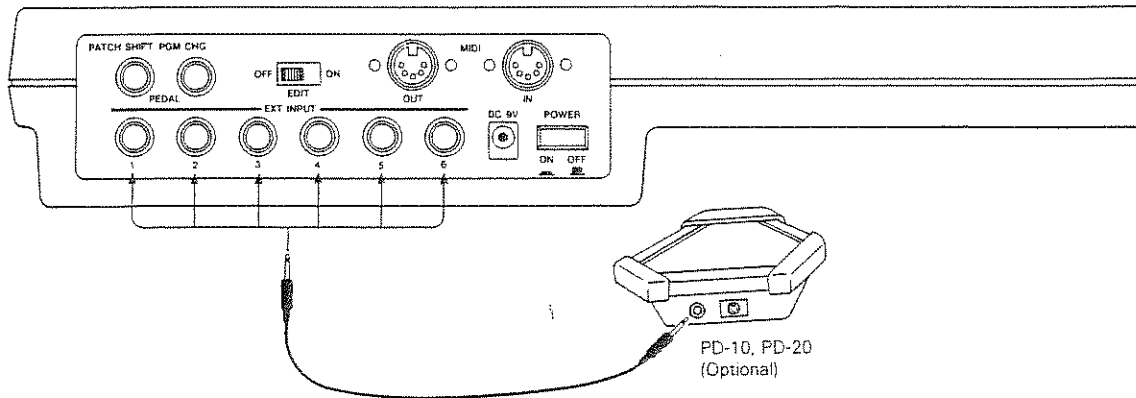



3. MIDI IN

The MIDI messages received at MIDI IN is mixed with the MIDI messages produced in the PAD-8 and the mixed messages are sent from MIDI OUT.

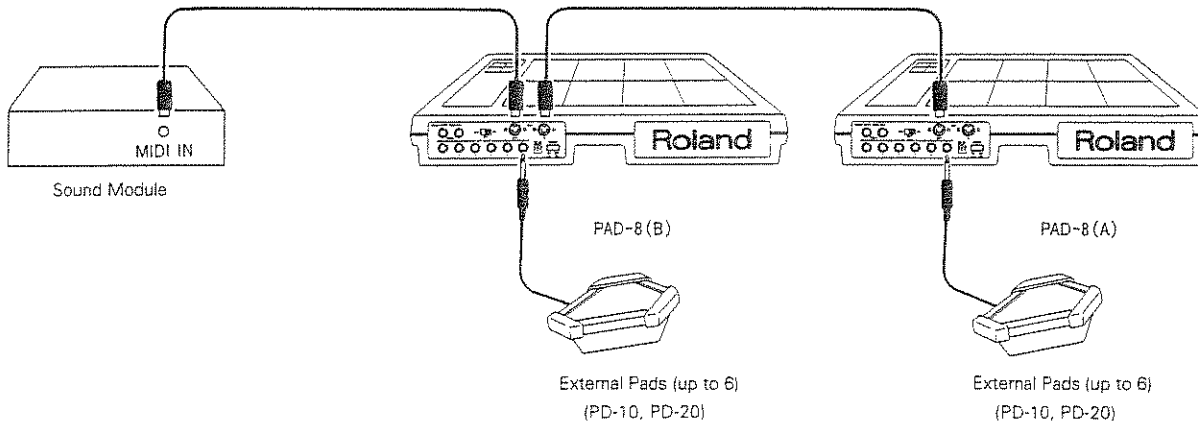
This MIDI IN Connector can be useful for when using two PAD-8's.



* When MIDI IN Connector is used and the Display  shows  for more than 10 seconds, turn all units off then turn them on again.

● Setting Memo

● Patch Preset

	MIDI CH	NOTE NUMBER								SENS	CURVE	MINIMUM VELOCITY	GATE TIME
		1	2	3	4	5	6	7	8				
	<i>d</i>												
	<i>b</i>												
	<i>c</i>												
	<i>d'</i>												

● Individual Edit

	MIDI	NOTE	SENS	CURVE	VELO	G. TIME
1						
2						
3						
4						
5						
6						
7						
8						

	MIDI	NOTE	SENS	CURVE	VELO	G. TIME
1						
2						
3						
4						
5						
6						
7						
8						

	MIDI	NOTE	SENS	CURVE	VELO	G. TIME
1						
2						
3						
4						
5						
6						
7						
8						

	MIDI	NOTE	SENS	CURVE	VELO	G. TIME
1						
2						
3						
4						
5						
6						
7						
8						

6 SPECIFICATIONS

OCTAPAD: PAD-8

Pad: 8

External Pad (Optional): 6

Patch Preset: 4 (*a, b, c, d*)

Parameter

MIDI Channel
Note Number
Sensitivity
Curve
Minimum Velocity
Gate Time

Control Section

Edit Switch
MIDI Channel Button
Note Number Button
Sensitivity Button
Curve Button
Down Button
Up Button
Patch Preset Button (*a, b, c, d*)
Power Switch
Indicator (X5)

Display: 7 segment 2 figures

Connectors

External Pad Input Jacks (X6)
(Input Impedance: 1.5k Ω)
Program Change Jack
Patch Shift Jack
AC Adaptor Jack
MIDI IN Connector
MIDI OUT Connector

Dimensions: 520(W) X 330(D) X 60(H) mm
20-1/2" X 13" X 2-3/8"

Consumption: 4.5W

Weight: 4kg/8 lb 13 oz

Accessories: AC Adaptor (specific for PAD-8)
MIDI Cable

OPTION: External Pads
PD-10 (Bass Drum Pad)
PD-20 (Snare/Tom Pads)
Pedal Switch
DP-2
All Purpose Clamp Set
APC-66

Function.....		Transmitted	Recognized	Remarks
Basic Channel	Default	1 - 16	×	Memorized
	Changed	1 - 16	×	
Mode	Default	Mode 3	×	
	Messages		×	
	Altered	*****	×	
Note Number		0 - 99	×	
	True voice	*****	×	
Velocity	Note ON	○ 9nh, V=10 - 127	×	
	Note OFF	× 9nh, V=0	×	
After Touch	Key's	×	×	
	Ch's	×	×	
Pitch Bender		×	×	
Control Change		×	×	
Prog Change		0 - 127	×	
	True #	*****		
System Exclusive		×	×	
System Common	Song Pos	×	×	
	Song Sel	×	×	
	Tune	×	×	
System Real Time	Clock	×	×	
	Commands	×	×	
Aux Messages	Local ON/OFF	×	×	
	All Notes OFF	×	×	
	Active Sense	×	×	
	Reset	×	×	
Notes				

Mode 1 : OMNI ON, POLY

Mode 2 : OMNI ON, MONO

○ : Yes

Mode 3 : OMNI OFF, POLY

Mode 4 : OMNI OFF, MONO

× : No

Pad controllor

MODEL PAD-8 MIDI Implementation

1. TRANSMITTED DATA

Status	Second	Third	Description
1001 nnnn	0kkk kkkk	0000 0000	Note Off Event 0kkk kkkk = 0 - 99 *1 *2
1001 nnnn	0kkk kkkk	0vvv vvvv	Note On Event 0kkk kkkk = 0 - 99 0vvv vvvv = 10 - 127
1100 nnnn	0ppp pppp		Program Change 0ppp pppp = 0 - 127 *3

- Notes: *1 Transmitted channel can be changed to 1 - 16 by the front pannel
- *2 Each pad-surface can be set to different channel
- *3 Program numbers are assigned as follows

GROUP A

BANK	NUMBER	1	2	3	4	5	6	7	8
1	0	1	2	3	4	5	6	7	
2	8	9	10	11	12	13	14	15	
3	16	17	18	19	20	21	22	23	
4	24	25	26	27	28	29	30	31	
5	32	33	34	35	36	37	38	39	
6	40	41	42	43	44	45	46	47	
7	48	49	50	51	52	53	54	55	
8	56	57	58	59	60	61	62	63	

GROUP B

BANK	NUMBER	1	2	3	4	5	6	7	8
1	64	65	66	67	68	69	70	71	
2	72	73	74	75	76	77	78	79	
3	80	81	82	83	84	85	86	87	
4	88	89	90	91	92	93	94	95	
5	96	97	98	99	100	101	102	103	
6	104	105	106	107	108	109	110	111	
7	112	113	114	115	116	117	118	119	
8	120	121	122	123	124	125	126	127	

 Roland®

10672

UPC 10672



1099:

PA-D-B

 Roland