

Roland®



MT 300s

MUSIC PLAYER

OWNER'S MANUAL

Before using this unit, carefully read the sections entitled: "IMPORTANT SAFETY INSTRUCTIONS" (p. 2), "USING THE UNIT SAFELY" (p. 3), and "IMPORTANT NOTES" (p. 4).

These sections provide important information concerning the proper operation of the unit. Additionally, in order to feel assured that you have gained a good grasp of every feature provided by your new unit, Owner's manual should be read in its entirety. The manual should be saved and kept on hand as a convenient reference.

Copyright © 1998 ROLAND CORPORATION
All rights reserved. No part of this publication may be reproduced in any form without the written permission of ROLAND CORPORATION.



This product complies with the requirements of European Directives EMC 89/336/EEC and LVD 73/23/EEC.

For EU Countries

FEDERAL COMMUNICATIONS COMMISSION RADIO FREQUENCY INTERFERENCE STATEMENT

This equipment has been tested and found to comply with the limits for a Class B digital device, pursuant to Part 15 of the FCC Rules. These limits are designed to provide reasonable protection against harmful interference in a residential installation. This equipment generates, uses, and can radiate radio frequency energy and, if not installed and used in accordance with the instructions, may cause harmful interference to radio communications. However, there is no guarantee that interference will not occur in a particular installation. If this equipment does cause harmful interference to radio or television reception, which can be determined by turning the equipment off and on, the user is encouraged to try to correct the interference by one or more of the following measures:

- Reorient or relocate the receiving antenna.
- Increase the separation between the equipment and receiver.
- Connect the equipment into an outlet on a circuit different from that to which the receiver is connected.
- Consult the dealer or an experienced radio/TV technician for help.

Unauthorized changes or modification to this system can void the users authority to operate this equipment.
This equipment requires shielded interface cables in order to meet FCC class B Limit.

For the USA

NOTICE

This Class B digital apparatus meets all requirements of the Canadian Interference-Causing Equipment Regulations.

AVIS

Cet appareil numérique de la classe B respecte toutes les exigences du Règlement sur le matériel brouilleur du Canada.

For Canada

USING THE UNIT SAFELY

INSTRUCTIONS FOR THE PREVENTION OF FIRE, ELECTRIC SHOCK, OR INJURY TO PERSONS

About ⚠ WARNING and ⚠ CAUTION Notices







⚠ WARNING	Used for instructions intended to alert the user to the risk of death or severe injury should the unit be used improperly.
⚠ CAUTION	Used for instructions intended to alert the user to the risk of injury or material damage should the unit be used improperly. * Material damage refers to damage or other adverse effects caused with respect to the home and all its furnishings, as well to domestic animals or pets.

About the Symbols







⚠	The ⚠ symbol alerts the user to important instructions or warnings. The specific meaning of the symbol is determined by the design contained within the triangle. In the case of the symbol at left, it is used for general cautions, warnings, or alerts to danger.
⊘	The ⊘ symbol alerts the user to items that must never be carried out (are forbidden). The specific thing that must not be done is indicated by the design contained within the circle. In the case of the symbol at left, it means that the unit must never be disassembled.
⦿	The ⦿ symbol alerts the user to things that must be carried out. The specific thing that must be done is indicated by the design contained within the circle. In the case of the symbol at left, it means that the power-cord plug must be unplugged from the outlet.

ALWAYS OBSERVE THE FOLLOWING

⚠ WARNING

- Before using this unit, make sure to read the instructions below, and the Owner's Manual. 
- Do not open or perform any internal modifications on the unit. 
- Do not attempt to repair the unit, or replace parts within it (except when this manual provides specific instructions directing you to do so). Refer all servicing to your retailer, the nearest Roland Service Center, or an authorized Roland distributor, as listed on the "Information" page. 
- Never use or store the unit in places that are:
 - Subject to temperature extremes (e.g., direct sunlight in an enclosed vehicle, near a heating duct, on top of heat-generating equipment); or are
 - Damp (e.g., baths, washrooms, on wet floors); or are
 - Humid; or are
 - Exposed to rain; or are
 - Dusty; or are
 - Subject to high levels of vibration.
- Make sure you always have the unit placed so it is level and sure to remain stable. Never place it on stands that could wobble, or on inclined surfaces. 
- The unit should be connected to a power supply only of the type described in the operating instructions, or as marked on the rear side of unit. 
- Use only the attached power-supply cord. 
- Do not excessively twist or bend the power cord, nor place heavy objects on it. Doing so can damage the cord, producing severed elements and short circuits. Damaged cords are fire and shock hazards! 









⚠ WARNING

- This unit, either alone or in combination with an amplifier and headphones or speakers, may be capable of producing sound levels that could cause permanent hearing loss. Do not operate for a long period of time at a high volume level, or at a level that is uncomfortable. If you experience any hearing loss or ringing in the ears, you should immediately stop using the unit, and consult an audiologist. 
- Do not allow any objects (e.g., flammable material, coins, pins); or liquids of any kind (water, soft drinks, etc.) to penetrate the unit. 

- Immediately turn the power off, remove the power cord from the outlet, and request servicing by your retailer, the nearest Roland Service Center, or an authorized Roland distributor, as listed on the "Information" page when:
 - The AC adaptor, the power-supply cord, or the plug has been damaged; or
 - If smoke or unusual odor occurs
 - Objects have fallen into, or liquid has been spilled onto the unit; or
 - The unit has been exposed to rain (or otherwise has become wet); or
 - The unit does not appear to operate normally or exhibits a marked change in performance.
- In households with small children, an adult should provide supervision until the child is capable of following all the rules essential for the safe operation of the unit. 
- Protect the unit from strong impact. (Do not drop it!) 
- Do not force the unit's power-supply cord to share an outlet with an unreasonable number of other devices. Be especially careful when using extension cords—the total power used by all devices you have connected to the extension cord's outlet must never exceed the power rating (watts/amperes) for the extension cord. Excessive loads can cause the insulation on the cord to heat up and eventually melt through. 
- Before using the unit in a foreign country, consult with your retailer, the nearest Roland Service Center, or an authorized Roland distributor, as listed on the "Information" page. 

⚠ WARNING

- Do not put anything that contains water (e.g., flower vases) on this unit. Also, avoid the use of insecticides, perfumes, alcohol, nail polish, spray cans, etc., near the unit. Swiftly wipe away any liquid that spills on the unit using a dry, soft cloth. 

⚠ CAUTION

- The unit should be located so that its location or position does not interfere with its proper ventilation. 
- Always grasp only the plug on the power-supply cord when plugging into, or unplugging from, an outlet or this unit. 
- At regular intervals, you should unplug the power plug and clean it by using a dry cloth to wipe all dust and other accumulations away from its prongs. Also, disconnect the power plug from the power outlet whenever the unit is to remain unused for an extended period of time. Any accumulation of dust between the power plug and the power outlet can result in poor insulation and lead to fire. 
- Try to prevent cords and cables from becoming entangled. Also, all cords and cables should be placed so they are out of the reach of children. 
- Never climb on top of, nor place heavy objects on the unit. 
- Never handle the power cord or its plugs with wet hands when plugging into, or unplugging from, an outlet or this unit. 
- Before moving the unit, disconnect the power plug from the outlet, and pull out all cords from external devices. 
- Before cleaning the unit, turn off the power and unplug the power cord from the outlet (p. 18). 
- Whenever you suspect the possibility of lightning in your area, pull the plug on the power cord out of the outlet. 

In addition to the items listed under "IMPORTANT SAFETY INSTRUCTIONS" and "USING THE UNIT SAFELY" on pages 2 and 3, please read and observe the following:

Power Supply

- Do not use this unit on the same power circuit with any device that will generate line noise (such as an electric motor or variable lighting system).
- Before connecting this unit to other devices, turn off the power to all units. This will help prevent malfunctions and/or damage to speakers or other devices.
- Although the LCD and LEDs are switched off when the POWER switch is switched off, this does not mean that the unit has been completely disconnected from the source of power. If you need to turn off the power completely, first turn off the POWER switch, then unplug the power cord from the power outlet. For this reason, the outlet into which you choose to connect the power cord's plug should be one that is within easy reach.

Placement

- Using the unit near power amplifiers (or other equipment containing large power transformers) may induce hum. To alleviate the problem, change the orientation of this unit; or move it farther away from the source of interference.
- This device may interfere with radio and television reception. Do not use this device in the vicinity of such receivers.
- Observe the following when using the unit's floppy disk drive. For further details, refer to "Before Using Floppy Disks" (p. 5).
 - Do not place the unit near devices that produce a strong magnetic field (e.g., loudspeakers).
 - Install the unit on a solid, level surface.
 - Do not move the unit or subject it to vibration while the drive is operating.
- Do not expose the unit to direct sunlight, place it near devices that radiate heat, leave it inside an enclosed vehicle, or otherwise subject it to temperature extremes. Excessive heat can deform or discolor the unit.
- To avoid possible breakdown, do not use the unit in a wet area, such as an area exposed to rain or other moisture.

Maintenance

- For everyday cleaning wipe the unit with a soft, dry cloth or one that has been slightly dampened with water. To remove stubborn dirt, use a cloth impreg-

nated with a mild, non-abrasive detergent. Afterwards, be sure to wipe the unit thoroughly with a soft, dry cloth.

- Never use benzine, thinners, alcohol or solvents of any kind, to avoid the possibility of discoloration and/or deformation.

Additional Precautions

- Unfortunately, it may be impossible to restore the contents of data that was stored on a floppy disk once it has been lost. Roland Corporation assumes no liability concerning such loss of data.
- Use a reasonable amount of care when using the unit's buttons, sliders, or other controls; and when using its jacks and connectors. Rough handling can lead to malfunctions.
- Never strike or apply strong pressure to the display.
- When connecting / disconnecting all cables, grasp the connector itself—never pull on the cable. This way you will avoid causing shorts, or damage to the cable's internal elements.
- A small amount of heat will radiate from the unit during normal operation.
- To avoid disturbing your neighbors, try to keep the unit's volume at reasonable levels. You may prefer to use headphones, so you do not need to be concerned about those around you (especially when it is late at night).
- When you need to transport the unit, package it in the box (including padding) that it came in, if possible. Otherwise, you will need to use equivalent packaging materials.
- Use a cable from Roland to make the connection. If using some other make of connection cable, please note the following precautions.
 - Some connection cables contain resistors. Do not use cables that incorporate resistors for connecting to this unit. The use of such cables can cause the sound level to be extremely low, or impossible to hear. For information on cable specifications, contact the manufacturer of the cable.

* GS () is a registered trademark of Roland Corporation.

* Apple is a registered trademark of Apple Computer, Inc.

* Macintosh is a registered trademark of Apple Computer, Inc.

* IBM PC is a registered trademark of International Business Machines Corporation.

Handling the Floppy Disk Drive

- Install the unit on a solid, level surface in an area free from vibration. If the unit must be installed at an angle, be sure the installation does not exceed the permissible range.
- Avoid using the unit immediately after it has been moved to a location with a level of humidity that is greatly different than its former location. Rapid changes in the environment can cause condensation to form inside the drive, which will adversely affect the operation of the drive and/or damage floppy disks. When the unit has been moved, allow it to become accustomed to the new environment (allow a few hours) before operating it.
- To insert a disk, push it gently but firmly into the drive—it will click into place. To remove a disk, press the EJECT button firmly. Do not use excessive force to remove a disk which is lodged in the drive.
- Never attempt to remove a floppy disk from the drive while the drive is operating (the indicator is brightly lit); damage could result to both the disk and the drive.
- Remove any disk from the drive before powering up or down.
- To prevent damage to the disk drive's heads, always try to hold the floppy disk in a level position (not tilted in any direction) while inserting it into the drive. Push it in firmly, but gently. Never use excessive force.
- To avoid the risk of malfunction and/or damage, insert only floppy disks into the disk drive. Never insert any other type of disk. Avoid getting paper clips, coins, or any other foreign objects inside the drive.

Handling Floppy Disks

- Floppy disks contain a plastic disk with a thin coating of magnetic storage medium. Microscopic precision is required to enable storage of large amounts of data on such a small surface area. To preserve their integrity, please observe the following when handling floppy disks:
 - Never touch the magnetic medium inside the disk.
 - Do not use or store floppy disks in dirty or dusty areas.
 - Do not subject floppy disks to temperature extremes (e.g., direct sunlight in an enclosed vehicle). Recommended temperature range: 10 to 50° C (50 to 122° F).
 - Do not expose floppy disks to strong magnetic fields, such as those generated by loudspeakers.

- Floppy disks have a “write protect” tab which can protect the disk from accidental erasure. It is recommended that the tab be kept in the PROTECT position, and moved to the WRITE position only when you wish to write new data onto the disk.

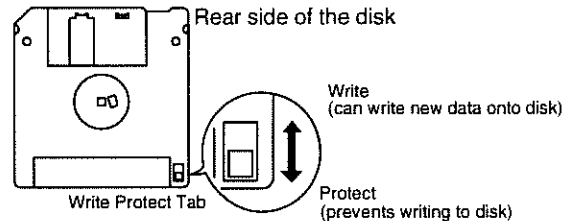

- The identification label should be firmly affixed to the disk. Should the label come loose while the disk is in the drive, it may be difficult to remove the disk.
- Store all disks in a safe place to avoid damaging them, and to protect them from dust, dirt, and other hazards. By using a dirty or dust-ridden disk, you risk damaging the disk, as well as causing the disk drive to malfunction.
- Disks containing performance data for this unit should always be locked (have their write protect tab slid to the “Protect” position) before you insert them into the drive on some other unit (except the PR-300, or a product in the HP-G, MT, KR, or Atelier families), or into a computer’s drive. Otherwise (if the write protect tab remains in the “Write” position), when you perform any disk operations using the other device’s disk drive (such as checking the contents of the disk, or loading data), you risk rendering the disk unreadable by this unit’s disk drive.

- Button names, such as the **[Song]** button or the **Reset [⏮]** button, are enclosed in square brackets [].
- The three possible states of button indicators—on, off, or blinking—are illustrated as follows:

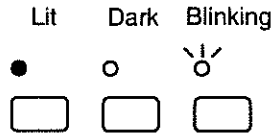

You can also enjoy using the MT 300s along with acoustic instruments. The items related to this in Chapters 1 through 6, that you will need to read are preceded by “★” in the Table of Contents.



... savor a great piece of music!



... practice one hand at a time!



... You can play the piano with a band or orchestral accompaniment



...record your playing!
(When you connect to the electric piano)



You can play an acoustic instrument with an orchestral accompaniment.



... try singing some karaoke!

Check to see if you have all of the items that normally are supplied with the MT 300s.
If you find that something is missing, please contact the Roland dealer from whom
you purchased your MT 300s.

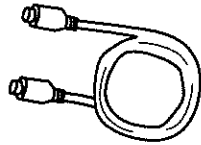

MIDI Cable (1)



Power Cord (1)

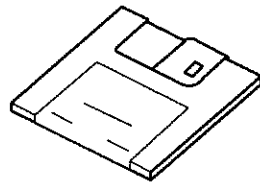

Music File Disk (1)

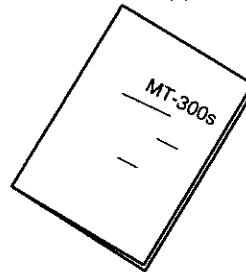

Owners Manual (1)

Using the Unit Safely	3
Important Notes	4
Before Using Floppy Disks	5
Introduction.....	6
Main Features of the MT 300s.....	11
Names of Things and What They Do: 1—The Front Panel	12
Names of Things and What They Do: 2—The Rear Panel	14
About the Display Screen.....	15

If You are Connecting an Electronic Keyboard ..16

Connection Procedure	16
Turning the Power On and Off	18
Adjusting the Volume.....	19
Tuning the MT 300s to Electronic Keyboards	19
Adding Reverberation to the Sound.....	20
Selecting Piano Sounds.....	21

If You are Using Acoustic Instruments ...23

Turning the Power On and Off	23
Adjusting the Volume.....	23
Matching your instrument to the pitch of the MT 300s	24

Chapter 1 Mastering the Basics.....25

How to Listen to Songs.....	25	★
Inserting and Removing Floppy Disks	25	
Starting and Stopping Songs	26	
To Play a Song Repeatedly	26	
Listening to All Songs Played Back Continuously.....	27	
Moving to a Desired Location in a Song.....	28	★
To Return to the Beginning of the Song	28	
To Go to the End of the Song.....	28	
Moving to Marked Locations	29	
Repeating the Same Part of a Song	31	★
Moving a Repeating Segment	32	
Changing the Song's Tempo.....	33	★
Setting the Tempo by Pressing the Button in Time (Tap Tempo).....	33	
Playing Without Tempo Changes (Tempo Mute)	34	
How to Transpose a Song	35	★
Sounding the Metronome	36	★
Practicing a Song	38	★
Synchronizing the Timing When You Come into a Song (Count In)	39	
Practicing the Right-Hand Part.....	39	
Practicing the Left-Hand Part.....	40	
Using Both Hands to Play Along with Accompaniment	40	

Try Recording Your Own Performance	41	
Recording Along with Songs.....	42	
Recording New Songs	45	
Deleting Sounds Recorded to Track Buttons	48	
Deleting Recorded Songs	48	
How to Save Songs.....	49	
Before Using Floppy Disks (Format).....	49	
Saving Songs to Floppy Disks	50	
Changing the Song Order on Floppy Disks	52	
Deleting Songs from Floppy Disks	53	
Performing Karaoke and Accompanying Yourself on the Keyboard.....	54	★

Chapter 2 Convenient Functions55

Getting Various Instruments Sounds from the Keyboard	55	
Listening to Songs after Changing Instrument Sounds or Making Other Changes	56	★
Changing the Basic Tempo of the Song	59	★
Preventing Only One Instrument from Being Played.....	60	★

Chapter 3 Recording Functions.....61

The MT 300s's Recording Functions.....	61	
Recording Ensemble Works.....	62	
Using the Ordinary Recording Process.....	67	
Recording by Layering Sounds	68	
Repeated Recording of the Same Segment	69	
Recording Certain Segments Over Again.....	70	
Recording Songs Starting with Pickups.....	73	
Creating Songs Featuring Tempo Changes	74	
Creating Songs Featuring Beat Changes.....	76	
Creating Rhythm Parts Easily	77	

Chapter 4 Editing Functions78

Undoing Edits	78	
Copying Measures.....	79	
Copying Rhythm Patterns.....	82	
Correcting Unvenness in the Rhythm (Quantize)	85	
Deleting Measures (Delete)	86	
Inserting Blank Measures (Insert)	87	
Erasing Measures (Erase)	88	
Transposing Parts Individually (Transpose)	90	
Exchanging Parts (Part Exchange)	91	
Making Revisions One Note at a Time (Note Edit).....	92	
Editing Tone Changes Within a Song (PC Edit)	93	

Chapter 5 Other Functions95 ★

Restoring the Original Settings	95	★
Changing the Metronome Settings	95	★
Changing the Count Sound Settings	96	★
Setting Markers Within Measures.....	97	★
Adding Various Effects to Sounds.....	97	★
Changing the Pedal Functions.....	98	★
Turnig off the Bouncing Ball.....	98	★
Turning Off the Display of Lyrics.....	99	★
Switching the Language on the Display Screen.....	99	★

Chapter 6 Connecting to MIDI Devices ... 100

About MIDI.....	100
Making MIDI Settings.....	100
About the MT 300s's Sound Generator	101
Selecting the Sound Generator	101
Converting MIDI Channels.....	102
Synchronizing with Connected MIDI Devices.....	102
Transmitting Synchronization Messages.....	103
Outputting Received MIDI Messages	103
Connecting to Computers	103
Troubleshooting.....	104
If You See This Screen Displayed	106
List of Tone Names.....	107
List of Rhythm Patterns	111
Music Files that can be Used with the MT 300s	112
Specifications.....	113
Optional Accessories.....	113
Glossary	114
Easy Operation List.....	115
MIDI Implementation Chart.....	116
Index.....	118

If You Are Using Acoustic Instruments

The items related to this in Chapters 1 through 6, that you will need to read are preceded by "★".

Thank you, and congratulations on your choice of the Roland MT 300s Music Player. You can use the MT 300s not only on its own; by connecting a digital piano, you'll have even more ways to play sounds.

What You Can Do with the MT 300s as a Stand-Alone Machine

Listen to music files

Using the built-in disk drive, you can listen to songs in a wide variety of musical genres formatted as music files (p.25).

Practice instruments

The MT 300s features a variety of convenient functions for changing song tempos (p.33), practicing each hand's part (p.38), playing back the same section of a song repeatedly (p.31), and other functions useful for playing songs.

Perform accompanied by orchestral backing from music files

You can mute specific parts contained in music files and play those parts yourself (p.38), or listen only to specific selected parts (p.60).

Enjoy karaoke

The MT 300s features a microphone input jack. You can also add echo, and change the key of the accompaniment (p.54).

NOTE

Your original performances using acoustic instruments cannot be recorded with the MT 300s.

What you can do with a digital piano connected:

Record your own performances

Just as with a regular tape recorder, you can record performances onto the five Track/TRACK buttons (p.41).

Create authentic ensemble pieces

With so many different recording and performance functions, creating your own songs is a snap (p.61, 78).

Save the songs you create to floppy disks, and then make and copy original song collections.

Using the built-in disk drive, you can save recorded songs (p.49).

Perform with various instrument sounds played from a connected keyboard.

The MT 300s includes an internal GS sound generator with a selection of over 300 sounds to choose from (p.55, 56).

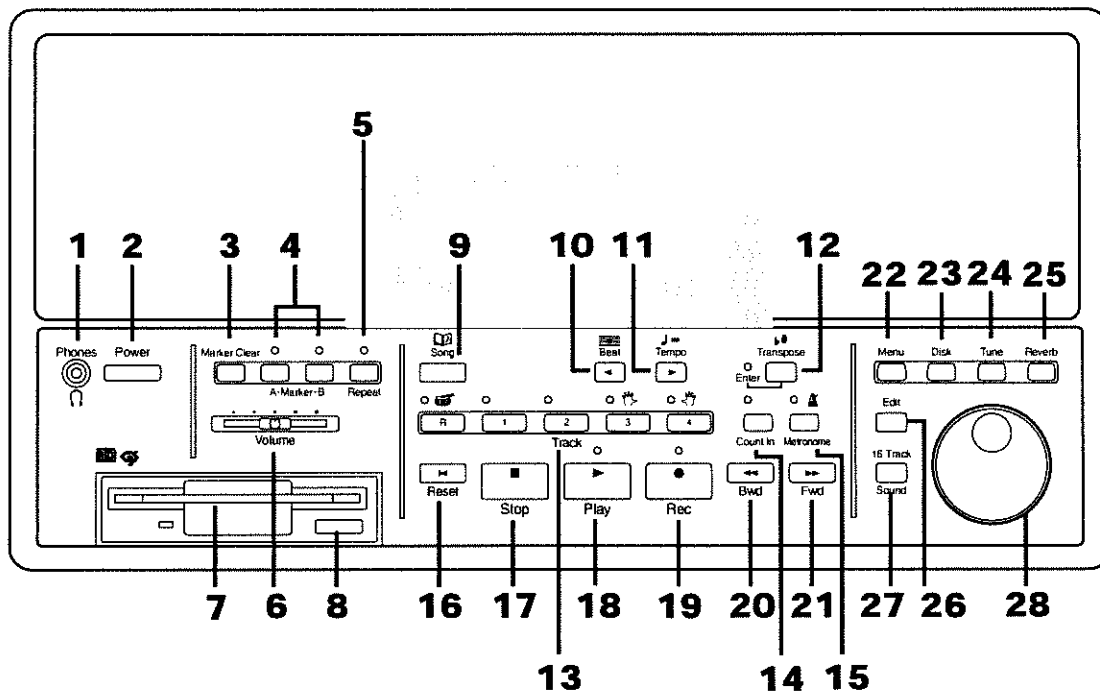

- | | |
|--|---|
| <p>1 Phones Jack
Headphones (sold separately) are connected here.</p> <p>2 Power Switch
Pressed to turn the power on and off (p.18).
When you turn on the power, the display back-light will light.</p> <p>3 [Marker Clear] Button
Pressed to delete markers (p.30).</p> <p>4 Marker [A] and [B] Buttons
Set Markers A and B within songs (p.29).</p> <p>5 [Repeat] Button
Pressed to have a marked section play back repeatedly (p.31).</p> <p>6 [Volume] Control
Adjusts the MT 300s's volume (p.19, 23).</p> <p>7 Disk Drive
Floppy disks are inserted here (p.25).</p> <p>8 Eject Button
Pressed to eject the floppy disk from the disk drive.</p> <p>9 [Song] Button
Pressed to select songs (p.26).
Returns you to the Basic screen (p.15).</p> | <p>10 Beat [◀] Button
Changes the beat (p.36).
Moves the cursor on the screen among the different beats, such as (▶) and (◄) (p.15).</p> <p>11 Tempo [▶] Button
Adjusts the tempo (p.33, p.37).
Moves the cursor on the screen among the different tempos, such as (▶) and (◄) (p.15).</p> <p>12 [Transpose] Button
Transposes (changes the key of) the song (p.35).
This button is also used to execute various other operations.</p> <p>13 Track Buttons
The five buttons labeled [R], [1], [2], [3], and [4] are called the Track buttons.
They are used for playing each instrument part individually (p.38), and for recording your own performances (p.41).</p> <p>14 [Count In] Button
When this button is pressed, a count sound plays before you begin playback or recording of a song (p.39).</p> <p>15 [Metronome] Button
Plays the internal metronome (p.36).</p> |
|--|---|

- 16 Reset [⏮] Button**
Returns you to the beginning of the current song (p.28).
- 17 Stop [■] Button**
Stops playback or recording of the song.
- 18 Play [▶] Button**
Begins playback or recording of the song.
- 19 Rec [●] Button**
Puts the keyboard in record standby mode (p.41).
- 20 Bwd [◀◀] Button**
"Rewinds," or takes you to an earlier point in the song (p.28).
- 21 Fwd [▶▶] Button**
Advances, or "fast-forwards" the song (p.28).
- 22 [Menu] Button**
Allows you to select from various functions, including recording functions.
- 23 [Disk] Button**
Pressed to save songs to (p.49), or delete songs from floppy disks (p.53).
- 24 [Tune] Button**
With this button you can adjust the keyboard's tuning (p.19, p.24).
- 25 [Reverb] Button**
Press this button to apply reverberation to the sound (p.20).
- 26 [Edit] Button**
Use this button in editing recorded songs (p.78).
- 27 [16 Track] Button**
You can select instrument sounds (p.55) and create ensemble pieces using this button (p.61).
- 28 [Dial]**
Changes the value of the item designated by the cursor on the screen, such as (▶) and (←).

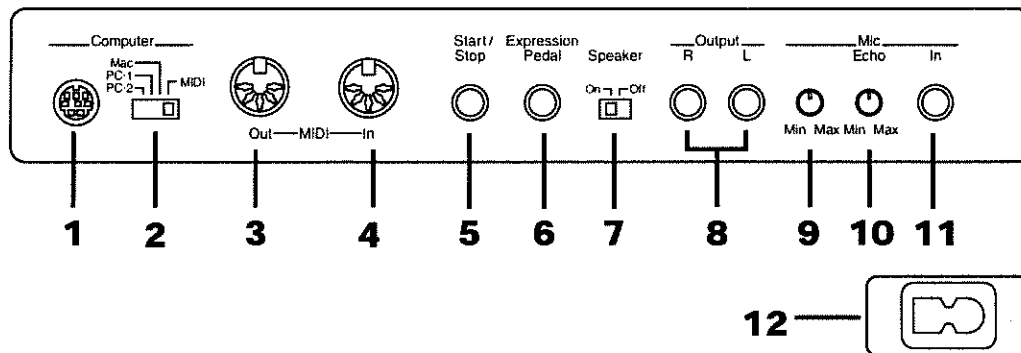

- 1 Computer Connector**
Use an optional computer cable to connect your computer here (p.103).
- 2 Computer Switch**
Selects whether the unit's MIDI In/Out connectors or the Computer connector are to be used. If using only audio or MIDI cables to connect with external devices, set the switch to "MIDI". If you are connecting with a computer, set the switch to "Mac", "PC-1", or "PC-2"; whichever is appropriate for the type of computer you have (p. 103).
When the computer switch is set to "MIDI", you will be unable to use the Computer connector. When the computer switch is set to "Mac", "PC-1", or "PC-2", all messages that arrive at the MIDI In connector will be sent to the computer, so you will be unable to use the MIDI Out connector.
- 3 MIDI Out Connector**
Using an optional MIDI cable, you can connect MIDI devices here.
- 4 MIDI In Connector**
You can connect external MIDI devices here using the MIDI cable included with the MT 300s (p.16).
- 5 Start/Stop Jack**
An optional pedal switch can be connected here (p.17).
- 6 Expression Pedal Jack**
An optional Expression Pedal can be connected here (p.17).
- 7 Speaker Switch**
Switches the sound from the MT 300s's speaker on and off.
- 8 Output R/L Jacks**
Using optional audio cables, you can connect external instruments such as digital pianos here (p.17).
- 9 Mic Volume Control**
Adjusts the volume of the microphone (p.54).
- 10 Mic Echo Control**
Adjusts the amount of echo applied to the sound from the mic (p.54).
- 11 Mic In Jack**
A microphone (optional) is connected here (p.54).
- 12 AC Inlet**
The power cord provided with the unit is connected here.

The Basic Screen

When the MT 300s's power is turned on, the following screen appears.

If a different screen appears, pressing the [Song] button or the Stop [■] button a number of times returns you to the basic screen.

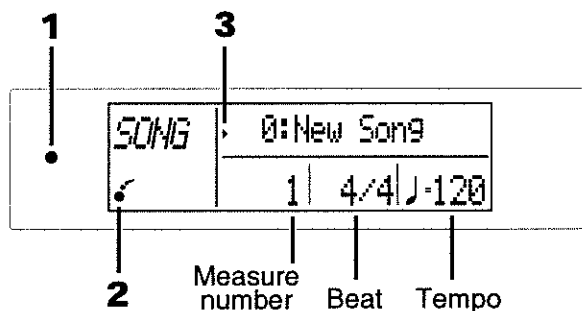

1 Beat Indicator

Flashes in time with the beat of the song or the Metronome.

2 Bouncing Ball

The "Bouncing Ball" is a ball-shaped icon that moves in time with the rhythm of the song or Metronome. By tracing a semicircular path as it moves from beat to beat, it conveys a better understanding of rhythm than that obtained through a mere series of dots, making it this a very useful feature.

3 Cursor

Symbols on the screen, including (▶) and (←), are known as cursors. You can move the cursors with the Beat [◀] button or Tempo [▶] button.

You can change the values for items with cursor at the beginning by using the [Dial].

MEMO

You can delete the bouncing ball. Refer to "Turning off the Bouncing Ball" (p.98).

MEMO

If messages starting with "E," such as "E.00" appears on the screen, refer to "If You See This Screen Displayed" (p.106).

Menu Screen

This screen appears when you press [Menu].

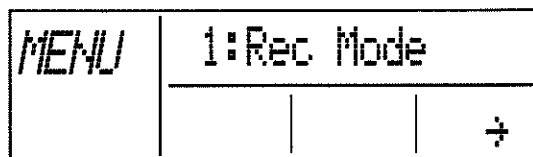

Disk Screen

This screen appears when you press [Disk].

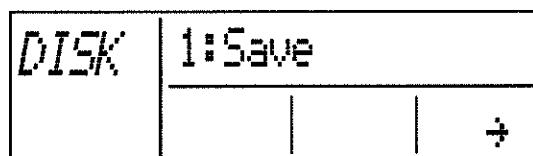

Edit Screen

This screen appears when you press [Edit].

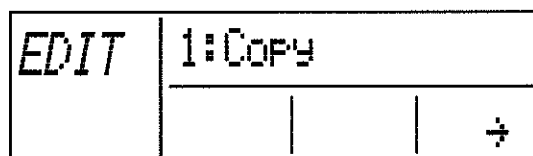

16-Track Screen

This screen appears when you press [16 Track].

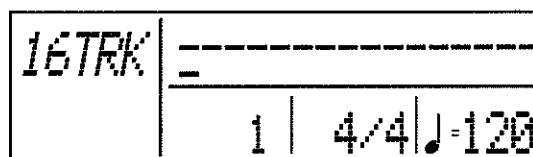

Read this section if you are using the MT 300s with a digital piano connected.

NOTE

If you are using the MT 300s along with acoustic instruments, please read p.23.

NOTE

To prevent malfunction and/or damage to speakers or other devices, always turn down the volume, and turn off the power on all devices before making any connections.

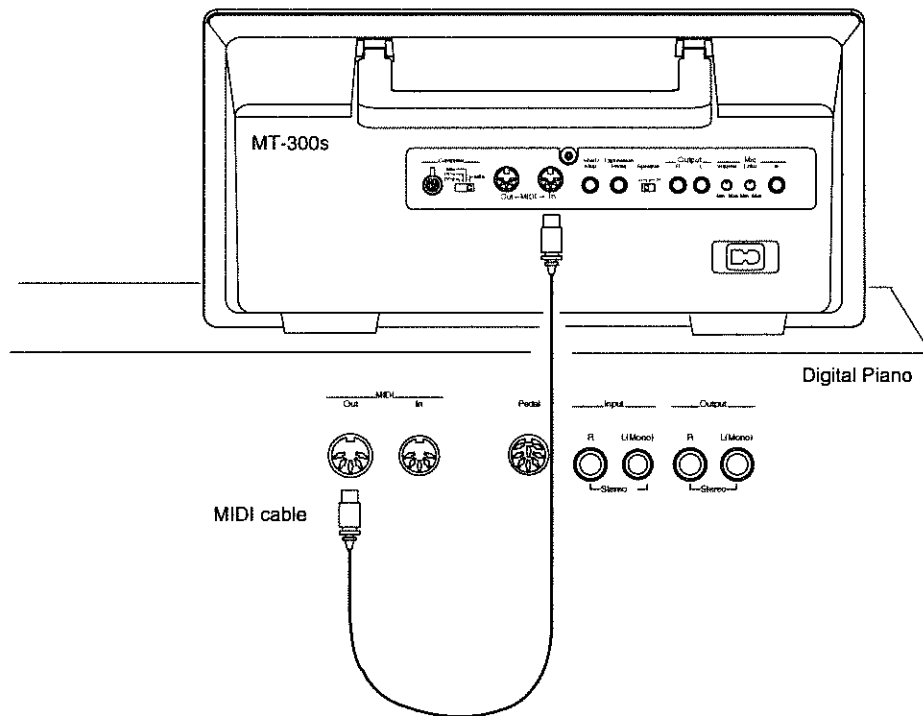

Make sure that the Computer switch is set to the "MIDI" position.

- 1.** Connect the MIDI In connector of the MT 300s with the digital piano's MIDI Out connector, using the MIDI cable provided.

To get even better sound

You can play the sound from the MT 300s through a digital piano's speakers.

1. Using a commercially available audio cable, connect the Output R/L jack of the MT 300s to the digital piano's Input R/L jack.

This lets you play the sound from the MT 300s through the digital piano speakers as well as from the MT 300s's own speaker.

2. Flip the Speaker switch on the rear panel of the MT 300s to "Off."

Sound from the MT 300s speaker now stops.

If you turn the Speaker switch back to "On," sound will again come from the MT 300s's speaker.

MEMO

Please use an audio cable with a standard phone plug. Consult the retailer from whom you purchased the MT 300s.

About the Pedal

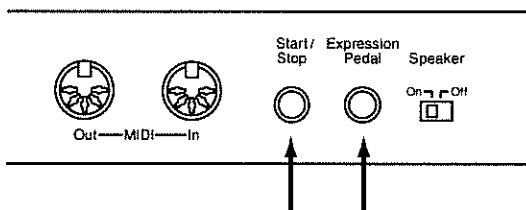

Using a pedal to start and stop playback and recording of songs

By connecting an optional pedal switch (such as Roland's model DP-2) to the MT 300s's Start/Stop jack, you can start and stop playback and recording of songs by pressing on the pedal. Furthermore, you can begin and end songs with fade-ins and fade-outs. Please refer to "Changing the Pedal Functions" (p.98).

Changing the volume with the pedal

By connecting an expression pedal (such as the Roland EV-5) to the MT 300s's Expression Pedal jack, you can change the volume of songs or sounds by stepping on the pedal.

NOTE

You cannot use the pedal switch if it is connected to the Expression Pedal jack; likewise, the expression pedal cannot be used if it is plugged into the Start/Stop jack.

MEMO

You will need to set up the Roland DP-2 Expression Pedal or EV-5 Expression Pedal separately. Please consult the dealer where you purchased these products when using them with the MT 300s.

NOTE

Use only the specified expression pedal (EV-5; sold separately). By connecting any other expression pedals, you risk causing malfunction and/or damage to the unit.

Once the connections have been completed (p. 16), turn on power to your various devices in the order specified.

NOTE

By turning on devices in the wrong order, you risk causing malfunction and/or damage to speakers and other devices.

Turning the Power On

1. Before turning on the power, reduce the volume all the way by sliding the [Volume] control completely to the left.

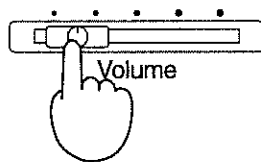

2. Plug the AC cord into the AC Inlet on the rear panel of the MT 300s.



AC Inlet

3. Plug the other end of the AC cord into a power outlet or wall socket.
4. Turn down the volume on the digital piano.
5. Turn on the digital piano's power switch.
6. Turn on the MT 300s by pressing the [Power] switch to the ON position. Adjust the volume to the appropriate level.

NOTE

Always turn on the power of the digital piano before turning on the MT 300s.

NOTE

This unit is equipped with a protection circuit. A brief interval (a few seconds) after power up is required before the unit will operate normally.

Turning the Power Off

1. Before turning off the power, reduce the volume all the way by moving the [Volume] slider completely to the left.
2. Turn down the volume on the digital piano.
3. Turn off the MT 300s by pressing the [Power] switch, putting it in the OFF position.
4. Turn off the digital piano's power switch.

NOTE

Use only the power cord that was supplied with the MT 300s.

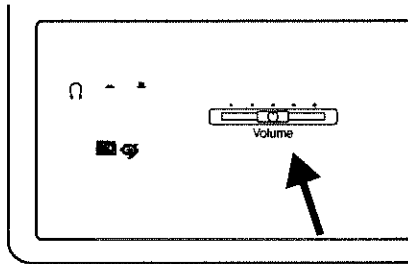

1. Adjust the volume with the [Volume] slider.

Sliding the control to the right increases the volume, and sliding it to the left decreases the volume.

When using the MT 300s with a digital piano or other instrument connected, you first have to tune the instruments' standard pitches to each other.

If, while playing ensemble pieces with other instruments, the pitches do not match, you will not be able to get pleasant sounding performances. Matching these standard pitches is called "tuning."

TERMS

What is the standard pitch?

In general, the pitch at Middle A on the piano is what is referred to as the standard pitch.

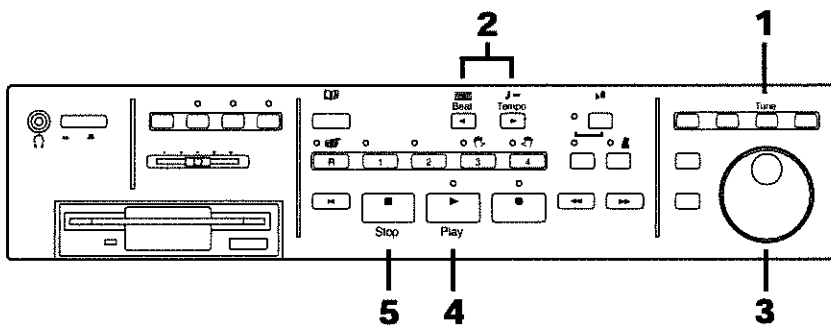

Press the [Song] button to display the Basic screen.

1. Press the [Tune] button.

The following screen is displayed.

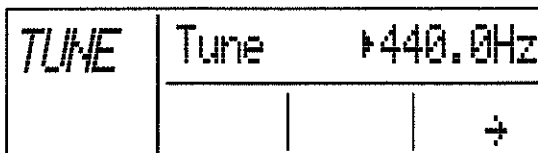

2. Press the Beat [◀] button or Tempo [▶] button until “Tune” appears in the upper part of the screen.

When “Key” or “Sound” is displayed, you can use the [Dial] to change the pitch and sound type of the tuning reference sound.

Displayed	Description
Tune	Changes the standard pitch.
Key	Changes the key of the tuning reference sound.
Sound	Changes the tuning sound type.

3. Rotate the [Dial] to change the pitch.

Match the digital piano’s pitch with that of the MT 300s.

The MT 300s’s standard pitch can be adjusted within the range from 415.3 to 466.2 Hz.

MEMO

When adjusting the pitch of the digital piano, please refer to the owner’s manual for that instrument.

4. When you press the Play [▶] button, the tuning pitch is played.

Confirm whether or not the MT 300s is in tune by playing the keyboard.

5. When you press the Stop [■] button, the tuning pitch stops playing.

NOTE

This setting is remembered, and will still be in effect the next time the MT 300s is switched on. Please refer to “Restoring the Original Settings” (p.95) if you wish to restore the original settings.

You can select the method of applying reverberation to the MT 300s’s sound to suit your particular needs.

TERMS

What is the reverb effect?

Reverberation is provided by the reverb effect. Adding reverb lends the sound a pleasant reverberation similar to that heard in a concert hall.

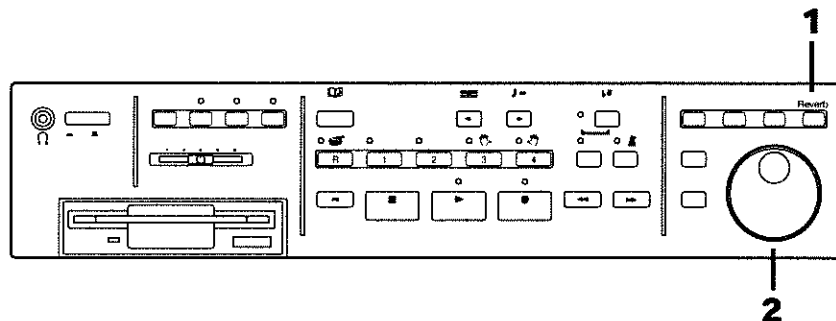

Press the [Song] button to display the Basic screen.

1. Press the [Reverb] button.

The following screen is displayed.

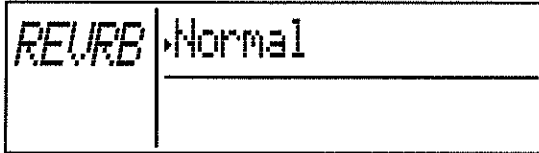

2. Rotate the [Dial] to select the amount of reverb to be used.

When you select a different song, the reverb reverts to its original settings.

Displayed	Description
Normal	The song is played with the reverb settings set in the music file left unchanged.
Listening	Adds an amount of reverb appropriate for music appreciation.
Lesson	Adds an amount of reverb appropriate for practicing piano and other such times.

NOTE

Some music files do not allow the reverb settings to be changed.

MEMO

You can also change the type of reverb. Please refer to "Adding Various Effects to Sounds" (p.97).

With two MIDI cables connecting the MT 300s and a digital piano, when playing the keyboard or listening to music files, you can choose to play digital piano sounds, or play the MT 300s's internal piano sounds.

NOTE

Set this up using a separate MIDI cable. Consult your dealer when purchasing this cable (p.113).

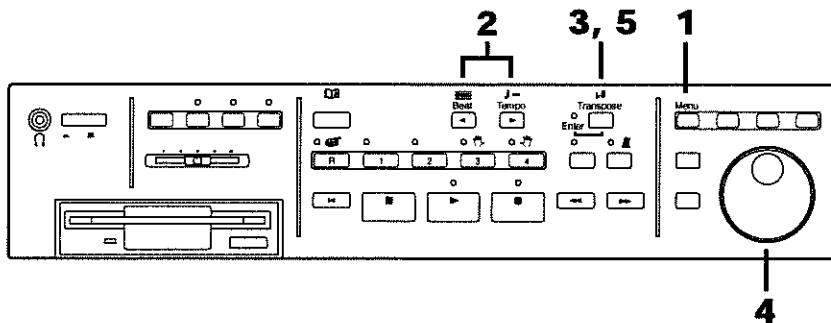

Press the [Song] button to display the Basic screen.

1. Press the [Menu] button.

The Menu screen is displayed (p.15).

2. Press the Beat [◀] button or Tempo [▶] button until "Piano Switch" appears in the upper part of the screen.

- 3.** When you press the [Transpose] button, the following screen is displayed.

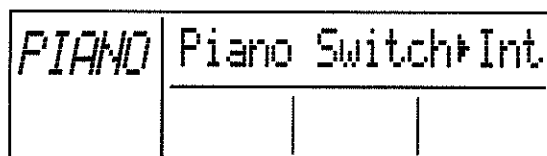

- 4.** With the [Dial], select [Int], [A], or [B].
Pressing the [Song] button at this point undoes the change and returns you to the Menu screen.
- 5.** Press the [Transpose] button.
The setting is now changed, and you are returned to the Menu screen.

Displayed	Description
Int	At this setting, the MT 300s's sounds are used when you play the keyboard. When listening to music files, all parts are played using the MT 300s's piano sounds.
A	At this setting, the connected digital piano's sounds are used when you play the keyboard with Part 1 selected in the 16-Track Screen (p.55). When listening to music files, Part 1 is played using the digital piano's sounds. Use this setting when listening to Roland Digital Piano Compatible music files.
B	At this setting, the connected digital piano's sounds are used when you play the keyboard with Parts 1, 3, and 4 selected in the 16-Track Screen (p.55). When listening to music files, Parts 1, 3, and 4 are played using the digital piano's sounds. Use this setting when playing Roland SMF format music files for piano lessons.

NOTE

This setting is remembered, and will still be in effect the next time the MT 300s is switched on. Please refer to "Restoring the Original Settings" (p.95) if you wish to restore the original settings.

NOTE

If the digital piano sounds are not being played, even with "A" or "B" selected, select "Piano" in the settings described in "Selecting the Sound Generator" (p.101).

MEMO

For more about music file parts, please refer to "Listening to Songs after Changing Instrument Sounds or Making Other Changes" (p.56).

With this, your preparations are complete.
When you are ready, continue with "Chapter 1 Mastering the Basics" (p.25)

Read this section if you going to use the MT 300s in combination with any acoustic instruments.

Turning the Power On

Be sure to use the following procedure when turning the power on or off. Carrying out this procedure incorrectly may result in malfunctioning or in damage to the speakers and other parts.

1. Before turning on the power, turn the volume all the way down by positioning the [Volume] slider all the way to the left.

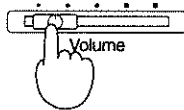

2. Plug the supplied power cord into the AC inlet on the rear panel of the MT 300s.



3. Plug the other end of the power cord into a power outlet or wall socket.
4. Press the MT 300s's [Power] switch.
This turns on the power to the MT 300s.
Adjust the volume to the appropriate level.

NOTE

Use only the power cord that was supplied with the MT 300s.

Turning the Power Off

1. Before turning off the power, reduce the volume all the way by moving the [Volume] slider completely to the left.
2. Turn off the MT 300s by pressing the [Power] switch, putting it in the OFF position.

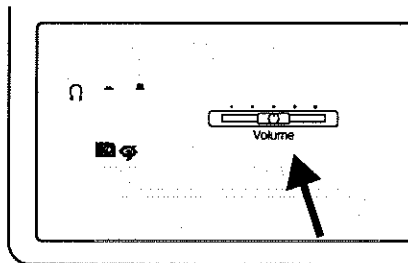

1. Adjust the volume with the [Volume] slider.
Sliding the control to the right increases the volume, and sliding it to the left decreases the volume.

To tune the standard pitch of the MT 300s so it matches that of an acoustic instrument you are using, perform the following. You will not be able to achieve a good sound if the standard pitches do not match. Matching these standard pitches is called "Tuning."

TERMS

What is the standard pitch?

In general, the pitch at Middle A on the piano is what is referred to as the standard pitch.

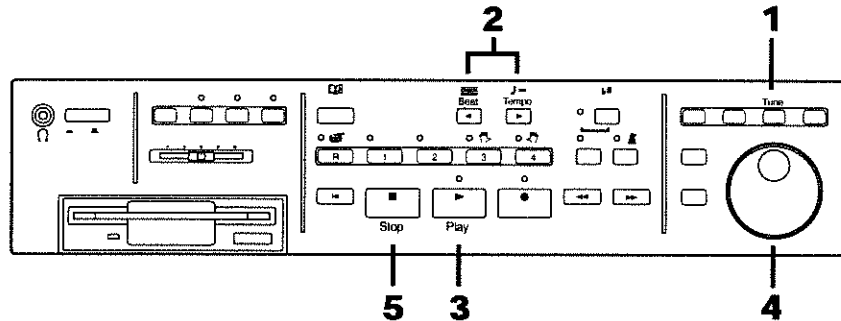

Press the [Song] button to display the Basic screen.

- 1.** Press the [Tune] button.
- 2.** Press the Beat [◀] button or Tempo [▶] button until "Tune" appears in the upper part of the screen. When "Key" or "Sound" is displayed, you can use the [Dial] to change the pitch and sound type of the tuning reference sound.

Displayed	Description
Tune	Changes the standard pitch.
Key	Changes the key of the tuning reference sound.
Sound	Changes the tuning sound type.

- 3.** When you press the Play [▶] button, a reference pitch sounds.
Play your instrument to see if it is in tune with the MT 300s.
- 4.** If you need to adjust the pitch of the MT 300s, change the value using the [Dial].
The MT300s's standard pitch can be adjusted within the range from 415.3 to 466.2 Hz.
- 5.** When you are finished, press the Stop [■] button.
The pitch then stops sounding.

NOTE

This setting is remembered, and will still be in effect the next time the MT 300s is switched on. Please refer to "Restoring the Original Settings" (p.95) if you wish to restore the original settings.

With this, your preparations are complete. If you like, you might try adding reverberation to the MT 300s's sounds. Please refer to "Adding Reverberation to the Sound" (p.20).

When you are ready, continue with "Chapter 1 Mastering the Basics (p.25)."

Using the MT 300s's internal disk drive, try listening to some of the songs on the Music File Disk included with the unit.

The Music File Disk is a floppy disk containing performance information for piano songs and other kinds of music.

Inserting and Removing Floppy Disks

NOTE

Before the first use of the disk drive, be sure to read the precautions on (p.5).

- 1.** With the label side facing up, insert the floppy disk into the disk drive until you hear it click firmly into place.

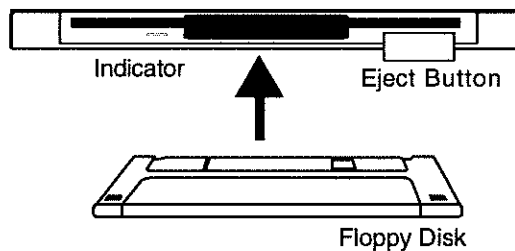

NOTE

The indicator light for the disk drive lights up at full brightness when reading or writing data, and lights up at half brightness at other times. Don't try to eject the disk while reading or writing is in progress (that is, when the indicator light is lit up at full brightness). Attempting to do so may damage the magnetic surface of the disk, rendering it unusable.

- 2.** Press the Eject button.

The edge of the floppy disk pops out of the disk drive opening. Gently grasp the edge of the floppy disk with your fingers and gently remove the disk.

Starting and Stopping Songs

Next, try playing a song and then stopping it. Playing a song on the MT 300s is referred to as "playback."

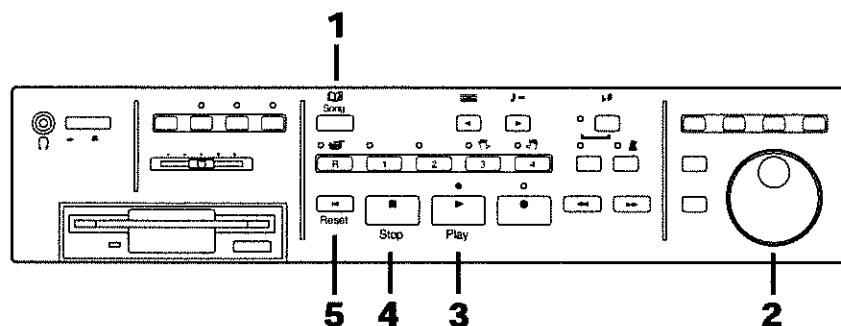

1. Press the [Song] button.

The song number and name are displayed in the upper part of the display.

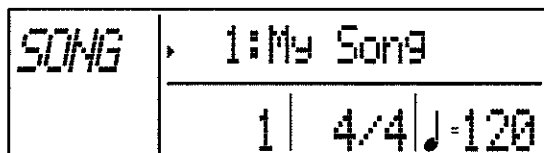

2. Rotate the [Dial] to select a song.
The song number and name change as you turn the [Dial].
3. When you press the Play [▶] button, playback of the selected song begins. The song is played to its end, at which point it automatically stops.
4. Pressing the Stop [■] button stops the song immediately.
5. Pressing the Reset [◀] button returns you to the beginning of the current song.

NOTE

When playing back songs that begin with pickups (songs that start on a beat other than the downbeat), the measure numbers "PU," "1," "2," are displayed on the screen.

MEMO

By connecting an optional pedal switch (such as Roland's model DP-2) to the MT 300s's Start/Stop jack, you can start and stop playback and recording of songs by pressing on the pedal (p.17, 98).

To Play a Song Repeatedly

1. When you press the [Repeat] button, its indicator lights, and the selected song is set for repeated playback.

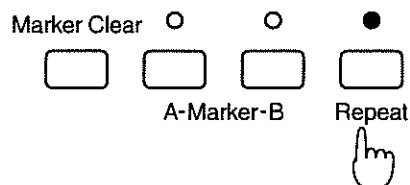

Pressing the [Repeat] button once more turns its indicator off, and the repeat function is canceled.

Listening to All Songs Played Back Continuously

You can repeat playback of all of the MT 300s's songs continuously. This function is called "All Song Play."

- 1. While pressing the [Song] button, also press the Play [▶] button.**
Playback begins from the selected song. After playback of the last song is completed, the MT 300s returns to the first song, and continues playback from there.
- 2. Pressing the Stop [■] button stops the song immediately.**

If You See This Screen Displayed

When recording songs (p.41, 61) or changing a song's basic settings (p.56, 59), if you try to select another song, the following will appear on the display.

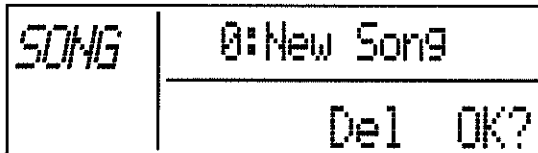

When You Want to Save the Song

- 1. Pressing the [Song] button returns you to the Basic screen.**
Save the song to a floppy disk.
For instructions on how to save songs, please refer to "How to Save Songs" (p.49).

When You Want to Delete the Song

- 1. Pressing the [Transpose] button deletes the recorded song or the song whose basic settings have been changed.**
You are then returned to the Basic screen.

NOTE

You cannot select another song until you have deleted the recorded song or the song whose basic settings have been changed.

Here's how to move to a measure somewhere within the song and begin playback from that point.

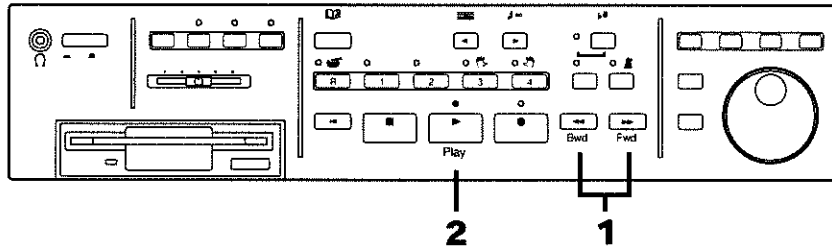

1. Using the Bwd [◀◀] button or Fwd [▶▶] button, “rewind” or fast forward to the measure you want to hear.
Pressing these buttons once moves you forward or back one measure. You can move forward and back continuously and more rapidly by holding the buttons down.
2. When you press the Play [▶] button, playback then begins from the measure to which you’ve moved.
You can also rewind and fast forward during playback of the song.

NOTE

When you begin playback of a song, the measure number in the lower left part of the screen begins flashing. This flashing indicates that the MT 300s is reading performance data from the floppy disk. While this is in progress, you cannot rewind or fast forward. Please wait a moment for this operation to finish.

To Return to the Beginning of the Song

1. Pressing the Reset [◀] button immediately returns you to the beginning of the song.

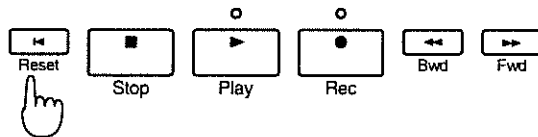

To Go to the End of the Song

1. You can move directly to the end of a song by pressing the Fwd [▶▶] button while holding down the Stop [■] button.

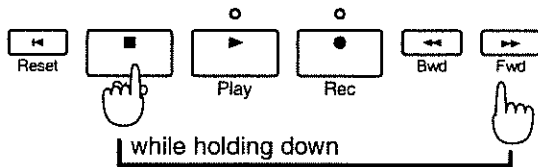

Moving to Marked Locations

By placing markers at points in the song, you can then jump directly to those points. You can set two markers (A and B) within a song. You can also set markers and jump to marked locations during playback of the song.

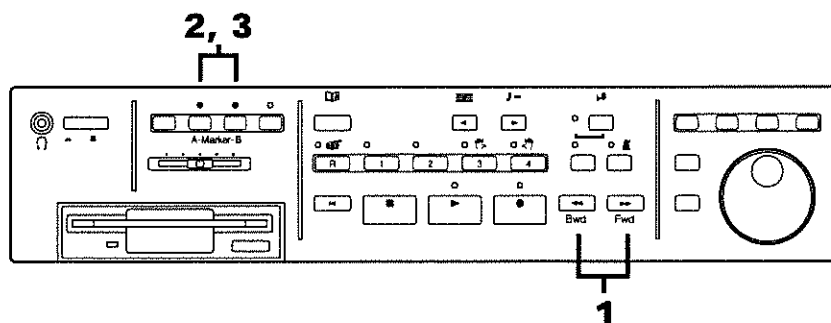

1. Using the Bwd [◀◀] button or Fwd [▶▶] button, move to the location in the song where you want to set a marker.
2. Pressing the [A] button sets Marker [A] at that point in the song; pressing the [B] button sets Marker [B].
When Marker [A] is set, the Marker [A] button indicator lights; when Marker [B] is set, the Marker [B] button indicator then lights.
3. After the markers are set, pressing the [A] button or [B] button takes you directly to the locations where Marker [A] or Marker [B] were placed.

NOTE

You cannot set Marker [A] and Marker [B] at the same point in the song. You also cannot place Marker [B] at an earlier point in the song than Marker [A].

MEMO

Although markers are normally placed at the beginning of measures, you can also place them within measures. Please refer to "Setting Markers Within Measures" (p.97).

Checking Where Markers Are Placed

You can check the display to confirm where markers are placed.

1. Press the [B] button while holding down the [A] button.
While these buttons are pressed, the measure numbers where Marker [A] and Marker [B] are set appear on the screen.

MARKER	[A]: 16	[B]: 23
	16	4/4 ♩=120

Moving Markers

You can move markers even after they have been set once.

1. While holding down the [A] button, press the Bwd [◀◀] button or Fwd [▶▶] button.

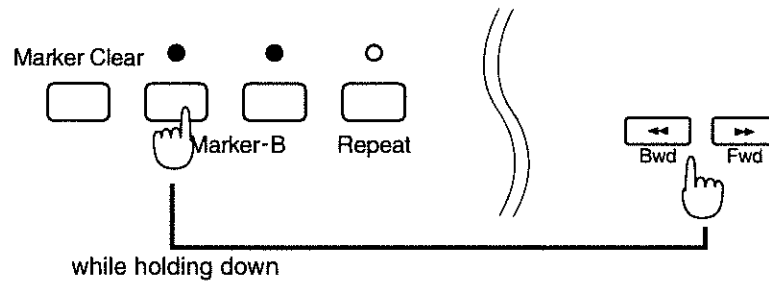

Marker [A] moves back or forward through the song one measure at a time. By holding the buttons down, you can have Marker [A] move continuously.

When moving Marker [B], press the Bwd [◀◀] button or Fwd [▶▶] button while holding down the [B] button.

Deleting Markers

1. Pressing the [A] button while holding down the [Marker Clear] button deletes Marker [A].

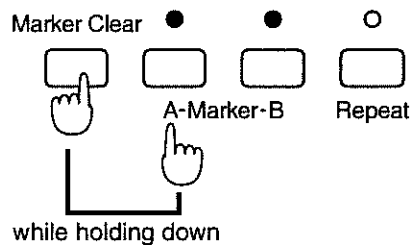

Pressing the [B] button while holding down the [Marker Clear] button deletes Marker [B].

NOTE

Markers are deleted when you select another song.

You can have only a selected section of a song played back repeatedly. This is convenient when you want to practice the same passage a number of times. If there is a portion of a song you can't seem to play the way you want, set markers there so you can practice just that section.

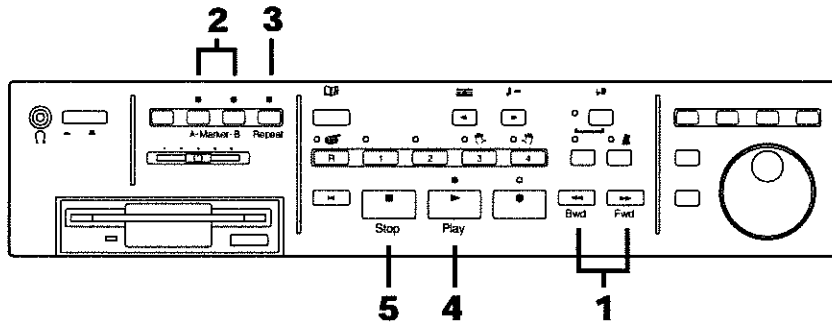

1. Using the Bwd [◀◀] button or Fwd [▶▶] button, move to the location in the song where you want to set a marker.

2. Press the [A] button and [B] button.

Marker [A] or Marker [B] is set at the location to which you've moved.

For example, if you want to repeat playback of the section from Measure 5 to Measure 8, place Marker A at the beginning of Measure 5 and Marker B at the beginning of Measure 9.

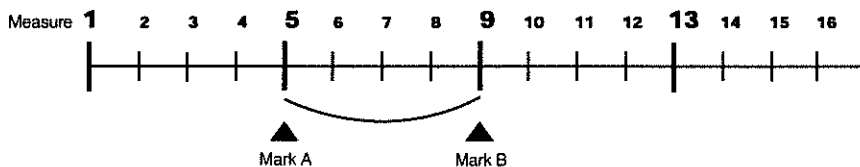

3. Press the [Repeat] button; its indicator lights.

The segment between Marker A and Marker B is set for repeated playback.

4. Press the Play [▶] button.

Playback between Marker A and Marker B repeats.

- If only Marker A is set, playback repeats between Marker A and the end of the song.
- If only Marker B, playback repeats between the beginning of the song and Marker B.

5. Press the Stop [■] button, and playback of the song ceases.

Moving a Repeating Segment

You can move the interval of a repeated segment forward or back without changing the length of the interval between the markers. This is effective when, for example, you have finished practicing one section and want to go on to practice the next section.

1. While simultaneously pressing the [A] button and [B] button, press either the Bwd [◀◀] or Fwd [▶▶] button.

The interval between Marker A and Marker B is shifted back or forward.

For example, with Marker A set at the beginning of Measure 5 and Marker B at the beginning of Measure 9

- Pressing the Bwd [◀◀] button moves the markers back one interval, with Marker A moved to the beginning of Measure 1 and Marker B to the beginning of Measure 5.

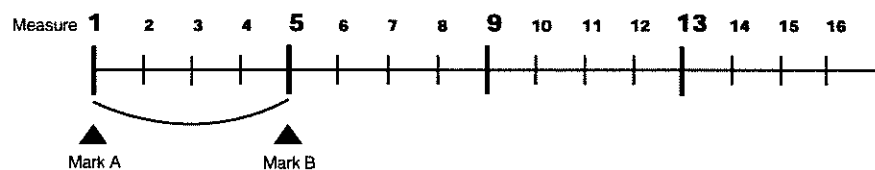

- Pressing the Fwd [▶▶] button moves the markers further along once, with Marker A moved to the top of Measure 9 and Marker B to the top of Measure 13.

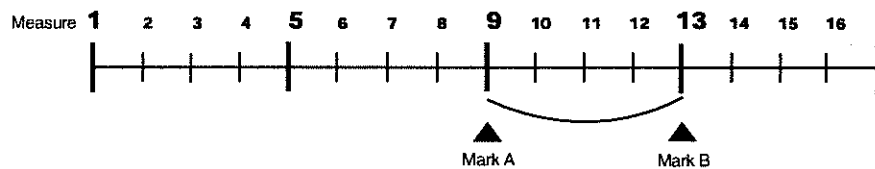

Perform the steps below to change the tempo of a song.

When you have a song with a tempo that is difficult to play, it can be effective to first practice the song at a slower, easier tempo, and then practice the song at a gradually increased tempo as you become more familiar with the music.

Changing the tempo does not affect the pitch.

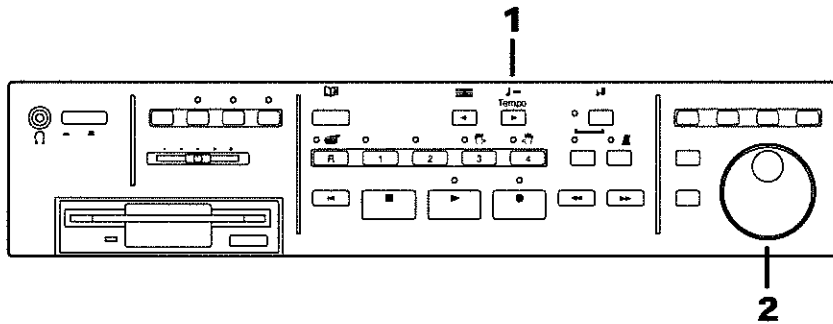

1. Press the Tempo [▶] button.

The cursor (▶) moves to the lower right part of the screen.

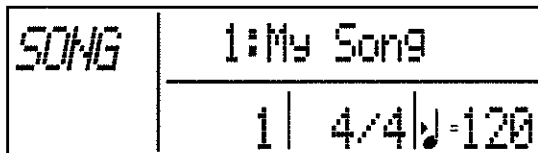

2. Rotate the [Dial] to adjust the tempo.

You can also change the tempo while the song is playing.

Pressing the Reset [◀] button while holding down the Tempo [▶] button restores the original tempo.

Setting the Tempo by Pressing the Button in Time (Tap Tempo)

You can set determine the song tempo through the rhythm with which you tap the button.

1. Press the Tempo [▶] button four times at the desired tempo.

The tempo is set to the same timing you used to press the button.

Playing Without Tempo Changes (Tempo Mute)

You can have songs that feature tempo changes played back at a fixed tempo. Playing back songs at a fixed tempo after suspending any tempo changes is called "Tempo Mute."

Try practicing a song that includes an increasing tempo, first setting a single tempo with Tempo Mute.

1. Press the Tempo [▶] button, and set the tempo with the [Dial].
2. While pressing the Tempo [▶] button, press the Stop [■] button.
The song is now set to be played back at the selected fixed tempo.

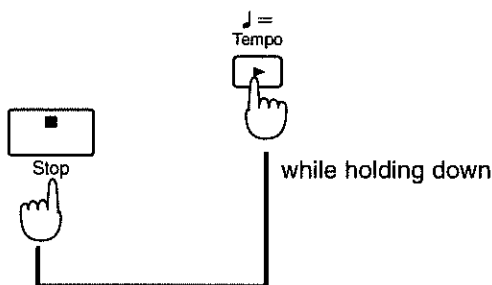

You can cancel the Tempo Mute with the following procedure.

- Once more, while pressing the Tempo [▶] button, press the Stop [■] button.
- While pressing the Tempo [▶] button, press the Play [▶] button.

The following appears on the display while Tempo Mute is active.

SONG	1: My Song
1 4/4	Tempo Mute 120

NOTE *Tempo Mute is canceled when you select a different song.*

You can play back songs in different keys by transposing them.

NOTE

The transposed setting is canceled when the power is turned off, or when you select a different song.

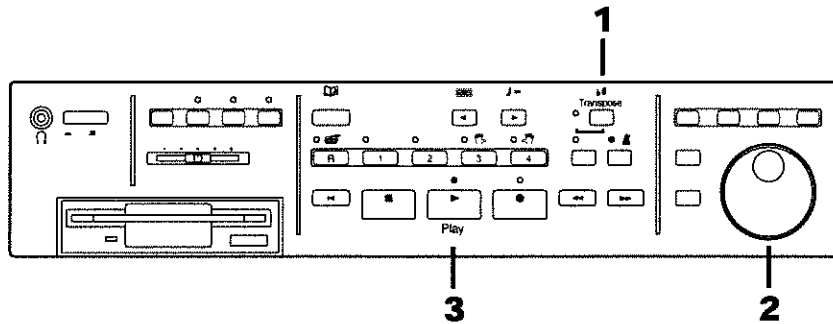

- 1.** Press the [Transpose] button.
The following screen is displayed.



- 2.** Use the [Dial] to change the key.
You can transpose the song within a range from -24 to +24 (in semitone steps).
- 3.** Press the Play [▶] button, and the song is played in the new key.

The MT 300s features a built-in metronome. You can start and stop the metronome with the press of a single button. Use the metronome when you are having difficulty in getting a feel for the tempo. You can also have the metronome play the tempo of a song while the song is played.

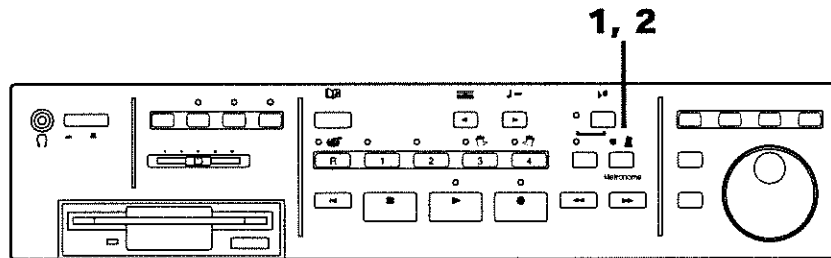

1. When you press the [Metronome] button, the metronome sounds. The [Metronome] button indicator lights.
2. Pressing the [Metronome] button once more stops the metronome, and the [Metronome] button indicator is extinguished.

Changing the Metronome Beat

1. Press the Beat [\blacktriangleleft] button. The cursor (\blacktriangleright) moves to the middle of the lower row of the screen.

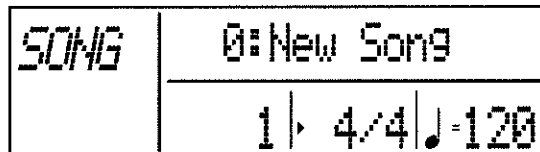

2. Rotate the [Dial] to select the beat.

Displayed	Description
2/2	2/2
0/4	Only upbeat sounds
2/4	2/4
3/4	3/4
4/4	4/4
5/4	5/4
6/4	6/4
7/4	7/4
3/8	3/8
6/8	6/8
9/8	9/8
12/8	12/8

3. Press the [Metronome] button; its indicator lights. The metronome then plays the selected rhythm.

Adjusting the Metronome Tempo

1. Press the Tempo [▶] button.

The cursor (▶) moves to the lower right part of the screen.



2. Rotate the [Dial] to select the tempo.
3. Press the [Metronome] button; its indicator lights.
The metronome then plays the selected tempo.

Adjusting the Metronome Volume

You can adjust the metronome volume, with ten volume levels available.

1. While pressing the [Metronome] button, adjust the metronome volume level with the [Dial].

The following screen is displayed.

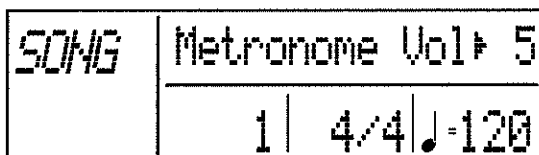

MEMO

You can also change the metronome pattern and sound type. Please refer to "Changing the Metronome Settings" (p.95).

Each part of the piano songs on the Music File Disk included with the MT 300s can be played separately. So, whether you want to play the right-hand part, following along with the song's right hand; or play the left-hand part, following along the song's right hand, you can practice each hand's part individually.

The songs on the Music File Disk included with the MT 300s are assigned to the five Track buttons as follows.

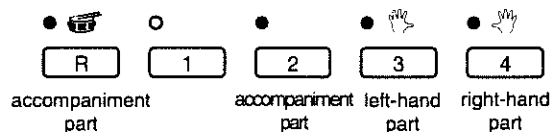

Button indicators for Track buttons to which sounds are assigned shine in green. Indicators for buttons to which no sounds are assigned are not lit.

1. Press any of the Track buttons, turning on the button indicator.

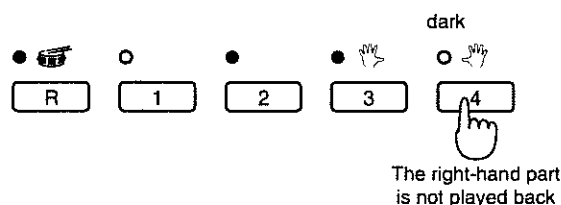

2. Press the Play [▶] button.

The sounds assigned to Track buttons whose indicators are turned on are played; sounds assigned to Track buttons whose indicators are not lit are not played.

3. Pressing Track buttons with indicators that are not lit then turns on those indicators.

Sounds on those Track buttons can then be heard.

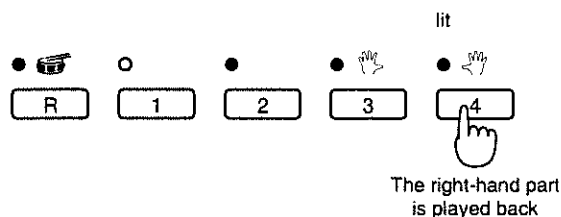

Temporarily stopping the sounds on tracks by turning off the Track indicators this way is called "muting."

Try using this function in practicing the parts for each hand.

4. Press the Stop [■] button to cease playback of the song.

MEMO

By recording your own songs to the Track buttons this way, you can also use this function to practice each part of your songs individually.

Synchronizing the Timing when You Come into a Song (Count In)

The function whereby a “count sound” is played in the leadup to playback of a song is called “Count In.”

For example, when you want to play along with a song, by playing this count sound before playback starts, you can synchronize your timing with that of the song.

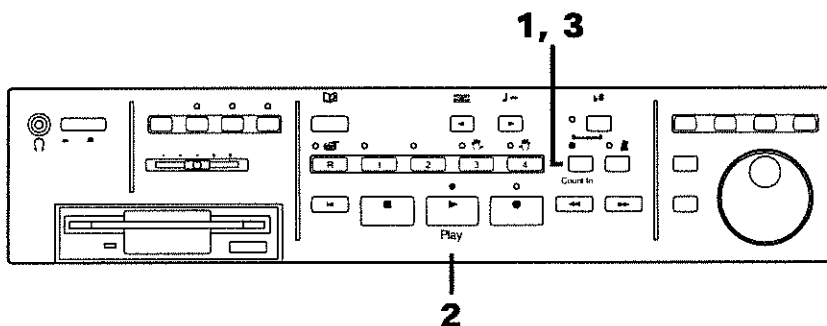

- 1.** Press the [Count In] button, turning on its indicator.
- 2.** When you press the Play [▶] button, two measures of count sound plays, after which playback of the song begins.
- 3.** Pressing the [Count In] button once more turns off the button indicator, and Count In is canceled.

MEMO

You can change the number of measures of count sound and the type of sound that is played during Count In. Please refer to “Changing the Count Sound Settings” (p.96).

Practicing the Right-Hand Part

Try practicing the right-hand part, playing along with the left-hand part of the song. First the tempo must be set.

When using the count sound or metronome, press the [Count In] button or [Metronome] button, turning on the indicators.

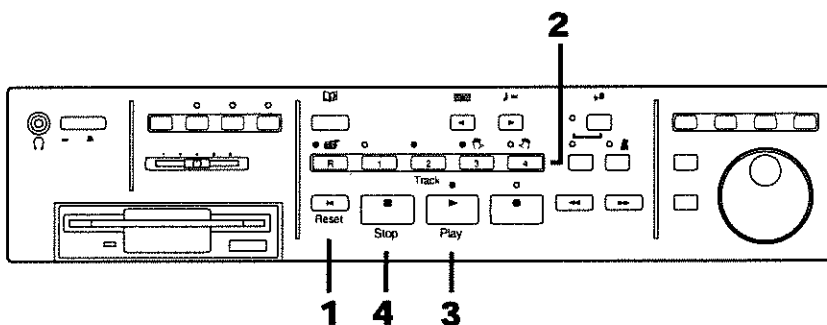

- 1.** Press the Reset [◀] button to go to the beginning of the song.
- 2.** Press the [4] button, turning off its indicator.
- 3.** When you press the Play [▶] button, and playback of the song begins.
The right-hand part is not played.
Play the right-hand part of the song along with the song's left-hand part.
- 4.** Press the Stop [■] button, and playback of the song ceases.

Practicing the Left-Hand Part

Now, practice the left-hand part, playing along with the right-hand part of the song.

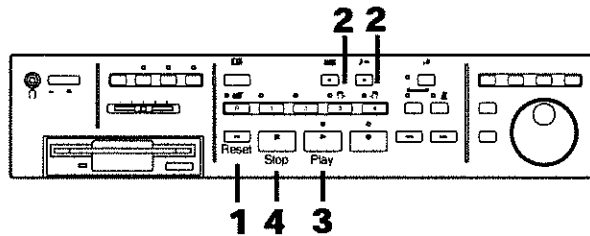

The procedure is the same as that in "Practicing the Right-Hand Part."

1. Press the Reset [\blacktriangleleft] button to go to the beginning of the song.
2. Press the [3] button, turning off its indicator, and then press the [4] button to turn that button indicator on.

Now, the left-hand part is set to not play, while the right-hand part will sound.

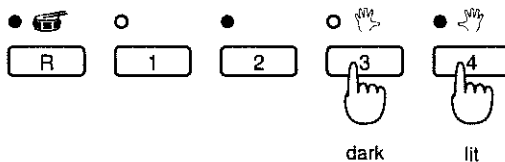

3. When you press the Play [\blacktriangleright] button, playback of the song begins. Play the left-hand part of the song along with the song's right-hand part.
4. Press the Stop [\blacksquare] button, and playback of the song ceases.

Using Both Hands to Play Along with Accompaniment

After practicing each hand's part separately, try playing with both hands.

By selecting a song that features accompaniment, you can play along with the song as an orchestra accompanies you.

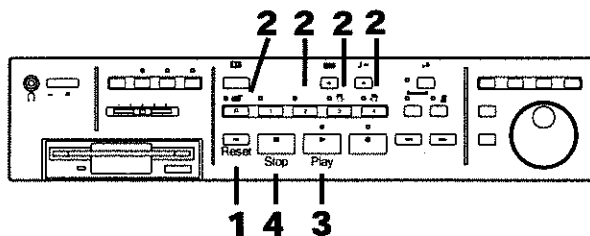

The procedure is the same as that in "Practicing the Right-Hand Part."

1. Press the Reset [\blacktriangleleft] button to go to the beginning of the song.
2. Press the [3] and [4] buttons to turn off their indicators. Press the [R] button and [2] button, turning on those indicators.

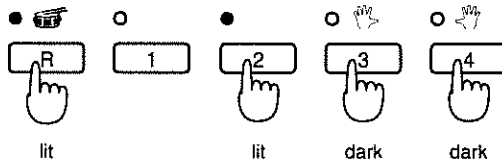

3. When you press the Play [▶] button, playback of the song begins.

4. Press the Stop [■] button, and playback of the song ceases.

MEMO

When multiple instruments are included on the same Track button, and you want to play with the sound of one of the instruments on that Track button muted, please refer to "Preventing Only One Instrument from Being Played" (p.60).

If you are using an acoustic instrument, please go directly to "Performing Karaoke and Accompanying Yourself on the Keyboard" (p.54).

If you are connecting a digital piano to the MT 300s, please go directly to "Try Recording Your Own Performance".

NOTE

By connecting a digital piano or other instrument to the MT 300s, you can record your own performances.

Recorded performances are erased when the MT 300s's power is turned off. Furthermore, you cannot select a different song until the recorded song is erased or deleted. If you do not want to delete a recorded performance, then you will want to save it to a floppy disk.

MEMO

For instructions on how to save performances, please refer to "How to Save Songs" (p.49).

If You See This Screen Displayed

The following screen is displayed when you try to select a different song without first saving the song you've recorded.

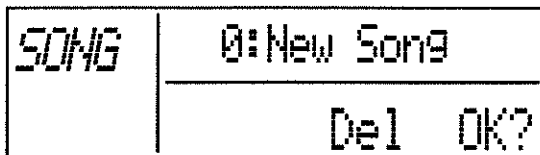

When Saving the Song

- 1. Press the [Song] button to return to the Basic screen.**
Save the song to a floppy disk.

When Deleting the Song

- 1. When you press the [Transpose] button, the song is deleted.**
You are then returned to the Basic screen.

Recording Along with Songs

You can record your own performance while you play along with a song, and then listen to the recorded performance.

Recording the Right-Hand Part

You can record and then listen to your performance of the right-hand part.

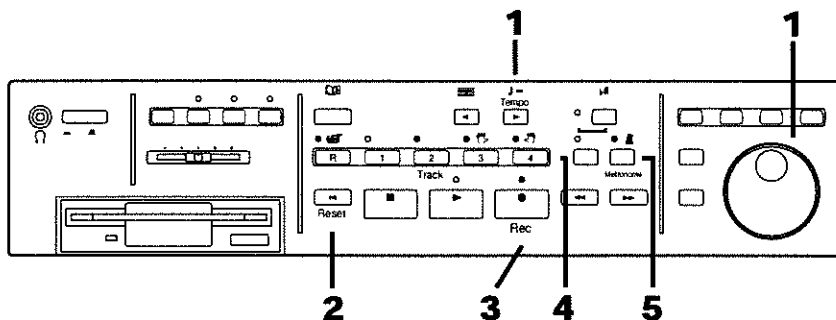

- 1.** Using the Tempo [▶] button and the [Dial], adjust the tempo to one you find is easy to play.
- 2.** Press the Reset [◀] button to go to the beginning of the song.
- 3.** Press the Rec [●] button; its indicator lights.
 The MT 300s is put in record standby mode.
 To cancel recording, press the Stop [■] button.
 When you press the Rec [●] button and go into record standby, the [Count In] button indicator lights. If you don't want the count sound to be played, press the [Count In] button, turning off the button indicator.
 When the [Count In] button indicator is turned off, recording begins after the two previous measures of the song are played back. When you start recording from the beginning of the song, recording begins after two silent measures are played.
- 4.** When you press the [4] button, its indicator begins flashing.
 Your performance is set for recording on the [4] button.

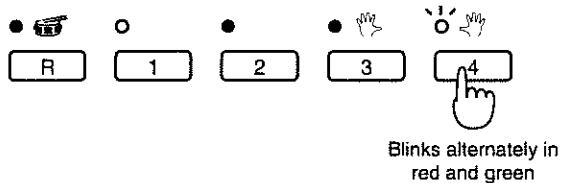

- 5.** If you want the metronome to play, press the [Metronome] button, turning on that button indicator.
 The sound of the metronome is not recorded.

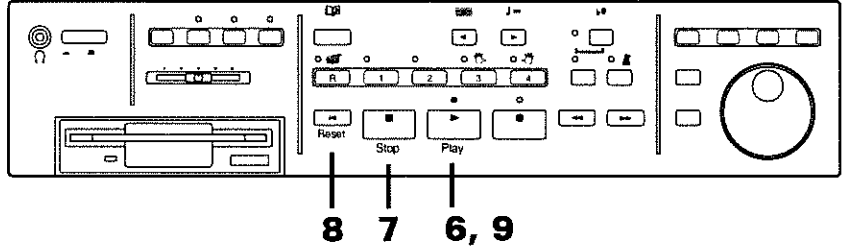

6. Press the Play [▶] button.

Recording begins after two measures of count sound.

Play the right-hand part of the song along with the song's left-hand part.

You can also begin recording without pressing the Play [▶] button just by starting to play the keyboard. There is no count sound played when you start in this manner.

7. Press the Stop [■] button, and recording of the song ceases.

"0 : New Song" in the upper part of the display.

At this point, the recording to the Track button is as shown below.

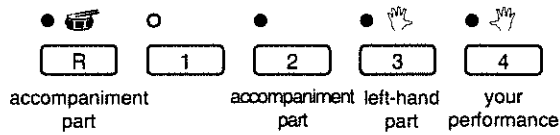

8. Press the Reset [◀] button to go to the beginning of the song.

9. When you press the Play [▶] button, the recorded performance is played back.

Now, see how the recording of your performance of the right-hand part sounds.

Recording the Left-Hand Part

Now, record and listen to your performance of the left-hand part.

Although the procedure is the same as in "Recording the right-hand part," you will need to substitute the following step.

In Step 4 of "Recording the right-hand part," press the [3] button, and confirm that its indicator has started flashing.

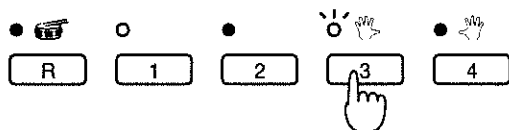

Blinks alternately in red and green

Recording Along with Accompaniment

Now, you might want to try recording your own performance using both hands while playing along with accompaniment.

In this case, you need to select a song that features accompaniment.

Although the procedure is the same as in "Recording the Right-Hand Part," you will need to change the procedure as shown below.

Prevent the right-hand and left-hand parts from sounding by pressing the [3] and [4] buttons, turning off their indicators. Then, have the accompaniment parts play by pressing the [R] and [2] buttons, turning on the indicators for those buttons.

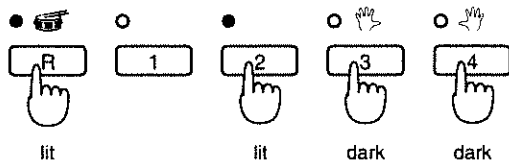

In Step 4 of "Recording the Right-Hand Part," press the [1] button, and confirm that its indicator has begun flashing.

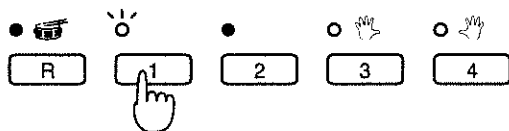

Blinks in red

Recording New Songs

The MT 300s's five Track buttons allow you to easily record your performances and create authentic ensemble works as well.

MEMO

To learn how to construct ensemble pieces, please refer to "Recording Ensemble Works" (p.62).

Here you will find a description of how to record using the Track buttons

NOTE

You cannot record songs with different tempos or rhythms to the five Track buttons.

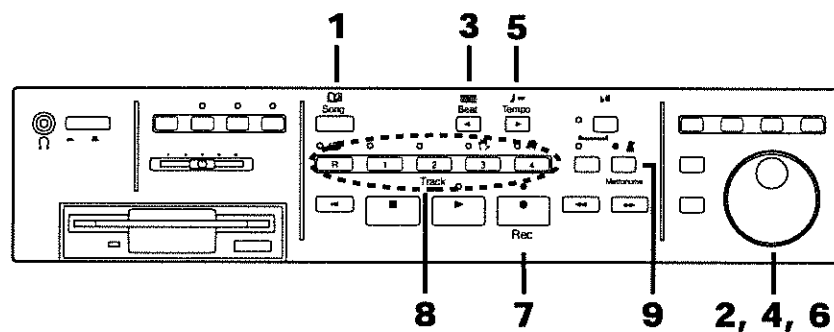

1. Press the [Song] button.
2. Turn the [Dial] until "0 : New Song" appears in the upper part of the display.

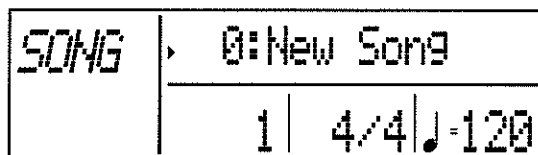

3. Press the Beat [◀] button.
4. Rotate the [Dial] to determine the rhythm for the song. (Note 1)

Displayed	Description
2/2	2/2
0/4	Only weak beats are played
2/4	2/4
3/4	3/4
4/4	4/4
5/4	5/4
6/4	6/4
7/4	7/4
3/8	3/8
6/8	6/8
9/8	9/8
12/8	12/8

- 5.** Press the Tempo [▶] button.
- 6.** Rotate the [Dial] to determine the song's basic tempo. (Note 2)
- 7.** Press the Rec [●] button, turning on the button indicator.
The MT 300s is put into record standby mode.
To cancel recording, press the Stop [■] button.
- 8.** Press the Track button for the track you want to record to, causing the button indicator to flash. (Note 3)
- 9.** If you want the metronome to play while you record, press the [Metronome] button.
The sound of the metronome is not recorded.

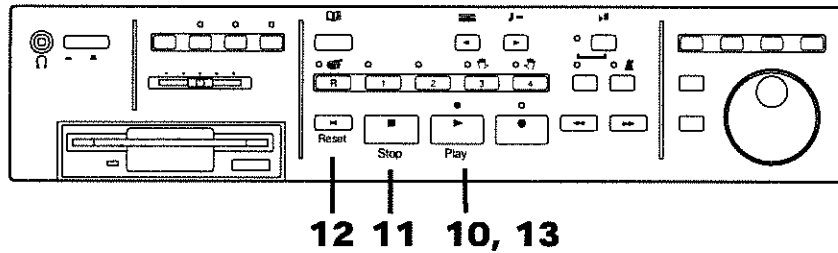

- 10.** Press the Play [▶] button.
Recording begins after two measures of count sound. (Note 4)
You can also begin recording without pressing the Play [▶] button just by starting to play the keyboard. There is no count sound played when you start in this manner.
- 11.** Press the Stop [■] button, and playback of the song ceases.
The button indicator of the Track button to which you have recorded lights.
- 12.** Press the Reset [◀] button.
This returns you to the beginning of the recorded song.
- 13.** Press the Play [▶] button to play back the recorded performance.

(Note 1)

You cannot change the song's beat during or after recording. If you want to create and record a song that does include such rhythm changes in the course of the song, please refer to "Creating Songs Featuring Beat Changes" (p.76).

(Note 2)

To change the recorded song's basic tempo, see "Changing the Basic Tempo of the Song" (p.59) for instructions.

If you want to create a song that does include tempo changes in the course of the song, please refer to "Creating Songs Featuring Tempo Changes" (p.74).

(Note 3)

If you select a Track button to which something already has been recorded, then the previously recorded performance is replaced by the new material from the point where the new recording begins to where it stops.

When you select a Track button which already has material recorded onto it, the button indicator begins flashing in red and green.

Only the Drum Set and SFX (sound effects) Set tones are recorded to the [R] button. For more information on the Drum Set and SFX Set, please refer to "List of Tone Names" (p.107).

(Note 4)

When you press the Rec [●] button to put the MT 300s into record standby, the [Count In] button indicator lights. If you don't want the count sound to be played, press the [Count In] button, turning off the button indicator.

When the [Count In] button indicator is turned off, recording begins after the two previous measures of the song are played back. When you start recording from the beginning of the song, recording begins after two silent measures are played.

MEMO

By connecting an optional pedal switch (such as Roland's model DP-2) to the MT 300s's Start/Stop jack, you can start and stop playback and recording of songs by pressing on the pedal (p.17, 98).

Deleting Sounds Recorded to Track Buttons

You can delete the sounds recorded to each Track button individually.

NOTE

However, you cannot a song's basic tempo or rhythm settings.

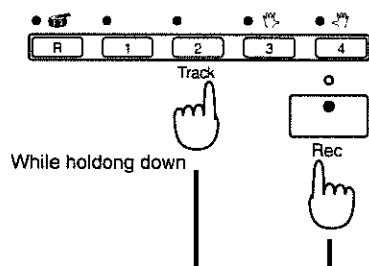

1. While pressing the Track button onto which the sounds you want to delete are recorded, press the Rec [●] button.

The Track button indicator goes off, and the recorded sounds are deleted.

Deleting Recorded Songs

You can delete recorded songs entirely.

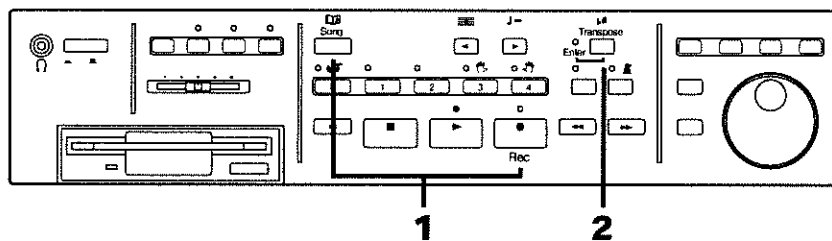

1. While pressing the [Song] button, press the Rec [●] button.

The [Transpose] button indicator begins flashing, and the following screen is displayed.

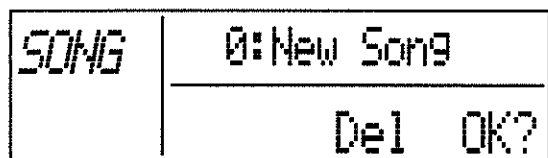

Pressing the [Song] button cancels the operation.

2. When you press the [Transpose] button, the recorded song is deleted.

Recorded songs are deleted when the MT 300s is turned off. Furthermore, you cannot select a different song until you delete the recorded performance. Thus, you will want to save your important works to a floppy disk.

MEMO

You can create your own original music files when you save recorded performances to floppy disks. Be sure to check out the many ways you can use floppy disks.

Before Using Floppy Disks (Format)

Before a floppy disk can ever be used for saving songs with the MT 300s, you must “format” the disk.

The deleting of data on a floppy disk and preparing the disk for the equipment it is to be used with is known as “formatting.” Floppy disks cannot be used on the MT 300s without changing the disk’s format to that of the MT 300s.

NOTE

Formatting erases all the data stored on the floppy disk. When formatting a previously used floppy disk for reuse, make sure that it is all right to format the disk.

NOTE

Before using the disk drive for the first time, be sure to read the related precautions on p.5.

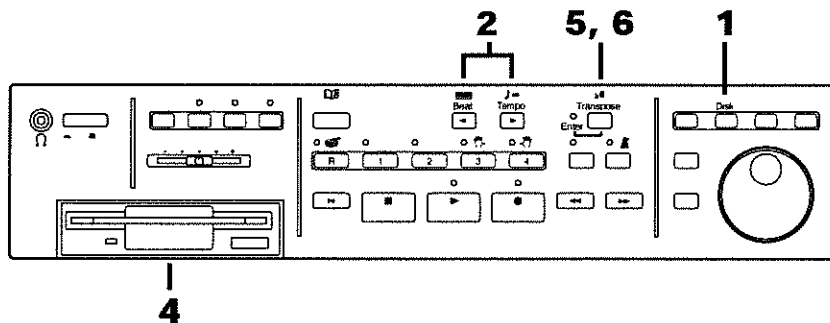

Press the [Song] button to display the Basic screen.

1. Press the [Disk] button.
The Disk screen is displayed (p.15).
2. Press the Beat [◀] button or Tempo [▶] button until “Disk Format” appears in the upper part of the screen.



3. Confirm that the disk’s protect tab is in the “Write” position.

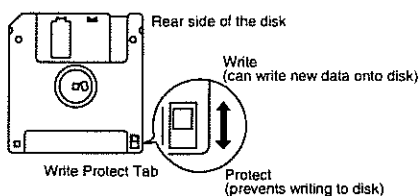

4. With the front (label side) of the floppy disk facing up, insert the disk into the disk drive opening until there is a solid “click (p.25).”
5. Press the [Transpose] button; the following screen is displayed.

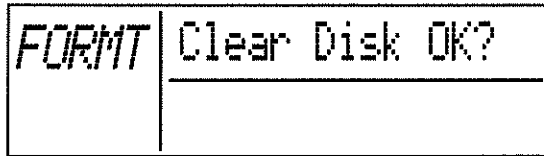

Pressing the [Song] button returns you to the Disk screen.

6. Pressing the [Transpose] button once again begins the formatting process.

A countdown, from “80” to “0” is displayed on the screen. When the format is finished, the Disk screen returns.

NOTE Do not remove the floppy disk from the disk drive until the formatting is finished.

NOTE Please refer to “If You See This Screen Displayed” (p.106) if the number beginning with the letter “E,” such as “E.00,” appears on the screen.

Saving Songs to Floppy Disks

Storing data, including recorded performances, onto floppy disks is called “saving.”

NOTE Before using the disk drive for the first time, be sure to read the related precautions on p.5.

NOTE When using a brand new floppy disk on the MT 300s, format the disk first. Please refer to “Before Using Floppy Disks (Format)” (p.49).

NOTE You may not be able to save some songs contained in certain commercially available music files.

MEMO Improper handling of floppy disks may result in cracked disks, unplayable data, or other damage. When saving songs to floppy disks, making two copies of each disk is recommended. Keeping an additional copy of the same song on a separate floppy disk can provide great peace of mind.

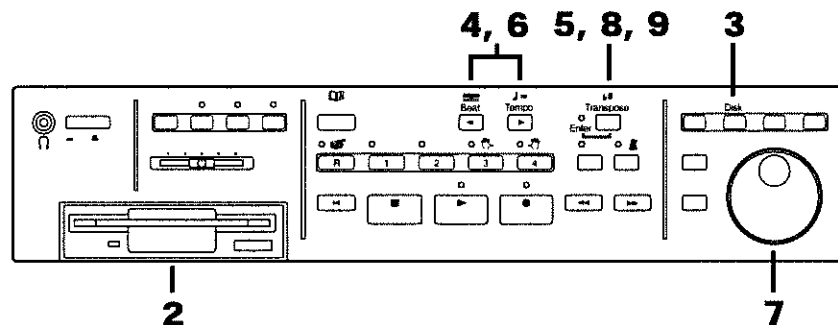

Step 1... Insert the floppy disk into the disk drive

1. Confirm that the disk’s protect tab is in the “Write” position (p.49).
2. With the front (label side) of the floppy disk facing up, insert the disk into the disk drive opening until there is a solid “click” (p.25).

Step 2... Select a format for saving.

Press the [Song] button to display the Basic screen.

3. Press the [Disk] button.

The Disk screen is displayed (p.15).

4. Press the Beat [◀] or Tempo [▶] button until either “Save” or “Save As SMF” appears in the upper part of the display.

Displayed	Description
Save	The song is saved in MT 300s format. You can listen to songs saved in this format on the Roland HP-G series and KR series keyboards as well as on Roland MT series devices.
Save As SMF	The song is saved as an SMF (Standard MIDI File). You can listen to songs saved in this SMF format on the many types of devices that can play SMFs (p.112). *When you play back recorded performance on some devices, certain sounds may be missing or altered. *You cannot use the “Save As SMF” option to save recorded songs that use commercially available music files.

NOTE

On any one floppy disk, you can save songs in one format only.

Step 3... Assign the song a song number and name

5. When you press the [Transpose] button, the following screen is displayed.

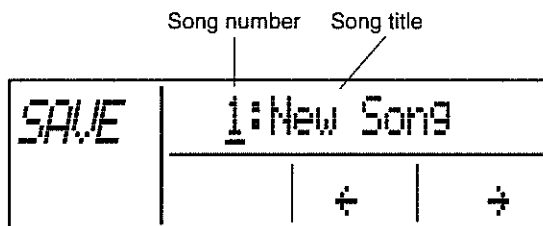

Pressing the [Song] button returns you to the Disk screen

6. Press the Beat [◀] or Tempo [▶] buttons to move the cursor (—) in the upper part of the display one character at a time.

7. Use the [Dial] to select the numerals and letters.

NOTE

If you select a number that is already being used by a saved song, the previously saved song is then erased, and the new one saved in its place. A “U” appears before the number of saved songs. If you don’t want to delete the previously saved song, select a song number that does not have “U” appearing before it.

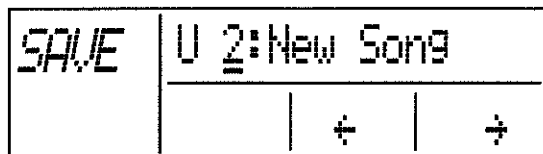

Step 4... Save

8. When you press the [Transpose] button, the following screen is displayed.

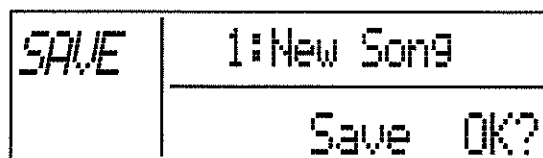

Pressing the [Song] button returns you to the previous screen.

9. Pressing the [Transpose] button once again starts the save.
Saving a song takes anywhere from a few seconds to about a minute.
When the save is finished, the Disk screen returns.

NOTE

Do not remove the floppy disk from the disk drive until the save is finished.

It is a good idea to make a habit of sliding the protect tab to the "Protect" position when a save is completed.

Putting the protect tab in the "Protect" position, protects against accidental erasure of songs. With the protect tab of disks with songs saved on them in the "Write" position, inserting the disks into the disk drive of a computer or other device may make the songs on the disk unplayable on the MT 300s (for more detailed information, please refer to the notes on p.5).

Changing the Song Order on Floppy Disks

Use the following procedure to change the order of songs that have been saved onto a floppy disk.

1. Prepare one more blank, formatted floppy disk.
2. Insert the floppy disk on which the songs are saved into the disk drive, and select the song to which you would like to assign song number one.
3. Press the Play [▶] button.
The measure number in the lower left part of the display begins flashing.
4. When the lower left section of the display stops flashing, press the Stop [■] button.
5. Remove the floppy disk from the disk drive and insert the other formatted disk.
6. Save the song in the normal manner.
Repeating this process, save your songs in the order you like.

You can delete songs that have been saved to floppy disks.

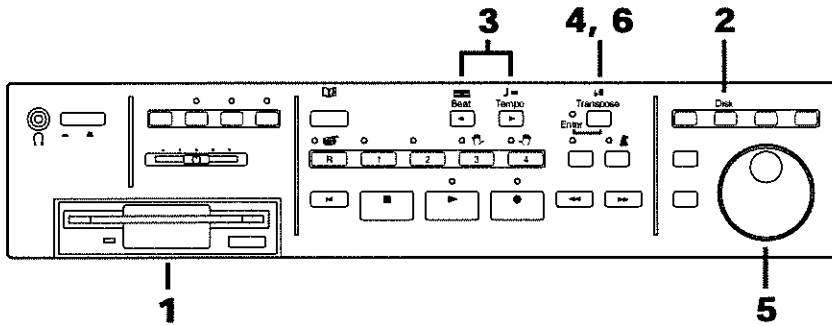

Press the [Song] button to display the Basic screen.

- 1.** Insert a floppy disk into the disk drive (p.25).
- 2.** Press the [Disk] button.
The Disk screen is displayed (p.15).
- 3.** Press the Beat [◀] or Tempo [▶] buttons until "Disk Song Del." appears in the upper part of the display.
- 4.** When you press the [Transpose] button, the following screen is displayed.

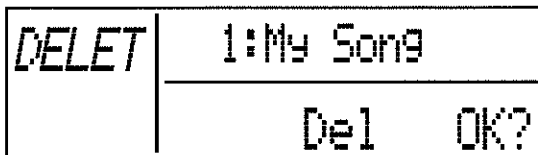

Pressing the [Song] button returns you to the Disk screen.

- 5.** Use the [Dial] to select the song you want to delete.
Pressing the [Song] button returns you to the previous screen.
- 6.** When you press the [Transpose] button once more, the following screen is displayed.

By plugging a microphone into the MT 300s's Mic In jack, you can enjoy karaoke and use the MT 300s to accompany yourself while you sing.

NOTE

If you are going to connect a microphone or want to use the karaoke feature, you will need to purchase special music files for this. Consult the Roland dealer where you purchased your MT 300s when buying such music files. For more information, please refer to "Music Files that Can Be Used with the MT 300s" (p.112).

NOTE

Before the first use of the disk drive, be sure to read the precautions on (p.5).

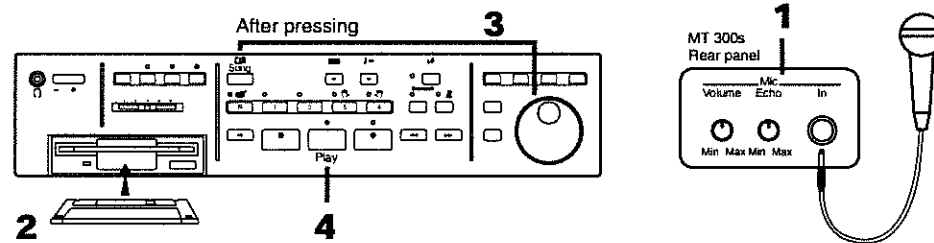

- 1. Plug in the microphone, and adjust the volume and echo levels.**

NOTE

Make connections only after first making sure that the power is turned off and volume levels turned all the way down on all equipment being connected.

- 2. Insert the music file disk into the disk drive.**

MEMO

Please see "Inserting and Removing Floppy Disks" (p.25).

- 3. Select a song.**

Press the [Song] button, and then use the [Dial] to select a song.

The song name appears in the upper part of the display.

If the song is in a key that is too high or too low for you, then turn the [Dial] while pressing the [Transpose] button to change the key of the song.

- 4. When you press the Play [▶] button, the song plays.**

Now, just song along.

MEMO

You can set the song so that the lyrics do not appear in the display. Please refer to "Turning Off the Display of Lyrics" (p.99).

The MT 300s features over 300 internal instrument and effects sounds. The instrument sounds are called “tones.”

With an electronic piano or similar keyboard connected to the MT 300s, you can use the connected keyboard to play the MT 300s’s instrument sounds.

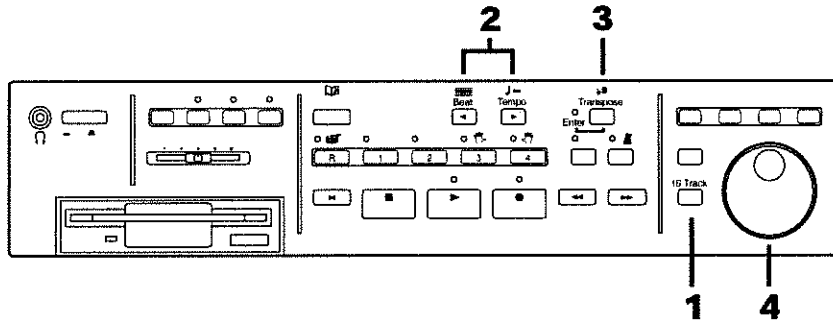

Press the [Song] button to display the Basic screen.

1. Press the [16 Track] button.

The 16-Track screen is displayed.

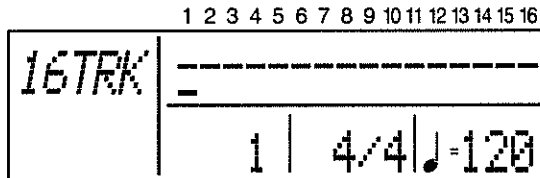

2. Select a part by pressing the Beat [◀] button or Tempo [▶] button to move the cursor (—) in the upper part of the screen.

When selecting the digital piano’s sounds (A or B), as in “Selecting piano sounds” (p.21), select parts other than 1, 3, 4, and 10.

3. When you press the [Transpose] button, the following screen is displayed.



Pressing the [Song] button returns you to the “16-Track screen.”

4. Rotate the [Dial] to select a tone.

Play the keyboard to confirm your selection.

MEMO

For more on tone names, please refer to “List of Tone Names” (p.107).

Only Drum Set and SFX Set sounds can be selected for Parts 10 and 11.

The Drum Set contains percussion instrument tones, and the SFX Set contains sound effects.

Different tones are played with each key.

The songs on the Music File Disk and on commercially available music files are divided into 16 separate parts, with each part containing different instrument sounds or tones.

On the MT 300s, you can switch each part's tones and change the volume levels and other settings of the tones on each part.

About a Song's Basic Settings

Tones, volume levels, basic tempos, and other settings for each part, as well as the settings determined at the beginning of each song are called "basic settings." On the MT 300s, you can listen to songs after temporarily making changes to the parameters of a song's basic settings—the state of each part's tone, volume, panpot, reverb, and chorus—and change the basic settings and basic tempo of the song itself.

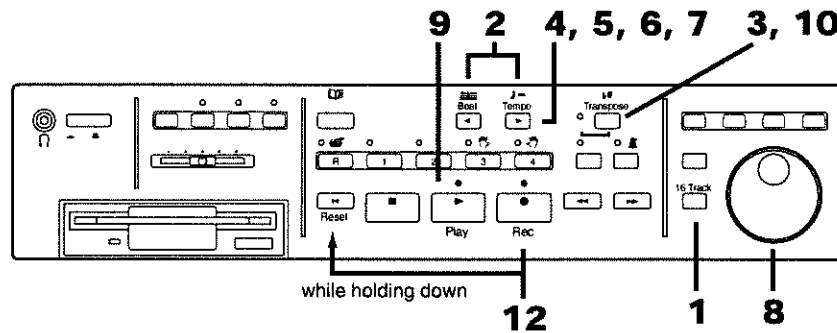

Press the [Song] button to display the Basic screen.

1. Press the [16 Track] button.

The 16-Track screen is displayed.

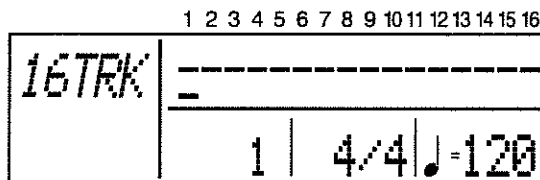

2. Select the part to which you want to make changes in the settings by pressing the Beat [◀] button or Tempo [▶] button to move the cursor (—) in the upper part of the screen.

3. When you press the [Transpose] button, the selected part appears in the display.

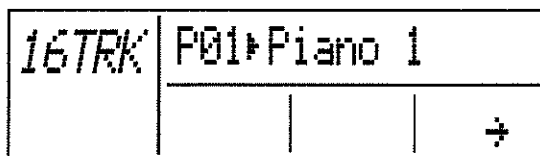

You can change the tone for the selected part in this screen.

If you have a digital piano or similar instrument connected, then you can play the keyboard to hear the selected tone.

- Pressing the Tempo [▶] button once calls up the screen in which you can adjust the volume of the selected part.

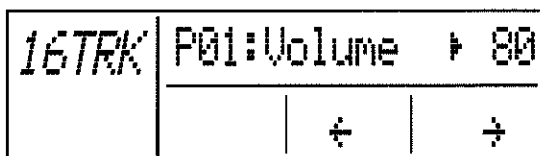

- Pressing the Tempo [▶] button once more calls up the screen in which you can adjust the panpot for the selected part.

The panpot is adjustable in the range between L63 (left) to 0 (center) to R63 (right).

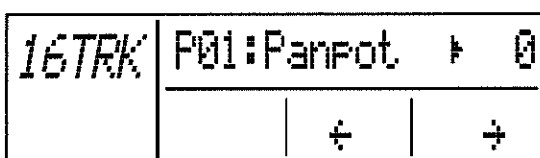

What is the Panpot?

TERMS

The setting that controls the perceived direction of the sound from the speakers within the left-right stereo field is known as the panpot. The panpot setting allows you to determine the position at which a sound is localized between the left and right speakers. The location is normally set at the center.

- Pressing the Tempo [▶] button once more calls up the screen in which you can adjust the depth of the reverb effect for the selected part.

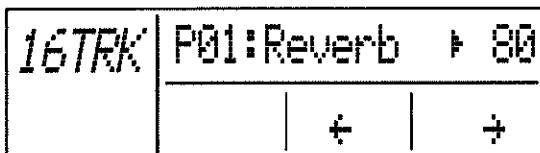

- Pressing the Tempo [▶] button once more calls up the screen in which you can adjust the depth of the chorus effect for the selected part.



Pressing the Beat [◀] button once returns you to the previous screen.

- In each of the above screens, the [Dial] is used to make the settings.
- When you press the Play [▶] button, playback of the song begins with the changed settings in effect. Play the song to confirm your settings.

Press the Stop [■] button, and playback of the song ceases.

Pressing the [Song] button undoes the settings changes for each part and returns you to the 16-Track screen.

- 10.** Press the [Transpose] button.
The changes for each part are saved, and you are then returned to the 16-Track screen.
- 11.** Carry out Steps 2-10 of the settings change procedure for any other parts as needed.
- 12.** Pressing the Reset [◀] button while pressing the Rec [●] button changes the song's basic settings.

NOTE

Songs whose basic settings have been changed are deleted when the MT 300s is turned off. Furthermore, you cannot select a different song until you delete the song with its basic settings changed. If you don't want to delete the song, then save it to a floppy disk (p.49).

NOTE

With some commercially available music files, you may be unable to make changes to the basic settings.

MEMO

You can select Drum Set and SFX Set for Parts 10 and 11. The Drum Set contains percussion instrument sounds, and the SFX Set contains sound effects. A different sound will be heard for each key.

NOTE

With songs that feature tone changes during the course of the song, the tone at the beginning of the song is used until the point in the song where the tone first changes.

NOTE

In "Selecting Piano Sounds" (p.21), when setting "A" and "B," the tones that are played may sound different than what you intend, even if you change the tones for Parts 1, 3, and 4.

MEMO

For more on tone names, please refer to "List of Tone Names" (p.107).

You can change the type of reverb and chorus effect applied to the sound. Please refer to "Adding Various Effects to Sounds" (p.97).

If You See This Screen Displayed

If you attempt to display the Basic screen without having gone through the "press the Reset [◀] button while pressing the Rec [●] button" procedure, the song's basic settings are left unchanged, and the following screen is displayed.

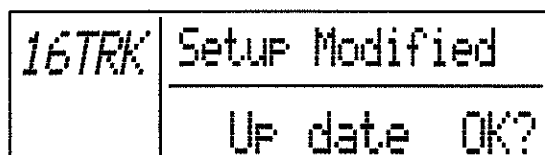

When you are not going to undo the changes to the settings

- 1.** Press the [Transpose] button.
The basic settings are changed, and you are returned to the Basic screen.

When you wish to undo the changes to the settings

- 1.** Press the [Song] button.
The changes to the settings are deleted, and you are returned to the Basic screen.

You can change the song's basic tempo.

For example, after changing a song's basic tempo, if you save the song to a floppy disk under a different name, you will have the same song with a different tempo. This can be convenient when you want to create a practice version of a song featuring a slower tempo.

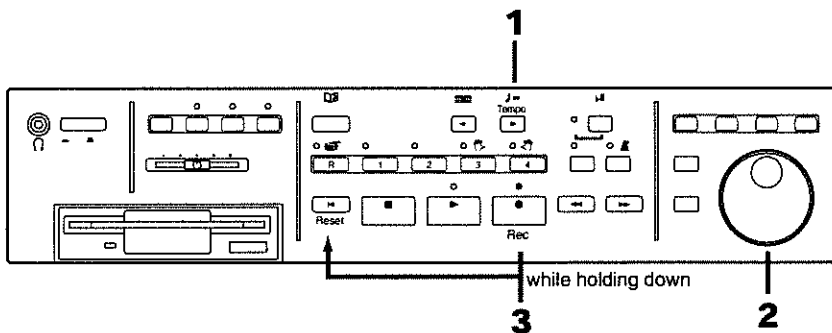

Press the [Song] button to display the Basic screen.

- 1.** Press the Tempo [▶] button.
- 2.** Set the tempo using the [Dial].
- 3.** While pressing the Rec [●] button, press the Reset [◀] button.

This changes the song's basic tempo.

Save the song to a floppy disk (p.49).

NOTE

Songs with their basic tempos changed are deleted when the power is turned off. Furthermore, you cannot select another song until the song with the altered basic tempo is deleted.

NOTE

For songs that have tempo changes within the song, first press the Reset [◀] button to return to the beginning of the song before carrying out this procedure. If you change the tempo without first returning to the beginning of the song, the relative change in tempo where the tempo does change will affect the tempo of the entire song.

You can play back a song with a single part prevented from being played. Playing back a song with only one of the sixteen parts prevented from being played is called "Minus One."
If there is a part you want to play yourself, stop that part from being sounded, and try playing the part yourself.

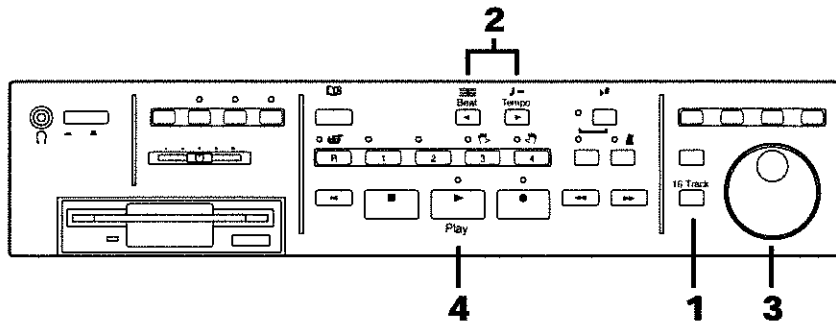

Press the [Song] button to display the Basic screen.

1. Press the [16 Track] button.

The 16-Track screen is displayed.

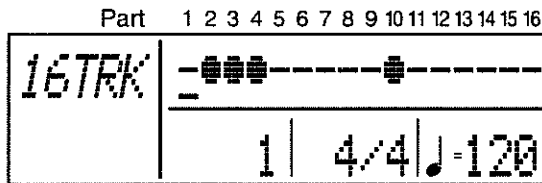

Displayed	Description
●	The part is played back
○	The part is not played back
-	There is no sound on this track

2. Press the Beat [◀] button or Tempo [▶] button to move the cursor (—) in the upper part of the screen to the part you want to set.

3. Rotate the [Dial] to change from "● (Played back)" to "○ (Muted)."
Parts with the ○ symbol are not played. If any parts you want to have played are designated by a ○, be sure to change them to ●.

4. When you press the Play [▶] button, playback of the song begins.
The sounds of parts designated by a "○ (not played back)", are not played. Try playing those parts yourself.

The MT 300s allow you to create ensemble works with ease.

A Variety of Ways to Record

There are four ways to record with the MT 300s.

- **Replace Recording**
New material is recorded as previously recorded material is erased (p.67).
- **Mix Recording**
Newly recorded material layered on previously recorded material (p.68).
- **Loop Recording**
A specified segment of the song is repeated, and the different sounds recorded with each pass are layered on one another (p.69).
- **Patch-In Recording**
While listening to a recorded performance, only a specified segment of the performance is rerecorded (p.70).

Although the MT 300s is normally set to “replace” recording, set each of the four recording modes according to your particular situation.

The Relationship Between Track Numbers and Parts

The sixteen separate parts of the 16-track sequencer correspond to the MT 300s's five track buttons as shown below.

Track Button	R	1	2	3	4
Part	10, 11	1	2, 5-9, 12-16	3	4

For example, if you select the [1] button and then record, material is actually recorded to Part 1.

However, the [R] button and [2] button include multiple parts; when the [R] is selected for recording, the material is recorded to Part 10; when the [2] button is selected, the signal goes to Part 2.

NOTE

On commercially available Roland SMF music files, Part 11 is included on Track 2. The correspondence of the other parts' track buttons is identical.

Here we introduce the basic procedure for creating ensemble works .
 This is a fundamental process. Combining this process with the MT 300s's functions,
 try the composing techniques that appeal to you.

How to Create Ensemble Works

To create an ensemble piece, first you must determine the imagery of the song, decid-
 ing which part will play what tone an so on. Then, after carrying out the sequence of
 setting rhythm patterns and bass, chord , and melody parts for each part's tone, you
 go on to record.

Determining the Basic Tempo and Beat for the Song

Let's set a song's basic tempo and beat.

1. Press the [Song] button.
2. Use the [Dial] ; "0 : New Song" appears in the upper part of the display screen.
 New Songs are assigned the number "0" and then recorded.

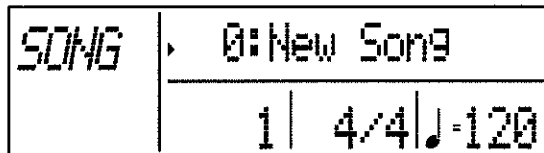

3. After pressing the Tempo [▶] button, use the [Dial] to select the basic tempo for the song.
4. After pressing the Beat [◀] button, use tthe [Dial] to select the basic beat/rhythm for the song.

NOTE

You cannot change the song's beat (rhythm) after recording is done. If you want to create a song during which the rhythm does change, please refer to "Creating Songs Featuring Beat Changes" (p.76).

MEMO

To change the basic tempo of a song, please refer to "Changing the Basic Tempo of the Song (p.59).

If you want to change the tempo on a recorded song, please refer to "Creating Songs Featuring Tempo Changes" (p.74).

Recording Drum Parts

First, let's record the rhythm parts.

HINT

It's easy to make your own rhythm part when you use the MT 300s's internal rhythm Patterns. There's no need to record each instrument's part one at a time, making it very convenient. Please refer to "Creating Rhythm Parts Easily" (p.77) and "Copying Rhythm Patterns" (p.82).

When you do want to record rhythm tracks one at a time, Loop Recording is a convenient way to do this.

Loop Recording

TERMS

What is Loop Recording?

Loop Recording is a recording method in which a specified segment of the song is repeated, and the different sounds recorded with each pass are layered on one another.

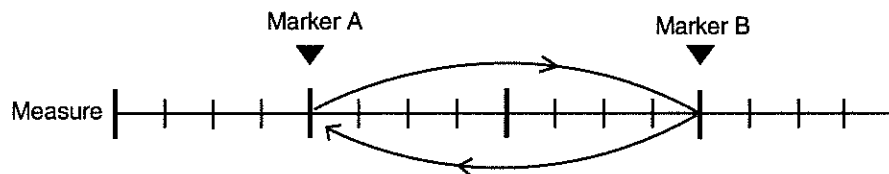

1. First, record the length of the song using no input.

If nothing has yet been recorded, selecting any track button or part in the 16-Track screen, prepare a "blank," an empty recording with the number of measures needed for the song, but without any performance input. This is called "Blank recording."

2. Define the segment to be repeated with Markers A and B.

Using the Bwd [◀◀] and Fwd [▶▶] buttons, move to the start of the segment to be repeated, then press the [A] button to set Marker A.

Similarly, go to the end of the segment and press the [B] button to set Marker B.

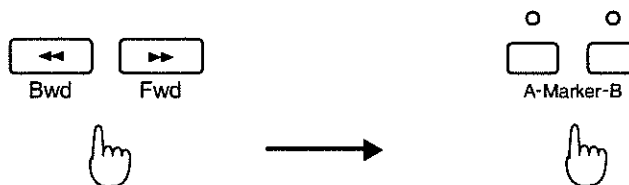

If no segment is specified by markers, then the entire song, from beginning to end, will repeat.

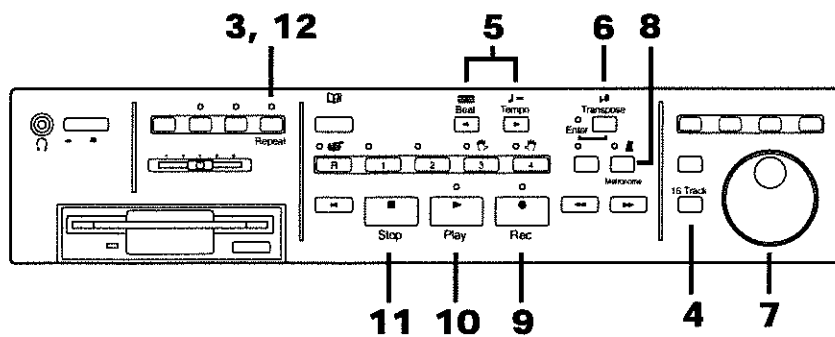

3. Press the [Repeat] button; the button's indicator lights.

This sets Loop Recording.

If at this point you press the [Repeat] button once more, the button's indicator goes off, and Loop Recording is canceled.

4. Press the [16 Track] button.
The 16 track screen is displayed.
5. Press the Beat [◀] button or Tempo [▶] button to move the cursor (—) in the upper part of the screen to Part 10.

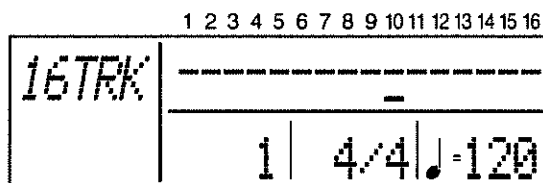

You can select Drum Set, SFX Set, and other tones for Parts 10 and 11. When recording, you should assign rhythm parts that use rhythm patterns and Drum Set tones to Part 10, and SFX sound effects to Part 11.

6. When you press the [Transpose] button, the following screen is displayed.

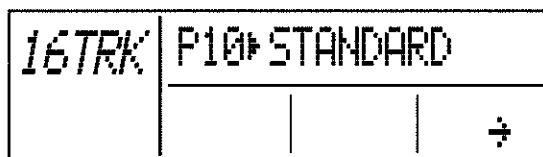

Pressing the [Song] button returns you to the "16-Track screen."

7. Rotate the [Dial] to select the Drum Set type.
8. If you want to record with the metronome sound playing, press the [Metronome] button, turning on its indicator.
The metronome sound is not recorded.
9. Press the Rec [●] button, turning on the button indicator.
The MT 300s is put into record standby mode.
10. Press the Play [▶] button, and after two measure of count sound, recording begins.
After the segment from Marker A to Marker B is recorded, recording continues after returning to Marker A.
Try recording the drum sounds in sequence, taking the kick drum first, followed by the snare, toms, and so on.
11. When you press the Stop [■] button, recording ceases.
After you have finished recording the first segment, shift the segment between markers A and B (p.32), and then record that section the same way.
12. After you have finished recording the drums, press the [Repeat] button, turning off its indicator.

When the Performance is Unsatisfactory

HINT By pressing the [Transpose] button while holding down the Rec [●] button, you can delete the sound recorded on a selected part.

Using the "Delete" method (p.86), delete the recorded measure(s).

HINT At times when you want to have the same rhythm pattern continued, copying the same measures with the "Copy" method (p.79) is convenient.

Recording the Bass Part

Next, record the bass part.

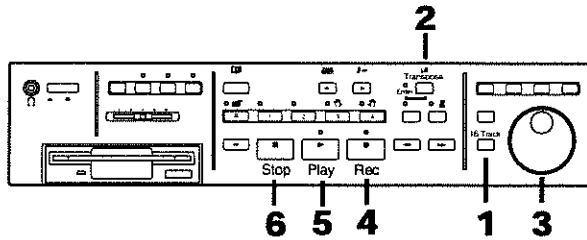

- 1.** In the 16-track screen, select the part you want to record.
You should record the bass part to Part 2.
- 2.** Pressing the [Transpose] button calls up the screen for the selected part.
- 3.** Using the [Dial] , select the bass tone, for example “69:Acoustic Bs.”
- 4.** Press the Rec [●] button, turning on its indicator.
This puts the keyboard in record standby.
- 5.** Press the Play [▶] button, and after two measure of count sound, recording begins.
- 6.** When you press the Stop [■] button, recording ceases.

Recording Melody and Chord Parts

As with the bass part, record these after selecting the parts and tones in the 16-Track screen.

When the chords and melody are recorded, the song is complete. If you want to make the song even fancier or more fully developed, you can record ornamental phrases, percussion parts, and so on.

NOTE

When you select a part that already has material recorded on it and then proceed with recording, then the previously recorded material is replaced by the newly-recorded material from the point where the new recording starts to where it stops.

HINT

When you want to listen to a part of the recorded performance, use rewind and fast forward to go the part you want to hear, and then play back the song from there (p.28).

If you just want to record over a section of the song, move to the point you want to do over and begin recording there. If you press the [Count In] button while in record standby, the button's indicator goes off, and you can begin recording after the two measures leading up to the current location are played back.

MEMO

You can change the volume and other settings for each part. Please refer to “Listening to Songs after Changing Instrument Sounds or Making Other Changes” (p.56).

You can record over sections specified using markers or the pedal. Please refer to “Recording Certain Segments Over Again” (p.70).

MEMO

By connecting a Roland EV-5 Expression Pedal (sold separately) to the Expression Pedal jack on the rear panel of the MT 300s, you can create songs featuring crescendo and decrescendo. You can adjust the volume with the Expression Pedal of parts selected in the 16-Track screen (p.17).

If you connect an optionally available Roland DP-2 Pedal Switch to the Start/Stop jack on the unit's rear panel, you will be able to use the pedal to start and stop recording (p.17, 98).

If the Following Screen Appears

After changing any part settings, if you then try to return to the basic screen without recording, the following screen appears.

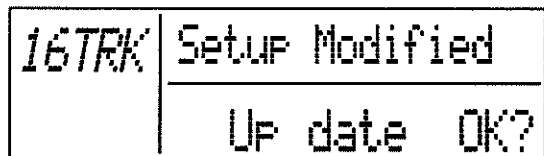

When Not Canceling Changes to the Settings

1. Press the [Transpose] button.

The song's basic settings are changed, and you are returned to the Basic screen.

When Canceling Changes to the Settings

1. Press the [Song] button.

After the setting changes are canceled, you are returned to the basic screen.

Saving Songs

After all the parts have been recorded, save the performance to a floppy disk. Recorded songs are deleted when the power is turned off. Furthermore, you cannot select another song until the current song is deleted. For more on how to save songs, please refer to "How to Save songs" (p.49).

NOTE

Poor handling of floppy disks may result in cracked disks, unplayable data, or other damage. When saving songs to floppy disks, making two copies of each disk is recommended. Keeping an additional copy of the same song on a separate floppy disk can provide great peace of mind.

Editing Songs

You can edit recorded songs in many ways, including deleting measures, copying measures to other locations in a song, and more. Please refer to "Chapter 4 Editing Functions" (p.78).

NOTE

When editing, you may be unable to recover a previous version of a song, or, depending on the settings, the results may be different than intended. We recommend that you save a copy of the song onto a floppy disk before you edit.

To Edit Songs Saved to Floppy Disks

When selecting the song you want to edit from the floppy disk, play the song until the left side of the lower screen stops flashing. After that, you can edit the song as usual.

The recording process whereby previous material is erased as new material is recorded is called "replace recording." The keyboard defaults to this method whenever the power is turned on

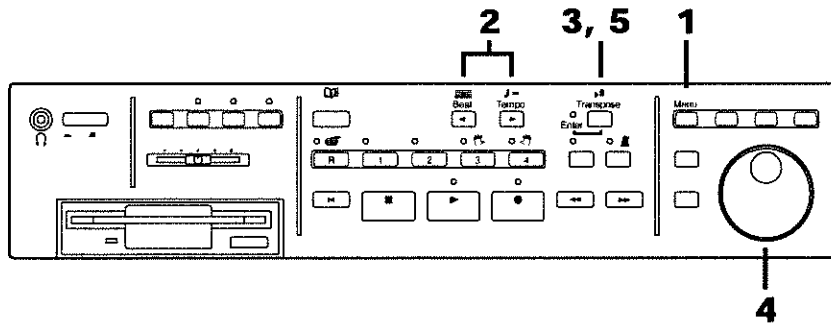

Press the [Song] button to display the Basic screen.

- 1.** Press the [Menu] button.
The Menu screen is displayed (p.15).
- 2.** Press the Beat [◀] or Tempo [▶] buttons until "Rec Mode" appears in the upper part of the screen.
- 3.** Press the [Transpose] button.
- 4.** Use the [Dial] until "Replace" appears in the upper part of the screen.

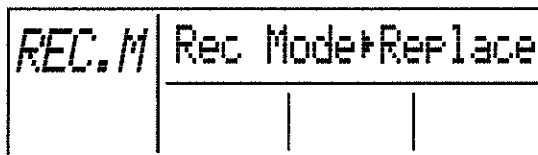

If you press the [Song] button, the settings are deleted, and you are returned to the Menu screen.

- 5.** Press the [Transpose] button.
The ordinary recording method is selected again, and you are returned to the Menu screen.

The recording process whereby newly recorded sounds are layered over a previously recorded performance is called “mix recording.” This method is convenient when, for example, you want to layer drum performances on the same part or build rhythm parts.

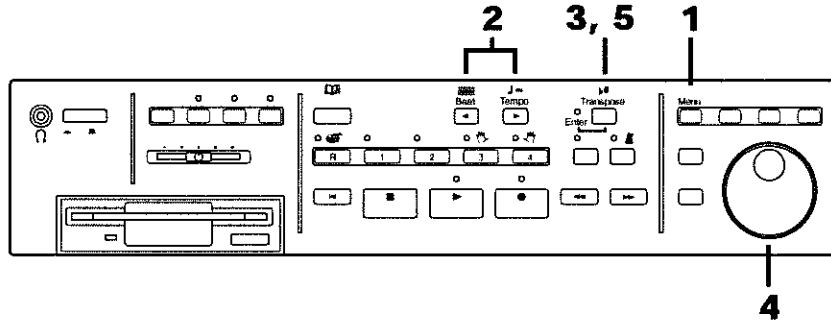

Press the [Song] button to display the Basic screen.

- 1.** Press the [Menu] button.
The Menu screen is displayed (p.15).
- 2.** Press the Beat [◀] or Tempo [▶] buttons until “Rec Mode” appears in the upper part of the screen.
- 3.** Press the [Transpose] button.
- 4.** Use the [Dial] until “Mix” appears in the upper part of the screen.

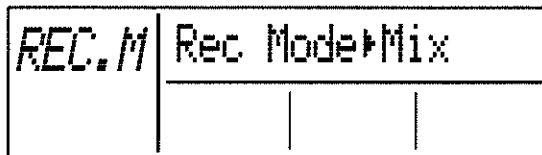

If you press the [Song] button, the settings are deleted, and you are returned to the Menu screen.

- 5.** Press the [Transpose] button.
This sets the “mix recording” mode.
Returns you to the Menu screen.

NOTE

After you have finished with mix recording, return to the usual recording mode. Please refer to “Using the Ordinary Recording Process” (p.67).

You can layer recorded sounds in a specified segment of a song, repeating the section any number of times while recording new material with each pass. This type of recording process is called “loop recording.”

Please see p.63 for the “loop recording” procedure.

With the following procedure, you can perform “loop recording” even when the [Repeat] button’s indicator is not on.

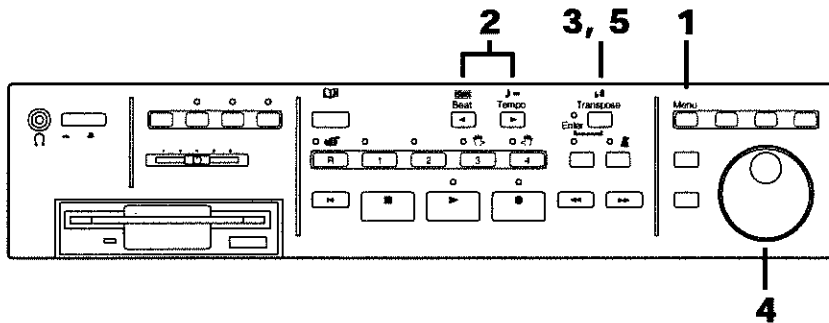

Press the [Song] button to display the Basic screen.

- 1.** Press the [Menu] button.
The Menu screen is displayed (p.15).
- 2.** Press the Beat [◀] or Tempo [▶] buttons until “Rec Mode” appears in the upper part of the screen.
- 3.** Press the [Transpose] button.
- 4.** Use the [Dial] until “Loop” appears in the upper part of the screen.



If you press the [Song] button, the settings are deleted, and you are returned to the Menu screen.

- 5.** Press the [Transpose] button.
This sets the “Loop Recording” mode.
Returns you to the Menu screen.

NOTE

After you have finished with loop recording, return to the usual recording mode. Please refer to “Using the Ordinary Recording Process” (p.67).

Rerecording only one segment of a song while listening to the playback of the recorded performance is called "Punch-In Recording."

With Punch-In Recording, you can use markers, buttons, and the pedal for punching in and out.

NOTE

When using the pedal for Punch-In Recording, be sure to first connect the optional Roland DP-2 Pedal Switch to the Start/Stop jack in the MT 300s's rear panel.

To use this method, first you need to change how the pedal works. See "Changing the Pedal Functions" (page 98).

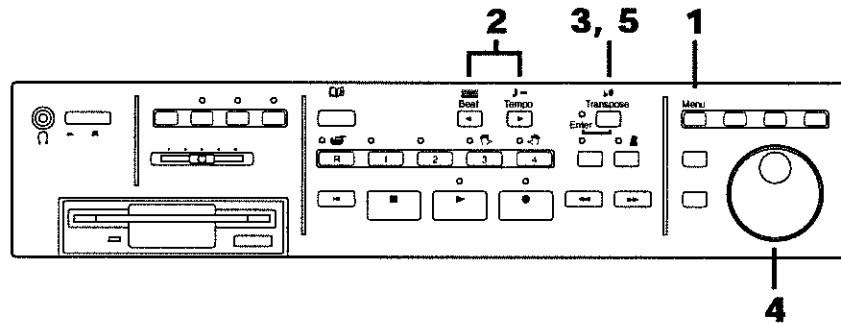

Press the [Song] button to display the Basic screen.

- 1.** Press the [Menu] button
The Menu screen is displayed (p.15).
- 2.** Press the Beat [◀] or Tempo [▶] buttons until "Rec Mode" appears in the upper part of the screen.
- 3.** Press the [Transpose] button.
- 4.** Use the [Dial] to select [A-Punch] or [M-Punch].

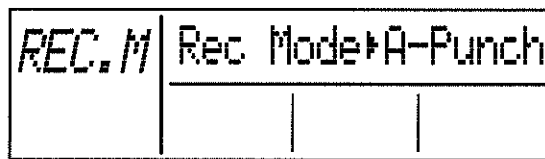

Displayed	Description
A-Punch	Records in the interval designated by Marker A and Marker B.
M-Punch	Recording begins at the point where either the Rec [●] button or the pedal is pressed.

If you press the [Song] button, the settings are deleted, and you are returned to the Menu screen.

- 5.** Press the [Transpose] button.
This sets the "Punch-In Recording" mode.
Returns you to the Menu screen.

NOTE

After you have finished with Punch-In Recording, return to the usual recording mode. Please refer to "Using the Ordinary Recording Process" (p.67).

Rerecording the Section Between Marker A and Marker B (A-Punch)

After first setting Marker A and Marker B to define the segment you want to record over and setting the recording process to "Punch-In Recording," proceed with the recording. The MT 300s goes into recording mode only between Marker A and Marker B, allowing you to record over the section from Marker A to Marker B.

- 1.** When recording over only a certain part or parts, select such parts in the 16-Track screen (p.64).
- 2.** Set Marker A at the beginning of the section you want to record over, and set Marker B at the end of the section.
Place Marker A and Marker B by using the Bwd [◀◀] button or Fwd [▶▶] button to move the markers to the desired locations. Then, press the Marker [A] and [B] buttons to set the markers.
- 3.** Pressing the Marker [A] button takes you to the point where Marker A is set.
- 4.** Press the Bwd [◀◀] button to move to the point where you want playback to begin.
- 5.** Press the Rec [●] button, turning on its indicator.
The MT 300s is put into record standby mode.
- 6.** If you are using the Track buttons in rerecording, press the Track buttons for those tracks you want to record over.
- 7.** Press the Play [▶] button.
After two measures of count sound, playback begins.
Recording begins at the point where Marker A is set.
Recording stops where Marker B is located, and the MT 300s reverts to playback only.
- 8.** When you press the Stop [■] button, playback of the song ceases.

Punching In and Out with the Buttons or the Pedal (M-Punch)

You can begin recording while a song is played back by either pressing the Rec [●] button or the pedal at a designated point. Pressing the Rec [●] button or pedal once again stops the recording, after which the MT 300s returns to playback mode.

MEMO

You must change the pedal's function beforehand when you use it for recording. Please refer to "Changing the Pedal Functions" (p.98).

- 1.** When recording over only a certain part or parts, select such parts in the 16-Track screen (p. 64).
- 2.** Press the Bwd [◀◀] button to move to the point where you want playback to begin.
- 3.** Press the Rec [●] button, turning on its indicator.
The MT 300s is put into record standby mode.
- 4.** If you are using the Track buttons in rerecording, press the Track buttons for those tracks you want to record over.
- 5.** Press the Play [▶] button.
After two measures of count sound, playback begins.
- 6.** When you reach the point where you want recording to begin, press the Rec [●] button or depress the pedal.
- 7.** When you then reach the point where you want recording to stop, press the Play [▶] button or depress the pedal once more.
When recording is stopped, the MT 300s reverts to playback mode.
- 8.** When you press the Stop [■] button, playback of the song ceases.

You can record songs that start with pickups. Songs that begin on a beat other than the downbeat are called "songs with pickups."

NOTE

To record a song with an Upbeat, first you need to go back to ordinary recording method. Take a look at "Using the Ordinary Recording Process" (p.67).

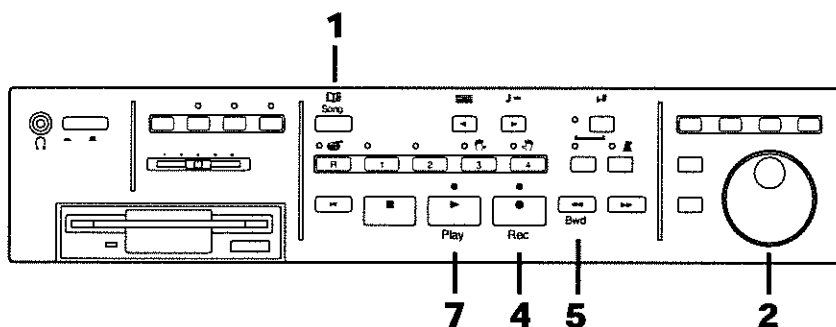

1. Press the [Song] button.
2. Use the [Dial] ; "0 : New Song" appears in the upper part of the screen.
3. Make the necessary preparations before recording.
 Select the basic tempo and rhythm, tones, and so on for the song (p.45).
 When recording in the "16-Track screen," select the parts to be recorded (p.64).
4. Press the Rec [●] button; its indicator lights.
 This puts the keyboard in record standby.
5. Press the Bwd [◀◀] button once.
 The measure number on the screen changes to "PU."

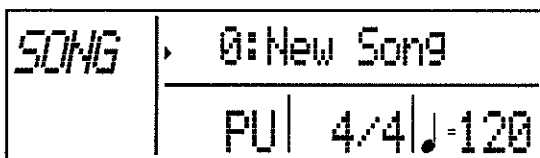

6. When recording using the track buttons, press the buttons for the tracks you want to record to.
7. Press the Play [▶] button to begin recording.

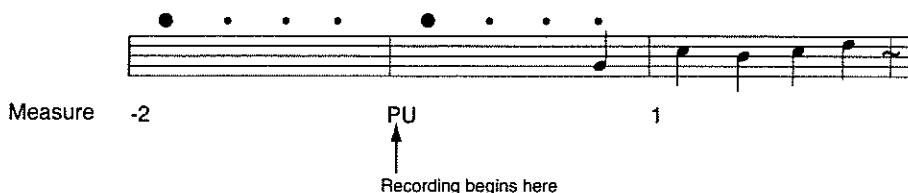

You can add tempo changes (such as ritardando) to the song being recorded. This recording of the tempo is called "Tempo Recording."

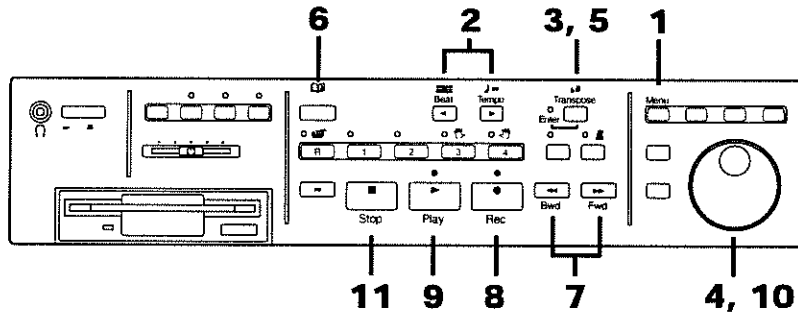

Changing the Tempo While Listening to the Song

Press the [Song] button to display the Basic screen.

- 1.** Press the [Menu] button.
The Menu screen is displayed (p.15).
- 2.** Press the Beat [◀] or Tempo [▶] buttons until "Rec Mode" appears in the upper part of the screen.
- 3.** Press the [Transpose] button.
- 4.** Use the [Dial] until "Tempo" appears in the upper part of the screen.



If you press the [Song] button, the settings are deleted, and you are returned to the Menu screen.

- 5.** Press the [Transpose] button.
This selects "Tempo Recording."
You are returned to the Menu screen.
- 6.** Press the [Song] button to display the Basic screen.
- 7.** Using the Bwd [◀◀] button or Fwd [▶▶] button, go to a point a little before the measure where you want to change the tempo.
- 8.** Press the Rec [●] button, turning on its indicator.
The MT 300s is put into record standby mode.
- 9.** Press the Play [▶] button.
The song is played back, and recording of the tempo begins.
- 10.** When you reach the point where you want the tempo changed, adjust the tempo with the [Dial].
- 11.** Press the Stop [■] button, and playback of the song ceases.

Changing the Tempo from a Designated Measure

You can also change the tempo from the beginning of the measure to which you have moved.

1. Select Tempo recording.

Use the same procedure as in "Changing the Tempo While Listening to the Song."

2. Press the Bwd [◀◀] button or Fwd [▶▶] button to go to the measure where you want the tempo changed.

3. Press the Rec [●] button, turning on its indicator.

The MT 300s is put into record standby mode.

4. Rotate the [Dial] to change the tempo.

5. Press the [Transpose] button.

Recording of the tempo is finished, and the tempo of the song is changed, starting at the beginning of the measure to which you moved.

NOTE

After you have finished with Tempo Recording, return to the usual recording mode. Please refer to "Using the Ordinary Recording Process" (p.67).

NOTE

You cannot record performances while in Tempo Recording mode.

NOTE

Even when you press the Rec [●] button while pressing the Tempo [▶] button, you can still go make Tempo Recording settings. If you do, Tempo Recording is canceled when you stop recording.

MEMO

If you want to restore the previous tempo, delete the tempo data at the place where the tempo was recorded. For an explanation of how to delete the information of tempo settings, refer to the "Erasing Measures (Erase)" (p.88).

You can create songs that feature changes in the beat.

NOTE

You cannot make changes to the beat of a song after it has been recorded.

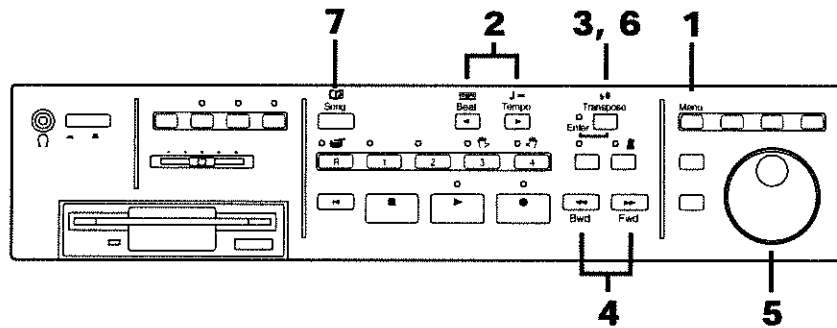

Press the [Song] button to display the Basic screen.

- 1.** Press the [Menu] button.
The Menu screen is displayed (p.15).
- 2.** Press the Beat [◀] or Tempo [▶] buttons until “Beat Map” appears in the upper part of the screen.
- 3.** Press the [Transpose] button, and the following screen will appear:

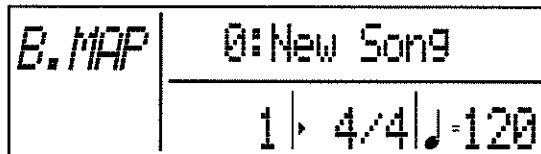

Pressing the [Song] button returns you to the Menu screen.

- 4.** Press the Bwd [◀◀] and Fwd [▶▶] buttons to move to the measure whose beat you want to change.
- 5.** Rotate the [Dial] to select a beat.
- 6.** When you press the [Transpose] button, the beat in the measure you moved to changes to your selected beat.
- 7.** When you're done making the setting for the beat, press the [Song] button some times to display the basic screen.
- 8.** Start a recording.

The MT 300s features many internal rhythm patterns. Recording these rhythm patterns allows you to make rhythm parts very easily. Rhythm patterns are recorded to Part 10 (the [R] button).

MEMO

The kind of rhythm patterns can be changed. Please refer to "List of Rhythm Patterns" (p.111).

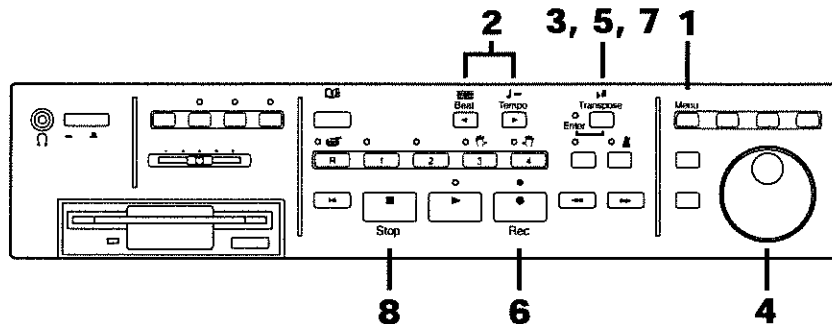

Press the [Song] button to display the Basic screen.

- 1. Press the [Menu] button.**
The Menu screen is displayed (p.15).
- 2. Press the Beat [◀] or Tempo [▶] buttons until "Rhythm Patrn" appears in the upper part of the screen.**
- 3. Press the [Transpose] button, and the following screen will appear:**

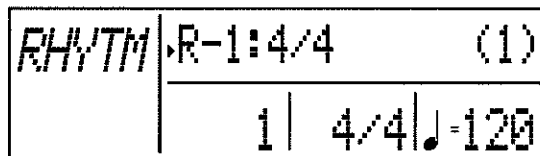

Pressing the [Song] button returns you to the Menu screen.

- 4. Use the [Dial], select a rhythm pattern.**
For example, with "4/4 (1)" displayed, it means that the rhythm pattern will be one measure in length, with four beats in the measure.
- 5. When you press the [Transpose] button, the rhythm pattern sounds.**
Confirm your selected rhythm pattern.
Pressing the Stop [■] button or the [Transpose] button once more stops the rhythm pattern.
- 6. Press the Rec [●] button; its indicator lights.**
This puts the keyboard in record standby.
- 7. Press the [Transpose] button.**
The rhythm pattern begins to play while recording begins simultaneously.
- 8. Press the Stop [■] button after recording the required number of measures.**
The rhythm pattern stops, and recording ends.
Pressing the [Transpose] button stops only the rhythm pattern, while recording continues.

MEMO

Rhythm patterns can be added to songs without going through the recording process. Please refer to "Copying Rhythm Patterns" (p.82).

There is a wide variety of ways you can edit performances recorded with the MT 300s.

NOTE

Once you edit a song, you may be unable to recover a previous or original version of the song, and depending on the settings, the results may be different than you intend. We recommend that you save a copy of the song onto a floppy disk before you edit.

Displayed	Description
Copy	Copies measures and internal rhythm patterns (p.79, p.82)
Quantize	Corrects unevenness in the rhythm of recorded performances (p.85)
Delete	Deletes measures (p.86)
Insert	Inserts empty measures (p.87)
Erase	Erases measures (p.88)
Transpose	Transposes parts (p.90)
Part Exchange	Switches part sounds (p.91)
Note Edit	Edits notes one at a time (p.92).
PC Edit	Edits tone changes made during songs (p.93)

NOTE

You can undo the immediately preceding editing operation.

Depending on what you edit, you may be unable to recover a previous or original version of a song.

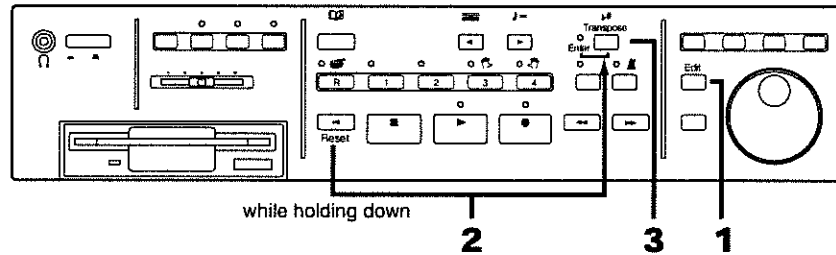

Press the [Song] button to display the Basic screen.

- 1. Press the [Edit] button.**
The Edit screen is displayed (p.15).
- 2. While pressing the Reset [⏪] button, press [Transpose] button.**
The canceled editing function is displayed on the upper portion of the screen.



Pressing the [Song] button once returns the previous screen.

- 3. Press the [Transpose] button.**
This undoes the operation of the editing function displayed on the screen.

You can take a part of the performance and copy the same part and put it in a different measure, or copy measures and place them in other parts. This is convenient when you want to create a song where the same kind of phrases is repeated.

First... Select the Section to be Copied

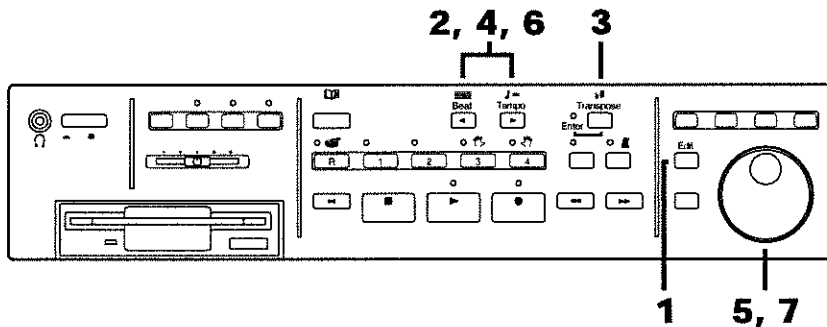

Press the [Song] button to display the Basic screen.

- 1.** Press the [Edit] button.
The Edit screen is displayed (p.15).
- 2.** Press the Beat [◀] or Tempo [▶] buttons until “Copy” appears in the upper part of the screen.
- 3.** Press the [Transpose] button, and the following screen will appear:

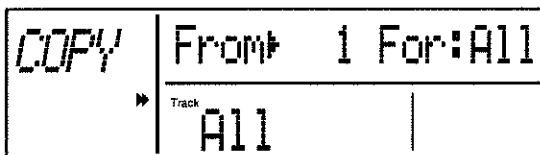

- 4.** Using the Beat [◀] or Tempo [▶] buttons, move the cursor (▸) to the “From” or “For.”

Displayed	Description
From	Selects the number of the first measure to be copied.
For	Selects the number of measures to be copied. When “All” is selected, everything from the measure selected with “From” to the end of the song is selected.

- 5.** Rotate the [Dial] to select the segment you want to copy.
For example, if you want to copy the interval from the beginning of Measure 5 to the end of Measure 8, specify “From : 5” and “For : 4” to set the four-measure interval.
- 6.** Using the Beat [◀] or Tempo [▶] buttons, move the cursor (▸) to the left side of the lower part of the screen.
- 7.** With the [Dial], select the track button number or part number to be copied.
If you select “All,” all parts in the same interval are copied to the same location.
If you selected a track button number, then only that track button can be copied.

Second... Select the Copy Destination

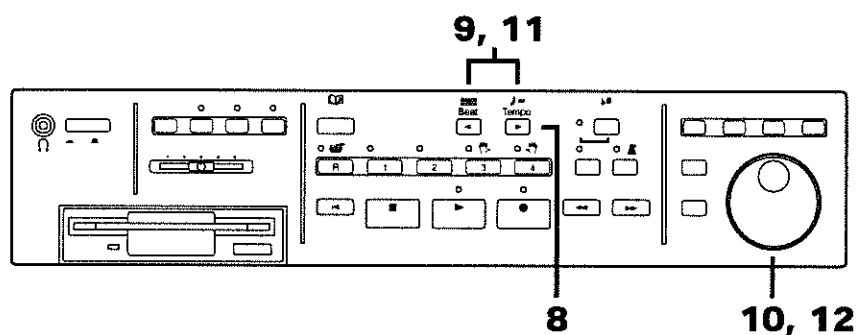

- 8.** With the cursor (▶) in the left side of the lower part of the screen, press the Tempo [▶] button.

The following screen is called up.

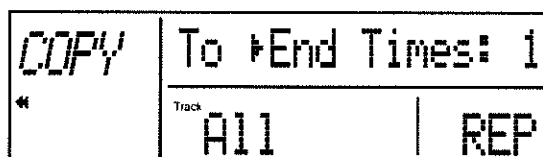

Pressing the Beat [◀] button once returns you the previous screen.

- 9.** Using the Beat [◀] or Tempo [▶] buttons, move the cursor (▶) to the "To" or "Times."

Displayed	Description
To	For selecting the number of the first destination measure. If you select "End," the last measure of the song is selected.
Times	For selecting the number of times the measures are copied.

- 10.** Rotate the [Dial] to select the location you want the measures copied to.

For example, if you want to copy the four measures 5 to 8 to the interval from Measure 12 to Measure 23, you can specify "To : 12" and "Times : 3" to copy the four-measure interval (three times).

In 7 above, if you chose the number of a Track button or "All," then go to 13 below.

- 11.** Using the Beat [◀] or Tempo [▶] buttons, move the cursor (▶) to the left side of the lower part of the screen.

- 12.** Rotate the [Dial] to select the destination part number.

Third... Select the Copy Type

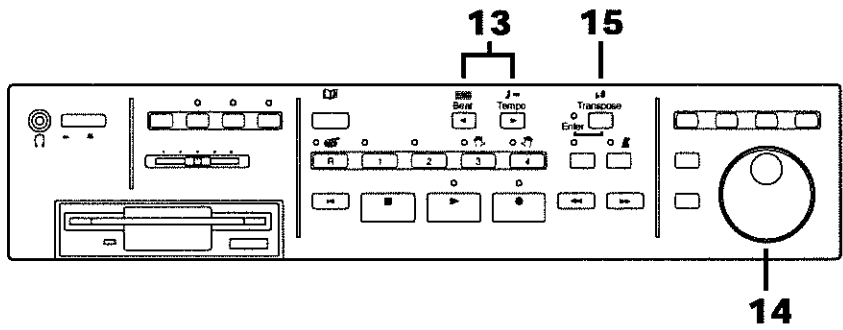

- 13.** Using the Beat [◀] or Tempo [▶] buttons, move the cursor (▸) to the right side of the lower part of the screen.
- 14.** Rotate the [Dial] to select the Copy Type.

Displayed	Description
REP	If there is any performance recorded in the copy destination, the previous material is deleted, replaced by the material being copied.
MIX	If there is any performance recorded in the copy destination, the copied material is layered over the previously recorded material. If the tone of the copied material is different than that at the destination, the copied material's tone changes to that of the destination.
INS	If there is any performance recorded in the copy destination, the copied portion is inserted at the destination, without the previous material being deleted. The song is extended only by the length of the inserted measures.

Example: Copying the first measure



Measure 1 replaces measure 3 (REP)

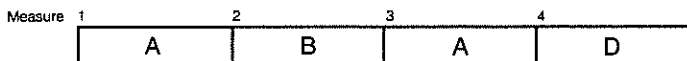

Measure 1 is mixed with measure 3 (MIX)

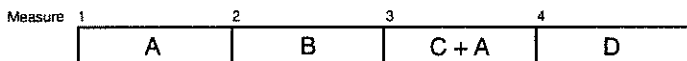

Measure 1 is inserted at measure 3 (INS)

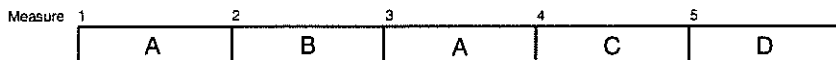

Fourth... Copy

If you press the [Song] button at this point, you will be returned to the Edit screen.

15. When all of the settings are finished, press the [Transpose] button.

Copying then begins.

When copying is finished, you are returned to the Edit screen.

The MT 300s features many internal rhythm patterns. You can make rhythm parts very easily by copying these rhythm patterns.

MEMO

The kind of rhythm patterns can be changed. Please refer to "List of Rhythm Patterns" (p.111).

NOTE

You can record rhythm patterns only to Parts 10 (the [R] button).

First... Select the rhythm pattern to be copied

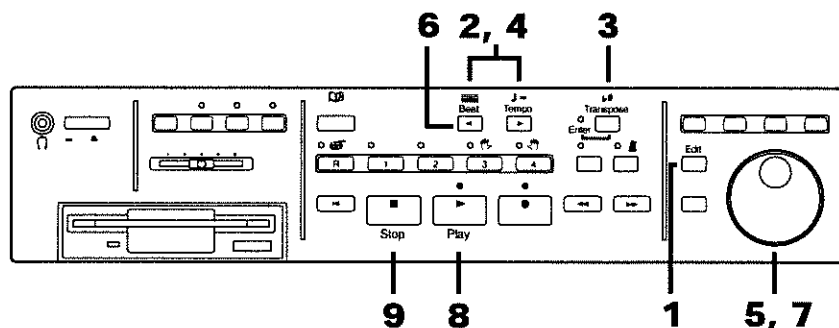

Press the [Song] button to display the Basic screen.

1. Press the [Edit] button.
The Edit screen is displayed (p.15).
2. Press the Beat [◀] or Tempo [▶] buttons until "Copy" appears in the upper part of the screen.
3. Press the [Transpose] button, and the following screen will appear:

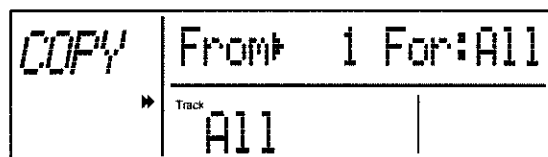

4. Using the Beat [◀] or Tempo [▶] buttons, move the cursor (▸) to the left side of the lower part of the screen.
5. Rotate the [Dial] to select "R.Pt."
This changes the screen to the following.

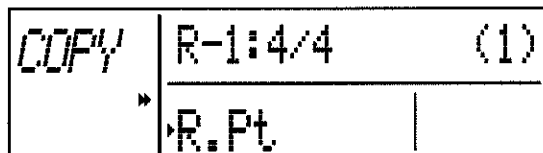

6. Using the Beat [◀] button, move the cursor (▸) to the upper part of the screen.
7. Use the [Dial] to select the rhythm pattern.
For example, with "4/4 (1)" displayed, it means that the rhythm pattern will one measure in length, with four beats in the measure.
8. Press the Play [▶] button, and the rhythm pattern starts playing.
9. Press the Stop [■] button and the rhythm pattern stops.

Second... Select the Copy Destination

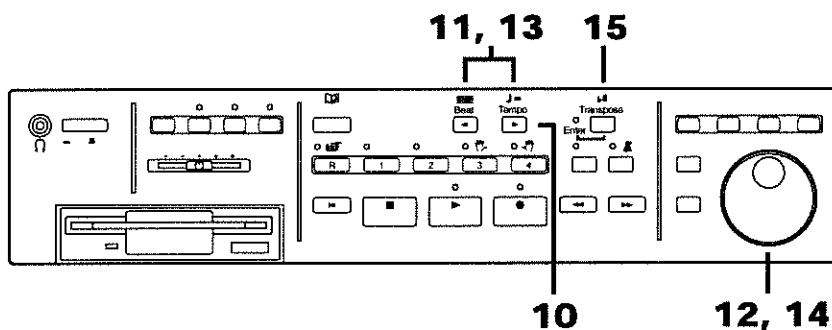

10. Press the Tempo [▶] button twice.
The following screen is called up.

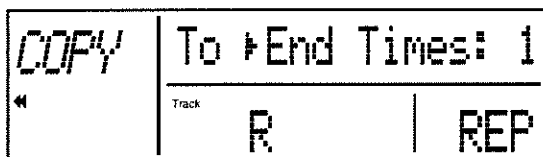

Pressing the Beat [◀] button once returns you the previous screen.

- 11.** Using the Beat [◀] or Tempo [▶] buttons, move the cursor (▶) to the “To” or “Times.”

Displayed	Description
To	Selects the number of the first destination measure.
Times	For selecting the number of times the pattern is copied.

- 12.** Rotate the [Dial] to select the spot where you want the measures copied.

For example, if you want to create a song in which a one-measure rhythm pattern is repeated from the first measure to the fourth measure, then you can make four copies of the first measure by specifying “To : 1” and “For : 4” and placing them in the song, starting with Measure 1.

Third... Select the Copy Type

- 13.** Using the Beat [◀] or Tempo [▶] buttons, move the cursor (▶) to the right side of the lower part of the screen.

- 14.** Rotate the [Dial] to select the Copy Type.

Displayed	Description
REP	If there is any performance recorded in the copy destination, the previous material is deleted, replaced by the material being copied.
MIX	If there is any performance recorded in the copy destination, the copied material is layered over the previously recorded material. If the sounds in the copied material are different than those at the destination, the sounds in the copied material change to those used at the destination.
INS	If there is any performance recorded in the copy destination, the copied portion is inserted at the destination, without the previous material being deleted. The song is extended only by the length of the inserted measures.

Fourth... Copy

If you press the [Song] button at this point, you will be returned to the Edit screen.

- 15.** When all of the settings are finished, press the [Transpose] button.

Copying then begins.

When copying is finished, you are returned to the Edit screen.

MEMO

You can record rhythm patterns. Please refer to “Creating Rhythm Parts Easily” (p.77).

You can correct any differences in timing in a performance and have everything set to the timing you specify. This is called “quantizing.”
 For example, let’s say you intend to play a quarter-note rhythm, but actually there is a little unevenness before and after the beats. In this case, if you quantize at quarter-note (1/4) timing, you can correctly match the rhythms.

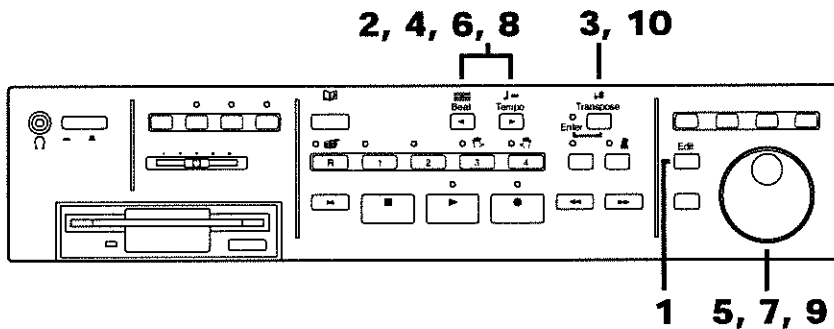

Press the [Song] button to display the Basic screen.

- 1.** Press the [Edit] Button.
The Edit screen is displayed (p.15).
- 2.** Press the Beat [◀] or Tempo [▶] buttons until “Quantize” appears in the upper part of the screen.
- 3.** Press the [Transpose] button, and the following screen will appear:

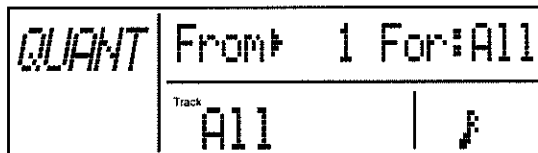

- 4.** Using the Beat [◀] or Tempo [▶] buttons, move the cursor (▸) to the “From” or “For.”

Displayed	Description
From	Selects the number of the first measure to be quantized.
For	Selects the number of measures to be quantized. When “All” is selected, everything from the measure selected with “From” to the end of the song is selected.

- 5.** Rotate the [Dial] to select the segment you want to quantize.
- 6.** Using the Beat [◀] or Tempo [▶] buttons, move the cursor (▸) to the left side of the lower part of the screen.
- 7.** With the [Dial], select the number of the track button or part to be quantized.
Selecting “All,” all parts in the same interval are quantized.

8. Using the Beat [◀] or Tempo [▶] buttons, move the cursor (▶) to the right side of the lower part of the screen.
9. Rotate the [Dial] to select the quantize timing.
Pressing the [Song] button at this point cancels the settings and returns you to the Edit screen.
10. When all of the settings are finished, press the [Transpose] button.
Quantizing then begins.
When the quantizing is finished, you are returned to the Edit screen.

You can delete parts of a performance. When you delete part of a performance, the rest of the performance that follows is shifted forward. This process of removing a portion of a performance is called "deleting."

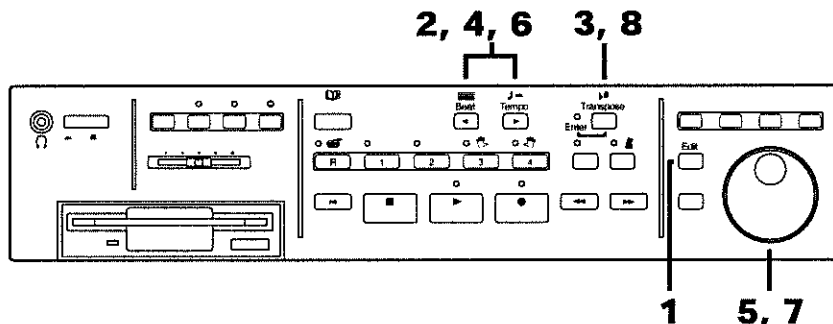

Press the [Song] button to display the Basic screen.

1. Press the [Edit] Button.
The Edit screen is displayed (p.15).
2. Press the Beat [◀] or Tempo [▶] buttons until "Delete" appears in the upper part of the screen.
3. Press the [Transpose] button, and the following screen will appear:

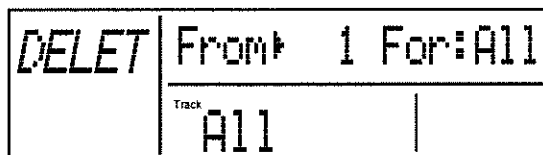

4. Using the Beat [◀] or Tempo [▶] buttons, move the cursor (▶) to the "From" or "For."

Displayed	Description
From	Selects the number of the first measure of the segment being deleted.
For	Selects the number of measures to be deleted. When "All" is selected, everything from the measure selected with "From" to the end of the song is selected.

- 5.** Rotate the [Dial] to select the segment to be deleted.
- 6.** Using the Beat [◀] or Tempo [▶] buttons, move the cursor (▸) to the left side of the lower part of the screen.
- 7.** With the [Dial], select the number of the track button or part to be deleted.
If you select "All," all parts in the same interval are deleted.
Pressing the [Song] button at this point cancels the settings and returns you to the Edit screen.
- 8.** When all of the settings are finished, press the [Transpose] button.
Deletion then begins.
When deletion is finished, you are returned to the Edit screen.

Were measure 3 to be deleted...

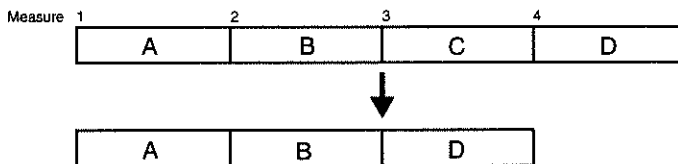

You can insert blank measures in a performance at locations you specify. This is called "insert."

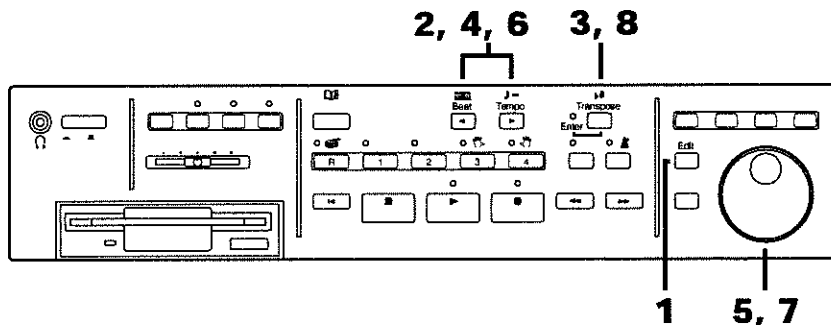

Press the [Song] button to display the Basic screen.

- 1.** Press the [Edit] button.
The Edit screen is displayed (p.15).
- 2.** Press the Beat [◀] or Tempo [▶] buttons until "Insert" appears in the upper part of the screen.
- 3.** Press the [Transpose] button, and the following screen will appear:

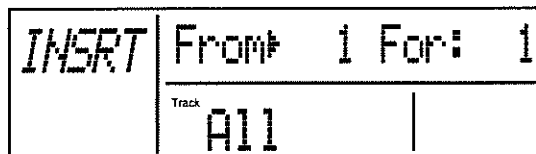

- Using the Beat [◀] or Tempo [▶] buttons, move the cursor (▶) to the “From” or “For.”

Displayed	Description
From	For selecting the number of the measure where the new measure are inserted. If you select “End,” the end of the song is selected.
For	For selecting the number of measures to be inserted.

- Rotate the [Dial] to select the segment into which the measures are to be inserted.
- Using the Beat [◀] or Tempo [▶] buttons, move the cursor (▶) to the left side of the lower part of the screen.
- With the [Dial], select the number of the track button or part to be inserted.
If you select “All,” the same number of measures is inserted in all parts in the same place. Pressing the [Song] button at this point cancels the settings and returns you to the Edit screen.
- When all of the settings are finished, press the [Transpose] button.

Insertion then begins.
When insertion is finished, you are returned to the Edit screen.

Here is what happens when an empty measure is inserted at measure 3...

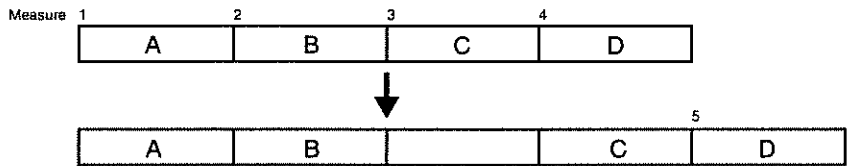

You can empty measures in a specified segment of a song without cramping the song length. This emptying of measures is called “erasing.”

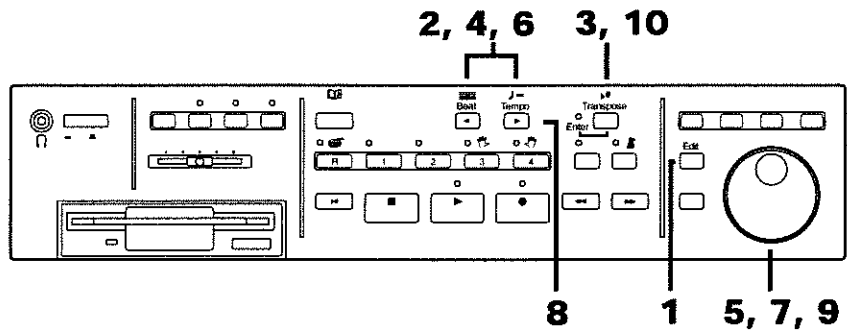

Press the [Song] button to display the Basic screen.

- Press the [Edit] button.
The Edit screen is displayed (p.15).
- Press the Beat [◀] or Tempo [▶] buttons until “Erase” appears in the upper part of the screen.

- 3.** Press the [Transpose] button, and the following screen will appear:

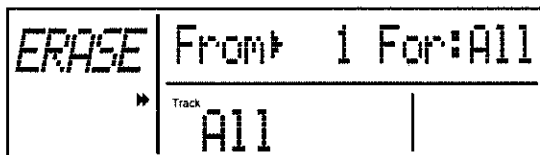

- 4.** Using the Beat [◀] or Tempo [▶] buttons, move the cursor (▶) to the “From” or “For.”

Displayed	Description
From	Selects the number of the first measure of the segment being erased.
For	Selects the number of measures to be erased. When “All” is selected, everything from the measure selected with “From” to the end of the song is selected.

- 5.** Rotate the [Dial] to select the segment you want to erase.
- 6.** Using the Beat [◀] or Tempo [▶] buttons, move the cursor (▶) to the left side of the lower part of the screen.
- 7.** With the [Dial], select the number of the track button or part to be erased.
Selecting “All,” all parts over the same interval are erased.
- 8.** With the cursor (▶) in the left side of the lower part of the screen, press the Tempo [▶] button.

The following screen is called up.



Pressing the Beat [◀] button once returns you the previous screen.

In this screen, you can select the kind of information you want erased from the selected measure or measures.

Displayed	Description
All	All performance information—notes, tempos, program changes, volume changes, and so on—are erased.
Tempo	Tempo information is erased. By erasing the tempo information for all measures, you can have a song featuring rhythm changes become a song with a fixed tempo. In such instances, you do not need to select track buttons or parts.
Prog.Chang	Program change information (p.93) is erased.
Note	Only notes are erased.
ExceptNote	All performance information except key and pedal information is erased.
Expression	Expression (volume change) information is erased. If any parts contain volume changes made with the Expression pedal, then starting from the point where the measures are erased, the volume is fixed at one level.

9. Rotate the [Dial] to select the information to be erased.
Pressing the [Song] button at this point cancels the settings and returns you to the Edit screen.
10. When all of the settings are finished, press the [Transpose] button.
Erasing then begins.
When the erasing is finished, you are returned to the Edit screen.

You can transpose each part individually.

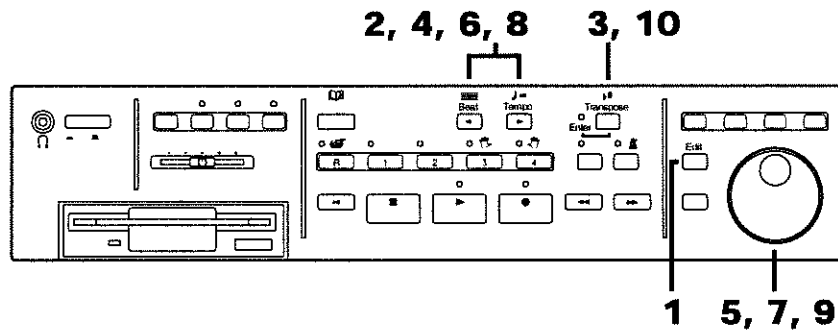

Press the [Song] button to display the Basic screen.

1. Press the [Edit] button.
The Edit screen is displayed (p.15).
2. Press the Beat [◀] or Tempo [▶] buttons until “Transpose” appears in the upper part of the screen.
3. Press the [Transpose] button, and the following screen will appear:

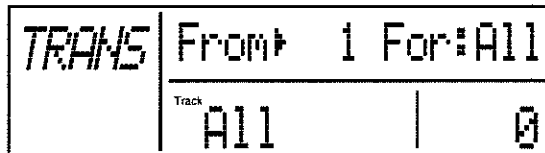

4. Using the Beat [◀] or Tempo [▶] buttons, move the cursor (▸) to the “From” or “For.”

Displayed	Description
From	Selects the number of the first measure of the segment being transposed.
For	Selects the number of measures to be transposed. When “All” is selected, everything from the measure selected with “From” to the end of the song is selected.

5. Rotate the [Dial] to select the segment you want to transpose.
6. Using the Beat [◀] or Tempo [▶] buttons, move the cursor (▸) to the left side of the lower part of the screen.
7. With the [Dial], select the number of the track button or part to be transposed.

- 8.** Using the Beat [◀] or Tempo [▶] buttons, move the cursor (▸) to the right side of the lower part of the screen.
- 9.** Rotate the [Dial] to select the amount of transposition.
You can transpose over a range of -24 to +24 (by semitones).
Pressing the [Song] button at this point cancels the settings and returns you to the Edit screen.
- 10.** When all of the settings are finished, press the [Transpose] button.
Transposition then begins.
When the transposition is finished, you are returned to the Edit screen.

You can switch sounds that have been recorded to one part with sounds recorded to a different part. This switching of material on parts is called "Part Exchange."

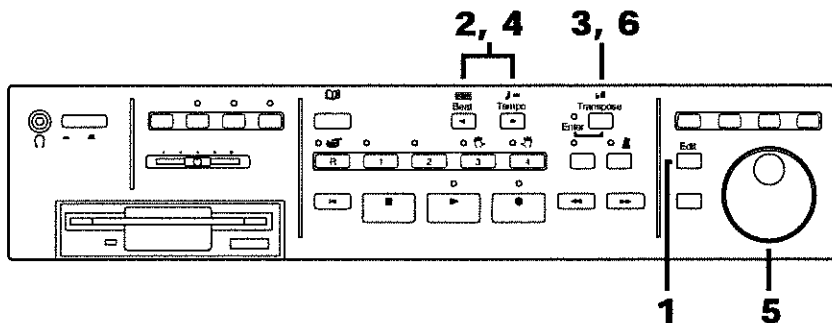

Press the [Song] button to display the Basic screen.

- 1.** Press the [Edit] button.
The Edit screen is displayed (p.15).
- 2.** Press the Beat [◀] or Tempo [▶] buttons until "Part Exchange" appears in the upper part of the screen.
- 3.** Press the [Transpose] button, and the following screen will appear:

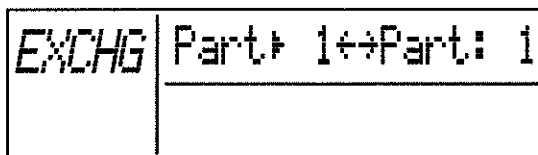

- 4.** Using the Beat [◀] or Tempo [▶] buttons, move the cursor (▸).
- 5.** Rotate the [Dial] to select the two parts you want to exchange.
Pressing the [Song] button at this point cancels the settings and returns you to the Edit screen.
- 6.** Press the [Transpose] button.
Exchange of the parts begins.
When the exchange is finished, you are returned to the Edit screen.

You can revise recorded performances one note at a time.

"Notes" being single sound units, revising a performance note by note is called "Note Edit."

You can make the following modifications.

- Delete mistaken notes
- Change the scale of a single note
- Change the strength a single note is played on the keyboard

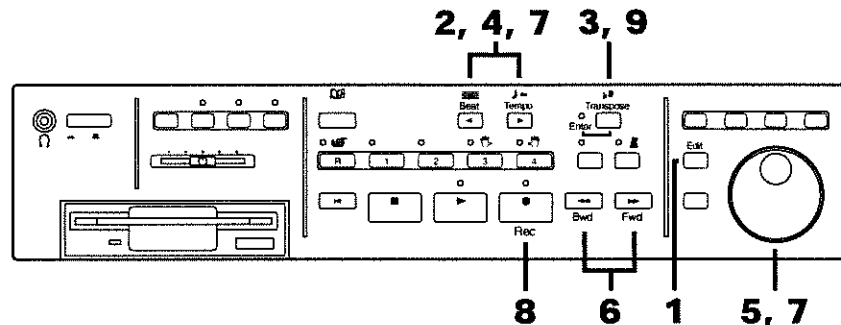

Press the [Song] button to display the Basic screen.

- 1. Press the [Edit] button.**
The Edit screen is displayed (p.15).
- 2. Press the Beat [◀] or Tempo [▶] buttons until "Note Edit" appears in the upper part of the screen.**
- 3. Press the [Transpose] button, and the following screen will appear:**

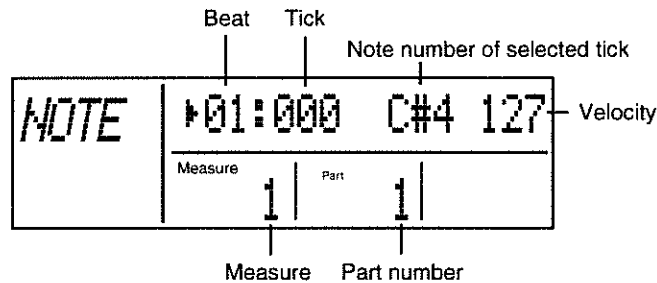

If there is nothing recorded at the selected location, "---" appears in the display.

- 4. Press the Beat [◀] button or Tempo [▶] button to move the cursor (▶) to the middle of the lower row of the screen.**
- 5. Rotate the [Dial] to select the part you want to edit.**
- 6. Using the Bwd [◀◀] and Fwd [▶▶] buttons, move to the measure you want to edit.**
- 7. Press the Beat [◀] button or Tempo [▶] button to move the cursor (▶) to another location, and set it with the [Dial].**

First, select the beat and tick. Next, edit the note number and velocity.

Pressing the [Song] button at this point cancels the settings and returns you to the Edit screen.

8. If you want to delete any notes, press the Rec [●] button.

The note at the selected location is deleted.

9. Press the [Transpose] button.

The note number and velocity at the selected location are changed. In this fashion, the notes are edited one at a time.

Pressing the [Song] button now returns you to the Edit screen.

In some songs, the instrument sound changes during the course of the song (that is, the Tone changes in the middle of a Part). In such songs, an instruction to switch the Tone is inserted at the place where you want the sound to change. This instruction is called a "Program Change" (PC), and actions such as deleting program changes, or changing the Tone that is selected by them is known as "PC Editing."

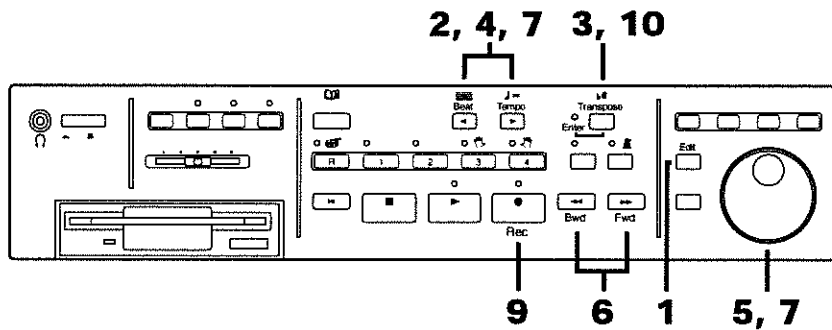

Press the [Song] button to display the Basic screen.

1. Press the [Edit] button.

The Edit screen is displayed (p.15).

2. Press the Beat [◀] or Tempo [▶] buttons until "PC Edit" appears in the upper part of the screen.

3. Press the [Transpose] button, and the following screen will appear:

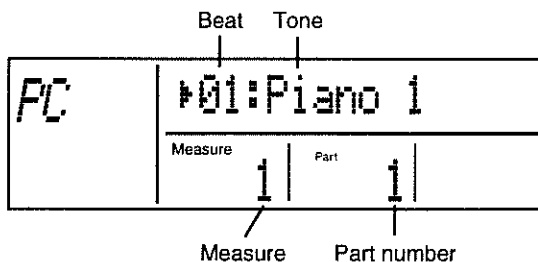

4. Press the Beat [◀] button or Tempo [▶] button to move the cursor (▶) to the middle of the lower row of the screen.

- 5.** Rotate the [Dial] to select the part you want to edit.
- 6.** Using the Bwd [◀◀] and Fwd [▶▶] buttons, move to the measure you want to edit.
- 7.** Press the Beat [◀] button or Tempo [▶] button to move the cursor (▶) to the Beat position, and select the beat with the [Dial].
- 8.** If you want to change the tone, move the cursor to the Tone position, and then select a tone with the [Dial].
Pressing the [Song] button at this point cancels the settings and returns you to the Edit screen.
- 9.** If you want to delete any program changes, press the Rec [●] button.
- 10.** Press the [Transpose] button.
The program changes at the selected location are edited.
Pressing the [Song] button at this point returns you to the Edit screen.

NOTE

Measures or beats for which the upper line of the screen shows "01:-----" do not contain a program change. It is not possible to insert a program change into a measure or beat that does not contain a program change.

The following do not revert to their original settings, even when the MT 300s is turned off and then on again. However, you can restore the original status for these settings (that is, the settings as they were when your MT 300s was shipped from the factory). This restoring of the original settings is call "Factory Preset."

Stored Settings

- Tuning settings (p.19, 24)
- Piano sounds produced when the keyboard is played; piano settings when music files are played back (p.21)
- The kind of metronome tones (p.95)
- The kind of Count Sound (p.96)
- Pedal functions (p.98)
- Screen language display settings (p.99)
- MIDI settings (p.100)

* The following MIDI settings are not stored in memory.

- Settings for individual Parts, when "Each" is selected for "MIDI Out"
- "MIDI Sync" settings

Press the [Song] button to display the Basic screen.

1. Press the [Menu] button.
The Menu screen is displayed (p.15).
2. Press the Beat [◀] button or Tempo [▶] button until "Factory Preset" appears in the upper part of the screen.
3. When you press the [Transpose] button, The following screen is displayed.

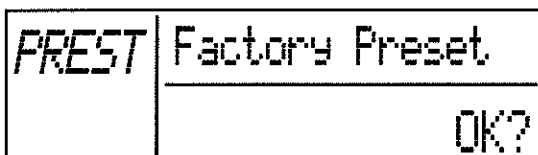

Pressing the [Song] button returns you to the Menu screen.

4. Press the [Transpose] button once more.
The [Transpose] button indicator turns off, and the original settings are restored.

You can change the sound played and the pattern used when you use the metronome.

Press the [Song] button to display the Basic screen.

1. Press the [Menu] button.
The Menu screen is displayed (p.15).
2. Press the Beat [◀] or Tempo [▶] buttons until "Metronome" appears in the upper part of the screen.
3. Press the [Transpose] button, and the following screen will appear:



4. Press the Tempo [▶] button until items you want to make settings to, for example "Mtr.Sound," appear in the upper part of the screen.
Pressing the Beat [◀] button returns you to the previous screen.







Displayed	Meaning
Metronome Vol	The metronome volume can be adjusted in ten levels. The volume is set to [5] when the keyboard is turned on.
Mtr. Sound	You can change the metronome sound.
Mtr. Ptrn	You can change the metronome pattern. The pattern is set to [Normal] when the keyboard is turned on.

5. Use the [Dial] to make your setting.
Pressing the [Song] button at this point cancels the settings and returns you to the Menu screen.

Metronome Tones

Displayed	Type
Click	Normal Metronome sound (Click & Bell)
Elec. Voice	Electronic Metronome Sound Voice (One, two, three,...)
Animal	Dog & Cat Sounds

Metronome Patterns

Type	Meaning
Normal	Ordinary beat, with no pickup.
	Plays with a dotted half note pickup before the beginning of the measure.
	Plays with a half note pickup before the beginning of the measure.
	Plays with a dotted quarter note pickup before the beginning of the measure.
	Plays with a quarter note pickup before the beginning of the measure.
	Plays with a dotted eighth note pickup before the beginning of the measure.
	Plays with an eighth note pickup before the beginning of the measure.
	Plays with a sixteenth note pickup before the beginning of the measure.
+Doubl	Plays with backbeats as the added sound.
+Tripl	Plays with triplets as the added sound.
+Shuffl	Adds a shuffle.

6. Press the [Transpose] button.

The settings are changed, and you are returned to the Menu screen.

→ “Sounding the Metronome” (p.36)

* The kind of metronome tones will be retained even while the MT 300s is switched off. Please refer to “Restoring the Original Settings” (p.95) if you wish to restore the original settings.



You can change the number of measures and the type of count sound used in the Count In function, and the count sound settings used in repeating functions.

Press the [Song] button to display the Basic screen.

1. Press the [Menu] button.

The Menu screen is displayed (p.15).

2. Press the Beat [◀] or Tempo [▶] buttons until “Count In” appears in the upper part of the screen.

3. Press the [Transpose] button, and the following screen will appear:

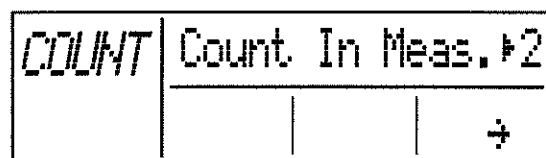

4. Press the Tempo [▶] button until items you want to make settings to, for example “CounSound,” appear in the upper part of the screen.

Pressing the Beat [◀] button returns you to the previous screen.

Displayed	Description
Count In Meas.	You can set the number of measures of count sound to “1” or “2.” “2” (two measures of count sound) is the power-on default setting.
CounSound	This selects the type of sound used for the Count In function.
CounRepeat	This setting is used to determine whether or not the count sound is played during repeating functions. “First” is the power-on default setting.

5. Select the count sound type and other settings with the [Dial].

If you press the [Song] button, the settings are deleted, and you are returned to the Menu screen.

Count Sound Types

Displayed	Description
Sticks	Sound of drumsticks beating
Click	Bell sound or click track
Elec.	An “electronic” sound
Voice	Voice (One, Two, Three,...)
Animal	Dog & Cat sounds

Count Sound Settings for Repeating

Displayed	Description
First	The count sound is played the first time only.
Every	The count sound is played with every repeat.

6. Press the [Transpose] button.

The settings are changed, and you are returned to the Menu screen.

* Please refer to “Synchronizing the Timing when You Come into a Song” (p.39) and “Repeating the Same Part of a Song” (p.31).

* The kind of count in sound will be retained even while the MT 300s is switched off. Please refer to “Restoring the Original Settings” (p.95) if you wish to restore the original settings.



Normally, markers are put at the beginning of the selected measure, but you can also put them at other places within the measure.

Press the [Song] button to display the Basic screen.

1. Press the [Menu] button.
The Menu screen is displayed (p.15).
2. Press the Beat [◀] or Tempo [▶] buttons until "Marker" appears in the upper part of the screen.
3. Press the [Transpose] button, and the following screen will appear:



4. Using the Alpha - dial, select [Meas] (measure bar) or [Beat] (middle of a measure).
Switching on the piano will automatically select [Meas].

Display	Description
Meas	The marker will be put at the closest measure line.
Beat	The marker will be put at the place where you press the button.

Pressing the [Song] button at this point cancels the settings and returns you to the Menu screen.

5. Press the [Transpose] button.
The settings are changed, and you are returned to the Menu screen.

→ See p.29, "Moving Marked Locations"



When playing back songs, you can add the right reverb and chorus effects for each song. You can change the type of reverb and chorus as well as the amount of effect applied.

Press the [Song] button to display the Basic screen.

1. Press the [Menu] button.
The Menu screen is displayed (p.15).
2. Press the Beat [◀] button or Tempo [▶] button until "Effect" appears in the upper part of the screen.

3. When you press the [Transpose] button, the following screen is displayed.

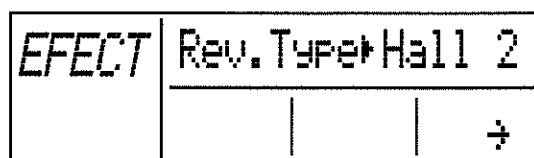

4. Press the Beat [◀] button or Tempo [▶] button until "Rev.Type" or "Cho.Type" appears in the upper part of the screen.
5. Use the [Dial] to select the type of reverb or chorus you want.
When the MT 300s is turned on, the default settings are "Hall 2" for the reverb and "Chorus 3" for the chorus.
Pressing the [Song] button undoes the changes to the settings and returns you to the Menu screen.

Reverb Type

Display Type	Description
Room1	Reverberation of a conference room.
Room2	Reverberation of a small club.
Room3	Reverberation of a spacious room.
Hall 1	Reverberation of a large hall.
Hall 2	Reverberation of a small hall.
Plate	Bright and metallic reverberation.
Delay	Repetitions like an echo.
PanDelay	Sound crossing between the right and left speakers.

Chorus Type

Display Type	Description
Chorus1	Slow and shallow chorus.
Chorus2	Quick and shallow chorus.
Chorus3	Slow and deep chorus.
Chorus4	Quick and deep chorus.
FBChors	Soft sound with a flanger-like effect.
Flanger	The sound like a jet plane going up and down.
S. Delay (Short Delay)	Short echo effect.
FB-Delay (Feedback Delay)	Short delay effect with many repetitions.

6. Press the [Transpose] button.
The settings are changed, and you are returned to the Menu screen.

With an optional Roland DP-2 Pedal Switch connected to the Start/Stop jack on the rear panel of the MT 300s, you can do the following.

- Start and stop playback of songs (p.26 and other pages)
- Start and stop recording (p.41 and other pages)
- Punch in and out (start and stop recording) in Punch-In Recording (p.70)

Press the [Song] button to display the Basic screen.

1. Press the [Menu] button.
The Menu screen is displayed (p.15).
2. Press the Beat [◀] button or Tempo [▶] button until "Pedal Setting" appears in the upper part of the screen.
3. When you press the [Transpose] button, the following screen is displayed.

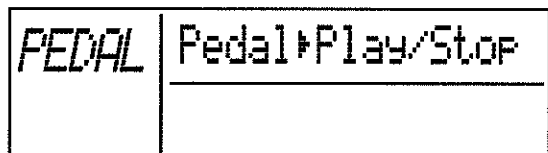

4. Use the [Dial] to select the pedal function.

Displayed	Function
Play/Stop	Allows you to start and stop playback or recording of songs.
Punch I/O	Allows you to use the pedal for Punch-In Recording (p.70).

Pressing the [Song] button undoes the changes to the settings and returns you to the Menu screen.

5. Press the [Transpose] button.
The settings are changed, and you are returned to the Menu screen.

* These settings are retained even while the MT 300s is turned off. Please refer to "Restoring the Original Settings" (p.95) if you wish to restore the original settings.

You can turn off the bouncing ball.

Press the [Song] button to display the Basic screen.

1. Press the [Menu] button.
The Menu screen is displayed (p.15).
2. Press the Beat [◀] button or Tempo [▶] button until "Metronome" appears in the upper part of the screen.
3. Press the [Transpose] button.
4. Press the Tempo [▶] button three times to call up "BouncingBall" to the upper part of the screen.



5. Use the [Dial] to switch between "ON" (lit) and "OFF" (off).
"ON" is set automatically when the MT 300s is turned on.
Pressing the [Song] button undoes the change to the setting and returns you to the Menu screen.
6. Press the [Transpose] button.
The setting is changed, and you are returned to the Menu screen.

→ "About the Display Screen" (p.15)



Some minus-one (Karaoke) music files cause the display to show the lyrics. You can change it so that the words will not be displayed.

Press the [Song] button to display the Basic screen.

1. Press the [Menu] button.
The Menu screen is displayed (p.15).
2. Press the Beat [◀] button or Tempo [▶] button until "Lyric" appears in the upper part of the screen.
3. When you press the [Transpose] button, the following screen is displayed.

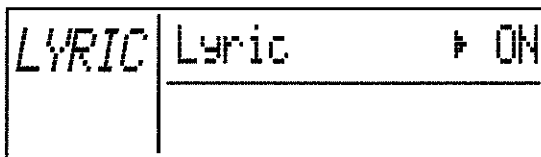

4. Use the [Dial] to switch between "ON" (lyrics displayed) and "OFF" (lyrics not displayed).
Pressing the [Song] button undoes the change to the setting and returns you to the Menu screen.
5. Press the [Transpose] button.
The setting is changed, and you are returned to the Menu screen.

* When the lyrics are displayed, pressing the [Song] button or other buttons removes the lyrics from the screen. If you want the lyrics displayed again, press the Play [▶] button once more.



You can select either Japanese or English the language used for the display.

Press the [Song] button to display the Basic screen.

1. Press the [Menu] button.
The Menu screen is displayed (p.15).
2. Press the Beat [◀] button or Tempo [▶] button until "Language" appears in the upper part of the screen.
3. When you press the [Transpose] button, the following screen is displayed.

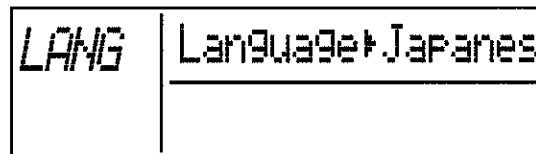

4. Use the [Dial] to switch between "Japanes" (Japanese) and "English."
Pressing the [Song] button undoes the change to the setting and returns you to the Menu screen.
5. Press the [Transpose] button.
The setting is changed, and you are returned to the Menu screen.

* This setting is retained even while the MT 300s is turned off. Please refer to "Restoring the Original Settings" (p.95) if you wish to restore the original setting.

TERMS

MIDI, short for “Musical Instrument Digital Interface,” is a standard that defines how the exchange of performance information between electronic instruments and computers takes place. The MT 300s features a MIDI connector and a computer connector to allow performance information to be exchanged with external devices. Connecting external equipment in this manner lets you use the MT 300s in an even greater variety of ways.

A separate publication titled “MIDI Implementation” is also available. It provides complete details concerning the way MIDI has been implemented on this unit. If you should require this publication (such as when you intend to carry out byte-level programming), please contact the nearest Roland Service Center or authorized Roland distributor.

About the MIDI Connectors

The MT 300s features two types of MIDI connectors. When external devices are hooked up to these connectors, each device can be set up to control the other. Devices that are connected to the MT 300s’s MIDI connector are referred to as “MIDI devices.”

MIDI Out Connector

Performance information output by, for example, playing the keyboard is sent to external MIDI devices from this connector.

MIDI In Connector

MIDI messages sent by external MIDI devices are received via this connector. MIDI devices from which MIDI messages are received may perform such actions as playing sounds and switching tones.



To learn about each of the following settings in greater detail, please refer to the pages for each particular item.

Press the [Song] button to display the Basic screen.

1. Press the [Menu] button.
The Menu screen is displayed (p.15).
2. Press the Beat [◀] button or Tempo [▶] button until “MIDI Setting” appears in the upper part of the screen.

3. When you press the [Transpose] button, the following screen is displayed.

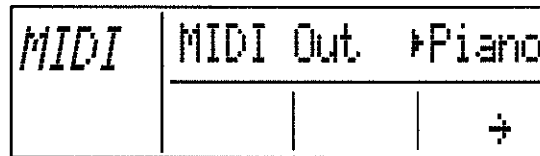

4. Press the Beat [◀] button or Tempo [▶] button until the item that you want to make settings for appears in the upper part of the screen.

Displayed

Description

MIDI Out

This switches the sound generator—the MT 300s’s or that of the connected external MIDI device—that is used to produce the tones that are played for each individual part (p.101).

Rx.Ch Conv.

RX Channel Convert—This is used to select whether channels for MIDI messages sent from connected external MIDI devices are converted to part channels by the MT 300s (p.102).

MIDI Sync

MIDI Sync Switch—This is used to determine whether the song uses the MT 300s’s tempo or the tempo from the external MIDI device connected to the MT 300s (p.102).

MIDI Clock

MIDI Clock Out—This selects whether or not messages for synchronization with MIDI are transmitted through the MIDI Out connector (p.103).

Soft Thru

Selects whether or not MIDI messages received via the MIDI In connector are output through the MIDI Out connector (p.103).

5. Make the settings with the [Dial].

Pressing the [Song] button undoes changes to the settings and returns you to the Menu screen.

6. Press the [Transpose] button.

Settings are changed, and you are returned to the Menu screen.

* These MIDI settings do not return to their original settings when the power is switched off and back on (except for the two items shown below). If you want to return the settings to the original values they had when you purchased the unit, refer to “Restoring the Original Settings” (p. 95).

○Settings That Return to Their Original Values When the Power Is Reset

- Settings for individual Parts, when “Each” is selected for “MIDI Out.”
- “MIDI Sync” settings

The MT 300s's internal sound generator supports both the General MIDI System and the GS Format. You can also use the MT 300s's sound generator for MIDI devices that do not contain sound generators by connecting those devices to the MT 300s.

TERMS

What is a Sound Generator?

A sound generator does just what the name suggests, that is, it generates or creates and outputs sounds. The MT 300s internal sound generator can produce sounds for sixteen separate parts. In addition, you can select the tones to be played in each part, with a tremendous variety of instrument sounds from which to choose.

* When using the MT 300s as a sound generator, set "RX Channel Convert" to "OFF" (p.102).

General MIDI system

The General MIDI system is a set of recommendations which seeks to provide a way to go beyond the limitations of proprietary designs, and standardize the MIDI capabilities of sound generating devices. Sound generating devices and music files that meets the General MIDI standard bears the General MIDI logo (). Music files bearing the General MIDI logo can be played back using any General MIDI sound generating unit to produce essentially the same musical performance.

GS format

The GS Format () is Roland's set of specifications for standardizing the performance of sound generating devices. In addition to including support for everything defined by the General MIDI System, the highly-compatible GS Format additionally offers an expanded number of sounds, provides for the editing of sounds, and spells out many details for a wide range of extra features, including effects such as reverb and chorus.

Designed with the future in mind, the GS Format can readily include new sounds and support new hardware features when they arrive.

Since it is upwardly compatible with the General MIDI System, Roland's GS Format is capable of reliably playing back GM Scores equally as well as it performs GS Music Files (music files that has been created with the GS Format in mind).

This product supports both the General MIDI system and the GS format, and can be used to play back music files carrying either of these logos.

You can have the sound of any part produced by either the MT 300s's internal sound generator, or the sound generator of a connected MIDI device. This setting is called "MIDI Out."

1. In Step 4 of the MIDI settings procedure (p.100), press the Beat [◀] button or Tempo [▶] button until "MIDI Out" appears in the upper part of the screen.
2. Switch the setting with the [Dial].

Displayed	Description
Piano	As in "Selecting Piano Sounds" (p.21), the sounds for parts are produced by the MT 300s's sound generator, except for the part for which the piano sound from a connected digital piano is set.
All	Music for all Parts will be sounded by the MT 300s's sound generator, as well as by the connected device.
Each	This setting allows you to select the sound generator, the MT 300s's or that of the connected MIDI device, to be used for each part.

3. Select "Each" and press the [Transpose] button; the following screen is displayed.

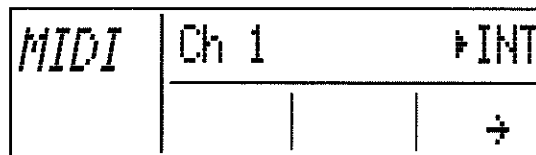

4. Using the Beat [◀] button or Tempo [▶] button, select the part.
5. Use the [Dial] to switch between "INT" and "EXT."

Displayed	Description
INT	The MT 300s's internal sound generator is used.
EXT	The sound generator of the connected device is used.

* When the power is turned on, all channels will be set to "INT."

In general, when recording or playing back songs with MIDI devices and MIDI sequencers connected, material is recorded to the sequencer channel (or part) with the same number as the MIDI Transmit channel selected by the connected MIDI device. Therefore, it is necessary to match the channels (parts) of the MIDI device and the MIDI sequencer.

With the MT 300s, you can play back songs and record to parts selected automatically by the MT 300s, even without changing the channel (part) of the connected MIDI device. This setting is called "RX Channel Convert."

1. In Step 4 of the MIDI settings procedure (p.100), press the Beat [◀] button or Tempo [▶] button until "Rx.Ch Conv." appears in the upper part of the screen.

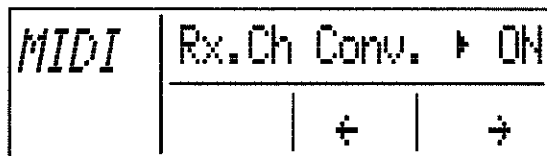

2. Switch the setting with the [Dial].

Displayed	Description
ON	Records to the parts selected by the MT 300s, regardless of the channels selected by the connected MIDI device.
OFF	Records material to the MT 300s parts with the same numbers as the channels selected by the connected MIDI device.

* Ordinarily, you should set this to "ON." Set it to "OFF" when using the MT 300s as a sound module.

Recording with the RX Channel Converter Set to "OFF"

Recording with the MT 300s with the RX Channel Converter set to "ON" differs from when it is set to "OFF."

1. Press the Rec [●] button.
The MT 300s is put into record standby mode.
All Track buttons begin flashing.
- * Pressing any Track button turns its indicator off. Nothing is recorded to Track buttons when their indicators are off.
2. When you press the Play [▶] button, recording begins.
3. Press the Stop [■] button, and recording ceases.
Material is recorded to the part with the same number as that of the channel selected by the connected MIDI device.

Channels correspond to Track buttons as shown below.

Track Button	R	1	2	3	4
Channel	10	1	2, 5-9, 11-16	3	4

You can have connected MIDI devices played by the tempo produced by the MT 300s; you can also have the tempo produced by connected MIDI devices play the MT 300s. This setting for this is called the "MIDI Sync Switch." Having connected MIDI devices work at the same tempo, and start and stop at the same timing is called "synchronization."

1. In Step 4 of the MIDI settings procedure (p.100), press the Beat [◀] button or Tempo [▶] button until "MIDI Sync" appears in the upper part of the screen.

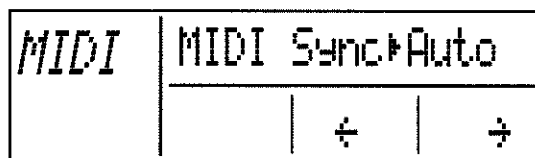

2. Switch the setting with the [Dial].

Displayed	Description
Auto	The MT 300s's tempo as well as the starting and stopping of playback and recording is controlled by the MIDI device connected to the MT 300s's MIDI In connector. When there is no MIDI device connected, then these operations can be performed by the MT 300s.
Int	Adjustment of the MT 300s's tempo and starting and stopping of playback and recording is performed by the MT 300s.
Ext	The MT 300s's tempo as well as the starting and stopping of playback and recording is controlled by the MIDI device connected to the MT 300s's MIDI In connector. When there is no MIDI device connected, then these operations can not be controlled by the MT 300s.
Remote	Playback and recording of songs is controlled by the connected MIDI device.

* If the above is set to "EXT," the MT 300s's buttons cannot be used to adjust the MT 300s's tempo, or to start and stop playback and recording of songs. Ordinarily, you should set this to "Auto."

You can choose whether or not to have MIDI synchronization messages transmitted via the MIDI Out connector. This setting is called "MIDI Clock Out."

1. In Step 4 of the MIDI settings procedure (p.100), press the Beat [◀] button or Tempo [▶] button until "MIDI Clock" appears in the upper part of the screen.



2. Use [Dial] to switch the setting between "ON" (transmitted) and "OFF" (not transmitted).

You can select whether or not to have the "MIDI Out" (p.101) settings control the retransmission of messages received via the MIDI In connector.

1. In Step 4 of the MIDI settings procedure (p.100), press the Beat [◀] button or Tempo [▶] button until "Soft Thru" appears in the upper part of the screen.

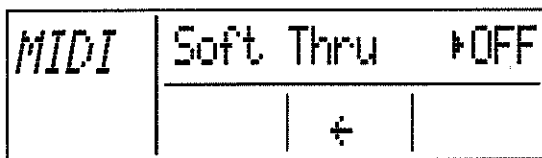

2. Use the [Dial] to switch the setting between "ON" (transmitted) and "OFF" (not transmitted).

* If you are using a digital piano that does not include a Local Off function, then switch Soft Thru to "OFF." The instant Soft Thru is switched to "ON," Local Off is transmitted via the MIDI Out connector; when Soft Thru is switched to "OFF," then Local On is transmitted.

When you connect the MT 300s to a computer using a computer cable (sold separately), follow the steps below.

1. Turn off the MT 300s and the computer.
2. Use a computer cable to connect the Computer connector on the MT 300s to a serial port on the computer.
3. Set the Computer switch on the rear panel of the unit to match the type of connected computer.

* Take a look at the Connection examples.

4. Turn on the computer.
 5. Turn on the MT 300s.
 6. Make the settings for baud rate (transmission speed) for the computer and the software.
- * For more information, refer to the documentation for the computer you're using.
7. You should also make the following settings as needed.

"Selecting Piano Sounds" (p. 21)

"Making MIDI Settings," etc. (p. 100-103)

Connection examples:

Connection with an Apple Macintosh computer

Use a computer cable to connect the Computer connector on the MT 300s to the modem port (or printer port) on the Apple Macintosh. Set the Computer switch to "Mac."

Use "PatchBay" on the Apple Macintosh to set the interface type (the clock speed for the MIDI interface) to "1 MHz."

Connection with an IBM PC

Use a computer cable to connect the Computer connector on the MT 300s to the COM1 or COM2 serial port on the IBM PC. Set the Computer switch to "PC-2."

* By connecting a computer to the MT 300s with a computer cable, and connecting a digital piano to the MT 300s with a MIDI cable, the MT 300s can take MIDI messages received from the digital piano via the MIDI In connector and transmit them to the computer.

If you are encountering any problems with the equipment, please read the section below before determining that there has been any malfunction.

The MT 300s does not switch on.

- Is the power cord properly connected? (p.18, 23)

No sound is produced.

- Is the volume slider completely to the left (turned completely down)? (p.19, 23)
- Are the part volume levels turned down? (p.57)
- Are headphones connected? (p.12)
- Is the Speaker switch turned to "Off?" (p.14)
- Are the MT 300s and other devices properly connected? (p.16)
- Is the power to all equipment turned on?
- Is the computer switch on the backside of the MT 300s set to "MIDI?" (p.14)

Only one tone is used for all the sounds.

- Has "RX Channel Convert" been set to "OFF?" (p.102)
Set this to "ON."

The digital piano sound is not produced.

- Is the MT 300s's piano sound set to play? (p.21)
- Is Soft Thru set to "OFF?" (p.103)

The piano sound from the digital piano is noisy.

- Were the digital piano and the MT 300s turned on in the proper order? (p.18)

If the noise persists even when the digital piano is turned on first, set the digital piano to Local Off. If you cannot set your piano to Local Off, then set "Soft Thru" on the MT 300s to "OFF." (p.103)

Some notes are missing.

- The MT 300s can play a maximum of 64 notes simultaneously. When performing with a song on a floppy disk, or when using the damper pedal a lot during a performance, the number of notes being expressed at any one moment may exceed 64. When the total exceeds 64 notes, then some will be omitted.

The song does not play.

- Is the Track button indicator off? (p.38)
Sounds on buttons whose indicators are off are not played. Press the desired buttons to turn on their indicators.
- Have you inserted the floppy disk containing the desired song into the disk drive? (p.25)

I can't play back songs on floppy disks right away.

- There are two types of SMFs, Format 0 and Format 1. It can take a while for Format 1 data to begin playback. To determine the format of the music files you are using, please refer to the documentation that came with the data.

Certain instrument sounds are missing.

- Have you selected the "Minus One" function? (p.60)

You cannot forward or rewind data.

- While the MT 300s is loading data from a floppy disk, you cannot fast-forward or rewind data (p.28).
- When the size of a song is too large, it cannot be forwarded or rewound.

The song goes out of tune, or the pitch drifts.

- Has the song been transposed? (p.35)
- Is the "Tuning" setting correct? (p.19, 24)

The indicator for a track button does not go out.

- Check if the display shows 16 tracks. While the 16-track display is active, you cannot turn off the indicators on the track buttons.

The pedals are not functioning, or function intermittently.

- Are the pedals connected properly? (p.17)
- Make sure that the cord from the pedal switch is connected securely to the Start/Stop jack.

Make sure that the cord from the expression pedal is connected securely to the Expression Pedal jack.

Can't Record

- Have you selected a [Track] button for recording? (p.46)
- Has "Punch-In Recording" been selected? (p.70)

In "Punch-In Recording," recording begins from the point in the song where you press the Rec [●] button or where Marker A is placed.

- Has "Tempo Recording" been selected? (p.74)

You cannot record performances while "Tempo Recording" is active.

- Has "RX Channel Convert" been set to "OFF?" Set this to "ON." (p.102)

The recorded performance has been deleted.

- Recorded material is deleted when the keyboard is turned off. Deleted performances cannot be retrieved. Save the data onto a floppy disk before switching the unit off (P.49).

The song cannot be saved.

- Some commercially available music files cannot be saved for copyright reasons.
- Songs on commercially available music disks cannot be saved in SMF format.

The bouncing ball does not appear on the screen .

- Is the bouncing ball setting set to "Off?" Set the bouncing ball to "On" (p.98).
- The MT 300s features a liquid crystal display. Characters may begin to disappear in freezing conditions. Once above zero degrees Celsius (32 degrees Fahrenheit), the characters reappear.

Lyrics are not indicated properly in the display.

- With some music files, the lyrics cannot be displayed correctly.
- After saving a song from music files in which lyrics are displayed, the lyrics of the saved song cannot be displayed.
- When the lyrics are displayed, pressing the [Song] button or other buttons removes the lyrics from the screen. If you want the lyrics displayed again, press the Play [▶] button once more.

Indication: PU

Meaning : When a song with a pickup (a song that does not start on the first beat) is played back, the measure numbers will be indicated in the display as PU, 1, 2, and so forth.

Indication: New Song Del OK?

Meaning : When you try to delete a recorded song (p.48), to select a different song after recording a song (p.26) or to select a different song after editing the basic settings of a song, this is shown in the display (p.27, 41).

Indication: Setup Modified Up date OK?

Meaning : This is shown in the display when you edit the settings in each Part, then try to select a different song without changing the basic settings (p.58).

Indication: E.00: CopyProtect

Meaning : To protect the copyright, this music file cannot be saved onto a different floppy disk than the original one.

Meaning : To protect the copyright, this music file cannot be saved as an SMF.

Indication: E.01: Can't Save

Meaning : This music file cannot be saved onto a floppy disk.

Indication: E.02: Protected

Meaning : The protect tub on the floppy disk is set to the Protect position. Change it to the Write position (p.5).

Indication: E.03: Master Disk

Meaning : This floppy disk cannot store the format.

Indication: E.04: Can't Save

Meaning : The data cannot be saved onto this floppy disk because the saving system is different. Use the floppy disk that has the save saving system.

Indication: E.05: Read Only

Meaning : A new song cannot be written on this song. Select a different song number or use a different floppy disk.

Meaning : This song cannot be deleted.

Indication: E.10: No Disk

Meaning : No floppy disk is connected to the disk drive.

Indication: E.11: Disk Full

Meaning : There is not sufficient space left on the floppy disk for the data to be saved. Save the data onto a different floppy disk.

Indication: E.12: Unknown Disk

Meaning : This floppy disk is not formatted or the songs stored on this floppy disk cannot be played in the MT 300s.

Indication: E.13: Disk Ejected

Meaning : The floppy disk has been disconnected during operation, repeat the procedure from the beginning.

Indication: E.14: DamagedDisk

Meaning : This floppy disk is damaged and cannot be used.

Indication: E.15: Can't Read

Meaning : This song cannot be read into the piano.

Indication: E.16: Can't Play

Meaning : The MT 300s cannot read the floppy disk quickly enough. Press the Stop [■] button, then press the Reset [◀] button and Play [▶] button to play the song.

Indication: E.17: Can't Edit

Meaning : Tones and other parameters of these music files cannot be edited on the MT 300s. You can only play back these music files.

Indication: E.30: Memory Full

Meaning : The internal memory capacity of the MT 300s is full. If you save the song data then play, the operation may be carried out successfully.

Indication: E.40: Buffer Full

Meaning : The MT 300s cannot deal with the excessive MIDI data sent from the external MIDI device. Reduce the amount of MIDI data sent to the MT 300s.

Indication: E.41: Comm.Error

Meaning : A MIDI cable or computer cable has been disconnected. Connect it properly and securely.

Indication: E.42: Can't Record

Meaning : An excessive amount of performance information has been sent to the piano in one time and therefore could not be recorded.

Indication: E.43: Comp./IF Err

Meaning : The Computer Switch is set to a wrong position or the computer is set wrongly. Switch off the piano then set the Computer Switch to the correct position and set the computer correctly (p.14).

Indication: E.51: Memory Error

Meaning : There is something wrong with the system. Repeat the procedure from the beginning. If it is not solved after you have tried several times, contact the Roland service center.

→ See p.55 "Getting Various Instruments Sounds from the Keyboard", p.56 "Listening to Songs after Changing Instrument Sounds or Making Other Changes."

No.	Tone Name	No.	Tone Name	No.	Tone Name
1	Piano 1	61	Muted Gt.	121	English Horn
2	Piano 1w	62	Funk Gt.	122	Bassoon
3	Piano 1d	63	Funk Gt.2	123	Clarinet
4	Piano 2	64	Overdrive Gt	124	Piccolo
5	Piano 2w	65	DistortionGt	125	Flute
6	Piano 3	66	Feedback Gt.	126	Recorder
7	Piano 3w	67	Gt.Harmonics	127	Pan Flute
8	Honky-tonk	68	Gt. Feedback	128	Bottle Blow
9	Honky-tonk 2	69	Acoustic Bs.	129	Shakuhachi
10	E.Piano 1	70	Fingered Bs.	130	Whistle
11	Detuned EP 1	71	Picked Bs.	131	Ocarina
12	E.Piano 1v	72	Fretless Bs.	132	Square Wave
13	60's E.Piano	73	Slap Bass 1	133	Square
14	E.Piano 2	74	Slap Bass 2	134	Sine Wave
15	Detuned EP 2	75	Synth Bass 1	135	Saw Wave
16	E.Piano 2v	76	SynthBass101	136	Saw
17	Harpichord	77	Synth Bass 3	137	Doctor Solo
18	Coupled Hps.	78	Synth Bass 2	138	Syn.Calliope
19	Harpsi.w	79	Synth Bass 4	139	Chiffer Lead
20	Harpsi.o	80	Rubber Bass	140	Charang
21	Clav.	81	Violin	141	Solo Vox
22	Celesta	82	Slow Violin	142	5th Saw Wave
23	Glockenspiel	83	Viola	143	Bass & Lead
24	Music Box	84	Cello	144	Fantasia
25	Vibraphone	85	Contrabass	145	Warm Pad
26	Vibes w	86	Tremolo Str	146	Polysynth
27	Marimba	87	PizzicatoStr	147	Space Voice
28	Marimba w	88	Harp	148	Bowed Glass
29	Xylophone	89	Timpani	149	Metal Pad
30	Tubular-bell	90	Strings	150	Halo Pad
31	Church Bell	91	Orchestra	151	Sweep Pad
32	Carillon	92	Slow Strings	152	Ice Rain
33	Santur	93	Syn.Strings1	153	Soundtrack
34	Organ 1	94	Syn.Strings3	154	Crystal
35	Detuned Or.1	95	Syn.Strings2	155	Syn Mallet
36	Pop Organ 1	96	Choir Aahs	156	Atmosphere
37	Full Organ 4	97	Choir	157	Brightness
38	Organ 2	98	Pop Voice	158	Goblin
39	Detuned Or.2	99	SynVox	159	Echo Drops
40	Jazz Organ 1	100	OrchestraHit	160	Echo Bell
41	Rock Organ 2	101	Trumpet	161	Echo Pan
42	Church Org.1	102	Trombone	162	Star Theme
43	Church Org.2	103	Trombone 2	163	Sitar
44	Church Org.3	104	Tuba	164	Sitar 2
45	Reed Organ	105	MutedTrumpet	165	Banjo
46	Accordion Fr	106	French Horns	166	Shamisen
47	Accordion It	107	Fr.Horn 2	167	Koto
48	Harmonica	108	Brass 1	168	Taisho Koto
49	Bandoneon	109	Brass 2	169	Kalimba
50	Nylon-str.Gt	110	Synth Brass1	170	Bagpipe
51	Ukulele	111	Synth Brass3	171	Fiddle
52	Nylon Gt.o	112	AnalogBrass1	172	Shanai
53	Nylon Guitar	113	Synth Brass2	173	Tinkle Bell
54	Steel-str.Gt	114	Synth Brass4	174	Agogo
55	12-str.Gt	115	AnalogBrass2	175	Steel Drums
56	Mandolin	116	Soprano Sax	176	Woodblock
57	Jazz Guitar	117	Alto Sax	177	Castanets
58	Hawaiian Gt.	118	Tenor Sax	178	Taiko
59	Clean Gt.	119	Baritone Sax	179	Concert BD
60	Chorus Gt.	120	Oboe	180	Melo. Tom 1

No.	Tone Name	No.	Tone Name	No.	Tone Name
181	Melo. Tom 2	241	Tubularbell*	301	Bassoon*
182	Synth Drum	242	Santur*	302	Clarinet*
183	808 Tom	243	Organ 1*	303	Piccolo*
184	Elec Perc.	244	Pop Organ 1*	304	Flute*
185	Reverse Cym.	245	Organ 2*	305	Recorder*
186	Gt.FretNoise	246	Rock Organ2*	306	Pan Flute*
187	Gt.Cut Noise	247	ChurchOrg.1*	307	Bottle Blow*
188	String Slap	248	Reed Organ*	308	Shakuhachi*
189	Breath Noise	249	AccordionFr*	309	Whistle*
190	Fl.Key Click	250	Harmonica*	310	Ocarina*
191	Seashore	251	Bandoneon*	311	Square Wave*
192	Rain	252	Nylon-strGt*	312	Saw Wave*
193	Thunder	253	Steel-strGt*	313	Doctor Solo*
194	Wind	254	Jazz Guitar*	314	SynCalliope*
195	Stream	255	Clean Gt.*	315	ChifferLead*
196	Bubble	256	Muted Gt.*	316	Charang*
197	Bird	257	Funk Gt.*	317	Solo Vox*
198	Dog	258	OverdriveGt*	318	5th SawWave*
199	Horse-Gallop	259	Dist.Guitar*	319	Bass & Lead*
200	Bird 2	260	Gt.Harmo*	320	Fantasia*
201	Telephone 1	261	Acoustic Bs*	321	Warm Pad*
202	Telephone 2	262	Fingered Bs*	322	Polysynth*
203	DoorCreaking	263	Picked Bs.*	323	Space Voice*
204	Door	264	Fretless Bs*	324	Bowed Glass*
205	Scratch	265	Slap Bass 1*	325	Metal Pad*
206	Windchime	266	Slap Bass 2*	326	Halo Pad*
207	Helicopter	267	Synth Bass1*	327	Sweep Pad*
208	Car-Engine	268	Synth Bass2*	328	Ice Rain*
209	Car-Stop	269	Rubber Bass*	329	Soundtrack*
210	Car-Pass	270	Violin*	330	Crystal*
211	Car-Crash	271	Viola*	331	Syn Mallet*
212	Siren	272	Cello*	332	Atmosphere*
213	Train	273	Contrabass*	333	Brightness*
214	Jetplane	274	Tremolo Str*	334	Goblin*
215	Starship	275	Pizzicato*	335	Echo Drops*
216	Burst Noise	276	Harp*	336	Star Theme*
217	Applause	277	Timpani*	337	Sitar*
218	Laughing	278	Strings*	338	Banjo*
219	Screaming	279	SlowStrings*	339	Shamisen*
220	Punch	280	Syn.Str 1*	340	Koto*
221	Heart Beat	281	Syn.Str 2*	341	Kalimba*
222	Footsteps	282	Choir Aahs*	342	Bagpipe*
223	Gun Shot	283	Pop Voice*	343	Fiddle*
224	Machine Gun	284	SynVox*	344	Shanai*
225	Lasergun	285	Orche.Hit*	345	Tinkle Bell*
226	Explosion	286	Trumpet*	346	Agogo*
227	Piano 1*	287	Trombone*	347	Steel Drums*
228	Piano 2*	288	Tuba*	348	Woodblock*
229	Piano 3*	289	M.Trumpet*	349	Taiko*
230	Honky-tonk*	290	FrenchHorns*	350	Melo.Tom 1*
231	E.Piano 1*	291	Brass 1*	351	Synth Drum*
232	E.Piano 2*	292	SynthBrass1*	352	ReverseCym.*
233	Harpsichord*	293	A.Brass 1*	353	Fret Noise*
234	Clav.*	294	SynthBrass2*	354	BreathNoise*
235	Celesta*	295	Soprano Sax*	355	Seashore*
236	Glocken*	296	Alto Sax*	356	Bird*
237	Music Box*	297	Tenor Sax*	357	Telephone 1*
238	Vibraphone*	298	BaritoneSax*	358	Helicopter*
239	Marimba*	299	Oboe*	359	Applause*
240	Xylophone*	300	EnglishHorn*	360	Gun Shot*

* Tone with a "*" symbol appended to their name may not playback satisfactorily on other GS sound generating devices.

The Drum Set (percussion instrument) have a variety of different sounds assigned to each key.

* You can select Drum and SFX sets only for Parts 10 and 11.

	1: STANDARD 6: JAZZ	2: ROOM	3: POWER	4: ELECTRONIC	5: TR-808
24	Bar Chime				
25	Snare Roll				
26	Finger Snap				
27	High Q				
28	Slap				
29	Scratch Push [EXC7]				
30	Scratch Pull [EXC7]				
31	Sticks				
32	Square Click				
33	Metronome Click				
34	Metronome Bell				
35	Std Kick 2				
C2 36	Std Kick 1		MONDO Kick	Elec BD	808 Bass Drum 1
37	Side Stick		Gated SD	Elec SD	808 Rim Shot
38	Snare Drum 1				808 Snare Drum
39	Hand Clap				
40	Snare Drum 2			Gated SD	
41	Low Tom 2	Room Low Tom 2	Room Low Tom 2	Elec Low Tom 2	808 Low Tom 2
42	Closed Hi-hat 1 [EXC1]	Room Low Tom 1	Room Low Tom 1	Elec Low Tom 1	808 CHH [EXC1]
43	Low Tom 1				808 Low Tom 1
44	Pedal Hi-hat 1 [EXC1]	Room Mid Tom 2	Room Mid Tom 2	Elec Mid Tom 2	808 CHH [EXC1]
45	Mid Tom 2	Room Mid Tom 1	Room Mid Tom 1	Elec Mid Tom 1	808 Mid Tom 2
46	Open Hi-hat 1 [EXC1]				808 OHH [EXC1]
47	Mid Tom 1	Room Mid Tom 1	Room Mid Tom 1	Elec Mid Tom 1	808 Mid Tom 1
C3 48	High Tom 2	Room Hi Tom 2	Room Hi Tom 2	Elec Hi Tom 2	808 Hi Tom 2
49	Crash Cymbal1				808 Cymbal
50	High Tom 1	Room Hi Tom 1	Room Hi Tom 1	Elec Hi Tom 1	808 Hi Tom 1
51	Ride Cymbal 1				
52	Chinese Cymbal			Reverse Cymbal	
53	Ride Bell				
54	Tambourine				
55	Splash Cymbal				
56	Cowbell				808 Cowbell
57	Crash Cymbal 2				
58	Vibra-slap				
59	Ride Cymbal 2				
C4 60	High Bongo				
61	Low Bongo				
62	Mute High Conga				808 High Conga
63	Open High Conga				808 Mid Conga
64	Low Conga				808 Low Conga
65	High Timbale				
66	Low Timbale				
67	High Agogo				
68	Low Agogo				
69	Cabasa				
70	Maracas				808 Maracas
71	Short Hi Whistle [EXC2]				
C5 72	Long Low Whistle [EXC2]				
73	Short Guiro [EXC3]				
74	Long Guiro [EXC3]				
75	Claves				808 Claves
76	High Wood Block				
77	Low Wood Block				
78	Mute Cuica [EXC4]				
79	Open Cuica [EXC4]				
80	Mute Triangle [EXC5]				
81	Open Triangle [EXC5]				
82	Shaker				
83	Jingle Bell				
C6 84	Bell Tree				
85	Castanets				
86	Mute Surdo [EXC6]				
87	Open Surdo [EXC6]				
88	-----	-----	-----	-----	-----

7: BRUSH

8: ORCHESTRA

24	25		
26			
27			
28			Close Hi-hat [EXC1]
29			Pedal Hi-hat [EXC1]
30			Open Hi-hat [EXC1]
31			Ride Cymbal
32			
33			
34			
35			Concert BD 2
C2 36			Concert BD 1
37	Brush Tap		Concert SD
38	Brush Slap		Castanets
39	Brush Swirl		Concert SD
40			Timpani F
41			Timpani F#
42			Timpani G
43			Timpani G#
44			Timpani A
45			Timpani A#
46			Timpani B
47			
C3 48			Timpani c
49			Timpani c#
50			Timpani d
51			Timpani d#
52			Timpani e
53			Timpani f
54			
55			
56			
57			Concert Cymbal 2
58			
59			Concert Cymbal 1
C4 60			
61			
62			
63			
64			
65			
66			
67			
68			
69			
70			
71			
C5 72			
73			
74			
75			
76			
77			
78			
79			
80			
81			
82			
83			
C6 84			
85			
86			
87			
88	-----		Applause

9: SOUND EFFECT

39	High Q
40	Slap
	Scratch Push [EXC7]
41	Scratch Pull [EXC7]
42	
43	Sticks
44	Square Click
45	Metronome Click
46	Metronome Bell
47	Guitar sliding Finger
C3 48	Guitar cutting noise (down)
49	Guitar cutting noise (up)
50	String slap of double bass
51	Fl.Key Click
52	Laughing
	Screaming
53	Punch
54	Heart Beat
55	Footsteps1
56	Footsteps2
57	Applause
58	Door Creaking
59	
C4 60	Door
61	Scratch
62	Wind Chimes
63	Car-Engine
64	Car-Stop
	Car-Pass
65	Car-Crash
66	Siren
67	Train
68	Jetplane
69	Helicopter
70	Starship
71	
C5 72	Gun Shot
73	Machine Gun
74	Lasergun
75	Explosion
76	Dog
	Horse-Gallop
77	Birds
78	Rain
79	Thunder
80	Wind
81	Seashore
82	Stream
83	Bubble
C6 84	Cat
85	

Blank : same percussion instruments as the STANDARD.

----- : No sound.

[EXC] : will not sound simultaneously with other percussion instruments of the same number.

→ "Creating Rhythm Parts Easily (p.77)", "Copying Rhythm Patterns (p.82)"

No.	Rhythm Pattern (Measure)
R-1	4/4 (1)
R-2	3/4 (1)
R-3	6/8 (1)
R-4	8Beat (1)
R-5	16Beat (1)
R-6	Rock (1)
R-7	Ballad (1)
R-8	Disco (1)
R-9	R&B 1 (1)
R10	R&B 2 (1)
R11	Skip Beat (1)
R12	Shuffle (1)
R13	Triplet (1)
R14	March (1)
R15	Waltz (1)
R16	Swing (1)
R17	BossaNova (2)
R18	Samba (1)
R19	Rhumba (2)
R20	Mambo (2)
R21	Tango (2)
R22	Beguine (2)
R23	CountIn 1 (2)
R24	CountIn 2 (2)
R25	C.InSwing (1)
R26	Ending 1 (1)
R27	Ending 2 (1)
R28	Sticks4/4 (1)
R29	Sticks3/4 (1)
R30	Sticks6/8 (1)

TERMS

What Are Music Files?

Music files contain information describing the details of a musical performance, such as "the C3 key on a keyboard was pressed for this amount of time, using this amount of force." By inserting the floppy disk into the disk drive on the MT 300s, the performance information is sent from the floppy disk to the piano, and played faithfully by the piano. This is different than a CD, since the music file does not contain a recording of the sound itself. This makes it possible to erase certain parts, or to change instruments, tempos and keys freely, allowing you to use it in many different ways.

Regarding Copyright

Use of the song data supplied with this product for any purpose other than private, personal enjoyment without the permission of the copyright holder is prohibited by law. Additionally, this data must not be copied, nor used in a secondary copyrighted work without the permission of the copyright holder. Using existing copyrighted material (commercially available SMF music files, etc.) to create your own composition is permitted only for your private, personal enjoyment. Be aware that any other use may constitute copyright infringement. Roland Corporation assume no responsibility whatever for any copyright infringement that may result from a work that you create.



The Music File Disk included with the MT 300s

Floppy disks saved on a Roland MT Series, or Roland Piano Digital HP-G/KR Series instrument

Roland Digital Piano Compatible music files

Roland's original music file is made specifically for practicing the piano. Some follow an instructional curriculum, allowing for a complete range of lessons, such as "practicing each hand separately" or "listening to only the accompaniment."

SMF Music files (720KB/1.44MB Format)

SMF (Standard MIDI Files) use a standard format for music file that was formulated so that files containing music file could be widely compatible, regardless of the manufacturer of the listening device. An enormous variety of music is available, whether it be for listening, for practicing musical instruments, for Karaoke, etc.

If you wish to purchase SMF music files, please consult the retailer where you purchased your MT 300s.

Floppy Disks Containing SMF (Standard MIDI File) Songs Created with a Computer Sequencer

The MT 300s can play back SMF (Standard MIDI File) songs for GS sound generators that are created on computers and similar equipment.

- * *SMF songs created on IBM or IBM-compatible PCs, and playable with GS sound generators can be played back and recorded upon as is. You can use other sequencers and computers (including Atari, Macintosh computers) to play back and record SMF songs created for GS sound generators by saving their files on a computer using 3.5-inch 2DD floppy disks formatted on the MT 300s.*
- * *When you want to use the MT 300s to listen to songs created on Atari series computers, first save the songs on floppy disks that have been formatted on the MT 300s. However, you cannot put songs saved in a different format on the same disk.*
- * *Some songs may not be completely playable on the MT 300s.*
- * *Whenever possible, convert songs to Format 0.*

Format 1 suffers the following limitations:

- Handles a maximum of only 33 data tracks.
 - Cannot play back some songs containing large amounts of data.
 - Requires more time to begin playback of songs.
- * *Save SMF (Standard MIDI File) songs created on Macintosh computers onto MT 300s-formatted disks, using Apple File Exchange or Macintosh PC Exchange software. When doing this, change the file name, using a maximum of eight characters followed by the .MID extension.*

Ex.: abcdefgh.MID

<Sound Generator>

Comforms to GM/GS

Max.Polyphony

64 Voices

Tones

369 variations (incl.8 drum sets, 1 SFX set)

Master Tuning

415.3 Hz-466.2 Hz (0.1 Hz Steps)

Playback Transpose

-24→+24 Half-steps

Effects

Reverb (8 types)

Chorus (8 types)

<Composer>

Metronome

Beat (2/2, 0/4, 2/4, 3/4, 4/4, 5/4, 6/4, 7/4, 3/8, 6/8, 9/8, 12/8)

Volume (10 levels)

Metronome Pattern (11 patterns)

Sounds (4 Types)

Tracks

5/16 tracks

Song

1 song

Note Storage

Approx. 30,000 notes

Tempo

Quarter note= 20-250

Resolution

120 ticks per quarter note

Recording Method

Realtime (Replace, Mix, Auto Punch In, Manual Punch In, Loop, Tempo)

Beat Map

Edit

Copy

Quantize

Delete

Insert

Erase

Transpose

Part Exchange

Note Edit

PC Edit

Rhythm Pattern

30 Patterns

Control

Song Select

Reset, Stop, Play, Rec

Bwd, Fwd

All song Play

Track Select

Maker Set

Repeat

Count In

Tempo Mute

<Disk Drive/Disk Storage>

3.5 inch Micro Floppy Disk Drive

Disk Format

720 K bytes (2DD)/1.44 M bytes (2HD)

Songs

Max. 99 Songs

Note Storage

Approx. 120,000 notes (2DD)

Approx. 240,000 notes (2HD)

Playable Software

Standard MIDI Files (format 0/1)

Roland Original Format (i-format)

Save

Standard MIDI Files (format 0)

Roland Original Format (i-format)

<Others>

Rated Power Output

10 W x 2

Speakers

10 cm x 2

Display

Beat Indicator

Large custom LCD

Bouncing Ball

Language

English/Japanese

Lyric

Yes (Built-in Display, MIDI Out)

Control

Volume

Microphone Volume

Microphone Echo

Speaker Switch

Reverb Switch (One Touch 3 Types)

Connectors

Output jacks (Stereo/RCA-Pin)

Microphone jack (with echo)

Headphone jack (Stereo Mini)

MIDI In connector

MIDI Out connector

Computer connector

Expression pedal jack

Start/Stop jack

Power Supply

AC117 V/AC230 V/AC240 V

Power Consumption

34 W (117 V)/34 W (230 V)/34 W (240 V)

Dimensions

394 (W) x 223 (D) x 207 (H) mm

15-9/16 (W) x 8-13/16 (D) x 8-3/16 (H) inches

Weight

4.2 kg/91 lbs 5 oz

Accessories

Owner's manual

Power Cord

MIDI Cable

Music File Disk

** In the interest of product improvement, the specifications and/or appearance of this unit are subject to change without prior notice.*



Consult your MT 300s dealer when purchasing the items listed below.

MIDI Implementation

Pedal Switch: DP-2

Expression Pedal: EV-5

Stereo Headphones: RH-80/120

Microphone: DR-10/20

Microphone stand: ST-210/259

MIDI cable: MSC-15/25/50

Audio cable:

PCS-075W/150W/250W/100PW

Computer cable:

RSC-15APL/RSC-15AT/RSC-15N

** When purchasing headphones, make sure you get stereo headphones.*

** Please buy an audio cable with a standard phone plug.*

Basic Settings

The sounds and volume levels for each part, the basic tempo, and other settings that are predetermined for each song are called the "basic settings." On the MT 300s, you can listen to songs after temporarily making changes to the parameters of a song's basic settings—the status of each part's tone, volume, panpot, reverb, and chorus—and change the basic settings and basic tempo of the song itself (p.56).

Bouncing Ball

The flashing dot that moves in a semicircular pattern across the screen of the MT 300s is called a "bouncing ball" (p.15).

Drum Set

A Drum Set is a collection of percussive instrument sounds. With drum sets, a different sound can be heard for each key on the keyboard. The special effects sound set is called the SFX Set (p.55, 58, 64, 109).

Editing

Editing is to change the song you have recorded, such as by erasing part of the song, or copying a measure (p.78).

Ensemble

"Ensemble" is when two or more instruments perform at the same time.

Part

On the MT 300s, "Part" can have two different meanings. One meaning refers to a performance part, such as the right-hand part of a piano song (p.38). The other refers to the 16 parts in the 16-track sequencer (p.55, 56).

Pickup

A song with a pickup does not start on the first beat (p.73).

Playback

The MT 300s plays back the performance information (p.26).

PU (Pickup)

A song that does not start on the first beat starts with what is called a pickup. When playing a pickup song, the measures will be shown in the display as "PU, 1, 2..." (p.26).

Saving

Saving is storing the recorded performance data onto a floppy disk (p.49).

Sound Generator

The sound generator of the MT 300s supports GM/GS, and can play more than 300 different sounds (p.101).

Standard Pitch

The pitch of the sound created by playing the middle A on the keyboard is called the "standard pitch." Changing the standard pitch of the MT 300s is called "Master Tuning," and tuning to other musical instrument is called "Tuning" (p.19, 24).

Tone

Tones are the musical instruments or effect sounds stored in the internal memory of the MT 300s.

You want to : Play back all the music files (All Song Play, p. 27)

Do this : While pressing the Play [▶] button, press the [Song] button.

You want to : Return to the beginning of the song (p. 28)

Do this : While pressing the Stop [■] button, press the Bwd [◀◀] button.

You want to : Go to the end of a song (p. 28)

Do this : While pressing the Stop [■] button, press the Fwd [▶▶] button.

You want to : Check the location of markers (p. 29)

Do this : Simultaneously press the [A] and [B] buttons.

You want to : Delete a marker (p. 30)

Do this : Press the [A] button (or [B] button) while pressing the [Marker Clear] button.

You want to : Move a marker (p. 30)

Do this : While pressing the [A] button (or [B] button), press the Bwd [◀◀] or Fwd [▶▶] button.

You want to : Move the region marked by markers A and B (p. 32)

Do this : While simultaneously pressing both the [A] and [B] buttons, press either the Bwd [◀◀] or Fwd [▶▶] button.

You want to : Return to the original tempo (p. 33)

Do this : While pressing the Tempo [▶] button, press the Reset [◀] button.

You want to : Defeat any tempo changes and play back the song at one set tempo (Tempo Mute, p. 34)

Do this : While pressing the Tempo [▶] button, press the Stop [■] button.

You want to : Cancel the tempo mute setting

Do this : While pressing the Tempo [▶] button, press the Play [▶] button.

You want to : Cancel the transposition setting (p. 35)

Do this : While pressing the [Transpose] button, press the Reset [◀] button.

You want to : Change the metronome volume (p. 37)

Do this : Hold down the [Metronome] button, and rotate the [Dial].

You want to : Delete music recorded to track buttons (p. 48)

Do this : While pressing the [Track] button, press the Rec [●] button.

You want to : Delete recorded songs (p. 48)

Do this : While pressing the [Song] button, press the Rec [●] button.

You want to : Change the basic tempo of the song (Writing to a Setup, p. 58)

Do this : While pressing the Rec [●] button, press the Reset [◀] button.

You want to : Delete the sound of a part in the 16-track sequencer (p. 64)

Do this : While pressing the Rec [●] button, press the [Transpose] button.

You want to : Get ready for tempo recording (p. 74)

Do this : While pressing the Tempo [▶] button, press the Rec [●] button.

You want to : Undo the most recent editing operation (p. 78)

Do this : While pressing the Reset [◀] button, press the [Transpose] button.

MIDI Implementation Chart

Function...	Transmitted	Recognized	Remarks
Basic Channel Default Changed	x x	1-16 1-16	
Mode Default Messages Altered	x x *****	Mode 3 Mode 3, 4(M=1)	* 2
Note Number : True Voice	x *****	0-127 0-127	
Velocity Note ON Note OFF	x x	O x	
After Touch Key's Ch's	x x	O *1 O *1	
Pitch Bend	x	O *1	
Control Change	0, 32 x 1 x 5 x 6, 38 x 7 x 10 x 11 x 64 x 65 x 66 x 67 x 84 x 91 x 93 x 98, 99 x 100, 101 x	O *1 O *1 O *1 O *1 O *1 O *1 O *1 O *1 O *1 O *1 O *1 O *1 O (Reverb) *1 O (Chorus) *1 O *1 O *1	Bank select Modulation Portamento time Data entry Volume Panpot Expression Hold 1 Portamento Sostenuto Soft Portamento control Effect1 depth Effect3 depth NRPN LSB, MSB RPN LSB, MSB
Prog Change : True #	x *****	O *1 0-127	Program number 1-128
System Exclusive	x	O	
System Common : Song Pos Song Sel Tune	x x x	x x x	
System Real Time : Clock Commands	x x	x x	
Aux Message : All sound off Reset all controllers Local Control All Notes OFF Active Sensing Reset	x x x x x x	O (120, 126, 127) O x O (123-125) O x	
Notes	* 1 O x is selectable by SysEx. * 2 Recognized as M=1 even if M≠1.		

Mode 1 : OMNI ON, POLY Mode 2 : OMNI ON, MONO O : Yes
 Mode 3 : OMNI OFF, POLY Mode 4 : OMNI OFF, MONO X : No

MIDI Implementation Chart

Function...		Transmitted	Recognized	Remarks
Basic Channel	Default Changed	1-16 x	1-16 x	
Mode	Default Messages Altered	Mode 3 x *****	Mode 3 x	
Note Number :	True Voice	0-127 *****	0-127 0-127	
Velocity	Note ON Note OFF	O x 8n v=64	O x	
After Touch	Key's Ch's	O O	O O	
Pitch Bend		O	O	
Control Change	0, 32 1 5 6, 38 7 10 11 64 65 66 67 84 91 93 98, 99 100, 101 (2-119)	O O O O O O O O O O O O O O O O O	O O O O O O O O O O O O O O O O O	Bank select Modulation Portamento time Data entry Volume Panpot Expression Hold 1 Portamento Sostenuto Soft Portamento control Effect1 depth Effect3 depth NRPN LSB, MSB RPN LSB, MSB
Prog Change	: True #	O 0-127 *****	O 0-127	Program number 1-128
System Exclusive		O	O	
System Common	: Song Pos : Song Sel : Tune	x x x	x x x	
System Real Time	: Clock : Commands	O *1 O	O *1 O *1	
Aux Message	: All sound off : Reset all controllers : Local Control : All Notes OFF : Active Sensing : Reset	O O O O O x	O (120, 126, 127) O O O (123-125) O x	
Notes		* 1 O x is selectable. * 2 Recognized as M=1 even if M≠1.		

Mode 1 : OMNI ON, POLY
 Mode 3 : OMNI OFF, POLY

Mode 2 : OMNI ON, MONO
 Mode 4 : OMNI OFF, MONO

O : Yes
 X : No

A	
All Song Play	p.27
B	
Beat Map	p.76
Beat Indicator	p.15
Blank Recording	p.63
Bouncing Ball	p.15
Bwd (Backward)	p.28
C	
Chorus Effect	p.57, 97
Chorus Send Level	p.57
Computer Switch	p.14
Connectors	p.14
Copy	
Measure	p.79
Rhythm Pattern	p.82
Count In	p.39
Cursor	p.15
D	
Delete	
Measure	p.86
Recording Song	p.48
Recording Track	p.48
Disk Song	p.53
Disk Drive	p.12, 25
Display	p.15
Drum Set	p.109
E	
Edit	p.78
Effects	p.20, 57, 97
Eject Button	p.25
Ensemble	p.62
Erase	p.88
F	
Factory Preset	p.95
Floppy Disk	p.5, 25
Format	p.49
Fwd (Foward)	p.28
G	
General MIDI	p.101
GS	p.101
I	
Insert	p.87
K	
Karaoke	p.54
Key	p.35, 54
L	
Language	p.99
Loop Recording	p.69
Lyric	p.99
M	
Marker	p.29
Metronome	p.36
Metronome Pattern	p.95
Mic Echo	p.54
Microphone	p.54
MIDI	p.100
Clock Out	p.103
Rx Ch Convert	p.102
Soft Thru	p.103
Sync Switch	p.102
MIDI Out	p.101
Minus One	p.60
Mix Recording	p.68
Music Files	p.112
Mute	p.38
N	
Note Edit	p.92
P	
Panpot	p.57
Part	
16 Track screen	p.55, 56
Piano Light Hand (Piano Left Hand)	p.38
Part Exchange	p.91
PC Edit	p.93
Pedal	p.17, 98
Piano Switch	p.21
Pickup Notes	p.73
Program Change	p.93
Protect Tab	p.5, 49
PU (Pick up)	p.73
Punch In Recording	p.70
Q	
Quantize	p.85
R	
Recording	p.41, 61
Repeat	p.26, 31
Replace Recording	p.67
Reverb Effect	p.20, 57, 97
Reverb Send Level	p.57
Rhythm Pattern	p.77, 82
S	
Save	p.49
SFX Set	p.110
SMF	p.112
Song Edit	p.78
Sound Generator	p.101
Speaker Switch	p.14
Standard MIDI Files	p.112
Standard Pitch	p.19, 24
T	
Tempo Recording	p.74
Tempo Mute	p.34
Tone	p.55, 56
Track Button	p.38
Transpose	
Playback Transpose	p.35
16 Part	p.90
Tuning	p.19, 24
U	
Undo	p.78
V	
Velocity	p.92
Volume	
Master	p.19, 23
Metronome	p.37, 95
16 Part	p.57

Roland®

71451845

UPC 71451845



1296

Roland®