

# Roland

**MIDI SOUND MODULE**  
**SUPER JUPITER**

# MKS-80

## Owner's Manual

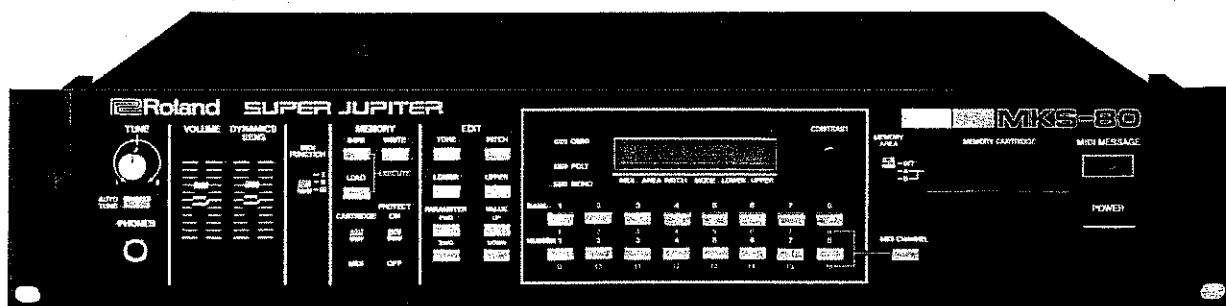

## RADIO AND TELEVISION INTERFERENCE

**Warning** — This equipment has been verified to comply with the limits for a Class B computing device, pursuant to Subpart J, of Part 15, of FCC rules. Operation with non-certified or non-verified equipment is likely to result in interference to radio and TV reception.”

---

The equipment described in this manual generates and uses radio-frequency energy. If it is not installed and used properly, that is, in strict accordance with our instructions, it may cause interference with radio and television reception.

This equipment has been tested and found to comply with the limits for a Class B computing device in accordance with the specifications in Subpart J, of Part 15, of FCC Rules. These rules are designed to provide reasonable protection against such a interference in a residential installation.

However, there is no guarantee that the interference will not occur in a particular installation. If this equipment does cause interference to radio or television reception, which can be determined by turning the equipment on and off, the user is encouraged to try to correct the interference by the following measure:

- Disconnect other devices and their input/output cables one at a time. If the interference stops, it is caused by either the other device or its I/O cable.

These devices usually require Roland designated shielded I/O cables. For Roland devices, you can obtain the proper shielded cable from your dealer. For non Roland devices, contact the manufacturer or dealer for assistance.

If your equipment does cause interference to radio or television reception, you can try to correct the interference by using one or more of the following measures:

- Turn the TV or radio antenna until the interference stops.
- Move the equipment to one side or the other of the TV or radio.
- Move the equipment farther away from the TV or radio.
- Plug the equipment into an outlet that is on a different circuit than the TV or radio. (That is, make certain the equipment and the radio or television set are on circuits controlled by different circuit breakers or fuses.)
- Consider installing a rooftop television antenna with coaxial cable lead-in between the antenna and TV.

If necessary, you should consult your dealer or an experienced radio/television technician for additional suggestions. You may find helpful the following booklet prepared by the Federal Communications Commission:

“How to Identify and Resolve Radio-TV Interference Problems”

This booklet is available from the U.S. Government Printing Office, Washington, D. C., 20402, Stock No.004-000-00345-4.

# 1 PANEL DESCRIPTION

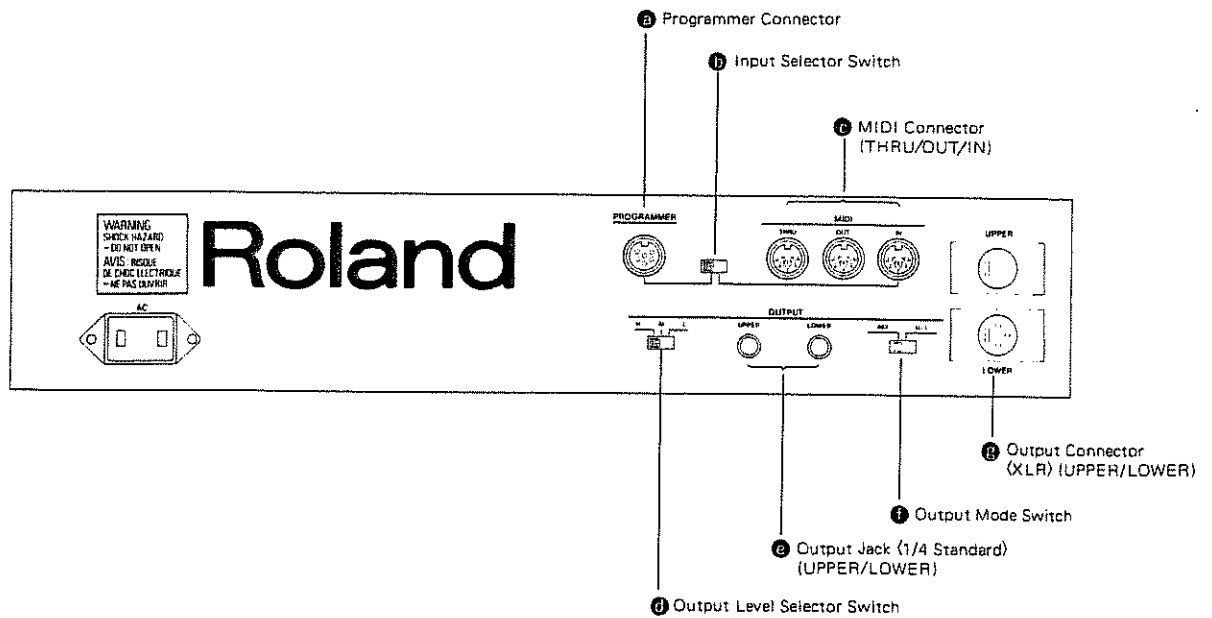
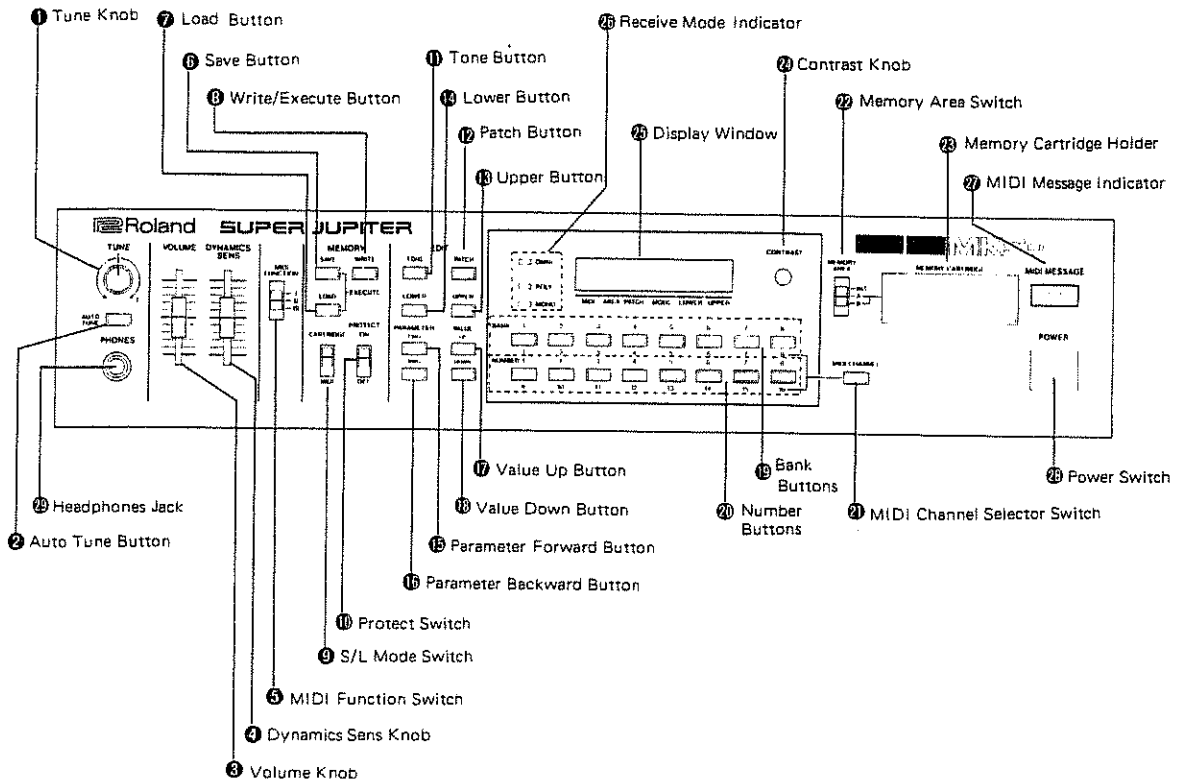

The MKS-80 is an 8 voice, 16 VCO polyphonic synthesizer module that can be played by MIDI music messages sent from the other MIDI device.

## FEATURES

- The MKS-80 has memory capacity that retains 64 different tone colors. By using the Memory Cartridge M-64C that retains up to 128 tone colors, total of 192 patch programs can be available.
- The MKS-80 features battery backup system that retains the data in memory even when switched off.
- Auto Tune function that allows all VCO's to be instantaneously tuned just by pressing a button.
- Patch Preset is a program that can contain a tone color (or even a pair of tone colors depending on the Key mode setting) and various mode and effect settings.
- The Detune function enables a powerful ensemble effect in Unison mode.
- The Octave Shift function allows shifting the pitch of the entire keyboard without changing the VCO range.
- Data in the MKS-80's memory can be transferred to another MKS-80 or to a computer.
- The MKS-80's dynamics function can change the attack time as well as the level.
- By the unique Envelope Reset function, each time you press a new key, the note will start from the beginning of the envelope curve.
- By using the optional Programmer MPG-80, synthesizing will become much easier.

It is important to understand all the functions of the MKS-80 to make the best use of it. Please read the separate volume "MIDI" and this owner's manual.

## CONTENTS

<b>1 Panel Description</b> . . . . .	<b>3</b>	b. How to use the Programmer MPG-80 . . . . .	<b>28</b>
A. Front Panel . . . . .	3	1) Method 1 . . . . .	28
B. Rear Panel . . . . .	3	2) Method 2 . . . . .	29
<b>2 Connection</b> . . . . .	<b>6</b>	<b>E. Write Mode</b> . . . . .	<b>30</b>
<b>3 Operation</b> . . . . .	<b>7</b>	a. Writing a Tone Memory . . . . .	30
A. Outline of the MKS-80 . . . . .	7	b. Writing a Patch Preset . . . . .	31
B. Play Mode . . . . .	8	<b>F. Memory Cartridge</b> . . . . .	<b>32</b>
a. MIDI Channel Setting . . . . .	8	a. Saving onto the Memory Cartridge . . . . .	32
b. MIDI Function Switch . . . . .	8	b. Loading from the Memory Cartridge . . . . .	34
c. Tone Color Selection . . . . .	9	<b>4 MIDI</b> . . . . .	<b>36</b>
1) Calling a Patch Preset . . . . .	10	A. Saving and Loading . . . . .	36
2) Calling a Tone Memory . . . . .	10	a. Saving the data in the MKS-80	
d. Auto Tune . . . . .	13	to a MIDI device (or computer) . . . . .	37
e. Volume . . . . .	13	b. Loading the data in the MIDI device	
f. Dynamics Sens Knob . . . . .	13	(or computer) to the MKS-80 . . . . .	39
g. Contrast Knob . . . . .	13	B. Indicators . . . . .	40
C. Edit Mode (I) . . . . .	14–20	a. Receive Mode Indicators . . . . .	40
a. Parameters of Tone Memory Section . . . . .	14	b. MIDI Message Indicators . . . . .	40
b. Editing a Tone Memory . . . . .	21	<b>5 Tables</b> . . . . .	<b>41</b>
c. Parameters of Patch Preset Section . . . . .	22–25	Edit Map . . . . .	11
d. Editing a Patch Preset . . . . .	26	Parameter Table . . . . .	41
D. Edit Mode (II) . . . . .	27	Display Message Table . . . . .	44
a. Setting up the Programmer MPG-80 . . . . .	27	Program Change Table . . . . .	45
1) Programmer Connector . . . . .	27	MIDI Function Table . . . . .	46
2) Connection . . . . .	27	<b>6 Specifications</b> . . . . .	<b>47</b>

\* Before turning the MKS-80 on, make sure that the Protect Switch **10** is set to the ON position. Otherwise the data in memory may be destroyed.

## IMPORTANT NOTES

### Power Supply

- The appropriate voltage to be used is shown on the name plate on the rear panel. Be sure that it meets the voltage system in your country.
- Do not use the same socket that is used for any noise generating device, such as a motor, or variable lighting system.
- When setting up the MKS-80, be sure that all the units are turned off.
- This unit might not work properly if turned on immediately after turned off, or if the power cable is plugged in with the unit turned on. If this happens, simply turn the unit off, and turn it on again in a few seconds.
- This unit might get hot while operating, but there is nothing to worry about.

### Location

- Operating the MKS-80 near a neon or fluorescent lamp may cause noise interference. If so, change the angle or position of the MKS-80.
- Avoid using the MKS-80 in extreme heat or humidity or where it may be affected by dust.

### Cleaning

- Use a soft cloth and clean only with a mild detergent.
- Do not use solvent such as paint thinner.

## 2 CONNECTION

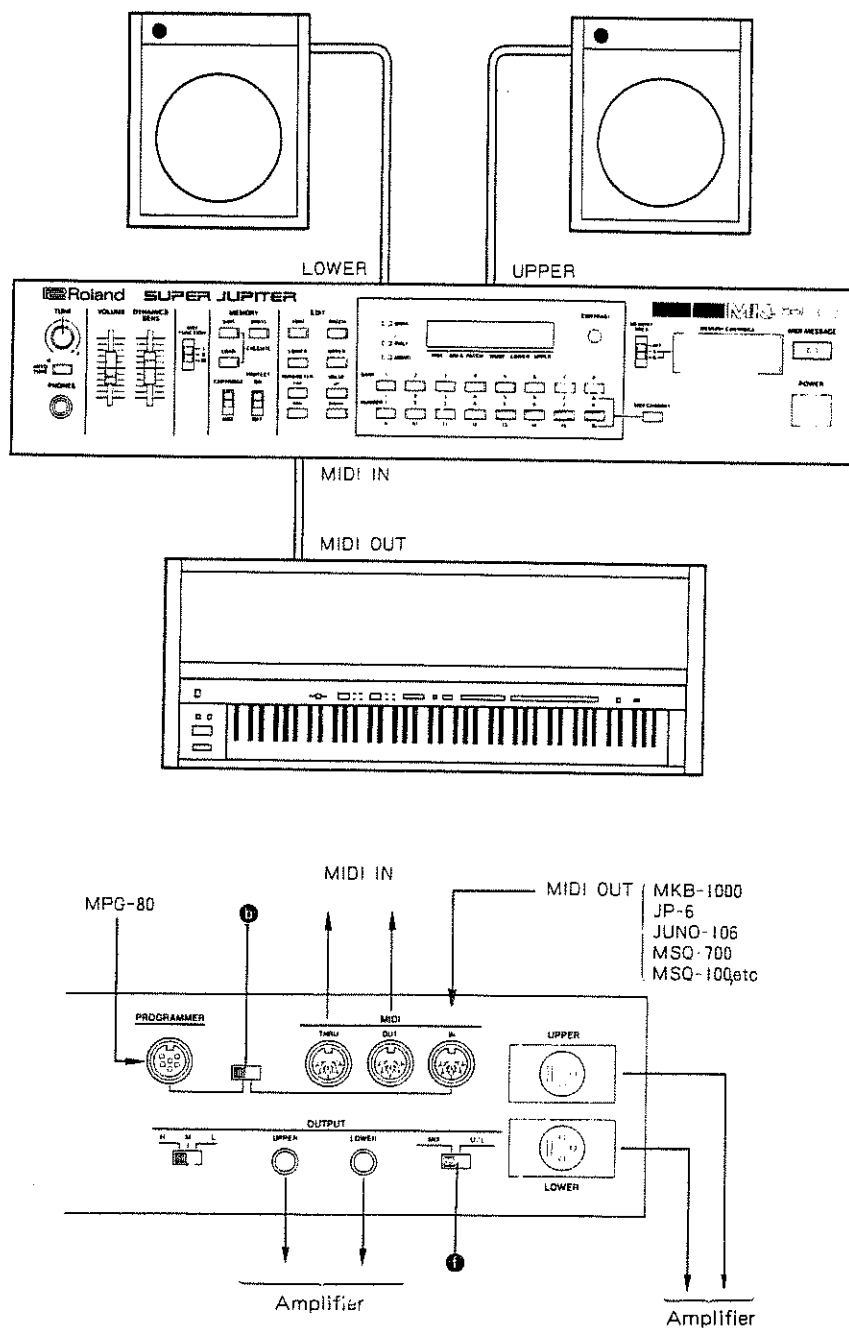

When the MKS-80 is used in monaural, set the Output Mode Switch **f** to the Mix position. If it is set to the U/L position, the MKS-80 may not sound at all.

\* Before setting up the units, make sure that all the units are turned off and the volume of the amplifier is set to zero.

### ■ Input Selector Switch **b**

This selects whether to receive the MIDI message from the MIDI IN Jack or the Programmer Connector. When not using the Programmer, set it to the MIDI position, if it is set to the Programmer position, the message received from the MIDI IN will be ignored.

### 3 OPERATION

#### A. OUTLINE OF THE MKS-80

The MKS-80 is a polyphonic synthesizer module that can be played by the MIDI music messages sent from the external device.

If the MKS-80 is properly set up with a device transmitting MIDI music messages, it will be ready to be played by powered on. There are 64 tone colors (we call them **Tone Memories**) and 64 combination programs of a tone color (or a pair of tone colors) and various effect and mode settings (we call

them **Patch Presets**) preprogrammed in the MKS-80's memory which can be recalled to be used just by pressing buttons.

Also, these Tone Memories and Patch Presets can be edited as you like. **This editing operation, however, does not automatically rewrite the existing tone color.** If you wish to write the edited tone color, appropriate writing operation is required.

#### ■ MEMORY CARTRIDGE

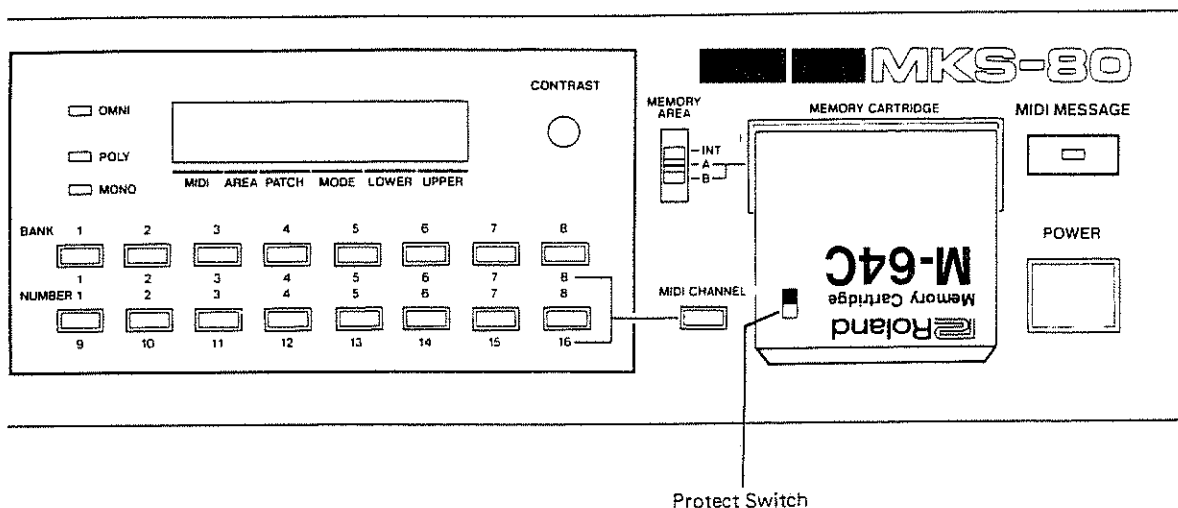

The supplied Memory Cartridge M-64C can be effectively used to expand the memory capacity. The M-64C has two separate blocks A and B, and can retain 64 different Tone Memories and Patch Presets in each block. The cartridge memory can be used exactly like the internal memory of the MKS-80. You may consider it as a part of internal memory. Be sure that the Protect Switch on the Cartridge is set to the ON position when connecting it to the

MKS-80 or disconnecting, otherwise the data in memory might be damaged. Securely insert the Cartridge to the Cartridge Holder ② of the MKS-80 with its Protect Switch facing upward.

\* To prevent accidental loss of the data, set the Protect Switch to the ON position except for when writing new data.

\* Refer to Patch Preset and Tone Memory on page 9.

## B. PLAY MODE

Make sure that all the connections have been correctly made, and turn on the MKS-80, then the keyboard, and finally the amplifier. Now, the MKS-80's Display Window shows AUTO TUNE, all the 16 VCO's being automatically tuned. And soon, the Display will respond as shown right.

At this stage, if the MKS-80 receives the message on the same MIDI Channel as shown at "a" in the Display, it will operate. While the MKS-80 is receiving any message, the MIDI Message Indicator is lighted. If the message is transmitted on a different channel, the MKS-80 cannot receive the message, therefore, the indicator stays dark.

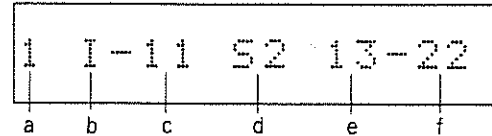

\* The letters "a" to "f" represent the following elements.

- a MIDI Channel
- b Memory Area
  - I - Internal Memory (INT)
  - A - Memory Cartridge (A)
  - B - Memory Cartridge (B)
- c Patch Number
- d Key Mode
  - W - Whole
  - S2 - Split 2
  - S1 - Split 1
  - D - Dual
- e Lower Tone Number
- f Upper Tone Number

### a. MIDI Channel Setting

① Press the MIDI Channel Button **11**, and the display will respond as shown right.

② While holding the MIDI Channel Button **11**, assign the MIDI Channel by pressing a Bank Button **19** and a Number Button **20**. The Display shows the selected MIDI Channel in blue numbers.

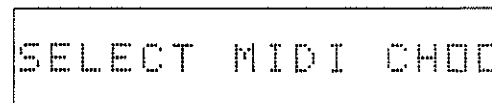

\*   represent the MIDI Channel currently remembered in memory.

\* The set MIDI Channel is remembered even after power off, so the next time the MKS-80 is powered on, the previous MIDI Channel remains.

### b. MIDI Function Switch

With this switch, you can select which of the MIDI function to be used.

\* To prevent improper operation, select either the I or II position. The III position is to be selected only for a special purpose (Exclusive Message).

\* For the details of the MIDI Function Switch, refer to page 46.



### c. Tone Color Selection

#### ■ Tone Memory and Patch Preset

There are two types of patch programs in the MKS-80's memory.

One is called **Tone Memory** which is a tone color with various parameter settings of such as VCO, VCF, VCA, ENV sections. Up to 64 different Tone Memories can be retained in memory and each Tone Memory has its own number from 11 to 88 (we call it **Tone Number**).

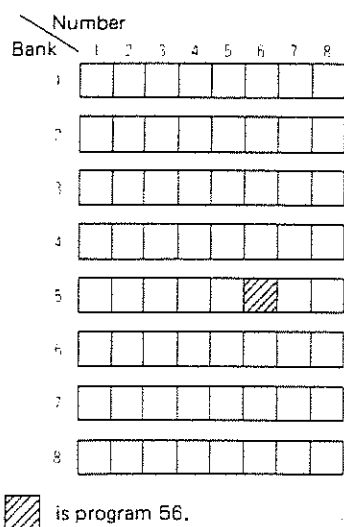

Another is called **Patch Preset** which is a combination of a Tone Number or a pair of Tone Numbers and various settings of effects and modes. A Patch Preset can only remember the combination of the Tone Number(s) and effect and mode settings, that is, it has no ability of retaining the tone color itself. Therefore, if the Tone Memory is edited or replaced with a new tone color, the Patch Preset will accordingly altered. Up to 64 Patch Presets can be stored in memory, and each Patch Preset has a number from 11 to 88 (we call it **Patch Number**).

\* To assign a Tone Number or Patch Number, simply press the relevant Bank and Number Buttons.

e.g.) Press the Bank Button (5) and the Number Button (6) to select Program 56.

#### ■ MEMORY AREA

Depending on the position of the Memory Area Switch (2), available memory area will change as shown below.

INT — Internal memory of the MKS-80

A — Memory Cartridge Block A

B — Memory Cartridge Block B

\* At power up, Patch Preset 11 in the selected memory area is automatically recalled. If, however, the Memory Cartridge is not connected, Patch Number 11 in the Internal memory will be called.

## 1) Calling a Patch Preset

Any Patch Preset can be recalled in the Play mode.

- ① Set the Memory Area Switch ②② to the desired position.
- ② By using a Bank Button ①⑨ or Number Button ②⑩ , assign the Patch Preset you wish to recall.

## 2) Calling a Tone Memory

You cannot change Tone Memories in the Play mode. Turn the MKS-80 to the Edit mode.

- ① Set the Memory Area Switch ②② to the desired position.
- ② Press the Tone Button ①① .
- ③ By using a Bank Button ①⑨ and a Number Button ②⑩ , assign the Tone Memory you wish to recall.

\* To turn the MKS-80 to the Play mode, just press the Tone Button ①① again.

\* If you try to call a Tone Memory in the Cartridge without the Cartridge connected to the MKS-80, the Display will respond as shown below.

INSERT CARTRIDGE

Cont. to p. 13 

■ EDIT MAP

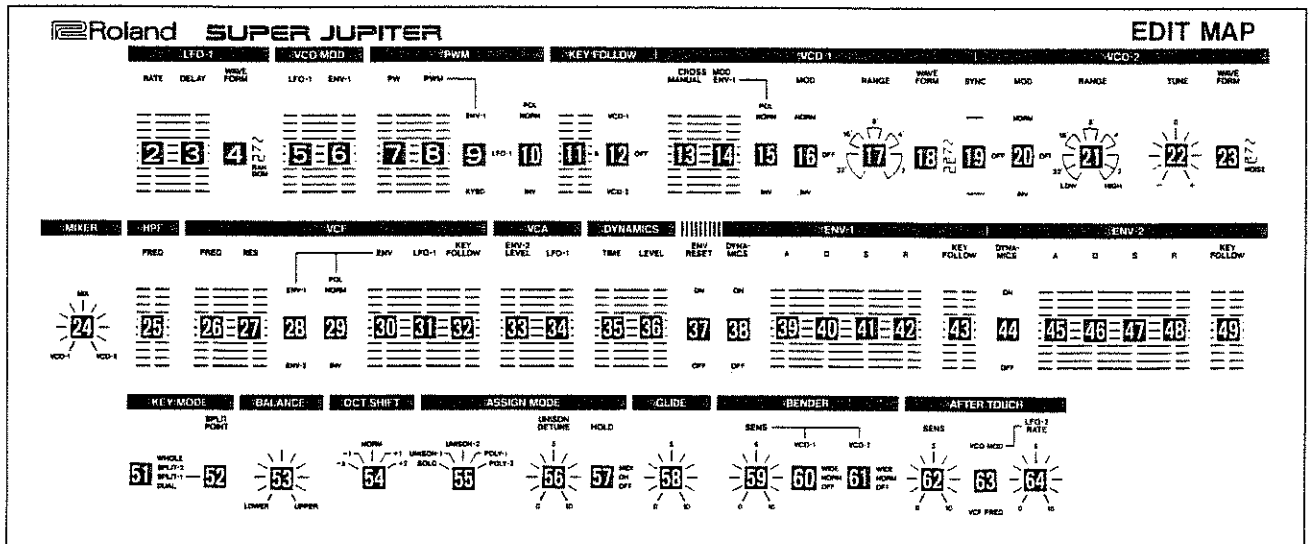

■ PROGRAMMER

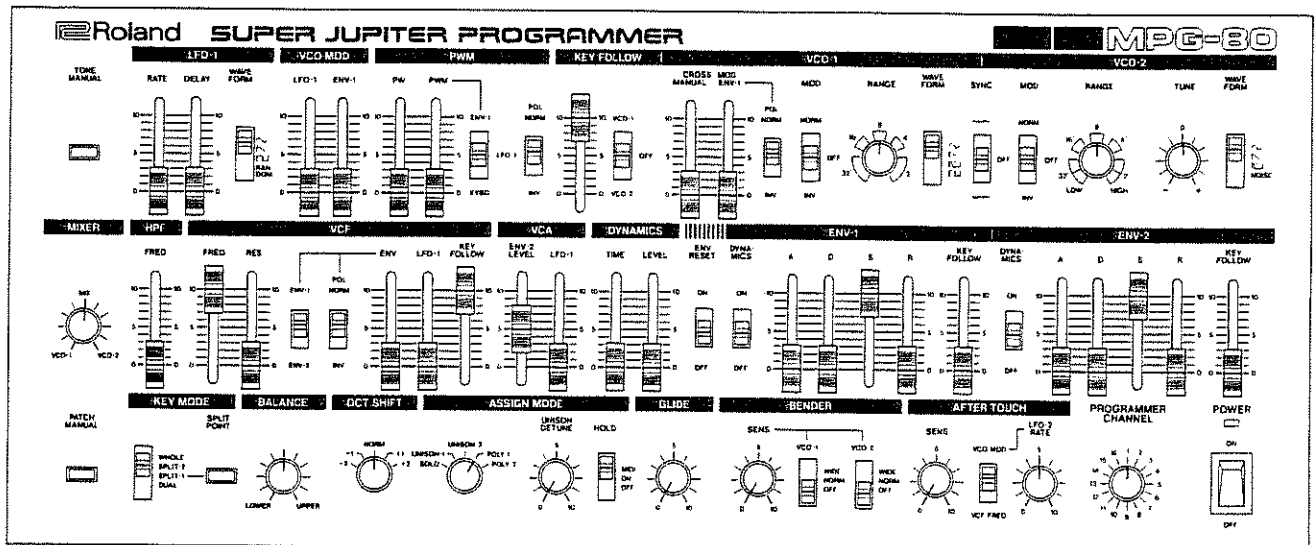



d. Auto Tune

All 16 VCO's will be instantaneously tuned just by flick of a switch even during live performance.

\* At power up, the Auto Tune function will automatically work. When the MKS-80 is not warmed up enough, the pitches are unstable. Press the Auto Tune Button ② when the MKS-80 is well warmed.

To tune the MKS-80 with other musical instrument, adjust the Tune Knob ① which is variable within  $\pm 50$  cent ( $\pm 1/4$  tone).

f. Dynamics Sens Knob

Even if this knob is raised, there will be no dynamics effect obtained, unless the dynamics is turned on in the Tone Memory currently in use.

\* The values of the Dynamics and Volume cannot be written into memory.

g. Contrast Knob

This adjusts the contrast of the Display Window.

e. Volume Knob

This controls the overall volume of the MKS-80, and the headphones volume.

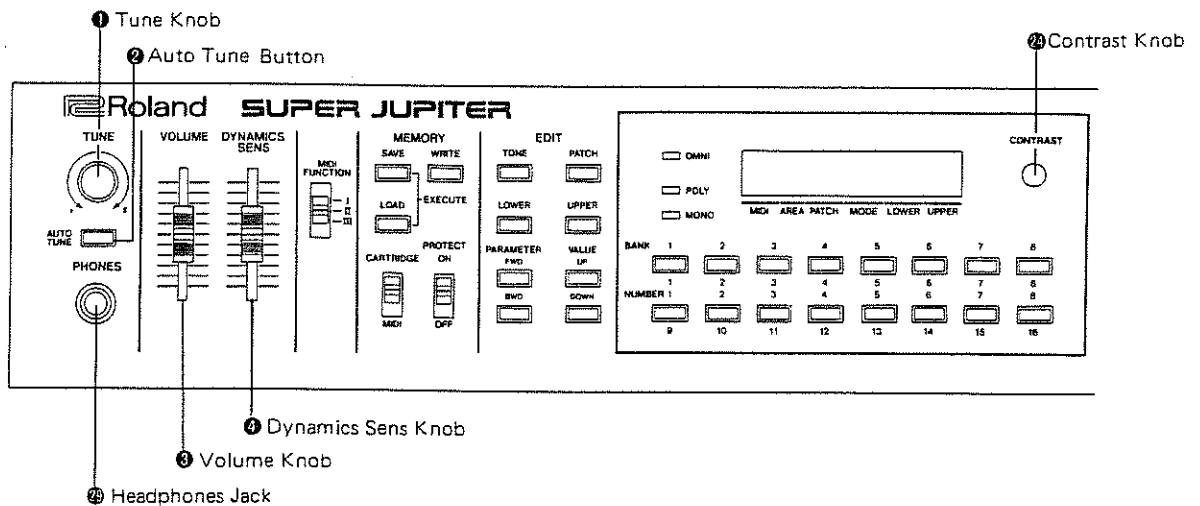

### C. EDIT MODE (I)

Like any analog synthesizer, the MKS-80 has various parameters which can be edited for sound synthesis. The MKS-80, however, does not feature knobs or switches on its panel for you to touch or move. Instead, there are two methods of synthesizing. One is calling each parameter and changing its value by using the panel buttons on the MKS-80. Another is by using the optional programmer MPG-80 which works just like panel controls of a synthesizer.

The Edit function does not automatically rewrite the existing program, unless the appropriate procedure for rewriting is done.

#### a. Parameters of Tone Memory Section

All the parameters in the Tone Section can be used to edit a Tone Memory.

\* See the Edit Map on p. 11, too.

**LFO-1** This is a Low Frequency Oscillator which controls the VCO and VCF, etc.

#### **2** LFO Rate (0—100)

This controls the rate of the LFO-1. At zero, obtained rate is the slowest, and as the value is increased, the rate is quickens.

#### **4** LFO Waveform ( , , , RND)

This is to select the output waveform of the LFO-1. There are four types of waveforms optional.

#### **3** LFO Delay Time (0—100)

This sets the time required for the LFO-1 to start its modulation after a key is pressed on the keyboard. At zero, there is no delay time.

## VCO Modulation

VCO's frequency can be controlled by the LFO-1 or ENV-1.

### 5 VCO Modulation LFO-1 Depth (0–100)

When the LFO-1 is modulating the VCO's frequency, this value decides the intensity of the modulation. At zero, there is no modulation obtained, and as the value is increased, deeper pitch modulation is obtained.

### 6 VCO Modulation ENV-1 Depth (0–100)

When the ENV-1 is controlling the VCO's frequency, the value set here decides the intensity of the modulation. At zero, there is no modulation, and as the value is increased, deeper pitch modulation is obtained.

## Pulse Width Modulation

The ratio of the VCO's pulse wave can be altered by ENV-1, LFO-1 or keyboard.

### 7 Pulse Width (0–100)

This sets the ratio of the VCO's pulse wave. At 0, pulse width ratio is 50%, making a square wave. And as you increase the value, the pulse width will become narrower, the sound disappearing just before 100%.

### 8 PWM (0–100)

The ratio of the pulse wave set with the Pulse Width **7** can be modulated by the ENV-1, LFO or keyboard. The PWM Knob decides the intensity of the modulation. At value zero, there is no modulation, and as the value goes up, deeper modulation is obtained.

### 9 PWM Mode Selector (ENV, LFO, KYBD)

This selects which one of the ENV-1, LFO-1 or the keyboard modulates the pulse width.

#### \* Modulating pulse width by keyboard

The width of pulse wave generated from the MKS-80 can be changed depending on the key you play. If all the pulses are set exactly the same ratio, higher note may sound thin. To solve this problem, it is a good idea to set the pulse in the higher pitch to wider.

### 10 PWM Polarity (NRM, INV)

This selects the polarity of the waveform or envelope curve that controls PWM. For instance, if using the ENV-1 for modulation, the pulse width gets wider in the Normal, and narrower in the Invert mode.

## VCO Key Follow

In the VCO section, Key Follow function is provided to detune the generated sound. This also can be effectively used during synthesizing with Cross Modulation function.

### 11 VCO Key Follow (0–100)

This is usually set to 100%, but can be set to any value you like from 0 to 100%. At 0%, the pitch obtained will be always the same regardless of which key is pressed. And as you increase the value, the pitch alteration will be more drastic.

### 12 VCO Selector (1, OFF, 2)

With this, you can select which of the VCO-1 or 2 should take on the Key Follow effect set at the VCO Key Follow. At OFF, both VCO-1 and 2 take on 100% Key Follow.

## Cross Modulation

Here, the output waveform from the VCO-2 changes the VCO-1's pitch. With the VCO-2 set to the Low Frequency, complicated pitch alteration can be obtained with combination of the LFO-1.

### 13 Cross Modulation Manual Depth (0–100)

The intensity of the Cross Modulation can be manually changed. At 0, there is no effect obtained, and increasing the value will deepen the pitch alteration.

### 15 Cross Modulation Polarity (NRM, INV)

This selects the polarity of the ENV-1 output set above. In Normal, the ENV curve starts from zero to its maximum, and at Invert, the curve will reach to zero finally.

### 14 Cross Modulation ENV-1 Depth (0–100)

This decides the amount of ENV-1's output sent to the Cross Modulation. At 100, maximum effect is obtained.

## VCO-1

### 16 VCO-1 Modulation (NRM, OFF, INV)

This controls ON/OFF of the VCO-1 Modulation. In Normal, higher CV makes higher pitch, and in Invert, the other way round.



**17** VCO-1 Range (32C-2C)

This selects the pitch of the VCO-1 in half tone step from 32' to 2'. The Display Window shows the note represented by MIDI Key number 60 (which corresponds with Middle C of the piano keyboard).

**Synchro**

By synchronizing two VCO's, complicated waveform, which is impossible to make with a single VCO, can be created.

**19** VCO SYNC (1 → 2, OFF, 1 ← 2)

This controls ON/OFF of the VCO synchro, and its direction.

**VCO-2**

By mixing this with VCO-1, or using Synchro or Cross Modulation function, wide variety of sound synthesis is possible.

**20** VCO-2 Modulation (NRM, OFF, INV)

This selects the ON/OFF of the VCO-2 modulation. In Normal, higher CV makes higher pitch, and in Invert, the other way round.

**21** VCO-2 Range (LOW, 32C-2C, HI)

This selects the pitch of the VCO-2 in half tone step from 32' to 2', and also selects Low or High Frequency. The Display Window shows the note represented by MIDI Key number 60 (which corresponds with Middle C of the piano keyboard).

**Mixer**

**24** Source Mixer (0-100)

This sets the proportion of the signal from the VCO-1 and 2. At 0, only the VCO-1 sound is heard, and as the value increases, the proportion of the VCO-2 increases, and at 100, only the VCO-2 sound is obtained.

**18** VCO-1 Waveform ( S, T, L, H )

This selects the output waveform from the VCO-1.

**22** VCO-2 Fine Tune

This is the VCO-2's tuning function ranging from -50 to +50 cents ( $\pm 1/4$  tone).

**23** VCO-2 Waveform ( S, T, L, NIS)

This selects the output waveform of the VCO-2.

**High Pass Filter**

This filter lets the high frequency harmonics pass and cuts off the low harmonics.

**25 High Pass Filter Cutoff Frequency**

This sets the cutoff point of the HPF. As the value is increased, lower frequency is cut off.

**VCF**

This filter changes the tone color by cutting off or emphasizing harmonics. This filter lets the low frequency harmonics pass and cuts off the high frequency. Also the cutoff frequency of this filter is controlled by the LFO or Envelope.

**26 VCF Cutoff Frequency (0–100)**

This controls the cutoff frequency of the VCF. At 100, the original waveform passes without being changed, and as the value is decreases, higher frequency is cutoff.

**27 VCF Resonance (0–100)**

This emphasizes the cutoff point set with the Cutoff Frequency **26**. At 0, there is no effect, and as you raise the value, certain harmonics are emphasized, and created sound will become more unusual, more electronic in nature.

**28 VCF Envelope Selector (EG1, EG2)**

This selects which of ENV-1 or 2 controls the VCF.

**29 VCF Envelope Polarity (NRM, INV)**

This selects the polarity of the envelope curve that controls the VCF. At Normal the curve goes up from zero up to its maximum.

**30 VCF Modulation ENV Depth (0–100)**

This sets the amount of Envelope which controls the cutoff frequency. At 0, there is no effect, and as the value increases, the modulation becomes more intensive.

**31 VCF Modulation LFO Depth (0–100)**

This sets the amount of the LFO-1 that controls the cutoff frequency of the VCF. At 0, there is no effect and as the value increases the modulation becomes more intensive.

**32 VCF Key Follow (0–100)**

The cutoff frequency of the VCF can be changed depending on the key pressed. At 0, however, the cutoff frequency does not change at all. At 100, the cutoff frequency will fully change according to the pitch of the key pressed.

**VCA** This controls the volume (amplitude) of the sound.

**33** VCA Level (0 to 100)

This sets the level of the ENV-2 that controls the VCA, so it should be set considering the volume difference caused in changing the tone colors.

**34** VCA Modulation LFO-1 Depth

This sets the amount of the LFO-1 that control the VCA level. At 0, there is no effect, and as the value is increased, the amount of the signal increases.

**Dynamics** This is to change the level or attack time of the envelope by the velocity of key pressure. The message which controls dynamics is MIDI Key Velocity.

**35** Dynamics Time (0 to 100)

This decides the amount of the Key Velocity that controls attack time of the envelope. At 0, the attack time remains at its set level, and as the value is increased, attack time gets shorter by harder key attack.

**36** Dynamics Level (0 to 100)

This decides the amount of the Key Velocity that controls the level of envelope. At 0, the level remains at its set level however hard the key is attacked. But as the value is increased, the envelope level changes more obviously depending on how you play the keyboard, that is, the harder you attack the key, the higher the level will be.

**Envelope** This section processes the gate signal generated by Key ON/OFF to control VCF, VCO, etc. Basically, it consists of Attack Time, Decay Time, Sustain Level and Release Time.

**37** Envelope Reset (ON, OFF)

This selects whether to start each note from the beginning of the envelope curve, or continue the curve from the present level. When it is ON, each time you press a new key, the note will start from the beginning of the envelope curve.

**38** ENV-1 Dynamics (ON, OFF)

**44** ENV-2 Dynamics (ON, OFF)

These two are both to select whether to control the envelope with Key Velocity message or not.

**39** ENV-1 Attack Time (0–100)

**45** ENV-2 Attack Time (0–100)

These set the time required for the signal to reach its maximum from the moment the key is pressed down. At 0, the shortest attack time is obtained.

**40** ENV-1 Decay Time (0–100)

**46** ENV-2 Decay Time (0–100)

These adjust the time needed for the signal to drop from the maximum to the sustain level. At 0, the quickest decay time is obtained.

- \* When the sustain level is set to 100, the envelope curve does not change by the decay time setting.

**41** ENV-1 Sustain Level (0–100)

**47** ENV-2 Sustain Level (0–100)

This determines the sustain level to which the signal falls at the end of the decay time.

At 100, this equals to the peak level of the envelope curve. ...

**42** ENV-2 Release Time (0–100)

**48** ENV-2 Release Time (0–100)

These determine the time needed for the voltage to reach zero from the moment the key is turned OFF. At 0, the shortest release time is obtained.

**43** ENV-1 Key Follow (0–100)

**49** ENV-2 Key Follow (0-100)

The time required for the envelope to complete its curve can be changed depending on which key is pressed. There is no change of the time at all when the Key Follow is set to 0, but as the value is increased, envelope time becomes shorter with higher key pressed.

## b. Editing a Tone Memory

All the parameters in the Tone Section can be edited to your taste as follows.

- ① Press the Tone Button **11**, and the button lights up and the Display will respond as shown below.

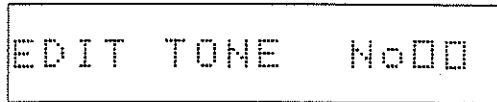

- \*  is the Tone Number currently called.

- ② Assign the Tone Memory which you wish to edit with a Bank Button **19** and a Number Button **20**.

- ③ By pressing the Parameter Forward Button **15**, go to the parameter whose value you wish to change. If you happen to come too far, use the Backward Button **16**.

- ④ By using the Value Up **17** or Down **18** Button, change the value as you like.

- ⑤ Repeat the step **③** and **④** as many times as necessary.

- ⑥ Press the Tone Button **11** to return to the Play mode.

The editing operation does not automatically rewrite the existing Tone Memory. If you wish to retain the edited Tone Memory, writing operation is required.

### ■ Repeat Function

If you wish to change the Parameter Number or Parameter Value quickly, hold down the relevant buttons; Parameter Forward, Backward, Value Up and Down Button, instead of releasing the button each time.

### ■ Display response in Edit Mode

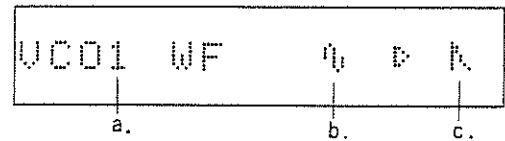

- a. Parameter
- b. Parameter value written in memory
- c. Edited parameter value

- \* The edited parameter value is not automatically written into memory.

### c. Parameters in Patch Preset Section

A Patch Preset includes the following parameters which can be spontaneously edited.

\* The Edit Map shown on P. 11 will help you understand the parameters easier.

#### Key Mode

### 51 Key Mode (Whole, Split 2, Split 1, Dual)

These four Key Modes are optional.

#### □ Whole Mode

In this mode the MKS-80 acts as an 8 voice synthesizer. Receiving the message sent from an external device, the MKS-80 can output up to 8 notes at a time. When 9 notes are received, the 9th note will be ignored. When the Key mode is changed from the Dual or Split to Whole, the tone color of the Upper Section will remain.

#### □ Split Mode

In this mode, the MKS-80 acts as two polyphonic synthesizers. The keyboard is split into Lower and Upper sections at the set split point, each having 4 synthesizer modules. Two different tone colors and mode settings can be separately assigned.

#### ● Split 1

When the keyboard does not have the Split function, select this key mode. The MKS-80 can remember the key number of the split point, and distribute the received message to the relevant section.

#### ● Split 2

When the keyboard features the Split function, select this mode. The message sent on the same MIDI Channel as the MKS-80 is distributed to the Upper, and the message sent on the channel one number bigger is distributed to the Lower Section.

\* When the MKS-80 chooses MIDI Channel 3, message sent from the external device on channel 3 is assigned to the Upper section, and channel 4 message works on the Lower section.

#### □ Dual Mode

In this mode, the MKS-80 acts as a 4 voice synthesizer with two independent modules.

Even if the keyboard does not feature the Dual mode setting the MKS-80 to the Dual mode will allow Dual mode performance. And when the keyboard features the Dual mode, the MKS-80 can be set to either the Split 2 or Dual mode.

**\* Split and Dual Mode on the Keyboard**

When the keyboard does not feature either the Split or Dual mode, or if it is set to the Whole mode, the MIDI message is sent only on the channel the keyboard is set to.

If the keyboard is set to the Split mode, the key higher than the split point is sent on the current set MIDI channel as Upper section message. And the key lower than the split point is sent on the channel number one bigger as Lower section message.

When the keyboard is set to the Dual mode, a key message will be sent on the current MIDI channel as Upper section message, and on the channel one bigger than that as Lower section message.

**Balance**

**53** Balance (0–100)

This sets the volume balance of the upper and lower sections in Split or Dual mode. At 0, only lower section output, and at 100, only upper section output is obtained.

**Octave Shift**

Without changing the VCO's range, the pitch of the entire keyboard can be transposed in an octave.

**54** Octave (+2, +1, NORM, -1, -2)

In Normal, no transposition is done, and from -2 to +2 octave transpositions are optional in one octave step.

**52** Split Point (A0 to C8)

When the MKS-80 is set to the Split 1 mode, this value determines the split point. A0 is represented by MIDI key number 21. (C4 corresponds with C4 of the piano keyboard.)

**Tone Number**

**Tone Number (11 to 88)**

This is to assign a Tone Number or pair of Tone Numbers. Use the Bank Buttons **19** and Number Buttons **20**.

**55** Assign Mode (Solo, Unison 1, Unison 2, Poly 1, Poly 2)

The above four Assign Modes are optional.

□ Solo

This mode turns the MKS-80 to a monophonic synthesizer following Last Note Priority. Last Note Priority is that the last key pressed is selected when more than one key is pressed at a time.

□ Unison 1

This turns the MKS-80 to a monophonic synthesizer following Last Note Priority. In the Whole mode, all 8 synthesizer modules will be assigned to each key.

□ Unison 2

The maximum synthesizer modules applied to one key changes depending on how many keys you are pressing.

In the Whole mode

1 key	8 modules
2 keys	4 modules each
3 or 4 keys	2 modules each
more than 5 keys	1 module each

In the Split mode

1 key	4 modules
2 keys	2 modules each
3 or 4 keys	1 module each

In the Dual mode

1 key	8 modules
2 keys	4 modules each
3 or 4 keys	2 modules each

□ Poly 1

This mode turns the MKS-80 to an 8 voice polyphonic synthesizer assigning one synthesizer module to each key pressed. (In the Dual mode, 2 modules to each.) This is suitable for the sound with long release time.

□ Poly 2

This is very similar to Poly 1 mode, the only difference is that Poly 2 is suitable for portamento.

**56** Unison Detune (0–100)

As you increase the value, the pitch difference increases and richer ensemble effect will be obtained.



**57** Hold (MIDI, ON, OFF)

MIDI MIDI Hold (Damper) message can make a sustained sound.

ON MIDI Hold message will be ignored. The note played will be sustained even after the key is released, but playing a new key will kill the old note, retaining only the new note.

OFF There is no Hold function.

**Glide**

**58** Glide (Portamento) (0–100)

This adjusts the Portamento time. At 0, there is no portamento effect.

**After Touch**

The VCO pitch or cutoff frequency of the VCF can be controlled by after touch message (MIDI Channel Pressure or Modulation wheel).

**62** After Touch Sensitivity (0–100)

This determines the maximum effect of the After Touch message that controls the VCO or VCF. At 0, there is no effect, and as the value is raised, the effect becomes wider.

**Bender**

**59** Bender Sensitivity (0–100)

This adjusts the maximum effect of Bender. At 100, pitch bender effect up to about 1 octave (Normal) is obtained.

**60** VCO-1 Bender (WIDE, NORM, OFF)

**61** VCO-2 Bender (WIDE, NORM, OFF)

The above 2 parameters control ON/OFF and the range of pitch bender effect.

With the Bender Sens set to 100

Wide Approx. 2.5 octave

Normal Approx. 1 octave or more

**63** After Touch Mode Selector (VCO, VCF)

If VCO is selected, the after touch message will control the VCO's pitch, and if VCF, the VCF's cutoff frequency.

**64** LFO-2 Rate (0–100)

This decides the rate of the LFO-2 that is used for VCO modulation by after touch message.

#### d. Editing a Patch Preset

All the parameters in the Patch Preset Section can be edited as follows.

- ① Press the Patch Button 12 . The button will light up and the Display will respond as shown below.



\*  is the Patch Number currently called.

- ② Assign the Patch Preset you wish to edit with a Bank Button 19 and Number Button 20 .

- ③ By using the Parameter Forward Button 15 , go to the parameter whose value you wish to change. If you have come too far, use the Backward Button 16 .

- ④ By using the Value Up 17 and Down 18 Button, change the value as you like.

- ⑤ Repeat steps ③ and ④ as many times.

- ⑥ Press the Patch Button 12 to return to the Play mode.

\* When the Split or Dual Key mode is selected, the Tone Number and its follower parameters can be set separately in each upper and lower section. To edit the parameter in the upper section, press the Upper Button 13 , and to edit the lower section, press the Lower Button 14 . The button pressed will light up. In the Whole mode, both Upper and Lower Buttons are lighted.

This editing operation, however, does not automatically rewrite the existing Patch Preset. If you wish to write the edited Patch Preset, appropriate writing operation is required.

## D. EDIT MODE ( 2 )

By using the optional programmer MPG-80, editing or synthesizing operation will become considerably quicker and easier.

### a. Setting up the Programmer MPG-80

Use the supplied 6P DIN Cord for setup.

#### 1) Programmer Connector

The Programmer Connector in the rear panel is to connect the MPG-80. Connecting any other device to this connector will cause break down. Also, never leave the cable connected here without the MPG-80 connected to the other end.

\* Through the Programmer Connector, direct current of about 8V comes out. Please be careful about handling.

#### 2) Connection

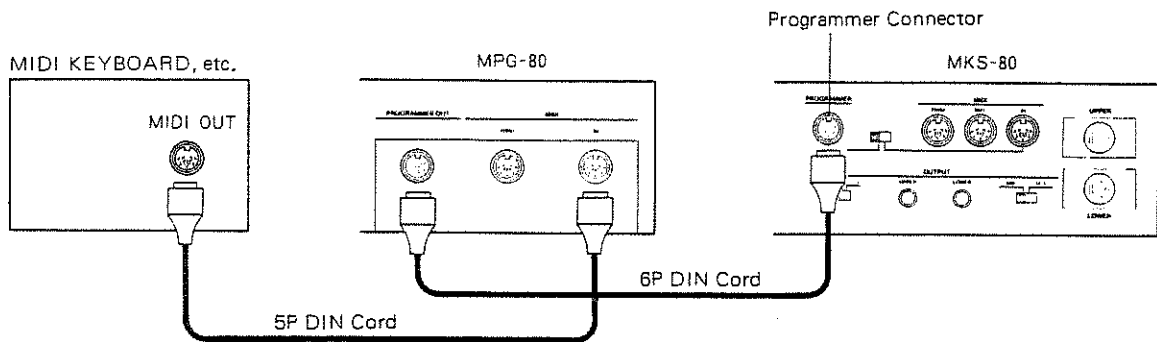

\* As shown below, the message received through MIDI IN of the MPG-80 is sent to the MKS-80

through the Programmer Connectors in the exact same shape.

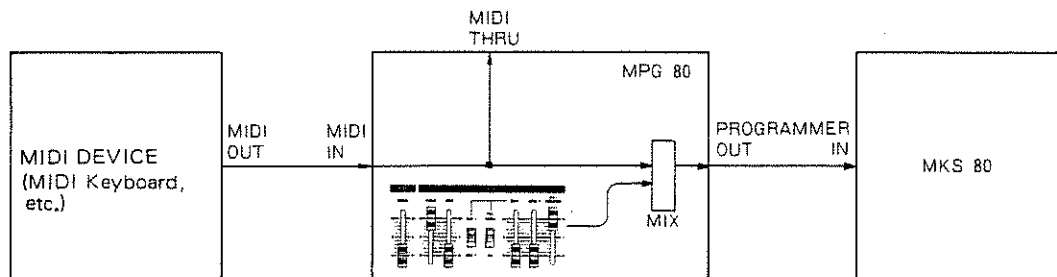

### b. How to use the Programmer MPG-80

Make sure that all the connections have been correctly made. Turn on the MKS-80 first, then the MPG-80, the keyboard and finally the amplifier. Turn the MKS-80 to the Play or Edit mode, then recall any Tone Memory or Patch Preset you wish to edit.

If you wish to edit only a few parameters, remaining the rest of parameter values intact, take the **method (1)**. Also, if you wish to synthesize from scratch, take the **method (2)**.

#### Method (1)

① Set the Input Selector Switch ⑤ on the MKS-80 to the Programmer position.

\* Now, the message received through MIDI IN of the MPG-80 is sent to the MKS-80 through the Programmer Connectors in the exact same form.

② Set the MIDI Function Switch ⑥ to the III position.

③ Set the Programmer Channel Switch of the Programmer to the same number as the MIDI Channel selected on the MKS-80.

④ Move the desired controls on the Programmer, and the values of the corresponding parameters will change.

⑤ When you have completed editing, press either the Tone Button ① or the Patch Button ② which is lighted.

\* Set the MIDI Function Switch to the I or II position.

## Method (2)

- ① Set the Input Selector Switch **b** to the Programmer position.
- ② Set the MIDI function Switch **5** on the MKS-80 to the **III** position.
- ③ Set the Programmer Channel Switch of the Programmer to the same number as the MIDI Channel selected on the MKS-80.
- ④ Press the Tone Manual Button **1**, if you wish to make a Tone Memory. And press the Patch Manual Button **50**, if you wish to make a Patch Preset.
- ⑤ Make your own sound by using the controls on the Programmer.
- ⑥ When you have completed synthesizing, press the Tone Button **1** or Patch Button **12**.

### ■ Setting Split Point

The following is how to set the split point by using the programmer.

Press the Split Point Button, and without releasing it, press a key. The pressed key will be the lowest key of the Upper section. The split point you set, however, has no meaning in the Whole or Dual mode.

\* If you wish to retain the edited program, take the following writing procedure.

## E. WRITE MODE

An edited program can be written into memory for storage and later retrieval.

Before going to the following writing procedure, make sure that the MKS-80 is set to either Play or Edit mode, if not, turn it to the Play mode.

\* Please always keep the Protect Switch ⑩ to the ON position except for during Writing mode. In this way, the data in memory will be protected from accidental loss.

### a. Writing a Tone Memory

① Set the Memory Area Switch ⑫ to the appropriate position depending on which memory you wish to use for writing the edited program.

② Press the Write/Execute Button ⑧, and the button starts flashing.

③ If the Tone Button ⑪ is not lighted, press it. Then it will light up and the Display will respond as shown right.

```
WRITE      TONE      **
```

④ If you wish to write into the internal memory of the MKS-80, set its Protect Switch ⑩ to the OFF position. And to write into the cartridge, set its Protect Switch to OFF.

⑤ Assign the Tone Number where you wish to write the edited program by using the Bank Button ⑬ and Number Button ⑭.

```
WRITTEN TONE  00
```

Now, writing is done, and the Display responds as shown right.

\*  represents the Tone Number just written.

⑥ Set the Protect Switch to the ON position.

b. Writing a Patch Preset

- ① Set the Memory Area Switch ⑫ to the appropriate position depending on which memory you wish to use for writing the edited program.
- ② Press the Write/Execute Button ⑧, and the button starts flashing.
- ③ If the Patch Button ⑬ is not lighted, press it. Then it will light up and the Display will respond as shown right.
- ④ If you wish to write into the internal memory of the MKS-80, set its Protect Switch ⑩ to the OFF position. And to write into the cartridge, set its Protect Switch to OFF.
- ⑤ Assign the Patch Number where you wish to write the edited program by using the Bank Button ⑨ and Number Button ⑭.

Now, writing is done, and the Display responds as shown right.

- ⑥ Set the Protect Switch to the ON position.

**(Note)**

If the Protect Switch is set to the ON position, the Display will respond as shown right.

If you have tried to write into the Cartridge without the Cartridge connected to the MKS-80, the Display will respond as shown right.

If any above indication is seen, simply press the Write/Execute Button ⑧. The MKS-80 will return to the condition just before the Write/Execute Button ⑧ was pressed, allowing you to repeat the writing procedure.

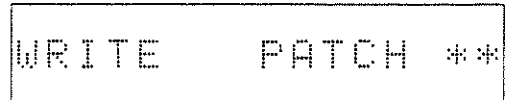

WRITE PATCH \*\*

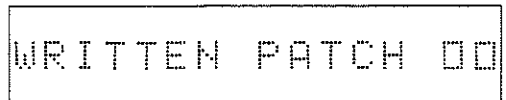

WRITTEN PATCH 00

\*  represents the Patch Number just written.

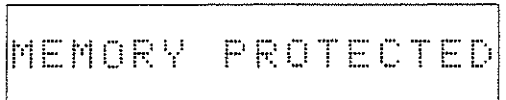

MEMORY PROTECTED

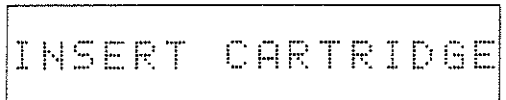

INSERT CARTRIDGE

## F. MEMORY CARTRIDGE

The data in the internal memory of the MKS-80 can be saved onto the cartridge. Also, the saved data can be loaded from the cartridge to the MKS-80 at any time later. This saving and loading

operation can be done only with the MKS-80 set to the Play-mode, if it is set to other mode, turn it to the Play mode then take the following operation.

### a. Saving onto the Memory Cartridge

- ① Connect the Memory Cartridge to the Cartridge Holder ⑭ on the MKS-80.
- ② Set the Memory Area Switch ⑳ to the A or B position.
- ③ Set the Save/Load Switch ① to the Cartridge position.
- ④ Set the Protect Switch of the Memory Cartridge to the OFF position.
- ⑤ Press the Save Button ⑥, and the Display will respond as shown right.

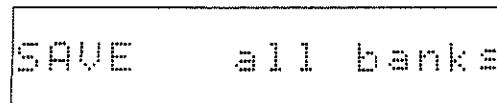

SAVE all banks

- ⑥ If you wish to save the whole data in memory onto the cartridge, go straightly to step ⑦.

And if you wish to save the data in a bank or banks, assign the bank or banks by pressing the Bank Button(s) while holding the Save Button ⑥.

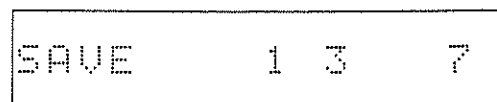

SAVE 1 3 7

\* This is the example when bank 1, 3 and 7 are assigned.

- ⑦ Press the Save Button ⑥, and without releasing it press the Write/Execute Button ⑧. The Display will respond as shown right.

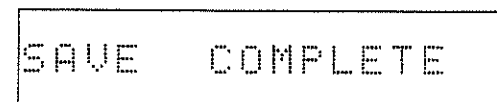

SAVE COMPLETE

- ⑧ Set the Protect Switch of the Memory Cartridge to the ON position.



**(Note)**

\* If `SAVE COMPLETE` is not seen in the step ⑦, simply press the Write/Execute Button ⑧. The MKS-80 will return to the condition just before the Save Button was pressed (in the step ⑤), allowing you to repeat the saving procedure.

(e. g.)

If the Protect Switch is set to the ON position, the Display will respond as shown right.

MEMORY PROTECTED

If the Cartridge has not been connected to the MKS-80, the Display will respond as shown right.

INSERT CARTRIDGE

If the Memory Area Switch ⑫, is set to the INT position.

FUNCTION ERROR

■ DATA BACKUP

To prevent accidental loss of the data in the MKS-80's memory, save the important data into the Memory Cartridge.

**b. Loading from the Memory Cartridge**

- ① Connect the Memory Cartridge.
- ② Set the Memory Area Switch ⑫ to the A or B position.
- ③ Set the S/L Mode Switch ⑨ to the Cartridge position.
- ④ Set the Protect Switch ⑩ to the OFF position.
- ⑤ Press the Load Button ⑦, and the Display will respond as shown right.
- ⑥ If you wish to load the whole data on the cartridge into the MKS-80, straightly go to the step ⑦.

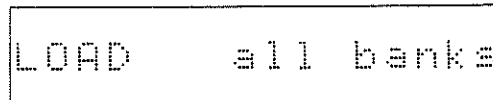

LOAD all banks

And if you wish to load the data in a bank or banks, assign the bank number or numbers by pressing Bank Button(s) ⑬ while still holding the Load Button ⑦.



LOAD 45 8

\* The above is the example when Banks 4, 5 and 8 are assigned.

- ⑦ Press the Load Button ⑦, and without releasing it, press the Write/Execute Button ⑧. The Display will respond as shown right.
- ⑧ Set the Protect Switch of the MKS-80 to the ON position.

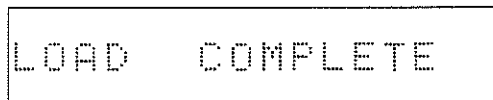

LOAD COMPLETE

**(Note)**

- \* If LOAD COMPLETE is not seen in the step ⑦, simply press the Write/Execute Button ⑧. The MKS-80 will return to the condition just before the Load Button was pressed (in the step ⑤), allowing you to repeat the loading procedure.

(e. g.)

If the Protect Switch ⑩ is set to the ON position, the Display will respond as shown right.

MEMORY PROTECTED

If the Cartridge has not been connected to the MKS-80, the Display will respond as shown right.

INSERT CARTRIDGE

If the Memory Area Switch ⑫ is set to the INT position.

FUNCTION ERROR

## 4 MIDI

### A. Saving and Loading

The data in MKS-80's memory can be saved into another MKS-80 or computer using MIDI. Also, the saved data can be at any time loaded back to the MKS-80.

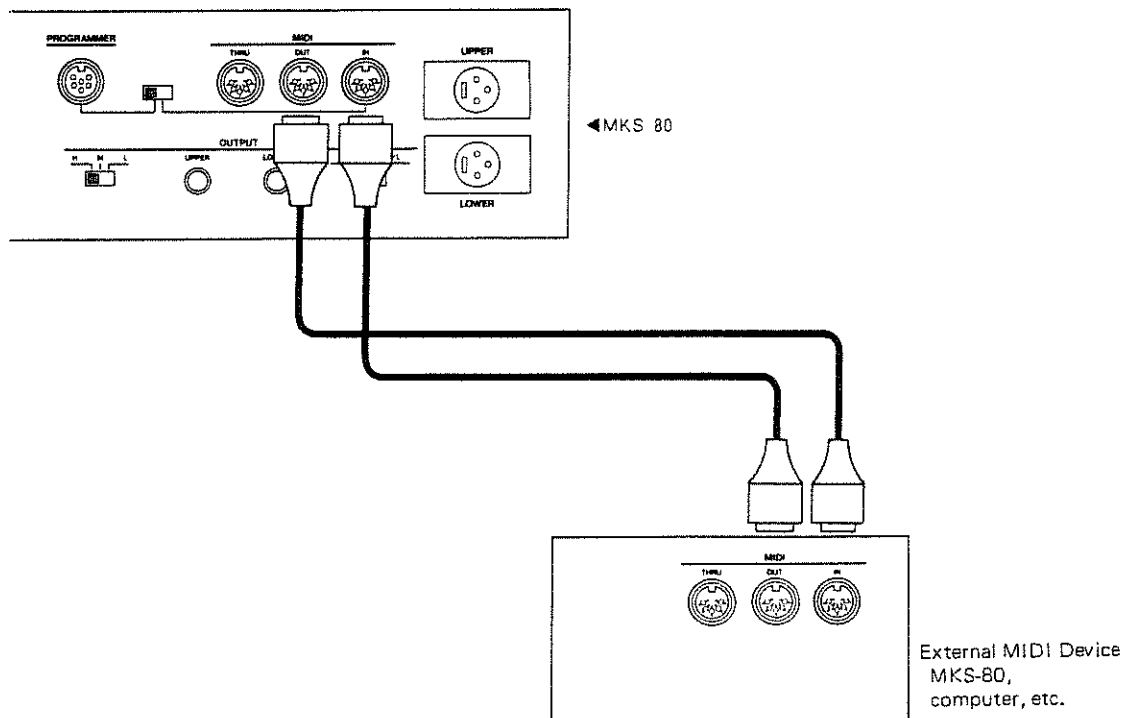

The saving and loading operation can be done only when the MKS-80 is set to the Play mode, if it is set to other mode, turn it to the Play mode then take the following operation.

a. Saving the data in the MKS-80 to a MIDI device (or computer)

- ① Set the S/L Mode Switch ④ to the MIDI position.
- ② Set the MIDI Function Switch ⑤ to the III position.
- ③ Set the Protect Switch of the receiver to the OFF position.
- ④ Press the Save Button ⑥. The Display will respond as shown right.

Here, if you wish to save the entire data in memory, go straightly to step ⑤.

If you wish to select a bank or banks to be saved, without releasing the Save Button ⑥, assign the bank or banks by pressing the Bank Button ⑩.

- ⑤ While still holding the Save Button ⑥, press the Write/Execute Button ⑧. The Display will respond as shown right.

And in about a second, saving will be completed with the Display as shown right.

Then, the MKS-80 is returned to the condition just before the Save Button ⑥ was pressed (in the step ④).

- ⑥ Set the Protect Switch of the receiver to the ON position.
- ⑦ If not specifically required, set the MIDI Function Switch ⑤ to the I or II position.

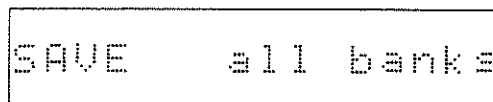

SAVE all banks

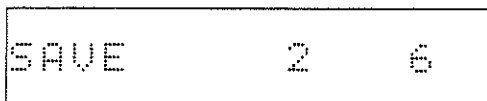

SAVE 2 6

\* The above is the example when banks 2 and 6 are assigned.



SAVING

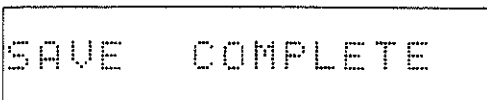

SAVE COMPLETE

\* If SAVE COMPLETE is not seen in the step ⑤, simply press the Write/Execute Button ⑧, and the MKS-80 will be returned to the condition just before the Save Button ⑥ was pressed (in the step ④), allowing you to repeat the saving procedure again.

(e. g.)

If the connected device is unable to receive message, the Display will be as shown right. If the receiver is another MKS-80, this indication is shown when the Protect Switch is set to ON.



REJECTED

b. Loading the data in the MIDI device (or computer) to the MKS-80

① Set the S/L Mode Switch ⑨ to the MIDI position.

② Set the MIDI Function Switch ⑤ to the III position.

③ Set the Protect Switch ⑩ of the MKS-80 to the OFF position.

④ Press the Load Button ⑦. The Display will respond with:

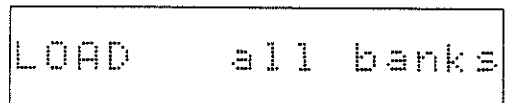

LOAD all banks

Here, if you wish to load the entire data in memory, go straightly to step ⑤.

If you wish to select a bank or banks to be loaded, without releasing the Load Button ⑦, assign the bank or banks by pressing the Bank Button ⑯.

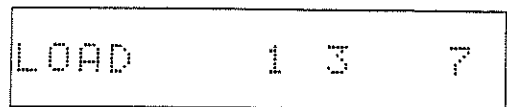

LOAD 1 3 7

\* The above is the example when banks 1, 3 and 7 are assigned.

⑤ While still holding the Load Button ⑦, press the Write/Execute Button ⑧. The Display will respond as shown right.

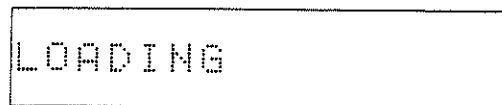

LOADING

And in about a second, loading will be completed with the Display as shown right.

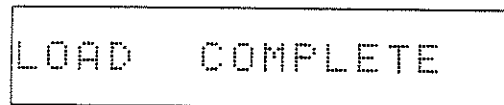

LOAD COMPLETE

Then, the MKS-80 is returned to the condition just before the Load Button ⑦ was pressed. (in the step ④).

⑥ Set the Protect Switch ⑩ of the MKS-80 to the ON position.

⑦ If not specifically required, set the MIDI Function Switch ⑤ to the I or II position.

\* If `LOAD COMPLETE` is not seen in the step ⑤, simply press the Write/Execute Button ⑧, and the MKS-80 will be returned to the condition just before the Load Button ⑦ was pressed (in the step ④), allowing you to repeat the loading procedure again.

(e. g.)

When the transmitter is not able to send message, the Display will react as shown right. If, however, the transmitter is another MKS-80, this will never be seen.

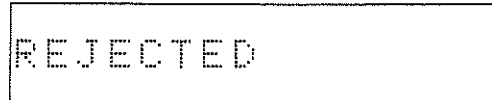

REJECTED

If the Protect Switch ⑩ of the MKS-80 (receiver) is set to the ON position, the Display will respond as shown right.

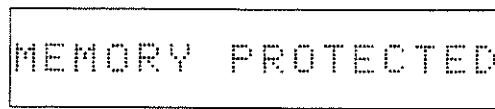

MEMORY PROTECTED

## B. INDICATORS

### a. Receive Mode Indicators

You can tell the current receive mode with these indicators.

\* Refer to the separate volume "MIDI" for the details.







### b. MIDI Message Indicator



This lights up when the MKS-80 recognizes MIDI message. While a key is held down, this indicator is lighted.



**MKS-80 Parameter Table**

Tone Section

Parameter			Value	
No	Display		Display	
2	LFO RATE	LFO-1 Rate	0-100	
3	LFO DLY	LFO-1 Delay Time	0-100	
4	LFO WF	LFO-1 Waveform		Triangle Wave
				Sawtooth Wave
				Square Wave
			RND	Random
5	VCO LFO	VCO Modulation LFO-1 Depth	0-100	
6	VCO ENV	VCO Modulation ENV-1 Depth	0-100	
7	PW	Pulse Width	0-100	
8	PWM	Pulse Width Modulation	0-100	
9	PWM SEL	PWM Mode Selector	ENV	ENV-1
			LFO	LFO-1
			KBD	Keyboard
10	PWM POL	PWM Polarity	NRM	Normal
			INV	Invert
11	VCO KYBD	VCO Key Follow	0-100	
12	VCO SEL	VCO Selector (Key Follow)	1	VCO-1
			OFF	OFF
			2	VCO-2
13	XMOD MAN	Cross Modulation Manual Depth	0-100	
14	XMOD ENV	X-MOD ENV-1 Depth	0-100	
15	XMOD POL	X-MOD Polarity	NRM	Normal
			INV	Invert
16	VCO1 MOD	VCO-1 Modulation	NRM	Normal
			OFF	OFF
			INV	Invert
17	VCO1 RNG	VCO-1 Range	32C-2C	32'C - 2'C
18	VCO1 WF	VCO-1 Waveform		Triangle
				Sawtooth Wave
				Pulse Wave
				Square Wave
19	VCO SYNC	VCO Synchro	1 → 2	VCO-1 → VCO-2
			OFF	OFF
			1 ← 2	VCO-1 ← VCO-2
20	VCO2 MOD	VCO-2 Modulation	NRM	Normal
			OFF	OFF
			INV	Invert

Parameter			Value	
No	Display		Display	
21	VCO2 RNG	VCO-2 Range	LOW	Low Frequency
			32C-2C	32°C - 2°C
			HI	High Frequency
22	VCO2 TUN	VCO-2 Fine Tune	0-100	
23	VCO2 WF	VCO-2 Waveform		Triangle Wave
				Sawtooth Wave
				Pulse Wave
			NIS	Noise
24	MIXER	Source Mix	0-100	
25	HPF FREQ	High Pass Filter Cutoff Frequency	0-100	
26	VCF FREQ	VCF Cutoff Frequency	0-100	
27	VCF RESO	VCF Resonance	0-100	
28	VCF ENV	VCF Envelope Selector	EG1	ENV-1
			EG2	ENV-2
29	VCF ENV	VCF Envelope Polarity	NRM	Normal
			INV	Invert
30	VCF ENV	VCF Modulation ENV Depth	0-100	
31	VCF LFO	VCF Modulation LFO-1 Depth	0-100	
32	VCF KYBD	VCF Key Follow	0-100	
33	VCA LEVL	VCA ENV-2 Level	0-100	
34	VCA LFO	VCA Modulation LFO-1 Depth	0-100	
35	DYN TIME	Dynamics Time	0-100	
36	DYN LEVL	Dynamics Level	0-100	
37	EG RESET	Envelope Reset	ON	
			OFF	
38	EG1 DYN	ENV-1 Dynamics	ON	
			OFF	
39	EG1 A	ENV-1 Attack Time	0-100	
40	EG1 D	ENV-1 Decay Time	0-100	
41	EG1 S	ENV-1 Sustain Level	0-100	
42	EG1 R	ENV-1 Release Time	0-100	
43	EG1 KYBD	ENV-1 Key Follow	0-100	
44	EG2 DYN	ENV-2 Dynamics	ON	
			OFF	
45	EG2 A	ENV-2 Attack Time	0-100	
46	EG2 D	ENV-2 Decay Time	0-100	
47	EG2 S	ENV-2 Sustain Level	0-100	
48	EG2 R	ENV-2 Release Time	0-100	
49	EG2 KYBD	ENV-2 Key Follow	0-100	

## Patch Section

Parameter			Value	
No	Display		Display	
51	MODE	Key Mode	WHOL	Whole
			SPL2	Split 2
			SPL1	Split 1
			DUAL	Dual
52	S. POINT	Split Point	A0-C8	
53	BALANCE	Balance	0-100	
	TONE	Tone Number	11-88	
54	OCTAVE	Octave Shift	-2	2 OCT Down
			-1	1 OCT Down
			NORM	Normal
			+1	1 OCT Up
			+2	2 OCT Up
55	ASSIGN	Assign Mode	SOLO	
			UNI 1	Unison 1
			UNI 2	Unison 2
			PLY 1	Poly 1
			PLY 2	Poly 2
56	DETUNE	Unison Detune	0-100	
57	HOLD	Hold	MIDI	
			ON	
			OFF	
58	GLIDE	Glide	0-100	
59	BENDER	Bender Sensitivity	0-100	
60	VCO-1	VCO-1 Bend	WIDE	
			NORM	Normal
			OFF	
61	VCO-2	VCO-2 Bend	WIDE	
			NORM	Normal
			OFF	
62	TOUCH	After Touch Sensitivity	0-100	
63	SELECT	After Touch Mode Selector	VCO	VCO LFO-2 MOD
			VCF	VCF FREQ
64	RATE	LFO-2 Rate	0-100	

**Display Message Table**

DISPLAY	ACTION TAKEN	OPERATION
AUTO TUNE	Tune Button pressed	While auto tuning
EDIT TONE No ##	Tone Button pressed	While editing Tone Number ##
EDIT PATCH No ##	Patch Button pressed	While editing Patch Number ##
INSERT CARTRIDGE	Cartridge mode selected without Cartridge connected	Requesting to connect Memory Cartridge
LOAD all banks	Load Button pressed	Followed by pressing Write/Execute Button, all banks will be loaded
LOAD COMPLETE		Loading is completed
LOAD # # #	Load and Bank Buttons pressed	Followed by pressing Write/Execute Button, selected banks ### will be loaded
MEMORY PROTECTED	Writing mode selected with Protect Switch ON	Requesting to set the Protect Switch to OFF
REJECTED	External MIDI device is unable to receive or send signal	
SAVE all banks	Save Button pressed	Followed by pressing Write/Execute Button, all banks will be saved
SAVE COMPLETE		Saving is completed
SAVE # # #	Save and Bank Buttons pressed	Followed by pressing Write/Execute Button, selected banks ### are saved
WRITE TONE * *	Write/Execute and Tone Buttons are pressed	While writing Tone Number * *
WRITE PATCH * *	Write/Execute and Patch Button pressed	While writing Patch Number * *
WRITTEN TONE ##		Tone Memory is properly written
WRITTEN PATCH ##		Patch Memory is properly written

Program Change Table

Memory Area Switch: INT

		Number							
Area	Bank	1	2	3	4	5	6	7	8
INT	1	0	1	2	3	4	5	6	7
	2	8	9	10	11	12	13	14	15
	3	16	17	18	19	20	21	22	23
	4	24	25	26	27	28	29	30	31
	5	32	33	34	35	36	37	38	39
	6	40	41	42	43	44	45	46	47
	7	48	49	50	51	52	53	54	55
	8	58	57	58	59	60	61	62	63
A	1	64	65	64	67	68	69	70	71
	2	72	73	74	75	76	77	78	79
	3	80	81	82	83	84	85	86	87
	4	88	89	90	91	92	93	94	95
	5	96	97	98	99	100	101	102	103
	6	104	105	106	107	108	109	110	111
	7	112	113	114	115	116	117	118	119
	8	120	121	122	123	124	125	126	127

Memory Area Switch: A

		Number							
Area	Bank	1	2	3	4	5	6	7	8
A	1	0	1	2	3	4	5	6	7
	2	8	9	10	11	12	13	14	15
	3	16	17	18	19	20	21	22	23
	4	24	25	26	27	28	29	30	31
	5	32	33	34	35	36	37	38	39
	6	40	41	42	43	44	45	46	47
	7	48	49	50	51	52	53	54	55
	8	58	57	58	59	60	61	62	63
B	1	64	65	64	67	68	69	70	71
	2	72	73	74	75	76	77	78	79
	3	80	81	82	83	84	85	86	87
	4	88	89	90	91	92	93	94	95
	5	96	97	98	99	100	101	102	103
	6	104	105	106	107	108	109	110	111
	7	112	113	114	115	116	117	118	119
	8	120	121	122	123	124	125	126	127

Memory Area Switch: B

		Number							
Area	Bank	1	2	3	4	5	6	7	8
B	1	0	1	2	3	4	5	6	7
	2	8	9	10	11	12	13	14	15
	3	16	17	18	19	20	21	22	23
	4	24	25	26	27	28	29	30	31
	5	32	33	34	35	36	37	38	39
	6	40	41	42	43	44	45	46	47
	7	48	49	50	51	52	53	54	55
	8	58	57	58	59	60	61	62	63
INT	1	64	65	64	67	68	69	70	71
	2	72	73	74	75	76	77	78	79
	3	80	81	82	83	84	85	86	87
	4	88	89	90	91	92	93	94	95
	5	96	97	98	99	100	101	102	103
	6	104	105	106	107	108	109	110	111
	7	112	113	114	115	116	117	118	119
	8	120	121	122	123	124	125	126	127

**MIDI Function Table**

		I	II	III
	Key ON/OFF & Dynamics	○	○	○
*1	Damper	○	○	○
	Active Sens	○	○	○
	Mode Message	○	○	○
	Bender	x	○	○
*2	Bender Sensitivity	x	○	○
	Volume	x	○	○
	Modulation	x	○	○
	After Touch	x	○	○
*3	Tune Request	x	○	○
	Program Change	x	○	○ <small>(RECEIVE ONLY)</small>
	System Exclusive	x	x	○

**\* MIDI Function Switch set to II** .....

Tone Memory changes by the Program Change message sent from the external device. If you change the Tone Memory by using the buttons on the MKS-80, corresponding Program Change message will be sent from the MKS-80 to the receiver.

**MIDI Function Switch set to III** .....

Patch Preset changes by the Program Change message sent from the external device. But even if you change the Patch Preset by using the buttons on the MKS-80's panel, no Program Change message will be transmitted to the receiver.

\*1 The Hold function by a Damper pedal can be obtained only when the Hold parameter is ON in a Patch Preset.

\*2 If this message is received from MIDI IN, the value written in the Patch Preset is replaced with this. This message remains until a new Patch Preset is selected.

\*3 The MKS-80 sends out all the messages received from the MIDI IN, plus these messages, through the MIDI OUT.

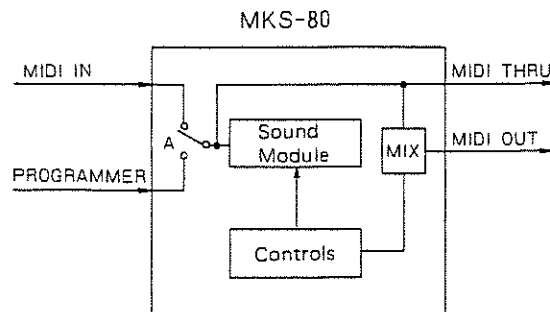

A: Input Selector Switch

## 6 SPECIFICATIONS

### MKS-80

8 voice, 16 VCO, Polyphonic Synthesizer Module

- Internal Memory
  - 64 Patch Presets
  - 64 Tone Memories

- External Memory
  - 2 x 64 Patch Presets
  - 2 x 64 Tone Memories

#### • Front Panel

Tune	±50 cent
Auto Tune	
Volume	
Dynamics Sens	
MIDI Function	I, II, III
MIDI Channel	1 to 16
MIDI Message Indicator	
Receive Mode Indicator	OMNI, POLY, MONO
Bank	1 to 8
Number	1 to 8
Memory Area	INT, A, B
Memory Cartridge Holder	
Display	LCD 5 x 7 dots x 16 letters
Contrast	
Save	
Load	
Write/Execute	
S/L Mode	Cartridge, MIDI
Protect	ON, OFF
Tone	
Patch	
Upper	
Lower	
Parameter Fwd	
Parameter Bwd	
Value Up	
Value Down	

Headphones Jack  
Power Switch

#### • Rear Panel

Input Selector	MIDI, PROGRAMMER
MIDI	5 pin DIN Connector x 3 IN, OUT, THRU
PROGRAMMER	6 pin DIN Connector
Output Level	H, M, L
Output Mode	MIX, U/L
Balanced Output	XLR Connector x 2 UPPER, LOWER
Unbalanced Output	Standard Phone Jack x 2 UPPER, LOWER

#### • Parameters

Refer to the owners manual from P. 41 to 43.

■ Consumption 35W

■ Dimensions 430(W) x 400(D) x 88(H) mm  
16-7/8" x 15-3/4" x 3-1/2"

■ Weight 8 kg / 17 lb 10 oz

#### ■ Accessories

Connection Cord (LP-25) x 2  
5P DIN Cord  
AC Cord  
Memory Cartridge (M-64C)  
Owner's Manual

#### ■ OPTIONS

Programmer MPG-80

# MKS-80 MIDI Implementation

## 1. RECOGNIZED RECEIVE DATA

1.1 When the MIDI FUNCTION is at I,  
Note events, Hold ON/OFF, Mode Messages and Active Sensing are recognized.

Status	Second	Third	Description
1000 nnnn	0kxx kkkk	0vxx vvvv	Note OFF, velocity ignored
1001 nnnn	0kxx kkkk	0000 0000	Note OFF kkkkkk = 0 - 127 (21 - 108) *1
1001 nnnn	0kxx kkkk	0vxx vvvv	Note ON kkkkkk = 0 - 127 (21 - 108) *1 vvvvvv = 1 - 127
1011 nnnn	0100 0000	01xx xxxx	Hold ON xxxxxx = 0 - 63
1011 nnnn	0100 0000	00xx xxxx	Hold OFF xxxxxx = 0 - 63
1011 nnnn	0111 1011	0000 0000	ALL NOTES OFF
1011 nnnn	0111 1100	0000 0000	OMNI OFF *2
1011 nnnn	0111 1101	0000 0000	OMNI ON *2
1011 nnnn	0111 1110	0000 mmmm	MONO ON *2 mmmm = 1
1011 nnnn	0111 1111	0000 0000	POLY ON *2
1111 1110			Active Sensing

Notes :

\*1 Note numbers outside of the range 21 - 108 are transposed to the nearest octave inside this range.

\*2 Mode Messages (123 - 127) are also recognized as ALL NOTES OFF. MONO ON messages in which mmmm = 0 or 2 - 15 are ignored.

Mode Messages are recognized as follows:

: POLY ON (127) : MONO ON (126) : MONO ON (126)  
: mmmm = 1 : mmmm < 1

OMNI OFF (124) : OMNI = OFF : OMNI = OFF : ignored  
: POLY : MONO : (not changed)

OMNI ON (125) : OMNI = ON : OMNI = ON : ignored  
: POLY : MONO : (not changed)

1.2 When the MIDI FUNCTION is at II  
Modulation, Volume, Bender Sens, Program Change, Channel After Touch, Pitch Bender and Tune Request are recognized in addition to the messages described in 1.1.

Status	Second	Third	Description
1011 nnnn	0000 0001	0vxx vvvv	Modulation vvvvvv = 0 - 127
1011 nnnn	0000 0111	0vxx vvvv	Volume vvvvvv = 0 - 127
1011 nnnn	0001 1111	0vxx vvvv	Bender Sensitivity vvvvvv = 0 - 127
1100 nnnn	0ppp pppp		Program Change pppppp = 0 - 127 *
1101 nnnn	0vxx vvvv		Channel After Touch vvvvvv = 0 - 127
1110 nnnn	0vxx vvvv	0vxx vvvv	Pitch Bender Change
1111 0110			Tune Request

Note :

The Program Change number in the basic channel is recognized as an Upper 'Tone Number' and that in the basic channel + 1 as a Lower one.

1.3 When the MIDI FUNCTION is at III  
EXCLUSIVE messages and the messages described in 2.2 are recognized. The Program Change number only in the basic channel is recognized as a 'Patch Number'.

The Program Change assignments

Prog #	Number (see note)	MEMORY AREA switch		
		INT	A	B
0 - 63	: 11 - BB	Internal	cart A	cart B
64 - 127	: 11 - BB	cart A	cart B	Internal

Note :

MIDI function	Number
II	'Tone Number'
III	'Patch Number'

## 2. TRANSMITTED DATA

2.1 When the MIDI FUNCTION is at I  
Only messages received from MIDI IN are sent to MIDI OUT. No messages are internally originated.

2.2 When the MIDI FUNCTION is at II  
Program Change and Tune Request will be sent in addition to the messages described in 2.1.

Status	Second	Third	Description
1100 nnnn	0ppp pppp		Program Change pppppp = 0 - 63
1111 0110			Tune Request

Notes :

nnnn : MIDI channel number ( 0000 - 1111 ), ch-1 = 0000

When the 'Patch Number' is changed, Program Change messages are transmitted in the basic channel for the Upper 'Tone Number' defined by the 'Patch Number', and in the basic channel + 1 for the Lower 'Tone Number'

When the 'Tone Number' is changed, a Program Change message is transmitted in the basic channel for the Upper 'Tone Number', or in the basic channel + 1 for the Lower one, according to the panel setting.

2.3 When the MIDI FUNCTION is at III  
Tune Request and Exclusive Messages will be sent in addition to the messages described in 2.1. The Program Change is not internally originated.

## 3. TRANSMITTED EXCLUSIVE MESSAGES

3.1 When the Tone Parameters are changed while the MIDI FUNCTION is set at III, the following exclusive message (IPR) is sent.

Byte	Description
a 1111 0000	Exclusive status
b 0100 0001	Roland ID #
c 0011 0110	Operation code = IPR (individual parameter)
d 0000 nnnn	Unit # = MIDI basic channel, nnnn = 0 - 15 where nnnn + 1 = channel #
e 0010 0000	Format type
f 0010 0000	Level # = 1
g 0000 00gg	Group # gg = 01 : Upper Tone gg = 10 : Lower Tone
h 0ppp pppp	Parameter # ( 0 - 47 )
i 0vxx vvvv	Value ( 0 - 100 ) h and i ( respectively )
j 1111 0111	End of System Exclusive

Note :

Parameter #	Function	Value
0	LFO-1 RATE	0 - 100
1	LFO-1 DELAY TIME	0 - 100
2	LFO-1 WAVEFORM	0 = Random 1 = Square Wave 2 = Sawtooth Wave 3 = Triangle Wave
3	VCO MOD LFO-1 DEPTH	0 - 100
4	VCO MOD ENV-1 DEPTH	0 - 100
5	PW	0 - 100
6	PWM	0 - 100
7	PWM MODE SEL	0 = Keyboard 1 = LFO-1 2 = ENV-1 3 = inverted 4 = Normal
8	PWM POL	0 = inverted 1 = Normal
9	VCO KEY FOLLOW	0 - 100
10	VCO SEL	0 = VCO-2 1 = OFF 2 = VCO-1
11	XMOD MANUAL DEPTH	0 - 100
12	XMOD ENV-1 DEPTH	0 - 100
13	XMOD POL	0 = inverted 1 = Normal
14	VCO-1 MOD	0 = inverted 1 = OFF 2 = Normal
15	VCO-1 RANGE	36 - 84 (60 = middle C of B')

Parameter #	Function	Value
16	VCO-1 WAVEFORM	0 = Square Wave 1 = Pulse Wave 2 = Sawtooth Wave 3 = Triangle Wave
17	VCO SYNC	0 = VCO-1 <- VCO-2 1 = OFF 2 = VCO-1 -> VCO-2
18	VCO-2 MOD	0 = inverted 1 = OFF 2 = Normal
19	VCO-2 RANGE	0 = Low Frequency 36 - 84 (60 = middle C of B') 100 = High Frequency
20	VCO-2 FINE TUNE	0 - 100
21	VCO-2 WAVEFORM	0 = Noise 1 = Pulse Wave 2 = Sawtooth Wave 3 = Triangle Wave
22	MIXER	0 - 100
23	HPF CUTOFF FREQ	0 - 100
24	VCF CUTOFF FREQ	0 - 100
25	VCF RESONANCE	0 - 100
26	VCF ENV SEL	0 = ENV-2 1 = ENV-1
27	VCF ENV POL	0 = inverted 1 = Normal
28	VCF MOD ENV DEPTH	0 - 100
29	VCF MOD LFO-1 DEPTH	0 - 100
30	VCF KEY FOLLOW	0 - 100
31	VCA ENV-2 LEVEL	0 - 100
32	VCA MOD LFO-1 DEPTH	0 - 100
33	DYNAMICS TIME	0 - 100
34	DYNAMICS LEVEL	0 - 100
35	ENV RESET	0 = OFF 1 = ON
36	ENV-1 DYNAMICS	0 = OFF 1 = ON
37	ENV-1 ATTACK TIME	0 - 100
38	ENV-1 DECAY TIME	0 - 100
39	ENV-1 SUSTAIN LEVEL	0 - 100
40	ENV-1 RELEASE TIME	0 - 100
41	ENV-1 KEY FOLLOW	0 - 100
42	ENV-2 DYNAMICS	0 = OFF 1 = ON
43	ENV-2 ATTACK TIME	0 - 100
44	ENV-2 DECAY TIME	0 - 100
45	ENV-2 SUSTAIN LEVEL	0 - 100
46	ENV-2 RELEASE TIME	0 - 100
47	ENV-2 KEY FOLLOW	0 - 100

3.2 When the Patch Parameters are changed while the MIDI FUNCTION is set at III, the following exclusive message (IPR) is sent.

byte	Description
a 1111 0000	Exclusive status
b 0100 0001	Roland ID #
c 0011 0110	Operation code = IPR (individual parameter)
d 0000 nnnn	Unit # = MIDI basic channel, nnnn = 0 - 15 where nnnn + 1 = channel #
e 0010 0000	Format type
f 0011 0000	Level # = 2
g 0000 00gg	Group # gg = 01 : Upper Patch gg = 10 : Lower Patch



# MODEL MKS-80 MIDI Implementation Chart

Function.....	Transmitted			Recognized			Remarks
	I	II	III	I	II	III	
Basic Channel	Default	1 - 16		1 - 16			memorized
	Changed	1 - 16		1 - 16			
Mode	Default Messages Altered	Mode 3 × *****		Mode 3 MONO,POLY,OMNI ON/OFF m ≠ 1 ignored ×			
Note Number	True voice	× × × *****		0 - 127 21 - 108			The Note Number message that gives less than 5 ms from Note ON to Note OFF cannot be received.
Velocity	Note ON Note OFF	× × × × × ×		○ ○ ○ × × ×			v = 1 - 127
After Touch	Key's Ch's	× × × × × ×		× × × × ○ ○			
Pitch Bender		× × ×		× ○ ○			
Control Change	1 7 31 64	× × × × × × × × × × × ×		× ○ ○ × ○ ○ × ○ ○ * * *			Modulation Volume Bender Sense Hold * ○ or × by Patch preset
Prog Change	True #	× ○(0-63)× *****		× ○ ○(0-127) 0 - 127			
System Exclusive		× × ○		× × ○			
System Common	Song Pos Song Sel Tune	× × × × × × × ○ ○		× × × × × × × ○ ○			
System Real Time	Clock Commands	× × × × × ×		× × × × × ×			
Aux Messages	Local ON / OFF All Notes OFF Active Sense Reset	× × × × × × × × × × × ×		× × × ○ ○ ○ ○ ○ ○ × × ×			(123 - 127)
Notes		Received messages are usually transmitted. Program change: MIDI func Tx Rx II Tone # Tone # III Patch #					

Mode 1 : OMNI ON, POLY  
Mode 3 : OMNI OFF, POLY

Mode 2 : OMNI ON, MONO  
Mode 4 : OMNI OFF, MONO

○ : Yes  
× : No

```

h 0ppp pppp Parameter # (0 - 14)
i 0vvv vvvv Value (0 - 100)
:          h and i (repetitively)
j 1111 0111 End of System Exclusive

```

Note :

Parameter #	Function	Value
0	KEY MODE SELECT	0 = Dual 1 = Split-1 2 = Split-2 3 = Whole
1	SPLIT POINT	2) - 100 (Note number)
2	BALANCE	0 - 100
3	TOPE NUMBER	0 - 63
4	OCT SHIFT	0 = 2 OCT Down 1 = 1 OCT Down 2 = Normal 3 = 1 OCT Up 4 = 2 OCT Up
5	ASSIGN MODE SELECT	0 = Solo 1 = Unison-1 2 = Unison-2 3 = Poly-1 4 = Poly-2
6	UNISON DETUNE	0 - 100
7	HOLD	0 = OFF 1 = ON (always) (MIDI Damper messages are ignored) 2 = MIDI Damper messages are recognized
8	GLIDE	0 - 100
9	BENDER SENS	0 - 100
10	VCO-1 BEND	0 = OFF 1 = Normal (Slightly more than 1 octave) 2 = Wide (2.5 octaves)

Parameter #	Function	Value
11	VCO-2 BEND	0 = OFF 1 = Normal (Slightly more than 1 octave) 2 = Wide (2.5 octaves)
12	AFTER TOUCH SENS	0 - 100
13	AFTER TOUCH MODE SELECT	0 = VCF Frequency 1 = VCO LFO-2 MOD (1 and 2)
14	LFO-2 RATE	0 - 100

```

e 0010 0000 Format type
f 0010 0000 Level # = 1
g 0000 0010 Group # = Lower
h 0vvv vvvv values (0 - 100) of parameter # 0 - 47
:          in sequence, (48 bytes total)
i 0vvv vvvv
j 1111 0111 End of System Exclusive

```

3.4 When the 'Tone Number' is changed while the MIDI FUNCTION is set at 111, the following exclusive messages (A and B) are sent.

A. PCR (Program number) which indicates the 'Tone Number'

Byte	Description
a 1111 0000	Exclusive status
b 0100 0001	Roland ID #
c 0011 0100	Operation code = PCR (program number)
d 0000 nnnn	Unit # = MIDI basic channel, nnnn = 0 - 15 where nnnn + 1 = channel #
e 0010 0000	Format type
f 0010 0000	Level # = 1
g 0000 00xx	Group # xx = 01 Upper Tone xx = 10 Lower Tone
h 0000 0000	Next program number indicates the 'Tone Number'
i 0ppp pppp	Program # ('Tone Number')
j 0000 0000	NO
k 1111 0111	End of System Exclusive

B. APR (All parameter) which indicates the All parameters for the 'Tone Number'

Byte	Description
a 1111 0000	Exclusive status
b 0100 0001	Roland ID #
c 0011 0101	Operation code = APR (all parameter)
d 0000 nnnn	Unit # = MIDI basic channel, nnnn = 0 - 15 where nnnn + 1 = channel #
e 0010 0000	Format type
f 0010 0000	Level # = 1
g 0000 00xx	Group # xx = 01 Upper Tone xx = 10 Lower Tone
h 0vvv vvvv	values (0 - 100) of parameter # 0 - 47
i	in sequence, (48 bytes total)
j 0vvv vvvv	
k 1111 0111	End of System Exclusive

3.3 When the 'Patch Number' is changed while the MIDI FUNCTION is set at III, the following exclusive messages (A through E) are sent in sequence.

A. PCR (Program number) which indicates the 'Patch Number'

Byte	Description
a 1111 0000	Exclusive status
b 0100 0001	Roland ID #
c 0011 0100	Operation code = PCR (program number)
d 0000 nnnn	Unit # = MIDI basic channel, nnnn = 0 - 15 where nnnn + 1 = channel #
e 0010 0000	Format type
f 0011 0000	Level # = 2
g 0000 0000	Dummy
h 0000 0000	Next program number indicates the 'Patch Number'
i 0ppp pppp	Program # ('Patch Number')
j 0000 0000	NOP
k 1111 0111	End of System Exclusive

B. APR (All parameter) which indicates the Patch Parameters for Upper section

Byte	Description
a 1111 0000	Exclusive status
b 0100 0001	Roland ID #
c 0011 0101	Operation code = APR (all parameter)
d 0000 nnnn	Unit # = MIDI basic channel, nnnn = 0 - 15 where nnnn + 1 = channel #
e 0010 0000	Format type
f 0011 0000	Level # = 2
g 0000 0001	Group # = Upper
h 0vvv vvvv	values (0 - 100) of parameter # 0 - 14 in sequence, (15 bytes total)
i 1111 0111	End of System Exclusive

C. APR (All parameter) which indicates the Patch Parameters for Lower section

Byte	Description
a 1111 0000	Exclusive status
b 0100 0001	Roland ID #
c 0011 0101	Operation code = APR (all parameter)
d 0000 nnnn	Unit # = MIDI basic channel, nnnn = 0 - 15 where nnnn + 1 = channel #
e 0010 0000	Format type
f 0011 0000	Level # = 2
g 0000 0010	Group # = Lower
h 0vvv vvvv	values (0 - 100) of parameter # 0 - 14 in sequence, (15 bytes total)
i 1111 0111	End of System Exclusive

D. APR (All parameter) which indicates the Tone Parameters for Upper section

Byte	Description
a 1111 0000	Exclusive status
b 0100 0001	Roland ID #
c 0011 0101	Operation code = APR (all parameter)
d 0000 nnnn	Unit # = MIDI basic channel, nnnn = 0 - 15 where nnnn + 1 = channel #
e 0010 0000	Format type
f 0010 0000	Level # = 1
g 0000 0001	Group # = Upper
h 0vvv vvvv	values (0 - 100) of parameter # 0 - 47 in sequence, (48 bytes total)
i 1111 0111	End of System Exclusive

E. APR (All parameter) which indicates the Tone Parameters for Lower section

Byte	Description
a 1111 0000	Exclusive status
b 0100 0001	Roland ID #
c 0011 0101	Operation code = APR (all parameter)
d 0000 nnnn	Unit # = MIDI basic channel, nnnn = 0 - 15 where nnnn + 1 = channel #

4. RECOGNIZED EXCLUSIVE MESSAGES

All Exclusive messages described in section 3.

5. HANDSHAKING COMMUNICATION

5.1 Message type

5.1.1 Want to send a file (WSF)

Byte	Description
a 1111 0000	Exclusive status
b 0100 0001	Roland ID #
c 0100 0000	Operation code
d 0000 nnnn	Unit # MIDI basic channel, nnnn = 0 - 15 where nnnn = 0 for channel 1
e 0010 0000	Format type
f 0100 1101	M :
g 0100 1011	K :
h 0101 0011	S : - File name in ASCII
i 0010 1101	- :
j 0011 1000	B :
k 0011 0000	O :
l 0000 0000	Check sum
m 1111 0111	End of System Exclusive

5.1.2 Request a file (RQF)

Byte	Description
a 1111 0000	Exclusive status
b 0100 0001	Roland ID #
c 0100 0001	Operation code
d 0000 nnnn	Unit # MIDI basic channel, nnnn = 0 - 15 where nnnn = 0 for channel 1
e 0010 0000	Format type
f 0100 1101	M :
g 0100 1011	K :
h 0101 0011	S : - File name in ASCII
i 0010 1101	- :
j 0011 1000	B :
k 0011 0000	O :
l 0000 0000	Check sum
m 1111 0111	End of System Exclusive

5.1.3 Data (DAT)

Byte	Description
a 1111 0000	Exclusive status
b 0100 0001	Roland ID #
c 0100 0010	Operation code
d 0000 nnnn	Unit # MIDI basic channel, nnnn = 0 - 15 where nnnn = 0 for channel 1
e 0010 0000	Format type
f 0ddd dddd	Data 248 bytes = 4 sets of data
g 0ddd dddd	Check sum
h 1111 0111	End of System Exclusive

Notes :  
Summed value of the all bytes in data and the check sum must be 0 (7 bits).

Each DAT message consists of 4 sets of the Patch and Tone data. Each data set consists of 62 bytes total --- 39 bytes for Tone Parameters of a number and 23 bytes for Patch Parameters of the same number.

These parameters are sent in sequence of the 'Tone Number's and 'Patch Number's. 2 DATs are sent for each 'Bank'. In normal operation, 16 DATs are totally sent for all 'bank's (1 - 8).

5.1.4 Acknowledge (ACK)

Byte	Description
a 1111 0000	Exclusive status
b 0100 0001	Roland ID #
c 0100 0011	Operation code
d 0000 nnnn	Unit # MIDI basic channel, nnnn = 0 - 15 where nnnn = 0 for channel 1
e 0010 0000	Format type
f 1111 0111	End of System Exclusive

5.1.5 End of file (EOF)

Byte	Description
a 1111 0000	Exclusive status
b 0100 0001	Roland ID #
c 0100 0101	Operation code
d 0000 nnnn	Unit # MIDI basic channel, nnnn = 0 - 15 where nnnn = 0 for channel 1
e 0010 0000	Format type
f 1111 0111	End of System Exclusive

5.1.6 Communication error (ERR)

Byte	Description
a 1111 0000	Exclusive status
b 0100 0001	Roland ID #
c 0100 1111	Operation code
d 0000 nnnn	Unit # MIDI basic channel, nnnn = 0 - 15 where nnnn = 0 for channel 1
e 0010 0000	Format type
f 1111 0111	End of System Exclusive

5.1.7 Rejection (RJC)

byte	description
a 1111 0000	Exclusive status
b 0100 0001	Roland ID #
c 0100 1111	Operation code
d 0000 nnnn	Unit # MIDI basic channel, nnnn = 0 - 15 where nnnn = 0 for channel 1
e 0010 0000	Format type
f 1111 0111	End of System Exclusive

5.2 Data format of DAT (62 bytes total)

Note :

Parameter	Type of Exclusive message	
	Value in DAT	Value in IPR
* SPLIT POINT	0 - 87	2) - 108
b Upper Tone Number ( 1 byte )	43 0 - 63	
c Upper bit data ( 4 bytes )	bits 4-7 are not used	
44	: bit 0-2 ASSIGN MODE SELECT	
	: 000 = Solo	
	: 001 = Unison-1	
	: 010 = Unison-2	
	: 011 = Poly-1	
	: 100 = Poly-2	
45	: bit 0,1 HOLD	
	: 00 = OFF	
	: 01 = ON ( always )	
	: 10 = by damper messages	
46	: bit 2,3 VCO-2 BEND : bit 0,1 VCO-1 BEND	
	: 00 = OFF : 00 = OFF	
	: 01 = Normal : 01 = Normal	
	: 10 = Wide : 10 = Wide	
47	: bit 1-3 OCT SHIFT : bit 0 AFTER TOUCH MODE SELECT	
	: 000 = 2 OCT Down : 0 = VCF Frequency	
	: 001 = 1 OCT Down : 1 = VCO LFO-2 MOD	
	: 010 = Normal	
	: 011 = 1 OCT Up	
	: 100 = 2 OCT Up	
d Upper continuous values ( 5 bytes, value = 0 - 100 )	48 UNISON DETUNE 51 AFTER TOUCH SENS	
	49 GLIDE 52 LFO-2 RATE	
	50 BENDER SENS	
e Lower Tone Number ( 1 byte )	53 0 - 63	
f Lower bit data ( 4 bytes )	54 - 57 The same as Upper SW data.	

5.2.1 Tone section ( 39 bytes )

a Continuous values ( 33 bytes, value = 0 - 100 )

- 1 LFO-1 RATE
- 2 LFO-1 DELAY TIME
- 3 VCO MOD LFO-1 DEPTH
- 4 VCO MOD ENV-1 DEPTH
- 5 PW
- 6 PWM
- 7 VCO KEY FOLLOW
- 8 XMOD MANUAL DEPTH
- 9 XMOD ENV-1 DEPTH
- \*1 10 VCO-1 RANGE
- \*2 11 VCO-2 RANGE
- 12 VCO-2 FINE TUNE
- 13 MIXER
- 14 HPF CUTOFF FREQ
- 15 VCF CUTOFF FREQ
- 16 VCF RESONANCE
- 17 VCF MOD ENV DEPTH
- 18 VCF MOD LFO-1 DEPTH
- 19 VCF KEY FOLLOW
- 20 VCA ENV-2 LEVEL
- 21 VCA MOD LFO-1 DEPTH
- 22 DYNAMICS TIME
- 23 DYNAMICS LEVEL
- 24 ENV-1 A
- 25 ENV-1 D
- 26 ENV-1 S
- 27 ENV-1 R
- 28 ENV-1 KEY FOLLOW
- 29 ENV-2 A
- 30 ENV-2 D
- 31 ENV-2 S
- 32 ENV-2 R
- 33 ENV-2 KEY FOLLOW

Note :

Parameter	Type of Exclusive message	
	Value in DAT	Value in IPR
*1 10 VCO-1 RANGE	0 - 48	36 - 84
*2 11 VCO-2 RANGE	0	0
	1 - 49	36 - 84
	50	100

b Bit data ( 6 bytes ) bits 4-7 are not used

34	bit 2,3 PWM MODE SEL		bit 0,1 LFO-1 WAVEFORM	
	00 = Keyboard	00 = Random	01 = Square Wave	
	01 = LFO-1	10 = Sawtooth Wave	11 = Triangle Wave	
	10 = ENV-1			
35	bit 2,3 VCO SEL		bit 1 XMOD POL : bit 0 PWM POL	
	00 = VCO-2	0 = Inverted	0 = Inverted	
	01 = OFF	1 = Normal	1 = Normal	
	10 = VCO-1			
36	bit 2,3 VCO-2 MOD		bit 0,1 VCO-1 MOD	
	00 = Inverted	00 = Inverted	01 = OFF	
	01 = OFF	10 = Normal	11 = Normal	
	10 = Normal			
37	bit 3	bit 2	bit 1	bit 0
	ENV-2 DYNAMICS	ENV-1 DYNAMICS	VCF ENV POL	VCF ENV SEL
	0 = OFF	0 = OFF	0 = Inverted	0 = ENV-2
	1 = ON	1 = ON	1 = Normal	1 = ENV-1
38	bit 2,3 VCO-2 WAVEFORM		bit 0,1 VCO-1 WAVEFORM	
	00 = Noise	00 = Square Wave	01 = Pulse Wave	
	01 = Pulse Wave	10 = Sawtooth Wave	11 = Triangle Wave	
	10 = Sawtooth Wave			
	11 = Triangle Wave			
39	bit 2 ENV RESET		bit 0,1 VCO SYNC	
	0 = OFF	00 = VCO-1 ← VCO-2	01 = OFF	
	1 = ON	10 = VCO-1 → VCO-2		

5.2.2 Patch section ( 23 bytes )

a Common data ( 3 bytes )

- 40 KEY MODE
  - 0 = DUAL
  - 1 = SPLIT-1
  - 2 = SPLIT-2
  - 3 = WHOLE
- \* 41 SPLIT POINT 0 - 87
- 42 BALANCE 0 - 100

g Lower continuous values ( 5 bytes, value = 0 - 100 )

- 58 JOHNSON DETUNE
- 59 GLIDE
- 60 BENDER SENS
- 61 AFTER TOUCH SENS
- 62 LFO-2 RATE

5.3 Sequence of communication

5.3.1 In the Save mode.

```

a WSF : Want to send a file (transmitted)
b ACK : Acknowledge (received)
c DAT : Data (transmitted)
d ACK : Acknowledge (received)
e ACK : Acknowledge (received)

```

5.3.2 In the Load mode.

```

a RQF : Request a file (received)
b DAT : Data (transmitted)
c ACK : Acknowledge (received)
d ACK : Acknowledge (received)
e ACK : Acknowledge (received)

```

5.3.3 When the WSF is recognized

```

a WSF : Want to send a file (received)
b ACK : Acknowledge (transmitted)
c DAT : Data (received)
d ACK : Acknowledge (transmitted)
e ACK : Acknowledge (received)

```

5.3.4 When the RQF is recognized

```

a RQF : Request a file (received)
b DAT : Data (transmitted)
c ACK : Acknowledge (received)
d ACK : Acknowledge (received)
e ACK : Acknowledge (received)

```

5.3.5 When the ERR is recognized

```

a ERR : Communication error (received)
b RJC : Rejection (transmitted)

```





 Roland®

---

**10803**

UPC

10803



10803

 Roland