

# Roland

**MIDI** SOUND MODULE

**PLANET-P**

# MKS-10

Owner's Manual

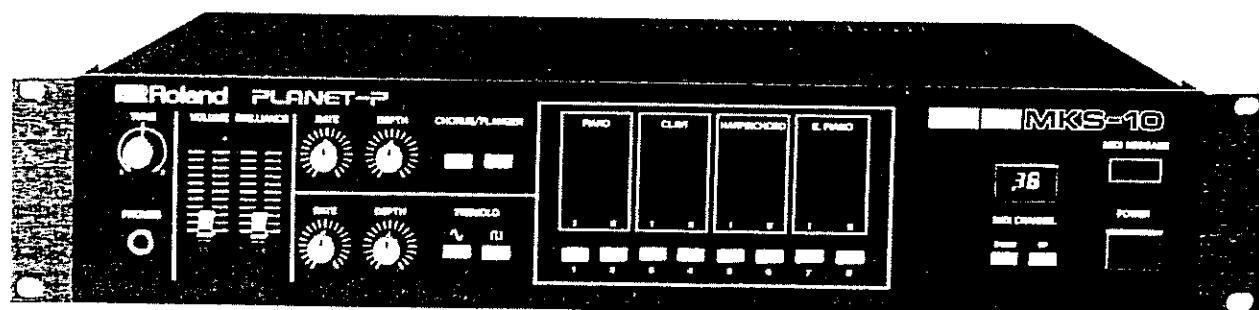

## Radio and television interference

**"Warning – This equipment has been verified to comply with the limits for a Class B computing device, pursuant to Subpart J, of Part 15, of FCC rules. Operation with non-certified or non-verified equipment is likely to result in interference to radio and TV reception."**

The equipment described in this manual generates and uses radio-frequency energy. If it is not installed and used properly, that is, in strict accordance with our instructions, it may cause interference with radio and television reception.

This equipment has been tested and found to comply with the limits for a Class B computing device in accordance with the specifications in Subpart J, of Part 15, of FCC Rules. These rules are designed to provide reasonable protection against such an interference in a residential installation.

However, there is no guarantee that the interference will not occur in a particular installation. If this equipment does cause interference to radio or television reception, which can be determined by turning the equipment on and off, the user is encouraged to try to correct the interference by the following measure:

- Disconnect other devices and their input/output cables one at a time. If the interference stops, it is caused by either the other device or its I/O cable.

These devices usually require Roland designated shielded I/O cables. For Roland devices, you can obtain the proper shielded cable from your dealer. For non Roland devices, contact the manufacturer or dealer for assistance.

If your equipment does cause interference to radio or television reception, you can try to correct the interference by using one or more of the following measures:

- Turn the TV or radio antenna until the interference stops.
- Move the equipment to one side or the other of the TV or radio.
- Move the equipment farther away from the TV or radio.
- Plug the equipment into an outlet that is on a different circuit than the TV or radio. (That is, make certain the equipment and the radio or television set are on circuits controlled by different circuit breakers or fuses.)
- Consider installing a rooftop television antenna with coaxial cable lead-in between the antenna and TV.

If necessary, you should consult your dealer or an experienced radio/television technician for additional suggestions. You may find helpful the following booklet prepared by the Federal Communications Commission:

"How to Identify and Resolve Radio-TV Interference Problems"

This booklet is available from the U.S. Government Printing Office, Washington, D.C., 20402, Stock No. 004-000-00345-4.

The **MKS-10** is a **Piano Sound Module** which is played by the music data transmitted from the external device.

It is specifically designed to be used with a **MIDI** equipped keyboard, sequencer or a home computer.

## FEATURES

- This is a 16 voice polyphonic sound module provided with 8 basic preset tone colors and effects such as tremolo and chorus, allowing wide variety of synthesizing.
- This produces a waveform independently for each tone color and pitch, therefore the created tone color is extremely realistic.
- Natural dynamics effect and smooth change of harmonic contents are obtained by MIDI velocity message sent from an external device.
- MIDI program change message, received from an external device, controls tone color selection and effect on/off.
- Any of 16 channel numbers CH-1 to CH-16 can be selected for a MIDI receiving channel.
- The MKS-10 is 19 inch, EIA standard mounting type, thereby can be compactly and comfortably set up with other MKS series and sound module, effect device, amplifier, etc.

## CONTENTS

<b>1</b> Panel Description .....	3
<b>2</b> Connection .....	5
<b>3</b> Operation .....	6
A. Setting MIDI Channel .....	6
B. Selecting a Tone Color .....	6
C. Effects .....	7
a. Chorus/Flanger .....	7
b. Tremolo $\wedge/\Pi$ .....	7
D. Rate, Depth Knobs .....	7
E. Other Controls .....	7
a. Brilliance Knob .....	7
b. Volume knob .....	7
c. Tune Knob .....	7
<b>4</b> External Control to the MKS-10 .....	8
A. Program Change Message .....	8
B. Control Change Message .....	8
<b>5</b> Specifications .....	9

**PANEL DESCRIPTION**

**8. Brilliance Knob**  
As you raise the knob, the tone color becomes brighter.

**9. Volume Knob**

**10. Tune Knob**  
This can change the pitch of the MKS-10 up to  $\pm 50$  cent.

**7. Rate Knob**  
This knob controls the rate of the flanger or chorus effect.

**6. Depth Knob**  
This is used to adjust the depth of the flanger or chorus effect.

**5. Chorus Button**  
Press this button to turn the chorus effect on.

**4. Flanger Button**  
Press this button to turn the flanger effect on.

**11. Headphones Jack**  
The headphones volume can be changed with the Volume Knob.

**12. Rate Knob**  
This controls the rate of the tremolo effect.

**13. Depth Knob**  
This knob controls the depth of the tremolo effect.

**14-15. Tremolo Selector Buttons**  
Press the  $\wedge$  Button for a soft tremolo and the  $\cap$  Button for a hard one.

**16. Tone Selector Buttons**

**18. MIDI THRU Connector**  
Through this connector, the MIDI message received from the MIDI IN is transmitted unchanged.

**13. MIDI IN Connector**  
MIDI message is received from this connector.

**20. OUTPUT Jack**

**21. Level Selector Switch**  
This selects the output level.

**3. MIDI Channel Display**  
This shows the MIDI Channel number currently selected.

**2. MIDI Message Indicator**  
This indicator flashes while the MKS-10 is receiving MIDI message.

**17. MIDI Channel Buttons**  
These buttons are used to set the MIDI channel number on which the MKS-10 receives the message.

**1. Power Switch**

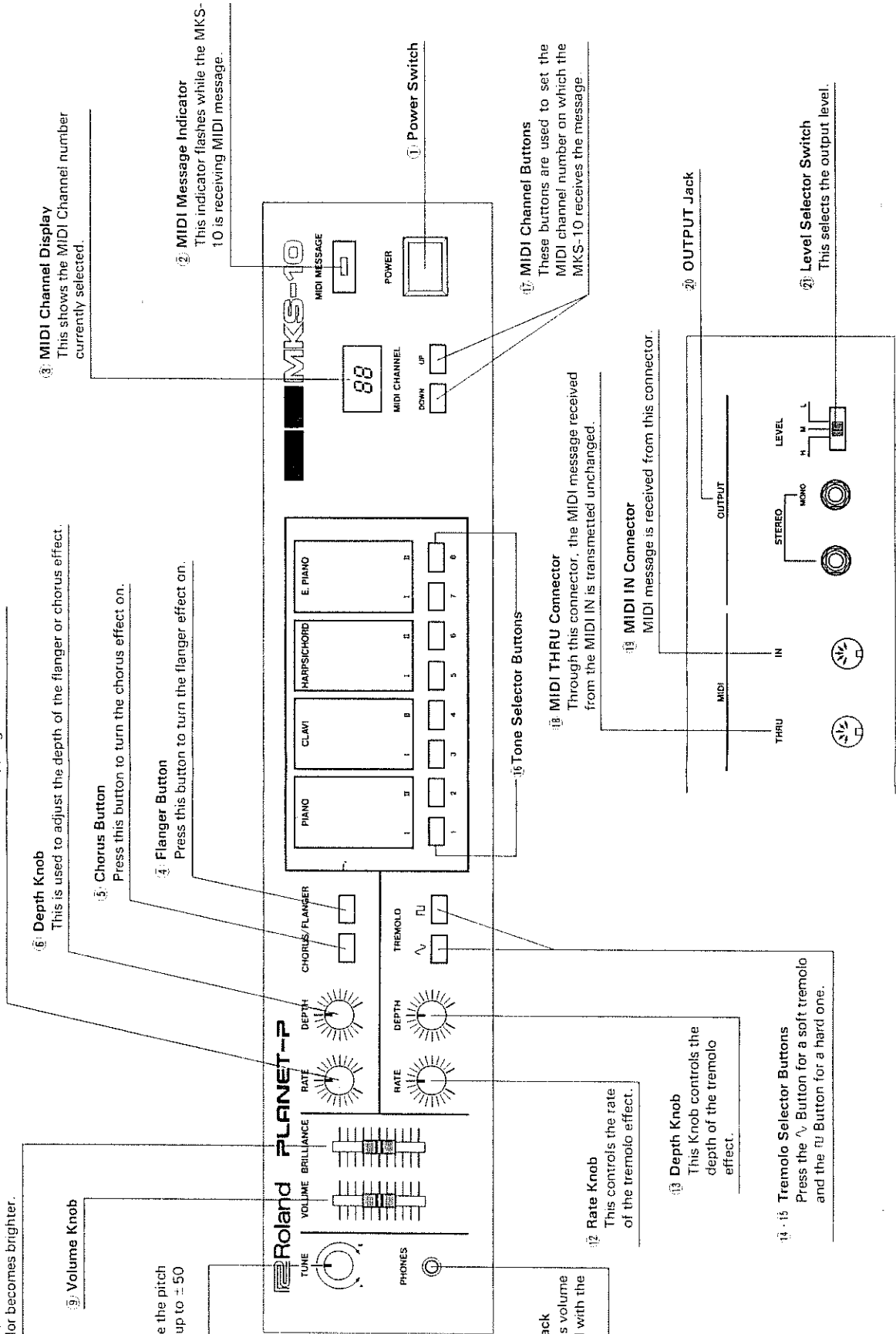



## 2 CONNECTION

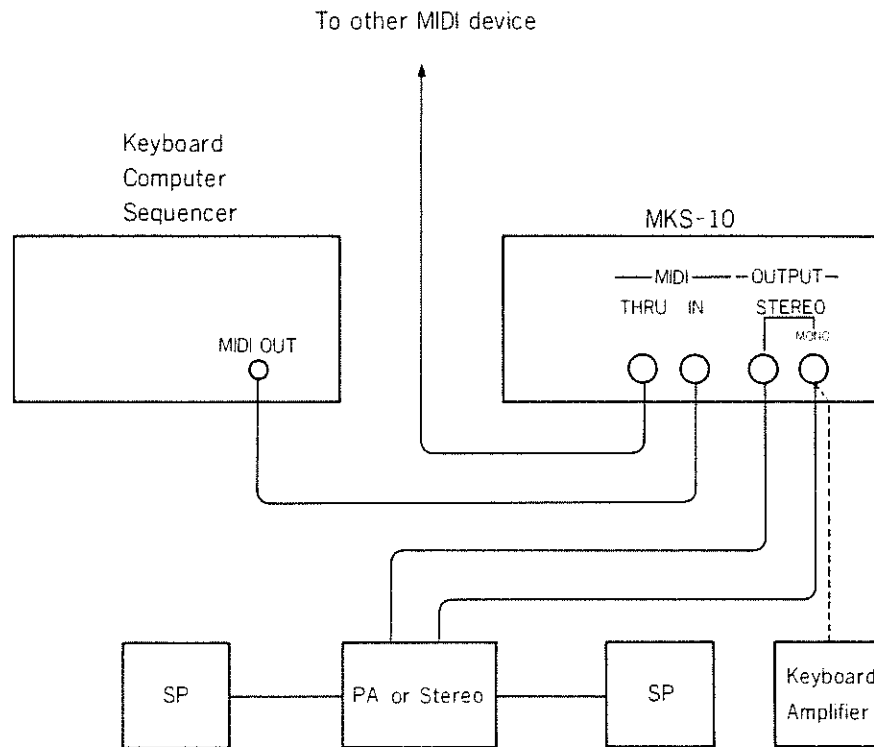

### IMPORTANT NOTES

#### POWER SUPPLY

- Be sure to use the AC Adaptor PSA-120, 220 or 240, depending on the voltage system in your country.
- Do not use the same socket that is used for any noise generating device, such as a motor, or variable lighting system.
- When setting up the MKS-10, be sure that all the units are turned off.
- This unit might not work properly if turned on immediately after turned off, or if the power cable is plugged in with the unit turned on. If this happens, simply turn the unit off, and turn it on again in a few seconds.
- This unit might get hot while operating, but there is nothing to worry about.

#### LOCATION

- Operating the MKS-10 near a neon or fluorescent lamp may cause noise interference. If so, change the angle or position of the MKS-10.
- Avoid using the MKS-10 in extreme heat or humidity or where it may be affected by dust.

#### CLEANING

- Use a soft cloth and clean only with a mild detergent.
- Do not use solvents such as paint thinner.

## **3 OPERATION**

Set up the MKS-10 with a MIDI device transmitting music information, then turn the units on, and you are ready to begin using the MKS-10.

Set up with all the units turned off, as shown on P.5, check if all the connections are correctly made, then turn the units on.

Here, the Piano 1 is automatically selected (the button is lighted), and the MIDI Channel Display ③ shows the channel number on which MIDI message can be received.

If the external MIDI device transmits the message on the same channel selected in the MKS-10, the MIDI Message Indicator ② flashes showing the MKS-10 is receiving the message.

If the channel number of the transmitted message differs from the MKS-10's set MIDI channel, the MKS-10 cannot receive the message. So, the MIDI Message Indicator remains dark and no sound is output.

However, when the MKS-10 is set to the OMNI mode, message sent on any channel number can be received, therefore, the indicator always flashes while the external device is transmitting message.

### **A. SETTING MIDI CHANNEL NUMBER**

The MKS-10's MIDI Channel number (receive channel) can be easily changed by using the UP and DOWN Buttons which are located below the MIDI Channel Display. Press the UP Button to increase the number and the DOWN Button to decrease.

If you do not know the MIDI Channel number (transmit channel) of the external device, try shifting the MIDI Channel of the MKS-10 until the MIDI Message Indicator flashes. That is the number you want.

\* The channel number you have set is not erased from memory even after the MKS-10 is turned off. Therefore, when powered on the next time, the Display shows the channel number previously set.

\* The MKS-10's memory retains the set channel number about 30 to 50 hours even if switched off. If more time has been elapsed before you switch on the MKS-10 second time, the Display will show an irrelevant number, but this is nothing to worry about.

### **B. SELECTING A TONE COLOR**

Right after power on, the Piano 1 is automatically selected, but you can select any tone color by pressing the corresponding Tone Color Selector Button.

### C. EFFECT

#### a. Chorus/Flanger

To turn the Chorus effect on, simply press the Chorus Button . Press it once again, and the Chorus will be off.

Use the Flanger Button  in the same way. It is not possible to obtain both Chorus and Flanger effects at the same time.

If you press the Flanger Button while the Chorus Button is turned on, the Chorus Button goes out and the Flanger Button lights up, the Flanger effect being turned on.

To turn the Chorus effect at this stage, just press the Chorus Button again. The Flanger Button goes out and the Chorus Button lights, the Flanger effect turned off.

In other words, the later pressed button has priority and comes on.

### D. RATE, DEPTH KNOBS

Chorus/Flanger

Tremolo  / 

These knobs control the rate and depth of each effect currently in use.

### E. OTHER CONTROLS



#### a. Brilliance Knob

As you raise this knob, the tone color becomes brighter. Normally, set it to the center position and change the position depending on the type of speaker or amplifier or the music you play.

#### b. Volume Knob

With this knob set between 3 and 7, adjust the volume knob on the amplifier and the Level Selector Switch to obtain desirable volume.

#### b. Tremolo /

These buttons, the  and the , behave just like the Chorus and the Flanger Buttons.

#### c. Tune Knob

Use this knob to tune the MKS-10 with other musical instrument. In its center position, the MKS-10 is tuned A=442Hz and changes up to  $\pm 50$  cent.

## 4 EXTERNAL CONTROL TO THE MKS-10

When program change message transmitted from an external device is received by the MKS-10, a combination program of a tone color and effect(s) is accordingly

called. Also, this Program Change Message enables you to use 8 "hidden tone colors" which cannot be called by pressing the MKS-10's Tone Selector Buttons.

Note)

If you do not want the MKS-10 to receive the program Change message, hold down any Tone Color Selector Button except for 1, and switch the MKS-10 on without releasing the button.

### A. PROGRAM CHANGE MESSAGE

The "hidden tone colors" are preset patches which can be in use just by MIDI program change message transmitted from the external device, and they have the same tone colors as the 8 preset patches 1 to 8 on the MKS-10's front panel, but have different release times. For instance, PIANO I and II of the panel presets have rather long release times, and Clavi I and II short. The "hidden preset patches" are piano sounds with short release times and clavi sound with long release times, therefore sound completely different.

#### a. Program Change Number 1 to 7

The program change numbers 1 to 7 correspond to the panel preset patches 1 to 7.

#### b. Program Change Number 8 to 15

The program change numbers 8 to 15 correspond to the 8 "hidden preset patches."

\* You can consider that there are 16 different preset tone colors. Program change numbers 16 to 127 can be used to add various effects to those 16 preset tone colors. Refer to the table below.

**MKS-10's Program Change Numbers and Corresponding Tone Colors and Effects.**

Tone Color → Effect ↓	PIANO		CLAVI		HARPS CHORD		E.PIANO		PIANO		CLAVI		HARPS CHORD		E.PIANO	
	I	II	I	II	I	II	I	II	I	II	I	II	I	II	I	II
NORMAL (No effect)	0	1	2	3	4	5	6	7	8	9	10	11	12	13	14	15
CHORUS	16	17	18	19	20	21	22	23	24	25	26	27	28	29	30	31
FLANGER	32	33	34	35	36	37	38	39	40	41	42	43	44	45	46	47
TREMORO $\wedge$	48	49	50	51	52	53	54	55	56	57	58	59	60	61	62	63
TREMORO $\sqcap$	64	65	66	67	68	69	70	71	72	73	74	75	76	77	78	79
CHORUS & TREMORO $\wedge$	80	81	82	83	84	85	86	87	88	89	90	91	92	93	94	95
CHORUS & TREMORO $\sqcap$	96	97	98	99	100	101	102	103	104	105	106	107	108	109	110	111
FLANGER & TREMORO $\wedge$	112	113	114	115	116	117	118	119	120	121	122	123	124	125	126	127
RELEASE TIME	Long	<input type="radio"/>	<input type="radio"/>			<input type="radio"/>	<input type="radio"/>	<input type="radio"/>	<input type="radio"/>			<input type="radio"/>	<input type="radio"/>			
	Short			<input type="radio"/>	<input type="radio"/>					<input type="radio"/>	<input type="radio"/>			<input type="radio"/>	<input type="radio"/>	<input type="radio"/>

e.g.) Piano I with Flanger effect is called when the MKS-10 receives the Program Change **40**.

### B. CONTROL CHANGE MESSAGE

The control change message received by the MKS-10 selects whether to use or not a damper pedal and a soft pedal.



## 5 SPECIFICATIONS

### MKS-10: 16 VOICE PIANO MODULE

#### ■ Front Panel

##### ● Tone Selector Buttons

Piano I (1), Piano II (2), Clavi I (3), Clavi II (4),  
Harpsichord I (5), Harpsichord II (6), Electric Piano I (7),  
Electric Piano II (8)

##### ● Effects

Chorus, Flanger, Tremolo  $\sqrt{\text{fl}}$

##### ● MIDI Channel Selector Buttons

UP, DOWN

##### ● Power Switch

##### ● Controls

Tune ( $\pm$  50cent)  
Volume  
Brilliance  
Rate, Depth (Chorus, Flanger)  
Rate, Depth (Tremolo)

##### ● Display & Indicator

MIDI Channel Display  
MIDI Message Indicator

#### ■ Rear Panel

MIDI IN Connector  
MIDI THRU Connector  
Output (Mono, Stereo) Jacks  
Level Selector Switch (H/M/L)

##### ● Consumptions

30W

##### ● Dimensions

480(W) × 400(D) × 90(H)mm  
19" (W) × 15-3/4" (D) × 3-9/16" (H)  
(19" Standard Rack Mount type)

##### ● Weight

10kg/41b 9oz

##### ● Accessories

MIDI Cable (5P DIN) 1m/3'3"  
Connection Cord (LP-25) × 2

# MODEL MKS-10 MIDI Implementation Chart

Function.....		Transmitted	Recognized dis en	Remarks
Basic Channel	Default Changed		1-16 1-16	memorized
Mode	Default Messages Altered	*****	3 POLY, OMNI ON OFF MONO(M=1)→mode 1, (M=1)→mode 3	
Note Number	: True voice	*****	0-127 21-108	
Velocity	Note ON Note OFF		- x	
After Touch	Key s Ch's		x x	
Pitch Bender			x	
Control Change	64 65 67		- x -	Damper pedal (Soft) * Soft
Prog Change	True =	*****	- (0-127) 0-127	
System Exclusive			x	
System Common	Song Pos Song Sel Tune		x x x	
System Real Time	Clock Commands		x x	
Aux Messages	Local ON OFF All Notes OFF Active Sense Reset		x - - - x (123-127)	
Notes		* This message can be recognized by panel control Receiver only		







**Roland®**

**RUS10006**

---

UPC

RUS10006



12981

**Roland®**