

MIDI

GUIDEBOOK

THE FOURTH EDITION

**A System Which
Greatly Expands the
Potential of Musical Composition**

 **Roland**



WHAT IS MIDI

THE FOURTH EDITION

CONTENTS

1 WHAT IS MIDI ?

(1)Conversation Between Musical Instruments	4
(2)Applications of MIDI	4
(3)What Makes MIDI Conversation Possible	5
(4)One-way MIDI Conversation	7
(5)Closer is Better	8

2 THE BENEFITS OF MIDI

(1)Two Instruments in Unison	10
(2)Combinations of Different Kinds of Instruments	11
(3)A Sequencer System	12
(4)Computer Music System	12
(5)MIDI Systems Expanding Into Various Fields	13

3 MUSICAL INFORMATION TRANSMITTED VIA MIDI

(1)MIDI Channel and Mode	16
(2)Main Contents of MIDI Information	19

4 ACTUAL MIDI IMPLEMENTATION AND NOTES

(1)MIDI Implementation Chart	24
(2)To Avoid MIDI Problems	29

Illustration by T. Yamamoto

1

WHAT IS MIDI ?



WHAT IS MIDI?

(1) Conversation Between Musical Instruments

Musical instruments finally started “conversing” in the 1980’s, a revolution in the world of electronic music. Now, one instrument can say to another: “play middle C, with about 60% strength, then play E4, a little louder”. The second instrument “listens” to this dialogue, and plays the notes in turn, as long as it can understand the language used. The “language” that is now shared by all electronic musical instruments is called “MIDI”, and is featured in this booklet.

Even though the instruments can now “converse”, they still have no will of their own. In fact, the only link in the chain with its own will is you, the musician. Then the instruments interpret your performance by “translating” it into MIDI. “MIDI” is considered to be “the language which is used to send ‘performance information’ from one instrument to another”

Although MIDI is a relatively new concept, it has already become a household word in the musical instrument scene. It is one of the common features of today’s musical instruments. For your reference, MIDI stands for “Musical Instrument Digital Interface”

(2) Applications of MIDI

MIDI is widely known as a “language between musical instruments”. MIDI has expanded in such a short period of time, because it can be applied to many kinds of situations.

MIDI is a universal term. Although there are

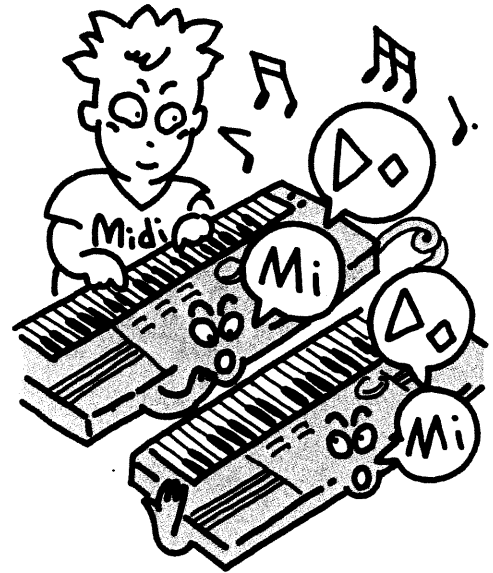

WHAT IS MIDI?

many different languages in the world, such as English, French, and so on, MIDI has only one language, and can therefore provide communication between Japanese and American instruments, or German and Italian instruments. More importantly, MIDI can even be used to “talk” to instruments from different manufacturers.

Furthermore, MIDI can be applied to many kinds of instruments. In this way it is possible for an electronic piano to “talk” to a synthesizer, or a drum machine (for details, please refer to page 11). Consequently, MIDI has an enormous potential for growth and development, as you shall see in this booklet.

(3) What Makes MIDI Conversation Possible

Just how is MIDI used to provide this “conversation”? To explain this, look at the back of your instrument. There are several connectors, including a MIDI IN, a MIDI OUT and often a MIDI THRU. These are the ears and mouth of the MIDI conversation, and are essential for any MIDI communication. The actual “MIDI conversation” travels from the MIDI OUT of one instrument, to the MIDI IN of another, by connecting only one MIDI cable between these two sockets. The cable used has five pins, matching perfectly the five holes in each of the sockets.

NOTE: “DIN SYNC” sockets look very similar to MIDI sockets, but have an entirely different function, so please don’t connect a MIDI cable to a DIN SYNC socket.

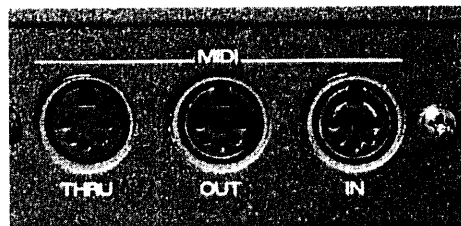

↑ MIDI Connectors

WHAT IS MIDI ?

So why do we need three sockets ? (MIDI IN, MIDI OUT, and MIDI THRU).

MIDI IN is for “listening” to a MIDI conversation, that is, it is the entrance for MIDI information.

MIDI OUT is for “speaking”, to send the conversation from an instrument, and is therefore the exit point for MIDI information.

See FIG 1 for a simple MIDI OUT to MIDI IN connection.

As you can see, MIDI IN and MIDI OUT are relatively easy to understand, and use, however, MIDI THRU is comparatively more difficult. MIDI THRU is similar to MIDI OUT, in that it does “speak” to the next instrument, however, it doesn’t provide it’s own conversation, it merely “repeats” anything that is heard by the MIDI IN. For example, FIG 2, shows the flow of information through a possible set-up of three keyboards.

In this set-up, MIDI information is fed out of the MIDI OUT of keyboard number 1, and into the IN of keyboard number 2. It is also passed on to the IN of keyboard number 3, via the THRU of keyboard number 2. In this way, the information from keyboard number 1 can control both keyboards 2 and 3.

Such a combination of more than 2 instruments is referred to as a “MIDI system”. Of course, without the MIDI THRU this set-up could not

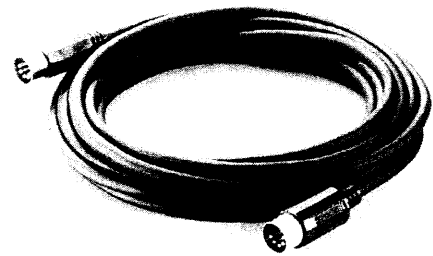

↑ MIDI cable

FIG 1

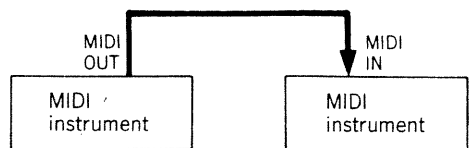
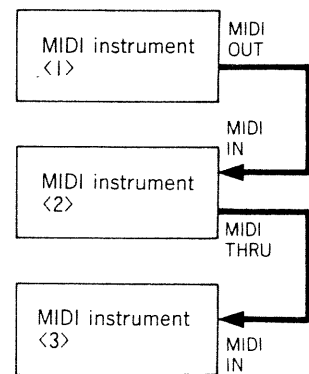
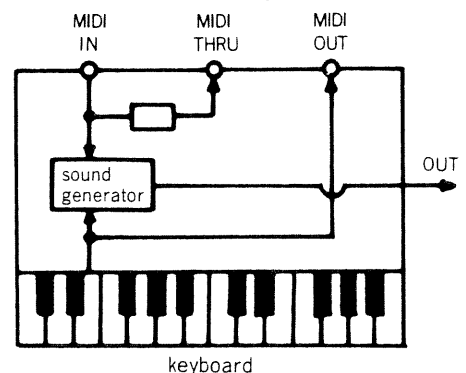

FIG 2



● construction of MIDI Keyboard



WHAT IS MIDI ?

become a MIDI system, and therefore it is easy to understand the use of MIDI THRU in expanding a MIDI system.

(4) One-Way MIDI Conversation

MIDI information is sent from MIDI OUT to MIDI IN, or from MIDI THRU to MIDI IN. The information is always sent “one-way”, so that the “Speaker” and the “listener” in a MIDI conversation remain the same, always! For example, a MIDI “keyboard controller” which has no sound of its own, or a MIDI “sound module” which has no keyboard, and so on, have fixed roles. They are either the “master”, or the “slave”. In this situation, the “speaker” is called the master, and the “listener” is the slave. FIG 3a shows the information from an electronic piano being sent to a synthesizer. In this case the piano is the master, and the synth is the slave.

However, in FIG 3b, the information is being sent from the synth to the piano, and so their roles are reversed. The synth is now the master, while the piano is the slave. Consequently, the connections are very important.

Furthermore, the master/slave relationship is not always one to one, as in the previous 2 diagrams. The number of slaves can be increased, 1:2 or 1:3, etc., as we saw in FIG 2 on a previous page, where instrument 1 was the master, and was controlling 2 slaves, instruments 2 and 3.

As a result, even in very large MIDI systems, if

FIG 3

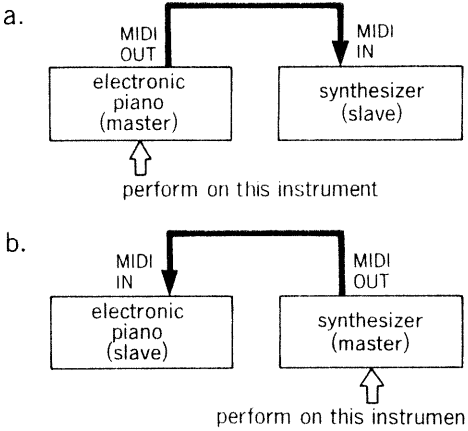

↑ MIDI keyboard controller



↑ MIDI sound module

WHAT IS MIDI ?

you check that the flow of information is all one-way, and all correct, and the relationship between master and slaves is very clear, then the connections will pose no problems.

(5) Closer is Better

From the previous discussion, it would seem that we could construct a chain of instruments, one after the other, via a large series of MIDI THRU connections. However, in reality, a MIDI conversation involves some complicated “dialogue”, and too many MIDI THRU connections can disrupt the conversation, making it progressively less easy to “understand”. Consequently, the 4th or 5th instrument in a chain may receive incorrect data (For further information refer to page 16).

To avoid this situation, place the master and slave instruments as close together as possible. This does not mean the actual physical placement, but rather the number of MIDI connections between them. To simplify this procedure, a MIDI THRU Box, or OUTPUT Selector should be used.

MIDI THRU Boxes send MIDI information from the master to the slaves at the same time, so that each slave receives the information first hand (correctly). There are many kinds of MIDI devices, but remember, although perhaps the simplest, the THRU Box is the most necessary.

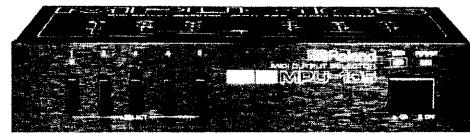

↑ MIDI Output Selector

FIG 4

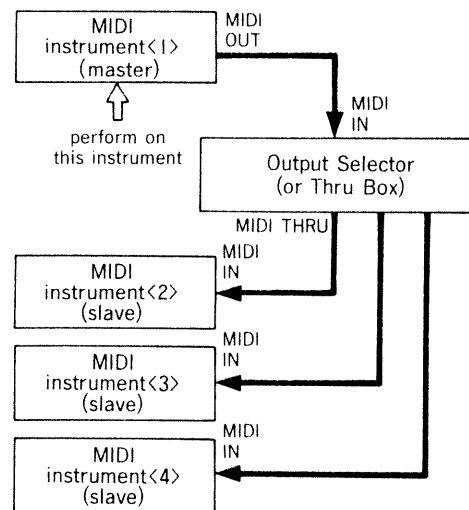

2

THE BENEFITS OF MIDI



THE BENEFITS OF MIDI

(1) Two Instruments in Unison

This section will cover the uses of MIDI in performance, expression, and other facets of the music making process. Firstly, we shall discuss playing 2 instruments in unison.

For example, the MIDI OUT of an electronic piano to the MIDI IN of a synth. Then, if the synth is set to a string sound, playing the piano will cause the synth to play exactly the same part on a string sound. The result is a very BIG sound, simulating the pianist being doubled by an orchestra.

Another useful combination would be to use a harpsichord sound from the piano, and a synth flute sound. Similarly, two synths with pipe organ and choir sounds are very effective. Two trumpet sounds, slightly detuned, make the brass effect much thicker. The list is endless. Playing two instruments in unison can provide a wealth of musical possibilities.

Another method is to use one synth sound that features a unique attack sound, combined with another instrument whose sustain sound is interesting. In this way, a whole new synthesized sound is created by playing the two together.

Playing two instruments in unison is a very basic way of using MIDI, and yet you can achieve a much greater variety of sounds, thicker sounds, than using only one synth. It can certainly



THE BENEFITS OF MIDI

expand your expressive capabilities, so try it and you'll begin to understand the fascination of MIDI. Of course, if you use MIDI THRU connectors... 3 or 4 synths can create some amazing possibilities.

(2) Combinations of Different Kinds of Instruments

As was mentioned earlier, it is possible for different kinds of instruments to “converse” through MIDI. Naturally, we expect keyboards to “talk” to each other, but what would a piano say to a drum machine. It is hard to imagine just what the result might be.

Think what would happen if you connect a piano to a drum machine, the piano as the master, the drum machine as the slave. You may choose the sounds (assign them) so that by playing the key “C” on the piano, a bass drum sound is heard. Then perhaps a “D” would play the snare, and a “G” a tom, etc.. Then, rather than using drum sticks, you can play the “drums” by pressing the appropriate keys on the keyboard.

What happens if the drum machine is the master and the piano is the slave? This time, if the drum machine is playing a pre-programmed rhythm, the piano will play the same part. However, whenever the drum machine plays a bass drum, the piano will play a “C”, etc.. Just the reverse of the previous situation.

NOTE: A drum machine has limited note capability, and can usually only remember a few songs,



THE BENEFITS OF MIDI

so it would be more practical to use a sequencer, or a computer, for this type of automatic performance (as we shall discuss later).

This combination of a piano and a drum machine is only one example. Using MIDI performance information it is possible for many types of instruments to “converse” via MIDI.

(3) A Sequencer System

One of the most powerful uses of the MIDI language is to include a sequencer. Performing in unison, as we mentioned earlier, can provide some excellent sound possibilities, but still limits the performance to that of the master keyboard. A sequencer on the other hand, is capable of remembering several instrumental parts, making it possible to use a variety of sound sources. It then becomes a simple matter to construct an entire arrangement, or orchestration.

For example, a sequencer as the master can control a synth for melody, a piano for chords, another synth for bass, and a drum machine, all at the same time. The data for this 4 part performance being stored in the sequencer. Then, as the data is sent to all 4 instruments, the automatic performance begins.

(4) Computer Music System

Computers did not seem to relate to music very well before MIDI. Certainly it was hard to understand any “conversation” between computers

FIG 1

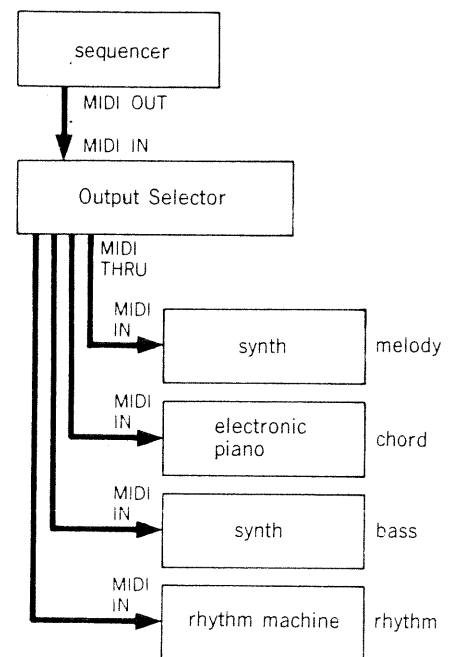

THE BENEFITS OF MIDI

and musical instruments. Thanks to MIDI it is now possible to build small boxes that can "interpret" the language of computers into MIDI, and vice versa. These boxes are called "interfaces".

All computers use what we now call "software", that is, information on computer disk that tells the computer how to behave. One piece of "software" may teach the computer how to be a sequencer for example, while another could be "sound edit" software, teaching the computer how to modify the sounds of a synthesizer.

FIG 2 shows an example of a computer music system with sequencer software. The advantages of such a system are the huge computer memory available, in order to store many songs, or long songs, and the size of the computer display, making it easy to visually check all the data for a performance.

(5) MIDI Systems Expanding Into Various Fields

We have already discussed a variety of MIDI systems, but there are still many more possibilities. For example, when changing a sound in a MIDI system it is also possible to switch a variety of effects on or off, delay or reverb for example. A MIDI sequencer can also be synchronized with a multi-track tape recorder (MTR), expanding the number of available tracks. The concept is extremely versatile, and the future is still wide open.

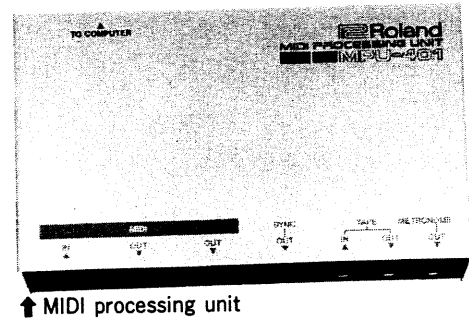
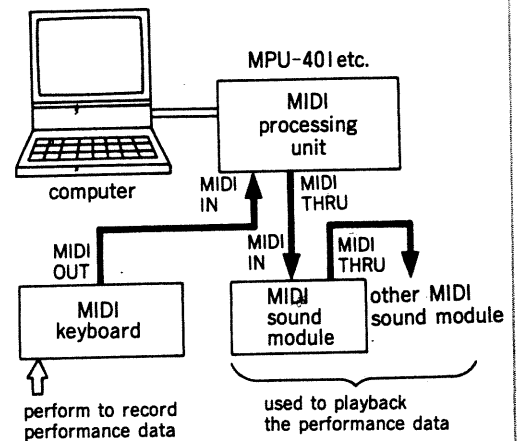

FIG 2



3

MUSICAL INFORMATION TRANSMITTED VIA MIDI



MUSICAL INFORMATION TRANSMITTED VIA MIDI

(1) MIDI Channel and Mode

① Channel

MIDI is able to transmit a variety of information from a master instrument to a slave instrument. Either one part, or multiple parts can be transmitted, for example via a sequencer system.

For this purpose, MIDI includes 16 “channels”. All the different types of MIDI conversation can be sent via these 16 channels separately. So, with one MIDI cable, 16 parts can be played at the same time.

The concept of MIDI channels is similar to that of TV broadcasting in a sense. Many TV stations are transmitting their respective programs at the same time. This means that your TV antenna must be receiving all these channels at once. However, since all the stations are transmitting on different channels, you simply need to select the channel you wish to watch.

MIDI channels behave the same way. A MIDI master instrument is just like a TV broadcasting station. A MIDI slave instrument is like your TV receiver, although rather than transmitting through the air, MIDI is transmitted via cables.

The MIDI master instrument can then decide which channel to transmit, rather like choosing which TV station it wants to be. On the other hand, the slave instrument can behave like the

FIG 1

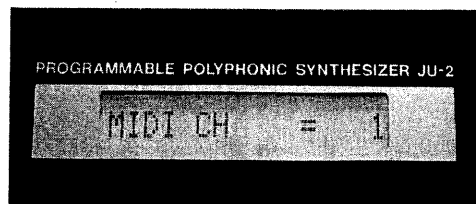
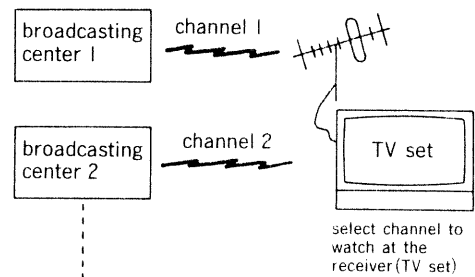

↑ MIDI channel on display

MUSICAL INFORMATION TRANSMITTED VIA MIDI

TV set and choose which MIDI channel it wants to “hear”. Even if information is received on all 16 MIDI channels, the slave will only “hear” the chosen channel, just like the TV set.

For example, if the instruments are set up as in FIG 3, synth 1 only receives the information from channel 1 through the MIDI cable. Synth 2 only receives channel 2. So that if the master keyboard is sending on MIDI channel 1, only synth 1 will respond. Similarly, if the master is on MIDI channel 2, only synth 2 will respond. Even though synth 1 is obviously receiving the information, it cannot respond because it is switched to a different channel. In other words, for this system to work correctly, YOU MUST CAREFULLY SELECT MIDI CHANNELS.

With this concept of MIDI channels, it is then possible to play 16 different parts on 16 instruments, via a sequencer, and all originally down one MIDI cable.

② Modes

As we mentioned before, it is necessary to use the same MIDI channel if a master and a slave are to play in unison, but there is another way to make the slave receive the information. This mode is called “OMNI ON”, and it forces the slave to respond to all 16 MIDI channels at once. In a simple set-up of one master and one slave this becomes very useful, because the slave doesn’t care which channel the master is using, it will “hear” them all. However, when using a

FIG 2

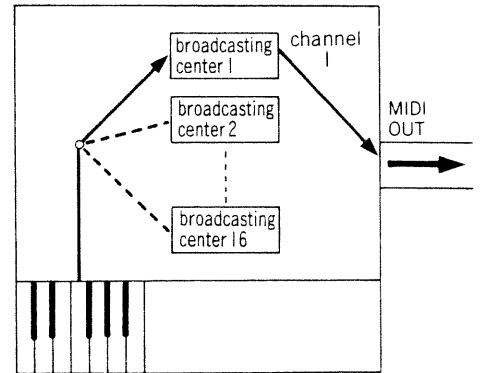
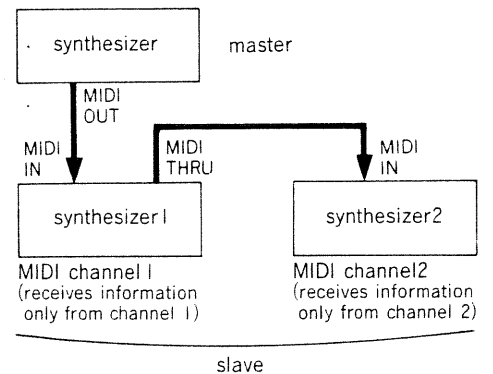

FIG 3



MUSICAL INFORMATION TRANSMITTED VIA MIDI

sequencer playing on a variety of different channels, it is impossible to separate the information. So then the slave must be in the **OMNI OFF** mode, so that it will only receive information on the chosen channel.

There are also “**POLY**” and “**MONO**” modes in MIDI, which decide whether the information is to be sent as “monophonic” information (one note), or “polyphonic” information (more than one note). Keyboard instruments such as pianos and synths usually use the **POLY** mode.

MONO mode is mainly used for MIDI guitar controllers. In this mode, the information belonging to each guitar string is sent on separate channels, dividing the sound source into 6 monophonic synths. Then a **BASIC** MIDI channel is set, and the next 5 channels are used for the other strings.

To choose whether to use **POLY**, **MONO**, **OMNI**, etc., MIDI includes a **MODE** selector, with 4 possibilities, **MODE 1—4**.

MODE 1 : OMNI ON, POLY

Receives the information on all channels
Polyphonic

MODE 2 : OMNI ON, MONO

Receives the information on all channels
but will only play one note at a time

FIG 4

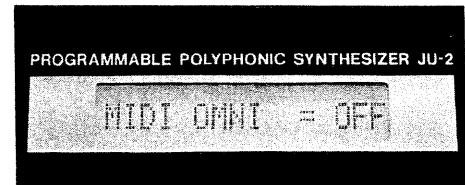
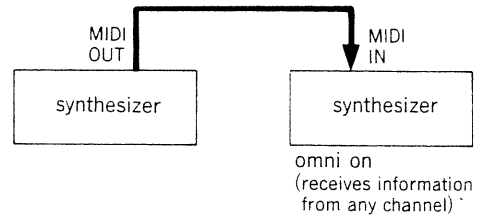

↑ "omni off" on display

FIG 5

	poly	mono
omni on	mode 1	mode 2
omni off	mode 3	mode 4

MUSICAL INFORMATION TRANSMITTED VIA MIDI

MODE 3: OMNI OFF, POLY

Receives only on the chosen MIDI channel

Polyphonic, useful with sequencers

MODE 4: OMNI OFF, MONO

Receives on specific MIDI channel(s), will

only play one note per channel

Useful with guitar controllers

(2) Main Contents of MIDI Information

MIDI contains many kinds of information, that it can use to transmit performance details from the master to the slave. Such things as when each note was played or released (note on and note off), damper pedal on and off, etc. Also, the information is divided into “channel messages” and “system messages”.

① Channel Messages

These messages are sent via the individual MIDI channels to specific instruments in the system, and therefore only effect those instruments receiving that channel. Channel Messages include note on/off, damper pedal on/off, pitch bend, etc.. These Channel Messages are further divided into 2 categories, “Voice Messages” and “Mode Messages”.

a. Voice Messages

• Note Information

Note Information is the most basic, it simply says which key was pressed, when it was pressed, and when it was released.

MUSICAL INFORMATION TRANSMITTED VIA MIDI

• Program Changes

A Program Change is used to cause the slave to change its sound. Synths, electronic pianos, and sampling machines have memories full of many sounds. With these Program Changes the musician can choose which sound to use. It is also possible to switch the memories of MIDI effects devices.

• Control Changes

A Control Change can add subtle nuance to a performance, things like modulation (i.e., vibrato and tremolo), hold (damper) pedal, soft pedal, and portamento. These messages are not used in all MIDI instruments. An electronic piano will send and receive damper pedal information, but it certainly does not require portamento. So even if the master instrument has portamento, the piano will not respond to that information. To find out which controllers a specific instrument will respond to, refer to the "MIDI Implementation Chart" at the back of the owner's manual for that instrument (see page 24).

• After-Touch

Synths and samplers can control vibrato, brilliance, volume, etc., by simply pressing the key harder after initially playing it. This effect is called "After-Touch", and can be used to transmit the same effects via MIDI. Of course, the slave instrument must then decide how to use the After-Touch Information it receives.

• Pitch Bender

If the master has a pitch bender, the information may be sent via MIDI. Once again, the slave will decide if it wants pitch bend, and even how much

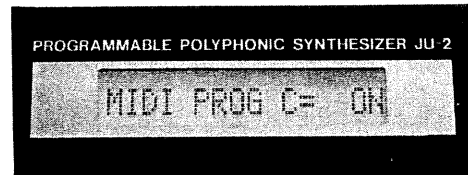

↑ "Program Change ON" on display

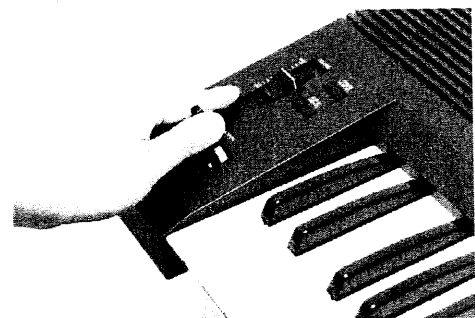

↑ pitch bender lever

MUSICAL INFORMATION TRANSMITTED VIA MIDI

it wants.

b. Mode Messages

As mentioned earlier, MIDI has 4 MODES, and MODE messages are used to switch the MODE of a slave. Some synths or electronic pianos are in MODE 1 (OMNI ON, POLY) whenever they are switched on, so you will need to switch them to MODE 3 (OMNI OFF, POLY) for use with a sequencer. Because of this, some sequencers will automatically send a mode message to turn the slaves to MODE 3. Turning the slaves power on first, followed by the power of the master, will often achieve the same result.

NOTE: Make it a habit to always turn the master on last.

② System Messages

System Messages can be sent no matter how the MIDI channels of the slave or the master are set, since they are used to control the whole MIDI system, that is, every instrument connected by the MIDI cables.

For example, they can be used to synchronize a sequencer and a drum machine, so that they play exactly in time together, or to start and stop the performance, or simply to avoid MIDI system problems.

Also, there are messages called “System Exclusive Messages”, which are messages that are exclusive to a particular manufacturer. So that

MUSICAL INFORMATION TRANSMITTED VIA MIDI

each manufacturer has an “ID Number” which their instruments will recognize. Any system exclusive data received with the wrong ID Number will be ignored by that manufacturers machines. With Exclusive Messages it is possible to transmit sounds between synths, or to change the parameters of a synth via a synth programmer, such as the PG-1 000 or PG-300.

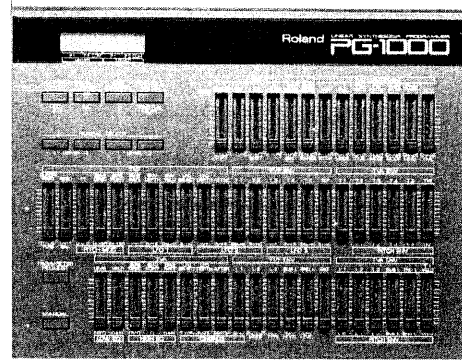

↑ Synthesizer programmer



4

ACTUAL MIDI IMPLEMENTATION AND NOTES

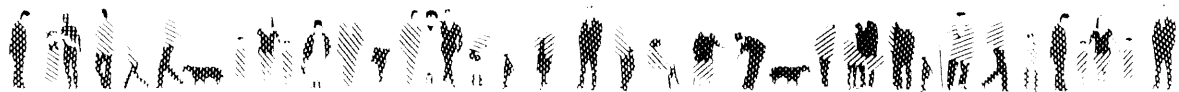

ACTUAL MIDI IMPLEMENTATION AND NOTES

(1) MIDI Implementation Chart

❶ The Effective Way to Check MIDI “Communication”

Although MIDI made it possible for a wide variety of instruments to communicate, this does not mean that all instruments will understand the entire MIDI language.

For example, connecting a MIDI cable from a synth to a MIDI effect may not make the effect behave the way you want. Or using a synth with pitch bend connected to an electronic piano will not force the piano to change its pitch. Simply connecting a MIDI cable is not enough. For the information to be successfully communicated between the two instruments they must both understand that particular piece of information.

As FIG 1 shows, when using a synth as a master to play an electronic piano sound, they can only communicate in area a. The synth has portamento and pitch bend functions, and sends the relevant information via MIDI OUT, but the piano does not have these functions. Consequently, the piano can neither receive nor perform either of these effects. On the other hand, the piano has a soft pedal, a control the synth can not understand.

So, in a multi-instrument MIDI system, you will need to check what information each instrument can send and receive. To quickly check

FIG 1

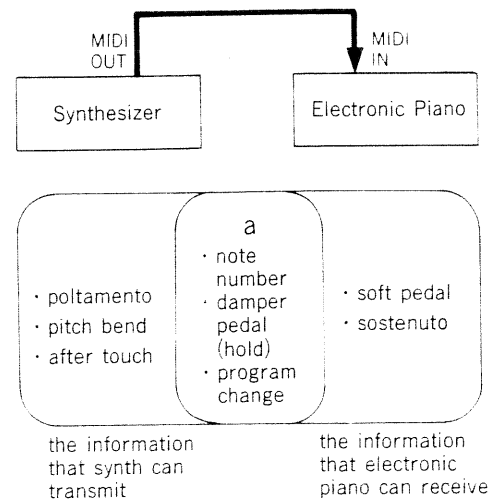

ACTUAL MIDI IMPLEMENTATION AND NOTES

this information, each instrument has a User's Manual that will include a "MIDI Implementation Chart", showing the kinds of information that can be sent and received.

② How To Read MIDI Implementation Charts

On the left hand side of the chart, various types of MIDI information names are listed. The transmit/receive column shows the capability of the instrument to transmit or receive that data, using a "○" for yes and a "X" for no. If its capability depends on other factors, the additional information will also be shown.

■ Basic Channel

There are two columns on Basic Channel, "Power On" and "can be set". Power On shows which channel is set when you first turn on the power. Recently, most instruments can remember a specific MIDI channel. In this case, the channel you selected last time you used the instrument will be recalled, in which case the chart will say "memory works even after the power is turned off".

The next column says "can be set". This shows how many MIDI channels can be set, usually 1—16.

■ Mode

There are 3 columns for Mode, power on, message, and alternative. Power on shows the mode it is in when the power is turned on. The message column shows if it is possible for the instrument to receive Mode messages, or after having

ACTUAL MIDI IMPLEMENTATION AND NOTES

received a mode message if it's possible to still change modes. The alternative column is only used is only used for instruments that can receive messages which will switch the instrument to a special mode, the special mode being explained in this column.

■ Note Numbers

This column shows the note range over which the instrument can receive or transmit. It can usually only transmit as many note numbers as it has keys, while it may receive over a much wider range. Some instruments may receive very high or low notes, but play a note in a different octave as a result, this too is mentioned in this column.

■ Velocity

There are note on and note off columns for velocity. This column shows whether the instrument can transmit or receive these two velocities. It does not represent the actual note on/off capability, just the speed of the respective note on or off. If there is an "X" in either column, it does not mean that the instrument cannot recognize a note on or off, merely that it does not recognize how fast it was pressed or released.

■ After-touch

This shows if the instrument can receive/transmit after-touch information. The columns refer to channel after-touch (one value per MIDI channel) and polyphonic after-touch (a separate

ACTUAL MIDI IMPLEMENTATION AND NOTES

after-touch for each note), but after-touch usually refers to channel after-touch.

■ Pitch Bend

Whether or not the instrument can receive/transmit pitch bender information.

■ Control Change

This column shows whether or not the instrument can transmit/receive controls like modulation, damper pedal, portamento, etc.. These controls are particularly important when connecting two different synths, or a synth and a piano.

■ Program Change

Whether or not the instrument can transmit/receive program change information, and what numbers it uses.

■ System Exclusive

This column indicates what kind of data can be transmitted/received via System Exclusive Messages.

■ System Common

This section is for sequencer based MIDI systems. It indicates if the instrument will understand MIDI Song Position Pointer, where the instrument can decide from which bar to start playing, and MIDI SONG Selection, to decide which song to play, etc..

ACTUAL MIDI IMPLEMENTATION AND NOTES

■ System Real Time

Real Time Information refers to the ability of the machine to synchronize via MIDI. If it understands “Clock” information then it can play in time with other instruments. If it understands “Command” information, it will also know when to start and stop.

■ Aux Messages

This column is used to display whether the instrument is capable of receiving information that will help it to avoid any MIDI problems.

This area is used for exceptions to the rules. For example, if the functions of an instrument change according to specific parameter settings, they will be indicated here.

As a result, when you connect two or more instruments via MIDI cables, you merely need to check the relevant columns of their respective Implementation Charts to see if the communication you require is possible.

See FIG 2 for an easy way to compare charts. All MIDI Implementation Charts have a standard format, making it easy to arrange the charts as shown, and compare the transmit column of the master to the receive column of the slave. For instance, if either column has a “X” for pitch bend, then it will not be communicated.

FIG 2

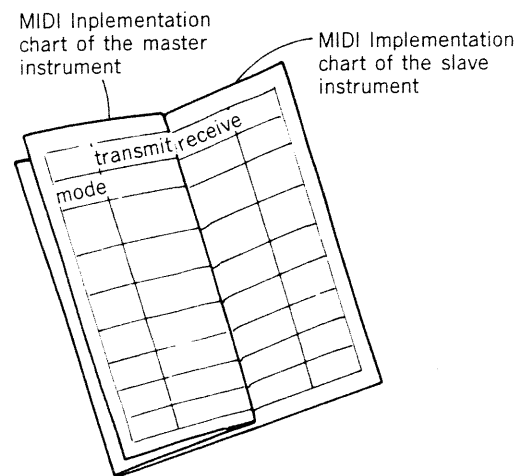

ACTUAL MIDI IMPLEMENTATION AND NOTES

NOTE : Some synths can decide whether or not to transmit or receive specific data such as program change, or portamento, which can then create some interesting effects.

(2) To Avoid MIDI Problems

MIDI enables you to add expression to your music in many different ways. Things like after touch, synchronization, and pitch bend can substantially enhance the performance. However, this requires an exchange of large amounts of data, which also increases the possibility of error. Unexpected problems can be caused by faulty connections, lack of knowledge, and many other factors. In this section some of the common problems are discussed, and their solutions explained.

① MIDI Cable Connections

Obviously, if the cables are connected incorrectly the performance information can not be successfully communicated. Make sure they are connected from the MIDI OUT of the master, to the MIDI IN of the slaves (or MIDI THRU to MIDI IN).

See FIG 3, the master is connected straight back to its own MIDI IN. In this case, turn the power off, and re-connect the cables correctly. Do not connect the MIDI OUT to the MIDI IN of the same instrument.

② How to Connect MIDI Cables, and Switching MIDI Channels

Whenever you wish to change a connection,

FIG 3
Example of a wrong connection

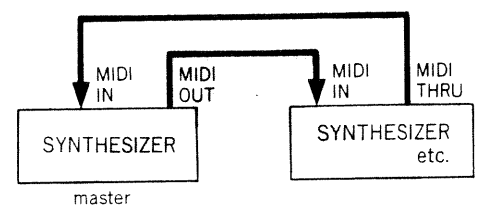

always turn the power off before removing the cable. If you are playing and a cable is removed, you may not be able to stop the sound. Some keyboards will not change MIDI channels while a note is playing, so you will need to stop playing before changing channels.

③ Power On Order

Always turn the master instrument on last! In fact, you cannot cause damage by turning it on first, but it may make the set-up much easier to finish with the master. This is because the master often sends out Mode Messages that will make the slaves behave correctly.

④ Pitch Bend Range and After Touch Effects

Although MIDI can transmit Pitch Bender and After-Touch Information, it actually only says how much the pitch lever was moved and how hard the keys were pressed. It does not say how far the pitch actually moved, nor what after-touch effect occurred. The range of pitch change (bender range), and the effects caused by the after-touch need to be set on both instruments, the master and the slave.

⑤ MIDI and Drum Machines

Drum machines can be used in synchronization with sequencers, or as a sound source for a MIDI keyboard, etc. . When a synth is the slave, to change the sound you need to send a Program Change Message. However, to change the sound of a drum machine you need only play a different note. "C" for bass drum, "D" for snare, etc..

ACTUAL MIDI IMPLEMENTATION AND NOTES

Consequently, in a MIDI system using a sequencer, it would be better to set the MIDI channel of the drum machine to a channel that is not being used, so that it does not receive unexpected note on data.

⑥ Local Control

Some synths and equipment have a parameter related to MIDI called “Local Control”. When this control is “on” (LOCAL ON) the keyboard of the instrument can play its own sounds, if LOCAL is OFF, the instrument can only send MIDI information out, without playing its own sounds.

The basic structure of synths and electronic pianos is shown in FIG 4. The information generated by the keyboard usually goes to the sound generating part to play a sound. This connection is broken if the LOCAL switch is OFF. However, even if LOCAL is OFF, the MIDI OUT connection will still operate.

LOCAL OFF is convenient when using sequencers which are capable of mixing the MIDI IN information with the MIDI OUT information. This function is called SOFT THRU (see FIG 5). In this case, when you record using LOCAL OFF, and SOFT THRU ON, you can listen to the performance of the sequencer as well as your performance on the keyboard.

FIG 4

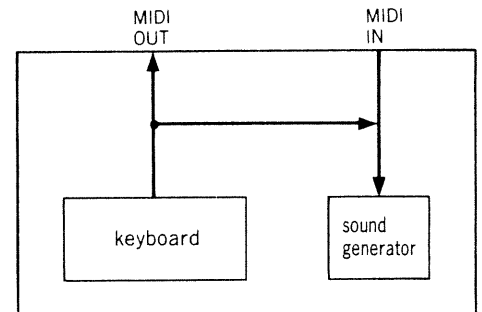
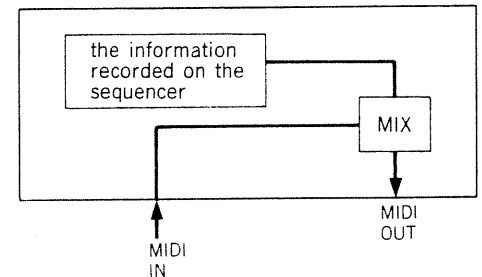

FIG 5



Roland®

2601510200

UPC

2601510200



10981

Roland

MIDI GUIDEBOOK
〈THE FOURTH EDITION〉

December 1987

27th Printing Apr 1992 (E-3)

Printed in Japan

No.26015102

Copyright © 1987 by ROLAND CORPORATION

All rights reserved. No part of this publication may be reproduced in any form without the written permission of ROLAND CORPORATION

