

## 10CH DIGITAL LINE MIXER M-1000

24 bit / 96 kHz 56 bit Internal Processing

### Owner's Manual





Before using this unit, carefully read the sections entitled: “IMPORTANT SAFETY INSTRUCTIONS” (Owner’s manual p. 2), “USING THE UNIT SAFELY” (Owner’s manual p. 3), and “IMPORTANT NOTES” (Owner’s manual p. 5). These sections provide important information concerning the proper operation of the unit. Additionally, in order to feel assured that you have gained a good grasp of every feature provided by your new unit, Owner’s manual should be read in its entirety. The manual should be saved and kept on hand as a convenient reference.

Copyright © 2002 ROLAND CORPORATION

All rights reserved.

No part of this publication may be reproduced in any form  
without the written permission of ROLAND CORPORATION.

<http://www.roland.co.jp/>

	<b>CAUTION</b> RISK OF ELECTRIC SHOCK DO NOT OPEN	
<b>ATTENTION:</b> RISQUE DE CHOC ELECTRIQUE NE PAS OUVRIR		
<b>CAUTION:</b> TO REDUCE THE RISK OF ELECTRIC SHOCK, DO NOT REMOVE COVER (OR BACK). NO USER-SERVICEABLE PARTS INSIDE. REFER SERVICING TO QUALIFIED SERVICE PERSONNEL.		



The lightning flash with arrowhead symbol, within an equilateral triangle, is intended to alert the user to the presence of uninsulated "dangerous voltage" within the product's enclosure that may be of sufficient magnitude to constitute a risk of electric shock to persons.



The exclamation point within an equilateral triangle is intended to alert the user to the presence of important operating and maintenance (servicing) instructions in the literature accompanying the product.

**INSTRUCTIONS PERTAINING TO A RISK OF FIRE, ELECTRIC SHOCK, OR INJURY TO PERSONS.**

# IMPORTANT SAFETY INSTRUCTIONS

## SAVE THESE INSTRUCTIONS

**WARNING** - When using electric products, basic precautions should always be followed, including the following:

1. Read these instructions.
2. Keep these instructions.
3. Heed all warnings.
4. Follow all instructions.
5. Do not use this apparatus near water.
6. Clean only with a dry cloth.
7. Do not block any of the ventilation openings. Install in accordance with the manufacturers instructions.
8. Do not install near any heat sources such as radiators, heat registers, stoves, or other apparatus (including amplifiers) that produce heat.
9. Do not defeat the safety purpose of the polarized or grounding-type plug. A polarized plug has two blades with one wider than the other. A grounding type plug has two blades and a third grounding prong. The wide blade or the third prong are provided for your safety. When the provided plug does not fit into your outlet, consult an electrician for replacement of the obsolete outlet.
10. Protect the power cord from being walked on or pinched particularly at plugs, convenience receptacles, and the point where they exit from the apparatus.
11. Only use attachments/accessories specified by the manufacturer.
12. Never use with a cart, stand, tripod, bracket, or table except as specified by the manufacturer, or sold with the apparatus. When a cart is used, use caution when moving the cart/apparatus combination to avoid injury from tip-over.
13. Unplug this apparatus during lightning storms or when unused for long periods of time.
14. Refer all servicing to qualified service personnel. Servicing is required when the apparatus has been damaged in any way, such as power-supply cord or plug is damaged, liquid has been spilled or objects have fallen into the apparatus, the apparatus has been exposed to rain or moisture, does not operate normally, or has been dropped.



**For the U.K.**

**WARNING:** THIS APPARATUS MUST BE EARTHED

**IMPORTANT:** THE WIRES IN THIS MAINS LEAD ARE COLOURED IN ACCORDANCE WITH THE FOLLOWING CODE.  
GREEN-AND-YELLOW: EARTH, BLUE: NEUTRAL, BROWN: LIVE

As the colours of the wires in the mains lead of this apparatus may not correspond with the coloured markings identifying the terminals in your plug, proceed as follows:

The wire which is coloured GREEN-AND-YELLOW must be connected to the terminal in the plug which is marked by the letter E or by the safety earth symbol  or coloured GREEN or GREEN-AND-YELLOW.



The wire which is coloured BLUE must be connected to the terminal which is marked with the letter N or coloured BLACK.



The wire which is coloured BROWN must be connected to the terminal which is marked with the letter L or coloured RED.

- \* Microsoft and Windows are registered trademarks of Microsoft Corporation.
- \* Windows® 98 is known officially as: "Microsoft® Windows® 98 operating system."
- \* Windows® 2000 is known officially as: "Microsoft® Windows® 2000 operating system."
- \* Windows® Me is known officially as: "Microsoft® Windows® Millennium Edition operating system."
- \* Windows® XP is known officially as: "Microsoft® Windows® XP operating system."
- \* Apple and Macintosh are registered trademark of Apple Computer, Inc.
- \* MacOS is a trademark of Apple Computer, Inc.
- \* VST and ASIO are trademark of Steinberg Media Technologies AG.
- \* All product names mentioned in this document are trademarks or registered trademarks of their respective owners.







# USING THE UNIT SAFELY

## INSTRUCTIONS FOR THE PREVENTION OF FIRE, ELECTRIC SHOCK, OR INJURY TO PERSONS

About  WARNING and  CAUTION Notices









 <b>WARNING</b>	Used for instructions intended to alert the user to the risk of death or severe injury should the unit be used improperly.
 <b>CAUTION</b>	Used for instructions intended to alert the user to the risk of injury or material damage should the unit be used improperly. * Material damage refers to damage or other adverse effects caused with respect to the home and all its furnishings, as well to domestic animals or pets.





About the Symbols

	The  symbol alerts the user to important instructions or warnings. The specific meaning of the symbol is determined by the design contained within the triangle. In the case of the symbol at left, it is used for general cautions, warnings, or alerts to danger.
	The  symbol alerts the user to items that must never be carried out (are forbidden). The specific thing that must not be done is indicated by the design contained within the circle. In the case of the symbol at left, it means that the unit must never be disassembled.
	The  symbol alerts the user to things that must be carried out. The specific thing that must be done is indicated by the design contained within the circle. In the case of the symbol at left, it means that the power-cord plug must be unplugged from the outlet.

### ALWAYS OBSERVE THE FOLLOWING

#### **WARNING**

- Before using this unit, make sure to read the instructions below, and the Owner's Manual. 
- Do not open or perform any internal modifications on the unit. 
- Do not attempt to repair the unit, or replace parts within it (except when this manual provides specific instructions directing you to do so). Refer all servicing to your retailer, the nearest Roland Service Center, or an authorized Roland distributor, as listed on the "Information" page. 
- Never use or store the unit in places that are:
  - Subject to temperature extremes (e.g., direct sunlight in an enclosed vehicle, near a heating duct, on top of heat-generating equipment); or are 
  - Damp (e.g., baths, washrooms, on wet floors); or are 
  - Humid; or are
  - Exposed to rain; or are
  - Dusty; or are
  - Subject to high levels of vibration.
- Make sure you always have the unit placed so it is level and sure to remain stable. Never place it on stands that could wobble, or on inclined surfaces. 
- The unit should be connected to a power supply only of the type described in the operating instructions, or as marked on the unit. 
- Use only the attached power-supply cord. 

- Do not excessively twist or bend the power cord, nor place heavy objects on it. Doing so can damage the cord, producing severed elements and short circuits. Damaged cords are fire and shock hazards! 
- This unit, either alone or in combination with an amplifier and headphones or speakers, may be capable of producing sound levels that could cause permanent hearing loss. Do not operate for a long period of time at a high volume level, or at a level that is uncomfortable. If you experience any hearing loss or ringing in the ears, you should immediately stop using the unit, and consult an audiologist. 
- Do not allow any objects (e.g., flammable material, coins, pins); or liquids of any kind (water, soft drinks, etc.) to penetrate the unit.   

- Immediately turn the power off, remove the power cord from the outlet, and request servicing by your retailer, the nearest Roland Service Center, or an authorized Roland distributor, as listed on the "Information" page when:
  - The power-supply cord, or the plug has been damaged; or
  - If smoke or unusual odor occurs
  - Objects have fallen into, or liquid has been spilled onto the unit; or
  - The unit has been exposed to rain (or otherwise has become wet); or
  - The unit does not appear to operate normally or exhibits a marked change in performance.

- In households with small children, an adult should provide supervision until the child is capable of following all the rules essential for the safe operation of the unit. 

---

- Protect the unit from strong impact. (Do not drop it!) 

---

- Do not force the unit's power-supply cord to share an outlet with an unreasonable number of other devices. Be especially careful when using extension cords—the total power used by all devices you have connected to the extension cord's outlet must never exceed the power rating (watts/amperes) for the extension cord. Excessive loads can cause the insulation on the cord to heat up and eventually melt through. 

---

- Before using the unit in a foreign country, consult with your retailer, the nearest Roland Service Center, or an authorized Roland distributor, as listed on the "Information" page. 

---

- DO NOT play a CD-ROM disc on a conventional audio CD player. The resulting sound may be of a level that could cause permanent hearing loss. Damage to speakers or other system components may result. 

---

 **CAUTION**

- The unit should be located so that its location or position does not interfere with its proper ventilation. 

---

- Always grasp only the plug on the power-supply cord when plugging into, or unplugging from, an outlet or this unit. 

---

- Any accumulation of dust between the power plug and the power outlet can result in poor insulation and lead to fire. Periodically wipe away such dust with a dry cloth. Also, disconnect the power plug from the power outlet whenever the unit is to remain unused for an extended period of time. 

---

- Try to prevent cords and cables from becoming entangled. Also, all cords and cables should be placed so they are out of the reach of children. 

---

- Never climb on top of, nor place heavy objects on the unit. 

---

- Never handle the power cord or its plugs with wet hands when plugging into, or unplugging from, an outlet or this unit. 

---

- Before moving the unit, disconnect the power plug from the outlet, and pull out all cords from external devices. 

---

- Before cleaning the unit, turn off the power and unplug the power cord from the outlet (p. 8). 

---

- Whenever you suspect the possibility of lightning in your area, pull the plug on the power cord out of the outlet. 

---

- Should you remove rubber feet or screws of rack mount angles, make sure to put them in a safe place out of children's reach, so there is no chance of them being swallowed accidentally. 

---

# IMPORTANT NOTES

In addition to the items listed under “IMPORTANT SAFETY INSTRUCTIONS” and “USING THE UNIT SAFELY” on p. 2 and p. 3, please read and observe the following:

## Power Supply

- Do not use this unit on the same power circuit with any device that will generate line noise (such as an electric motor or variable lighting system).
- Before connecting this unit to other devices, turn off the power to all units. This will help prevent malfunctions and/or damage to speakers or other devices.

## Placement

- Using the unit near power amplifiers (or other equipment containing large power transformers) may induce hum. To alleviate the problem, change the orientation of this unit; or move it farther away from the source of interference.
- This device may interfere with radio and television reception. Do not use this device in the vicinity of such receivers.
- Noise may be produced if wireless communications devices, such as cell phones, are operated in the vicinity of this unit. Such noise could occur when receiving or initiating a call, or while conversing. Should you experience such problems, you should relocate such wireless devices so they are at a greater distance from this unit, or switch them off.
- When moved from one location to another where the temperature and/or humidity is very different, water droplets (condensation) may form inside the unit. Damage or malfunction may result if you attempt to use the unit in this condition. Therefore, before using the unit, you must allow it to stand for several hours, until the condensation has completely evaporated.

## Maintenance

- For everyday cleaning wipe the unit with a soft, dry cloth or one that has been slightly dampened with water. To remove stubborn dirt, use a cloth impregnated with a mild, non-abrasive detergent. Afterwards, be sure to wipe the unit thoroughly with a soft, dry cloth.
- Never use benzine, thinners, alcohol or solvents of any kind, to avoid the possibility of discoloration and/or deformation.

## Additional Precautions

- Use a reasonable amount of care when using the unit's buttons, sliders, or other controls; and when using its jacks and connectors. Rough handling can lead to malfunctions.

- When connecting / disconnecting all cables, grasp the connector itself—never pull on the cable. This way you will avoid causing shorts, or damage to the cable's internal elements.
- A small amount of heat will radiate from the unit during normal operation.
- To avoid disturbing your neighbors, try to keep the unit's volume at reasonable levels. You may prefer to use headphones, so you do not need to be concerned about those around you (especially when it is late at night).
- When you need to transport the unit, package it in the box (including padding) that it came in, if possible. Otherwise, you will need to use equivalent packaging materials.
- Use a cable from Roland to make the connection. If using some other make of connection cable, please note the following precautions.
  - Some connection cables contain resistors. Do not use cables that incorporate resistors for connecting to this unit. The use of such cables can cause the sound level to be extremely low, or impossible to hear. For information on cable specifications, contact the manufacturer of the cable.

## Handling CD-ROMs

- Avoid touching or scratching the shiny underside (encoded surface) of the disc. Damaged or dirty CD-ROM discs may not be read properly. Keep your discs clean using a commercially available CD cleaner.

## Copyright

- As this product is designed as professional equipment, this unit can perform recording without being subject to the restrictions of the Serial Copy Management System (SCMS) even in case of exchanging audio signals through a digital connection with an external instrument. This is because the unit is intended solely for musical production, and is designed not to be subject to restrictions as long as it is used to record works (such as your own compositions) that do not infringe on the copyrights of others. (SCMS is a feature that prohibits second-generation and later copying through a digital connection. It is built into MD recorders and other consumer digital-audio equipment as a copyright-protection feature.)
- Do not use this unit for purposes that could infringe on a copyright held by a third party. We assume no responsibility whatsoever with regard to any infringements of third-party copyrights arising through your use of this unit.

# Contents

<b>USING THE UNIT SAFELY .....</b>	<b>3</b>
<b>IMPORTANT NOTES .....</b>	<b>5</b>
<b>Contents .....</b>	<b>6</b>
<b>Introduction .....</b>	<b>7</b>
Main Features.....	7
Accessories .....	7
Basic Operation.....	7
Preparation.....	7
Turning On the Power.....	8
Turning Off the Power .....	8
Functions and Operation of Each Section.....	8
<b>Examples of Use .....</b>	<b>9</b>
Mixing Analog and Digital Inputs.....	9
Using the M-1000 with a Computer Connected Via USB.....	10
Installing the USB Audio Driver.....	11
Matching the Sampling Frequency.....	11
Procedure for Changing the Settings .....	11
Indicator Status and Settings Status .....	11
<b>USB Audio .....</b>	<b>12</b>
What is a Driver?.....	12
Types of Drivers .....	12
Advanced Mode and Standard Driver Mode .....	12
Advanced Mode .....	12
Standard Driver Mode .....	13
Installing the Drivers .....	14
Installation Overview .....	14
Deleting the Special Drivers (Uninstall).....	15
<b>Explanations.....</b>	<b>16</b>
Digital Connections.....	16
Other Points.....	17
<b>Other Features .....</b>	<b>18</b>
Initializing the Settings	
---Restoring the M-1000 to Its Original Factory Conditions.....	18
Changing the Signal Path for the Analog Output (MIX OUT)	
- If the audio in the inputs is doubled in the output when using the USB connection - .....	18
<b>Troubleshooting.....</b>	<b>19</b>
<b>Concerning Copyright .....</b>	<b>20</b>
About SCMS.....	20
Disclaimer of liability.....	20
About the License Agreement .....	20
<b>Specifications.....</b>	<b>21</b>
<b>block diagram.....</b>	<b>22</b>
<b>Index.....</b>	<b>23</b>

# Introduction

## Main Features

- Features four pairs of stereo (eight-channels) digital audio input plus one pair of stereo (two-channels) analog audio input.
- Connects to computers via USB for input and output of digital audio signals.
- Each digital audio signal input is equipped with a sample rate converter, thus allowing you to mix even inputs with different sampling frequencies and phases.

## Accessories

The following additional items are shipped with the M-1000. Please take a moment to confirm that all of the following items have been included in the box.

- Owner's Manual (this volume)
- "Functions and Operations of Each Section" chart
- CD-ROM (Driver)
- USB cable
- Rubber feet (4)
- Power cable

## Basic Operation

### ■ Preparation

#### Attaching the rubber feet

If necessary, attach the rubber feet on the bottom panel as shown in the figure.

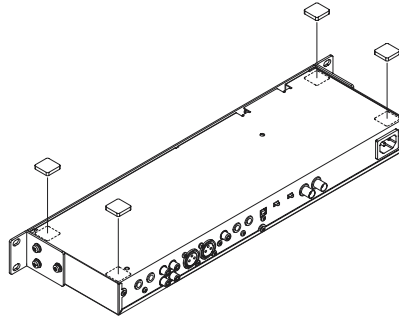

#### Setup

Mount the M-1000 in rack mount, set it on a table or desk, or in another suitable location.

*\* If the M-1000 is placed directly above a power amp, the heat generated by the amp may adversely affect the M-1000.*

#### Connecting the Power Source

Use the included power cable to connect the unit with a power source.

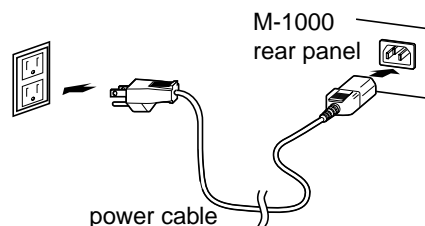

#### The pin assignment for the XLR type connectors

*\* The pin assignment for the XLR type connectors is as shown below. Before making any connections, make sure that this pin assignment is compatible with that of all your other devices.*

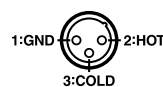

### ■ Turning On the Power

*\* Once the connections have been completed (p. 7, p. 9, p. 10), turn on power to your various devices in the order specified. By turning on devices in the wrong order, you risk causing malfunction and/or damage to speakers and other devices.*

1. Turn down the volume completely on all devices.
2. Press the POWER switch on the M-1000's front panel to turn on the power. If the M-1000 is operating properly, the indicators should show the current settings. If set to the default factory settings, the [INT] and [44.1kHz] indicators light if no input or output device is connected. In other cases, indicators show the current settings or connections.

*\* This unit is equipped with a protection circuit. A brief interval of a few seconds is required after power up before the unit will operate normally.*

### ■ Turning Off the Power

1. Turn down the volume completely on all devices.
2. Press the POWER switch on the M-1000's front panel to turn off the power.



“Examples of Use” (p. 9)

## Functions and Operation of Each Section

---



For a look at the features found in each section and how to use them, refer to the A3-size chart “Functions and Operations of Each Section.”



# Examples of Use

*\* To prevent malfunction and/or damage to speakers or other devices, always turn down the volume, and turn off the power on all devices before making any connections.*

## Mixing Analog and Digital Inputs

As shown in the following figure, you can connect synthesizers and audio sources, and then mix these inputs.

*\* For instructions on what to do in each section, refer to the separate "Functions and Operations of Each Section" chart.*

### Analog Input

Try inputting signals with the ANALOG INPUT SENS (sensitivity) switch set to [-10 dB]. If the PEAK indicator lights, switch this to [+4 dB].

### Digital Input

If using one digital input, set the DIGITAL INPUT SELECT switch to match the input (coaxial or optical) connector being used. Confirm that the LOCK indicator for the input being used is lit. Adjust the volume with the LEVEL

### Amp/Digital Recorder

The sampling frequency of the connected digital recorder is synchronized to the M-1000. Adjust the output volume with the LEVEL (inner) knob. Adjust the left-right volume balance with the BALANCE (outer) knob.

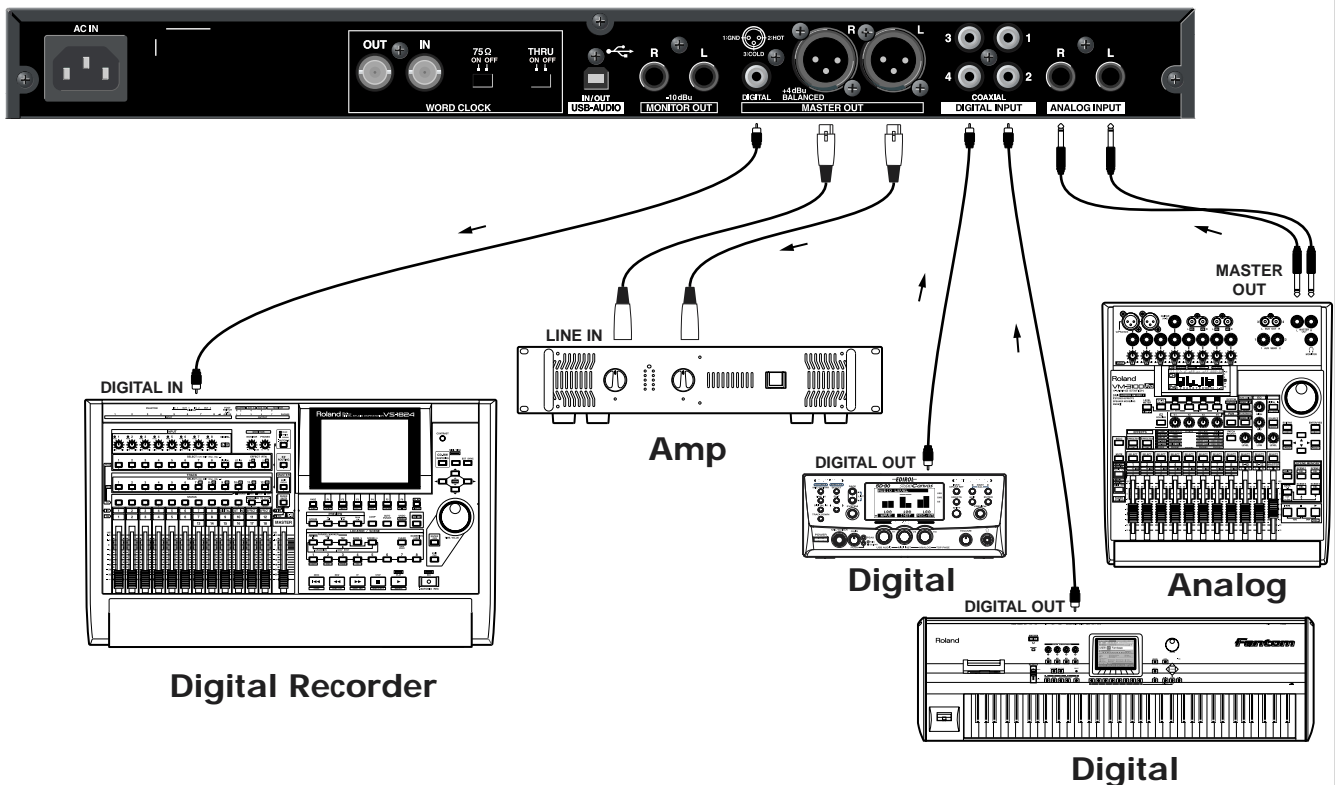
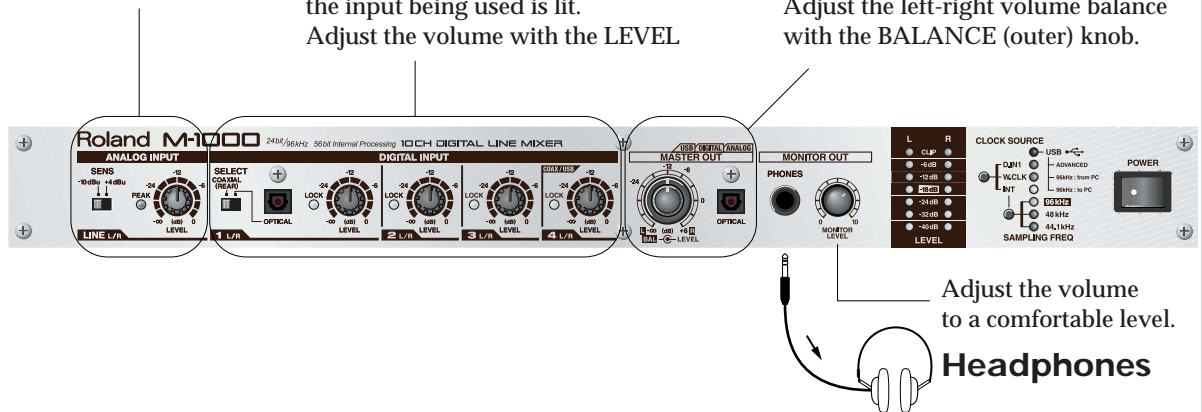

# Examples of Use

## Using the M-1000 with a Computer Connected Via USB

You can use the M-1000 with computers by connecting as shown in the following figure.

- Mixing the input from digital inputs 1-3 and the analog input with sounds played back from the computer
- Mixing the input from digital inputs 1-3 and the analog input, and recording this to the computer
- Recording the mixed input from digital inputs 1-3 and the analog input to the computer while playing back previously recorded sounds with the computer.

To record or play audio on computers, application software is necessary. (The application software pre-installed to MacOS or Windows can be used for such purpose.)

\* For instructions on what to do in each section, refer to the separate "Functions and Operations of Each Section" chart.

### NOTE

The M-1000 mix output can be sent to the USB port, and then the USB port can return this signal along with its own audio as the USB input to the M-1000. However, signals played back with the computer cannot be returned and used by the computer via USB (computer → USB → M-1000 → USB → computer).

### Analog Input

Try inputting signals with the ANALOG INPUT SENS (sensitivity) switch set to [-10 dB]. If the PEAK indicator lights, switch this to [+4 dB].

### Digital Input

If using one digital input, set the DIGITAL INPUT SELECT switch to match the input (coaxial or optical) connector being used. Confirm that the LOCK indicator for the input being used is lit. Adjust the volume with the LEVEL knob. Four digital inputs accept sounds from computers.

### Outputting to the Computer (and MASTER Output)

Adjust the volume level input to the computer with the LEVEL (inner) knob. Adjust the left-right balance of the sound input to the computer with the BALANCE (outer) knob.

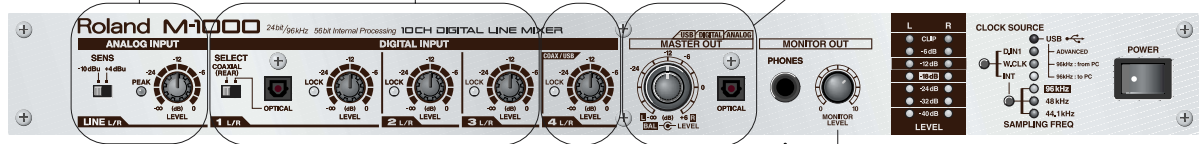

### Inputting from the Computer

The LOCK indicator lights up when the M-1000 is connected to a computer with a USB cable. Adjust the volume of the sound from the computer.

Adjust the volume to a comfortable level.

### Headphones

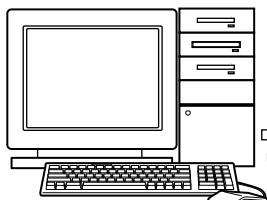
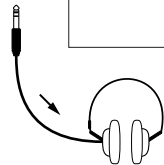

### Computer

Install the USB audio driver and make the appropriate settings.

### Digital

When connecting with USB, you cannot input signals through input 4.

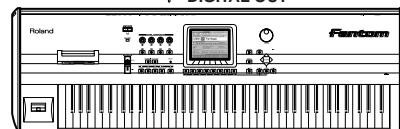

### Digital

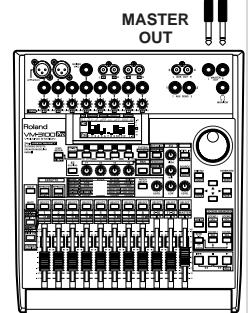

### Analog

## ■ Installing the USB Audio Driver

To connect a computer via USB, you first need to install the USB audio driver. Read the section “Installing the Drivers” (p. 14), then perform the installation as instructed. For better sound, we strongly recommend using the M-1000 in “Advanced Mode” (p. 12).

## ■ Matching the Sampling Frequency

When exchanging audio signals between the M-1000 and a computer via a USB connection, set both the software and the M-1000 to the same sampling frequency. Although there are applications capable of exchanging audio signals with differing sampling frequencies, this may reduce the sound quality.

## ■ Procedure for Changing the Settings

You need to switch off the M-1000, then turn it on again after you've changed the driver or sampling frequency settings when the M-1000 is connected to a computer via USB.

1. Quit all applications that make use of USB audio.
2. Press the USB driver select button/sampling frequency select buttons a number of times until the desired indicators flash (reserved status).
3. Turn off the M-1000, then turn it on again.
4. Start up your application or applications.

## ■ Indicator Status and Settings Status

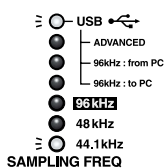

Standard Driver Mode  
44.1 kHz

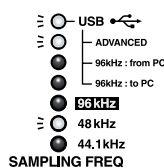

Advanced Mode  
48 kHz

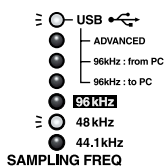

Standard Driver Mode  
48 kHz

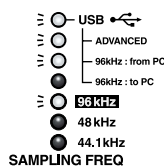

Advanced Mode  
96 kHz  
Input from Computer

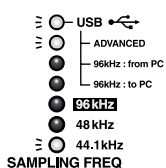

Advanced Mode  
44.1 kHz

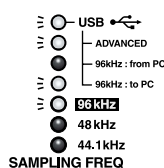

Advanced Mode  
96 kHz  
Output to Computer

### MEMO

The flashing light indicates the “reserved” setting; when the M-1000 is turned off, then on again, that setting is enabled, and the indicator then remains lit.

# USB Audio

If using the M-1000 with a computer connected, you will need to install the USB audio driver on the computer.

*\* For latest information about driver etc., please refer to Roland web site.*

<http://www.roland.co.jp/>



USB:  
Universal Serial Bus

## ■ What is a Driver?

Drivers are software programs that allow data to be exchanged between computer applications and the M-1000 when the M-1000 is connected to the computer with a USB cable.

The driver transmits data from applications to the

M-1000 and also relays data from the M-1000 back to the applications.

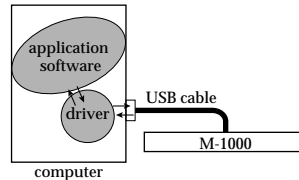

## ■ Types of Drivers

The following chart shows the drivers that can be used according to your operating system (such as Windows XP or Mac OS).

WindowsXP/2000	M-1000 Special WDM Driver	c cADVANCED 44.1kHz/48kHz/96kHz:fromPC/96kHz:toPC
	M-1000 Special MME Driver	c cADVANCED 44.1kHz/48kHz/96kHz:fromPC/96kHz:toPC
	Windows Standard Driver	c c44.1kHz/48kHz
WindowsMe/98	M-1000 Special Driver	c cADVANCED 44.1kHz/48kHz/96kHz:fromPC/96kHz:toPC
	Windows Standard Driver	c c44.1kHz/48kHz
MacOS	M-1000 Special Driver (under MacOS 8.6: not supported)	c cADVANCED 44.1kHz/48kHz/96kHz:fromPC/96kHz:toPC
	MacOS Standard Driver (under MacOS 9.0.4: not supported)	c c44.1kHz/48kHz



The special driver supports  
ASIO.

## Advanced Mode and Standard Driver Mode

The M-1000 features two operational modes, Advanced mode and Standard Driver mode, each of which uses different drivers.

### ■ Advanced Mode

This mode is operational when the [ADVANCED] USB indicator is lit. Using the special drivers provided on the M-1000 Driver CD-ROM, you can input and output high-quality audio data with great stability in timing.

In Advanced mode, audio signals are exchanged between the M-1000 and the computer using 24-bit resolution, with sampling frequencies of 44.1 kHz, 48 kHz, and 96 kHz supported. Set the M-1000 to Advanced mode when using software capable of handling input and output of high-quality audio, including programs by Cakewalk, Cool Edit, and other 24-bit compatible software, and applications that support ASIO, such as Cubase VST, Logic Audio, SingerSongWriter, and Metro. You cannot play back audio data (audio CDs, alert sounds, etc.) from Macintosh's Sound Manager in Advanced mode.



ASIO:  
Steinberg Audio Stream In/  
Out Interface

## When Using Windows XP/2000 (WDM Driver/MME Driver)

The M-1000 Driver CD-ROM includes two different drivers for use with Windows XP and Windows 2000, the WDM driver and the MME driver.

You cannot have both installed; select one according to the software you are using.

### WDM Driver

Use this driver if you have SONAR or a similar application set to WDM Driver mode. This will allow you to obtain very good audio performance.

*\* 24-bit resolution is not available with Cool Edit, Media Player, and other applications that have no WDM Driver mode.*

### MME Driver

Cool Edit and similar programs that have no WDM Driver mode cannot be used with 24-bit resolution.

*\* The MME driver cannot be used with SONAR or similar applications while in WDM Driver mode.*

You cannot have both the WDM Driver and MME Driver installed at the same time. Select one, then install that driver. If after installing one of the drivers you want to change it, always be sure to delete the installed driver before installing the new driver.

→ “Deleting the Special Drivers (Uninstall)” (p. 15)

## ■ Standard Driver Mode

This mode is operational when the [ADVANCED] USB indicator is **off**.

This mode uses the standard USB drivers included with Windows and Macintosh.

In Standard Driver mode, audio signals exchanged between the M-1000 and the computer feature 16-bit resolution, with sampling frequencies of 44.1 kHz and 48 kHz supported. Set the M-1000 to this mode when using applications in which audio CDs are played back with the computer's built-in CD-ROM drive, that involve the use software synthesizers included with Windows and Macintosh, or that utilize functions specific to the Windows or Macintosh systems themselves.

*\* Drivers included with Windows and Macintosh do not support ASIO.*

*\* The use of MacOS under MacOS 9.0.4 is not supported (standard driver mode).*

### Using the M-1000 After Switching Between Advanced Mode and Standard Driver Mode

If you have both a special driver and the standard drivers installed, you can then use the M-1000's USB driver select button (the CLOCK SOURCE select button) to switch between Advanced mode and Standard Driver mode.

*\* To enable the setting, quit all applications using the M-1000, including the sequencer software, then turn the M-1000's power off, then on again.*

→ “Procedure for Changing the Settings” (p. 11)



WDM:  
Win32 Driver Model



MME:  
Microsoft Multimedia  
Extensions

## Installing the Drivers

### ■ Installation Overview

Although you can install the necessary drivers separately, to avoid the complications involved with repeating installation and switching settings, we recommend starting out by installing both the standard and special drivers.

The suggested procedure is described below.

*\* In case you are not familiar with software installation, please refer to the document on the CD-ROM included with the M-1000 for more detailed instruction.*

#### Windows

for standard driver: CD-ROM → “WinGenericDriver\_E.htm”

for special driver: CD-ROM → “Driver” folder → operating system version you are using → (“WDM”/”MME”) → “ReadMe\_E.htm”

#### Macintosh

for special driver: CD-ROM → “Driver” folder → “ReadMe” folder → “English” folder → “ReadMe\_E.htm”

for standard driver: CD-ROM → “WinGenericDriver\_E.htm”

### With Windows

1. With the M-1000 disconnected, start up your computer.

#### If the setting is not default factory setting

2. Initialize the M-1000.

3. Turn the M-1000 off temporarily.

4. Connect the M-1000 and the computer with a USB cable.
5. Turn on the M-1000.
6. Follow the instructions displayed to install the **standard drivers**. The M-1000's USB indicator lights.  
The instructions are not displayed if the drivers have already been installed; in this case, proceed to step 8.
7. Re-boot the computer.
8. Press the CLOCK SOURCE button to switch the M-1000 to Advanced mode (the light flashes).
9. Turn off the M-1000 (do not turn it on again just yet).
10. Open the folder on the included CD-ROM corresponding to the operating system version you are using, then run “Setupinf.exe” in the “Driver” folder.

11. Turn the M-1000 back on.
12. Follow the instructions displayed to install the **special driver**. The M-1000's USB and ADVANCED indicators light.
13. Go to “Start” → (“Settings” →) “Control Panels” → “Sound and Audio Device” (, “Sound and Multimedia” or “Multimedia”); specify the M-1000 (or the USB audio device) as the priority device for audio.



“WDM Driver” (p. 13)  
“MME Driver” (p. 13)



Initialize:  
Set the [SELECT] switch to the optical setting, then hold down the CLOCK SOURCE button while turning on the M-1000 (p. 18).



During the re-boot procedure, USB indicator or internal indicator (INT) of M-1000 irregularly blinks. But this is not malfunction.



Please confirm USB indicator lights after re-booting.



You can choose any sampling rate.

## With Macintosh

1. With the M-1000 disconnected, start up your computer.
2. Run “M-1000 USB Installer J” on the included CD-ROM.
3. Follow the instructions displayed to install the **special driver**.
4. Re-boot your computer.
5. Connect the M-1000 and the computer with a USB cable.
6. Turn on the M-1000. If in Advanced mode (ADVANCED indicator lit), press the CLOCK SOURCE button to switch to Standard Driver mode (ADVANCED indicator off), and turn the M-1000 off and then on again.
7. Wait five seconds for the **standard drivers** to be recognized automatically, then go to Control Panels in the Apple menu and open the “Sound” control panel. For “Input,” specify “USB Audio” (required when using the standard driver).
8. Uncheck the “Play sound through output device” option.
9. Switch the M-1000 to Advanced mode (the ADVANCED indicator should flash; turn the M-1000 off and then on again).
10. On the included CD-ROM, go to “Driver” → “ASIO” → “M-1000 ASIO1.0 16bit” and “M-1000 ASIO1.0 24bit.” Copy all of the drivers in the folder for the ASIO-supported software you will be using to the “ASIO Drivers” folder.
11. Specify “M-1000 ASIO1.0 16bit” or “M-1000 ASIO1.0 24bit” in the settings screen in each ASIO application.

### MEMO

During the re-boot procedure, USB indicator or internal indicator (INT) of M-1000 irregularly blinks. But this is not malfunction.

### MEMO

Please confirm USB indicator lits after re-booting.

### MEMO

You can choose any sampling rate.

## Deleting the Special Drivers (Uninstall)

If the special driver is not installed according to the prescribed procedure, or if there is some other problem, the computer may fail to recognize the M-1000. If this occurs, first delete then reinstall the special driver.

For the exact procedure, refer to the document on the CD-ROM included with the M-1000.

### Windows

CD-ROM → “Driver” folder → operating system version you are using → “ReadMe\_E.htm”

### Macintosh

CD-ROM → “Driver” folder → “ReadMe” folder → “English” folder → “ReadMe\_E.htm”

# Explanations

## Digital Connections

### Standards for Digital Input/Output

The M-1000 conforms to the "IEC60958," "IEC 958" (input and output using a fixed consumer format), and "EIAJ-CP-1201" (consumer format) standards for digital input and output.

### Word Clock and Sampling Frequency

When analog audio signals are converted into digital audio signals, the analog signals are sampled at extremely short intervals of time, and those samples are converted into a digital signal. The sampling frequency indicates how many times this process is performed each second. The finer the divisions of time, the more precise the conversion becomes.

In order to attain a high level of precision in the processing of digital audio signals between multiple devices, these time segments must be synchronized. The signal transmitted to achieve this is known as "word clock."

When synchronizing, all the connected devices shall be specified as Word Clock Master or Word Clock Slave (to control or to be controlled). In case you are using M-1000 as Word Clock Slave (to be controlled), you need to specify the CLOCK SOURCE. Word clock is transmitted via a different route (the [WORD CLOCK] connector) than the audio signals, and all of the devices are synchronized to a single word clock. This is used when synchronizing three or more devices.

### WORD CLOCK [75Ω] and [THRU]

#### Example of synchronizing 3 units of M-1000

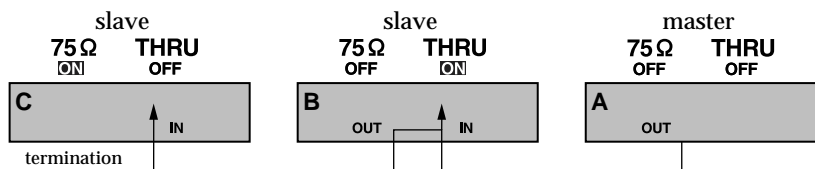

**Clock signal passes through**

The units A, B and C will be synchronized in exact timing.

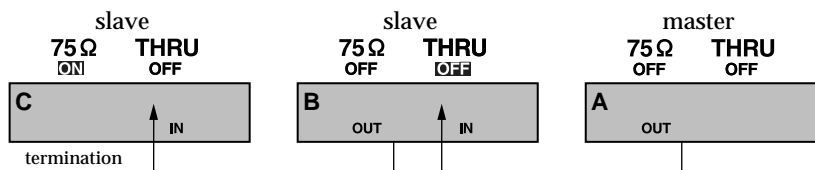

**Re-create clock signal**

The clock signal used for synchronization of B unit will come out to C unit. The lag between A-C will be greater but the decline of signal to C unit will be smaller.

#### [75Ω] ON/OFF (Termination ON/OFF)

When the M-1000 is connected as the terminus of a word clock connection, termination is used (75Ω:ON). The resistance is 75 ohms, the same as that of the word clock cable, and the signals are terminated.

If termination is not done correctly, it can disrupt the word clock signal's waveform, causing distortion and noise in the sound. You only need to terminate the last device in the chain.



IEC:  
International Electrotechnical  
Commission



EIAJ:  
Electronic Industries  
Association of Japan



The word clock signal includes a high-frequency component. When relaying such signals, a measure known as "termination" needs to be used, in order to prevent signals from being reflected by both ends of the cable.



## SRC

Normally, when transmitting digital audio signals between devices, including digital sources sent to digital mixers, the sampling frequencies (SAMPLING FREQ) of each device must be the same. If the different devices use differing rates, they must be converted to the same master rate. In addition, the clocking or timing of the clock signals of each signals of each signal must be exactly the same. This is usually achieved by having one master clock and then slaving each digital device to that one Master or Word Clock.

With the M-1000, each digital input 1--4 features its own sample rate converter (SRC). This allows you to use devices that are set to different digital clock rates and also that are not synchronized with each other by use of a master Word Clock. Each input in the M-1000 is able to receive the following rates.

- DIGITAL INPUT 1: Rate can be set to any frequency from 32 kHz to 96 kHz
- DIGITAL INPUT 2--4: Rate can be set to 32 kHz, 44.1 kHz, 48 kHz, 88.2 kHz, or 96 kHz

The appropriate sample rate conversion is performed internally in the M-1000 and the signals are all synchronized to the master clock signal according to the clock source and sample frequency settings on the M-1000. This conversion and clock synchronization is done automatically, making it very easy to mix multiple digital devices.



SRC:  
Sample Rate Converter

## SCMS

→“About SCMS” (p. 20)



SCMS:  
Serial Copy Management  
System

## Other Points

### Input Sensitivity Select Switch (SENS) and LEVEL Knobs

The input sensitivity select switch adjusts the input gain.

If the input volume level is set too low when converting an analog signal to digital, the conversion accuracy suffers. Setting the input volume too high ends up distorting the sound. Ideally, the input level prior to conversion should be as high as possible without causing distortion. First, try a high input level with the input sensitivity select switch set to [-10 dB]. If the PEAK indicator does not light, then use the signal as is. If the PEAK indicator does light, it means the sound is going to be distorted, so slide the switch to [+4 dB].

The LEVEL knobs work like channel faders on a digital recorder or similar device. These adjust the volume level for each input. These affect the signals after they are digitally converted.

### MASTER Output and MONITOR Output

Both of these channel contain the mixed output of the M-1000. Normally, the MASTER output is connected to house speakers or recording devices, and the MONITOR output is connected to headphones or monitor speakers.

Although the output to the MONITOR bus is the same as the MASTER output, changing the MONITOR output volume does not affect the volume of the MASTER output.

# Other Features

## Initializing the Settings

### ---Restoring the M-1000 to Its Original Factory Conditions

You can use the following procedure to reset the settings to the default factory condition.

1. Set the SELECT switch to OPTICAL.
2. Hold down the CLOCK SOURCE button and switch on the power to the M-1000.

This resets the settings to their factory values.

Clock Source:	INT (Internal Clock)
Internal Clock Sampling Frequency:	44.1 kHz
USB Driver Mode:	Standard Driver Mode
Sampling Frequency w/USB Connection:	44.1 kHz

## Changing the Signal Path for the Analog Output (MIX OUT)

- If the audio in the inputs is doubled in the output when using the USB connection -

The M-1000's internal signal routing incorporates a switch called [MIX OUT]. Normally, sounds input to the M-1000 are output both through the USB connection and the MASTER output, but you can change the [MIX OUT] setting to block the path from the analog input to the MASTER output.

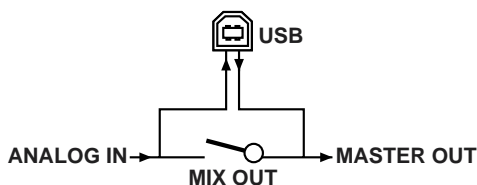

When using the M-1000 in combination with another mixer, the way the connections are made and the mixer is structured can cause sounds to be output twice. This occurs in the following cases.

When connected via USB, the [MIX OUT] setting (Connect/Disconnect) is enabled. When not connected via USB, [MIX OUT] remains connected at all times.

*\* Settings are saved even when the power is turned off.*

### Disconnecting the Path from ANALOG INPUT to MASTER OUT ([MIX OUT] off)

The analog input is transmitted only through USB.

Hold down the **SAMPLING FREQ** button for at least one second.

→The [96kHz], [48kHz], and [44.1kHz] indicators light for one second, indicating that the path from ANALOG INPUT to MASTER OUT is disconnected.

### Connecting the Path from ANALOG INPUT to MASTER OUT ([MIX OUT] on)

This is the normal setting. The analog input is sent both to the USB connector and MASTER OUT.

Hold down the **CLOCK SOURCE** button for at least one second.

→The [ADVANCE], [96kHz:fromPC], and [96kHz:toPC] indicators light for one second, indicating that the path from ANALOG INPUT to MASTER OUT is connected.

# Troubleshooting

If the M-1000 does not operate as you expect, check the problems and solutions listed below first. If this does not solve the problem, consult with your retailer, the nearest Roland Service Center, or an authorized Roland distributor, as listed on the “Information” (p. 26) page.

## **There is no sound.**

This may be due to one or more of the following.

- The digital signals being input have a sampling rate that is not compatible with the M-1000.  
→ Input signals that are compatible.
- The M-1000 is set to a sampling rate not compatible with the connected device.  
→ Select a compatible sampling rate.
- The volume or level knob on the audio device is turned down too low.  
→ Adjust to an appropriate level.
- The input sensitivity select switch is not at the right setting.  
→ Try setting this to [-10dBu].

## **The volume level of the instrument connected to [ANALOG INPUT] is too low.**

Could you be using a connection cable that contains a resistor?

→ Use a connection cable that does not contain a resistor.

## **The CLOCK SOURCE indicator is flashing.**

This indicates that synchronization with the specified clock source could not be accomplished. In this case, the M-1000 switches to using its internal clock (INT).

This may be due to one or more of the following.

- The right signals are not reaching their corresponding connectors (such as when incompatible sampling rates are used).
- The M-1000 is not properly connected to the corresponding device.

→ Check the settings for the connected device, and make sure it is connected properly.

## **When connecting via USB, the indicators showing the driver and sampling rate are flashing.**

These flash when you change USB-related settings. The flashing light indicates the “reserved” setting; when the M-1000 is turned off, then on again, that setting is enabled, and the indicator then remains lit.

→ When connecting via USB, turn the power off, then on again whenever you change the settings.

## **DIGITAL INPUT 1 is connected with a coaxial cable, but won't lock.**

Is the digital input SELECT switch on the front panel set to OPTICAL?

→ Switch to match the connection.

## **Sounds cannot be exchanged with the PC after a change in the USB settings.**

When changing settings, you need to exit all computer applications and restart the computer.

## **The volume levels for the device connected to the output connector is too low.**

Could you be using a connection cable that contains a resistor?

→ Use a connection cable that doesn't incorporate a resistor (such as one from the Roland PCS Series).

## **Installation of the driver is requested when attempting to switch to USB Advanced mode.**

If no M-1000 special driver has been installed, installation of the driver begins automatically if you try to switch to Advanced mode.

→ Follow the instructions given to install the driver.

→ You can also follow the instructions in “Initializing the Settings ---Restoring the M-1000 to Its Original Factory Conditions” (p. 18) to return to Standard Driver mode.

## **Sounds are doubled (played twice).**

→ If using USB, try the procedure in “Disconnecting the Path from ANALOG INPUT to MASTER OUT ([MIX OUT] off)” (p. 18).

# Concerning Copyright

The law prohibits the unauthorized recording, public performance, broadcast, sale, or distribution etc. of a work (CD recording, video recording, broadcast, etc.) whose copyright is owned by a third party. Roland will take no responsibility for any infringement of copyright that you may commit in using the M-1000.

## About SCMS

---

SCMS (Serial Copy Management System) is a function that protects the rights of the copyright owner by prohibiting second-generation or later copying via a digital connection to a consumer digital audio device such as a DAT recorder or MD recorder. When a recording is made via a digital connection on a digital recorder that has this function, SCMS data will be recorded along with the digital audio signal. A digital audio signal containing this SCMS data cannot be recorded again via a digital connection.

## Disclaimer of liability

---

Roland will take no responsibility for any “direct damages,” “consequential damages,” or “any other damages” which may result from your use of the M-1000. These damages may include but are not limited to the following events which can occur when using the M-1000.

- Any loss of profit that may occur to you
- Permanent loss of your music or data
- Inability to continue using the M-1000 itself or a connected device

## About the License Agreement

---

The M-1000 is designed to allow you to reproduce material to which you have copyright, or material which the copyrighted material without permission of the copyright owner avoiding technical prohibiting feature of second-generation and later copying like SCMS or others constitutes copyright infringement and may incur penalties even in case such reproduction is for your own personal use and enjoyment (private use). Consult a copyright specialist or special publications for more detailed information on obtaining such permission from copyright holders.

# Specifications

## Signal Processing

AD Conversion: 24bits,64times oversampling  
DA Conversion: 24bits,128times oversampling  
Internal Processing: 56bits  
Sampling Frequency: 96kHz,48kHz,44.1kHz

## Analog Input

Connector: 1/4 inch phone type (unbalanced)  
Input Level: -10dBu, +4dBu (switchable)  
Maximum Input Level: +22 dBu (Input Level:+4dBu)

## Digital Input

Connector: COAXIAL, OPTICAL  
Format: IEC 60958 & EIAJ CP-1201 [TYPEII/  
Consumer]  
Number of Bits: 24bits  
Sampling frequency: Digital Input 1:  
96kHz to 32kHz (variable)  
Digital Input2--4:  
96kHz, 88.2kHz, 48kHz,  
44.1kHz, 32kHz

## Analog Output

Connector: XLR-3-31 type (balanced)  
1/4 inch phone type (unbalanced)  
Output Level: +4dBu (XLR-3-31 : Master Out)  
-10dBu (1/4 inch phone : Monitor Out)

## Digital Output

Connector: COAXIAL, OPTICAL  
Format: IEC 60958 & EIAJ CP-1201 [TYPEII/  
Consumer]  
Number of Bits: 24bits

## Audio Specification

Signal-to-Noise Ratio: 102dB or less (IHF-A. typ.)  
Frequency Response: 96.0kHz: 20Hz--40kHz (+0.1 / -2.0dB)  
48.0kHz: 20Hz--22kHz (+0.1 / -2.0dB)  
44.1kHz: 20Hz--20kHz (+0.1 / -2.0dB)  
Total harmonic distortion:  
0.001% or less (Input Level: +4dBu,  
1kHz, Nominal Output)

## USB Audio

Sampling frequency: 96kHz, 48kHz, 44.1kHz  
Number of Bits: 24bits

## Word Clock Terminal

Connector: BNC  
Input Impedance: 75Ω (terminator on)  
Input Signal Level: TTL Level  
Input Signal Frequency: 96KHz, 88.2KHz, 48KHz,  
44.1KHz, 32KHz

## Indicators

PEAK, LOCK, LEVEL METER,  
CLOCK SOURCE, SAMPLE RATE

## Power Supply

AC117V, AC230V, or AC240V

## Power Consumption

10W

## Dimensions

482 (W) x 167 (D) x 44 (H) mm  
19 (W) x 6-5/8 (D) x 1-3/4 (H) inches  
EIA-1U rack mount type

## Weight

1.9kg  
4 lbs 4 oz

## Accessories

Owners Manual  
Driver CD-ROM (Windows/Macintosh)  
AC Cord  
USB Cable  
Rubber feet

(0 dBu = 0.775 Vrms)

\* In the interest of product improvement, the specifications and/or appearance of this unit are subject to change without prior notice.

**M-1000 BLOCK DIAGRAM**

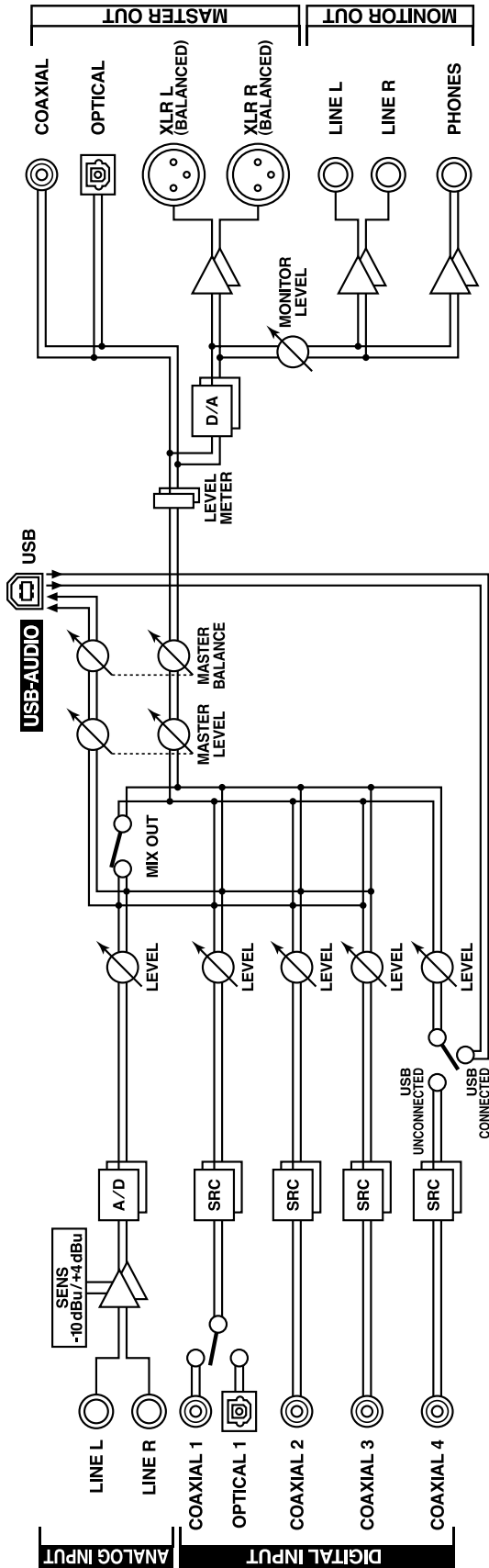

# Index

## Numerics

75Ω ..... 16

## A

ADVANCED ..... 12

Advanced Mode ..... 12

ASIO ..... 12

audio CD ..... 13

## B

block diagram ..... 22

## C

CD-ROM drive ..... 13

Changing the Settings ..... 11

Clock Source ..... 16

Computer ..... 10

Copyright ..... 20

## D

Digital Connections ..... 16

Driver ..... 12, 14

## E

EIAJ ..... 16

## F

flashing ..... 19

Functions and Operation of Each Section ..... 8

## G

gain ..... 17

## I

IEC ..... 16

Indicator ..... 11

Input Sensitivity Select Switch ..... 17

Installing ..... 14

## L

LEVEL Knobs ..... 17

## M

Master ..... 16

MASTER Output ..... 17

Matching the Sampling Frequency ..... 11

Mixing ..... 9

MME ..... 13

MONITOR Output ..... 17

## O

Operation ..... 8

## P

PEAK indicator ..... 17

phases ..... 7

pin assignment ..... 7

Power ..... 8

## R

reserved ..... 11

resolution ..... 12

## S

sample rate converter ..... 7, 17

Sampling Frequency ..... 16

SCMS ..... 20

SENS ..... 17

Signal Path ..... 18

Slave ..... 16

Sound Manager ..... 12

SRC ..... 17

Standard Driver Mode ..... 13

Standards for Digital Input/Output ..... 16

synchronized ..... 16

## T

Termination ..... 16

THRU ..... 16

Turning Off the Power ..... 8

Turning On the Power ..... 8

## U

Uninstall ..... 15

USB ..... 10, 12

USB Audio ..... 12

## W

WDM ..... 13

Word Clock ..... 16

Word Clock Master ..... 16

Word Clock Slave ..... 16

## X

XLR type connectors ..... 7

memo





# Information

When you need repair service, call your nearest Roland Service Center or authorized Roland distributor in your country as shown below.

## AFRICA

### EGYPT

**Al Fanny Trading Office**  
9, EBN Hagar A1 Askalany Street,  
ARD El Golf, Heliopolis,  
Cairo 11341, EGYPT  
TEL: 20-2-417-1828

### REUNION

**Maison FO - YAM Marcel**  
25 Rue Jules Hermann,  
Chaudron - BP79 97 491  
Ste Clotilde Cedex,  
REUNION ISLAND  
TEL: (0262) 218-429

### SOUTH AFRICA

**That Other Music Shop  
(PTY) Ltd.**  
11 Melle St., Braamfontein,  
Johannesbourg, SOUTH AFRICA

P.O.Box 32918, Braamfontein 2017  
Johannesbourg, SOUTH AFRICA  
TEL: (011) 403 4105

**Paul Bothner (PTY) Ltd.**  
17 Werdmuller Centre,  
Main Road, Claremont 7708  
SOUTH AFRICA

P.O.Box 23032, Claremont 7735,  
SOUTH AFRICA  
TEL: (021) 674 4030

## ASIA

### CHINA

**Roland Shanghai Electronics  
Co.,Ltd.**  
5F. No.1500 Pingliang Road  
Shanghai, CHINA  
TEL: (021) 5580-0800

**Roland Shanghai Electronics  
Co.,Ltd.  
(BEIJING OFFICE)**  
10F. No.18 Anhuaxili  
Chaoyang District, Beijing,  
CHINA  
TEL: (010) 6426-5050

### HONG KONG

**Tom Lee Music Co., Ltd.  
Service Division**  
22-32 Pun Shan Street, Tsuen  
Wan, New Territories,  
HONG KONG  
TEL: 2415 0911

### INDIA

**Rivera Digitec (India) Pvt. Ltd.**  
409, Nirman Kendra Mahalaxmi  
Flats Compound Off. Dr. Edwin  
Moses Road, Mumbai-400011,  
INDIA  
TEL: (022) 493 9051

### INDONESIA

**PT Citra IntiRama**  
Jl. Cideng Timur No. 15J-150  
Jakarta Pusat  
INDONESIA  
TEL: (021) 6324170

### KOREA

**Cosmos Corporation**  
1461-9, Seocho-Dong,  
Seocho Ku, Seoul, KOREA  
TEL: (02) 3486-8855

### MALAYSIA

**BENTLEY MUSIC SDN BHD**  
140 & 142, Jalan Bukit Bintang  
55100 Kuala Lumpur, MALAYSIA  
TEL: (03) 2144-3333

### PHILIPPINES

**G.A. Yupangco & Co. Inc.**  
339 Gil J. Puyat Avenue  
Makati, Metro Manila 1200,  
PHILIPPINES  
TEL: (02) 899 9801

### SINGAPORE

**Swee Lee Company**  
150 Sims Drive,  
SINGAPORE 387381  
TEL: 6846-3676

### CRISTOFORI MUSIC PTE LTD

Blk 3014, Bedok Industrial Park E,  
#02-2148, SINGAPORE 489980  
TEL: 6243-9555

### TAIWAN

**ROLAND TAIWAN  
ENTERPRISE CO., LTD.**  
Room 5, 9fl. No. 112 Chung Shan  
N.Road Sec.2, Taipei, TAIWAN,  
R.O.C.  
TEL: (02) 2561 3339

### THAILAND

**Theera Musik Co., Ltd.**  
330 Vergn NakornKasem, Soi 2,  
Bangkok 10100, THAILAND  
TEL: (02) 2248821

### VIETNAM

**Saigon Music**  
138 Tran Quang Khai St.,  
District 1  
Ho Chi Minh City  
VIETNAM  
TEL: (08) 844-4068

## AUSTRALIA/ NEW ZEALAND

### AUSTRALIA

**Roland Corporation  
Australia Pty., Ltd.**  
38 Campbell Avenue  
Dee Why West, NSW 2099  
AUSTRALIA  
TEL: (02) 9982 8266

### NEW ZEALAND

**Roland Corporation Ltd.**  
32 Shaddock Street, Mount Eden,  
Auckland, NEW ZEALAND  
TEL: (09) 3098 715

## CENTRAL/LATIN AMERICA

### ARGENTINA

**Instrumentos Musicales S.A.**  
Av.Santa Fe 2055  
(1123) Buenos Aires  
ARGENTINA  
TEL: (011) 4508-2700

### BRAZIL

**Roland Brasil Ltda**  
Rua San Jose, 780 Sala B  
Parque Industrial San Jose  
Cotia - Sao Paulo - SP, BRAZIL  
TEL: (011) 4615 5666

### COSTA RICA

**JUAN BANSBACH  
Instrumentos Musicales**  
Ave.1. Calle 11, Apartado 10237,  
San Jose, COSTA RICA  
TEL: 258-0211

### CHILE

**Comercial Fancy II S.A.**  
Rut.: 96.919.420-1  
Nataliel Cox #739, 4th Floor  
Santiago - Centro, CHILE  
TEL: (02) 688-9540

### EL SALVADOR

**OMNI MUSIC**  
75 Avenida Norte y Final  
Alameda Juan Pablo II,  
Edificio No.4010 San Salvador,  
EL SALVADOR  
TEL: 262-0788

### MEXICO

**Casa Veerkamp, s.a. de c.v.**  
Av. Toluca No. 323, Col. Olivar  
de los Padres 01780 Mexico D.F.  
MEXICO  
TEL: (55) 5668-6699

### PANAMA

**SUPRO MUNDIAL, S.A.**  
Boulevard Andrews, Albrook,  
Panama City, REP. DE PANAMA  
TEL: 315-0101

### PARAGUAY

**Distribuidora De  
Instrumentos Musicales**  
J.E. Olear y ESQ. Manduvira  
Asuncion PARAGUAY  
TEL: (021) 492-124

### URUGUAY

**Todo Musica S.A.**  
Francisco Acuna de Figueroa 1771  
C.P.: 11.800  
Montevideo, URUGUAY  
TEL: (02) 924-2335

### VENEZUELA

**Musicaland Digital C.A.**  
Av. Francisco de Miranda,  
Centro Parque de Cristal, Nivel  
C2 Local 20 Caracas  
VENEZUELA  
TEL: (212) 285-8586

## EUROPE

### AUSTRIA

**Roland Austria GES.M.B.H.**  
Siemensstrasse 4, P.O. Box 74,  
A-6063 RUM, AUSTRIA  
TEL: (0512) 26 44 260

### BELGIUM/HOLLAND/ LUXEMBOURG

**Roland Benelux N. V.**  
Houtstraat 3, B-2260, Oevel  
(Westerlo) BELGIUM  
TEL: (014) 575811

### DENMARK

**Roland Scandinavia A/S**  
Nordhavnsvej 7, Postbox 880,  
DK-2100 Copenhagen  
DENMARK  
TEL: (039) 16 6200

### FRANCE

**Roland France SA**  
4, Rue Paul Henri SPAAK,  
Parc de l'Esplanade, F 77 462 St.  
Thibault, Lagny Cedex FRANCE  
TEL: 01 600 73 500

### FINLAND

**Roland Scandinavia As,  
Filial Finland**  
Lauttasareentie 5 B  
Fin-00201 Helsinki, FINLAND  
TEL: (9) 682 4020

### GERMANY

**Roland Elektronische  
Musikinstrumente HmbH.**  
Oststrasse 96, 22844 Norderstedt,  
GERMANY  
TEL: (040) 52 60090

### GREECE

**STOLLAS S.A.  
Music Sound Light**  
155, New National Road  
Patras 26442, GREECE  
TEL: (061) 043-5400

### HUNGARY

**Roland East Europe Ltd.**  
Warehouse Area 'DEPO' Pf.83  
H-2046 Torokbalint, HUNGARY  
TEL: (23) 511011

### IRELAND

**Roland Ireland**  
Audio House, Belmont Court,  
Donnybrook, Dublin 4,  
Republic of IRELAND  
TEL: (01) 2603501

### ITALY

**Roland Italy S. p. A.**  
Viale delle Industrie 8,  
20020 Arese, Milano, ITALY  
TEL: (02) 937-78300

### NORWAY

**Roland Scandinavia Avd.  
Kontor Norge**  
Lilleakerveien 2 Postboks 95  
Lilleaker N-0216 Oslo  
NORWAY  
TEL: 273 0074

### POLAND

**P. P. H. Brzostowicz**  
UL. Gibraltarska 4,  
PL-03664 Warszawa POLAND  
TEL: (022) 679 44 19

### PORTUGAL

**Tecnologias Musica e Audio,  
Roland Portugal, S.A.**  
Cais Das Pedras, 8/9-1 Dto  
4050-465 PORTO  
PORTUGAL  
TEL: (022) 608 00 60

### ROMANIA

**FBS LINES**  
Piata Libertatii 1,  
RO-4200 Gheorgheni  
TEL: (095) 169-5043

### RUSSIA

**MuTek**  
3-Bogatyrskaya Str. 1.k.1  
107 564 Moscow, RUSSIA  
TEL: (095) 169 5043

### SPAIN

**Roland Electronics  
de España, S. A.**  
Calle Bolivia 239, 08020  
Barcelona, SPAIN  
TEL: (93) 308 1000

### SWEDEN

**Roland Scandinavia A/S  
SWEDISH SALES OFFICE**  
Danvik Center 28, 2 tr.  
S-131 30 Nacka SWEDEN  
TEL: (08) 702 0020

### SWITZERLAND

**Roland (Switzerland) AG**  
Landstrasse 5, Postfach,  
CH-4452 Itingen,  
SWITZERLAND  
TEL: (061) 927-8383

### UKRAINE

**TIC-TAC**  
Mira Str. 19/108  
P.O. Box 180  
295400 Munkachevo, UKRAINE  
TEL: (03131) 414-40

### UNITED KINGDOM

**Roland (U.K.) Ltd.**  
Atlantic Close, Swansea  
Enterprise Park, SWANSEA  
SA7 9EF,  
UNITED KINGDOM  
TEL: (01792) 700139

## MIDDLE EAST

### BAHRAIN

**Moon Stores**  
No.16, Bab Al Bahrain Avenue,  
P.O.Box 247, Manama 304,  
State of BAHRAIN  
TEL: 211 005

### CYPRUS

**Radex Sound Equipment Ltd.**  
17, Diagorou Street, Nicosia,  
CYPRUS  
TEL: (022) 66-9426

### IRAN

**MOCO, INC.**  
No.41 Nike St., Dr.Shariyati Ave.,  
Roberoye Ceraha Mirdamad  
Tehran, IRAN  
TEL: (021) 285-4169

### ISRAEL

**Halilit P. Greenspoon &  
Sons Ltd.**  
8 Retzif Ha'aliya Hashnya St.  
Tel-Aviv-Yafo ISRAEL  
TEL: (03) 6823666

### JORDAN

**AMMAN Trading Agency**  
245 Prince Mohammad St.,  
Amman 1118, JORDAN  
TEL: (06) 464-1200

### KUWAIT

**Easa Husain Al Yousifi Est.**  
Abdullah Salem Street,  
Safat, KUWAIT  
TEL: 243-6399

### LEBANON

**Chahine S.A.L.**  
Gerge Zeidan St., Chahine Bldg.,  
Achrafieh, P.O.Box: 16-5857  
Beirut, LEBANON  
TEL: (01) 20-1441

### QATAR

**Al Emadi Co. (Badie Studio  
& Stores)**  
P.O. Box 62,  
Doha, QATAR  
TEL: 4423-554

### SAUDI ARABIA

**aDawlah Universal  
Electronics APL**  
Corniche Road, Aldossary Bldg.,  
1st Floor, Alkhobar,  
SAUDI ARABIA

P.O.Box 2154, Alkhobar 31952  
SAUDI ARABIA  
TEL: (03) 898 2081

### SYRIA

**Technical Light & Sound  
Center**  
Khaled Ebn Al Walid St.  
Bldg. No. 47, P.O.Box: 13520,  
Damascus, SYRIA  
TEL: (011) 223-5384

### TURKEY

**Barkat muzik aletleri ithalat  
ve ihracat Ltd Sti**  
Siraselvililer Caddesi Siraselvililer  
Pasajı No:74/20  
Taksim - Istanbul, TURKEY  
TEL: (0212) 2499324

### U.A.E.

**Zak Electronics & Musical  
Instruments Co. L.L.C.**  
Zabeel Road, Al Sherooq Bldg.,  
No. 14, Grand Floor, Dubai, U.A.E.  
TEL: (04) 3360715

## NORTH AMERICA

### CANADA

**Roland Canada Music Ltd.  
(Head Office)**  
5480 Parkwood Way Richmond  
B. C., V6V 2M4 CANADA  
TEL: (604) 270 6626

### Roland Canada Music Ltd. (Toronto Office)

170 Admiral Boulevard  
Mississauga On L5T 2N6  
CANADA  
TEL: (905) 362 9707

### U. S. A.

**Roland Corporation U.S.**  
5100 S. Eastern Avenue  
Los Angeles, CA 90040-2938,  
U. S. A.  
TEL: (323) 890 3700

As of August 1, 2002 (Roland)

For EU Countries



This product complies with the requirements of European Directives EMC 89/336/EEC and LVD 73/23/EEC.

For the USA

## FEDERAL COMMUNICATIONS COMMISSION RADIO FREQUENCY INTERFERENCE STATEMENT

This equipment has been tested and found to comply with the limits for a Class B digital device, pursuant to Part 15 of the FCC Rules. These limits are designed to provide reasonable protection against harmful interference in a residential installation. This equipment generates, uses, and can radiate radio frequency energy and, if not installed and used in accordance with the instructions, may cause harmful interference to radio communications. However, there is no guarantee that interference will not occur in a particular installation. If this equipment does cause harmful interference to radio or television reception, which can be determined by turning the equipment off and on, the user is encouraged to try to correct the interference by one or more of the following measures:

- Reorient or relocate the receiving antenna.
- Increase the separation between the equipment and receiver.
- Connect the equipment into an outlet on a circuit different from that to which the receiver is connected.
- Consult the dealer or an experienced radio/TV technician for help.

This device complies with Part 15 of the FCC Rules. Operation is subject to the following two conditions:

- (1) This device may not cause harmful interference, and
- (2) This device must accept any interference received, including interference that may cause undesired operation.

Unauthorized changes or modification to this system can void the users authority to operate this equipment.  
This equipment requires shielded interface cables in order to meet FCC class B Limit.

For Canada

### NOTICE

This Class B digital apparatus meets all requirements of the Canadian Interference-Causing Equipment Regulations.

### AVIS

Cet appareil numérique de la classe B respecte toutes les exigences du Règlement sur le matériel brouilleur du Canada.



## **Caution: About Digital Audio Input/Output**

The Digital IN connectors of M-1000 are compatible with 2ch PCM audio only. In case M-1000 receives audio signal in other formats (DTS, Dolby Surround etc.), it outputs such signal as noise.

M-1000 does not have any multi-channel digital audio encoding function such as the DTS format. And do not input DTS signals or any other this kind of signals to the digital input on M-1000. If you input DTS signals to the digital input on M-1000, they cannot be decoded into multi-channel signals. Please use an external encode/decode device.

---