

### Owner's Manual

Before using this unit, carefully read the sections entitled: "USING THE UNIT SAFELY" and "IMPORTANT NOTES" (Owner's Manual p. 2, 3, 9). These sections provide important information concerning the proper operation of the unit. Additionally, in order to feel assured that you have gained a good grasp of every feature provided by your new unit, Quick Start and Owner's Manual should be read in its entirety. The manuals should be saved and kept on hand as a convenient reference.

This owner's manual consists of the following 14 chapters and supplementary information. Before you read this manual, you should read through the Quick Start manual so you're familiar with the basic operation of the unit.

<b>Chapter 1</b>	<b>An Overview of the JX-305</b>	<b>1</b>
	This chapter explains how the JX-305's sound generator and sequencer are organized, and explains the basic operation. By reading this chapter, you can gain an overall understanding of the JX-305.	
<b>Chapter 2</b>	<b>Playing the Keyboard</b>	<b>2</b>
	This chapter explains the Key Mode function, the pitch bend lever, the pedals, etc., and how to use the arpeggiator. Be sure to read this chapter.	
<b>Chapter 3</b>	<b>Playing Patterns</b>	<b>3</b>
	This chapter explains how to play patterns, and how to use functions such as Real-Time Transpose, Mute, Part Mixer, and Play Quantize. Be sure to read this chapter.	
<b>Chapter 4</b>	<b>One-Touch Phrase Playback (RPS)</b>	<b>4</b>
	This chapter explains the various effect types and how to use them. Read this chapter when you wish to use effects.	
<b>Chapter 5</b>	<b>Creating Original Sounds (Patch Edit)</b>	<b>5</b>
	This chapter explains the parameters that modify the sound. Read this chapter so you better understand how to use the knobs to control the sound when creating your own sounds.	
<b>Chapter 6</b>	<b>Creating an Original Rhythm Set (Rhythm Editing)</b>	<b>6</b>
	This chapter explains the rhythm set parameters. Read this chapter when you wish to create an original rhythm set.	
<b>Chapter 7</b>	<b>Applying Effects to the Sound (Effects)</b>	<b>7</b>
	This chapter explains the various effect types and how to use them. Read this chapter when you wish to use effects.	
<b>Chapter 8</b>	<b>Recording Patterns</b>	<b>8</b>
	This chapter explains how to record patterns. Read this chapter when you wish to record patterns.	
<b>Chapter 9</b>	<b>Editing Patterns</b>	<b>9</b>
	This chapter explains how to edit patterns, and how to modify music data after it's been recorded. Read this chapter as necessary.	
<b>Chapter 10</b>	<b>Keeping Frequently Used Patterns Together (Pattern Set)</b>	<b>10</b>
	This chapter explains how to use Pattern Sets and how to store patterns in a set. Read this chapter when you wish to use a pattern set.	
<b>Chapter 11</b>	<b>Placing Patterns in Playback Order to Create a Song</b>	<b>11</b>
	This chapter explains how to play back, record, and edit songs. Be sure to read this chapter if you wish to use songs.	
<b>Chapter 12</b>	<b>Using Memory Cards</b>	<b>12</b>
	Here you can learn how to use memory cards to back up your data, and how to make copies of a card. Be sure to read this chapter before using memory cards.	
<b>Chapter 13</b>	<b>Setting the Operating Environment of the JX-305 (System)</b>	<b>13</b>
	This chapter explains settings that determine the overall configuration for your JX-305, such as its tuning and synchronization preferences. Read this chapter as necessary.	
<b>Chapter 14</b>	<b>Advanced Applications</b>	<b>14</b>
	This chapter explains how the JX-305 can be used with external MIDI equipment, and gives tips for creating sounds and performing. Read this chapter as necessary.	
	<b>Supplementary Information</b>	
	Consult this chapter when the JX-305 does not function as you expect, or if an error message is displayed. This chapter also contains information such as parameter lists and the MIDI implementation.	

- SmartMedia is a trademark of Toshiba corporation.
- All product names mentioned in this document are trademarks or registered trademarks of their respective owners.

# USING THE UNIT SAFELY

## INSTRUCTIONS FOR THE PREVENTION OF FIRE, ELECTRIC SHOCK, OR INJURY TO PERSONS

### About ⚠ WARNING and ⚠ CAUTION Notices

<b>⚠ WARNING</b>	Used for instructions intended to alert the user to the risk of death or severe injury should the unit be used improperly.
<b>⚠ CAUTION</b>	Used for instructions intended to alert the user to the risk of injury or material damage should the unit be used improperly. * Material damage refers to damage or other adverse effects caused with respect to the home and all its furnishings, as well to domestic animals or pets.

### About the Symbols

	The ⚠ symbol alerts the user to important instructions or warnings. The specific meaning of the symbol is determined by the design contained within the triangle. In the case of the symbol at left, it is used for general cautions, warnings, or alerts to danger.
	The ⓧ symbol alerts the user to items that must never be carried out (are forbidden). The specific thing that must not be done is indicated by the design contained within the circle. In the case of the symbol at left, it means that the unit must never be disassembled.
	The ● symbol alerts the user to things that must be carried out. The specific thing that must be done is indicated by the design contained within the circle. In the case of the symbol at left, it means that the power-cord plug must be unplugged from the outlet.

## ALWAYS OBSERVE THE FOLLOWING

### ⚠ WARNING

- Before using this unit, make sure to read the instructions below, and the Owner's Manual.
- Do not open (or modify in any way) the unit or its AC adaptor.
- Do not attempt to repair the unit, or replace parts within it (except when this manual provides specific instructions directing you to do so). Refer all servicing to your retailer, the nearest Roland Service Center, or an authorized Roland distributor, as listed on the "Information" page.
- Never use or store the unit in places that are:
  - Subject to temperature extremes (e.g., direct sunlight in an enclosed vehicle, near a heating duct, on top of heat-generating equipment); or are
  - Damp (e.g., baths, washrooms, on wet floors); or are
  - Humid; or are
  - Dusty; or are
  - Subject to high levels of vibration.
- This unit should be used only with a rack or stand that is recommended by Roland.
- When using the unit with a rack or stand recommended by Roland, the rack or stand must be carefully placed so it is level and sure to remain stable. If not using a rack or stand, you still need to make sure that any location you choose for placing the unit provides a level surface that will properly support the unit, and keep it from wobbling.

### ⚠ WARNING

- Be sure to use only the AC adaptor supplied with the unit. Also, make sure the line voltage at the installation matches the input voltage specified on the AC adaptor's body. Other AC adaptors may use a different polarity, or be designed for a different voltage, so their use could result in damage, malfunction, or electric shock.
- Avoid damaging the power cord. Do not bend it excessively, step on it, place heavy objects on it, etc. A damaged cord can easily become a shock or fire hazard. Never use a power cord after it has been damaged.
- This unit, either alone or in combination with an amplifier and headphones or speakers, may be capable of producing sound levels that could cause permanent hearing loss. Do not operate for a long period of time at a high volume level, or at a level that is uncomfortable. If you experience any hearing loss or ringing in the ears, you should immediately stop using the unit, and consult an audiologist.
- Do not allow any objects (e.g., flammable material, coins, pins); or liquids of any kind (water, soft drinks, etc.) to penetrate the unit.

**⚠ WARNING**

- Immediately turn the power off, remove the AC adaptor from the outlet, and request servicing by your retailer, the nearest Roland Service Center, or an authorized Roland distributor, as listed on the "Information" page when:
  - The AC adaptor or the power-supply cord has been damaged; or
  - Objects have fallen into, or liquid has been spilled onto the unit; or
  - The unit has been exposed to rain (or otherwise has become wet); or
  - The unit does not appear to operate normally or exhibits a marked change in performance.
- In households with small children, an adult should provide supervision until the child is capable of following all the rules essential for the safe operation of the unit.
- Protect the unit from strong impact. (Do not drop it!)
- Do not force the unit's power-supply cord to share an outlet with an unreasonable number of other devices. Be especially careful when using extension cords—the total power used by all devices you have connected to the extension cord's outlet must never exceed the power rating (watts/amperes) for the extension cord. Excessive loads can cause the insulation on the cord to heat up and eventually melt through.
- Before using the unit in a foreign country, consult with your retailer, the nearest Roland Service Center, or an authorized Roland distributor, as listed on the "Information" page.

**⚠ CAUTION**

- The unit and the AC adaptor should be located so their location or position does not interfere with their proper ventilation.
- Always grasp only the plug or the body of the AC adaptor when plugging into, or unplugging from, an outlet or this unit.
- Whenever the unit is to remain unused for an extended period of time, disconnect the AC adaptor.
- Try to prevent cords and cables from becoming entangled. Also, all cords and cables should be placed so they are out of the reach of children.
- Never climb on top of, nor place heavy objects on the unit.
- Never handle the AC adaptor body, or its plugs, with wet hands when plugging into, or unplugging from, an outlet or this unit.
- Before moving the unit, disconnect the AC adaptor and all cords coming from external devices.
- Before cleaning the unit, turn off the power and unplug the AC adaptor from the outlet (Quick Start, p. 5).
- Whenever you suspect the possibility of lightning in your area, disconnect the AC adaptor from the outlet.

# Contents

<b>Features of the JX-305 .....</b>	<b>8</b>
<b>Important Notes.....</b>	<b>9</b>
<b>Front and Rear Panels.....</b>	<b>10</b>

## **Chapter 1. an Overview of the JX-305 ..... 13**

How the JX-305 Is Organized .....	13	About Memory .....	15
How the Sound Generator Is Organized .....	13	Basic Operation.....	16
How the Sequencer Is Organized.....	14		

## **Chapter 2. Playing the Keyboard ..... 18**

Selecting a Patch .....	18	Changing the Keyboard Dynamics (Keyboard Velocity) .....	22
Playing Two Patches from the Keyboard (Key Mode) .....	18	Sustaining the Notes You Play (Hold Pedal) .....	23
Playing One Patch Over the Entire Keyboard (Single).....	18	Using a Pedal to Modify the Sound (Control Pedal) .....	23
Layering Two Patches (Dual).....	19	Control Pedal Settings .....	23
Playing Different Patches with the Left and Right Hands (Split).....	19	Pressing Chords to Produce Arpeggios (Arpeggiator) .....	24
Changing the Split Point.....	20	Playing Arpeggios.....	24
Selecting the Upper Part/Lower Part.....	20	Creating an Arpeggio Pattern .....	24
Modifying the Key Mode Settings in the Editing Pages	20	Changing the Way in Which the Arpeggio Will Play (Arpeggio Style) .....	25
Smoothly Changing the Pitch of the Sound (Portamento) .....	21	Adding Expression to the Arpeggio (Accent Rate).....	25
Portamento On/Off .....	21	Changing the Pitch Range of the Arpeggio (Octave Range) .....	26
Changing the Time Over Which the Pitch Changes (Portamento Time) .....	21	Selecting the Part in Dual Mode Which Will Play the Arpeggio (Arpeggio Destination).....	26
Playing Notes Which Lie Outside the Range of the Keyboard (Octave Shift).....	21	Making More Detailed Settings .....	26
Changing the Pitch (Pitch Bend Lever) .....	22	Saving Arpeggio Settings (Arpeggio Write) .....	28
Applying Modulation to the Sound .....	22	Playing a Rhythm Set .....	28
Using the Modulation Lever .....	22	Listening to Sound Processed by the Effects (Audition).....	29
Using Aftertouch.....	22		

## **Chapter 3. Playing Patterns ..... 30**

Playing Patterns .....	30	Returning a Pattern to Its Original State During Playback (Pattern Reset).....	39
Adjusting the Tempo.....	31	Ensuring Correct Playback from the Middle of a Pattern .. (MIDI Update) .....	40
Viewing the Number of Measures in a Pattern .....	31	Changing the Groove of a Pattern (Play Quantize) ..40	
Muting a Specific Part (Part Mute/Rhythm Mute).....	32	Selecting Parts to Use with Play Quantize .....	41
Transposing During Playback		Correcting Inaccuracies in the Rhythm (Grid Quantize) 41	
(Real-Time Transpose) .....	32	Giving Swing to the Rhythm (Shuffle Quantize) .....	42
Using the VALUE Dial or [INC] [DEC].....	32	Giving a Groove to the Rhythm (Groove Quantize).....	43
Using the Keyboard.....	33	Using Pedal for Control (Switch Pedal) .....	46
Changing the Settings of Each Part.....	33	Specifying the Function of the Switch Pedal.....	46
Using the Part Mixer Page to Make Changes .....	33	Using the Pedal to Change the Tempo .....	46
Using the Editing Pages to Make Changes .....	34	Simultaneously Changing the Tempo and Pitch (Turntable) .....	47
Saving Patterns You've Modified (Pattern Write) ....	36		
Copying and Initializing Settings.....	37		
Using the Knobs to Modify the Sound During Playback (Real-Time Modify).....	38		
Modifying the Sound for an Individual Rhythm Group.	39		



## **Chapter 4. One-Touch Phrase Playback (RPS).....48**

<b>Pressing Notes to Play Back Phrases .....</b>	<b>48</b>	<b>Making Settings for Each Phrase .....</b>	<b>50</b>
Causing a Phrase to Continue Playing (RPS Hold).....	49	Using the Part Mixer to Modify Settings.....	50
<b>Assigning Phrases to the Keyboard .....</b>	<b>49</b>	Changing the Patch of Each RPS Part .....	51
		<b>Saving the Phrases You Assigned (RPS Set Write)...</b>	<b>52</b>

## **Chapter 5. Creating Original Sounds (Patch Edit).....53**

<b>The Basis for the Sound of a Patch (Tones).....</b>	<b>53</b>	<b>Making More Detailed Settings .....</b>	<b>68</b>
What a Tone Consists of.....	53	<b>Applying Cyclic Changes to the Sound (LFO) .....</b>	<b>71</b>
<b>Sound-Editing Procedure.....</b>	<b>53</b>	Selecting the Waveform That Will Modulate the Sound (LFO1 Waveform) .....	72
<b>Changing the Basic Waveform of the Sound (Wave/FXM) .....</b>	<b>56</b>	Adjusting the Speed of Modulation (LFO1 Rate).....	72
<b>Pitch-Related Settings .....</b>	<b>57</b>	Adjusting the Depth of Modulation (LFO1 Depth) .....	73
Modifying the Pitch (Pitch).....	57	Making More Detailed Settings .....	74
Making the Pitch Change Over Time (Pitch Envelope) ..	58	<b>Specifying the Parameters That Will Be Modified by Each Controller (Control) .....</b>	<b>76</b>
Making More Detailed Settings .....	59	Adjusting the Range of Pitch Bend (Bend Range).....	76
<b>Brightness-Related Settings (Filter).....</b>	<b>61</b>	Control 1/2/3/4 (Control Destination 1/2/3/4).....	77
Modifying the Brightness of the Sound (Filter).....	61	Ctrl 1/2/3/4 Depth (Control 1/2/3/4 Depth).....	77
Making the Brightness Change Over Time (Filter Envelope) .....	63	<b>Settings Common to the Entire Patch (Common) .....</b>	<b>77</b>
Making More Detailed Settings .....	65	Smoothly Changing the Pitch (Portamento) .....	77
<b>Settings Related to Volume and Pan (Amplifier) .....</b>	<b>67</b>	Making More Detailed Settings .....	78
Adjusting the Volume and Pan.....	67	<b>Saving Patches You've Created (Patch Write) .....</b>	<b>82</b>
Creating Time-Variable Change in Volume (Amplifier Envelope).....	68	Copying and Initializing Settings .....	83

## **Chapter 6. Creating an Original Rhythm Set (Rhythm Edit) .....85**

<b>How a Rhythm Tone Is Organized .....</b>	<b>85</b>	<b>Making More Detailed Settings .....</b>	<b>92</b>
<b>Creating the Sounds.....</b>	<b>85</b>	<b>Settings Related to Volume and Pan (Amplifier) .....</b>	<b>94</b>
<b>Specifying the Basic Waveform of the Sound (Wave) .....</b>	<b>86</b>	Adjusting the Volume and Pan (Amplifier).....	94
<b>Pitch-Related Settings .....</b>	<b>87</b>	Creating Time-Varying Change in Volume (Amplifier Envelope) .....	95
Changing the Pitch of the Sound (Pitch) .....	87	Making More Detailed Settings .....	96
Making the Pitch Change Over Time (Pitch Envelope) ..	87	<b>Adjusting the Range of Pitch Bend (Bend Range)....</b>	<b>97</b>
Making More Detailed Settings .....	89	<b>Adjusting the Effects for Each Rhythm Tone (Rhythm Tone) .....</b>	<b>97</b>
<b>Brightness-Related Settings (Filter).....</b>	<b>90</b>	<b>Saving Rhythm Sets You've Created (Rhythm Set Write) .....</b>	<b>98</b>
Modifying the Brightness of the Sound (Filter) .....	90	Copying and Initializing Settings .....	99
Making the Brightness Change Over Time (Filter Envelope).....	91		

## **Chapter 7. Applying Effects to the Sound (Effects) ..... 101**

<b>Turning Effects On/Off .....</b>	<b>101</b>	<b>Making More Detailed Settings .....</b>	<b>105</b>
<b>Adding Reverberation to the Sound (Reverb).....</b>	<b>102</b>	<b>Applying Various Effects to the Sound (Multi-Effects) 106</b>	
Adjusting the Overall Reverb Volume (Reverb Level)..	102	Selecting the Type (Multi-Effects Type).....	106
Adjusting the Reverb Volume for Each Part (Part Reverb Level) .....	102	Adjusting the Overall Multi-Effects Volume (Multi-Effects Output Level) .....	106
Making More Detailed Settings .....	103	Making Multi-Effects Settings.....	107
<b>Adding an Echo to the Sound (Delay).....</b>	<b>103</b>	Specifying the Part(s) to Which Multi-Effects Will Be Applied (Part Multi-Effects Switch) .....	124
Adjusting the Overall Delay Volume (Delay Level).....	104		
Adjusting the Delay Volume for Each Part (Part Delay Level) .....	104		

## **Chapter 8. Recording Patterns ..... 125**

<b>Recording Your Playing As You Perform (Real-Time Recording) .....</b>	<b>125</b>	<b>Recording Notes One at a Time (Step Recording) ..</b>	<b>131</b>
Recording Procedure .....	125	Recording Procedure .....	131
Auditioning Phrases During Recording (Rehearsal Function) .....	127	Recording Notes One by One (Step Recording 1) .....	132
Recording an Arpeggio Performance.....	127	Various Ways to Input Notes .....	133
Recording Knob Movements (Modify Data).....	128	Recording Individual Notes to Grid Locations (Step Recording 2).....	134
Recording Smoothly Across Pattern Boundaries .....	128	Inputting Complex Rhythms.....	136
Recording Part Mixer Operations .....	128	<b>Checking the Remaining Amount of Memory (Memory Information).....</b>	<b>137</b>
Recording the Mute Settings .....	129	Temp (Temporary).....	137
Recording Changes in Tempo.....	129	User (User Memory) .....	137
Erasing Unwanted Data While You Record (Real-Time Erase) .....	130	Card (Card Memory) .....	137

## **Chapter 9. Editing Patterns ..... 138**

<b>Editing the Musical Data of a Specified Part (Pattern Edit).....</b>	<b>138</b>	Using Play Quantize Settings to Modify a Pattern (Edit Quantize) .....	146
Copying a Portion of a Pattern (Copy) .....	138	<b>Individually Editing Musical Data (Microscope Edit).....</b>	<b>146</b>
Deleting Unwanted Measures (Delete Measure) .....	140	View the Musical Data That You Input .....	147
Inserting Blank Measures (Insert Measure) .....	140	Musical Data Handled in Microscope Mode .....	147
Erasing Unwanted Data (Erase).....	141	Modifying the Value of Musical Data (Change Event) .....	148
Transposing the Pitch (Transpose) .....	142	Deleting Musical Data (Delete Event).....	150
Modifying the Strength of Notes (Change Velocity) .....	142	Inserting Musical Data (Insert Event) .....	150
Modifying the Note Length (Change Gate Time) .....	143	Moving Musical Data (Move Event) .....	151
Shifting the Timing Slightly (Shift Clock) .....	144	Hiding Unwanted Musical Data (View Filter) .....	151
Thinning Out Unneeded Data (Data Thin) .....	145		
Converting the Note Timing of a Pattern (Reclock).....	145		

## **Chapter 10. Collecting Frequently Used Patterns in a Set (Pattern Set) 152**

<b>Using a Pattern Set to Recall Patterns .....</b>	<b>152</b>	<b>Saving a Pattern Set That Was Modified (Pattern Set Write) .....</b>	<b>153</b>
<b>Assigning a Pattern to be Recalled .....</b>	<b>152</b>		

## **Chapter 11. Connecting Patterns in Playback Order to Create a Song. 154**

<b>Playing Back a Song.....</b>	<b>154</b>	Deleting Unwanted Patterns from a Song (Delete Pattern).....	156
<b>Recording a Song.....</b>	<b>155</b>	Inserting a Pattern (Insert Pattern) .....	157
<b>Editing Songs (Song Edit).....</b>	<b>155</b>	<b>Saving a Song That You Recorded (Song Write).....</b>	<b>157</b>
Copying a Song (Song Copy) .....	156	Initializing Settings (Song Initialize) .....	158

## **Chapter 12. Using Memory Cards ..... 159**

<b>Cautions When Using a Memory Card .....</b>	<b>159</b>	<b>Restoring the Saved Settings Back to Internal Memory (Backup Load) .....</b>	<b>161</b>
<b>Before Using a New Card (Format) .....</b>	<b>159</b>	<b>Deleting the Backup File from the Card (Backup Delete).....</b>	<b>161</b>
<b>Saving All Internal Settings to a Card (User Backup) .....</b>	<b>160</b>	<b>Copying an Entire Card (Card Duplicate) .....</b>	<b>161</b>

## Chapter 13. Setting the Operating Environment of the JX-305 (System).163

<b>Controller-Related Settings</b> .....163	
Changing the Loudness of Notes Played on the Keyboard (Keyboard Velocity).....163	
Setting Aftertouch Sensitivity (Aftertouch Sens).....163	
Specifying How the Pedal Will Function.....163	
<b>MIDI-Related Settings</b> .....164	
Disconnecting the Keyboard from the Internal Sound Generator (Local Switch).....165	
Using an External MIDI Keyboard in Place of the Keyboard of the JX-305 (Remote Keyboard Switch).....165	
Differentiating Between Units of the Identical Model (Device ID Number).....165	
Re-Transmitting Messages Received at MIDI IN from MIDI OUT (Thru Function).....165	
Specifying the Reception Status for Each Part (Rx Switch).....165	
Specifying How Knob Data Is Transmitted (Edit Transmit/Receive Mode).....165	
Reception Settings for Each Type of Message.....166	
Transmission Settings for Each Type of Message.....166	
<b>Sequencer-Related Settings</b> .....166	
Synchronization Settings (Sync Mode).....167	
Transmitting Synchronization Messages (Sync Out).....167	
Making Songs Play Continuously (Loop Mode).....167	
Setting the Metronome (Metronome Mode).....167	
Adjusting the Metronome Volume (Metronome Level).....167	
Specifying the Timing for RPS Playback (RPS Trigger Quantize).....167	
Synchronizing Arpeggios to the Pattern (Arpeggio Sync).....168	
Calculating a Checksum Automatically (Auto Checksum).....168	
Specifying the Resolution of the Tap Tempo (Tap Resolution).....168	
<b>Tuning and Sound Generator Related Settings</b> .....168	
Adjusting the Display Contrast (LCD Contrast).....168	
Adjusting the Overall Tuning (Master Tune).....168	
Tuning Each Note (Scale Tune).....168	
Specifying How Patches Will Be Switched (Patch Remain).....169	
Specifying the Number of Notes for Each Part (Voice Reserve).....169	
Specifying the Variable Range of Resonance (Resonance Limiter).....169	
Specifying the Pattern at Power-On (Default Pattern).....169	
Specifying the Arpeggio Style at Power-On (Default Arpeggio Style).....170	
<b>Restoring the Factory Settings (Factory Preset)</b> .....170	

## Chapter 14. Advanced Applications.....171

<b>Taking Advantage of MIDI</b> .....171	
What Is MIDI?.....171	
Controlling the JX-305 from an External MIDI Device.....172	
Controlling an External MIDI Device from the JX-305.....174	
Synchronizing an External Sequencer.....175	
Synchronizing to an External Sequencer.....175	
Saving Pattern and Patch Data on an External Sequencer (Bulk Dump).....176	
<b>Example of Real-Time Modify</b> .....178	
<b>Example of Multi-Effects Settings</b> .....180	
<b>Troubleshooting</b> .....183	
<b>Error Message List</b> .....185	
<b>Waveform List</b> .....187	
<b>Preset Patch List</b> .....190	
<b>Preset Rhythm Set List</b> .....195	
<b>Effects Template List</b> .....203	
<b>Preset Pattern List</b> .....204	
<b>RPS Pattern List</b> .....210	
<b>RPS Set List</b> .....219	
<b>Parameter List</b> .....223	
<b>Transmit/Receive Setting List</b> .....235	
<b>MIDI Implementation</b> .....236	
<b>Main Specifications</b> .....256	
<b>Index</b> .....257	

# Features of the JX-305

## High-performance synthesis engine

The all-important sound generator is a high-performance synthesizer offering 64-note polyphony. A rich array of parameters, including sharp filters and ADSR envelopes can be modified using the knobs on the panel to create your own sounds. The sound generator can also be used as a multitimbral sound module, providing up to eight parts.

## Cutting-edge patterns that lead the scene

The JX-305 contains 274 high-quality preset patterns for immediate use and 494 RPS patterns. Since the patterns cover a wide range, from techno to reggae, this instrument provides everything you need for most situations.

## Sounds that match today's trends

The diverse assortment of carefully selected sounds and rhythm sets ranges from those from the TB-303, JUNO, JUPITER and TR-808/909—indispensable for the dance scene—to realistic acoustic sounds. From the day you take the JX-305 home, you can enjoy today's leading-edge sounds.

You can also create your own original sounds and store them in memory for immediate recall at any time.

## Three sophisticated digital effect units

High-performance DSP (digital signal processing) technology provides you with a wide range of effects. Three effect units are provided: Reverb adds reverberation, Delay adds echo-like effects, and general-purpose effect unit provides 24 types of effect that have been optimized for dance music.

## Three key modes

The JX-305 provides three key modes: single, dual, and split. It's easy to divide the keyboard into left and right zones, which can play different sounds simultaneously, or you can layer two sounds for every note.

## A sequencer to help your ideas take shape

You can construct a song in real time as you play, simply by switching the playback patterns. During recording, you can switch the recording part to record non-stop.

The JX-305's internal memory by itself can contain approximately 75,000 notes (up to 200 patterns). By using a memory card (SmartMedia), the capacity can be boosted to a maximum of approximately 480,000 notes (up to 200 patterns).

## Use the arpeggiator to create phrases

You can play arpeggios simply by pressing the keyboard. Your musical imagination and taste are all you need to create completely new phrases.

## RPS (Real-Time Phrase Sequence) function

You can play back phrases simply by pressing a single key. This has a wide variety of uses, such as adding accents during a song, or playing an entire song using just RPS.

## Play quantize changes the groove in real time

The JX-305 provides three types of play quantize: Grid, Shuffle and Groove. Simply by rotating a knob, you can produce your own "groove" in real time.

## Controls for live performance

The JX-305 is designed for live performance, with features such as a mute button that lets you instantly silence the playback of a specific part or rhythm instrument, and a Real-Time Transpose function that lets you transpose during pattern playback. Of course, you can also move knobs during pattern playback to modify the sound in real time.

# Important Notes

In addition to the items listed under "USING THE UNIT SAFELY" on page 2, please read and observe the following:

## Power Supply

- Do not use this unit on the same power circuit with any device that will generate line noise (such as an electric motor or variable lighting system).
- The AC adaptor will begin to generate heat after long hours of consecutive use. This is normal, and is not a cause for concern.
- Before connecting this unit to other devices, turn off the power to all units. This will help prevent malfunctions and/or damage to speakers or other devices.

## Placement

- Using the unit near power amplifiers (or other equipment containing large power transformers) may induce hum. To alleviate the problem, change the orientation of this unit; or move it farther away from the source of interference.
- This device may interfere with radio and television reception. Do not use this device in the vicinity of such receivers.
- Do not expose the unit to direct sunlight, place it near devices that radiate heat, leave it inside an enclosed vehicle, or otherwise subject it to temperature extremes. Excessive heat can deform or discolor the unit.

## Maintenance

- For everyday cleaning wipe the unit with a soft, dry cloth or one that has been slightly dampened with water. To remove stubborn dirt, use a cloth impregnated with a mild, non-abrasive detergent. Afterwards, be sure to wipe the unit thoroughly with a soft, dry cloth.
- Never use benzine, thinners, alcohol or solvents of any kind, to avoid the possibility of discoloration and/or deformation.

## Repairs and Data

- Please be aware that all data contained in the unit's memory may be lost when the unit is sent for repairs. Important data should always be backed up on a memory card, another MIDI device (e.g., a sequencer), or written down on paper (when possible). During repairs, due care is taken to avoid the loss of data. However, in certain cases (such as when circuitry related to memory itself is out of order), we regret that it may not be possible to restore the data, and Roland assumes no liability concerning such loss of data.

## Additional Precautions

- Please be aware that the contents of memory can be irretrievably lost as a result of a malfunction, or the improper operation of the unit. To protect yourself against the risk of losing important data, we recommend that you periodically save a backup copy of important data you have stored in the unit's memory on a memory card or another MIDI device (e.g., a sequencer).

- Unfortunately, it may be impossible to restore the contents of data that was stored in the unit's memory, a memory card or another MIDI device (e.g., a sequencer) once it has been lost. Roland Corporation assumes no liability concerning such loss of data.
- Use a reasonable amount of care when using the unit's buttons, sliders, or other controls; and when using its jacks and connectors. Rough handling can lead to malfunctions.
- Never strike or apply strong pressure to the display.
- When connecting/disconnecting all cables, grasp the connector itself—never pull on the cable. This way you will avoid causing shorts, or damage to the cable's internal elements.
- To avoid disturbing your neighbors, try to keep the unit's volume at reasonable levels. You may prefer to use headphones, so you do not need to be concerned about those around you (especially when it is late at night).
- When you need to transport the unit, package it in the box (including padding) that it came in, if possible. Otherwise, you will need to use equivalent packaging materials.

.....

The sounds, phrases and patterns contained in this product are sound recordings protected by copyright. Roland hereby grants to purchasers of this product the permission to utilize the sound recordings contained in this product for the creation and recording of original musical works; provided however, the sound recordings contained in this product may not be sampled, downloaded or otherwise re-recorded, in whole or in part, for any other purpose, including but not limited to the transmission of all or any part of the sound recordings via the internet or other digital or analog means of transmission, and/or the manufacture, for sale or otherwise, of any collection of sampled sounds, phrases or patterns, on CD-ROM or equivalent means.

The sound recordings contained in this product are the original works of Roland Corporation. Roland is not responsible for the use of the sound recordings contained in this product, and assumes no liability for any infringement of any copyright of any third party arising out of use of the sounds, phrases and patterns in this product.

## Important

Please observe the following points when using the JX-305. Various types of data required for the JX-305's operation are held in internal flash memory. If the power is turned off while data is being written to flash memory, writing will not be completed correctly, and subsequent operation can be affected.

While the following display appears, never turn off the power or remove the memory card.

Processing...  
Keep Power ON !

.....

# Front and Rear Panels

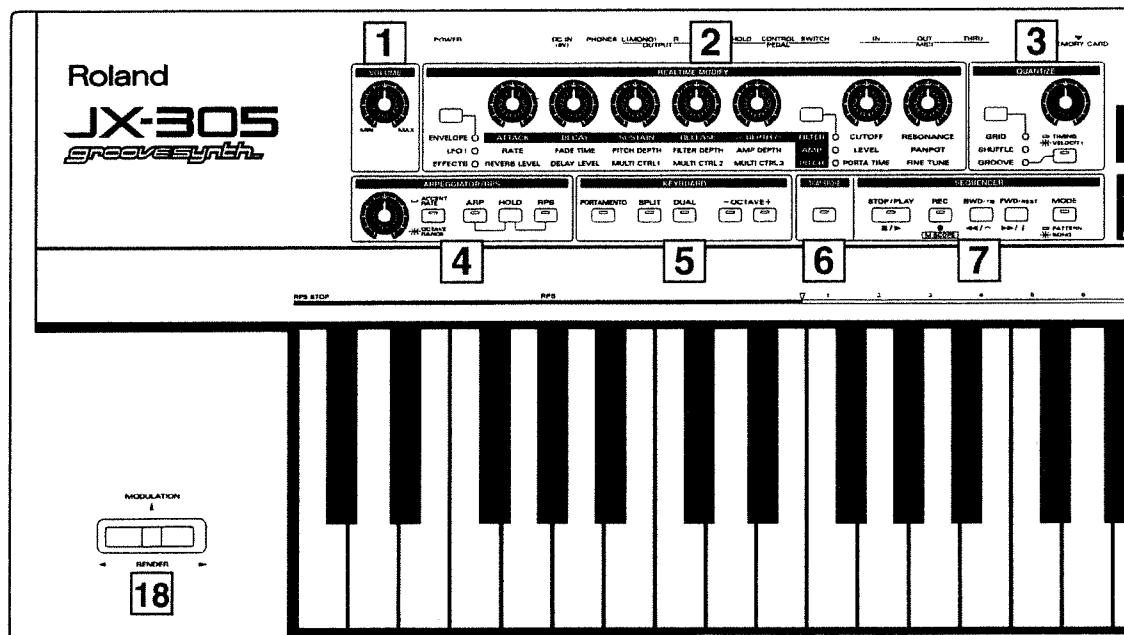

## Front Panel

### 1 VOLUME Knob

Controls the overall volume of the JX-305.

### 2 REALTIME MODIFY Section

Here you can make settings for sound parameters (p. 54) and effects (p. 101). Also, in the Part Mixer page you can make various settings for each part (p. 33).

### 3 QUANTIZE Section

Modifies the groove of the pattern (p. 40).

### 4 ARPEGGIATOR/RPS Section

Here you can make arpeggiator (p. 24)/RPS settings (p. 48).

### 5 KEYBOARD Section

Here you can make settings which affect the notes played on the keyboard, such as Key Mode (p. 18), Octave Shift (p. 21), and Portamento (p. 21).

### 6 TRANSPOSE Button

Press this button when you wish to transpose (p. 32).

### 7 SEQUENCER Section

Here are the buttons related to sequencer playback (p. 30) and recording (p. 125).

### 8 DISPLAY Section

The parameter you wish to modify using [INC] [DEC] or the [VALUE] dial appears in the display.

### 9 INC/DEC (Increment/Decrement) Buttons VALUE Dial

Use these to modify the value of a parameter (p. 16).

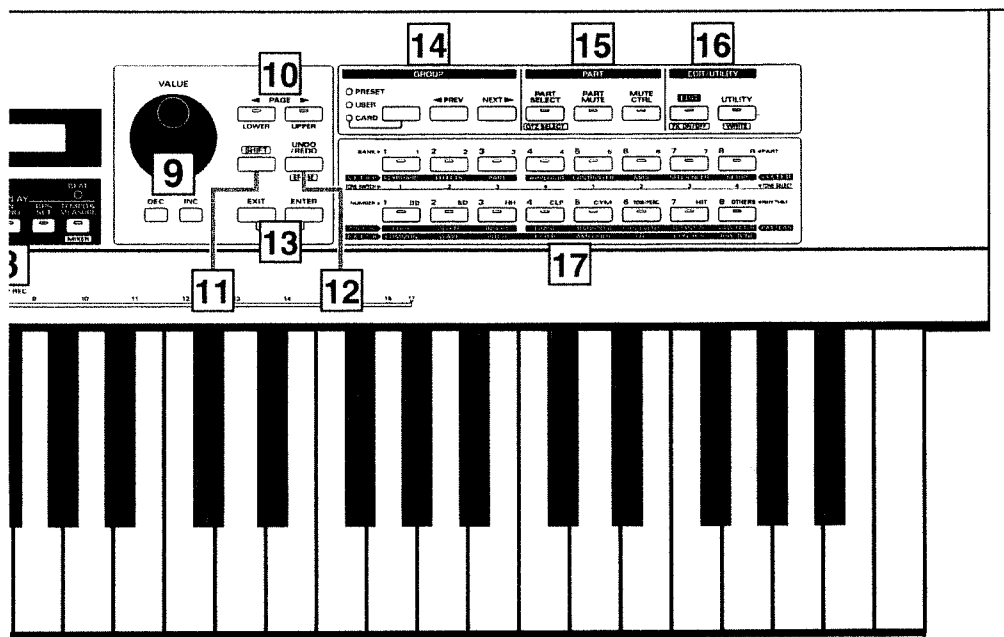

### 10 PAGE</PAGE> Buttons

Use these buttons to switch between levels of the various setting displays. In pages where you are assigning a name, these buttons move the cursor.

### 11 SHIFT Button

This button is used in conjunction with other buttons.

### 12 UNDO/REDO Button

Press this button to cancel the previous operation (p. 17).

### 13 ENTER/EXIT Buttons

Use these buttons to execute/cancel an operation, or to exit from a setting page.

### 14 GROUP Section

Here you can select the group for sounds or patterns (p. 18, 30).

### 15 PART Section

Press these buttons when you wish to use buttons 1– 8 to select or mute parts (p. 18, 32).

### 16 EDIT/UTILITY Section

Press these buttons when you wish to edit a sound or pattern, or to store or initialize settings.

### 17 1–8 Buttons

Use these buttons to select the bank and number of a patch or pattern (p. 18), to select parts or rhythm groups, or to switch muting on/off (p. 32). When editing, these buttons are used to select parameters.

### 18 Pitch Bend Lever/Modulation Lever

This lever lets you modify the pitch or apply vibrato. Depending on the settings, this can also be used to control specific parameters (p. 22, 47).

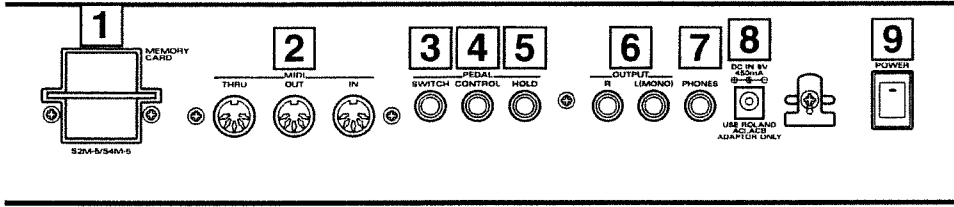

## Rear panel

### 1 MEMORY CARD Slot

An optional memory card (SmartMedia) can be inserted here (p. 159).

### 2 MIDI IN/OUT/THRU Connectors

External MIDI devices can be connected here (p. 171). Use MIDI cables (sold separately) to make connections.

### 3 SWITCH PEDAL Jack

A separately sold pedal switch or foot switch can be connected here. The pedal can be operated to apply various effects (p. 46).

### 4 CONTROL PEDAL Jack

A separately sold expression pedal can be connected here. The pedal can be operated to adjust the volume or to make the sound change in various ways (p. 23).

### 5 HOLD PEDAL Jack

A separately sold pedal switch can be connected here. The pedal can be used to sustain notes (p. 23).

### 6 OUTPUT JACKS (L (MONO), R)

An amp or mixer can be connected to these jacks. If outputting in mono, make connections to the L jack (Quick Start, p. 3).

### 7 PHONES Jack

Accepts connection of headphones. Audio signals will still be output from the output jacks even if headphones are connected (Quick Start, p. 3).

### 8 DC IN Jack

Connect the included AC adapter here (Quick Start, p. 3).

### 9 POWER Switch

This switch turns the power on/off (Quick Start, p. 5).



# Chapter 1. an Overview of the JX-305

A brief explanation of the JX-305's internal organization was provided in the Quick Start manual, but this chapter contains a more detailed explanation of the basic sections: the controller section, sound generating section, and the sequencer section.

## How the JX-305 Is Organized

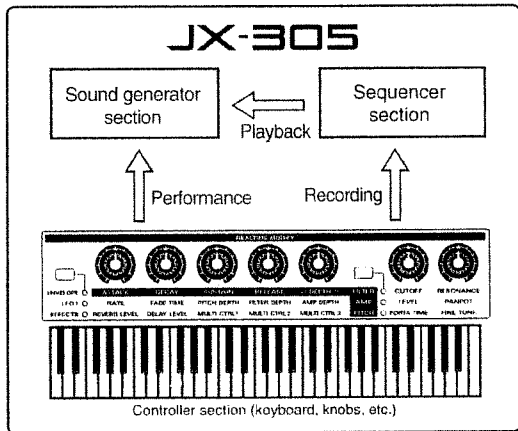

## Playing and Operation—Controller

Controllers refer collectively to the keyboard, the panel knobs, the pitch bend lever, and the pedal connected to the rear panel etc. By operating these controllers you can play sounds or modify them.

## Recording Your Performance—Sequencer

The sequencer can record your playing and controller operations (knob movements) as MIDI messages, and can play back the MIDI messages that were recorded. MIDI messages that have been recorded on the sequencer can also be transmitted from the MIDI OUT connector, and used to control external MIDI devices.

## Producing the Sound—Sound Generator

This is the section that produces the sound. The sound generator produces sound in response to data it receives from the JX-305's controllers and its sequencer. It can also be played by MIDI messages that arrive from an external MIDI device.

## How the Sound Generator Is Organized

### The Smallest Unit of Sound—Tones

Tones are the smallest unit of sound used by the JX-305. Although it is possible to create a sound using only one Tone, the sounds you will normally play on the JX-305 are "Patches," which consist of one or more Tones.

### Sounds That You Play—Patches

Patches are the unit of sound that you normally play. Each Patch consists of up to four Tones. Tones and Patches are organized as follows.

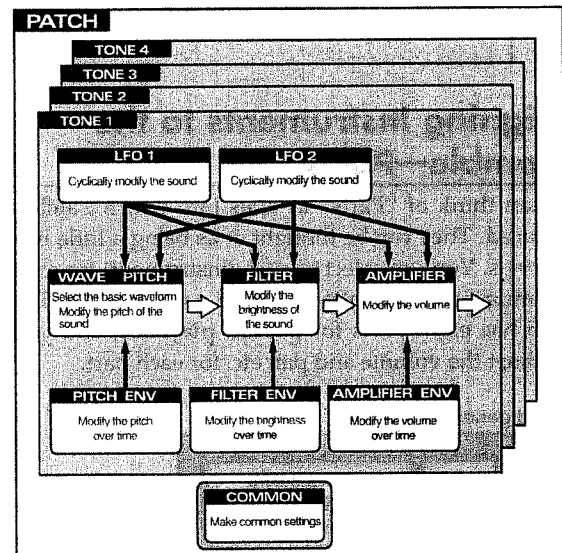

\* The way in which the four tones are combined will determine how they will sound. This is determined by the Structure Type parameter.

☞ "Settings Common to the Entire Patch (Common)" (p. 77)

## Playing Percussion Instruments—Rhythm Sets

A collection of various percussion instruments (rhythm tones) is referred to as a Rhythm Set. A different rhythm tone can be assigned to each key (note number), allowing you to use a large number of rhythm tones at once.

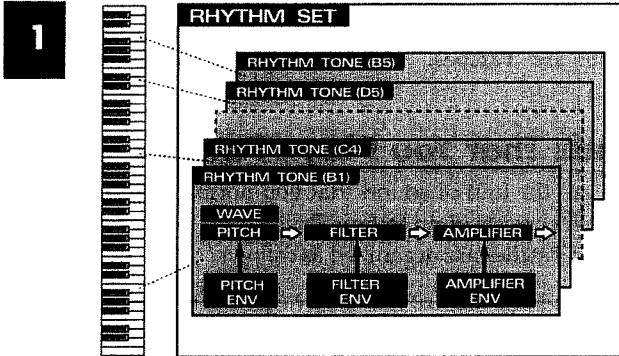

## Assigning Instruments to the Ensemble—Parts

You can think of “Parts” as slots into which Patches are placed. They can be thought of as being a little like musicians. You can select a patch (instrument) for each part (musician), and play multiple parts at once. The JX-305 has eight parts for pattern playback, and you can adjust the volume and pan etc. for each part.

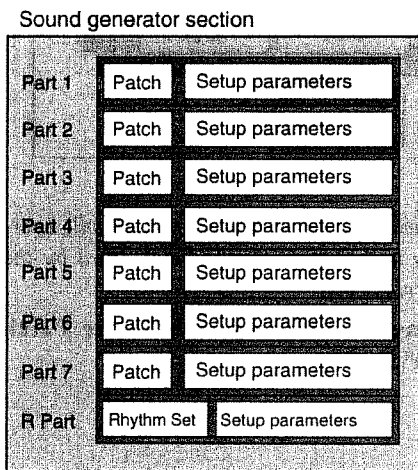

### Parts 1-7

For each of these parts, you can select a patch and play melodic, bass or chordal instruments. Since it is also possible to select an individual rhythm tone, you can also use one of these parts as an auxiliary rhythm part.

### Rhythm part

For this part, you can select a rhythm set and play percussion instrument sounds.

### About simultaneous polyphony

The JX-305 is able to play up to 64 notes simultaneously. If the incoming musical data requests more than 64 notes simultaneously, some notes will drop out. When using patches with a long release time or when using RPS, be careful not to exceed the maximum simultaneous polyphony. The number of notes that can be sounded will actually depend not only on the number of notes being played, but also on the number of tones that are used by each patch.

For example, if you are playing a patch that uses four tones, that patch will take up four times the number of notes that are played.

If you would like to know about the polyphony settings...

- The Voice Priority parameter can be set for each patch to specify how notes will be turned off when the maximum polyphony is exceeded.
  - ☞ “Settings Common to the Entire Patch (Common)” (p. 77)
- The Voice Reserve parameter can be set to specify a minimum number of notes that will be reserved for each part.
  - ☞ “Specifying the Number of Notes for Each Part (Voice Reserve)” (p. 169)

## How the Sequencer Is Organized

The sequencer records your performance and controller operations as musical data. Playing back the sequencer will cause this recorded musical data to be sent to the sound generator, making it produce sound. In other words, the sequencer plays the instrument instead of the musician.

In the sense that it records and plays back a performance, a sequencer is similar to a tape recorder. However, it has unique advantages: the tempo can be modified without affecting the pitch, there is no decrease in sound quality no matter how many times you play something back, and extremely detailed edits can be made at will.

## Musical Data Played Back by the Sequencer—Patterns

Patterns are musical data of various genres for the sequencer to play back, and can be selected even while they play back. The data within each pattern is divided into parts, and you can record or play back each part separately, or modify the musical data inside each part. For each pattern, you can also specify things such as the patch, volume and effect settings that will be used by each part.

You can save the data in the condition that will be most appropriate, and change the settings as a whole simply by changing the pattern. These settings can also be used when you play the keyboard directly.

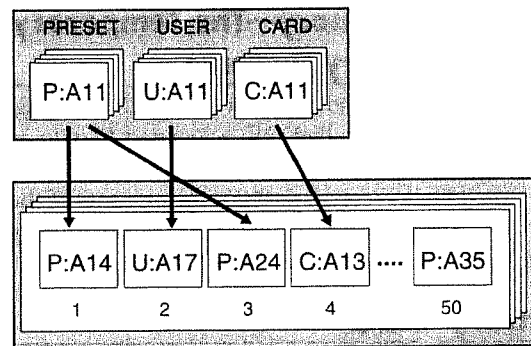
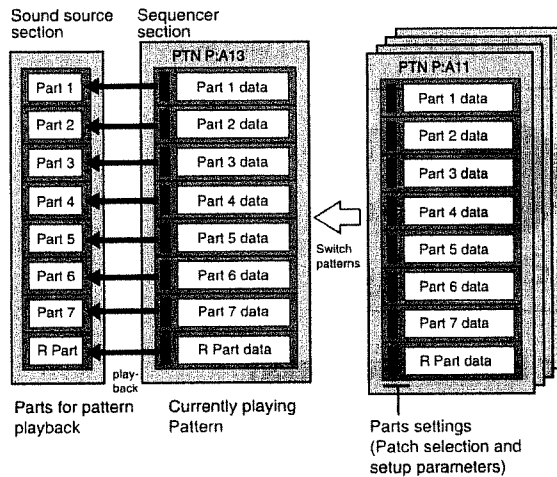

1

There are two types of patterns: "Preset Patterns" which are already built into the JX-305, and "User Patterns" which can contain patterns that you create.

### Collecting Frequently Used Patterns—Pattern Sets

A Pattern Set lets you collect frequently used patterns so that they can be recalled instantly. Sixteen patterns can be registered in each pattern set.

Pattern set example

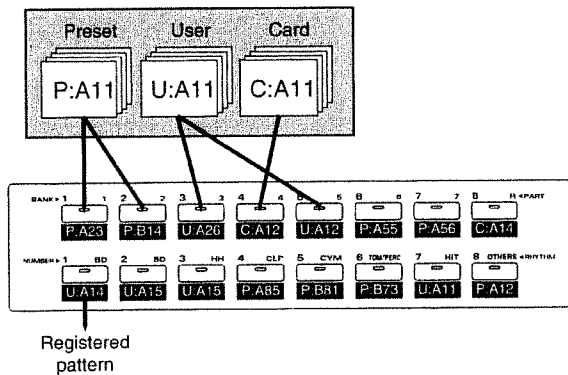

### Arranging Patterns in Playback Order—Songs

A sequential arrangement of two or more patterns is called a "song." When you play back a song, the patterns in the song will play back in succession. A song can contain up to 50 patterns.

## About Memory

"Memory" refers to the place where patch settings and musical data for patterns and other things are kept. The memory of the JX-305 is divided into three areas: System Memory, User Memory, and Preset Memory. There is also a "temporary area" within memory, into which data is placed when you select a patch or pattern, and the data in the temporary area is what you are actually playing and editing.

### Memory for Settings That Affect the Entire JX-305—System Memory

System Memory contains settings for the system parameters that configure the JX-305. These include parameters that determine the overall operation of the sound generator or sequencer, and MIDI-related settings.

### Rewritable Memory—User Memory

The contents of User Memory can be overwritten, and are used to store settings or musical data that you create. User Memory stores 256 patches, 200 patterns, 50 songs, 60 RPS sets, and 30 pattern sets.

\* At the factory settings, the User Patches and the User Patterns have the same contents as Preset Memory.

### Non-Rewritable Memory—Preset Memory

The contents of Preset Memory cannot be rewritten. Preset Memory contains 640 patches and 768 patterns.

## Temporary Memory—The Temporary Area (Temporary Pattern)

When you play a sound or select a patch for editing, the selected patch is called into a location known as the “temporary area.”

When you edit or record a pattern, the contents of the pattern are automatically copied to TMP (temporary pattern), and your operations will affect this data.

1

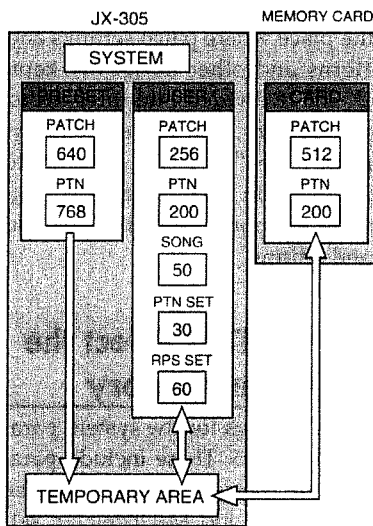

## Memory Card

An optional memory card can be used to store 512 User Patches and 200 User Patterns, just as in the user memory of the JX-305.



\* The data in memory will be preserved even if the power is turned off, and can be recalled at any time. However, the data in the temporary area will be lost when the power is turned off.

When you modify the settings of a patch or the contents of a pattern, you are actually modifying the data that was called into the temporary area or the temporary pattern. (In other words, you are not directly modifying the data in memory.) If you wish to keep the changes that you have made to the patch or pattern, you must save the data as a user patch or user pattern.

-  "Saving Patches You've Created (Patch Write)" (p. 82)
-  "Saving Patterns You've Modified (Pattern Write)" (p. 36)

## Basic Operation

### Modifying a Value

To select a patch or pattern, or to modify a parameter value, use the VALUE dial or the INC/DEC buttons.

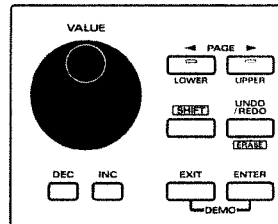

### INC button/DEC button

To increase a value press [INC]. To decrease a value press [DEC].

If you continue pressing the button, the value will continue to change.

If you press one button while holding down the other button, the value will change rapidly.

If you hold down [SHIFT] and press a button, the value will change in larger steps.

### VALUE dial

To increase a value, rotate the [VALUE] dial clockwise. To decrease a value, rotate the [VALUE] dial counterclockwise.

If you hold down [SHIFT] as you rotate the [VALUE] dial, the value will change in larger steps.

## Canceling the Previous Operation (Undo/Redo)

The function which lets a modified parameter value or edited musical data to be restored to its previous state is called Undo. The function which returns the parameter value or musical data from its "Undone" state back to the edited state is called Redo.

The JX-305 lets you use undo/redo for the following operations. This is convenient when you wish to cancel a change, or to compare your edits with the original data.

-  **Pattern Edit** ⇨ "Editing the Musical Data of a Specified Part (Pattern Edit)" (p. 138)
- Song Edit** ⇨ "Editing Songs (Song Edit)" (p. 155)
- Pattern Recording** ⇨ "Recording Patterns" (p. 125)
- Song Recording** ⇨ "Recording a Song" (p. 155)

**1. Make sure that the pattern or song select page is displayed.**

**2. Press [UNDO/REDO].**

The following display will appear.

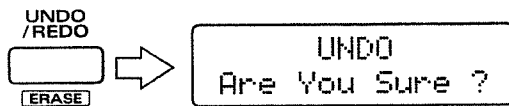

**3. Press [ENTER], and your changes will be "undone," restoring the value to its unmodified state.**

**4. Press [UNDO/REDO] once again.**

The following display will appear.

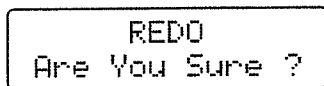

**5. Press [ENTER], and your changes will be "redone," returning the value to its edited state.**

*\* Undo/Redo operations must be done immediately after you modify the data. Once you save the modified pattern, the undo/redo operation will no longer be available. Also, if you use a different operation to make a further change to the data, it will no longer be possible to undo/redo to the change that was made first.*

When you execute an operation that modifies a large amount of data, such as during pattern editing, the Undo operation may not be available.

# Chapter 2. Playing the Keyboard

## Selecting a Patch

The JX-305 contains a total of 640 different patches. By specifying the group, bank, and number, you can select the desired patch and play it on the keyboard.

### 1. Press [PART SELECT].

The indicator lights.

### 2. Use PART [1]-[R] to select the part that you wish to play on the keyboard.

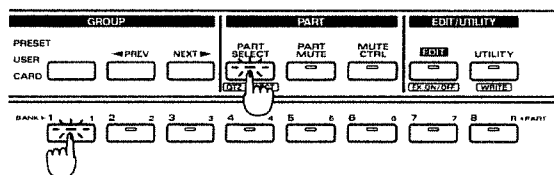

The currently selected part is referred to as the “current part.”

If the current part is a part 1-7 you can select patches. If the current part is the rhythm part, you can select rhythm sets.

[“Playing a Rhythm Set” \(p. 28\)](#)

### 3. In the DISPLAY section, press [PATCH].

The indicator lights, and the display will show the group, bank, number and name of the currently selected patch (rhythm set).

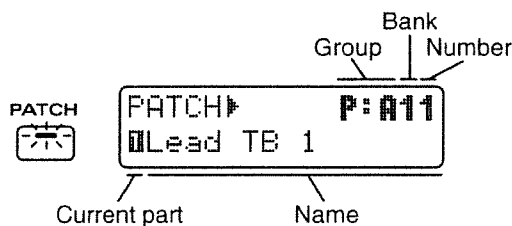

### 4. In the GROUP section, press [PRESET/USER/CARD] to select the group.

Patch groups are organized as follows.

PRESET-> P: A-J (Preset Group)

USER-> U: A-D (User Group)

CARD-> C: A-H (Card Group)

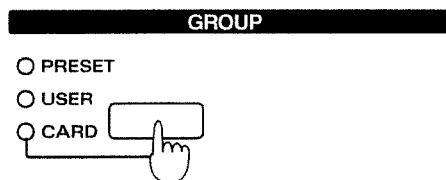

\* The card group cannot be selected unless a separately sold memory card is inserted.

[“Using Memory Cards” \(p. 159\)](#)

### 5. In the GROUP section, use [< PREV] [NEXT >] to select the group (A-J, A-D, A-H).

### 6. Press [PART SELECT] once again.

The [PART SELECT] indicator goes out, and you can now use BANK and NUMBER [1]-[8] to select a patch.

### 7. Use BANK [1]-[8] to select a bank.

### 8. Use NUMBER [1]-[8] to select a number.

Play the keyboard, and you will hear the selected patch.

\* If the [PART SELECT] or [PART MUTE] indicators in the PART section are lit, steps 7 and 8 will not be possible. In this case, press [PART SELECT] or [PART MUTE] to make the indicators go dark.

\* You can also select patches by using [INC] [DEC] or the [VALUE] dial instead of specifying the group/bank/number.

To view a list of the available patches...  
 [“Preset Patch List” \(p. 190\)](#)

## Playing Two Patches from the Keyboard (Key Mode)

The JX-305 lets you layer two patches, or play different patches with the right and left hands. This function is called the Key Mode.

The Key Mode setting can be stored as part of each pattern.

[“Saving Patterns You’ve Modified \(Pattern Write\)” \(p. 36\)](#)

## Playing One Patch Over the Entire Keyboard (Single)

This is the state in which you will normally play the keyboard.

### 1. In the KEYBOARD section, make sure that the [DUAL] and [SPLIT] indicators are dark.

If either indicator is lit, press the button and get the indicator to go out.

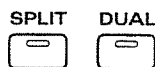

## Layering Two Patches (Dual)

1. In the **DISPLAY** section, press [PATCH].

The indicator lights.

2. In the **KEYBOARD** section, press [DUAL].

The indicator lights.

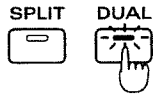

When you select Dual, the following screen will appear. The part shown in the right of the upper row is called the "upper part," and the part shown in the left of the upper row is called the "lower part."

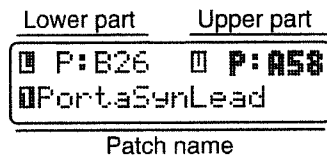

When you play the keyboard, the patches of the lower part and the upper part will sound simultaneously. Next, try changing the patch of each part.

3. Press [LOWER].

The indicator lights. The group, bank and number of the patch for the lower part will be displayed in bold characters. The lower line of the display will show the name of the patch that is currently selected for the lower part.



4. Select a patch.

The patch of the lower part changes.

5. Press [UPPER].

The indicator lights. The group, bank and number of the patch for the upper part will be displayed in bold characters. The lower line of the display will show the name of the patch that is currently selected for the upper part.



6. Select a patch.

The patch of the upper part changes.

7. To return to normal playing condition (Single), press [DUAL] once again to make the indicator go dark.

## Playing Different Patches with the Left and Right Hands (Split)

1. In the **DISPLAY** section, press [PATCH].

The indicator lights.

2. In the **KEYBOARD** section, press [SPLIT].

The indicator lights.

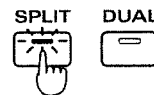

When you select Split, the following screen will appear. The part that is shown in the right of the upper row is called the "upper part," and the part that is shown in the left of the lower row is called the "lower part."

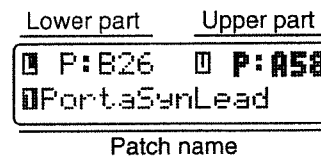

In Split mode, the keyboard is divided into two areas. Playing the left area will sound the patch of the lower part, and playing the right area will sound the patch of the upper part. The note at which the keyboard is divided into left and right is called the Split Point. For example if the split point is C4, the keyboard will be divided as shown below. The split point is included in the Upper part.

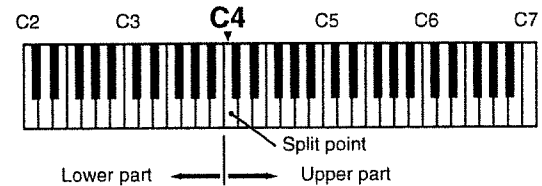

Here's how to change the patch of each part:

3. Press [LOWER].

The indicator lights. The group, bank and number of the patch for the lower part will be displayed in bold characters. The lower line of the display will show the name of the patch that is currently selected for the lower part.



4. Select a patch.

The patch of the lower part will change.

**5. Press [UPPER].**

The indicator lights. The group, bank and number of the patch for the upper part will be displayed in bold characters. The lower line of the display will show the name of the patch that is currently selected for the upper part.

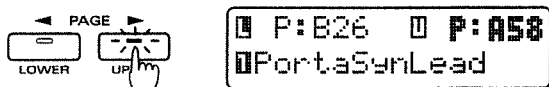

**6. Select a patch.**

The patch of the upper part will change.

**7. To return to normal play mode (Single), press [SPLIT] once again to make the indicator go dark.**

### Changing the Split Point

The split point can be changed freely.

**1. Hold down [SPLIT] and press the key that you wish to set as the split point.**

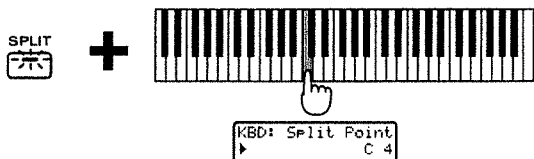

### Selecting the Upper Part/Lower Part

Key modes other than Single use two parts (the Upper part and Lower part). You can select which of the eight parts will be used as the Upper part, and which will be used as the Lower part.

\* When the Key Mode is Single, the upper part will be played by the keyboard.

**1. Press [PART SELECT].**

The indicator lights.

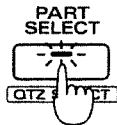

**2. Press [UPPER].**

The indicator on the PART button for the part currently selected as the upper part will light.

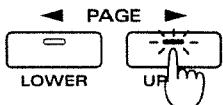

**3. Press PART [1]-[R] to select the part you**

**want to assign to the upper part.**

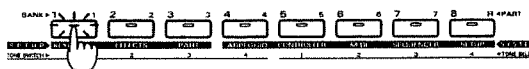

**4. Press [LOWER].**

The indicator on the PART button for the part currently selected as the lower part will light.

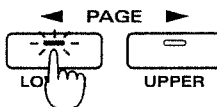

**5. Press PART [1]-[R] to select the part you want to assign to the lower part.**



\* If you assign the same part to both the upper part and lower part, it will not be possible to select patches independently.

### Modifying the Key Mode Settings in the Editing Pages

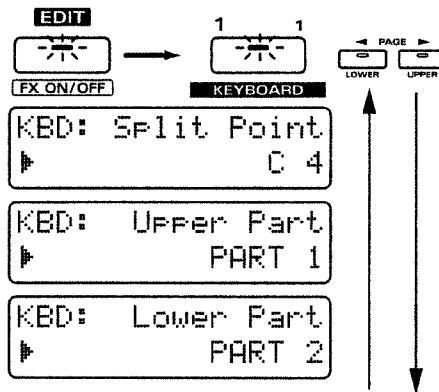

**1. Press [EDIT].**

The indicator lights, and the Edit page appears.

**2. Press BANK [1] (KEYBOARD).**

The display will show the Split Point setting page.

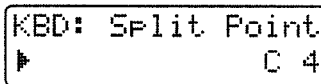

**3. Use [INC] [DEC] or the [VALUE] dial to set the value.**

Range: C-1-G9

\* The Split Point settings is not affected by Octave Shift. For example, middle C will be "C4" regardless of the Octave Shift setting.



4. Press **PAGE** [**>**] to select the upper part setting page.

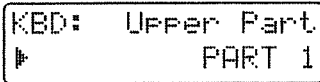

5. Use **[INC]** **[DEC]** or the **[VALUE]** dial to select the upper part.

Range: PART 1-7, PART R

6. Once again press **PAGE** [**>**] to select the lower part setting page.

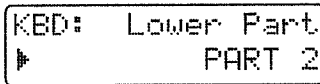

7. Use **[INC]** **[DEC]** or the **[VALUE]** dial to select the lower part.

Range: PART 1-7, PART R

8. Press **[EXIT]** to return to the normal display.

## Smoothly Changing the Pitch of the Sound (Portamento)

Portamento is a function which smoothly changes the pitch from one note to the next. It is effective when playing single-note lines.

### Portamento On/Off

1. In the **KEYBOARD** section, press **[PORTAMENTO]**.

The indicator lights, and portamento will be turned on.

PORTAMENTO



2. Each time you press **[PORTAMENTO]**, the function will be switched on or off.

### Changing the Time Over Which the Pitch Changes (Portamento Time)

You can change the speed at which the pitch will change when portamento is used.

1. In the **REALTIME MODIFY** section, press **[FILTER/AMP/PITCH]** several times, until the **PITCH** indicator lights.

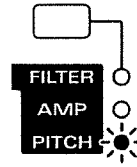

2. Rotate the **[PORTA TIME]** knob to adjust the portamento time value.

Range: 0-127

Rotating the knob clockwise will lengthen the time over which the pitch changes to that of the next note. Rotating the knob counterclockwise will shorten the time.

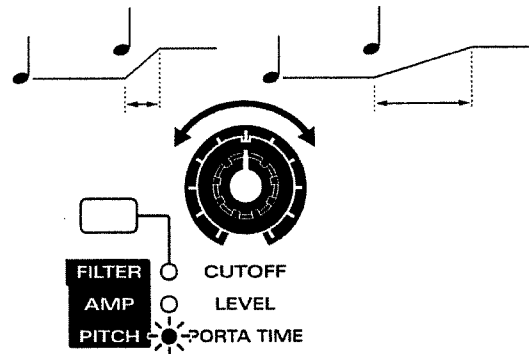

Portamento settings can be stored as part of the patch.

📖 “Saving Patches You’ve Created (Patch Write)” (p. 82)

## Playing Notes Which Lie Outside the Range of the Keyboard (Octave Shift)

Octave Shift is a function which shifts the range of the keyboard in one-octave steps (maximum +/- 3 octaves).

For example, bass notes can be easily played with the right hand if you first use Octave Shift to lower the range by one or two octaves.

1. In the **KEYBOARD** section, press **OCTAVE** [**-**] [**+**].

The range will be shifted in the **-/+** direction, and the button indicator lights.

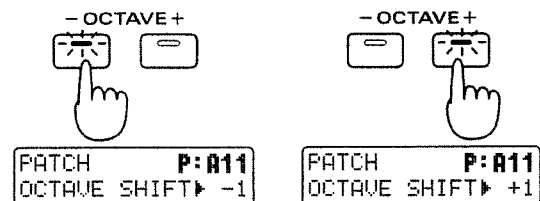

Each time you press OCTAVE [+], the range will be raised one octave.  
 Each time you press OCTAVE [-], the range will be lowered one octave.  
 While an OCTAVE button is pressed, the display will indicate the current setting.

## Changing the Pitch (Pitch Bend Lever)

By moving the pitch bend lever (located at the left of the keyboard) to left or right, you can change the pitch of the sound.

2

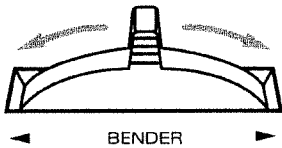

If you wish to modify the range of pitch change...  
 "Adjusting the Range of Pitch Bend (Bend Range)" (p. 76)

### Parts affected by the Pitch Bend lever

The part(s) affected by the pitch bend lever will depend on the Key Mode.

- Single:** The effect will be applied to the current part.
- Split:** The effect will be applied to the upper part when the [UPPER] indicator is lit, and to the lower part when the [LOWER] indicator is lit.
- Dual:** Regardless of the [UPPER]-[LOWER] selection, the effect will be applied to both parts.

## Applying Modulation to the Sound

### Using the Modulation Lever

You can use the Modulation lever to apply changes to the sound.

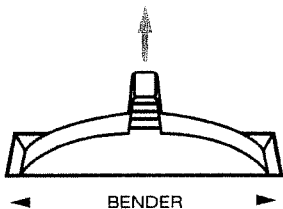

Since the sound will change only when the modulation lever is tilted away from you, this can be used to add accents to your playing.

If you wish to specify the parameter affected by the modulation lever...  
 "Specifying the Parameters That Will Be Modified by Each Controller (Control)" (p. 76)

## Using Aftertouch

Pressure which is applied to the keyboard after playing a note is referred to as "aftertouch." Aftertouch can be used to apply change to the sound.

To specify the parameter that will be affected when aftertouch is applied...  
 "Specifying the Parameters That Will Be Modified by Each Controller (Control)" (p. 76)

### Parts that will be affected

The part(s) affected by the modulation lever or aftertouch will depend on the Key Mode.

- Single:** The effect will be applied to the current part.
- Split:** The effect will be applied to the upper part when the [UPPER] indicator is lit, and to the lower part when the [LOWER] indicator is lit.
- Dual:** Regardless of the [UPPER]-[LOWER] selection, the effect will be applied to both parts.

## Changing the Keyboard Dynamics (Keyboard Velocity)

The force with which you play the keyboard is called "velocity." Velocity can be used to affect the volume or the way in which each note sounds.

### 1. Press [EDIT].

The indicator lights, and the edit page will appear in the display.

### 2. Press BANK [5] (CONTROLLER).

The Velocity setting page will appear.

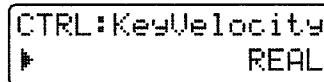

### 3. Use [INC] [DEC] or the [VALUE] dial to set the value.

Range:

- REAL:** The velocity value will correspond to the strength with which you actually play the note.
- 1-127:** A fixed velocity value will be produced, regardless of how strongly you play.

**4. Press [EXIT] when finished making the setting.**

The original display will reappear.

The keyboard velocity setting has now been made.

## Sustaining the Notes You Play (Hold Pedal)

When a pedal switch is connected to the Hold Pedal jack, notes can be sustained while you continue pressing the pedal. Newly played notes will be layered onto the currently sounding notes. This is the same function as the damper pedal of a piano.

### Parts that will be held

The part(s) that will be held will depend on the Key Mode.

**Single:** The current part will be held.

**Split:** The upper part will be held when the [UPPER] indicator is lit, and the lower part will be held when the [LOWER] indicator is lit.

**Dual:** Both parts will be held, regardless of the [UPPER]-[LOWER] selection.



If you wish to know about the Hold Pedal setting...

☞ "Specifying How the Pedal Will Function" (p. 163)

## Using a Pedal to Modify the Sound (Control Pedal)

If you connect an expression pedal to the control pedal jack, you can use the pedal to modify the volume and tonal character of the sound.

### Parts that will be controlled

The part(s) that will be controlled by the Control pedal will depend on the Key Mode.

**Single:** The sound of the current part will be controlled.

**Split:** The upper part will be controlled when the [UPPER] indicator is lit, and the lower part when the [LOWER] indicator is lit.

**Dual:** Regardless of the [UPPER]-[LOWER] selection, the effect will be applied to both parts.

## Control Pedal Settings

**1. Press [EDIT].**

The indicator lights, and the editing page will appear.

**2. Press BANK [5] (CONTROLLER).**

The CONTROLLER setting page will appear.

**3. Press PAGE [<] [>] several times to select the Control Pedal Assign page.**

```
CTRL: C-Pd1 Assgn
▶ EXPRESSION: CC11
```

**4. Use [INC] [DEC] or the [VALUE] dial to specify the MIDI message that will be transmitted when the pedal is pressed.**

Range:

CC 01-95: Controller numbers 1-95 (except for 6, 32, 38)

PITCH BEND UP: Pitch Bend Up

PITCH BEND DOWN: Pitch Bend Down

AFTERTOUCH: Aftertouch

**5. Once again press PAGE [>] to select the Control Pedal Polarity page.**

```
CTRL: C-Pd1 Pol
▶ STANDARD
```

**6. Use [INC] [DEC] or the [VALUE] dial to set the value.**

Range: STANDARD, REVERSE

If you are using a pedal whose polarity is inverted (i.e., when the pedal operation is opposite that of what you expect), select "REVERSE."

**7. Press [EXIT] to complete the setting.**

The original display will reappear.

## Pressing Chords to Produce Arpeggios (Arpeggiator)

By using the arpeggiator, you can produce an arpeggio (broken chord) simply by holding down the chord. For example, if you hold down a C major chord as follows, an arpeggio of C3, E3, G3, E3, C3, E3, G3.... will be played.

In the case of

Arpeggio Style: 1/4

Octave Range: 0

2

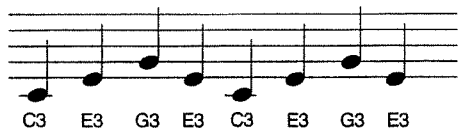

### Playing Arpeggios

1. Use [PART SELECT] and PART [1]-[R] to select the part to be used to play arpeggios.

2. In the ARPEGGIATOR/RPS section, press [ARP].

The indicator lights, and the arpeggiator will be turned on.



3. When you play the keyboard, any chord you play will be sounded as an arpeggio.

\* The tempo of the arpeggio will be synchronized to the tempo of the pattern. If you wish to change the speed of the arpeggio, change the tempo of the pattern.

"Adjusting the Tempo" (p. 31)

#### Parts that can be used for arpeggios

The part(s) that will sound the arpeggio will depend on the Key Mode.

**Single:** Arpeggios can be played on the current part.

**Split:** Regardless of the [UPPER]-[LOWER] selection, arpeggios can be played only on the lower part.

**Dual:** Arpeggios can be played on either the upper or the lower, or on both the upper and lower. For details refer to "Selecting the Part in Dual Mode Which Will Play the Arpeggio (Arpeggio Destination)" (p. 26)

#### Arpeggio Hold

If you hold down [HOLD] and press [ARP], and get the indicator to start blinking, the arpeggio will continue sounding even after you take your fingers off the keyboard. If you play a different chord or notes while the arpeggio is being held, the arpeggio will change accordingly.

To cancel Arpeggio Hold, hold down [HOLD] and press [ARP] simultaneously once again.

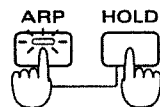

Also, if you connect a pedal switch (sold separately) to the Hold Pedal jack, you can hold the arpeggio as long as the pedal switch is pressed.

### Creating an Arpeggio Pattern

When you wish to make arpeggiator settings, you will first select an Arpeggio Style. When you select a style, optimal values will be set for the four parameters "Accent Rate," "Motif," "Beat Pattern," and "Shuffle Rate." You can adjust parameters such as Accent Rate and Octave Range to modify the pattern to your taste. If this is not enough, you can also make more detailed settings.

"Making More Detailed Settings" (p. 26)

The arpeggiator settings you modify can be stored as a User Style.

"Saving Arpeggio Settings (Arpeggio Write)" (p. 28)

## Changing the Way in Which the Arpeggio Will Play (Arpeggio Style)

Specifies the basic way in which the arpeggio will be played. Select one of the following 53 types.

1. Hold down [ARP] in the ARPEGGIATOR/RPS section, and use [INC] [DEC] or the [VALUE] dial to select the style.

While you hold down the button, the display will indicate the currently-selected style.

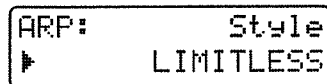

### Available Settings:

- 1/4: The rhythm will be divided in quarter notes.
- 1/6: The rhythm will be divided in quarter note triplets.
- 1/8: The rhythm will be divided in eighth notes.
- 1/12: The rhythm will be divided in eighth note triplets.
- 1/16: The rhythm will be divided in 16th notes.
- 1/32: The rhythm will be divided in 32nd notes.
- PORTAMENTO A, B: A style using the portamento effect.
- GLISSANDO: A glissando style.
- SEQUENCE A–D: Styles for sequenced patterns.
- ECHO: An echo-like style.
- SYNTH BASS, HEAVY SLAP, LIGHT SLAP, WALK BASS: Styles appropriate for bass playing.
- RHYTHM GTR 1–5: Styles for guitar cutting. Styles 2–5 are effective when 3–4 notes are held.
- 3 FINGER: Three-finger guitar style.
- STRUMMING GTR: A style simulating a guitar chord strummed upward (downward). Effective when 5–6 notes are held.
- PIANO BACKING, CLAVI CHORD: Styles for keyboard instrument backing.
- WALTZ, SWING WALTZ: Styles in triple meter.
- REGGAE: A reggae-type style. Effective when 3 notes are held.
- PERCUSSION: A style suitable for percussive instrument sounds.
- HARP: The playing style of a harp.
- SHAMISEN: The playing style of a Shamisen.
- BOUND BALL: A style suggestive of a bouncing ball.
- RANDOM: A style in which the notes sound in random order.
- BOSSANOVA: A style with bossanova guitar cutting. Hold 3–4 notes for best results. You can increase the BPM and use this as a Samba.
- SALSA: Typical salsa style. Hold 3–4 notes for best results.
- MAMBO: Typical mambo style. Hold 3–4 notes for

best results.

**LATIN PERCUSSION:** A rhythm style with Latin percussion instruments such as Clave, Cowbell, Clap, Bongo, Conga, Agogo etc.

**SAMBA:** Typical samba style. Use for rhythm patterns or bass lines.

**TANGO:** Typical tango rhythm style. Hold the root, 3rd and 5th of a triad etc. for best results.

**HOUSE:** A style for house piano backing. Hold 3–4 notes for best results.

**LIMITLESS:** The settings of all parameters can be freely combined without restriction.

**USER STYLE 1–10:** Arpeggio settings can be modified and saved in one of these user styles.

2

## Adding Expression to the Arpeggio (Accent Rate)

By modifying the accent strength and note length, you can change the sense of groove of the arpeggio.

1. Press [ACCENT RATE/OCTAVE RANGE] to make the indicator go dark.
2. Rotate the [ACCENT RATE] knob to set the accent rate.

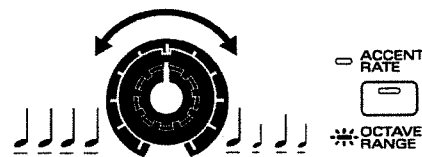

Rotating the knob clockwise will strengthen the sense of groove. Rotating the knob counterclockwise will decrease the amount of expression.

## Changing the Pitch Range of the Arpeggio (Octave Range)

You can specify the pitch range in which the arpeggio will be developed, in steps of one octave.

1. Press [ACCENT RATE/OCTAVE RANGE] to make the button indicator light.
2. Rotate the [OCTAVE RANGE] knob to set the Octave Range.

2

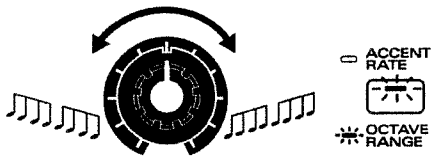

Rotating the knob clockwise will cause the pitch range to be extended upward from the notes which you play. Rotating the knob counterclockwise will extend the pitch range downward.

## Selecting the Part in Dual Mode Which Will Play the Arpeggio (Arpeggio Destination)

When the Key Mode is set to Dual, this setting specifies whether the upper and/or lower part will play arpeggios.

1. Make sure that the [ARP] indicator is lit.
2. Hold down [DUAL] and use [LOWER] [UPPER] to select the destination part.

If you press [LOWER] [UPPER] simultaneously, the destination part will be "LOWER&UPPER."

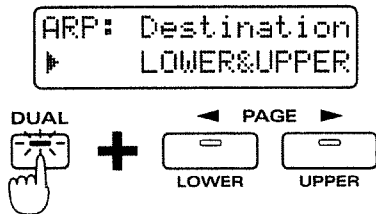

Range:

**LOWER&UPPER:** The patches of the upper and lower parts will be layered to sound the arpeggio.

**LOWER:** Arpeggios will be played only on the lower part. For example, this lets you play chords in the upper part and arpeggios in the lower part.

**UPPER:** Arpeggios will be played only on the upper part.

## Making More Detailed Settings

Normally you will create the arpeggio pattern by adjusting the three parameters "Arpeggio Style," "Accent Rate," and "Octave Range." However by modifying the settings of additional parameters, you can create arpeggio patterns that are even richer in variation.

1. Press [EDIT].  
The indicator lights, and the edit page appears.
2. Press BANK [4] (ARPEGGIO).  
The ARPEGGIO setting page will appear.

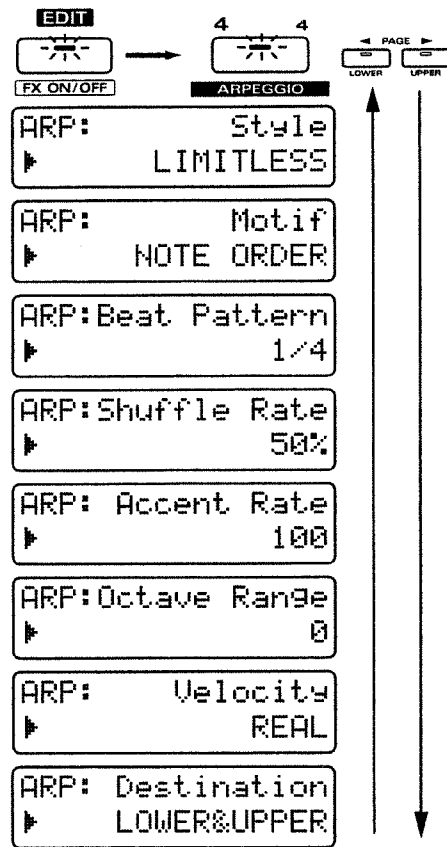

3. Use PAGE [<] [>] to select the parameter page, and set the parameters.

To leave the setting page, press [EXIT].

## Style (Arpeggio Style)

This is the setting page for “Changing the Way in Which the Arpeggio Will Play (Arpeggio Style)” (p. 25).

### Motif

Specifies the order in which the notes of the chord will be sounded.

#### Available Settings:

**SINGLE UP:** Notes you press will be sounded individually, beginning from low to high.

**SINGLE DOWN:** Notes you press will be sounded individually, from high to low.

**SINGLE UP&DOWN:** Notes you press will be sounded individually, from low to high, and then back down from high to low.

**SINGLE RANDOM:** Notes you press will be sounded individually, in random order.

**DUAL UP:** Notes you press will be sounded two at a time, beginning from low to high.

**DUAL DOWN:** Notes you press will be sounded two at a time, beginning from high to low.

**DUAL UP&DOWN:** Notes you press will be sounded two at a time, from low to high, and then back down from high to low.

**DUAL RANDOM:** Notes you press will be sounded two at a time, in random order.

**TRIPLE UP:** Notes you press will sound three at a time, from low to high.

**TRIPLE DOWN:** Notes you press will sound three at a time, from high to low.

**TRIPLE UP&DOWN:** Notes you press will sound three at a time, from low to high and then back down from high to low.

**TRIPLE RANDOM:** Notes you press will sound three at a time, in random order.

**NOTE ORDER:** Notes you press will be sounded in the order in which you pressed them. By pressing the notes in the appropriate order you can produce melody lines. Up to 128 notes will be remembered.

**GLISSANDO:** Each chromatic step between the highest and lowest notes you press will sound in succession, repeating upward and downward. Press only the lowest and the highest notes.

**CHORD:** All notes you press will sound simultaneously.

**BASS+CHORD 1–5:** The lowest of the notes you play will sound, and the remaining notes will sound as a chord.

**BASS+UP 1–8:** The lowest of the notes you play will sound, and the remaining notes will be arpeggiated.

**BASS+RND 1–3:** The lowest of the notes you play will sound, and the remaining notes will sound in random order.

**TOP+UP 1–6:** The highest of the notes you play will sound, and the remaining notes will be arpeggiated.

**BASS+UP+TOP:** The highest and the lowest of the notes you play will sound, and the remaining notes will be arpeggiated.

\* The parameters which can be set will depend on the currently-selected Arpeggio Style.

### Beat Pattern

This allows you to select the Beat Pattern. It will affect the accent location and note length, causing the beat (rhythm) to change.

Range : 1/4, 1/6, 1/8, 1/12, 1/16 1–3, 1/32 1–3, PORTA-A 1–11, PORTA-B 1–15, SEQ-A 1–7, SEQ-B 1–5, SEQ-C 1, 2, SEQ-D 1–8, ECHO 1–3, MUTE 1–16, STRUM 1–8, REGGAE 1, 2, REF 1, 2, PERC 1–4, WALKBS, HARP, BOUND, RANDOM, BOSSA NOVA, SALSA 1–4, MAMBO 1–2, CLAVE, REV CLA, GUILO, AGOGO, SAMBA, TANGO 1–4, HOUSE 1, 2

.....  
If “PORTA-A 1–11, PORTA-B 1–15” is selected as the Beat Pattern, the Patch parameter Portamento Time (p. 78) will control the speed of portamento. Adjust the portamento time as appropriate for the playback tempo. (It is not necessary to turn portamento on.)  
.....

\* The parameters which can be set will depend on the currently-selected Arpeggio Style.

### Shuffle Rate

This setting lets you modify the note timing to create shuffle rhythms.

Range: 50–90 (%)

With a setting of 50%, the notes will sound at equal spacing. As this value is increased, the notes will become more “bouncy,” as if they were dotted notes.

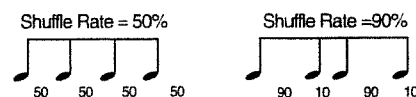

\* If the Beat Pattern setting is “1/4,” shuffle will not be applied even if you increase the Shuffle Rate setting.

### Accent Rate

This is the setting page for “Adding Expression to the Arpeggio (Accent Rate)” (p. 25).

Range: 0–100

### Octave Range

This is the setting page for "Changing the Pitch Range of the Arpeggio (Octave Range)" (p. 26).

Range: -3--+3

### Velocity

Specify the loudness of the notes that you play.

Range: REAL, 1-127

If you want the velocity value to change according to how strongly you played each note, set this to REAL. If you want to produce a constant velocity value regardless of how strongly each note was played, specify the desired value.

### Destination

This is the setting page for "Selecting the Part in Dual Mode Which Will Play the Arpeggio (Arpeggio Destination)" (p. 26).

## Saving Arpeggio Settings (Arpeggio Write)

When you have created a playback pattern that you like, save the settings as a User Style. The JX-305 has ten user styles, USER STYLE 1-10, and user styles that you save can be recalled at any time.

\* Velocity and Destination Part cannot be saved.

1. Create an arpeggio playback pattern.
2. Make sure that the ARPEGGIO setting page is shown in the display.

If it is not displayed, press [EDIT] and then press BANK [4] to access the setting page.

3. Hold down [SHIFT] and press [WRITE].
- The indicator will blink, and the following display will appear.



4. Use [INC] [DEC] or the [VALUE] dial to specify the writing destination user style.
- Range: USER STYLE 1-10

5. Press [ENTER].
- The execute page will appear in the display.

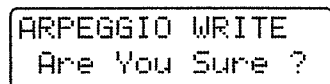

6. Press [ENTER] once again.
- The Arpeggio Write operation will be executed, and the normal display will reappear. To cancel the operation without executing, press [EXIT].

## Playing a Rhythm Set

The JX-305 contains various rhythm sets, each of which have a different percussion instrument sound or sound effect assigned to each key. These rhythm sets can be selected by specifying the group, bank and number, and are played from the keyboard.

1. Use [PART SELECT] and PART [R] to select the rhythm part.

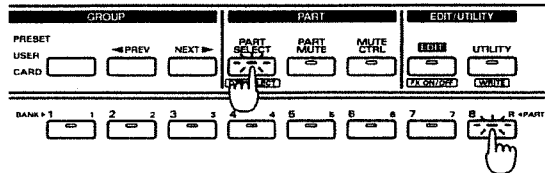

2. In the DISPLAY section, press [PATCH].
- The indicator lights, and the display will show the group, bank, number and name of the currently selected rhythm set.

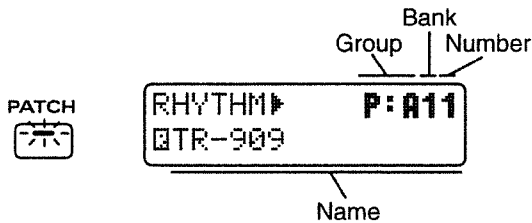

3. In the GROUP section, press [PRESET/USER/CARD] to select the group.

Rhythm set groups are organized as follows:  
 PRESET → P: A, B (Preset group)  
 USER → U: (User group)  
 CARD → C: (Card group)

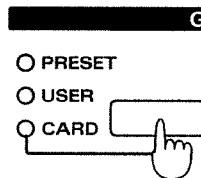

\* The Card group can be selected only when an optional memory card is inserted.



 "Using Memory Cards" (p. 159)

**4. Press [PART SELECT] once again.**

The [PART SELECT] indicator goes out, and you can now use BANK and NUMBER [1]–[8] to select a rhythm set.



**5. Press BANK [1]–[4] to select the bank.**

**6. Press NUMBER [1]–[8] to select the number.**  
Play the keyboard, and the selected rhythm set will be heard. Each key will play a different percussion instrument sound.

\* If the [PART SELECT] or [PART MUTE] indicators in the PART section are lit, steps 5 and 6 cannot be performed. In this case, press [PART SELECT] or [PART MUTE] to make the indicator go dark.

\* Instead of specifying the group/bank/number, you can also use [INC] [DEC] or the [VALUE] dial to select a patch.

\* Depending on the group and bank, it may not be possible to select all numbers [1]–[8].

 To view a list of available rhythm sets...  
 "Preset Rhythm Set List" (p. 195)

## Listening to Sound Processed by the Effects (Audition)

The JX-305 contains three effects units. Thirty-two different settings for these three effects units, together with a patch/rhythm set are provided as Effect Templates (16 for patches, 16 for rhythm sets). The Audition function lets you use these effects templates to listen to the sound of a patch as it is processed by the effects units. Effect templates are assigned to the sixteen BANK and NUMBER [1]–[8] buttons.

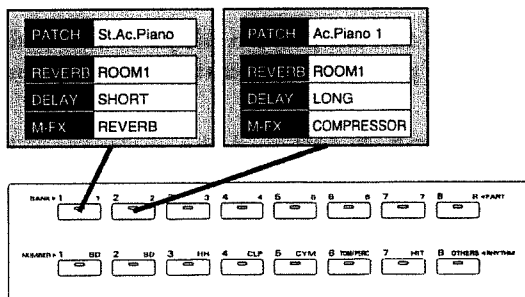

**1. Use [PART SELECT] and PART [1]–[R] to specify whether you will use an effects template for a patch or for a rhythm set.**

For parts 1–7, use one of the patch effects templates. For part R, use one of the rhythm set effects templates.

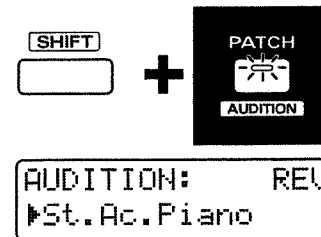

**2. Hold down [SHIFT] and press [AUDITION].**

The indicator will begin blinking, and the display will show the effect type and patch name for the currently selected effects template.



\* It is not possible to enter the audition function while a pattern is playing back.

**3. Use BANK and NUMBER [1]–[8] to select an effects template.**

 To see the effects templates that are available...  
 "Effects Template List" (p. 203)

**4. You can use [INC] [DEC] or the [VALUE] dial to change only the patch without changing the effects settings.**

If you wish to modify the effects settings, use the procedure given in "Applying Effects to the Sound (Effects)" (p. 101).

**5. To exit the Audition function, press [EXIT].**

\* When you select a effects template, the setup parameters of the temporary pattern will change to the settings of the template.

\* It is not possible to select the effects template while a pattern is playing back.

\* If you wish to keep the modified effects settings, it is not possible to rewrite the template, but you can save the data to a pattern.

 "Saving Patterns You've Modified (Pattern Write)" (p. 36)

\* A noise-like sound may be heard when the NUMBER [5] template for rhythm sets is selected, but this is not a malfunction.

# Chapter 3. Playing Patterns

## Playing Patterns

### 1. Make sure that the SEQUENCER section [MODE] button indicator is dark.

If it is not dark, press [MODE] to make it go dark (Pattern mode).

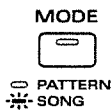

### 2. Press [PTN/SONG] in the DISPLAY section.

The indicator will light.

The display will indicate the group, bank, number and name of the currently selected pattern.

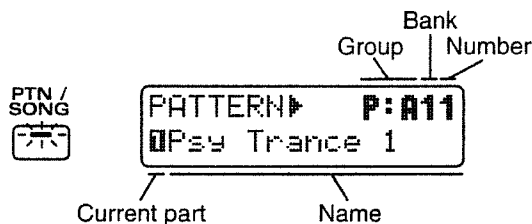

### 3. Press [PRESET/USER/CARD] in the GROUP section to select the group.

Pattern groups are organized as follows.

PRESET → P:A-L (Preset group)

USER → U:A-D (User group)

CARD → C:A-D (Card group)

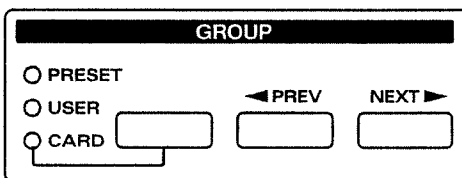

\* The card group can be selected only if an optional memory card is inserted.

📖 *ESP* "Using Memory Cards" (p. 159)

\* When all three indicators of the GROUP section are dark, TMP (the temporary pattern) is selected.

### 4. Press [<PREV>] [NEXT>] in the GROUP section to select group A-L.

### 5. Use [INC] [DEC] or the [VALUE] dial to select the bank and number.

Range: P:A11-P:L88, U:A11-U:D18, C:A11-C:D18

The bank, number and name in the display will change.

A pattern has now been selected.

\* P:E33-P:L88 are RPS patterns. Each pattern contains one phrase.

Instead of using [INC] [DEC] or the [VALUE] dial, you can also select patterns using BANK and NUMBER [1]-[8].

If you wish to use BANK and NUMBER [1]-[8] to select patterns, make the [PART SELECT] and [PART MUTE] indicators go dark.

### 6. Press [STOP/PLAY] and the pattern will play back.



The pattern that is currently playing back is referred to as the "current pattern," and the pattern that is scheduled to play next is called the "next pattern." Immediately after a pattern is played back, the current pattern and the next pattern will be the same pattern, and that pattern will play back repeatedly.

### 7. Use steps 3-5 to select the next pattern.

The display will indicate the group, bank, number and name of the next pattern.

When you select the next pattern, the "▶" at the left of the pattern group will change to "▶".

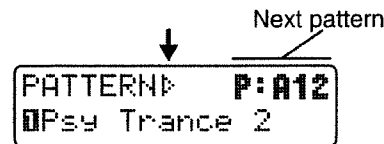

### 8. When the current pattern plays to the end, the next pattern will automatically be selected.

### 9. Press [STOP/PLAY] and the pattern will stop playing.



\* Immediately before the pattern changes or repeats, the following display will appear, notifying you that the pattern is about to change. During this time it is not possible to select the next pattern.

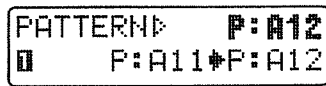

Current pattern                      Next pattern

\* If you press [STOP/PLAY] to stop playback after selecting the next pattern, the pattern that you had reserved will be canceled.

\* With the factory settings, the User group contain empty patterns that contain no musical data. Even if you select an empty pattern, it will not play back. If you specify an empty pattern as the next pattern, playback will stop the instant that the pattern changes.

### Fast-forward and rewind

Each time you press [FWD], the pattern will advance one measure. Each time you press [BWD], the pattern will go back one measure.

If you hold down [FWD] and press [BWD], you will advance to the last measure. If you hold down [BWD] and press [FWD], you will return to the beginning.

When a pattern is stopped, "||" will sometimes be displayed in the display. This indicates that the pattern was stopped in the middle of the measure.

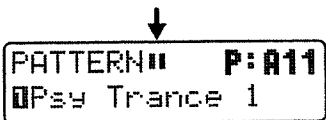

### Changing patterns instantly

By holding down [SHIFT] and press PAGE [<] [>] while a pattern is playing back, you can switch immediately to the previous or next pattern. In this case the pattern will play back the optimal tempo for that pattern.

Also, if you make a new recording and create a pattern that is only one measure long, and play back this pattern, it will in some cases be impossible to use [INC] [DEC], the [VALUE] dial or PAGE [<] [>] to select the next pattern. In such cases, holding down [SHIFT] and use PAGE [<] [>] to change patterns.

 If you would like to know what kind of patterns are available...

☞ "Preset Pattern List" (p. 204)

## Adjusting the Tempo

The tempo can be adjusted freely even while a pattern is playing back.

1. In the **DISPLAY** section, press [TEMPO& MEASURE]. Indicator will light, and the upper line of the display will show the current tempo value.

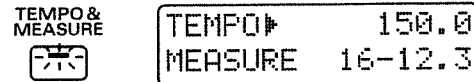

2. Use the [VALUE] dial to modify the tempo (20.0–240.0 BPM).

The tempo can be adjusted in 0.1 BPM steps. By holding down [SHIFT] and rotating the [VALUE] dial, you can adjust the tempo in 1 BPM units.

### BPM

BPM stands for Beats Per Minute, and indicates the number of quarter notes that occur in one minute.

### Standard tempo

An optimal tempo is already set for each pattern. This is called the "standard tempo."

If you select another pattern while pattern playback is stopped, the tempo will change to the standard tempo of that pattern. When you use [INC] [DEC] or the [VALUE] dial to switch to another pattern during pattern playback, the tempo value of the previous pattern will be maintained.

## Viewing the Number of Measures in a Pattern

If you wish to know the total number of measures in the current pattern, or the current playback location, use the following procedure.

1. Press [TEMPO&MEASURE].

The lower line of the display will show the number of measures in the entire pattern, and the playback location (measure and beat). In the example shown below, "Total number of measures = 16 measures" "Playback location = third beat of measure 12"



2. To return to the pattern select page, press [PTN/SONG].

## Muting a Specific Part (Part Mute/Rhythm Mute)

During pattern playback, you can mute the playback of a specific part or rhythm tone.

### 1. Press [PART MUTE].

The [PART MUTE] indicator will light, and the PART button [1]– [R] indicators will show the current status of that part.

The RHYTHM button [BD]– [OTHERS] indicators will also show the current status of that rhythm group.



3

**Blinking:** The playback data is muted.

**Lit:** The playback data is not muted.

**Dark:** There is no playback data.

### 2. Press the button of the part or rhythm group that you wish to mute.

The indicator of the button you pressed will begin blinking, and the playback data will be muted.

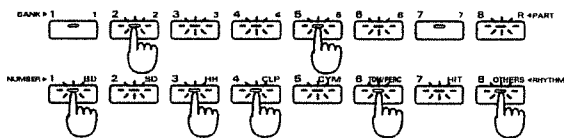

To cancel muting, press the button for the muted part or rhythm group to make the indicator light.

\* The indicator will not light even if you press the button of a part or rhythm group which is dark.

\* None of the preset patterns (P:A11-P:E32) contain playback data for part 1.

You can change the mute status of each part, and save the setting in a user pattern.

☞ "Saving Patterns You've Modified (Pattern Write)" (p. 36)

\* Rhythm mute settings will not be active if the Part Mute function has been used to mute the rhythm part itself.

\* The rhythm tones that are muted by each RHYTHM button will depend on the selected rhythm set.

If you would like to know which rhythm tones correspond to each rhythm group...

☞ "Preset Rhythm Set List" (p. 195)

### Other type of muting

In addition to Part Mute and Rhythm Mute, a variety of other muting operations are available. Use them as appropriate for your needs.

#### Simultaneously muting all parts (All Mute)

Hold down [SHIFT] and press [PART MUTE].

The indicator of [PART MUTE] will blink and all parts will be muted. Perform the same operation once again to return to the previous condition.

#### Playing back only a specific part (Monitor)

Hold down [PART MUTE] and press the PART button for the part that you wish to hear.

#### Exchanging the mute status of all parts (Mute Exchange)

Hold down [PART MUTE] and press [PART SELECT].

## Transposing During Playback (Real-Time Transpose)

### Using the VALUE Dial or [INC] [DEC]

1. Hold down [TRANPOSE] and use the [VALUE] dial or [INC] [DEC] to specify the transpose value.

Range: -12+12 semitones (factory setting is +4)

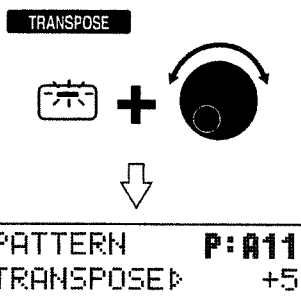

The display will indicate the current setting while you continue pressing the button. When you modify the transpose value, the "P" at the left of the transpose value will change to "T".

2. The transposition will be applied from the moment that you release the button.

To return to the original key, press [TRANPOSE] once again to make the button indicator go dark.

## Using the Keyboard

### 1. Hold down [TRANPOSE] and press a key to set the transpose value.

The transpose value can be set in a range of -12 to +12 semitones, above and below the C4 key.

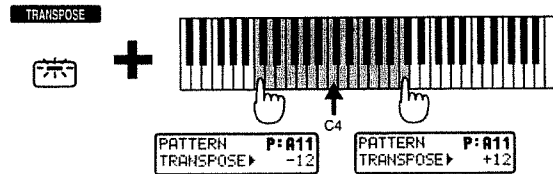

### 2. The transposition will be applied from the moment that you press the keyboard.

To return to the original key, press [TRANPOSE] once again to make the button indicator go dark.

## Changing the Settings of Each Part

The settings of a pattern (the volume and pan of each part, etc.) can be modified in the following two ways.

### Using the Part Mixer Page to Make Changes

In the Part Mixer page, the setting values of each part are displayed graphically. Here you can also record the modified settings to a pattern.

"Recording Part Mixer Operations" (p. 128)

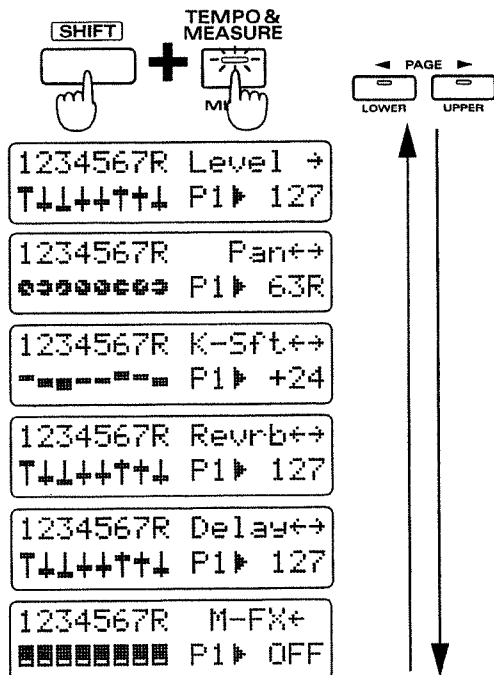

### 1. Hold down [SHIFT] and press [MIXER].

The indicator will light and the display will show the Part Mixer page.

### 2. Use PART [1]-[R] to select the part for which you wish to make settings.

### 3. Use PAGE [<] [>] to select the parameter that you wish to set.

### 4. Use [INC] [DEC] or the [VALUE] dial to set the value.

When you enter the Part Mixer page, all indicators of [ENVELOPE/LFO1/EFFECTS], [FILTER/AMP/PITCH] and [GRID/SHUFFLE/GROOVE] will blink, and you can use the eight knobs of the REALTIME MODIFY section and the QUANTIZE section to adjust the settings of each part. At this time, the QUANTIZE settings or REALTIME MODIFY cannot be modified by the knobs.

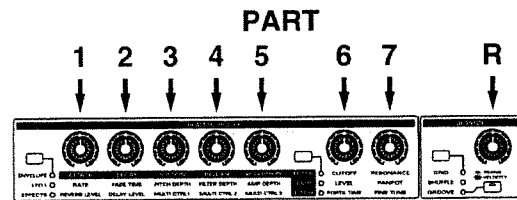

### 5. Press [EXIT] to exit the Part Mixer page.

### Adjusting the volume of each part (Part Level)

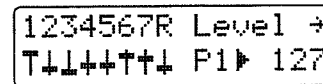

Range: 0-127

With a setting of "127," the volume setting of the patch itself will be fully active.

### Adjusting the pan of each part (Part Pan)

You can adjust the stereo location in the stereo output from the OUTPUT jacks. For example, you might place the drums and bass in the center, the piano at right, and a pad at left.

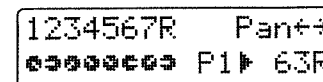

Range: L64-63R

3

When this setting is at "0," the setting of the patch itself will be unaffected.

\* Pan is specified independently for each tone of a patch (or each rhythm tone of a rhythm set). Modifying the Part Pan applies a relative change to the overall panning of the patch or rhythm set.

\* For some patches, a small amount of sound may be heard from the opposite speaker even if the pan is set to full left or full right. Also, the Part Pan setting will have no effect in the following cases.

- When monaural connections are used
- Tones/rhythm tones for which Random Pan is ON

 "Causing pan to change randomly (Random Pan Switch)" (p. 67)

- Patches/rhythm tones to which a mono-output Multi Effects (spectrum, overdrive, distortion, noise generator, phonograph, limiter, phaser) is applied
- The same applies for the Lo-Fi or Radio Tuning effects if the output setting of them is set to MONO.

 "Applying Various Effects to the Sound (Multi-Effects)" (p. 106)

### Adjusting the pitch of each part (Part Key Shift)

You can adjust the pitch of the sound of each part.

```
1234567R K-Sft↔
-■-■-■-■-■ P1▶ +24
```

Range: -48+48 semitones

When the value is "0," the original pitch of the patch itself will be used without change.

If you hold down [SHIFT] and change the value using [INC] [DEC] or the [VALUE] dial, the pitch will change in units of an octave (12 semitones).

### Adjusting the reverb volume for each part (Part Reverb Level)

You can adjust the volume of the reverberation for each part.

```
1234567R Reverb↔
T↓L↑↑↑↑↓ P1▶ 127
```

Range: 0-127

 "Adding Reverberation to the Sound (Reverb)" (p. 102)

### Adjusting the delay volume for each part (Part Delay Level)

You can adjust the volume of the delay sound for each part.

```
1234567R Delay↔
T↓L↑↑↑↑↓ P1▶ 127
```

Range: 0-127

 "Adding an Echo to the Sound (Delay)" (p. 103)

### Applying multi-effects to each part (Part Multi-Effects Switch)

For each part you can switch multi-effects on/off.

```
1234567R M-FX↔
■■■■■■■■ P1▶ OFF
```

Range:

OFF: Multi-effects will not be applied.

RHY: The sound will be output according to the Rhythm Tone Multi-Effects Switch, Rhythm Tone Reverb Level, and Rhythm Tone Delay Level settings of the selected rhythm set (only for the rhythm part) (p. 97).

ON: Multi-effects will be applied.

 "Applying Various Effects to the Sound (Multi-Effects)" (p. 106)

## Using the Editing Pages to Make Changes

In the editing pages you can make settings for all part parameters, but cannot record the modified settings to a pattern.

#### 1. Press [EDIT].

The indicator will light and the display will show the Edit page.

#### 2. Press BANK [3] (PART).

The part setting page will appear.

#### 3. Use [PART SELECT] and PART[1]-[R] to select the part.

#### 4. Use PAGE [<] [>] to switch parameters.

#### 5. Use [INC] [DEC] or the [VALUE] dial to make settings.

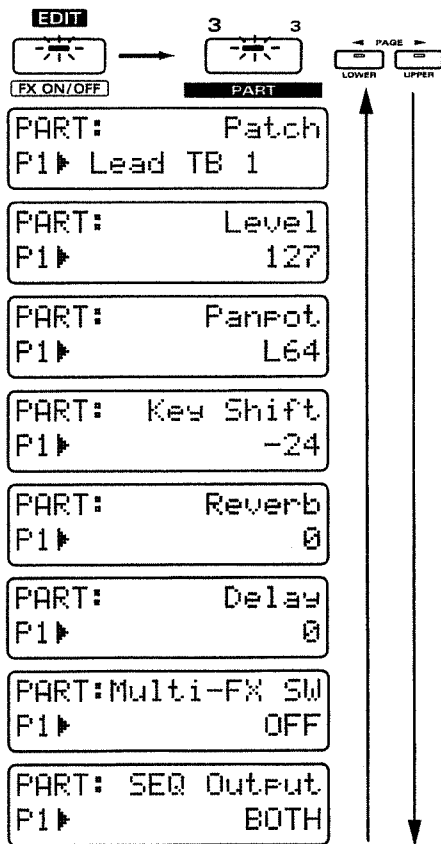

5. Press [EXIT] to leave the setting page.

### Selecting the patch that will be assigned to a part

The patch that is assigned to each part is memorized as part of the pattern settings.

```
PART: Patch
P1▶ Lead TB 1
```

### Adjusting the volume of each part (Part Level)

```
PART: Level
P1▶ 127
```

Range: 0–127

With a setting of “127,” the volume setting of the patch itself will be fully active.

### Adjusting the pan of each part (Part Pan)

You can adjust the stereo location in the stereo output from the OUTPUT jacks.

```
PART: Panpot
P1▶ L64
```

Range: L64–63R

When this setting is at “0,” the setting of the patch itself will be unaffected.

### Adjusting the pitch of each part (Part Key Shift)

You can adjust the pitch of the sound of each part.

```
PART: Key Shift
P1▶ -24
```

Range: -48–+48 semitones

When the value is “0,” the original pitch of the patch itself will be used without change.

### Adjusting the reverb volume for each part (Part Reverb Level)

The volume of reverberation can be specified for each part.

```
PART: Reverb
P1▶ 0
```

Range: 0–127

<sup>ES</sup> “Adding Reverberation to the Sound (Reverb)” (p. 102)

### Adjusting the delay volume for each part (Part Delay Level)

The volume of the delay sound can be specified for each part.

```
PART: Delay
P1▶ 0
```

Range: 0–127

<sup>ES</sup> “Adding an Echo to the Sound (Delay)” (p. 103)

### Applying multi-effects to each part (Part Multi-Effects Switch)

Multi-effects can be switched on/off for each part.

```
PART: Multi-FX SW
P1▶ OFF
```

Range:

OFF : Multi-effects will not be applied.

RHY : The sound will be output according to the Rhythm Tone Multi-Effects Switch, Rhythm Tone Reverb Level, and Rhythm Tone Delay

Level settings of the selected rhythm set (rhythm part only) (p. 97).

ON : Multi-effects will be applied.

"Applying Various Effects to the Sound (Multi-Effects)" (p. 106)

### Specifying the output destination for musical data (Sequencer Output Assign)

You can specify the output destination for the musical data of each part. For example, if you wish to use the JX-305 together with a sampler such as the SP-202, you can set Sequencer Output Assign to "EXT" for one or more of the parts. This will allow playback data from the JX-305 sequencer to control the external MIDI device.

If you want to control an external MIDI device such as a sampler...

"Controlling an External MIDI Device from the JX-305" (p. 174)

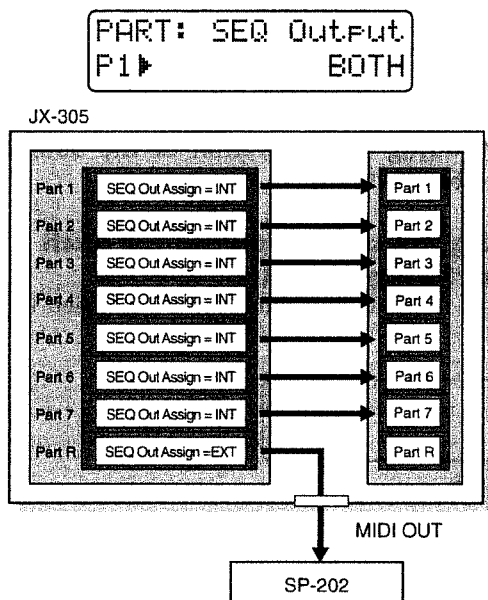

Range:

INT : Musical data from the sequencer will be sent to the internal sound generator of the JX-305.

EXT : Musical data from the sequencer will be sent to an external device via MIDI OUT.

BOTH : Musical data from the sequencer will be sent both to the internal sound generator and from MIDI OUT.

\* If "EXT" or "BOTH" is selected, that part will not be heard even if you play back the pattern.

Musical data from parts that are set to EXT will be transmitted as MIDI messages from MIDI OUT on a different MIDI channel for each part.

The musical data of each part is transmitted on the following MIDI channels.

Part	1	2	3	4	5	6	7	R
Channel	1	2	3	4	5	6	7	10

If you wish to use the keyboard to directly play an external MIDI device, set the Local Switch to "EXT."

"Disconnecting the Keyboard from the Internal Sound Generator (Local Switch)" (p. 165)

### Saving Patterns You've Modified (Pattern Write)

If you have modified the patch and part mixer settings for each part to create a pattern that you wish to keep, you can save that pattern as a User Pattern.

1. Make sure that the pattern is stopped.
2. Press [PTN/SONG] to access the pattern select page.
3. Hold down [SHIFT] and press [WRITE].

The indicator will blink. The following display will appear, and "▶" (the cursor) will appear at the left of the number.



If you do not wish to change the number or name, you can skip steps 4–8.

If you decide not to save the pattern, press [EXIT].

4. Press [PRESET/USER/CARD] to select the save destination group.

\* The PRESET group and TMP cannot be selected.  
\* CARD groups can be selected only if an optional memory card is inserted.

"Using Memory Cards" (p. 159)

5. Use [INC] [DEC] or the [VALUE] dial to select the save destination bank and number.

You can also use the BANK and NUMBER [1]–[8] buttons to select the save destination bank and number.



At this time, you can press [UNDO/REDO] to check the name of the pattern that is currently in the save destination number. After you have found a pattern that you do not mind overwriting, press [UNDO/REDO] once again to return to the previous display.

#### 6. Press PAGE [>].

The cursor will move to the beginning of the second line of the display.

```
PTN WRITE U:A12
▶Esw Trance 1
```

#### 7. Assign a name to the pattern.

Use [INC] [DEC] or the [VALUE] dial to select characters.

The following characters are available.  
space, A-Z, a-z, 0-9, ! " # \$ % & ' ( ) \* +, - . / : ; < = > ?  
@ [ ¥ ] ^ \_ ` { | }

#### 8. Repeat steps 6-7 to input the name.

You can move the cursor back toward the left by pressing PAGE [<].

#### 9. Press [ENTER].

The confirmation screen will appear in the display. If you decide to cancel the operation, press [EXIT].

```
PTN WRITE U:A12
Are You Sure ?
```

#### 10. Press [ENTER] once again.

```
Processing...
Keep Power ON !
```

The Pattern Write operation will be carried out, then the normal display will reappear. The pattern has now been saved.

On the JX-305, the following parameters are memo- rized for each pattern.

Standard Tempo (p. 31)  
Patch Number \* (p. 18)  
Part Level \* (p. 33)  
Part Pan \* (p. 33)  
Part Key Shift \* (p. 34)  
Part Reverb Level \* (p. 34)  
Part Delay Level \* (p. 34)  
Part Multi-Effects Switch \* (p. 34)  
Reverb settings # (p. 102)  
Delay settings # (p. 103)

Multi Effects settings (p. 106)  
Part Mute status \* (p. 32)  
Rhythm Mute status (p. 32)  
Sequencer Output Assign \* (p. 36)  
Key Mode # (p. 18)  
Split Point # (p. 20)  
Part number assigned to the upper part # (p. 20)  
Part number assigned to the lower part # (p. 20)

\* The "\*" indicates parameters that are set independently for each part.

\* If you switch patterns while playback is stopped, "#" settings will be updated. However, if you switch patterns during playback, these parameters will maintain the setting of the previous pattern.

These parameters are collectively referred to as the "setup parameters."

3

## Copying and Initializing Settings

### Setup Copy

This operation copies the setup parameters of a specified pattern to the temporary pattern.

#### 1. Press [PTN/SONG] to access the pattern select page.

#### 2. Press [UTILITY].

The indicator will light.

#### 3. Press PAGE [<] [>] several times to select "COPY," and press [ENTER].

#### 4. Press PAGE [<] [>] several times to select "SETUP PARAM," and press [ENTER].

The display will indicate the copy source pattern, copy source part, and copy destination part.

```
SETUP PARAM COPY
▶C:A11- P1→ P1
```

#### 5. Use [INC] [DEC] or the [VALUE] dial to specify the copy source pattern, the copy source part, and the copy destination part.

You can move the cursor by pressing PAGE [<] [>].

Available settings for the part:

P1-P7, R: Setup parameters of the specified part

FX: Effects setup parameters

ALL: All setup parameters

If the copy source part setting is "R," "FX" or "ALL," it will not be possible to specify the copy destination part.

#### 6. Press [ENTER].

The confirmation screen will appear in the display. If you decide to cancel the operation, press [EXIT].

```

SETUP PARAM COPY
Are You Sure ?
    
```

7. Press [ENTER] once again.

```

Processing...
Keep Power ON !
    
```

The Setup Copy operation will be carried out, then the normal display will reappear. To save the copied pattern, use the Pattern Write operation.

3

"Saving Patterns You've Modified (Pattern Write)" (p. 36)

### Pattern Initialize

This operation initializes a pattern to a state of containing no musical data (empty pattern).

1. Press [PTN/SONG] to access the pattern select page.
  2. Select the pattern that you wish to initialize.
- \* It is not possible to initialize if you select a preset pattern.*
3. Press [UTILITY].  
The indicator will light.
  4. Press PAGE [<] [>] several times to select "INITIALIZE," and press [ENTER].
  5. Select "PATTERN," and press [ENTER].  
The following display will appear.

```

PTN INIT    U:A11
Are You Sure ?
    
```

6. Press [ENTER].

```

Processing...
Keep Power ON !
    
```

The Pattern Initialize operation will be carried out, then the normal display will reappear. The pattern that was initialized will be saved automatically.

## Using the Knobs to Modify the Sound During Playback (Real-Time Modify)

You can freely modify the sound of a patch by moving the sound parameter knobs while a pattern is playing. This capability is referred to as Real-Time Modify, and is especially effective when used during a live performance. Realtime Modify adjusts the tone of the entire patch (rhythm set) selected for the current part, or the tone of an entire rhythm group.

1. Select a pattern, and play it (p. 30).
2. Use [PART SELECT] and PART [1]–[R] to select the part.

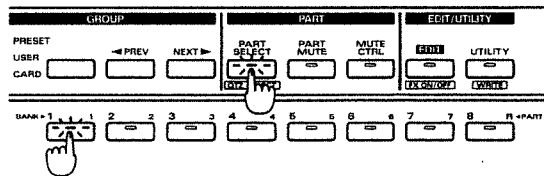

### The part(s) affected by Realtime Modify

The part(s) whose sound will be affected by Realtime Modify will depend on the Key Mode.

- Single:** The sound of the current part will be affected.
- Split:** The sound of the upper part will be affected when the [UPPER] indicator is lit, and the lower part when the [LOWER] indicator is lit.
- Dual:** The sounds of both the upper and lower parts will be affected.

3. Use the knobs to modify the sound.

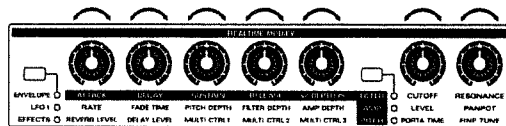

*\* When modifying the rhythm part, parameters of LFO1 and PORTAMENTO are not used.*

If you wish to learn about the function of each knob and button...

"Creating Original Sounds (Patch Edit)" (p. 53)

"Creating an Original Rhythm Set (Rhythm Edit)" (p. 85)

You can switch the current part during playback to change the part that you are modifying.

## Modifying the Sound for an Individual Rhythm Group

In the rhythm part, a different rhythm tone is assigned to each key, and you can use Real-Time Modify to modify the sound of rhythm tone groups such as Bass Drum or Snare Drum.

1. Select a pattern, and play it (p. 30).
2. Select the rhythm part as the current part.

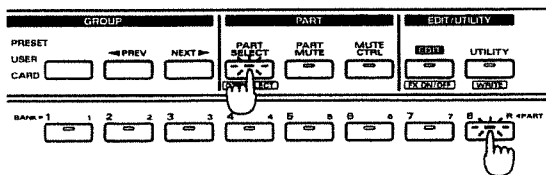

The indicator will light, and the RHYTHM buttons will indicate the rhythm group that is selected for Real-Time Modify.

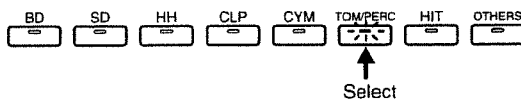

Rhythm groups with button indicators that are lit will be affected by Real-Time Modify.

For example, if you select [TOM/PERC], all toms and percussion-type rhythm tones in the rhythm set can be modified.

3. Press a button [BD]– [OTHERS] to select the rhythm group that will be affected by Real-Time Modify.

The indicator of the selected button will light.

*\* It is not possible to select two or more groups simultaneously.*

If no rhythm group is selected, all rhythm groups will be affected by Realtime Modify.

4. Use the knobs to modify the sound.

In addition to this, you can also modify each rhythm tone in the Rhythm Edit page.

"Creating an Original Rhythm Set" (Rhythm Edit) (p. 85)

By selecting a different part or rhythm group, you can change the object of your modifications even while the pattern is playing.

When the same pattern plays back repeatedly in Pattern mode, the modified parameter settings will remain as they are even if you return to the beginning of the pattern.

These knob movements are referred to as "modify data," and can be recorded in a pattern.

"Recording Knob Movements (Modify Data)" (p. 128)

## Returning a Pattern to Its Original State During Playback (Pattern Reset)

When you use Real-Time Modify, the pattern will remain in its modified state until a different pattern is selected. Here's how you can restore a modified pattern to its original state during playback.

3

### Restoring only the patch of a specific part that was modified

1. Press [PATCH] to access the patch select page.
2. Select the part that you wish to restore as the current part.
3. Press [UNDO/REDO].

The following display will appear.

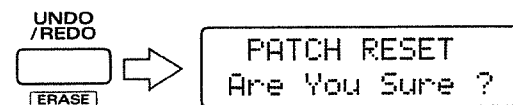

4. Press [ENTER] to return to the previous patch.

The "\*" (asterisk) at the left of the patch number will disappear.

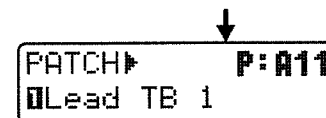

## Restoring the patch (rhythm set) and part mixer settings of all parts that were modified

1. In the pattern select page, re-select the pattern that is currently playing (p. 30).

The pattern will return to the beginning, and the original settings will be restored.

### The relation between modify data that was recorded and modify data from the knobs

If you perform Real-Time Modify while playing back a part for which modify data has already been recorded, the manual knob movements will take priority, and the modify data within the musical data for that part will be canceled, and will not be sent to the sound generator. (Note messages in the musical data will be sent to the sound generator regardless of knob operations.)

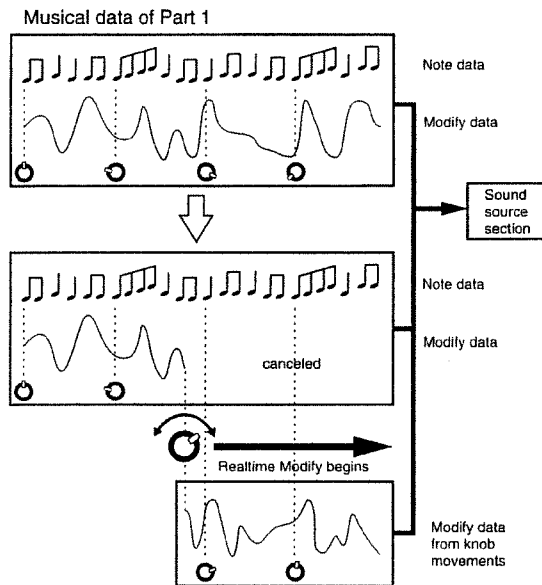

Modify Data that was canceled will once again be transmitted to the sound generator when the pattern returns to its beginning, or when you select a different pattern.

\* Each knob has eleven switching points as calibrated on the panel. Modify Data within the musical data will be canceled from the moment that a knob is moved through one of these points.

Switch point      Modify data is canceled

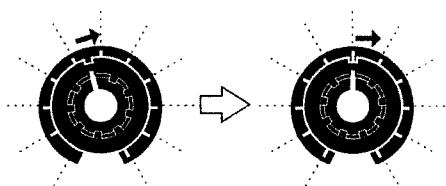

## Ensuring Correct Playback from the Middle of a Pattern (MIDI Update)

When a pattern is played back from the middle after fast-forward or rewind, some parts (depending on the pattern) may have incorrect pitch or volume. This is because when you move to a different location within a pattern, the musical data that was "skipped over" is not transmitted to the sound generator. In such cases, use the MIDI Update function so that the musical data (other than note messages) that lies between the beginning of the pattern and the current location will be transmitted to the sound generator, ensuring that playback will occur correctly.

1. Make sure that the pattern is stopped.

2. Hold down [SHIFT] and press [STOP/PLAY].

While this operation is being performed, the following display will appear.

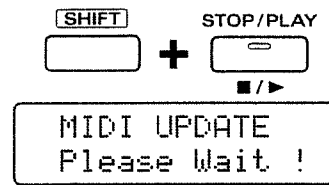

## Changing the Groove of a Pattern (Play Quantize)

Play Quantize is a function which modifies the pattern that is being played back by correcting or skewing the timing of the notes according to a specified rule. This means that you can modify only the timing with which the pattern will play back, without affecting the contents of the data itself.

The JX-305 provides three types of quantization, which you can use as appropriate for your situation. You can apply Play Quantize to a specified part while a pattern plays back, and make detailed timing adjustments in real time while you listen to the playback.

\* Quantization affects only the timing of the note messages (the timing at which notes are played and released), and does not modify the timing of other messages. This means that if a pattern contains messages (such as pitch bend) that apply real-time change to the sound, quantization settings may cause the timing of these messages to no longer match the timing of the note messages, so that playback will be incorrect. When applying quantization, it is best to use a pattern which does not contain messages that apply real-time change to the sound.

## Selecting Parts to Use with Play Quantize

Play Quantize can be applied to the playback of a specific part. Before you apply Play Quantize, you must specify the part(s) to which it will apply.

1. Hold down [SHIFT] and press [QTZ SELECT]. The button indicator will blink.

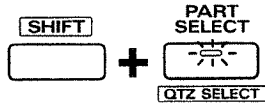

2. Use PART [1]-[R] to select the part(s) to which you wish to apply Play Quantize.

Play Quantize will be applied to the parts whose indicators are lit.



You can simultaneously select more than one part.

## Correcting Inaccuracies in the Rhythm (Grid Quantize)

Grid Quantize will quantize the pattern playback timing to the nearest specified note value. This will cause the pattern to play back with accurate timing.

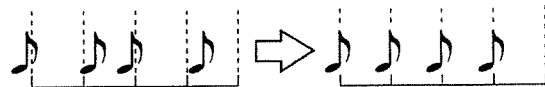

*\* When Grid Quantize is used, the playback timing will be correct, but conversely this may produce a mechanical, inhuman feel. If you wish to preserve the feel of the performance, you can set Resolution to a fine value, or lower the Strength setting.*

### Specifying the Unit (Resolution)

The note value unit to which quantization will adjust the timing is called the Resolution. The timing of notes will be adjusted to the nearest grid interval of the note value you specify here. Set this to the length of the smallest note value that occurs in the pattern.

1. Press [PTN/SONG].
2. Press [GRID/SHUFFLE/GROOVE] several times to make the GRID indicator light.

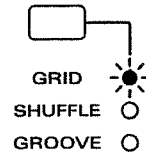

3. Press [EDIT].

The indicator will light and the display will show the Edit page.

4. Press NUMBER [7] (QUANTIZE).

The Grid Quantize setting page will appear.

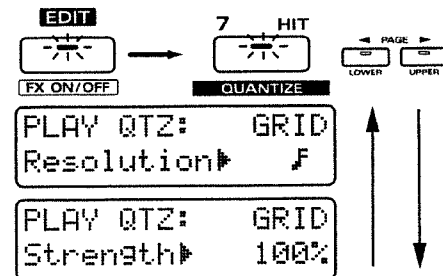

5. Use [INC] [DEC] or the [VALUE] dial to set the Resolution.

Range: ♪ ♪♪ ♪♪♪ ♪♪♪♪ ♪♪♪♪♪

To exit the setting page, press [EXIT].

When the GRID indicator is lit, you can also hold down [GRID/SHUFFLE/GROOVE] and rotate the [VALUE] dial to modify the Resolution.

### Applying Grid Quantize

1. Play back the pattern that you wish to quantize.
2. Press [GRID/SHUFFLE/GROOVE] several times to make the GRID indicator light.

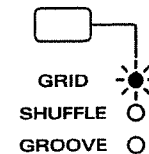

3. Grid Quantize will be applied to the playback data according to the Resolution setting.

4. In the QUANTIZE section, rotate the [TIMING] knob to adjust the Strength.

Range: 0-100%

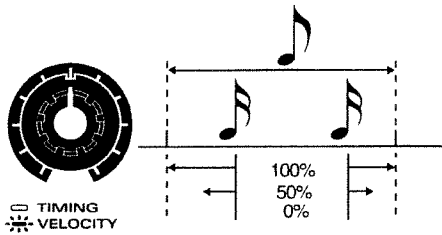

Strength specifies the degree to which the note timing will be corrected toward the note value specified by Resolution. Rotating the knob clockwise will cause the notes to be corrected all the way to their correct timing. When this setting is at "0%," the notes will be played at their original (un-quantized) timing.

3

In the Grid Quantize setting page, you can use PAGE [<] [>] to access the Strength setting page and view the numerical value of the knob setting while you apply quantization.

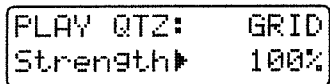

### Giving Swing to the Rhythm (Shuffle Quantize)

By applying Shuffle Quantize, you can adjust the timing of the backbeats of the pattern to create "bouncy" rhythms such as shuffle or swing.

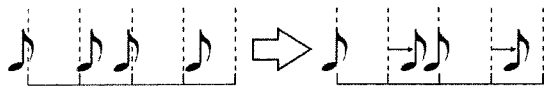

### Specifying the Unit (Resolution)

Specifies the Resolution. The timing of notes will be adjusted to the nearest grid interval of the note value you specify here. Set this to the length of the smallest note value that occurs in the pattern.

1. Press [PTN/SONG].
2. Press [GRID/SHUFFLE/GROOVE] several times to make the SHUFFLE indicator light.

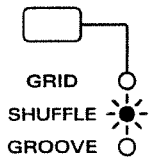

### 3. Press [EDIT].

The indicator will light and the display will show the Edit page.

### 4. Press NUMBER [7] (QUANTIZE).

The Shuffle Quantize setting page will appear.

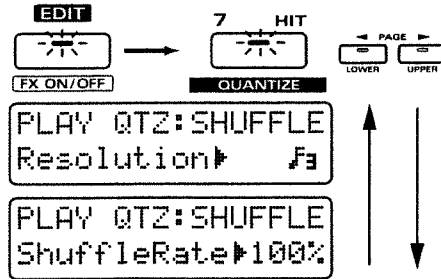

### 5. Use [INC] [DEC] or the [VALUE] dial to specify the Resolution.

Range: ♪ ♪

To exit the setting page, press [EXIT].

When the SHUFFLE indicator is lit, you can also hold down [GRID/SHUFFLE/GROOVE] and rotate the [VALUE] dial to modify the Resolution.

### Applying Shuffle Quantize

1. Play back the pattern that you wish to quantize.
2. Press [GRID/SHUFFLE/GROOVE] several times to make the SHUFFLE indicator light.

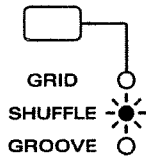

### 3. Shuffle Quantize will be applied according to the Resolution setting.

### 4. In the QUANTIZE section, rotate the [TIMING] knob to adjust the Shuffle Rate.

Range: 0–100 %

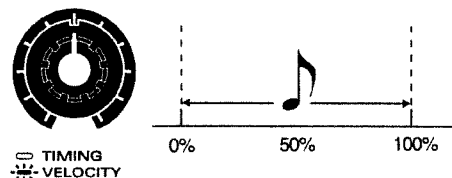

Shuffle Rate refers to the degree to which the backbeats will bounce, and specifies the ratio by which the backbeats will be separated from the downbeats. When the knob is in the center position, this setting is at 50%, and the backbeats will be located exactly between the adjacent downbeats.

Rotating the knob clockwise will move the backbeats later in time. Rotating the knob counterclockwise will move the backbeats earlier in time.

0%: Backbeats will fall at the same timing as the preceding downbeat.

100%: Backbeats will fall at the same timing as the following downbeat.

In the Shuffle Quantize setting page, you can use PAGE [<] [>] to access the Shuffle Rate setting page, and apply quantization while viewing the numerical setting of the knob.

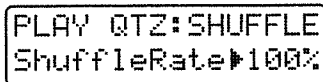

## Giving a Groove to the Rhythm (Groove Quantize)

Groove Quantize lets you select a template by which the playback timing and the velocity will be quantized. Simply by selecting a different template, you can give a variety of different-feeling grooves to a pattern. The JX-305 contains 71 different types of quantization templates, each of which contains a different set of playback timing and velocity (dynamics) data.

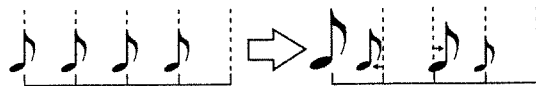

\* The templates are for use with 4/4 time signatures. They will not produce the desired result when applied to other time signatures.

### Selecting the Template

1. Press [PTN/SONG].
2. Press [GRID/SHFFLE/GROOVE] several times to make the GROOVE indicator light.

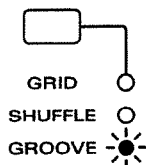

### 3. Press [EDIT].

The indicator will light and the display will show the Edit page.

### 4. Press NUMBER [7] (QUANTIZE).

The Groove Quantize Template setting page will appear.

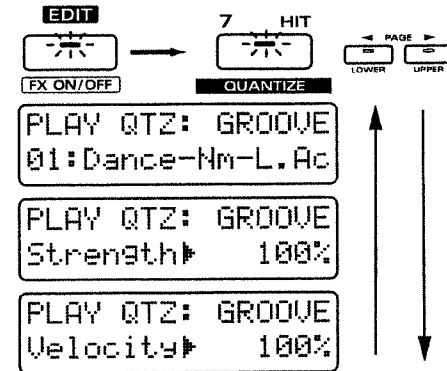

### 5. Use [INC] [DEC] or the [VALUE] dial to select the template.

To exit the setting page, press [EXIT].

Available Settings:

#### 16 Beat Dance type

01 : Dance-Nm-L.Ac	exact/low dynamics
02 : Dance-Nm-H.Ac	exact/high dynamics
03 : Dance-Nm-L.Sw	exact/light swing
04 : Dance-Nm-H.Sw	exact/strong swing
05 : Dance-Hv-L.Ac	dragging/low dynamics
06 : Dance-Hv-H.Ac	dragging/high dynamics
07 : Dance-Hv-L.Sw	dragging/light swing
08 : Dance-Hv-H.Sw	dragging/strong swing
09 : Dance-Ps-L.Ac	rushing/low dynamics
10 : Dance-Ps-H.Ac	rushing/high dynamics
11 : Dance-Ps-L.Sw	rushing/light swing
12 : Dance-Ps-H.Sw	rushing/strong swing

#### 16 Beat Fusion type

13 : Fuson-Nm-L.Ac	exact/low dynamics
14 : Fuson-Nm-H.Ac	exact/high dynamics
15 : Fuson-Nm-L.Sw	exact/light swing
16 : Fuson-Nm-H.Sw	exact/strong swing
17 : Fuson-Hv-L.Ac	dragging/low dynamics
18 : Fuson-Hv-H.Ac	dragging/high dynamics
19 : Fuson-Hv-L.Sw	dragging/light swing
20 : Fuson-Hv-H.Sw	dragging/strong swing
21 : Fuson-Ps-L.Ac	rushing/low dynamics
22 : Fuson-Ps-H.Ac	rushing/high dynamics
23 : Fuson-Ps-L.Sw	rushing/light swing
24 : Fuson-Ps-H.Sw	rushing/strong swing

### 16 Beat Reggae type

25 : Regge-Nm-L.Ac	exact/low dynamics
26 : Regge-Nm-H.Ac	exact/high dynamics
27 : Regge-Nm-L.Sw	exact/light swing
28 : Regge-Nm-H.Sw	exact/strong swing
29 : Regge-Hv-L.Ac	dragging/low dynamics
30 : Regge-Hv-H.Ac	dragging/high dynamics
31 : Regge-Hv-L.Sw	dragging/light swing
32 : Regge-Hv-H.Sw	dragging/strong swing
33 : Regge-Ps-L.Ac	rushing/low dynamics
34 : Regge-Ps-H.Ac	rushing/high dynamics
35 : Regge-Ps-L.Sw	rushing/light swing
36 : Regge-Ps-H.Sw	rushing/strong swing

### Others

61 : Samba 1	samba (pandero)
62 : Samba 2	samba (surdo and timba)
63 : Axe 1	axe (caixa)
64 : Axe 2	axe (surdo)
65 : Salsa 1	salsa (cascara)
66 : Salsa 2	salsa (conga)
67 : Triplets	triplets
68 : Quintuplets	quintuplets
69 : Sextuplets	sextuplets
70 : 7 against 2	seven notes played over two beats
71 : Lagging Tri	lagging triplets

## 3

### 8 Beat Pops type

37 : Pops-Nm-L.Ac	exact/low dynamics
38 : Pops-Nm-H.Ac	exact/high dynamics
39 : Pops-Nm-L.Sw	exact/light swing
40 : Pops-Nm-H.Sw	exact/strong swing
41 : Pops-Hv-L.Ac	dragging/low dynamics
42 : Pops-Hv-H.Ac	dragging/high dynamics
43 : Pops-Hv-L.Sw	dragging/light swing
44 : Pops-Hv-H.Sw	dragging/strong swing
45 : Pops-Ps-L.Ac	rushing/low dynamics
46 : Pops-Ps-H.Ac	rushing/high dynamics
47 : Pops-Ps-L.Sw	rushing/light swing
48 : Pops-Ps-H.Sw	rushing/strong swing

### 8 Beat Rhumba type

49 : Rhumb-Nm-L.Ac	exact/low dynamics
50 : Rhumb-Nm-H.Ac	exact/high dynamics
51 : Rhumb-Nm-L.Sw	exact/light swing
52 : Rhumb-Nm-H.Sw	exact/strong swing
53 : Rhumb-Hv-L.Ac	dragging/low dynamics
54 : Rhumb-Hv-H.Ac	dragging/high dynamics
55 : Rhumb-Hv-L.Sw	dragging/light swing
56 : Rhumb-Hv-H.Sw	dragging/strong swing
57 : Rhumb-Ps-L.Ac	rushing/low dynamics
58 : Rhumb-Ps-H.Ac	rushing/high dynamics
59 : Rhumb-Ps-L.Sw	rushing/light swing
60 : Rhumb-Ps-H.Sw	rushing/strong swing

### Selecting a template

Templates are categorized by the three elements of genre, groove, and variation. Select the template which combines the desired elements.

#### Genre

Dance	: 16 beat dance
Fuson	: 16 beat fusion
Regge	: 16 beat reggae
Pops	: 8 beat pops
Rhumb	: 8 beat rhumba
Others	: samba, axe, salsa, tuplets

#### Groove

Nm (Normal)	: on the beat
Hv (Heavy)	: "dragging" the beat
Ps (Pushed)	: "rushing" the beat

#### Variation

L.Ac (Light Accent)	: light dynamics
H.Ac (Hard Accent)	: heavy dynamics
L.Sw (Light Swing)	: light swing
H.Sw (Hard Swing)	: strong swing

For example, in the case of a dance song where you wish to drag the beat with light swing, you would select "Dance-Hv-L.Sw."

\* The genre names are only a guideline, and do not mean that those templates can be used only in the named genre. Try out additional possibilities.

\* If you apply Groove Quantize to musical data which contains inaccuracies in timing, you may not obtain the desired results. In such cases, it is best to apply Grid Quantize first, to bring the timing of the original musical data into alignment with the printed notes.



\* The templates are for use with 4/4 time signatures. Applying them to other time signatures may not produce the desired result.

\* For samba, axe, salsa and triplet, it is not possible to select groove or variation.

When the GROOVE indicator is lit, you can hold down [GRID/SHUFFLE/GROOVE] and rotate the [VALUE] dial to change the template.

### Applying Groove Quantize

1. Play back the pattern that you wish to quantize.
2. Press [GRID/SHUFFLE/GROOVE] to make the GROOVE indicator light.

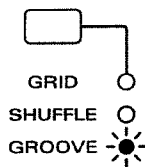

3. Groove Quantize will be applied according to the settings of the selected template.
4. In the QUANTIZE section, rotate the [TIMING] knob to adjust the Strength.

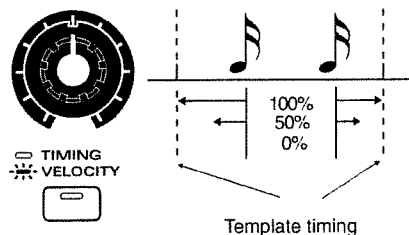

Range: 0–100%

Strength specifies the degree to which the note timing will be corrected toward the timings specified by the template. As the knob is rotated clockwise, the notes will be corrected further toward the timing of the template.

When this setting is at “0%,” the notes will be played at their original (un-quantized) timing.

5. Press [TIMING/VELOCITY] to make the indicator light, and rotate the [VELOCITY] knob to adjust the Velocity Strength.

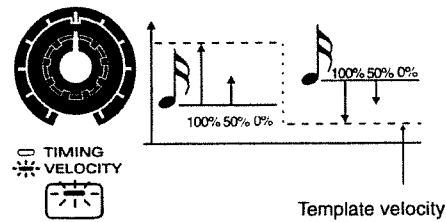

Range: 0–100%

Velocity Strength is the degree to which the velocities of the pattern will be adjusted toward the velocities of the template. As the knob is rotated clockwise, the velocities that are played will be closer to the velocities of the template.

When this setting is at “0%,” the notes will be played at their original velocities.

In the Groove Quantize setting page, you can also use PAGE [<] [>] to access the Strength or Velocity Strength setting pages, and use the knobs to adjust the setting while you view the numerical setting of the parameter.

### Techniques for creating a sense of groove

Templates use a variety of means to produce an optimal performance result for Groove Quantize. Refer to the following points as you use templates.

#### Apply Groove Quantize to drums and bass lines

The drums and bass are the most important parts in creating the groove. Thus, the templates are created to match these instruments. It is best to apply Groove Quantize only to instruments which need it.

#### Adjust the tempo

The groove templates have been created based on a tempo in the range of ♩=120–140. When applying Groove Quantize to a song with a faster tempo than this, set Strength to 100% for maximum effectiveness. For a song with a slower tempo than this, set Strength below 100%.

#### To create an effective swing

Careful attention to the tempo is an important part of creating an effective swing. For example, in the case of jazz, it will be effective to apply deeper swing to songs that have a slow tempo. Conversely, lightening the swing for a faster tempo will give a greater sense of speed. In another example, applying deeper swing to a dance-type rhythm at a rapid tempo will produce a feeling of “bounce.”

Try out various settings to find the most effective type of swing.

## Using Pedal for Control (Switch Pedal)

A pedal switch connected to the SWITCH PEDAL jack can be used to control the JX-305's sequencer.

### Specifying the Function of the Switch Pedal

**1. Press [EDIT].**

The indicator will light and the display will show the Edit page.

**2. Press BANK [5] (CONTROLLER).**

The Controller setting page will appear.

**3. Press BANK [5] (CONTROLLER) or PAGE [<] [>] several times to select the Switch Pedal Assign page.**

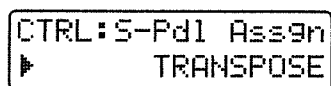

**4. Use [INC] [DEC] or the [VALUE] dial to specify the function of the switch pedal.**

Range:

**STOP/PLAY:** The pedal will act like the [STOP/PLAY] button.

**PTN INC:** (Pattern Increment) The patterns of the currently selected pattern set will be successively selected as the next pattern.

"Collecting Frequently Used Patterns in a Set (Pattern Set)" (p. 152)

**TRANPOSE:** The pedal will act like the [TRANPOSE] button (p. 32).

**SHIFT:** The pedal will act like the [SHIFT] button.

**RPS HOLD:** The RPS function can be held (p. 49).

**TAP:** The tempo will be modified to the interval at which you press the pedal.

**5. Once again press BANK [5] (CONTROLLER) or PAGE [>] to select the Switch Pedal Polarity page.**

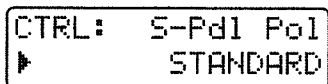

**6. Use [INC] [DEC] or the [VALUE] dial to switch the polarity of the pedal.**

Range: STANDARD, REVERSE

If you are using a pedal with inverted polarity (so the pedal functions in a way opposite from what you expect), select "REVERSE."

**7. Press [EXIT] to complete the setting.**

The original display will reappear.

Switch pedal settings have now been made.

### Using the Pedal to Change the Tempo

You can modify the tempo by the interval at which you press the pedal.

**1. Set the pedal switch setting to "TAP."**

**2. Press the pedal at least three times at quarter-note intervals of the desired tempo.**

The tempo will be calculated automatically, and the tempo will be changed to the interval at which you press the pedal.

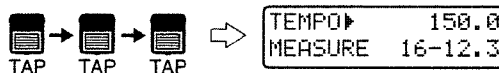

The pedal can be used to change the tempo even when the tempo value is not shown in the display.

The BEAT indicator will show the tempo and time signature.

The indicator will blink red on the first beat, and green on other beats.

## Simultaneously Changing the Tempo and Pitch (Turntable)

Turntable is a function which lets you use the pitch bend lever and modulation lever to affect the playback of a pattern. When you move the modulation lever, all parts will be instantly muted. When you move the pitch bend lever, the tempo and pitch will change simultaneously, producing an effect similar to when the pitch of a record turntable is changed.

### 1. Hold down [SHIFT] and move the modulation lever away from yourself.

The following screen will appear, and you will be able to use the pitch bend lever to control the Turntable function.

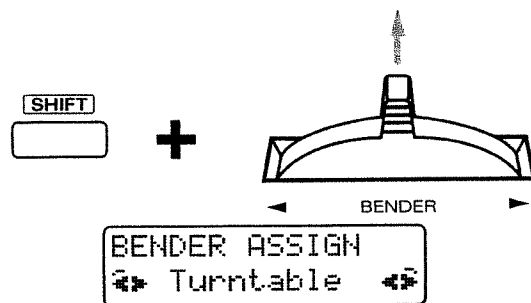

### 2. Move the pitch bend lever to left and right.

The tempo and pitch of all parts will change simultaneously.

Moving the pitch bend lever toward the left will simultaneously lower the tempo and pitch.

Moving it toward the right will simultaneously raise the pitch. Returning the lever to its normal position will restore the initial tempo and pitch.

*\* If the tempo of the pattern is fast, the tempo will not increase even if the pitch bend lever is moved toward the right.*

### 3. Move the modulation lever away from yourself.

While the modulation lever is moved away from yourself, all parts will be muted.

*\* The keyboard performance (including arpeggios) and RPS playback will not be muted.*

When the modulation lever is returned to its normal position, the initial mute status will be restored.

### 4. To turn off the Turntable effect, once again hold down [SHIFT] and move the modulation lever away from yourself.

The following screen will appear, and the pitch bend lever and modulation lever will return to their normal function.

```
BENDER ASSIGN
┌─ Pitch Bend ─┐
```

# Chapter 4. One-Touch Phrase Playback (RPS)

RPS (Realtime Phrase Sequence) is a function which lets you play back the musical data for one part of a pattern simply by pressing a specified note. You can play different phrases depending on the note that you press. Since you can play back RPS phrases while you play the keyboard or play back a pattern, this function is ideal for use during a live performance, etc. For example, if a drum fill-in phrase used by one pattern is assigned as an RPS, you can play back another pattern without a fill-in, and then add the fill-in simply by pressing a key.

## Pressing Notes to Play Back Phrases

4

On the JX-305, phrases assigned to the sixteen notes from C#2 to E3 are handled as one RPS set. The contents of an RPS set can be freely re-assigned later, and sixty different RPS sets can be stored in memory. The notes which can be used to assign phrases are the sixteen notes in the diagram except for the C2 note (RPS Stop).

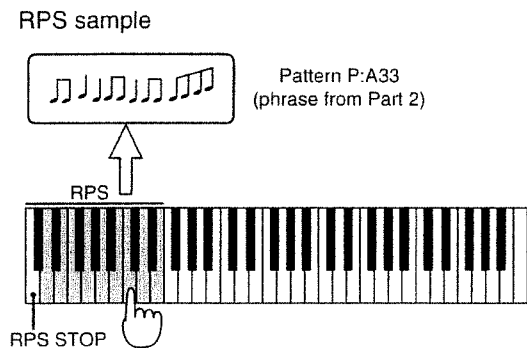

### 1. In the DISPLAY section, press [RPS SET].

The indicator will light, and the display will indicate the group, bank, number and name of the currently selected RPS set.

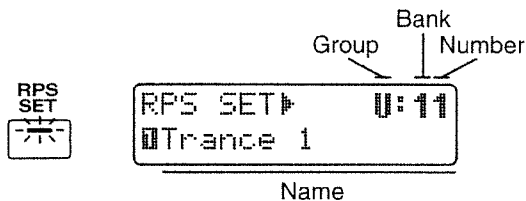

### 2. Use [INC] [DEC] or the [VALUE] dial to select the bank and number.

You can also use the BANK and NUMBER [1]-[8] buttons to select RPS sets.

Range: 11-84

The selection in the display will change.

The RPS set is now selected.

\* A brief interval of time is needed for the RPS set to change. Also, if you change RPS sets during pattern playback, the pattern may slow down or falter, so it is best to change RPS sets while pattern playback is stopped.

### 3. Press [RPS] to make the button indicator light.



### 4. Press a key to play back a phrase.

The phrase will play back while you continue pressing the key.

### RPS Modify

While you are pressing a key to play an RPS, you can move the Patch parameter knobs to modify the sound of the RPS. If you are pressing two or more keys, you can modify the sound of the key that was last pressed.

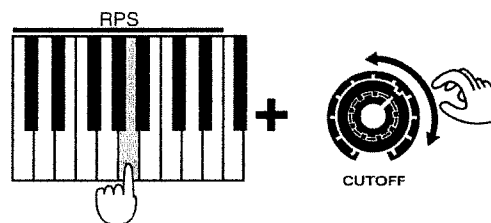

\* It is not possible to modify an RPS while editing a patch/rhythm set or when you enter the Part Mixer page.

\* When you release the note, the sound of the current part (not RPS) will be modified.

### RPS playback timing

If you use RPS while a pattern is playing back, the phrase will start in synchronization with the beat of the pattern.

By changing the RPS Trigger Quantize setting, you can modify the timing at which the RPS will play back.

☞ "Specifying the Timing for RPS Playback (RPS Trigger Quantize)" (p. 167)

### Maximum simultaneous RPS playback

Even while a pattern is playing back, the JX-305 can play back up to 8 phrases simultaneously. However, if phrases with large amounts of data are played back simultaneously, the timing may lag behind or notes may be interrupted. If this occurs, decrease the number of phrases that you play simultaneously.

## Causing a Phrase to Continue Playing (RPS Hold)

Normally, the phrase will stop playing when you take your finger off the note. However when the RPS Hold function is used, the phrase will continue playing even after you release the note.

There are two ways to hold an RPS phrase.

### Holding all phrases

**1. Hold down [HOLD] and press [RPS].**

The indicator will blink.

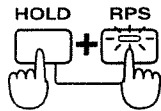

**2. Press a note to play back a phrase.**

The phrase will continue playing back even after you release the note.

You can press additional notes while the indicator is blinking, and their phrases will be held.

**3. To stop playback of a phrase, hold down the note of the phrase that you wish to stop, and press the note at the far left (RPS STOP).**

**4. To stop playback of all phrases, either press the note at the far left (RPS STOP), or once again press [RPS] and [HOLD] simultaneously.**

### Holding a specific phrases

**1. Press a note to play back the phrase that you wish to hold.**

**2. While continuing to press the note, press [HOLD].**

The phrase will continue playing even after you release the note.

If you release [HOLD] and then press and release other notes, their phrases will not be held.

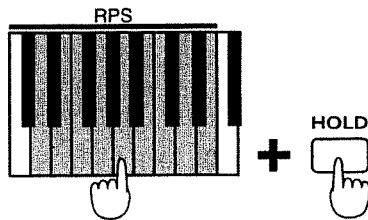

**3. To stop playback of a phrase, hold down the note to which that phrase is assigned, and press the note at the far left (RPS STOP).**

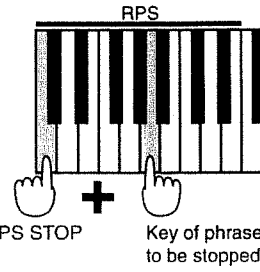

**4. To stop playback of all phrases, press the note at the far left (RPS STOP).**

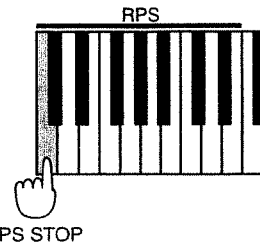

Alternatively, if you connect a pedal switch or foot switch (optional) and set the System setting "Switch Pedal Assign" to "RPS HOLD," the pedal switch can be used to hold RPS phrases in the same way as with the [HOLD] button (p. 46).

4

## Assigning Phrases to the Keyboard

The phrases that are assigned to an RPS set can be re-assigned whenever you wish. You will find it convenient to assign your favorite or frequently-used phrases in one RPS set. As an example, here's how to assign the phrase of part 2 of P:A12 in an RPS set.

First we must select the RPS set in which we will assign the phrase.

**1. Select the RPS set to which you wish to assign the phrase.**

**2. Select pattern P:A12.**

**3. Use [PART MUTE] and the PART buttons [1]-[R] to mute all parts except for part 2.**

\* You can quickly mute all parts except for part 2 by holding [PART MUTE] and pressing PART [2].

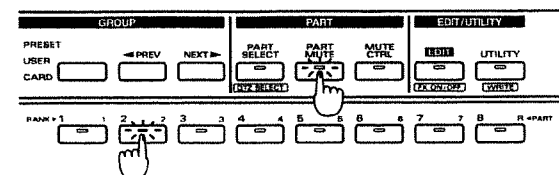

**4. Make sure that the [RPS] indicator is lit.**

**5. Hold down [RPS], and press the key to which you wish to assign the phrase.**

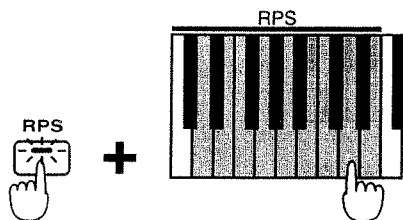

The phrase will be assigned to the key that you pressed. Phrases can be assigned even while a pattern is playing back.

P:E33–P:L88 contain patterns which are prepared specifically for use with RPS. You might find it convenient to assign phrases from these patterns to use as fill-ins, or for other situations.

4

**Cautions when assigning an RPS**

\* It is not possible to assign phrases of two or more parts to a single key. You must mute all but one of the parts, the one with the desired phrase, before assigning it. If any of the extra parts have been left unmuted when you make your assignment, the following message will appear in the display:

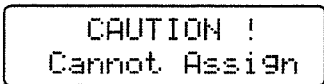

\* If after assigning a phrase from a user pattern as an RPS, you then modify the playback data of the pattern which contains that phrase, be aware that any change to the phrase will also be reflected in the way it is played back by RPS. For example, if you delete the musical data of the pattern which contains the phrase that you assigned, there will be no sound when you attempt to play back that phrase by RPS.

\* Even if you assign the phrase of a part that has a setting of "BOTH" or "EXT" for its Sequencer Output Assign (p. 36) parameter, the musical data of that phrase will not be transmitted from MIDI OUT.

\* If you assign a phrase from a part that uses multi-effects, the RPS playback will use the multi-effects settings of the pattern that is selected at that time. This means that what you hear when the RPS plays back may be somewhat different from the original phrase.

\* If a rhythm part phrase is assigned, the Rhythm Mute settings will be ignored during RPS playback.

\* Each phrase is played back by a special RPS part 1–16 which corresponds to each key, but phrases assigned from a rhythm part will be played back using the rhythm part of the currently-selected pattern. For this reason, a different rhythm set than that of the registered pattern may sound in some cases. If the pattern changes so that a different rhythm set is selected, the rhythm set which will play the RPS will also change.

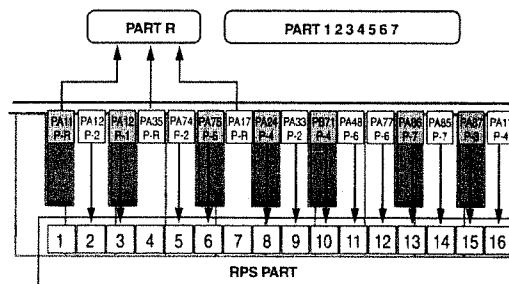

**Checking the pattern number and part that were registered**

If you hold down a key to which an RPS was registered and press [PTN/SONG], the pattern number, name and the part registered to that key will appear in the display while you continue pressing the key.

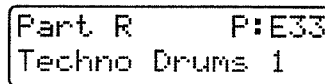

**Making Settings for Each Phrase**

**Using the Part Mixer to Modify Settings**

You can use the part mixer to modify settings such as volume and pan for each RPS part.

The following parameters can be modified for each RPS part.

- RPS Level (RPS Part Level)
- RPS Panpot (RPS Part Pan)
- RPS Key Shift (RPS Part Key Shift)
- RPS Reverb (RPS Part Reverb Level)
- RPS Delay (RPS Part Delay Level)
- RPS M-FX SW (RPS Part Multi-Effects Switch)

- 1. Make sure that the [RPS] indicator is lit.**
- 2. Hold down [RPS] and Press [MIXER].**

The indicator will light, and the display will graphically show the current setting of each RPS part.

**3. Press PAGE [<] [>] several times to select the parameter that you wish to modify.**

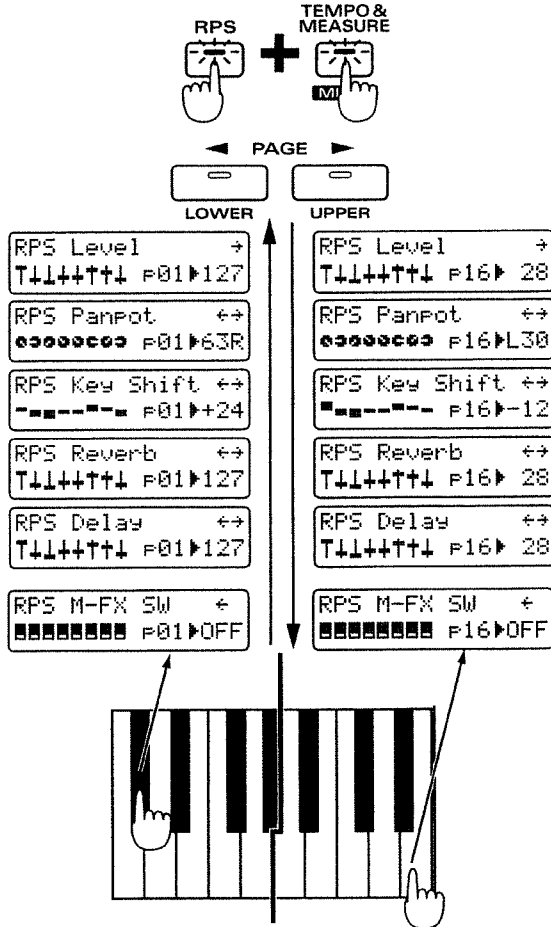

**4. Press a note to which a phrase has been registered to switch the part shown in the display.**

If you press any note C#2–G#2, the settings of RPS parts 1–8 will be graphically displayed.

If you press any note A2–E3, the settings of RPS parts 9–16 will be graphically displayed.

The right side of the display will indicate the current setting value of the selected RPS part.

**5. Use the eight knobs of the REALTIME MODIFY section and the QUANTIZE section to adjust the settings of each RPS part.**

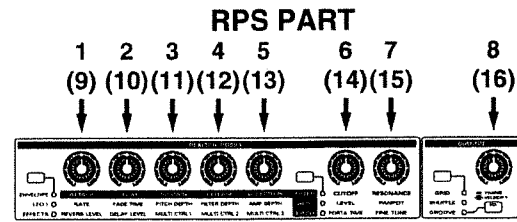

\* Keys to which a rhythm part phrase is assigned will reflect the rhythm part settings of the currently selected pattern. For example, if RPS phrases using the rhythm part are assigned to keys C#2 and D2, modifying the volume setting or rhythm set of C#2 key will cause the settings of D2 key and the rhythm part of the selected pattern to change in the same way.

## Changing the Patch of Each RPS Part

You can change the sound which plays each RPS part, so that the phrase assigned to each key will be heard with a different sound.

**1. Hold down [RPS] and press [PATCH].**

The indicator will light, and the following display will appear.

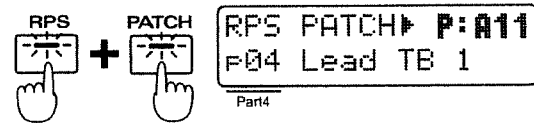

**2. Press the note for the phrase whose patch you wish to change to select the RPS part.**

The display will indicate the patch of the selected RPS part.

**3. Use [INC] [DEC] or the [VALUE] dial to select the desired patch.**

You can also use the GROUP section [PRESET/USER/CARD], [<PREV] [NEXT>] and BANK and NUMBER [1]–[8] buttons to select a patch.

\* If you change the rhythm set of a key to which a rhythm part phrase is registered, the rhythm set of the currently selected pattern will change in the same way.

## Saving the Phrases You Assigned (RPS Set Write)

When you have assigned phrases to create an RPS set that you like, here's how to save it as a User RPS Set.

1. Make sure that the pattern is stopped.
2. Press [RPS SET] to access the RPS Set Select page.

When you modify the contents of an RPS set, an asterisk "\*" will appear at the left of the number, indicating that the selected RPS set has been modified (edited). Be aware that if you turn off the power without saving the modified RPS set, the previous settings will reappear.

3. Hold down [SHIFT] and press [WRITE].

The indicator will blink.

The following display will appear, and a cursor "▶" will appear at the left of the number.

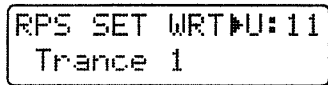
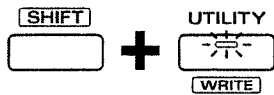

If you do not wish to change the bank, number or name, you may skip steps 4-7.

If you decide not to save the pattern, press [EXIT].

4. Use [INC] [DEC] or the [VALUE] dial to select the save destination bank and number.

You can also use the BANK and NUMBER [1]-[8] buttons to select an RPS set.

\* When saving an RPS set, only the user group can be selected.

At this time, you can press [UNDO/REDO] to check the name of the RPS set that is currently in the save destination number. After you have found an RPS set that you do not mind overwriting, press [UNDO/REDO] once again to return to the previous display.

5. Press PAGE [>].

The cursor will move to the beginning of the second line of the display.

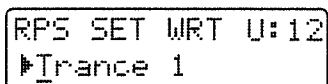

6. Assign a name to the RPS set.

Use [INC] [DEC] or the [VALUE] dial to specify the characters.

The following characters can be selected.

space, A-Z, a-z, 0-9, ! " # \$ % & ' ( ) \* + , - . / : ; < = > ? @ [ \ ] ^ \_ ` { | }

7. Repeat steps 5-6 to input the name.

By pressing PAGE [<] you can move the cursor back counterclockwise.

8. Press [ENTER].

The execute display will appear.

If you wish to cancel the operation, press [EXIT].

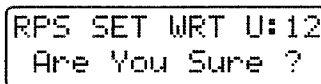

9. Press [ENTER] once again.

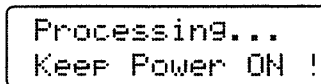

The RPS Set Write operation will be executed, and the normal display will reappear.

The RPS set has now been saved.



# Chapter 5. Creating Original Sounds (Patch Edit)

Although you can use Real-Time Modify to modify the sound of a patch in real time while a pattern plays, it is also possible to modify the various aspects of the sound beforehand to create the perfect patch for your music. This process is called Patch Edit, allows you to make detailed parameter settings for each tone. The sound parameters that can be set during patch editing are referred to as Patch parameters.

## The Basis for the Sound of a Patch (Tones)

### What a Tone Consists of

On the JX-305, the Tone is the smallest unit of sound. However it is not possible to play tones. Patches are the unit that you normally play, and tones are the building blocks which make up these patches. A tone contains the following elements.

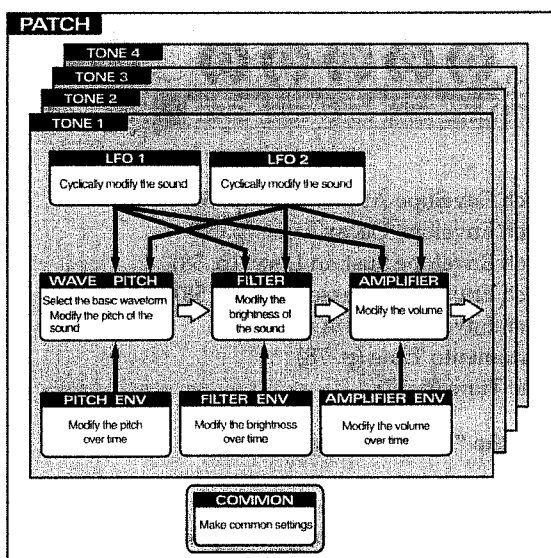

### WAVE

Select the PCM waveform (wave) that is the basis of the sound.

The JX-305 contains 636 types (A001–A254, B001–B251, C001–C131) of waveform. Each of the patches in the JX-305 consist of tones, which in turn are based on these waveforms.

### PITCH

Specify how the pitch will change.

### FILTER

Specify how the frequency components of the sound will change.

### AMPLIFIER

Specify how the volume and pan will change.

### LFO (Low Frequency Oscillator)

The LFO creates cyclic change (modulation). There are two LFOs, and these can apply change to the PITCH, FILTER, and AMPLIFIER. When the LFO is applied to pitch, a vibrato effect is produced. When the LFO is applied to filter cutoff frequency, a wah effect is produced, and when it is applied to the amplifier volume a tremolo effect is produced.

## Sound-Editing Procedure

1. Select one of the parts 1–7 as the current part.
2. Select the patch that you wish to edit (p. 18).
3. Make sure that the patch select page is displayed.
4. Press [EDIT].

The indicator will light, and the edit page will appear in the display.

```
EDIT:
Select Parameter
```

5. Select the patch parameter that you wish to modify, and edit it.

There are two ways to select patch parameters.

### Accessing the setting pages and editing

Here's how you can use NUMBER [1] (COMMON)–[7] (CONTROL) to access the various setting pages, use PAGE [<] [>] to switch parameter pages, and edit the desired parameter. This allows you to edit all parameters, and is a good method when you wish to create sounds in a logical sequence such as "waveform" → "pitch" → "brightness," and so forth.

Use [INC] [DEC] or the [VALUE] dial to modify the values.

For the procedure of how to access each setting page, refer to "Making More Detailed Settings."

### Using knobs or buttons to select an editing page

By operating a front panel knob or button, you can directly access the screen page for that parameter, and edit it. For example, if you rotate the [CUTOFF] knob, the display will automatically change to the Cutoff Frequency setting page, and you can edit the setting while viewing the values for each tone.

\* This method cannot be used to edit parameters for which there is no knob or button on the front panel.

### Parameters which are assigned to a knob

The parameters which can be adjusted by a knob are determined by the status of the [ENVELOPE/LFO1/EFFECTS] indicator and the [FILTER/AMP/PITCH] indicator.

5

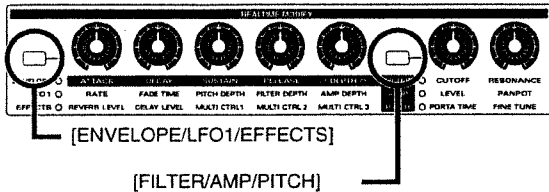

When the “ENVELOPE” indicator and “FILTER” indicator are lit

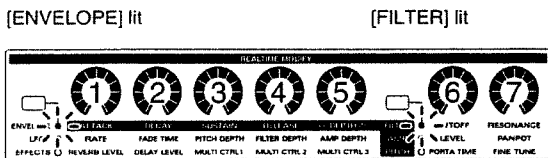

- 1: Filter Envelope Attack Time (p. 63)
- 2: Filter Envelope Decay Time (p. 63)
- 3: Filter Envelope Sustain Level (p. 63)
- 4: Filter Envelope Release Time (p. 63)
- 5: Filter Envelope Depth (p. 64)
- 6: Cutoff Frequency (p. 62)
- 7: Resonance (p. 63)

When the “ENVELOPE” indicator and “AMP” indicator are lit

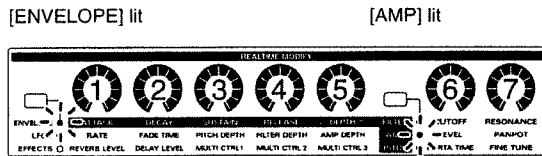

- 1: Amplifier Envelope Attack Time (p. 68)
- 2: Amplifier Envelope Decay Time (p. 68)
- 3: Amplifier Envelope Sustain Level (p. 68)
- 4: Amplifier Envelope Release Time (p. 68)
- 5: – No parameter is assigned.
- 6: Tone Level (p. 67)
- 7: Tone Pan (p. 67)

When the “ENVELOPE” indicator and “PITCH” indicator are lit

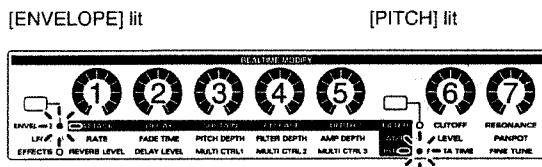

- 1: Pitch Envelope Attack Time (p. 58)
- 2: Pitch Envelope Decay Time (p. 58)
- 3: Pitch Envelope Sustain Level (p. 58)
- 4: Pitch Envelope Release Time (p. 58)
- 5: Pitch Envelope Depth (p. 59)
- 6: Portamento Time (p. 78)
- 7: Fine Tune (p. 57)

When the “LFO1” indicator is lit

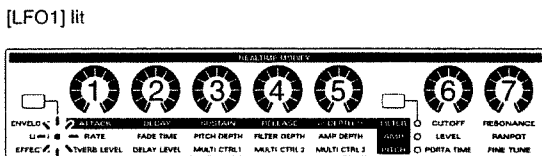

- 1: LFO1 Rate (p. 72)
- 2: LFO1 Fade Time (p. 74)
- 3: LFO1 Pitch Depth (p. 73)
- 4: LFO1 Filter Depth (p. 73)
- 5: LFO1 Amplifier Depth (p. 73)
- 6, 7: Determined by the [FILTER/AMP/PITCH] status

When the "EFFECTS" indicator is lit

[EFFECTS] lit

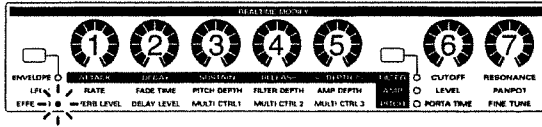

- 1: Reverb Level (p. 102)
- 2: Delay Level (p. 104)
- 3: Multi-Effects Control 1 (p. 107)
- 4: Multi-Effects Control 2 (p. 107)
- 5: Multi-Effects Control 3 (p. 106)
- 6, 7: Determined by the [FILTER/AMP/PITCH] status

\* During Patch Edit, it is not possible to access the editing page for the effect parameters.

**Accessing only the editing page without modifying the setting value**

If you wish to see the current setting before you make any changes, hold down [SHIFT] while you operate the knob, and you will access only the editing page without modifying the value.

**Maintaining the relative difference between tones when editing**

In an editing page, you can use [INC] [DEC] or the [VALUE] dial to edit while preserving the relative difference between tones. Use this method when appropriate.

The patch edit page will show the currently selected patch parameters and the settings of each tone.

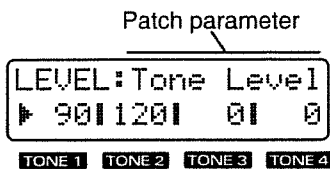

During patch editing, the BANK [1]–[8] indicators will show the following status.

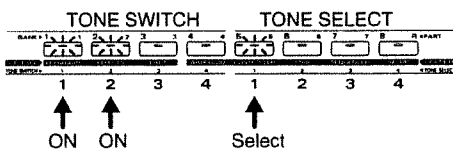

**Turning each tone on/off (Tone Switch)**

Of the tones which make up a patch, tones whose button indicator is lit are turned ON. You can press the button to switch each tone on/off.

**Selecting the tone for editing (Tone Select)**

The tone with a lit button indicator will be affected by your editing.

The tone to which your editing will apply is indicated by "▶" shown at the left of the value. In the following illustration, TONE 1 is being edited.

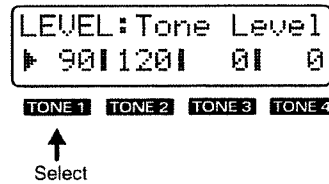

Press a button BANK [5]–[8] to select the tone that you wish to edit.

The indicator of the selected button will light, and "▶" will be displayed at the left of the setting value.

You can select two or more tones by holding down one of the buttons while you press another button.

**6. To exit the editing pages, press [EDIT] or [EXIT].**

An asterisk "\*" will be displayed at the left of the Group of an edited patch. This indicates that the settings of this patch have been modified.

If you select a different patch when the "\*" is displayed, the modified settings will be lost. If you wish to keep the edited patch, you must perform the Patch Write operation.

☞ "Saving Patches You've Created (Patch Write)" (p. 82)

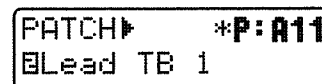

## Changing the Basic Waveform of the Sound (Wave/FXM)

Using the WAVE/FXM parameters, you can make settings related to the waveform that is the basis for a synthesizer's sound.

### 1. Press NUMBER [2] (WAVE).

The display will show the WAVE setting page.

### 2. Use PAGE [<] [>] to switch parameters and edit them.

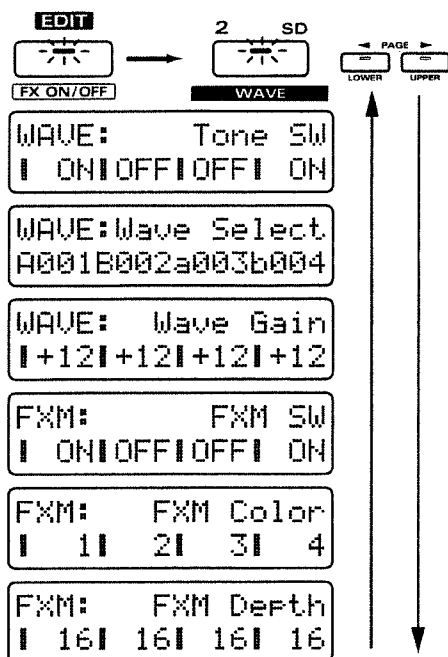

WAVE:	Waveform
A001TB	Dst. Saw
Number	Waveform name

If you would like to learn what waveforms are available...

→ "Waveform List" (p. 187)

It would not be an exaggeration to say that the major part of a sound is determined by the waveform that you select. Once you have an idea of the desired sound, select a waveform that you think will be suitable.

### Sawtooth wave

This is used as the original waveform for most instruments other than woodwinds. Many characteristic synthesizer sounds can be created using this waveform.

→ A001, A006–A008, A013–A021

### Square wave

This waveform is close to the sound of a woodwind instrument. Many characteristic synthesizer sounds can also be created using this waveform.

→ A002–A005, A009, A010, A022–A024

### Triangle wave

This waveform has fewer overtones, and produces a less distinctive sound. It is used for making flute-type sounds.

→ A038

### Sine wave

A soft sound without much character.

→ A039, A040

For most instrumental sounds, you will want to select one of the following types of waveforms.

Strings → C007–C010

Brass → A102–A108

Piano → C012–C014

Drums → A202–A254, B001–B251, C119–C131

### Wave Gain

This boosts the waveform. Raising this setting 6 dB will double the gain. If you are using the booster to distort the sound, setting this to the maximum value will be effective.

Range: -6, 0, +6, +12

5

### Tone SW (Tone Switch)

Turn this "ON" if you want the tone to sound, or "OFF" if you do not want the tone to sound.

In order to make the best use of the available polyphony, unused tones should be turned "OFF."

\* The setting of this parameter will be modified when you use BANK [1] – [4] to turn each tone on/off.

### Selecting the basic waveform (Wave Select)

For each tone, select the waveform that will be the basis of the sound.

Range: A001–A254, B001–B251, C001–C131

Your editing will apply to the tone(s) that has its group name (A/B/C) displayed in capital letters.

If only one tone is selected for editing, the waveform name will be displayed as follows:

 If you would like to learn more about booster gain settings...

☞ "Settings Common to the Entire Patch (Common)" (p. 77)

### FXM (Frequency Cross Modulation)

FXM (Frequency Cross Modulation) uses a specific waveform to apply frequency modulation to the selected waveform, creating complex overtones. This is useful for creating dramatic sounds or sound effects.

### FXM SW (FXM switch)

When you wish to use FXM, turn this "ON."

### FXM Color

Select one of four types of frequency modulation for FXM to apply.

Range: 1-4

As this value is increased, the sound will become rougher. Lower values will produce a metallic sound.

### FXM Depth

Adjusts the depth of frequency modulation produced by FXM.

Range: 1-16

As this value is increased, modulation will be applied more deeply. As the value is decreased, modulation depth will decrease.

## Pitch-Related Settings

Using the PITCH parameters you can make settings that affect the pitch.

### Modifying the Pitch (Pitch)

#### Fine adjustments to the pitch (Fine Tune)

You can adjust the pitch of each tone in 1-cent steps (1/100th of a semitone).

1. In the **REALTIME MODIFY** section, press [**FILTER/AMP/PITCH**] several times to make the **PITCH** indicator light.
2. Rotate the [**FINE TUNE**] knob to adjust the **Fine Tune** value.

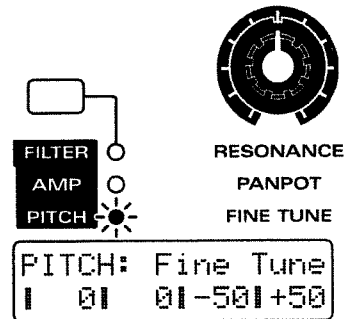

Range: -50→+50

Rotating the knob clockwise will raise the pitch. Rotating it counterclockwise will lower the pitch.

#### Approximate adjustments to the pitch (Coarse Tune)

Adjust the pitch of each tone in semitone steps.

1. In the **REALTIME MODIFY** section, press [**FILTER/AMP/PITCH**] several times to make the **PITCH** indicator light.
2. Hold down [**FILTER/AMP/PITCH**], and use [**INC**] [**DEC**] or the [**VALUE**] dial to set the **Coarse Tune** value.

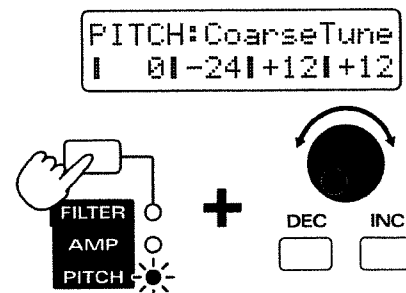

**Range: -48--+48 semitones**

The pitch will rise as this value is increased. The pitch will fall as this value is decreased.

By holding down [SHIFT] as you make the setting, you can change the pitch on one-octave steps (12 semitones).

**Making the sound more spacious**

If you select the same waveform for two tones, set the same Coarse Tune value for both tones and then use Fine Tune to create a slight pitch difference between the two tones, the sound will appear more spacious (the Detune effect).

**Making the Pitch Change Over Time (Pitch Envelope)**

On acoustic instruments, the pitch sometimes changes over time, from when the sound begins until it decays to silence. For example, on brass instruments such as the trumpet, there is a slight instability in pitch when the beginning of the note is blown. The P-ENV (Pitch Envelope) parameters let you make settings that specify this "change in pitch over time."

5

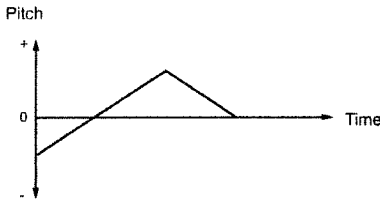

**Pitch envelope settings**

1. In the **REALTIME MODIFY** section, press **[FILTER/AMP/PITCH]** several times to make the **PITCH** indicator light.
2. Press **[ENVELOPE/LFO1/EFFECTS]** several times to make the **ENVELOPE** indicator light.
3. Use the **[ATTACK]** / **[DECAY]** / **[SUSTAIN]** / **[RELEASE]** knobs to set the pitch envelope values.

Available settings:

[ATTACK]/[DECAY]/[RELEASE]: 0-127

[SUSTAIN]: -63--+63

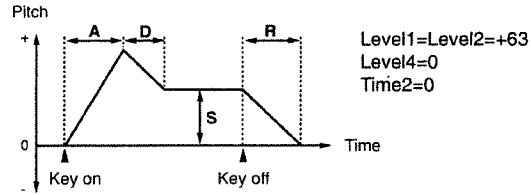
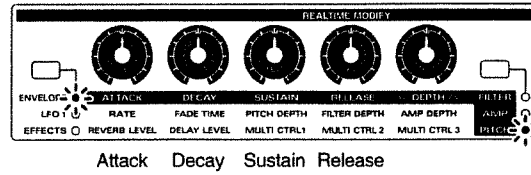

```
P-ENV: [A]Time1
| 20| 20| 0| 0
```

```
P-ENV: [D]Time3
| 30| 30| 0| 0
```

```
P-ENV: [S]Level13
| +63| +63| +63| +63
```

```
P-ENV: [R]Time4
| 0| 0| 0| 0
```

**[ATTACK] (Attack Time)**

The time from when the keyboard is played until the maximum pitch change is reached.

Higher settings will cause the pitch to change over a longer time.

**[DECAY] (Decay Time)**

The time from when the maximum pitch change is reached until the Sustain Level is reached.

Higher settings will cause the pitch to change over a longer time.

**[SUSTAIN] (Sustain Level)**

The pitch that will be held.

Positive (+) settings will make the pitch higher than the normal pitch (as specified by Coarse Tune and Fine Tune). Negative (-) settings will make the pitch lower than the normal pitch.

**[RELEASE] (Release Time)**

The time from when the keyboard is released until the pitch returns to the normal pitch.

Higher settings will cause the pitch to change over a longer time.

### Specifying the envelope depth (Pitch Envelope Depth)

Here's how you can adjust the depth of the Pitch Envelope.

1. In the **REALTIME MODIFY** section, press **[FILTER/AMP/PITCH]** several times to make the **PITCH** indicator light.
2. Press **[ENVELOPE/LFO1/EFFECTS]** several times to make the **ENVELOPE** indicator light.
3. Use the **[DEPTH]** knob to adjust the Pitch Envelope Depth.

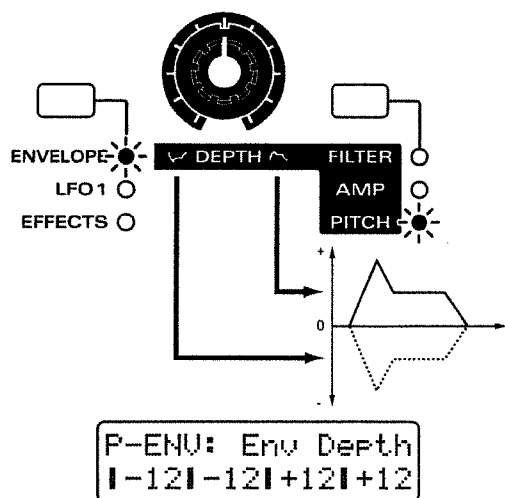

**Range: -12--+12**

Rotating the knob further toward the right of center will produce greater pitch change. Rotating the knob toward the left of center will invert the shape of the envelope, and rotating it further toward the left will produce greater pitch change.

With both the PITCH and ENVELOPE indicators lit, hold down **[ENVELOPE/LFO1/EFFECTS]**, and use **[INC]** **[DEC]** or the **[VALUE]** dial to set the Pitch Envelope Depth.

### Making More Detailed Settings

1. Press **NUMBER [3] (PITCH)**.  
The display will show the PITCH setting page.
2. Use **PAGE [<] [>]** to switch parameters and edit them.

The screenshot shows the PITCH parameter editing screen. At the top, there are buttons for EDIT, PITCH, and PAGE. The PITCH parameter is selected, and the screen displays a list of parameters for PITCH and P-ENU. The parameters are as follows:

- PITCH: Coarse Tune | 01-24 | +12 | +12
- PITCH: Fine Tune | 01 | 01-50 | +50
- PITCH: Rnd Pitch | 100 | 100 | 100 | 100
- PITCH: Key Follow | +50 | +50 | +50 | +50
- P-ENU: Env Depth | -12 | -12 | +12 | +12
- P-ENU: Velo Sens | 1 | 01 | 01 | 0
- P-ENU: Velo Time1 | 1 | 01 | 01 | 01 | 0
- P-ENU: Velo Time4 | 1 | 01 | 01 | 01 | 0
- P-ENU: Time KF | 1 | 01 | 01 | 01 | 0
- P-ENU: [A]Time1 | 1 | 20 | 20 | 01 | 0
- P-ENU: Time2 | 1 | 01 | 01 | 01 | 0
- P-ENU: [D]Time3 | 1 | 30 | 30 | 01 | 0
- P-ENU: [R]Time4 | 1 | 01 | 01 | 01 | 0
- P-ENU: Level1 | 1 | +63 | +63 | +63 | +63
- P-ENU: Level2 | 1 | +63 | +63 | +63 | +63
- P-ENU: [S]Level3 | 1 | +63 | +63 | +63 | +63
- P-ENU: Level4 | 1 | 01 | 01 | 01 | 0

#### Coarse Tune

This is the setting page for "Approximate adjustments to the pitch (Coarse Tune)" (p. 57).

### Fine Tune

This is the setting page for "Fine adjustments to the pitch (Fine Tune)" (p. 57).

### Rnd Pitch (Random Pitch Depth)

This applies a degree of randomness to the pitch of each note.

**Range:** 0–1200

As this value is increased, a greater degree of randomness will be applied. As this value is decreased, there will be less randomness.

With a value of "0" there will be no effect.

### Key Follow (Pitch Key Follow)

This setting causes the pitch to be affected by the key position.

Unless you are creating a special type of sound, you will normally leave this at "+100."

5

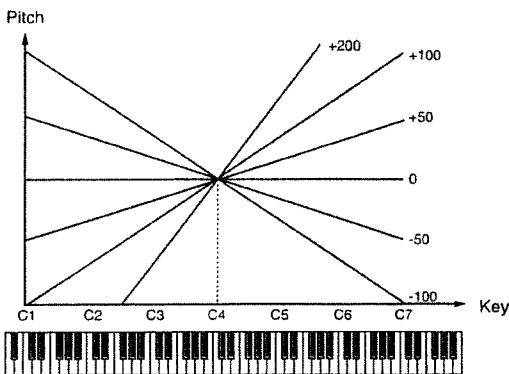

**Range:** -100–+200

With positive (+) settings, the pitch will rise as you play higher notes (i.e., notes toward the right of the keyboard). With negative (-) settings, the pitch will fall as you play higher notes.

**+100:** As on a conventional keyboard instrument, the pitch will rise one octave when you move 12 notes upward on the keyboard.

**+200:** The pitch will rise two octaves when you move 12 notes upward on the keyboard.

**0 :** The pitch will be the same regardless of which note you play.

**-100:** The pitch will fall one octave when you move 12 notes upward on the keyboard.

When you are creating sounds of instruments that naturally have minimal change in pitch, such as percussion instruments, it is effective to set Pitch Key Follow to a setting of "+10" or "+20."

### Env Depth (Pitch Envelope Depth)

This is the setting page for "Specifying the envelope depth (Pitch Envelope Depth) (p. 59)."

### Velo Sens (Pitch Envelope Velocity Sensitivity)

This setting lets you control the Pitch Envelope depth by the force with which you play the keyboard.

**Range:** -100–+150

With positive (+) settings, the pitch will change more greatly as you play the keyboard more strongly. With negative (-) settings, the pitch will change less as you play the keyboard more strongly.

**If you wish to change the loudness of the notes played on the keyboard...**

**"Changing the Loudness of Notes Played on the Keyboard (Keyboard Velocity)" (p. 163)**

When Velocity Sensitivity is set to a positive (+) value, softly-played notes will have little pitch change, and strongly-played notes will have greater pitch change; this lets you simulate "the pitch instability at the beginning of each note" that is characteristic of wind instruments.

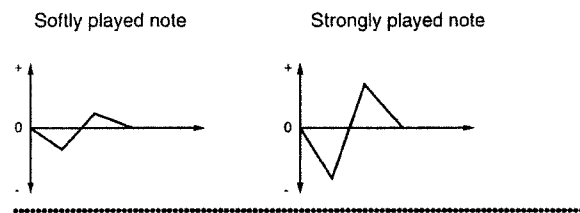

The four front panel knobs [ATTACK] / [DECAY] / [SUSTAIN] / [RELEASE] can be used to set the most commonly-used parameters of the pitch envelope, but the JX-305 also allows you to make more detailed pitch envelope settings.

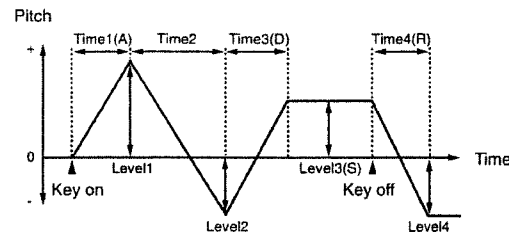

### Time 1–4 (Pitch Envelope Time 1–4)

Specifies the time until the next pitch level is reached. You can make settings for the four parameters Time 1–4.

**Range:** 0–127

Higher settings will result in a longer time until the next pitch level is reached.

\* The front panel parameter [ATTACK] (Attack Time) corresponds to Time1, [DECAY] (Decay Time) to Time3, and [RELEASE] (Release Time) to Time4.



### Level 1-4 (Pitch Envelope Level 1-4)

Specifies the pitch difference relative to the normal pitch (as specified by Coarse Tune and Fine Tune). You can make settings for the four parameters, Level 1-4.

Range: -63+63

Positive (+) settings will raise the pitch above the normal pitch. Negative (-) settings will lower the pitch below the normal pitch.

\* The front panel parameter [SUSTAIN] (Sustain Level) corresponds to Level3.

### Velo Time 1 (Pitch Envelope Velocity Time 1 Sensitivity)

This parameter lets your playing dynamics on the keyboard control the Time1 time.

Range: -100+100

With positive (+) settings, Time1 will become faster as you play the keyboard more strongly. With negative (-) settings, Time1 will become slower as you play the keyboard more strongly.

When Velocity Time 1 Sensitivity is set to a positive value, the pitch will change slowly for softly-played notes, and rapidly for strongly-played notes. This is useful for creating sound effects, and the like.

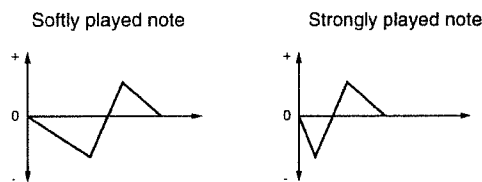

### Velo Time4 (Pitch Envelope Velocity Time 4 Sensitivity)

This lets you control Time4 by the speed at which you release the keyboard.

Range: -100+100

With positive (+) settings, releasing the keyboard more quickly will cause Time4 to be faster. With negative (-) settings, releasing the keyboard more quickly will cause Time4 to be slower.

### Time KF (Pitch Envelope Time Key Follow)

This setting causes the pitch envelope times (Time 2/3/4) to be affected by the key position.

Higher settings will produce a greater change relative to the C4 key envelope.

Range: -100+100

With positive (+) settings, times will become shorter as you play higher notes. With negative (-) settings, times will become longer as you play higher notes.

## Brightness-Related Settings (Filter)

Sound consists of a large number of overtones at various frequencies. By using a filter, you can cause only a specific range of overtones to be passed or attenuated, thus modifying the brightness. The FILTER parameters let you make settings that affect the brightness of the sound in this way.

### Modifying the Brightness of the Sound (Filter)

#### Selecting the type of filter (Filter Type)

Select the type of filter.

1. In the REALTIME MODIFY section, press [FILTER/AMP/PITCH] several times to make the FILTER indicator light.
2. Hold down [FILTER/AMP/PITCH], and use [INC] [DEC] or the [VALUE] dial to select the filter type.

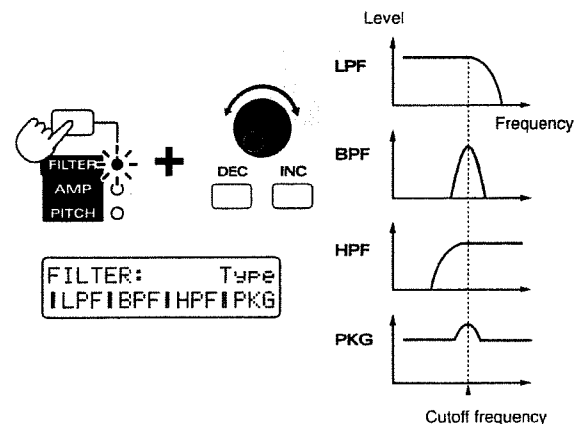

#### Available settings:

OFF:

The filter will not be used.

LPF (Low Pass Filter):

This is the most common type of filter, and allows frequencies below the cutoff frequency to pass. It is used to make the sound more mellow.

BPF (Band Pass Filter):

This filter allows frequencies in the region of the cutoff frequency to pass, and cuts the rest.

**HPF (High Pass Filter):**

This filter allows frequencies above the cutoff frequency to pass. It is used to make the sound brighter and sharper.

**PKG (Peaking Filter):**

This filter boosts the overtones in the region of the cutoff frequency. It will emphasize the mid-range, and is useful for creating a distinctive sound.

By selecting the Peaking Filter as the Filter Type and using the LFO to modulate the cutoff frequency, you can create a “wah” effect.

“Adjusting the depth of cutoff frequency modulation (LFO1 Filter Depth)” (p. 73)

**Brightening the sound (Cutoff Frequency)**

Specifies the frequency at which the filter will begin to affect the frequency components of the waveform (the Cutoff Frequency). By changing the cutoff frequency, you can control the brightness of the sound.

5

1. In the **REALTIME MODIFY** section, press **[FILTER/AMP/PITCH]** several times to make the **FILTER** indicator light.
2. Rotate the **[CUTOFF]** knob to adjust the cutoff frequency value.

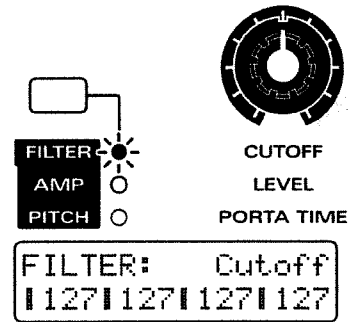

Range: 0–127

The effect will depend on the Filter Type.

**LPF (Low Pass Filter)**

Rotating the knob clockwise will cause the sound to become brighter, approaching the original waveform. Rotating it counterclockwise will cut more of the high frequency overtones, making the sound darker.

\* For some waveforms, you may not be able to hear any sound if you lower the value too far.

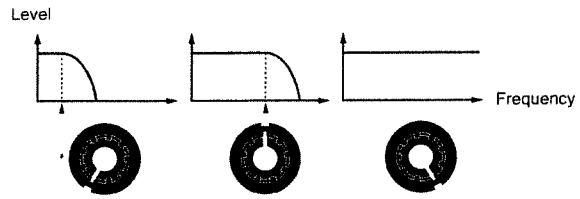

**BPF (Band Pass Filter)**

Rotating the knob clockwise will raise the frequency area that is heard. Rotating the knob counterclockwise will cause only a progressively lower frequency area to be heard.

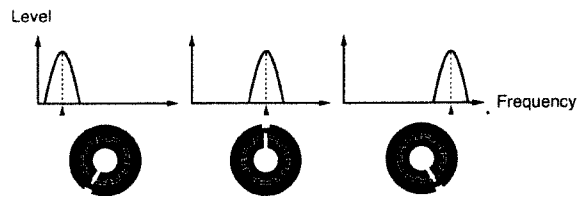

**HPF (High Pass Filter)**

When the knob is turned clockwise, the low frequency range will be cut more greatly, making the sound sharper. As the knob is rotated toward the left, the original sound of the waveform will be heard.

\* For some waveforms, you may hear no sound if this value is raised excessively.

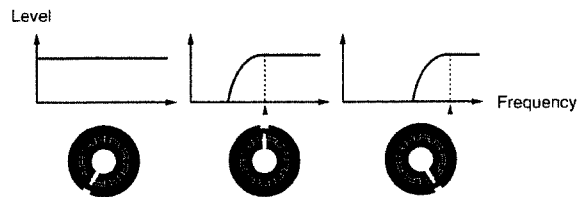

**PKG (Peaking Filter)**

When the knob is turned clockwise, the frequency area that is emphasized will rise. Rotating the knob counterclockwise will lower the frequency area that is emphasized.

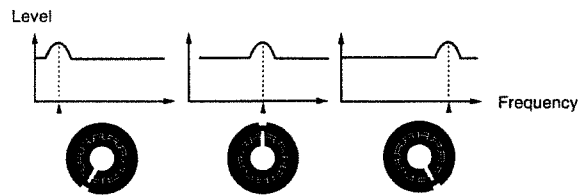

## Adding a distinctive character to the sound (Resonance)

This setting emphasizes the overtones in the region of the cutoff frequency, adding character to the sound.

1. In the **REALTIME MODIFY** section, press **[FILTER/AMP/PITCH]** several times to make the **FILTER** indicator light.
2. Rotate the **[RESONANCE]** knob to adjust the resonance setting.

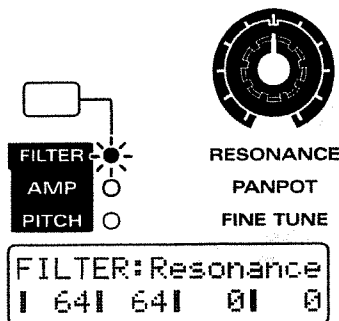

Range: 0–127

As the knob is rotated further clockwise, the sound will take on more character. Rotating it counterclockwise will make the sound more natural.

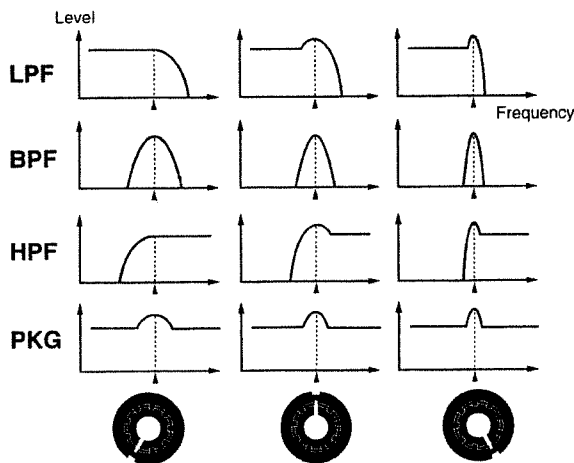

Depending on the cutoff frequency setting, raising the resonance excessively may cause the sound to distort suddenly.

In order to prevent the resonance from being increased excessively, factory settings have been made so that the value will not rise beyond "115" even if the **[RESONANCE]** knob is rotated all the way to the right. This is called the Resonance Limiter. You are free to adjust this upper limit.

"Specifying the Variable Range of Resonance (Resonance Limiter)" (p. 169)

If you have increased the Resonance Limiter setting, be careful not to raise the resonance excessively.

## Making the Brightness Change Over Time (Filter Envelope)

On acoustic instruments, the tone quality (brightness) often changes over the duration of a note. For example, on a piano, the sound at the beginning of each note contains many overtones (i.e., has a bright tone), and as the note decays to silence, the overtones diminish, making the sound more mellow. The **F-ENV** (Filter Envelope) parameters let you create this type of tonal change over time.

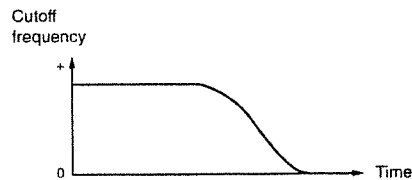

### Filter envelope settings

1. In the **REALTIME MODIFY** section, press **[FILTER/AMP/PITCH]** several times to make the **FILTER** indicator light.
2. Press **[ENVELOPE/LFO1/EFFECTS]** several times to make the **ENVELOPE** indicator light.
3. Use the **[ATTACK]** / **[DECAY]** / **[SUSTAIN]** / **[RELEASE]** knobs to adjust the filter envelope values.

Range: 0–127

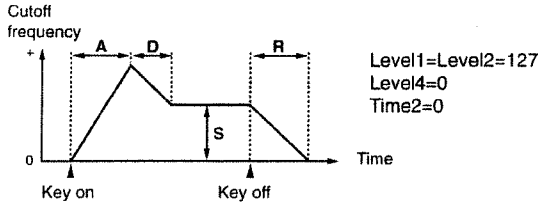
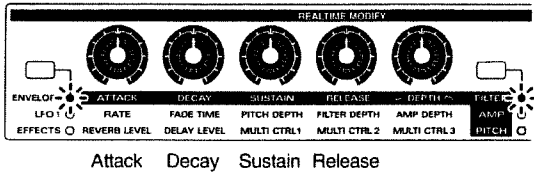

```

F-ENU: [A]Time1
| 10| 10| 10| 10
-----
F-ENU: [D]Time3
| 30| 30| 30| 30
-----
F-ENU: [S]Level13
|127|127|127|127
-----
F-ENU: [R]Time4
| 0| 0| 0| 0
    
```

5

**[ATTACK] (Attack Time)**

The time from when the keyboard is played until the maximum tonal change is reached. Higher settings will cause the tonal change to occur over a longer time.

**[DECAY] (Decay Time)**

The time from when the maximum tonal change is reached until the Sustain Level is reached. Higher settings will cause the tonal change to occur over a longer time.

**[SUSTAIN] (Sustain Level)**

The cutoff frequency level at which the tonal change will stabilize. Raising this setting will also raise the cutoff frequency.

**[RELEASE] (Release Time)**

The time from when the keyboard is released until the sound disappears. Higher settings will cause the tonal change to occur over a longer time.

**Specifying the depth of the envelope (Filter Envelope Depth)**

This setting adjusts the depth of the filter envelope.

1. In the REALTIME MODIFY section, press [FILTER/AMP/PITCH] several times to make the FILTER indicator light.
2. Press [ENVELOPE/LFO1/EFFECTS] several times to make the ENVELOPE indicator light.
3. Use the [DEPTH] knob to adjust the Filter Envelope Depth setting.

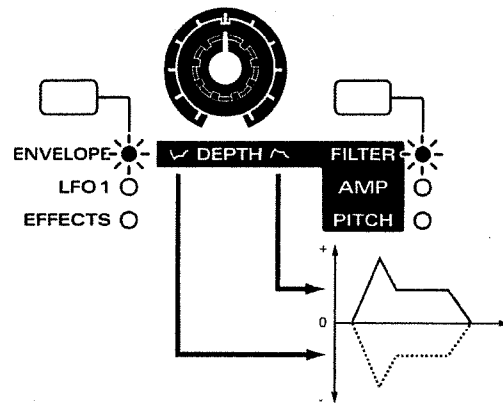

**Range: -63+63**

Rotating the knob toward the right of center will produce a greater change in the brightness. If the knob is rotated toward the left of center, the shape of the envelope will be inverted, and the brightness will change more greatly as the knob is rotated further.

When setting Envelope Depth to a positive (+) value, the effect of the filter envelope will be easier to hear if you set a lower cutoff frequency. (With negative (-) Envelope Depth values, set a higher cutoff frequency.)

With both the FILTER and ENVELOPE indicators lit, hold down [ENVELOPE/LFO1/EFFECTS], and use [INC] [DEC] or the [VALUE] dial to set the Filter Envelope Depth.

## Making More Detailed Settings

### 1. Press NUMBER [4] (FILTER).

The display will show the FILTER setting page.

### 2. Use PAGE [-] [>] to switch parameters and edit them.

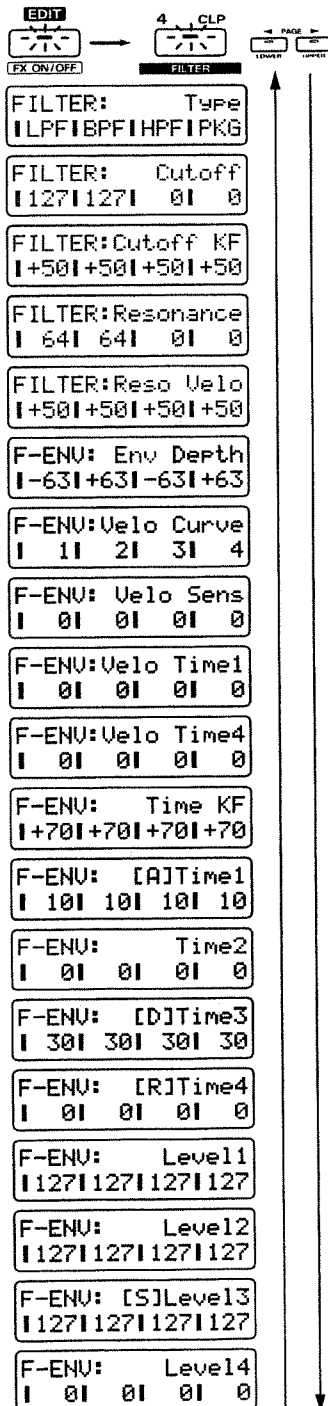

## Type (Filter Type)

This is the setting page for “Selecting the type of filter (Filter Type)” (p. 61).

## Cutoff (Cutoff Frequency)

This is the setting page for “Brightening the sound (Cutoff Frequency)” (p. 62).

## Cutoff KF (Cutoff Frequency Key Follow)

This setting causes the cutoff frequency to be affected by the key position.

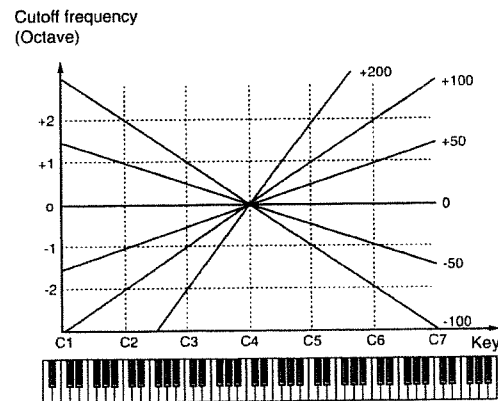

### Range: -100—+200

With positive (+) settings, the cutoff frequency will also rise as you play higher notes. With negative (-) settings, the cutoff frequency will become lower as you play higher notes.

**+100:** When you move 12 notes upward from C4 on the keyboard, the cutoff frequency will rise one octave.

**+200:** When you move 12 notes upward from C4 on the keyboard, the cutoff frequency will rise two octaves.

**0:** The cutoff frequency will be the same for all notes.

**-100:** When you move 12 notes upward from C4 on the keyboard, the cutoff frequency will fall one octave.

If you set Cutoff Frequency to a value of approximately “64,” the key follow effect will be easy to hear.

On acoustic instruments, the tone also changes as the pitch moves upward or downward. For example, the sound of a piano becomes slightly more mellow as you play higher notes. To simulate this type of effect, set Key Follow to approximately 70.

## Resonance

This is the setting page for “Adding a distinctive character to the sound (Resonance)” (p. 63).

### Reso Velo (Resonance Velocity Sensitivity)

Specifies how resonance depth will be affected by your playing dynamics on the keyboard.

Range: -100—+150

With positive (+) settings, playing the keyboard more strongly will cause the change to be greater. With negative (-) settings, playing the keyboard more strongly will cause the change to be less.

### Env Depth (Filter Envelope Depth)

This is the setting page for “Specifying the depth of the envelope (Filter Envelope Depth)” (p. 64).

### Velo Curve (Filter Envelope Velocity Curve)

Select the curve of change with which the force of your playing on the keyboard will affect the amount of change produced by the filter envelope.

Range: 1–7

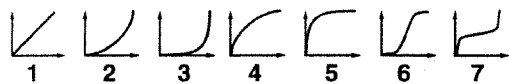

### Velo Sens (Filter Envelope Velocity Sensitivity)

Specifies how the force of your playing on the keyboard will affect the filter envelope.

Range: -100—+150

With positive (+) settings, the tone will change more as you play more strongly on the keyboard. With negative (-) settings, the tone will change less as you play more strongly on the keyboard.

If you wish to change the loudness of notes played on the keyboard...

“Changing the Loudness of Notes Played on the Keyboard (Keyboard Velocity)” (p. 163)

.....  
 With positive (+) settings of Velocity Sensitivity, the sound will be brighter for strongly-played notes, and darker for softly-played notes.  
 .....

The four front panel knobs [ATTACK] / [DECAY] / [SUSTAIN] / [RELEASE] can be used to set the most commonly-used parameters of the filter envelope, but the JX-305 also allows you to make more detailed filter envelope settings.

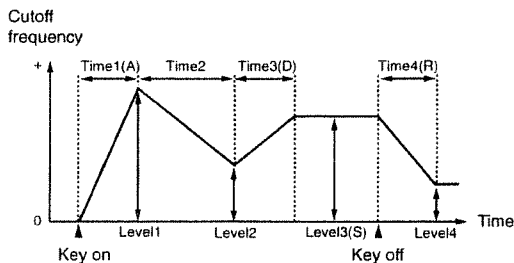

### Time1–4 (Filter Envelope Time 1–4)

Specifies the time until the next cutoff frequency is reached. You can set the four values Time1–4.

Range: 0–127

Higher settings will lengthen the time until the next cutoff frequency is reached.

\* The front panel [ATTACK] (Attack Time) corresponds to Time1, [DECAY] (Decay Time) to Time3, and [RELEASE] (Release Time) to Time4.

### Level1–4 (Filter Envelope Level 1–4)

Specifies the cutoff frequency at each level. You can set the four values Level1–4.

Range: 0–127

Higher settings will also raise the cutoff frequency.

\* The front panel [SUSTAIN] (Sustain Level) corresponds to Level3.

### Velo Time1 (Filter Envelope Velocity Time 1 Sensitivity)

Specifies how the dynamics of your playing on the keyboard will affect Time1.

Range: -100—+100

With positive (+) settings, Time1 will become faster as you play the keyboard more strongly. With negative (-) settings, Time1 will become slower as you play the keyboard more strongly.

### Velo Time4 (Filter Envelope Velocity Time 4 Sensitivity)

Specifies how the speed at which you release the keyboard will affect Time 4.

Range: -100—+100

With positive (+) settings, Time4 will become faster as you release the keyboard more quickly. With negative (-) settings, Time4 will become slower as you release the keyboard more quickly.

### Time KF (Filter Envelope Time Key Follow)

This setting causes the filter envelope times (Time 2/3/4) to be affected by the location of the key that you press.

Relative to the envelope at the C4 note, higher settings of this parameter will cause the times to change more greatly.

Range: -100→+100

With positive (+) settings, the times will become shorter as you play higher notes. With negative (-) settings, the times will become longer as you play higher notes.

For example, the notes of a piano change more rapidly in tone as their pitch rises (i.e., as you play up the keyboard). You can simulate this by setting Time Key Follow to a positive (+) setting.

## Settings Related to Volume and Pan (Amplifier)

The AMP (amplifier) parameters contain settings related to the volume and the position of the sound on the stereo sound field.

### Adjusting the Volume and Pan

#### Adjusting the volume of each tone (Tone Level)

This setting adjusts the volume of each tone. This is used mainly to adjust the volume balance between tones.

1. In the REALTIME MODIFY section, press [FILTER/AMP/PITCH] several times to make the AMP indicator light.
2. Rotate the [LEVEL] knob to adjust the Tone Level setting.

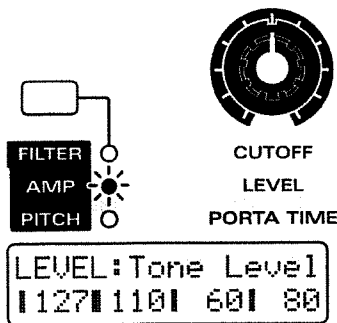

Range: 0-127

As the knob is rotated further clockwise, the volume will increase. As it is rotated counterclockwise, the volume will decrease.

\* The overall volume of the entire patch can be modified and memorized for each pattern as the Setup parameter Part Level. The Tone Level setting will be multiplied by this value.

📖 "Adjusting the volume of each part (Part Level)" (p. 33)

#### Adjusting the pan for each tone (Tone Pan)

This parameter sets the stereo location for each tone.

1. In the REALTIME MODIFY section, press [FILTER/AMP/PITCH] several times to make the AMP indicator light.
2. Rotate the [PANPOT] knob to set the Tone Pan value.

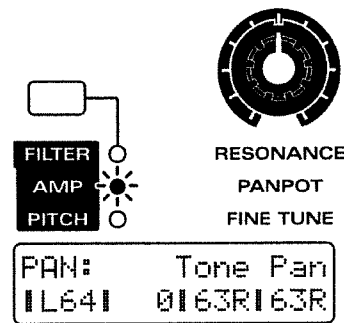

Range: L64-63R

As the knob is rotated further clockwise, the stereo location will shift toward the right. As it is rotated counterclockwise, the location will shift toward the left.

\* The pan of the overall patch can be modified and set for each pattern by the Setup parameter Part Pan. The Tone Pan value will be added to this setting.

📖 "Adjusting the pan of each part (Part Pan)" (p. 33)

#### Causing pan to change randomly (Random Pan Switch)

This setting causes the stereo location to change randomly each time a note is played.

1. In the REALTIME MODIFY section, press [FILTER/AMP/PITCH] several times to make the AMP indicator light.
2. Hold down [FILTER/AMP/PITCH] and use [INC] [DEC] or the [VALUE] dial to turn the Random Pan Switch on/off.

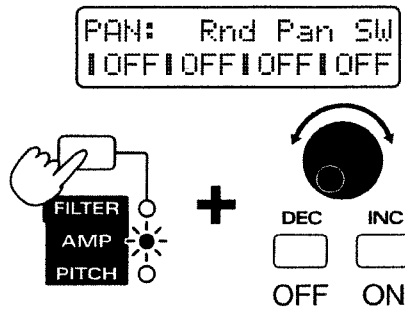

\* The Tone Pan setting will be ignored by Tones for which the Random Pan Switch is turned on.

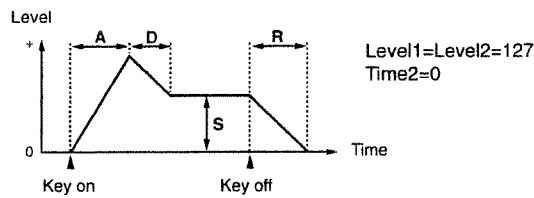
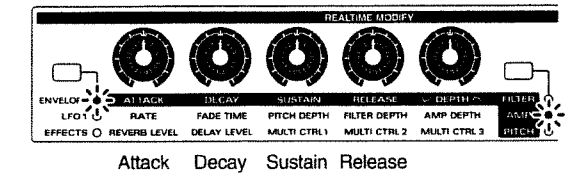

5

### Creating Time-Variable Change in Volume (Amplifier Envelope)

On acoustic instruments, change in volume occurs over the duration of each note. For example, on a piano, the volume reaches the maximum level immediately, and then gradually decays to silence (decay-type instruments). On instruments such as an organ, the volume remains constant as long as the note is held (sustaining instruments). The A-ENV (amplifier envelope) parameters let you specify this type of time-varying change in volume (the Amplifier Envelope).

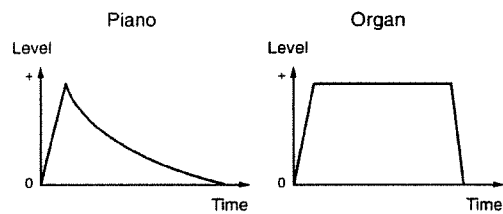

#### Amplifier envelope settings

1. In the **REALTIME MODIFY** section, press **[FILTER/AMP/PITCH]** several times to make the **AMP** indicator light.
2. Press **[ENVELOPE/LFO1/EFFECTS]** several times to make the **ENVELOPE** indicator light.
3. Use the **[ATTACK]** / **[DECAY]** / **[SUSTAIN]** / **[RELEASE]** knobs to set the amplifier envelope values.

Range: 0–127

With both the AMP and ENVELOPE indicators lit, hold down **[ENVELOPE/LFO1/EFFECTS]**, and use **[INC]** **[DEC]** or the **[VALUE]** dial to set the Amplifier Envelope Attack Depth.

```
A-ENV: [A]Time1
| 20| 20| 20| 20

A-ENV: [D]Time3
| 20| 20| 20| 20

A-ENV: [S]Level13
|127|127|127|127

A-ENV: [R]Time4
| 40| 40| 40| 40
```

#### [ATTACK] (Attack Time)

The time from when the keyboard is played until the maximum volume is reached. Higher settings will cause the volume to change over a longer time.

#### [DECAY] (Decay Time)

The time from when the maximum volume is reached until the Sustain Level is reached. Higher settings will cause the volume to change over a longer time.

#### [SUSTAIN] (Sustain Level)

The level at which the volume reaches a steady state. Higher settings will also raise the volume.

#### [RELEASE] (Release Time)

The time from when the keyboard is released until the volume decays to silence. Higher settings will cause the volume to change over a longer time.

### Making More Detailed Settings

#### 1. Press NUMBER [5] (AMPLIFIER).

The display will show the AMPLIFIER setting page.

#### 2. Use PAGE [**<**] [**>**] to switch parameters and edit them.



EDIT → 5\_Cym → FX ON/OFF → AMPLIFIER → TOWER → UPPER

LEVEL: Tone Level  
|127|110| 60| 80|

LEVEL: Bias Dir  
|LWR|UPR|L&U|ALL|

LEVEL: Bias Point  
|C-1|G 9|C-1|G 9|

LEVEL: Bias Level  
|+70|+70|+70|+70|

PAN: Tone Pan  
|L64| 0|63R|63R|

PAN: Pan KF  
|+70|+70|+70|+70|

PAN: Rnd Pan SW  
|OFF|OFF|OFF|OFF|

PAN: Alt Pan Dpth  
|63R|63R|63R|63R|

A-ENU: Velo Curve  
| 1| 2| 3| 4|

A-ENU: Velo Sens  
|+50|+50|+50|+50|

A-ENU: Velo Time1  
| 0| 0| 0| 0|

A-ENU: Velo Time4  
| 0| 0| 0| 0|

A-ENU: Time KF  
|+70|+70|+70|+70|

A-ENU: [A]Time1  
| 20| 20| 20| 20|

A-ENU: Time2  
| 0| 0| 0| 0|

A-ENU: [D]Time3  
| 20| 20| 20| 20|

A-ENU: [R]Time4  
| 40| 40| 40| 40|

A-ENU: Level1  
|127|127|127|127|

A-ENU: Level2  
|127|127|127|127|

A-ENU: [S]Level3  
|127|127|127|127|

**Tone Level**

This is the setting page for "Adjusting the volume of each tone (Tone Level)" (p. 67).

**Bias**

The Bias parameters specify how the key position will affect the Tone Level. This can be used to simulate the way in which the volume of an acoustic instrument changes according to the location (pitch) of the note.

**Bias Dir (Bias Direction)**

Select the keyboard area(s) that will be affected above and/or below the specified Bias Point.

Available settings:

- LWR:** The volume will be modified for the keyboard area below the note specified as the Bias Point.
- UPR:** The volume will be modified for the keyboard area above the note specified as the Bias Point.
- L&U:** The volume will be modified symmetrically toward the left and right of the note specified as the Bias Point.
- ALL:** The volume will be modified linearly from the note specified as the Bias Point.

**Bias Point**

Specifies the key relative to which the volume will be modified.

Range: C-1-G9

**Bias Level**

Adjusts the slope of the volume change that will occur in the direction specified by Bias Direction.

Range: -100+100

With positive (+) settings, the slope of volume change will increase in the positive (+) direction. With negative (-) settings, the slope of volume change will increase in the negative (-) direction.

\* Even with positive (+) settings of this parameter, the volume cannot exceed the maximum level.

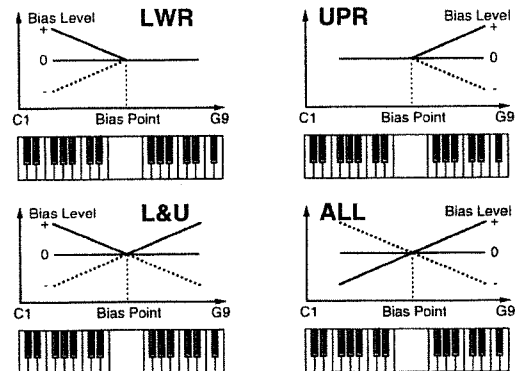

If you use two tones and set a Bias Direction of "UPR" for one and "LWR" for the other, the two tones will fade smoothly into each other as you play across the Bias Point. (This is known as "key crossfade.")

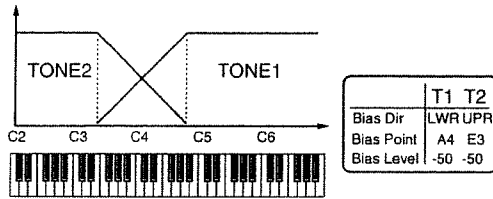

By setting Bias Direction to "L&U," you can create sounds that are heard only in a specific area of the keyboard.

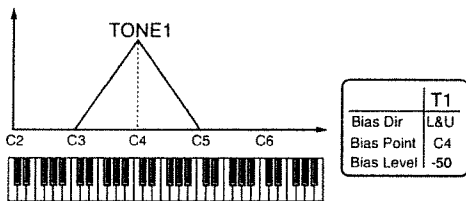

5

### Tone Pan

This is the setting page for "Adjusting the pan for each tone (Tone Pan)" (p. 67).

### Pan KF (Pan Key Follow)

This parameter causes the stereo location to change according to the key that is played.

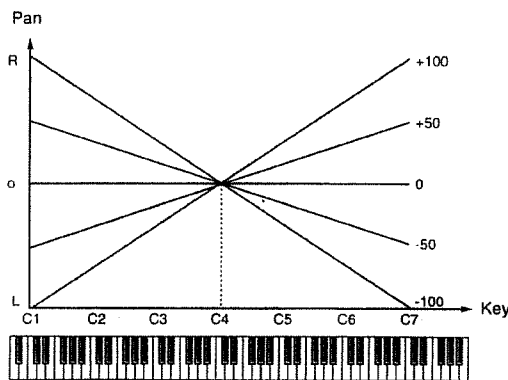

Range: -100+100

With positive (+) settings, the sound will move toward the right as you play higher notes. With negative (-) settings, the sound will move toward the left as you play higher notes.

### Rnd Pan SW (Random Pan Switch)

This is the setting page for "Causing pan to change randomly (Random Pan Switch)" (p. 67).

### Alt Pan Dpth (Alternate Pan Depth)

This parameter causes the stereo location of the sound to alternate between left and right each time a note is played.

Range: L63-63R

When this parameter is set in the L direction, the sound will alternate in the order of left → right → left → right. When set in the R direction, the sound will alternate in the order of right → left → right → left. Higher settings will cause greater change.

By using two tones and setting the Alternate Pan Depth of one to "L63" and of the other to "R63," you can make the two tones switch places alternately.

### Velo Curve (Amplifier Envelope Velocity Curve)

Select the curve at which the strength of your playing on the keyboard will affect the depth of the amplifier envelope.

Range: 1-7

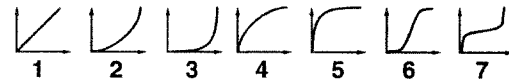

### Velo Sens (Amplifier Envelope Velocity Sensitivity)

Specifies how the depth of the amplifier envelope will be affected by the strength of your playing on the keyboard.

Range: -100+150

With positive (+) settings, the volume will increase as you play more strongly on the keyboard. With negative (-) settings, the volume will decrease as you play more strongly on the keyboard. If this is set to "0," the volume will not be affected by the strength of your playing on the keyboard.

If you wish to change the loudness of notes played on the keyboard...

See "Changing the Loudness of Notes Played on the Keyboard (Keyboard Velocity)" (p. 163)

If velocity sensitivity is set to a positive (+) value, the volume will be loud when you play strongly and soft when you play softly. As this value is increased, the volume difference between strongly played and softly played notes will gradually increase.

The four front panel knobs [ATTACK] / [DECAY] / [SUSTAIN] / [RELEASE] can be used to set the most common-used parameters of the amplifier envelope,

but the JX-305 also allows you to make more detailed amplifier envelope settings.

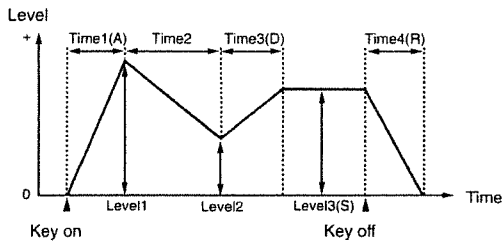

### Time 1-4 (Amplifier Envelope Time 1-4)

Specifies the time until the next level point is reached. This can be set for each of the four parameters Time 1-4.

**Range: 0-127**

Higher settings will lengthen the time until the next level point is reached.

\* The front panel parameter [ATTACK] (Attack Time) corresponds to Time1, [DECAY] (Decay Time) to Time3, and [RELEASE] (Release Time) to Time4.

### Level 1-3 (Amplifier Envelope Level 1-3)

These parameters specify the volume at each point. You can set the three points Level1-3.

**Range: 0-127**

Higher settings will also raise the volume.

\* The front panel [SUSTAIN] (Sustain Level) corresponds to Level3.

### Velo Time 1 (Amplifier Envelope Velocity Time 1 Sensitivity)

Specifies how Time1 will be affected by the strength of your playing on the keyboard.

**Range: -100+100**

With positive (+) settings, Time1 will become faster as you play the keyboard more strongly. With negative (-) settings, Time1 will become slower as you play the keyboard more strongly.

By setting Velocity Time 1 Sensitivity to positive (+) settings you can create volume changes that will be appropriate for strings-type sounds. The volume attack will be gradual for softly-played notes, and faster for strongly-played notes.

### Velo Time 4 (Amplifier Envelope Velocity Time 4 Sensitivity)

Specifies how Time 4 will be affected by the speed at which you release the keyboard.

**Range: -100+100**

With positive (+) settings, Time4 will become faster as you release the keyboard more quickly. With negative (-) settings, Time4 will become slower as you release the keyboard more quickly.

### Time KF (Amplifier Envelope Time Key Follow)

This parameter specifies how the amplifier envelope times (Time2/3/4) will be affected by the key location. Relative to the envelope of the C4 note, higher settings of this parameter will cause greater change in envelope times.

**Range: -100+100**

With positive (+) settings, envelope times will become shorter as you play higher notes. With negative (-) settings, envelope times will become longer as you play higher notes.

On instruments such as a piano, the volume decays more rapidly for higher notes. This can be simulated by setting Time Key Follow to positive (+) settings.

### Delay Start

For example, by setting Level1 to "0" and adjusting Time1 [ATTACK] appropriately, you can create envelopes in which the sound does not begin until a certain time after the key is pressed.

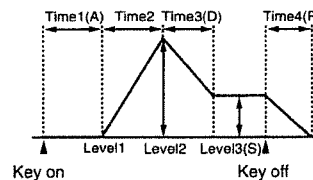

## Applying Cyclic Changes to the Sound (LFO)

The LFO (Low Frequency Oscillator) applies cyclic change to the sound. The JX-305 has two LFOs (LFO1/LFO2), and each of these can be used to modify the pitch, cutoff frequency or volume of each tone to create effects such as vibrato, wah and tremolo. Since both LFOs have the same parameters, the following explanation will cover both of them.

## Selecting the Waveform That Will Modulate the Sound (LFO1 Waveform)

Select the output waveform for LFO1. The sound will be modulated in the same shape as the selected waveform.

1. In the **REALTIME MODIFY** section, press **[ENVELOPE/LFO1/EFFECTS]** several times to make the LFO1 indicator light.
2. Hold down **[ENVELOPE/LFO1/EFFECTS]** and use **[INC]** **[DEC]** or the **[VALUE]** dial to select the LFO1 waveform.

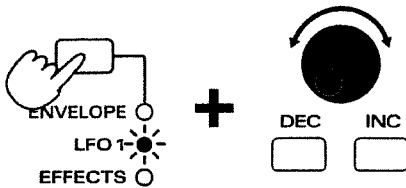
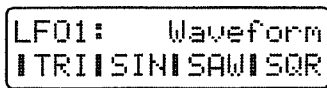

5

Available settings:

**TRI (triangle):** The sound will be modulated continuously. This is a frequently-used waveform, and is suited for effects such as vibrato.

**SIN (sine wave):** The sound will be modulated smoothly.

**SAW (sawtooth wave):** When the sound reaches the upper value, it will return to the original position and begin rising again.

**SQR (square wave):** The sound will be modulated as if it were being switched between two positions.

**TRP (trapezoid wave):** The sound will be modulated as if it were being switched between two positions. The curve at the transitions differs from square wave.

**S&H (sample & hold):** This setting causes the sound to change unpredictably, and is suitable for creating sound effects.

**RND (random):** This setting causes the sound to change unpredictably, and is suitable for creating sound effects.

**CHS (chaos):** This setting causes the sound to change unpredictably without regard to frequency, and is suitable for creating sound effects.

\* When *CHS (chaos)* is selected, the LFO rate setting will be ignored.

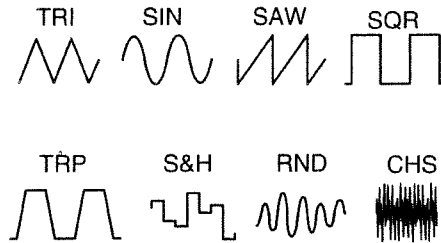

## Adjusting the Speed of Modulation (LFO1 Rate)

Here's how to adjust the modulation speed of LFO1.

1. In the **REALTIME MODIFY** section, press **[ENVELOPE/LFO1/EFFECTS]** several times to make the LFO1 indicator light.
2. Rotate the **[RATE]** knob to adjust the LFO1 rate.

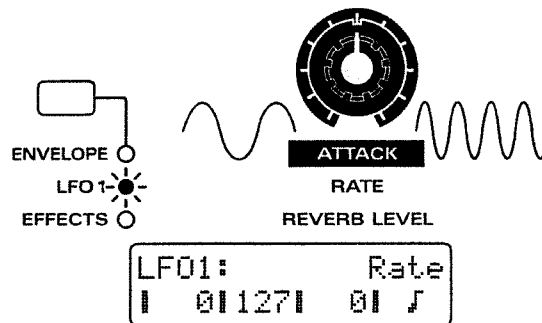

Range: 0-127

As the knob is rotated further clockwise, the sound will be modulated more rapidly. As the knob is rotated further counterclockwise, the sound will be modulated more slowly.

When LFO Tempo Sync (p. 74) is "ON," you can specify this parameter in terms of a note value.

Range: 0 880

At this time rotating the knob toward the right will cause the sound to be modulated more slowly.

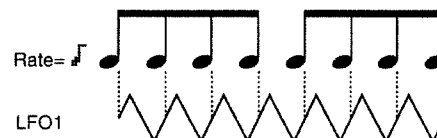

\* LFO Rate settings are common to PITCH (pitch), FILTER (brightness) and AMP (volume). The rate cannot be set independently for these three.

## Adjusting the Depth of Modulation (LFO1 Depth)

For each parameter, you can adjust the depth of the LFO effect.

Range: -63+63

The effect will increase as the knob is rotated further toward the right of center. Rotating the knob toward the left of center will invert the waveform, and the effect will increase as the knob is rotated further toward the left.

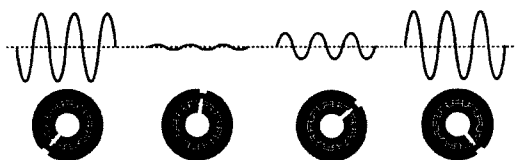

## Adjusting the depth of pitch modulation (LFO1 Pitch Depth)

By cyclically modulating the pitch you can create a vibrato effect.

1. In the REALTIME MODIFY section, press [ENVELOPE/LFO1/EFFECTS] several times to make the LFO1 indicator light.
2. Rotate the [PITCH DEPTH] knob to adjust the vibrato depth.

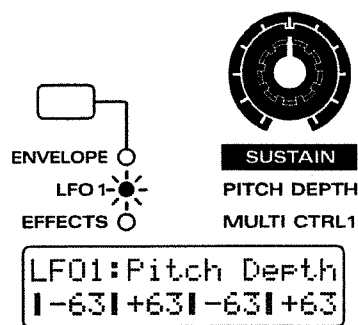

## Adjusting the depth of cutoff frequency modulation (LFO1 Filter Depth)

By cyclically modulating the cutoff frequency you can create a wah effect.

1. In the REALTIME MODIFY section, press [ENVELOPE/LFO1/EFFECTS] several times to make the LFO1 indicator light.
2. Rotate the [FILTER DEPTH] knob to adjust the wah depth.

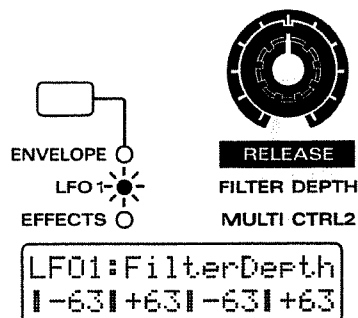

## Adjusting the depth of volume modulation (LFO1 Amplifier Depth)

By cyclically modulating the volume you can create a tremolo effect.

1. In the REALTIME MODIFY section, press [ENVELOPE/LFO1/EFFECTS] several times to make the LFO1 indicator light.
2. Rotate the [AMP DEPTH] knob to adjust the tremolo depth.

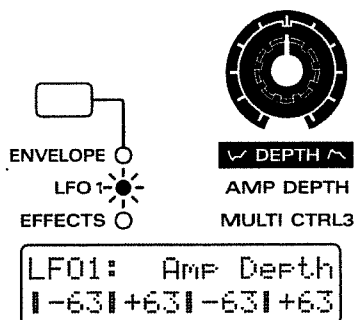

### Changing the time over which the maximum (minimum) modulation is reached (LFO1 Fade Time)

Specifies the time over which the LFO amplitude will reach the maximum (minimum) after the LFO1 Delay Time has elapsed.

1. In the **REALTIME MODIFY** section, press **[ENVELOPE/LFO1/EFFECTS]** several times to make the **LFO1** indicator light.
2. Rotate the **[FADE TIME]** knob to adjust the fade time.

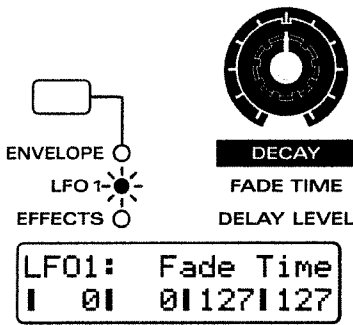

Range: 0-127

Higher settings will produce longer times. Refer to the diagrams for Fade Mode.

- ☞ "LFO1/LFO2 Fade Mode" (p. 75)
- ☞ "LFO1/LFO2 Delay Time" (p. 75)

\* The LFO2 parameters cannot be edited using the buttons and knobs in the **REALTIME MODIFY** section.

### Making More Detailed Settings

1. Press **NUMBER [6] (LFO)**.  
The display will show the LFO setting page.
2. Use **PAGE [<] [>]** to switch parameters and edit them.

\* Use this method to edit LFO2 parameters.

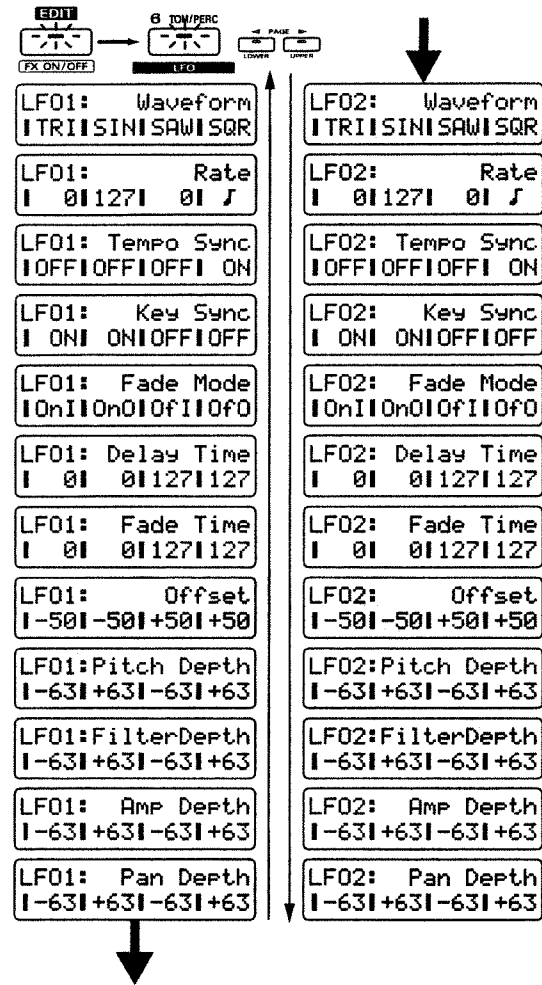

### Waveform (LFO1/LFO2 Waveform)

This is the setting page for "Selecting the Waveform That Will Modulate the Sound (LFO1 Waveform)" (p. 72).

### Rate (LFO1/LFO2 Rate)

This is the setting page for "Adjusting the Speed of Modulation (LFO1 Rate)" (p. 72).

### Tempo Sync (LFO1/LFO2 Tempo Sync)

This parameter synchronizes the LFO modulation frequency to the tempo of the pattern.

Available settings:

**ON** : The modulation speed will be synchronized to the tempo, and the LFO Rate parameter can be set in terms of a note value.

**OFF** : The modulation speed will be determined by the LFO Rate setting, regardless of the tempo.

### Key Sync (LFO1/LFO2 Key Sync)

This parameter synchronizes the LFO cycle to the timing at which the keyboard is played.

**Available settings:**

- ON** : The LFO cycle will begin when the keyboard is played.
- OFF** : The same LFO waveform will be output regardless of the timing at which the keyboard is played.

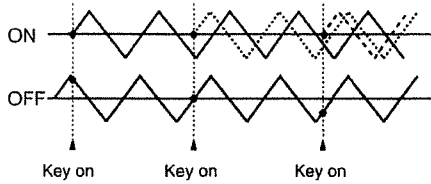

When Key Sync is on, the LFO waveform will begin for each note when it is played, producing a spacious sound with a sense of movement. When Key Sync is off, a single LFO waveform will be applied to all notes, producing a unified sound. When you wish to emphasize the effect (vibrato etc.), you may want to turn this parameter off. Also, when Tempo Sync is on, leaving Key Sync off will allow you to synchronize precisely to the tempo of the pattern.

### Fade Mode (LFO1/LFO2 Fade Mode)

Select the way in which the LFO effect will be applied.

**Available settings:**

- OnI (On-In):** The effect will be applied gradually, after the keyboard is played.
- OnO (On-OUT):** The effect will be applied immediately when the keyboard is played, and will gradually disappear.
- OffI (Off-In):** The effect will be applied gradually, starting when the keyboard is released.
- OffO (Off-Out):** The effect will be applied while the keyboard remains played, and will gradually disappear after it is released.

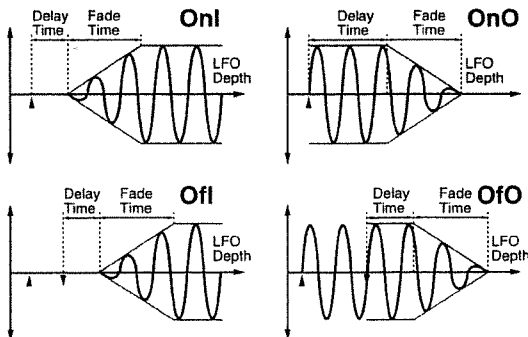

### Delay Time (LFO1/LFO2 Delay Time)

Depending on the Fade Mode setting, specify the time over which the LFO will be applied or the time over which it will continue, etc.

**Range: 0–127**

Higher settings will produce longer times.

### Fade Mode settings

- OnI:** Specifies the time from when the keyboard is played until the LFO begins to be applied.
- OnO:** Specifies the time that the LFO will continue after the keyboard is played.
- OffI:** Specifies the time from when the keyboard is released until the LFO begins to be applied.
- OffO:** Specifies the time that the LFO will continue after the keyboard is released.

Refer to the diagrams for Fade Mode.

### Fade Time (LFO1/LFO2 Fade Time)

This is the setting page for “Changing the time over which the maximum (minimum) modulation is reached (LFO1 Fade Time)” (p. 74).

5

### Offset (LFO1/LFO2 Level Offset)

This parameter offsets the LFO waveform upward or downward from the central value (pitch or cutoff frequency, etc.).

**Range: -100+100**

As this value is increased in the positive (+) direction, the waveform will be moved upward from the central value. As this value is increased in the negative (-) direction, the waveform will be moved downward from the central value.



### Pitch Depth (LFO1/LFO2 Pitch Depth)

This is the setting page for “Adjusting the depth of pitch modulation (LFO1 Pitch Depth)” (p. 73).

### Filter Depth (LFO1/LFO2 Filter Depth)

This is the setting page for “Adjusting the depth of cutoff frequency modulation (LFO1 Filter Depth)” (p. 73).

### Amp Depth (LFO1/LFO2 Amplifier Depth)

This is the setting page for “Adjusting the depth of volume modulation (LFO1 Amplifier Depth)” (p. 73).

### Pan Depth (LFO1/LFO2 Pan Depth)

Adjusts the effect that the LFO will have on pan (stereo location).

Range: -63+63

Setting values toward the positive (+) side of 0 will produce a greater change in panning. Setting values toward the negative (-) side of 0 will invert the waveform to change the pan in the opposite direction.

By giving two tones the same rate setting and setting their Pitch Depth to "+30" and "-30" respectively to apply opposite-phase LFO, you can create a vibrato effect in which the pitches change in opposite directions.

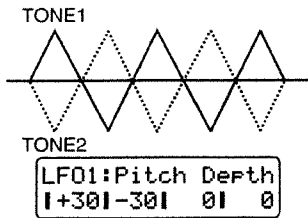

5

## Specifying the Parameters That Will Be Modified by Each Controller (Control)

These settings determine how the controllers (pitch bend lever, modulation lever, aftertouch) will control the patch parameters etc. of the JX-305.

These settings are divided into three groups, depending on the controller involved.

### Modulation Lever

This controller is used to apply vibrato or add various effects.

Settings for it are made using the MOD (Modulation) parameters.

### Pitch Bend Lever

This controller is normally used to control the pitch.

Settings for it are made using the BEND (Pitch Bend) parameters.

### Aftertouch

Aftertouch is a function which produces various types of change in the sound as you apply pressure to the keyboard after playing a note.

Settings for it are made using the AFT (Aftertouch) parameters.

### 1. Press NUMBER [7] (CONTROL).

The display will show the CONTROL setting page.

### 2. Use PAGE [<] [>] to switch parameters and edit them.

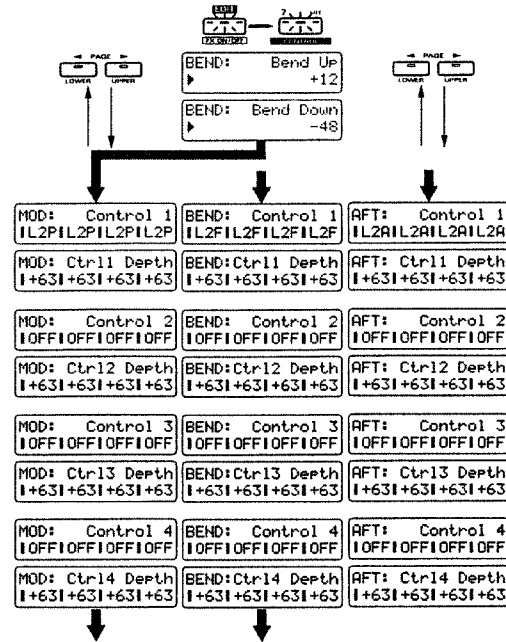

## Adjusting the Range of Pitch Bend (Bend Range)

### Bend Up/Down

Specifies the amount of pitch change (in semitone units) that will occur when the pitch bend lever is operated. You can make independent settings for movement to the right (raising the pitch) and left (lowering the pitch).

Available settings:

Bend Range Up : 0 - +12

Bend Range Down : 0 - -48

Higher settings will result in a greater pitch change when the pitch bend lever is moved to the left or right. For example, if Bend Range Up is set to "+12," the pitch will rise one octave when the pitch bend lever is moved to the right-most position.



## Control 1/2/3/4 (Control Destination 1/2/3/4)

Select the parameters that will be controlled when each controller is operated. For each controller, you can assign up to four parameters for each tone (Control 1 through Control 4).

Available settings:

- OFF: No control
- PCH: Pitch
- CUT: Cutoff Frequency (p. 62)
- RES: Resonance (p. 63)
- LEV: Tone Level (p. 67)
- PAN: Tone Pan (p. 67)
- L1P: LFO1 Pitch Depth (Vibrato) (p. 73)
- L2P: LFO2 Pitch Depth (Vibrato) (p. 75)
- L1F: LFO1 Filter Depth (Wah) (p. 73)
- L2F: LFO2 Filter Depth (Wah) (p. 75)
- L1A: LFO1 Amplifier Depth (Tremolo) (p. 73)
- L2A: LFO2 Amplifier Depth (Tremolo) (p. 75)
- L1p: LFO1 Pan Depth (p. 76)
- L2p: LFO2 Pan Depth (p. 76)
- L1R: LFO1 Rate (p. 72)
- L2R: LFO2 Rate (p. 74)

## Ctrl 1/2/3/4 Depth (Control 1/2/3/4 Depth)

Specifies the amount of change that will occur for each parameter selected as a control destination.

Range: -63+63

Setting values toward the positive (+) side of 0 will produce a greater change. Setting values toward the negative (-) side of 0 will invert the waveform to change in the opposite direction.

\* Parameters that are modified using controllers are modified only temporarily. The value of the parameter itself is not directly changed.

### Example of settings

Using LFO2 to apply vibrato controlled by the modulation lever

MOD: Control 1  L2P L2P L2P L2P	MOD: Ctr11 Depth  +63 +63 +63 +63
------------------------------------	--------------------------------------

For each tone, set the LFO2 Pitch Depth to "0," and the LFO2 Rate to approximately "90" (p. 75, 74).

Using the modulation lever to change the cutoff frequency

MOD: Control 1  CUT CUT CUT CUT	MOD: Ctr11 Depth  +63 +63 +63 +63
------------------------------------	--------------------------------------

Set the cutoff frequency of each tone to approximately "60" (p. 62).

Using the pitch bend lever to change the panning

BEND: Control 1  PAN PAN PAN PAN	BEND: Ctr11 Depth  +63 -63 +63 -63
-------------------------------------	---------------------------------------

For each tone, set the Tone Pan to "0," and the Bend Range Up/Down to "0" (p. 67, 76).

Using aftertouch to bend down

AFT: Control 1  PCH PCH PCH PCH	AFT: Ctr11 Depth  -63 -63 -63 -63
------------------------------------	--------------------------------------

## Settings Common to the Entire Patch (Common)

Here you can make settings that are common to the entire patch.

## Smoothly Changing the Pitch (Portamento)

You can make settings to apply a portamento effect.

### Portamento

Portamento is a function that smoothly connects the pitch of one note to the next. When the Solo switch is on, you can apply portamento to simulate the slide performance technique sometimes used on instruments such as violin.

## Turning portamento on/off (Portamento Switch)

Turn this on when you wish to use portamento.

### 1. Press [PORTAMENTO].

The indicator will light, and portamento will be turned on.

PORTAMENTO 	PORTAMENTO: SW ON
---	----------------------

### Adjusting the time over which the pitch will change (Portamento Time)

You can adjust the time over which the pitch will change when portamento is used.

1. In the **REALTIME MODIFY** section, press [**FILTER/AMP/PITCH**] several times to make the **PITCH** indicator light.
2. Rotate the [**PORTAMENTO TIME**] knob to set the portamento time value.

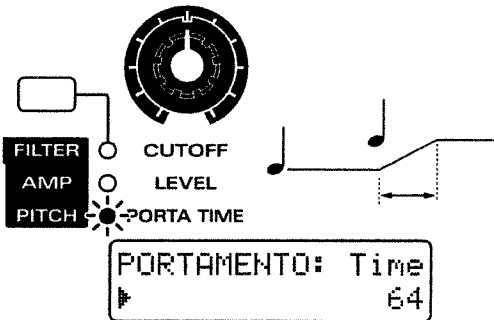

5

Range: 0-127

As the knob is rotated further clockwise, the pitch will take a longer time to reach the next note. As the knob is rotated counterclockwise, the pitch of the next note will be reached more quickly.

### Making More Detailed Settings

You can make settings that specify how the tones are combined and how the patch will be played, etc.

1. Press **NUMBER [1] (COMMON)**.  
The display will show the **COMMON** setting page.
2. Use **PAGE [<] [>]** to select parameters and edit them.

EDIT 1 BD  
FX ON/OFF COMMON  
SOLO: Solo SW ON  
SOLO: Solo Legato ON  
PORTAMENTO: SW ON  
PORTAMENTO: Mode NORMAL  
PORTAMENTO: Type RATE  
PORTAMENTO: Start PITCH  
PORTAMENTO: Time 100  
Strc|w-----F-A  
12|1|w-----f-a  
Strc|w-----F-A  
34|1|w-----f-a  
COM: Booster 1&2 0  
COM: Booster 3&4 0  
COM: Stretch Tune OFF  
COM: U-Priority LAST  
COM: Key Range L IC#1IC#1IC#1IC#1  
COM: Key Range U IG 9IG 9IG 9IG 9  
COM: Velo Range OFF  
COM: Velo Range L I 1I 1I 1I 1  
COM: Velo Range U I127I127I127I127  
COM: Velo X-Fade I127I127I127I127

### Solo SW (Solo Switch)

By turning on the Solo switch, you can play monophonically (one note at a time). It is effective to turn Solo on when playing synth lead or synth bass sounds.

Range: OFF, ON

### Solo Legato (Solo Legato Switch)

Solo Legato is a function that can be applied when the Solo Switch is on. When Solo Legato is on, playing a note while the previous note is still held will cause only the pitch to change, without generating a new attack. This creates a smooth transition between notes, which is effective when you wish to simulate the hammering-on and pulling-off techniques used by a guitarist.

Range: OFF, ON

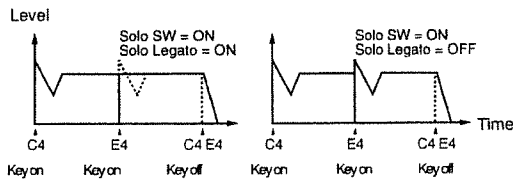

### Portamento SW (Portamento Switch)

This is the setting page for "Turning portamento on/off (Portamento Switch)" (p. 77).

### Portamento Mode

Select the performance technique by which portamento will be applied.

Available settings:

**NORMAL** : Portamento will always be applied.

**LEGATO** : Portamento will be applied for notes played legato (i.e., notes played before the previous note is released).

### Portamento Type

Select the type of the portamento effect.

Available settings:

**RATE** : The time over which the pitch change occurs will depend on the distance between the two pitches.

**TIME** : The pitch change will occur over a fixed time, regardless of the distance between pitches.

### Portamento Start (Portamento Start Pitch)

When portamento is on, pressing another key during the pitch change will cause a new pitch change to begin. This parameter specifies the pitch at which the change will begin.

Available settings:

**PITCH** : When another key is pressed while the pitch is changing, the new portamento movement will begin from the pitch at that moment.

**NOTE** : The new portamento movement will begin from the pitch toward which it had been moving.

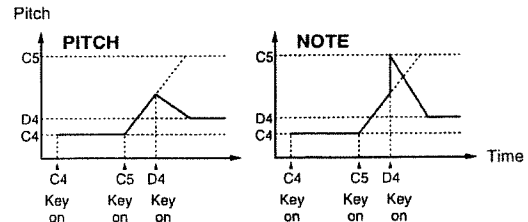

### Portamento Time

This is the setting page for "Adjusting the time over which the pitch will change (Portamento Time)" (p. 78).

### Struct 1&2/3&4 (Structure Type)

Specifies how tones 1 and 2 will be combined (Strc 1&2), and how tones 3 and 4 will be combined (Strc 3&4).

The display will show how the Tones are combined.

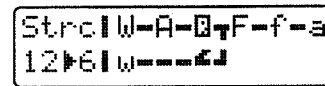

Structure 1&2 Structure Type

The displayed symbols have the following meanings.

|W|: Wave/Pitch 1 (3)

|w|: Wave/Pitch 2 (4)

|F|: Filter 1 (3)

|f|: Filter 2 (4)

|A|: Amplifier 1 (3)

|a|: Amplifier 2 (4)

|B|: Booster

|R|: Ring Modulator

Abbreviations shown for each type have the following meanings.

W/P: Wave/Pitch

FILTER: Filter

AMP: Amplifier

B: Booster

R: Ring Modulator

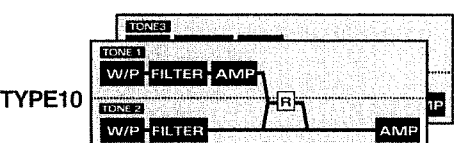
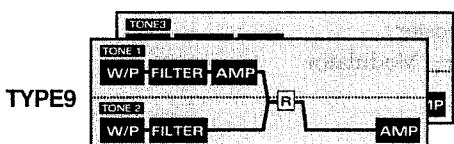
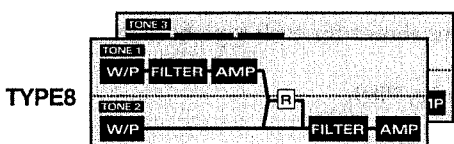
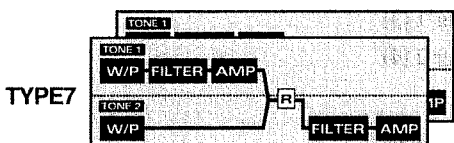
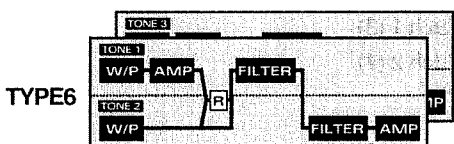
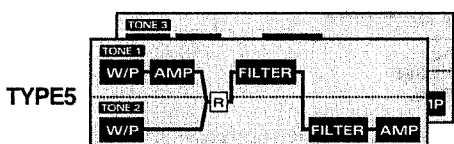
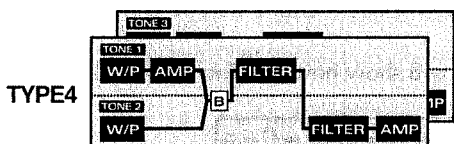
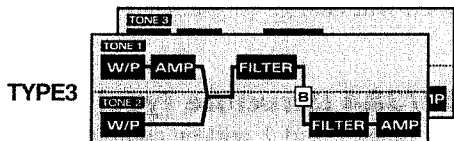
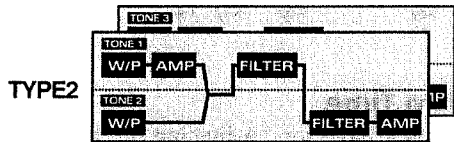
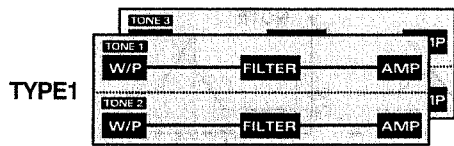

**TYPE 1:** This is the most basic type. Tones 1 and 2 (3 and 4) are independent. Select this when you wish to utilize the waveform of each tone without change, or when you wish to layer tones to create a richer sound.

**TYPE 2:** This type combines the two filters to strengthen their characteristics. The AMP of tone 1 (3) will control the volume balance of the two tones.

**TYPE 3:** This type mixes the sound of tone 1 (3) and tone 2 (4), applies a filter, and then applies a booster to distort the waveform.

**TYPE 4:** This type applies a booster to distort the waveform, and then combines the two filters. The AMP of tone 1 (3) adjusts the depth of the booster.

**TYPE 5:** This type uses a ring modulator to create new overtones, and combines the two filters. The AMP of tone 1 (3) adjusts the depth of ring modulation.

**TYPE 6:** This type uses a ring modulator to create new overtones, and in addition mixes in the sound of tone 2 (4) and stacks the two filters. The AMP of tone 1 (3) adjusts the depth of ring modulation.

**TYPE 7:** This type applies a filter to tone 1 (3) and ring-modulates it with tone 2 (4) to create new overtones.

**TYPE 8:** This type applies a filter to tone 1 (3) and ring-modulates it with tone 2 (4), then mixes it with the sound of tone 2 (4) and filters the result.

**TYPE 9:** This type passes the filtered sound of each tone through a ring modulator to create new overtones.

**TYPE 10:** This type passes the filtered sound of each tone through a ring modulator to create new overtones, and also mixes in the sound of tone 2 (4).

\* With TYPE 2-10 selected, turning off one of the paired tones will cause the other tone to sound as TYPE 1.

### Booster 1&2/3&4 (Booster Gain)

When a Structure Type of "TYPE3" or "TYPE4" is selected, you can adjust the depth of the booster.

This can be set for the pair of tones 1 and 2 (Booster 1&2) and for the pair of tones 3 and 4 (Booster 3&4).

Range: 0, +6, +12, +18

Higher settings will produce greater distortion.

#### Booster

The Booster is a function that increases the input signal in order to distort it.

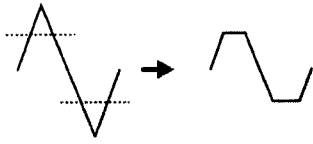

In addition to using this for distortion, you can use the waveform of one of the tones as an LFO to shift the other waveform up and down, producing an effect similar to PWM (Pulse Width Modulation). This is even more effective when used in conjunction with the Wave Gain of the WAVE/FXM parameters.

"Wave Gain" (p. 56)

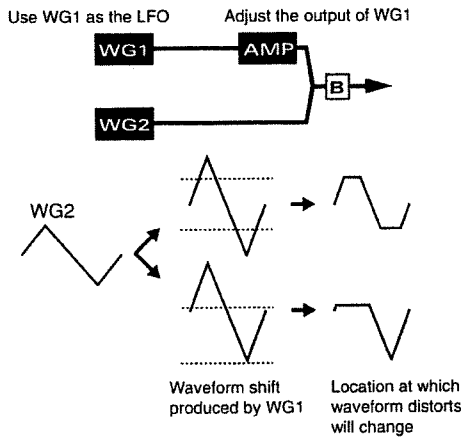

#### Ring Modulator

The ring modulator multiplies the waveforms of two tones to create many new overtones that were not present in either of the original waveforms (inharmonic overtones). This is suitable for creating unpitched metallic sounds such as bells.

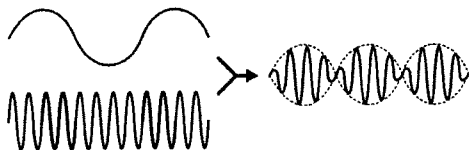

### Stretch Tune (Stretch Tuning Depth)

Select the stretch tuning curve. The selected curve will affect the way that chords will sound.

Range: OFF, 1-3

When this is "OFF," equal temperament will be used. As the value is increased, the pitch difference between the high range and low range will increase.

#### Stretch Tuning

Stretch Tuning is a method of tuning used only on pianos. In general, pianos are tuned so that their high range is sharper and their low range is flatter than the equal tempered pitch. This makes chords sound better.

### V-Priority (Voice Priority)

Specifies how notes will be prioritized when the maximum simultaneous polyphony (64 notes) is exceeded.

Available settings:

**LAST:** The last-played notes will take priority. If more than 64 notes are played, the first-played notes will be turned off successively.

**LOUDEST:** The loudest notes will take priority. If more than 64 notes are played, the notes with the lowest volume will be turned off successively.

5

### Key Range L (Key Range Lower)

Specifies the lowest note that the tone will sound.

If a note below this setting is played, it will not sound.

Range: C-1-UPR

### Key Range U (Key Range Upper)

Specifies the highest note that the tone will sound.

If a note above this setting is played, it will not sound.

Range: LWR-G9

By using Key Range Lower and Key Range Upper, you can cause different tones to sound in different areas of the keyboard.

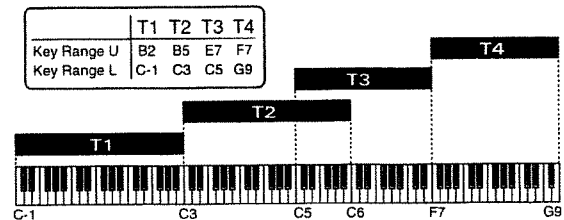

\* It is not possible to set the Lower value above the Upper, or the Upper below the Lower.

### Velo Range (Velocity Range Switch)

Specifies whether or not the Velocity Range settings will be enabled. By using velocity range settings, you can cause different tones to sound in response to notes played at different strengths on the keyboard.

Range: OFF, ON

When this setting is "ON," the Velocity Range settings will be used.

 If you wish to change the loudness of the notes played on the keyboard...

 "Changing the Loudness of Notes Played on the Keyboard (Keyboard Velocity)" (p. 163)

### Velo Range L (Velocity Range Lower)

Specifies the lower velocity limit for which the tone will sound.

The tone will not be sounded by notes played with a velocity lower than this setting.

Range: 1-UPR

5

### Velo Range U (Velocity Range Upper)

Specifies the upper velocity limit for which the tone will sound.

The tone will not be sounded by notes played with a velocity stronger than this setting.

Range: LWR-127

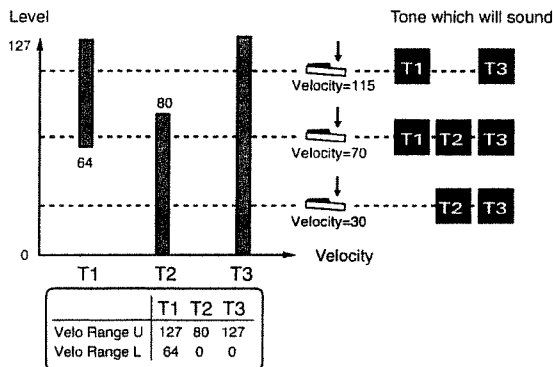

\* It is not possible to set the Lower value above the Upper, or the Upper below the Lower.

### Velo X-Fade (Velocity Crossfade)

Specifies the way in which the volume will change when a keyboard is played with a velocity that falls outside the velocity range setting.

Range: 0-127

Higher settings will cause the volume to decrease more gradually when the velocity falls outside of the velocity range.

By using Velocity Crossfade, you can use playing dynamics on the keyboard to smoothly connect two tones.

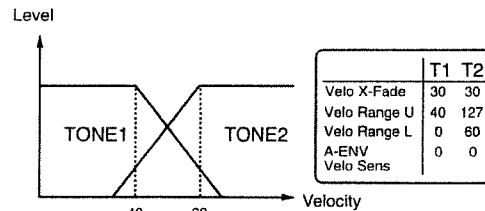

## Saving Patches You've Created (Patch Write)

After you've created a patch you like, do this to save it as a User Patch:

1. Make sure the pattern is stopped.
2. Press [PATCH] to access the Patch Select page.

If you've modified the patch settings, an asterisk "\*" will be displayed at the left of the number, indicating that the selected patch has been modified (edited). Be aware that if you select a different patch without saving the modified patch, your changes will be lost.

3. Hold down [SHIFT] and press [WRITE].

The indicator will blink.

The following display will appear, and the "▶" (cursor) will appear at the left of the group.





If you do not wish to change the number or name, you can omit steps 4-8.

If you decide not to save the patch, press [EXIT].

4. Press [PRESET/USER/CARD] to select the save destination group.

\* It is not possible to select the PRESET group.

\* CARD groups can be selected only if an optional memory card is inserted.

  "Using Memory Cards" (p. 159)

**5. Use [INC] [DEC] or the [VALUE] dial to select the save destination bank and number.**

You can also use the BANK and NUMBER [1]–[8] buttons to select the save destination bank and number.

At this time, you can press [UNDO/REDO] to check the name and sound of the patch that is currently in the save destination number. After you have found a patch that you do not mind overwriting, press [UNDO/REDO] once again to return to the previous display.

**6. Press PAGE [>].**

The cursor will move to the beginning of the second line in the display.

```
PATCH WRT  U:A11
▶Lead TB 1
```

**7. Assign a name to the patch.**

Use [INC] [DEC] or the [VALUE] dial to specify the character.

The following characters can be selected:

Space, A–Z, a–z, 0–9, ! " # \$ % & ' ( ) \* +, - . / : ; < = > ?  
@ [ ¥ ] ^ \_ ` { | }

**8. Repeat steps 6–7 to input the name.**

By pressing PAGE [<] you can move the cursor back toward the left.

\* A name of up to 12 characters can be input.

**9. Press [ENTER].**

The confirmation screen will appear in the display. If you decide to cancel the operation, press [EXIT].

```
PATCH WRT  U:A11
Are You Sure ?
```

**10. Press [ENTER] once again.**

```
Processing...
Keep Power ON !
```

The Patch Write operation will be carried out, then the normal display will reappear. The patch has now been saved.

## Copying and Initializing Settings

### Patch Tone Copy

This operation copies the settings of a tone in a patch to the specified tone of the currently-selected patch.

**1. Select any part 1–7 as the current part.**

**2. Press [PATCH] to access the patch select page.**

**3. Press [UTILITY].**

The indicator will light.

**4. Press PAGE [<] [>] several times to select "COPY," and press [ENTER].**

**5. Select "TONE," and press [ENTER].**

The display will show the copy source patch, the copy source tone and the copy destination tone.

```
PATCH TONE COPY
▶U:A11- T1 → T1
```

Copy source patch	Copy source tone	Copy destination tone
----------------------	---------------------	-----------------------------

**6. Use [INC] [DEC] or the [VALUE] dial to specify the copy source patch, the copy source tone and the copy destination tone.**

You can use PAGE [<] [>] to move the cursor.

You can also use the BANK and NUMBER [1]–[8] buttons to select the copy source patch.

**7. Press [ENTER].**

The confirmation screen will appear in the display.

If you decide to cancel the operation, press [EXIT].

```
PATCH TONE COPY
Are You Sure ?
```

**8. Press [ENTER] once again.**

```
Processing...
Keep Power ON !
```

The Patch Tone Copy operation will be carried out, then the normal display will reappear.

If you wish to save the patch that you copied, use the Patch Write operation.

 **"Saving Patches You've Created (Patch Write)" (p. 82)**

### Patch Initialize

This operation initializes a patch.

**1. Press [PATCH] to access the patch select page.**

**2. Select the patch that you wish to initialize.**

**3. Press [UTILITY].**

The indicator will light.

**4. Press PAGE [<] [>] several times to select "INITIALIZE," and press [ENTER].**

**5. Select "PATCH," and press [ENTER].**

The following display will appear.

```
PATCH INIT U:A11
Are You Sure ?
```

If you decide to cancel the operation, press [EXIT].

**6. Press [ENTER].**

```
Processing...
Keep Power ON !
```

The Patch Initialize operation will be carried out, then the normal display will reappear.



# Chapter 6. Creating an Original Rhythm Set (Rhythm Edit)

## How a Rhythm Tone Is Organized

A rhythm set is a group of many rhythm tones. Each rhythm tone consists of the following elements.

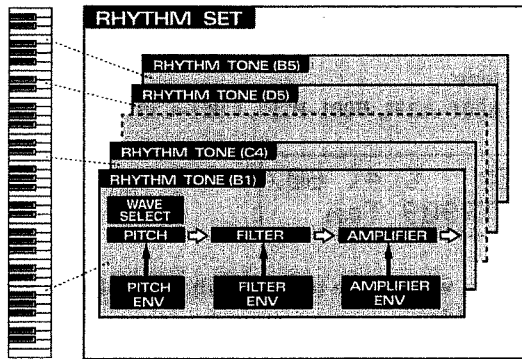

### WAVE

Select the PCM waveform that will be the basis of the sound.

The JX-305 contains 636 types (A001–A254, B001–B251, C001–C131) of waveform. Each of the JX-305's rhythm tones is based on these waveforms, and a rhythm tone is assigned to each key to create a rhythm set.

### PITCH

This specifies how the pitch will change.

### FILTER

This specifies changes in the frequency components of the sound.

### AMPLIFIER

This specifies changes in volume and pan.

## Creating the Sounds

In Rhythm Edit, you can modify the parameters of each rhythm tone independently.

1. Select the rhythm part as the current part.
2. Select the rhythm set that you wish to edit (p. 28).
3. Make sure that the rhythm set select page is displayed.
4. Press [EDIT].

The indicator will light, and the edit page will appear in the display.

```
EDIT:
Select Parameter
```

5. Select the rhythm set parameter that you wish to modify.

There are two ways to select rhythm set parameters.

### Selecting setting pages for editing

In this method, you will use NUMBER [2] (WAVE)–[8] (RHY TONE) to select the various setting pages, use PAGE [<] [>] to switch parameter pages, and edit the desired parameter. This method allows you to edit all parameters, and is suitable when you wish to edit a sound in a logical sequence such as “waveform”→ “pitch”→ “brightness,” etc.

To modify the value, use [INC] [DEC] or the [VALUE] dial.

For how to access the setting pages, refer to “Making More Detailed Settings” in each section.

### Using knobs and buttons to select the page for editing

By operating the knobs or buttons of the front panel, you can directly call up the editing page for that parameter. For example, if you operate [CUTOFF] knob, the display will automatically change to the cutoff frequency setting page, and you can view the settings for each rhythm tone as you modify them.

\* This method cannot be used to edit parameters for which there is no front panel knob or button.

In the rhythm edit page, the display will show the currently selected rhythm set parameters and the note number of the rhythm tone selected for editing.

```
Rhythm set parameter
LEVEL: Tone Level
C#4( 61)▶ 127
Note number
```

### Selecting only the edit page without modifying the value

If you wish to see the current value before you modify it, hold down [SHIFT] while you operate the knob. This will access the editing page without modifying the value.

6. Play the keyboard to select the rhythm tone that you wish to edit, and edit the value.

The last-played rhythm tone will be selected for editing.

**7. To exit from an editing page, press [EDIT] or [EXIT].**

An asterisk "\*" will be displayed at the left of the group of an edited rhythm set. This indicates that the settings of this rhythm set have been modified.

If you select a different rhythm set when the "\*" is displayed, the modified settings will be lost. If you wish to keep the edited rhythm set, you must perform the Rhythm Set Write operation.

"Saving Rhythm Sets You've Created (Rhythm Set Write)" (p. 98)

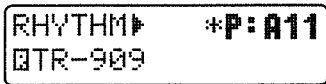

**Specifying the Basic Waveform of the Sound (Wave)**

6

In the WAVE setting pages you can specify the waveform that will be the basis of the sound, and how it will sound.

**1. Press NUMBER [2] (WAVE).**

The display will show the WAVE setting page.

**2. Use PAGE [<] [>] to select parameters and edit them.**

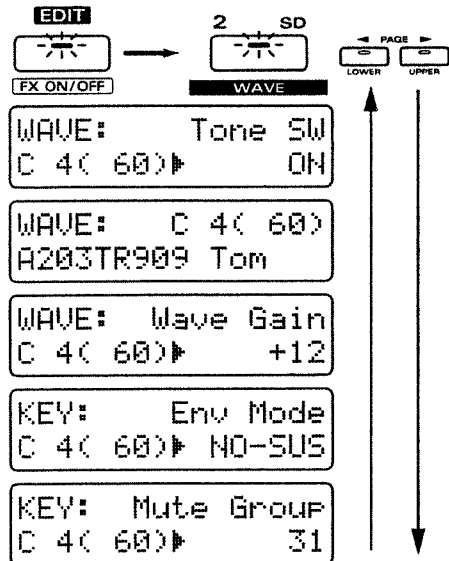

**Tone SW (Rhythm Tone Switch)**

Turn this "ON" if you want the rhythm tone to sound, or "OFF" if you do not want it to sound.

In order to make the best use of the available polyphony, set unused rhythm tones to "OFF."

**Selecting the basic waveform (Wave Select)**

Select the waveform that will be the basis of each rhythm tone.

Range: A001-A254, B001-B251, C001-C131

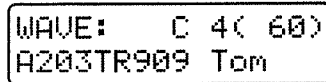

If you would like to know what waveforms are available...

"Waveform List" (p. 187)

**Wave Gain**

This parameter boosts the waveform. Raising the value by 6 dB will double the gain.

Range: -6, 0, +6, +12

**Env Mode (Envelope Mode)**

Specifies how the sound will play when a sustained-type waveform such as a whistle (a looped waveform) is selected.

Available settings:

NO-SUS: The sound will decay naturally even if you continue holding the keyboard.

SUSTAIN: The sound will continue as long as the keyboard is pressed.

\* If a waveform with a long decay (one-shot waveform) is selected, setting this parameter to SUSTAIN will have no effect.

**Mute Group**

The Mute Group function lets you prevent percussion instruments in the same mute group from sounding simultaneously.

Range: OFF, 1-31

If you are not using the mute group function, set this OFF.

For example, on an acoustic drum set, it is physically impossible for the open hi-hat sound to be heard at the same time as the closed hi-hat sound. To simulate this, you can specify the same mute group number for both hi-hat sounds.

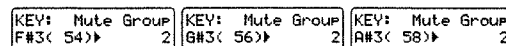

## Pitch-Related Settings

The PITCH parameters contain settings that affect the pitch.

### Changing the Pitch of the Sound (Pitch)

#### Fine pitch adjustments (Fine Tune)

For each rhythm tone, you can make fine adjustments to the pitch in 1-cent steps (1/100th of a semitone).

1. In the **REALTIME MODIFY** section, press **[FILTER/AMP/PITCH]** several times to make the **PITCH** indicator light.
2. Rotate the **[FINE TUNE]** knob to adjust the **Fine Tune** value.

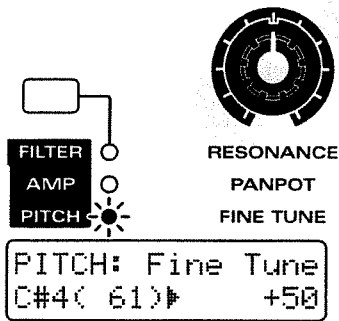

Range: -50→+50

As the knob is rotated further clockwise, the pitch will rise. As it is rotated counterclockwise, the pitch will fall.

#### Approximate pitch adjustments (Coarse Tune)

For each rhythm tone, you can adjust the pitch in semitone steps.

1. In the **REALTIME MODIFY** section, press **[FILTER/AMP/PITCH]** several times to make the **PITCH** indicator light.
2. Hold down **[FILTER/AMP/PITCH]** and use **[INC]** **[DEC]** or the **[VALUE]** dial to set the **Coarse Tune** value.

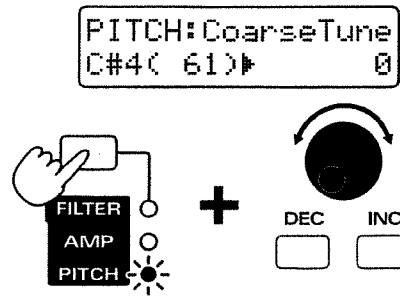

Range: -60→+60

The pitch will rise as the value is increased. The pitch will fall as the value is decreased.

If you hold down **[SHIFT]** as you make the setting, the pitch will change in one-octave steps (12 semitones).

\* With certain waveforms assigned to rhythm tones, when the coarse tune value is increased, the sound may change to a reversed sound at some point during the value increase.

### Making the Pitch Change Over Time (Pitch Envelope)

In the P-ENV (Pitch Envelope) parameters you can make settings to specify how the pitch of the percussion instrument will change over time.

#### Pitch envelope settings

1. In the **REALTIME MODIFY** section, press **[FILTER/AMP/PITCH]** several times to make the **PITCH** indicator light.
2. Press **[ENVELOPE/LFO1/EFFECTS]** several times to make the **ENVELOPE** indicator light.
3. Use the **[ATTACK]** / **[DECAY]** / **[SUSTAIN]** / **[RELEASE]** knobs to adjust the pitch envelope values.

Available settings:

**[ATTACK]/[DECAY]/[RELEASE]:** 0-127

**[S]:** -63→+63

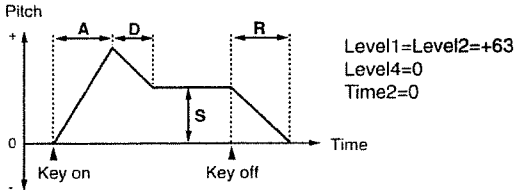
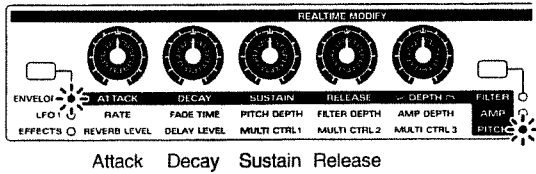

```

F-ENU: [A]Time1
C#4( 61)▶ 0

F-ENU: [D]Time3
C#4( 61)▶ 0

F-ENU: [S]Level3
C#4( 61)▶ +63

F-ENU: [R]Time4
C#4( 61)▶ 0
    
```

6

**[ATTACK] (Attack Time)**

The time from when the keyboard is played until the maximum pitch change is reached. Higher settings will cause the pitch to change over a longer time.

**[DECAY] (Decay Time)**

The time from when the maximum pitch change is reached until the Sustain Level is reached. Higher settings will cause the pitch to change over a longer time.

**[SUSTAIN] (Sustain Level)**

The pitch that will be held. Positive (+) settings will make the pitch higher than the normal pitch. Negative (-) settings will make the pitch lower than the normal pitch.

**[RELEASE] (Release Time)**

The time from when the keyboard is released until the pitch returns to the normal pitch. Higher settings will cause the pitch to change over a longer time.

**Specifying the envelope depth (Pitch Envelope Depth)**

Here's how you can adjust the depth of the Pitch Envelope.

1. In the **REALTIME MODIFY** section, press **[FILTER/AMP/PITCH]** several times to make the **PITCH** indicator light.
2. Press **[ENVELOPE/LFO1/EFFECTS]** several times to make the **ENVELOPE** indicator light.
3. Use the **[DEPTH]** knob to adjust the Pitch Envelope Depth.

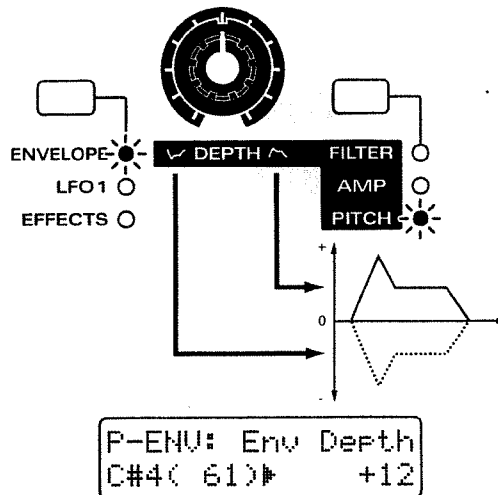

Range: -12--+12

The pitch change will increase as the knob is rotated further toward the right of center. Rotating the knob toward the left of center will invert the shape of the envelope, and the pitch change will increase as the knob is rotated further left.

With both the PITCH and ENVELOPE indicators lit, hold down [ENVELOPE/LFO1/EFFECTS], and use [INC] [DEC] or the [VALUE] dial to set the Pitch Envelope Depth.

## Making More Detailed Settings

### 1. Press NUMBER [3] (PITCH).

The display will show the PITCH setting page.

### 2. Use PAGE [<] [>] to select parameters and edit them.

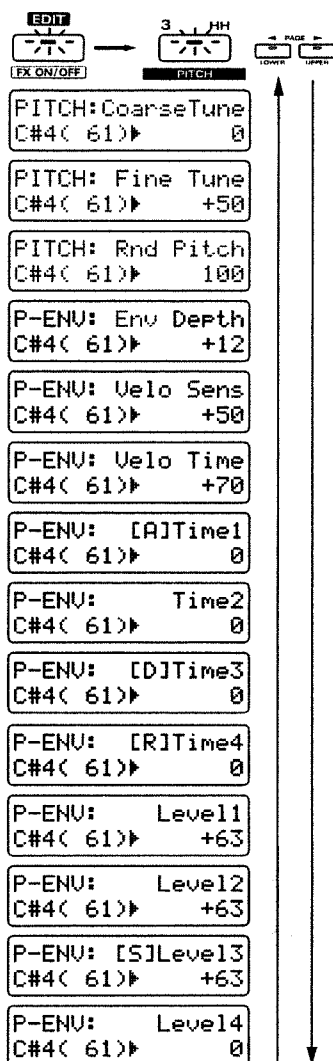

### Coarse Tune

This is the setting page for “Approximate pitch adjustments (Coarse Tune)” (p. 87).

### Fine Tune

This is the setting page for “Fine pitch adjustments (Fine Tune)” (p. 87).

### Rnd Pitch (Random Pitch Depth)

This applies a degree of randomness to the pitch of each note.

Range: 0–1200

As this value is increased, a greater degree of randomness will be applied. As this value is decreased, there will be less randomness. With a value of “0” there will be no effect.

### Env Depth (Pitch Envelope Depth)

This is the setting page for “Specifying the envelope depth (Pitch Envelope Depth)” (p. 88).

### Velo Sens (Pitch Envelope Velocity Sensitivity)

This setting lets you control the Pitch Envelope depth by the force with which you play the keyboard.

Range: -100→+150

With positive (+) settings, the pitch will change more greatly as you play the keyboard more strongly. With negative (-) settings, the pitch will change less as you play the keyboard more strongly.

If you wish to change the loudness of the notes played on the keyboard...

☞ “Changing the Loudness of Notes Played on the Keyboard (Keyboard Velocity)” (p. 163)

### Velo Time (Pitch Envelope Velocity Time Sensitivity)

This parameter lets your playing dynamics on the keyboard control the overall time of the entire Pitch Envelope.

Range: -100→+100

With positive (+) settings, the Pitch Envelope times will become faster as you play the keyboard more strongly. With negative (-) settings, the Pitch Envelope times will become slower as you play the keyboard more strongly.

The four front panel knobs [ATTACK] / [DECAY] / [SUSTAIN] / [RELEASE] can be used to set the most commonly-used parameters of the pitch envelope, but the JX-305 also allows you to make more detailed pitch envelope settings.

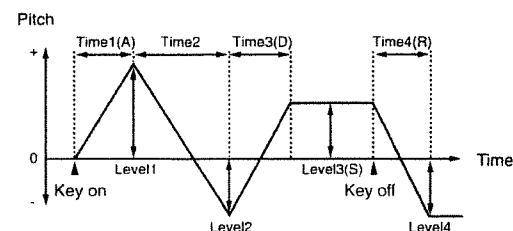

### Time1-4 (Pitch Envelope Time 1-4)

Specifies the time until the next pitch level is reached. You can set the four parameters Time1-4.

Range: 0-127

Higher settings will result in a longer time until the next pitch level is reached.

\* The front panel parameter [ATTACK] (Attack Time) corresponds to Time1, [DECAY] (Decay Time) to Time3, and [RELEASE] (Release Time) to Time4.

### Level1-4 (Pitch Envelope Level 1-4)

Specifies the pitch difference relative to the normal pitch (as specified by Coarse Tune and Fine Tune). You can set the four parameters Level1-4.

Range: -63+63

Positive (+) settings will raise the pitch above the normal pitch. Negative (-) settings will lower the pitch below the normal pitch.

\* The front panel parameter [SUSTAIN] (Sustain Level) corresponds to Level3.

## 6

## Brightness-Related Settings (Filter)

The FILTER parameters let you make settings that affect the brightness of the percussion instrument sounds.

### Modifying the Brightness of the Sound (Filter)

#### Selecting the type of filter (Filter Type)

Select the type of filter.

1. In the REALTIME MODIFY section, press [FILTER/AMP/PITCH] several times to make the FILTER indicator light.
2. Hold down [FILTER/AMP/PITCH] and use [INC] [DEC] or the [VALUE] dial to select the Filter Type.

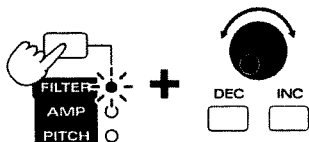

```
FILTER:      Type
C#4( 61)▶  LPF
```

Available settings:

**OFF:**

The filter will not be used.

**LPF (Low Pass Filter):**

This is the most common type of filter, and allows frequencies below the cutoff frequency to pass. It is used to make the sound more mellow.

**BPF (Band Pass Filter):**

This filter allows frequencies in the region of the cutoff frequency to pass, and cuts the rest. It is useful for creating sounds with a distinctive tone.

**HPF (High Pass Filter):**

This filter allows frequencies above the cutoff frequency to pass. It is appropriate for creating percussion instrument sounds with a distinctive high frequency range.

**PKG (Peaking Filter):**

This filter boosts the overtones in the region of the cutoff frequency. It allows you to simulate the resonance of a drum.

### Brightening the sound (Cutoff Frequency)

Specifies the frequency at which the filter will begin to affect the frequency components of the waveform (the Cutoff Frequency). By changing the cutoff frequency, you can control the brightness of the sound.

1. In the REALTIME MODIFY section, press [FILTER/AMP/PITCH] several times to make the FILTER indicator light.
2. Rotate the [CUTOFF] knob to adjust the cutoff frequency value.

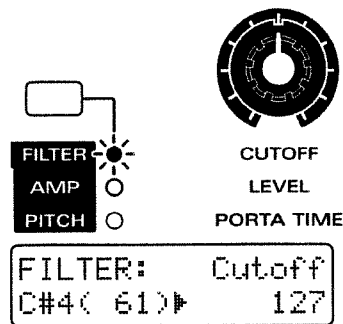

Range: 0-127

The effect will depend on the Filter Type.

**LPF (Low Pass Filter)**

Rotating the knob clockwise will cause the sound to become brighter, approaching the original waveform. Rotating it counterclockwise will cut more of the high frequency overtones, making the sound darker.

\* For some waveforms, you may not be able to hear any sound if you lower the value too far.

**BPF (Band Pass Filter)**

Rotating the knob clockwise will raise the frequency area that is heard. Rotating the knob counterclockwise will cause only a progressively lower frequency area to be heard.

**HPF (High Pass Filter)**

When the knob is turned clockwise, the low frequency range will be cut more greatly, making the sound sharper. As the knob is rotated counterclockwise, the original sound of the waveform will be heard.

\* For some waveforms, you may hear no sound if this value is raised excessively.

**PKG (Peaking Filter)**

When the knob is turned clockwise, the frequency area that is emphasized will rise. Rotating the knob counterclockwise will lower the frequency area that is emphasized.

**Adding a distinctive character to the sound (Resonance)**

This setting emphasizes the overtones in the region of the cutoff frequency, adding character to the sound.

1. In the **REALTIME MODIFY** section, press **[FILTER/AMP/PITCH]** several times to make the **FILTER** indicator light.
2. Rotate the **[RESONANCE]** knob to adjust the resonance setting.

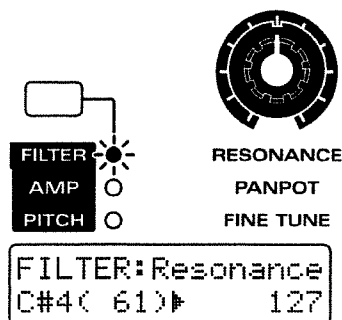

Range: 0–127

As the knob is rotated further clockwise, the sound will have more character. Rotating it counterclockwise will make the sound more natural.

Depending on the cutoff frequency setting, raising the resonance excessively may cause the sound to distort suddenly. In order to prevent the resonance from being increased excessively, factory settings have been made so that the value will not rise beyond “110” even if the **[RESONANCE]** knob is rotated all the way to the right. This is called the Resonance Limiter. You are free to adjust this upper limit.

**“Specifying the Variable Range of Resonance (Resonance Limiter)” (p. 169)**

If you have increased the Resonance Limiter setting, be careful not to raise the resonance excessively.

**Making the Brightness Change Over Time (Filter Envelope)**

On acoustic instruments, the tone quality (brightness) often changes over the duration of a note. For example, on a piano, the sound at the beginning of each note contains many overtones (i.e., has a bright tone), and as the note decays to silence, the overtones diminish, making the sound more mellow. The **F-ENV** (Filter Envelope) parameters let you create this type of tonal change over time.

**Filter envelope settings**

1. In the **REALTIME MODIFY** section, press **[FILTER/AMP/PITCH]** several times to make the **FILTER** indicator light.
2. Press **[ENVELOPE/LFO1/EFFECTS]** several times to make the **ENVELOPE** indicator light.
3. Use the **[ATTACK]** / **[DECAY]** / **[SUSTAIN]** / **[RELEASE]** knobs to adjust the filter envelope values.

Range: 0–127

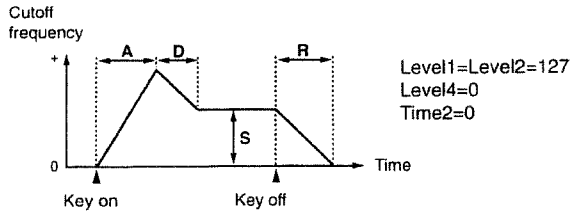
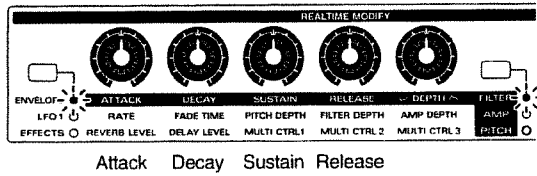

```

F-ENV: [A]Time1
C#4( 61)▶ 10

F-ENV: [D]Time3
C#4( 61)▶ 30

F-ENV: [S]Level3
C#4( 61)▶ 80

F-ENV: [R]Time4
C#4( 61)▶ 30
    
```

**[ATTACK] (Attack Time)**

The time from when the keyboard is pressed until the maximum tonal change is reached. Higher settings will cause the tonal change to occur over a longer time.

**[DECAY] (Decay Time)**

The time from when the maximum tonal change is reached until the Sustain Level is reached. Higher settings will cause the tonal change to occur over a longer time.

**[SUSTAIN] (Sustain Level)**

The cutoff frequency level at which the tonal change will stabilize. Raising this setting will also raise the cutoff frequency.

**[RELEASE] (Release Time)**

The time from when the keyboard is released until the sound disappears. Higher settings will cause the tonal change to occur over a longer time.

**Specifying the depth of the envelope (Filter Envelope Depth)**

This setting adjusts the depth of the filter envelope.

1. In the **REALTIME MODIFY** section, press **[FILTER/AMP/PITCH]** several times to make the **FILTER** indicator light.
2. Press **[ENVELOPE/LFO1/EFFECTS]** several times to make the **ENVELOPE** indicator light.
3. Use the **[DEPTH]** knob to adjust the Filter Envelope Depth setting.

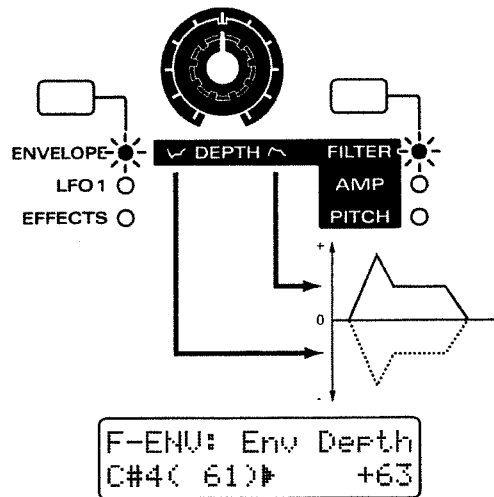

Range: -63+63

Rotating the knob toward the right of center will increase the change in brightness. If the knob is rotated toward the left of center, the shape of the envelope will be inverted, and the change in brightness will become greater as the knob is rotated toward the left.

With both the **FILTER** and **ENVELOPE** indicators lit, hold down **[ENVELOPE/LFO1/EFFECTS]**, and use **[INC]** **[DEC]** or the **[VALUE]** dial to set the Filter Envelope Depth.

**Making More Detailed Settings**

1. Press **NUMBER [4] (FILTER)**.

The display will show the **FILTER** setting page.

2. Use **PAGE [<] [>]** to select parameters and edit them.



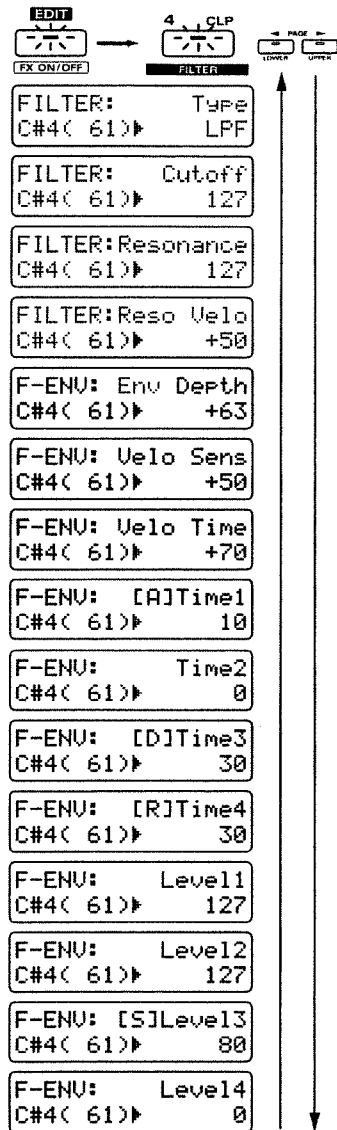

### Type (Filter Type)

This is the setting page for “Selecting the type of filter (Filter Type)” (p. 90).

### Cutoff (Cutoff Frequency)

This is the setting page for “Brightening the sound (Cutoff Frequency)” (p. 90).

### Resonance

This is the setting page for “Adding a distinctive character to the sound (Resonance)” (p. 91).

### Reso Velo (Resonance Velocity Sensitivity)

Specifies how resonance depth will be affected by your playing dynamics on the keyboard.

Range: -100+150

With positive (+) settings, playing the keyboard more strongly will cause the change to be greater. With negative (-) settings, playing the keyboard more strongly will cause the change to be less.

### Env Depth (Filter Envelope Depth)

This is the setting page for “Specifying the depth of the envelope (Filter Envelope Depth)” (p. 92).

### Velo Sens (Filter Envelope Velocity Sensitivity)

Specifies how the force of your playing on the keyboard will affect the filter envelope.

Range: -100+150

With positive (+) settings, the tone will change more as you play more strongly on the keyboard. With negative (-) settings, the tone will change less as you play more strongly on the keyboard.

If you wish to change the loudness of the notes played on the keyboard...

☛ “Changing the Loudness of Notes Played on the Keyboard (Keyboard Velocity)” (p. 163)

### Velo Time (Filter Envelope Velocity Time Sensitivity)

Specifies how the dynamics of your playing on the keyboard will affect the overall time of the entire filter envelope.

Range: -100+100

With positive (+) settings, the filter envelope times will become faster as you play the keyboard more strongly. With negative (-) settings, the filter envelope times will become slower as you play the keyboard more strongly.

The four front panel knobs [ATTACK] / [DECAY] / [SUSTAIN] / [RELEASE] can be used to set the most commonly-used parameters of the filter envelope, but the JX-305 also allows you to make more detailed filter envelope settings.

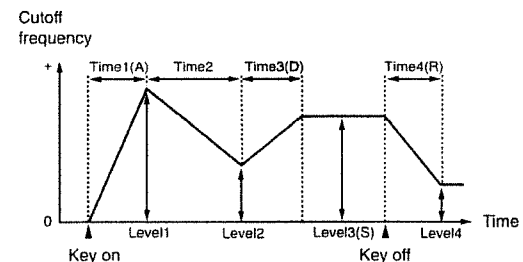

### Time 1–4 (Filter Envelope Time 1–4)

Specifies the time until the next cutoff frequency is reached. You can set the four values Time1–4.

Range: 0–127

Higher settings will lengthen the time until the next cutoff frequency is reached.

\* The front panel [ATTACK] (Attack Time) corresponds to Time 1, [DECAY] (Decay Time) to Time3, and [RELEASE] (Release Time) to Time4.

### Level 1–4 (Filter Envelope Level 1–4)

Specifies the cutoff frequency at each level. You can set the four values Level 1–4.

Range: 0–127

Higher settings will also raise the cutoff frequency.

\* The front panel [SUSTAIN] (Sustain Level) corresponds to Level3.

## Settings Related to Volume and Pan (Amplifier)

6

The AMP (amplifier) parameters contain settings related to the volume and stereo location of the sound.

### Adjusting the Volume and Pan (Amplifier)

#### Adjusting the volume of each rhythm tone (Rhythm Tone Level)

This setting adjusts the volume of each rhythm tone. This is used mainly to adjust the volume balance between rhythm tones.

1. In the REALTIME MODIFY section, press [FILTER/AMP/PITCH] several times to make the AMP indicator light.
2. Rotate the [LEVEL] knob to adjust the Rhythm Tone Level setting.

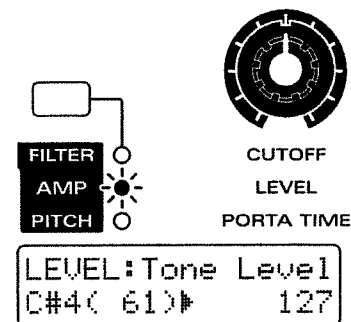

Range: 0–127

As the knob is rotated further clockwise, the volume will increase. As it is rotated counterclockwise, the volume will decrease.

\* The overall volume of the entire rhythm set can be modified, and memorized for each pattern as the Setup parameter Part Level. The Rhythm Tone Level setting will be multiplied by this value.

<sup>E8</sup> "Adjusting the volume of each part (Part Level)" (p. 33)

#### Adjusting the pan for each rhythm tone (Rhythm Tone Pan)

This parameter sets the stereo location for each rhythm tone.

1. In the REALTIME MODIFY section, press [FILTER/AMP/PITCH] several times to make the AMP indicator light.
2. Rotate the [PANPOT] knob to set the Rhythm Tone Pan value.

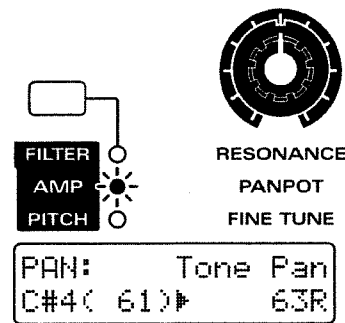

Range: L64–63R

As the knob is rotated further clockwise, the stereo location will shift toward the right. As it is rotated counterclockwise, the location will shift toward the left.

\* The pan of the overall rhythm set can be modified and set for each pattern by the Setup parameter Part Pan. The Rhythm Tone Pan value will be added to this setting.

<sup>E8</sup> "Adjusting the pan of each part (Part Pan)" (p. 33)

### Causing pan to change randomly (Random Pan Switch)

This setting causes the stereo location to change randomly each time a note is played.

1. In the **REALTIME MODIFY** section, press **[FILTER/AMP/PITCH]** several times to make the **AMP** indicator light.
2. Hold down **[FILTER/AMP/PITCH]** and use **[INC]** **[DEC]** or the **[VALUE]** dial to turn the **Random Pan Switch** on/off.

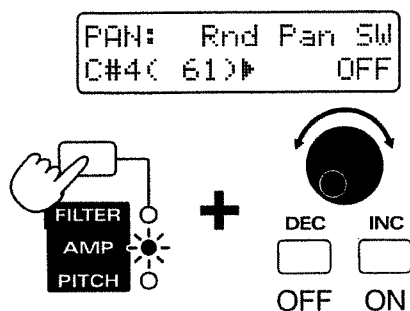

\* The Rhythm Tone Pan setting will be ignored by rhythm tones for which the Random Pan Switch is turned on.

### Creating Time-Varying Change in Volume (Amplifier Envelope)

On acoustic instruments, change in volume occurs over the duration of each note. For example, on a piano, the volume reaches the maximum level immediately, and then gradually decays to silence (decay-type instruments). On instruments such as an organ, the volume remains constant as long as the note is held (sustain-type instruments). The A-ENV (amplifier envelope) parameters let you specify this type of time-varying change in volume (the Amplifier Envelope).

#### Amplifier envelope settings

1. In the **REALTIME MODIFY** section, press **[FILTER/AMP/PITCH]** several times to make the **AMP** indicator light.
2. Press **[ENVELOPE/LFO1/EFFECTS]** several times to make the **ENVELOPE** indicator light.
3. Use the **[ATTACK]** / **[DECAY]** / **[SUSTAIN]** / **[RELEASE]** knobs to adjust the amplifier envelope values.

Range: 0–127

With both the **AMP** and **ENVELOPE** indicators lit, hold down **[ENVELOPE/LFO1/EFFECTS]**, and use **[INC]** **[DEC]** or the **[VALUE]** dial to set the Amplifier Envelope Attack Depth.

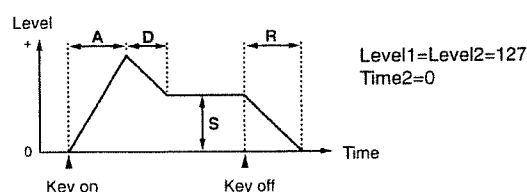
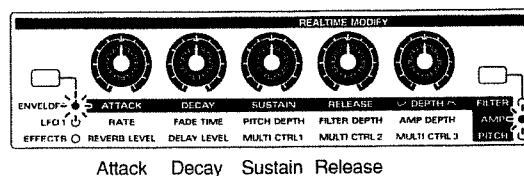

```

A-ENV: [A]Time1
C#4( 61) 127

A-ENV: [D]Time3
C#4( 61) 127

A-ENV: [S]Level3
C#4( 61) 127

A-ENV: [R]Time4
C#4( 61) 127
    
```

#### [ATTACK] (Attack Time)

The time from when the keyboard is played until the maximum volume is reached. Higher settings will cause the volume to change over a longer time.

#### [DECAY] (Decay Time)

The time from when the maximum volume is reached until the Sustain Level is reached. Higher settings will cause the volume to change over a longer time.

#### [SUSTAIN] (Sustain Level)

The level at which the volume reaches a steady state. Higher settings will also raise the volume.

#### [RELEASE] (Release Time)

The time from when the keyboard is released until the volume decays to silence. Higher settings will cause the volume to change over a longer time.

## Making More Detailed Settings

### 1. Press NUMBER [5] (AMPLIFIER).

The display will show the AMPLIFIER setting page.

### 2. Use PAGE [<] [>] to select parameters and edit them.

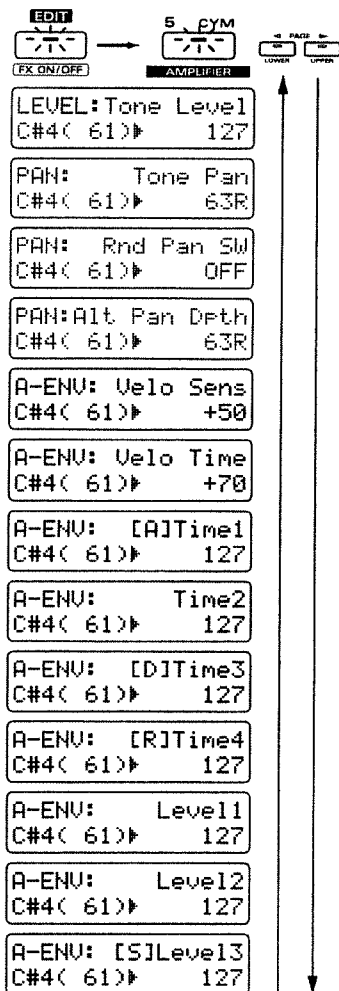

### Alt Pan Dpth (Alternate Pan Depth)

This parameter causes the stereo location of the sound to alternate between left and right each time a note is played.

Range: L63–63R

Higher settings will cause greater change.

When this parameter is set in the L direction, the sound will alternate in the order of left → right → left → right. When set in the R direction, the sound will alternate in the order of right → left → right → left.

### Velo Sens (Amplifier Envelope Velocity Sensitivity)

Specifies how the depth of the amplifier envelope will be affected by the strength of your playing on the keyboard.

Range: -100–+150

With positive (+) settings, the volume will increase as you play more strongly on the keyboard. With negative (-) settings, the volume will decrease as you play more strongly on the keyboard.

If this is set to “0,” the volume will not be affected by the strength of your playing on the keyboard.

If you wish to change the loudness of the notes played on the keyboard...

“Changing the Loudness of Notes Played on the Keyboard (Keyboard Velocity)” (p. 163)

### Velo Time (Amplifier Envelope Velocity Time Sensitivity)

Specifies how the overall times of the entire amplifier envelope will be affected by the strength of your playing on the keyboard.

Range: -100–+100

With positive (+) settings, amplifier envelope times will become faster as you play the keyboard more strongly. With negative (-) settings, amplifier envelope times will become slower as you play the keyboard more strongly.

### Tone Level (Rhythm Tone Level)

This is the setting page for “Adjusting the volume of each rhythm tone (Rhythm Tone Level)” (p. 94).

### Tone Pan (Rhythm Tone Pan)

This is the setting page for “Adjusting the pan for each rhythm tone (Rhythm Tone Pan)” (p. 94).

### Rnd Pan SW (Random Pan Switch)

This is the setting page for “Causing pan to change randomly (Random Pan Switch)” (p. 95).

The four front panel knobs [ATTACK] / [DECAY] / [SUSTAIN] / [RELEASE] can be used to set the most commonly used parameters of the amplifier envelope, but the JX-305 also allows you to make more detailed amplifier envelope settings.

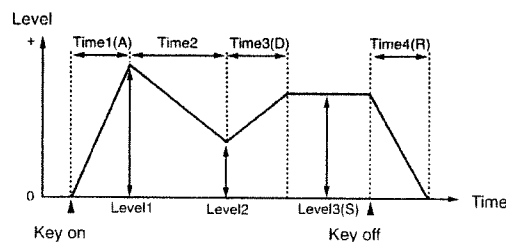

### Time 1–4 (Amplifier Envelope Time 1–4)

Specifies the time until the next level point is reached. This can be set for each of the four parameters Time 1–4.

**Range:** 0–127

Higher settings will lengthen the time until the next level point is reached.

\* The front panel parameter [ATTACK] (Attack Time) corresponds to Time1, [DECAY] (Decay Time) to Time3, and [RELEASE] (Release Time) to Time4.

### Level 1–3 (Amplifier Envelope Level 1–3)

These parameters specify the volume at each point. You can set the three points Level 1–3.

**Range:** 0–127

Higher settings will also raise the volume.

\* The front panel [SUSTAIN] (Sustain Level) corresponds to Level 3.

## Adjusting the Range of Pitch Bend (Bend Range)

Specifies the amount of pitch change (in semitone units) that will occur when the pitch bend lever is operated.

#### 1. Press NUMBER [7] (CONTROL).

The display will show the Bend Range setting page.

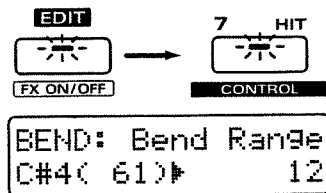

**Range:** 0–12 semitones

Higher settings will result in a greater pitch change when the pitch bend lever is moved to the left or right. For example, if this parameter is set to “12,” the pitch will rise one octave when the pitch bend lever is moved to the right-most position. The pitch will lower one octave when it is moved to the left-most position.

## Adjusting the Effects for Each Rhythm Tone (Rhythm Tone)

In the RHY TONE parameters you can adjust the amount of effects that will be applied to each rhythm tone.

#### 1. Press NUMBER [8] (RHY TONE).

The display will show the RHY TONE setting page.

#### 2. Use PAGE [<] [>] to select parameters and edit them.

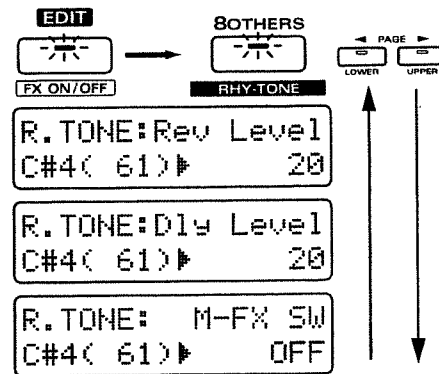

### R.TONE Rev Level (Rhythm Tone Reverb Level)

Specifies the reverb volume for each rhythm tone.

**Range:** 0–127

Higher settings will increase the reverb volume.

\* The Rhythm Tone Reverb Level setting is valid only if the Part Multi-Effects Switch setting of the rhythm part is set to “RHY.” Also in this case, if the Reverb Level and the Part Reverb Level setting of the rhythm part are low, there will be no reverb even if the Rhythm Tone Reverb Level is raised.

- ☞ “Specifying the Part(s) to Which Multi-Effects Will Be Applied (Part Multi-Effects Switch)” (p. 124)
- ☞ “Adjusting the Overall Reverb Volume (Reverb Level)” (p. 102)
- ☞ “Adjusting the Reverb Volume for Each Part (Part Reverb Level)” (p. 102)
- If you would like to know more about reverb settings...
- ☞ “Adding Reverberation to the Sound (Reverb)” (p. 102)

### R.TONE Dly Level (Rhythm Tone Delay Level)

Specifies the amount of delay for each rhythm tone.

Range: 0–127

Higher settings will increase the delay volume.

\* The Rhythm Tone Delay Level setting is valid only when the Part Multi-Effects Switch setting of the rhythm part is set to "RHY." Also in this case, if the Delay Level and the Part Delay Level setting of the rhythm part are low, there will be no delay even if the Rhythm Tone Delay Level is raised.

☞ "Specifying the Part(s) to Which Multi-Effects Will Be Applied (Part Multi-Effects Switch)" (p. 124)

☞ "Adjusting the Overall Delay Volume (Delay Level)" (p. 104)

☞ "Adjusting the Delay Volume for Each Part (Part Delay Level)" (p. 104)

● If you would like to know more about delay settings...

☞ "Adding an Echo to the Sound (Delay)" (p. 103)

## 6

### R.TONE M-FX SW (Rhythm Tone Multi-Effects Switch)

This switches multi-effects on/off for each rhythm tone. Make this setting when you wish to apply multi-effects only to a specific rhythm tone.

Range:

OFF: Multi-effects will not be applied.

ON: Multi-effects will be applied.

\* The setting of the Rhythm Tone Multi Effect Switch is valid only when the Part Multi Effect Switch of the rhythm part is set to "RHY."

☞ "Specifying the Part(s) to Which Multi-Effects Will Be Applied (Part Multi-Effects Switch)" (p. 124)

\* If the Multi-Effects Output Level is set to a low value, the rhythm tone to which multi-effects is applied will not be heard.

☞ If you would like to learn more about multi-effects settings...

☞ "Applying Various Effects to the Sound (Multi-Effects)" (p. 106)

## Saving Rhythm Sets You've Created (Rhythm Set Write)

When you have created a rhythm set that you like, you can save it as a User Rhythm Set.

**1. Make sure that the pattern is stopped.**

**2. Press [PATCH] to access the rhythm set select page.**

When you modify the settings of a rhythm set, an asterisk "\*" will appear at the left of the number, indicating that the selected rhythm set has been modified (edited).

Be aware that if you select a different rhythm set without saving the modified rhythm set, your changes will be lost.

**3. Hold down [SHIFT] and press [WRITE].**

The indicator will blink.

The following display will appear, and the cursor "▶" will appear at the left of the number.



If you do not wish to change the number or name, you can omit steps 4–8.

If you decide not to save the rhythm set, press [EXIT].

**4. Press [PRESET/USER/CARD] to select the save destination group.**

\* It is not possible to select the PRESET group.

\* CARD groups can be selected only if an optional memory card is inserted.

☞ "Using Memory Cards" (p. 159)

**5. Use [INC] [DEC] or the [VALUE] dial to select the save destination bank and number.**

You can also use the BANK and NUMBER [1]–[8] buttons to select the save destination bank and number.

At this time, you can press [UNDO/REDO] to check the name and sound of the rhythm set that is currently in the save destination number. After you have found a rhythm set that you do not mind overwriting, press [UNDO/REDO] once again to return to the previous display.

#### 6. Press PAGE [➤].

The cursor will move to the beginning of the second line in the display.

```
RHY WRITE  U:A11
└┬┘TR-909
```

#### 7. Assign a name to the rhythm set.

Use [INC] [DEC] or the [VALUE] dial to specify the character.

The following characters can be selected.

Space, A-Z, a-z, 0-9, ! " # \$ % & ' ( ) \* +, - . / : ; < = > ?  
@[¥]^\_`{|}

#### 8. Repeat steps 6–7 to input the name.

By pressing PAGE [◀] you can move the cursor back toward the left.

\* A name of up to 12 characters can be input.

#### 9. Press [ENTER].

The confirmation screen will appear in the display. If you decide to cancel the operation, press [EXIT].

```
RHY WRITE  U:A11
Are You Sure ?
```

#### 10. Press [ENTER] once again.

```
Processing...
Keep Power ON !
```

The Rhythm Set Write operation will be carried out, then the normal display will reappear. The rhythm set has now been saved.

## Copying and Initializing Settings

### Rhythm Key Copy

You can copy rhythm tone settings from another rhythm set to the specified rhythm tone of the currently-selected rhythm set.

1. Select the rhythm part as the current part.
2. Press [PATCH] to access the rhythm set select page.
3. Press [UTILITY].  
The indicator will light.
4. Press PAGE [◀] [➤] several times to select "COPY," and press [ENTER].
5. Select "RHYTHM," and press [ENTER].

The display will show the copy source rhythm set number, the note (key) of the copy source rhythm tone, and the note (key) of the copy destination rhythm tone.

```
RHYTHM KEY COPY
└┬┘U:A11- C 4➔ C 4
```

Copy source rhythm set number	Copy source rhythm tone key	Copy destination rhythm tone key
-------------------------------------	-----------------------------------	--

6. Use [INC] [DEC] or the [VALUE] dial to specify the copy source rhythm set number, the copy source rhythm tone key, and the copy destination rhythm tone key.

You can use PAGE [◀] [➤] to move the cursor.

#### 7. Press [ENTER].

The confirmation screen will appear in the display. If you decide to cancel the operation, press [EXIT].

```
RHYTHM KEY COPY
Are You Sure ?
```

#### 8. Press [ENTER] once again.

```
Processing...
Keep Power ON !
```

The Rhythm Key Copy operation will be carried out, then the normal display will reappear. If you wish to save the copied rhythm set, perform the Rhythm Set Write operation.

 "Saving Rhythm Sets You've Created (Rhythm Set Write)" (p. 98)

## Rhythm Tone Initialize

This operation initializes a specific rhythm tone.

**1. Press [PATCH] to access the rhythm set select page.**

**2. Select the rhythm set.**

**3. Press [UTILITY].**

The indicator will light.

**4. Press PAGE [<] [>] several times to select "INITIALIZE," and press [ENTER].**

**5. Select "RHYTHM," and press [ENTER].**

The following display will appear.

```
RHYTHM TONE INIT
▶          C 4( 60)
```

**6. Play the keyboard to select the rhythm tone that you wish to initialize.**

**7. Press [ENTER].**

The confirmation screen will appear in the display.

If you decide to cancel the operation, press [EXIT].

6

```
RHYTHM TONE INIT
Are You Sure ?
```

**8. Press [ENTER].**

```
Processing...
Keep Power ON !
```

The Rhythm Tone Initialize operation will be carried out, then the normal display will reappear.



# Chapter 7. Applying Effects to the Sound (Effects)

The JX-305 comes with three effects units: reverb, delay and multi-effects. Each of them can be set independently. The following diagram shows the signal flow for these effects.

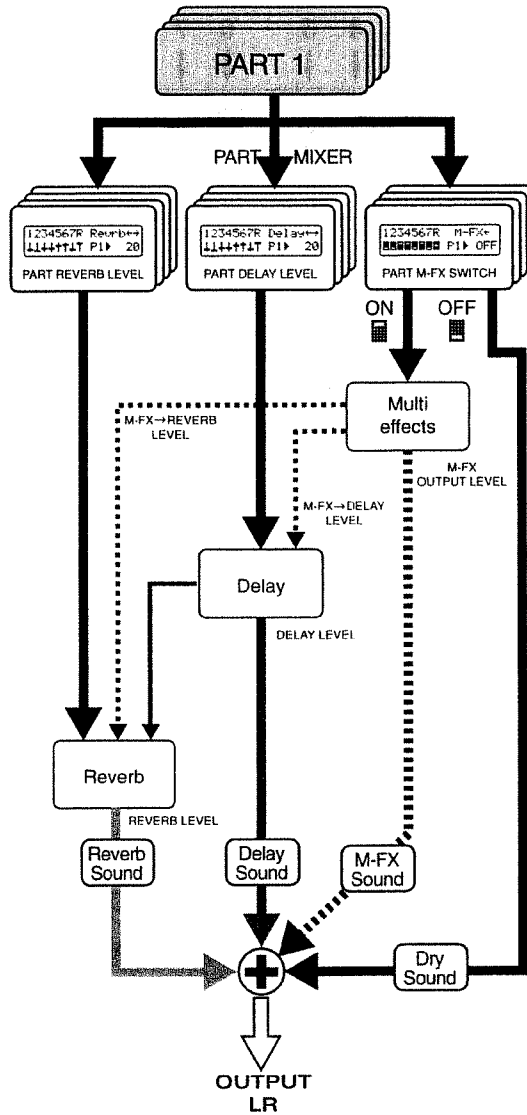

Since the effect settings you modify can be saved for each pattern, effect settings can be switched simply by selecting a pattern.

To save modified effects settings in a pattern...  
 ⓘ "Saving Patterns You've Modified (Pattern Write) (p. 36)

\* If you switch patterns while playback is stopped, all effect settings will be updated. However, if you switch patterns during playback, reverb and delay parameters other than Part Reverb Level and Part Delay Level will maintain the values of the previous pattern.

ⓘ "Adjusting the Reverb Volume for Each Part (Part Reverb Level)" (p. 102)  
 ⓘ "Adjusting the Delay Volume for Each Part (Part Delay Level)" (p. 104)

## Turning Effects On/Off

The effect units (reverb, delay, multi-effects) built into the JX-305 can be switched on/off as a group. Turn this setting off when you wish to listen to the original sound as you edit, or when you wish to use external effect units instead of the built-in effects.

**1. Hold down [SHIFT] and press [FX-ON/OFF].**  
 The effects on/off page will appear.



**2. Use PAGE [<] [>] to move the cursor to the effect unit whose setting you wish to change, and use [INC] [DEC] or the [VALUE] dial to switch it on/off.**

When the effect on/off page is displayed, you can use the [PTN SET], [PTN/SONG] and [RPS SET] buttons of the DISPLAY section to switch reverb, delay, and multi-effects on/off.

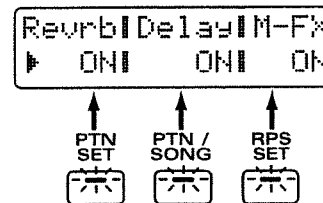

**3. To exit this page, press [EXIT].**

## Adding Reverberation to the Sound (Reverb)

Reverb is an effect which adds reverberation and ambiance to the sound, creating an impression of spatial depth. It simulates the sound of music played in a concert hall. In the REVERB parameters you can make settings which control the reverb.

### Adjusting the Overall Reverb Volume (Reverb Level)

You can adjust the overall volume of reverb for the eight parts (parts 1–7 and rhythm part).

1. Press [ENVELOPE/LFO1/EFFECTS] several times to make the EFFECTS indicator light.
2. Rotate the [REVERB LEVEL] knob to adjust the Reverb Level.

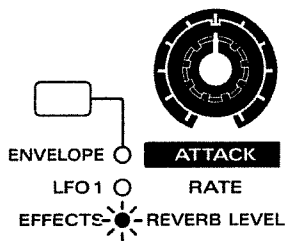

7

Range: 0–127

Rotating the knob clockwise will increase the reverb volume. Rotating the knob counterclockwise will decrease the reverb volume.

### Adjusting the Reverb Volume for Each Part (Part Reverb Level)

You can adjust the reverb volume for each part.

1. Hold down [SHIFT] and press [MIXER]. The indicator will blink, and the Part Mixer page will appear in the display.
2. Press PAGE [<] [>] several times to select the "Reverb" page.

The display will graphically indicate the Part Reverb Level of each part.

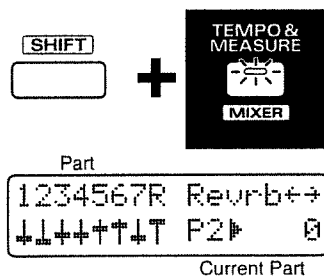

3. Use the eight knobs of the REALTIME MODIFY section and the QUANTIZE section to set the Part Reverb Level for each part.

Range: 0–127

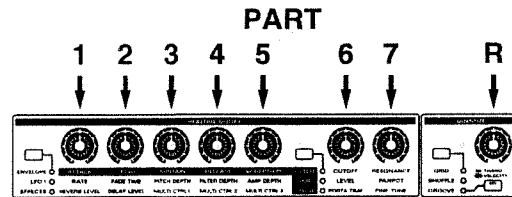

When you enter the Part Mixer page, all indicators of [ENVELOPE/LFO1/EFFECTS], [FILTER/AMP/PITCH] and [GRID/SHUFFLE/GROOVE] will blink, and you can use the eight knobs of the REALTIME MODIFY section and the QUANTIZE section to adjust the settings of each part. At this time, the QUANTIZE settings or REALTIME MODIFY cannot be modified by the knobs.

4. Press [EXIT] to exit the Part Mixer page.

If you wish to apply reverb to parts that are not using multi-effects, be aware that if either the Part Reverb Level of that part or the Reverb Level of all parts is set to "0," no reverb will be applied to that part. Also, if you set the Part Multi Effects Switch setting of the rhythm part to "RHY," you will be able to adjust the reverb volume for each rhythm tone.

☞ "Specifying the Part(s) to Which Multi-Effects Will Be Applied (Part Multi-Effects Switch)" (p. 124)

- If you wish to adjust the reverb volume for each rhythm tone...

☞ "R.TONE Rev Level (Rhythm Tone Reverb Level)" (p. 97)

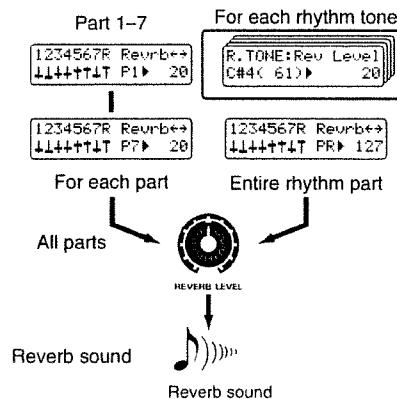

When the Part Multi Effects Switch setting of the rhythm part is "ON" or "OFF," raising the Part Reverb Level will apply reverb to all rhythm tones equally.

## Making More Detailed Settings

### 1. Press [EDIT].

The indicator will light, and the edit page will appear in the display.

### 2. Press BANK [2] (EFFECTS).

The EFFECTS setting page will appear.

### 3. Use PAGE [<] [>] to select parameters, and use [INC] [DEC] or the [VALUE] dial to make settings.

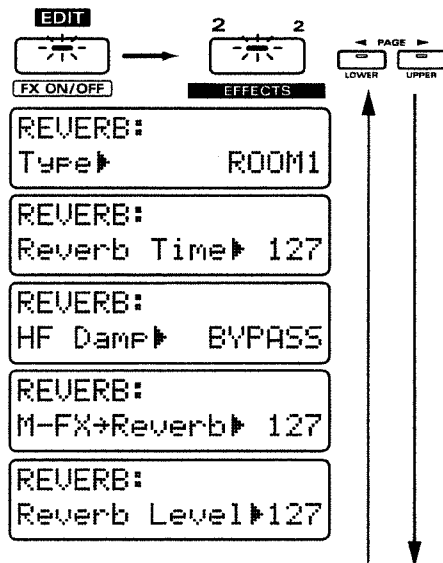

To exit the setting page, press [EXIT].

## Type (Reverb Type)

One of the following six basic types of reverb can be selected.

### Available Settings:

- ROOM1: Reverb with short decay and high density.
- ROOM2: Reverb with short decay and low density.
- STAGE1: Reverb with much lingering reverberation.
- STAGE2: Reverb with strong early reflections.
- HALL1: Clear-sounding reverb.
- HALL2: Rich-sounding reverb.

## Reverb Time

You can adjust the time over which the reverberation will continue.

Range: 0–127

The reverberation will become longer as this value is increased.

## HF Damp

Specifies the frequency at which the high frequency portions of the reverberation will be cut.

Range: 200–8000 (Hz), BYPASS

Lowering this setting will cause more of the upper frequency content to be cut, making the reverberation more muted in tone.

If you do not wish to cut the high frequency range, select "BYPASS."

## M-FX → Reverb (Multi Effects → Reverb Level)

Specify the amount of reverberation that will be applied to the sound processed by multi-effects.

Regardless of the Part Reverb Level of each part, reverb will apply equally to all parts whose Part Multi Effects Switch setting is "ON."

Range: 0–127

As this value is increased, more reverberation will be applied to the multi-effects sound.

\* This will not affect parts for which the Part Multi-Effects Switch is "OFF."

"Specifying the Part(s) to Which Multi-Effects Will Be Applied (Part Multi-Effects Switch)" (p. 124)

## Reverb Level

This is the setting page for "Adjusting the Overall Reverb Volume (Reverb Level)" (p. 102).

Range: 0–127

## Adding an Echo to the Sound (Delay)

Delay is an effect which adds echoes to the sound. It is effective when applied to solo phrases or to densely rhythmic phrases. In the DELAY parameters you can make settings that specify how the delay will sound.

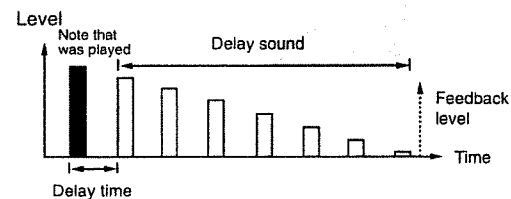

## Adjusting the Overall Delay Volume (Delay Level)

This adjusts the volume of the delay sound for all eight parts (parts 1–7 and the rhythm part).

1. Press **[ENVELOPE/LFO1/EFFECTS]** several times to make the **EFFECTS** indicator light.
2. Rotate the **[DELAY LEVEL]** knob to adjust the delay level.

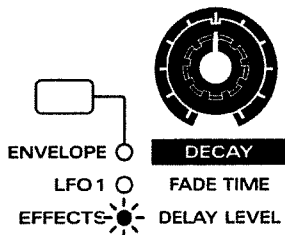

Range: 0–127

Rotating the knob clockwise will increase the volume of the delay sound. Rotating the knob counterclockwise will decrease the volume of the delay sound.

## Adjusting the Delay Volume for Each Part (Part Delay Level)

Adjusts the volume of the delay sound for each part.

1. Hold down **[SHIFT]** and press **[MIXER]**.  
The indicator will blink, and the Part Mixer page will appear in the display.
2. Press **PAGE** [**<**] [**>**] several times to select the "Delay" page.  
The display will graphically indicate the Part Delay Level of each part.

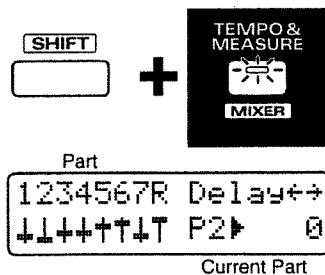

3. Use the eight knobs of the **REALTIME MODIFY** section and the **QUANTIZE** section to set the Part Delay Level for each part.

Range: 0–127

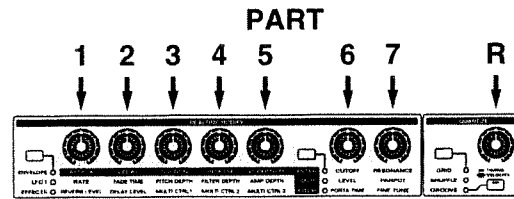

When you enter the Part Mixer page, all indicators of **[ENVELOPE/LFO1/EFFECTS]**, **[FILTER/AMP/PITCH]** and **[GRID/SHUFFLE/GROOVE]** will blink, and you can use the eight knobs of the **REALTIME MODIFY** section and the **QUANTIZE** section to adjust the settings of each part. At this time, the **QUANTIZE** settings or **REALTIME MODIFY** cannot be modified by the knobs.

4. Press **[EXIT]** to exit the Part Mixer page.

If you wish to apply delay to parts to which no multi-effects is applied, be aware that if either the Part Delay Level of that part or the Delay Level of all parts is set to "0," no delay will be applied to that part. Also, if you set the Part Multi Effects Switch setting of the rhythm part to "RHY," you will be able to adjust the delay volume for each rhythm tone.

☞ "Specifying the Part(s) to Which Multi-Effects Will Be Applied (Part Multi-Effects Switch)" (p. 124)

● If you wish to adjust the delay volume for each rhythm tone...

☞ "R.TONE Dly Level (Rhythm Tone Delay Level)" (p. 98)

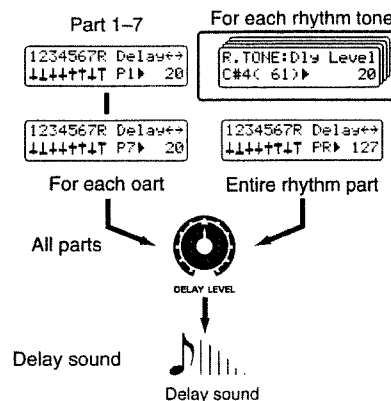

When the Part Multi Effects Switch setting of the rhythm part is "ON" or "OFF", raising the Part Delay Level will apply delay to all rhythm tones equally.

## Making More Detailed Settings

### 1. Press [EDIT].

The indicator will light, and the edit page will appear in the display.

### 2. Press BANK [2].

The EFFECTS setting page will appear.

### 3. Use PAGE [<] [>] to select parameters, and use [INC] [DEC] or the [VALUE] dial to make settings.

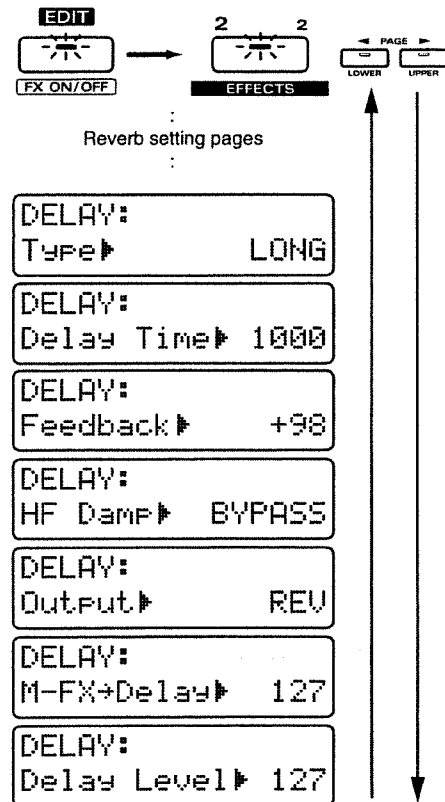

To exit the setting page, press [EXIT].

### Type (Delay Type)

One of the following two basic types of delay can be selected.

#### Available Settings:

**SHORT:** A delay which repeats at short intervals.

**LONG:** A delay which repeats at long intervals. You can also synchronize the spacing of the repeats to the tempo of the pattern.

### Delay Time

Adjusts the time from the original sound until when the delayed sound is heard (the interval between repeats).

#### Available Settings:

**SHORT:** 0.1–275

**LONG:** 200–1000, ♪

If this is set to a note value, the delay will synchronize to the tempo of the pattern, and will sound at the interval of the specified note value.

\* On the JX-305, it is not possible to set a delay time longer than 1000 ms (1 second). When the delay time is synchronized to the tempo, selecting a note value which would make the delay time exceed 1000 ms will cause the delay time to be halved, and the delay sound will be heard at 1/2 the specified interval. In addition, even if 1/2 the length would exceed 1000 ms, the delay time will be shortened to 1/4 the length.

### Feedback (Feedback Level)

Adjusts the proportion of the delay sound that will be repeated.

**Range:** 0–+98 (%)

Raising this value will increase the number of delay repeats.

### HF Damp

Determines the frequency at which the high frequency portions of the delay sound will be cut.

**Range:** 200–8000 (Hz), BYPASS

As this parameter is set to a lower frequency, more of the high range will be cut, making the delay sound more muted in tone.

If you do not wish to cut the high frequency range, select "BYPASS."

### Output (Delay Output Assign)

Specifies how the delay sound will be output.

#### Available Settings:

**LINE:** The delay sound will be output as is.

**REV:** Reverb will be applied to the delay sound before it is output.

**LINE+REV:** Delay without reverb and delay with reverb will both be output.

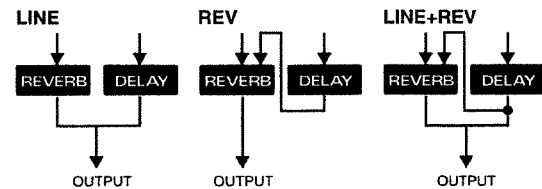

### M-FX → Delay (Multi Effects → Delay Level)

Specifies the volume of the delay that will be applied to the Multi Effects sound.

Regardless of the Part Delay Level of each part, delay will apply equally to all parts whose Part Multi Effects Switch setting is "ON."

**Range:** 0–127

\* This will not affect parts for which the Part Multi-Effects Switch is "OFF."

 "Specifying the Part(s) to Which Multi-Effects Will Be Applied (Part Multi-Effects Switch)" (p. 124)

### Delay Level

This is the setting page for "Adjusting the Overall Delay Volume (Delay Level)" (p. 104).

Range: 0-127

## Applying Various Effects to the Sound (Multi-Effects)

Multi Effects provides 24 different Effects Types, each of which let you apply a different effect. In the Multi-Effects parameters you can make settings that determine how Multi-Effects will sound.

### Selecting the Type (Multi-Effects Type)

1. Press [ENVELOPE/LFO1/EFFECTS] several times to make the EFFECTS indicator light.
2. Hold down [ENVELOPE/LFO1/EFFECTS] and use [INC] [DEC] or the [VALUE] dial to select the effect type.

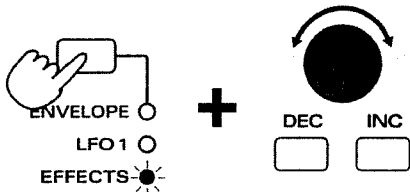
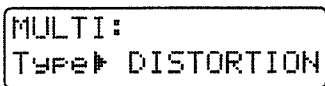

#### Available Settings:

- 4-BAND-EQ: 4 band EQ (modify the tone) (p. 107)
- SPECTRUM: Spectrum (add character to the sound) (p. 108)
- ENHANCER: Enhancer (add sparkle to the sound) (p. 109)
- OVERDRIVE: Overdrive (distort the sound mildly) (p. 109)
- DISTORTION: Distortion (distort the sound severely) (p. 110)
- Lo-Fi: Lo-Fi (simulate a "low-fidelity" sound) (p. 110)
- NOISE: Noise generator (add various types of noise) (p. 111)
- RADIO-TUNG: Radio tuning (simulate a radio being tuned) (p. 112)

- PHONOGRAPH: Phonograph (simulate an old record) (p. 112)
- COMPRESSOR: Compressor (make the volume level more consistent) (p. 113)
- LIMITER: Limiter (smooth out irregularities in volume) (p. 113)
- SLICER: Slicer (apply successive cuts to the sound) (p. 114)
- TREMOLO: Tremolo (cyclic changes in volume) (p. 115)
- PHASER: Phaser (modulate the sound) (p. 115)
- CHORUS: Chorus (add spaciousness and depth to the sound) (p. 116)
- SPACE-D: Space-D (add transparent depth) (p. 117)
- TETRA-CHRS: Tetra chorus (layer chorus sounds to add spaciousness) (p. 117)
- FLANGER: Flanger (add metallic resonance to the sound) (p. 118)
- ST-FLANGER: Step flanger (add metallic resonance to the sound while changing the pitch in steps) (p. 119)
- SHORT-DELY: Short delay (add echoes to the sound) (p. 120)
- AUTO-PAN: Auto pan (automatically move the stereo location) (p. 121)
- FB-P-SHIFT: Feedback pitch shifter (skew the pitch) (p. 122)
- REVERB: Reverb (add reverberation) (p. 123)
- GATE-REVRB: Gated reverb (sharply cut the reverberation) (p. 123)

### Adjusting the Overall Multi-Effects Volume (Multi-Effects Output Level)

This adjusts the volume of the multi-effects for all eight parts (parts 1-7 and the rhythm part).

1. Press [ENVELOPE/LFO1/EFFECTS] several times to make the EFFECTS indicator light.
2. Rotate the [MULTI CTRL 3] knob to adjust the Multi Effects level.

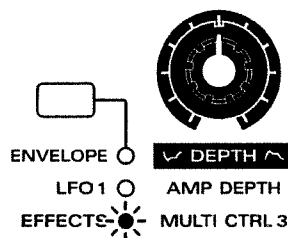

Range: 0-127

Rotating the knob toward the right will increase the volume of the multi-effects sound. Rotating the knob toward the left will decrease the volume of the multi-effects sound.

## Making Multi-Effects Settings

The parameters of the effect will depend on the Multi Effects Type that you selected. Of the parameters of each effect, the main ones can be adjusted using the front panel [MULTI CTRL 1/2] knob. For details on which knob corresponds to each parameter, refer to the explanatory diagram for each effect.

For example, in the case of the 4-band EQ, operation will be as follows.

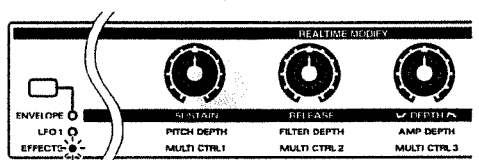

High Gain Low Gain Output Level

In addition to setting them from the front panel, you can also use the following procedure to set parameters except Part Multi-Effects Switch while viewing their value.

### 1. Press [EDIT].

The indicator will light, and the edit page will appear in the display.

### 2. Press BANK [2].

The effect setting page will appear.

### 3. Use PAGE [<] [>] to select parameters, and use [INC] [DEC] or the [VALUE] dial to set the value.

To exit the setting page, press [EXIT].

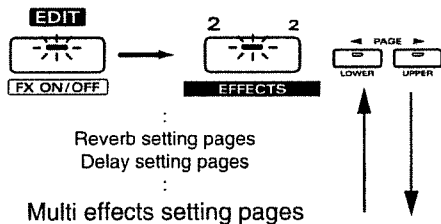

## 4 Band EQ (Modify the Tone)

This is a 4 band (high, midrange x 2, low) stereo equalizer.

MULTI:  
Type▶ 4-BAND-EQ

MULTI: 4-BAND-EQ  
Low Freq▶ 200

MULTI: 4-BAND-EQ  
Low Gain▶ +15

MULTI: 4-BAND-EQ  
High Freq▶ 8000

MULTI: 4-BAND-EQ  
High Gain▶ +15

MULTI: 4-BAND-EQ  
Peak1 Freq▶ 4000

MULTI: 4-BAND-EQ  
Peak1 Q▶ 0.5

MULTI: 4-BAND-EQ  
Peak1 Gain▶ +15

MULTI: 4-BAND-EQ  
Peak2 Freq▶ 4000

MULTI: 4-BAND-EQ  
Peak2 Q▶ 0.5

MULTI: 4-BAND-EQ  
Peak2 Gain▶ +15

MULTI: 4-BAND-EQ  
Output Level▶127

4-BAND-EQ



MULTI CTRL1  
High Gain



MULTI CTRL2  
Low Gain



MULTI CTRL3  
Output Level

### Low Freq (Low Frequency)

Determines the frequency of the low range.

Range: 200, 400 (Hz)

### Low Gain [MULTI CTRL 2]

Adjusts the volume of the low frequency range.

Range: -15~+15

### High Freq (High Frequency)

Determines the frequency of the high range.

Range: 4000, 8000 (Hz)

### High Gain [MULTI CTRL 1]

Adjusts the volume of the high frequency range.

Range: -15~+15

### Peak1 Freq (Peaking 1 Frequency)

Determines the frequency of midrange 1.

Range: 200~8000 (Hz)

### Peak1 Q (Peaking 1Q)

Specifies the width of the frequency range affected by midrange 1.

Range: 0.5–8.0

As this setting is increased, the affected area will become narrower.

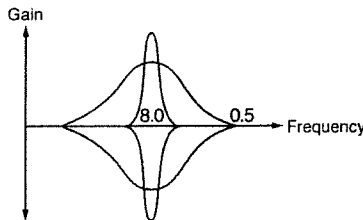

### Peak1 Gain (Peaking 1 Gain)

Adjusts the volume of midrange 1.

Range: -15+15

### Peak2 Freq (Peaking 2 Frequency)

Determines the frequency of midrange 2.

Range: 200–8000 (Hz)

### Peak2 Q (Peaking 2Q)

Specifies the width of the frequency range affected by midrange 2.

Range: 0.5–8.0

As this setting is increased, the affected area will become narrower.

### Peak2 Gain (Peaking 2 Gain)

Adjusts the volume of midrange 2.

Range: -15+15

### Output Level [MULTI CTRL 3]

Adjusts the output level from the 4 band EQ.

Range: 0–127

## Spectrum (Add Character to the Sound)

This is a type of filter, which modifies the tonal character by boosting or cutting specific frequencies. It is similar to an equalizer, but when you wish to add character to the sound, the Spectrum effect will produce a more distinctive result.

MULTI: SPECTRUM  
Type ▶ SPECTRUM

MULTI: SPECTRUM  
Low-High ▶ +15

MULTI: SPECTRUM  
Middle Gain ▶ +15

MULTI: SPECTRUM  
Width ▶ 5

MULTI: SPECTRUM  
Output Pan ▶ L64

MULTI: SPECTRUM  
Output Level1 ▶ 127

#### SPECTRUM



MULTI CTRL1  
Low-High Gain



MULTI CTRL2  
Middle Gain



MULTI CTRL3  
Output Level

### Low-High (Low-High Gain) [MULTI CTRL 1]

Specifies the volume change at 500Hz and 8000Hz.

Range: -15+15

### Middle (Middle Gain) [MULTI CTRL 2]

Specifies the volume change at 1250Hz.

Range: -15+15

### Width (Bandwidth)

Specifies the width of the bands in which the volume will be adjusted. (This setting applies to all bands.)

Range: 1–5

### Output Pan

Specifies the panning of the sound that is output from the Spectrum effect.

Range: L64–63R

### Output Level [MULTI CTRL 3]

Specifies the volume that is output from the Spectrum effect.

Range: 0–127



## Enhancer (Add Sparkle to the Sound)

By controlling the overtones of the high frequency range, this effect adds sparkle to the sound, giving it more definition.

Use this effect when you want to make a specific sound stand out from the rest of the ensemble, or to give it greater definition.

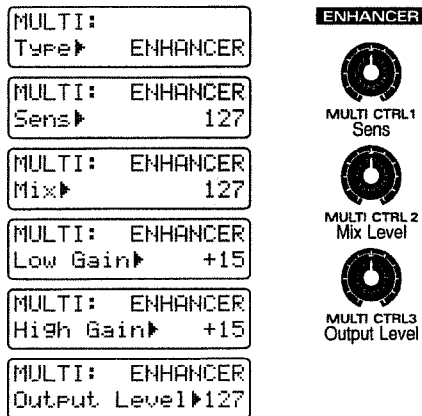

### Sens (Sensitivity) [MULTI CTRL 1]

Adjusts the depth of the enhancer effect.

Range: 0–127

### Mix (Mix Level) [MULTI CTRL 2]

Determines the proportion at which the overtones generated by the enhancer will be mixed with the original sound.

Range: 0–127

### Low Gain

Specifies how the low frequency range will be boosted or cut.

Range: -15–+15

### High Gain

Specifies how the high frequency range will be boosted or cut.

Range: -15–+15

### Output Level [MULTI CTRL 3]

Specifies the volume of the output from the Enhancer effect.

Range: 0–127

## Overdrive (Distort the Sound Mildly)

This simulates the soft distortion that occurs when you raise the gain of a vacuum tube amp. The effect also contains an amp simulator, and produces the natural distortion that is created by sounds played through a guitar amp. It is suitable for use with guitar and synth-bass sounds.

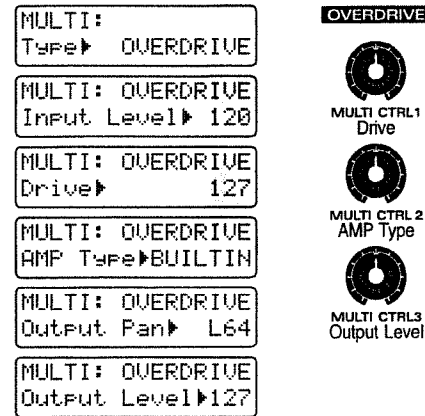

### Input Level

Adjusts the level of the input signal.

Range: 0–127

### Drive [MULTI CTRL 1]

Adjusts the depth of distortion. This will also affect the volume.

Range: 0–127

### AMP Type [MULTI CTRL 2]

Selection for the type of guitar amp.

Available Settings:

SMALL: small amp

BUILTIN: built-in type amp

2STACK: large double amp stack

3STACK: large triple amp stack

### Output Pan

Specifies the stereo location of the sound that is output from the Overdrive effect.

Range: L64–63R

### Output Level [MULTI CTRL 3]

Specifies the output volume from the Overdrive effect.

Range: 0–127

## Distortion (Distort the Sound Severely)

This effect produces a more severe distortion than the Overdrive effect. It also contains an amp simulator, and produces the natural sound of a guitar amp.

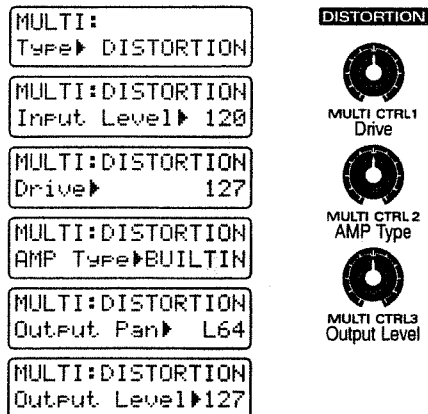

### Input Level

Adjusts the level of the input signal.  
Range: 0–127

### Drive [MULTI CTRL 1]

Adjusts the depth of distortion. This will also affect the volume.  
Range: 0–127

### AMP Type [MULTI CTRL 2]

Determines the type of guitar amp.  
Available Settings:  
SMALL: small amp  
BUILTIN: built-in type amp  
2STACK: large double amp stack  
3STACK: large triple amp stack

### Output Pan

Specifies the stereo location of the sound that is output from the Distortion effect.  
Range: L64–63R

### Output Level [MULTI CTRL 3]

Specifies the output volume from the Distortion effect.  
Range: 0–127

## Lo-Fi (Simulate a “Lo-Fidelity” Sound)

This effect intentionally degrades the audio quality to simulate a Lo-Fi sound. It is particularly effective on drums.

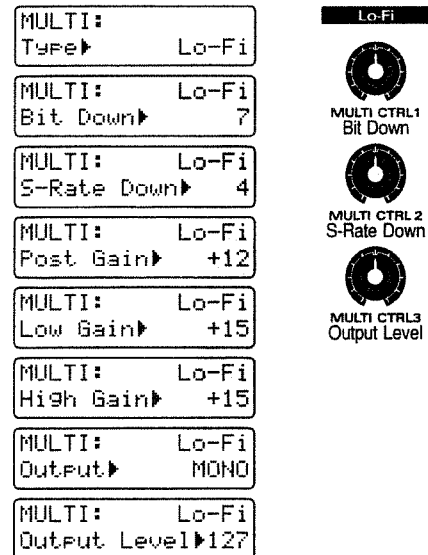

### Bit Down [MULTI CTRL 1]

This setting lowers the audio quality.  
Range: 0–7

The audio quality will worsen as this setting is increased.

### S-Rate Down (Sample Rate Down) [MULTI CTRL 2]

This coarsens the output signal.  
Range: 32, 16, 8, 4

The sound will become coarser as this setting is lowered.

### Post Gain

Adjusts the output signal.  
Range: 0, +6, +12, +18

### Low Gain

Adjusts the boost or cut applied to the low frequency range.  
Range: -15–+15

### High Gain

Adjusts the boost or cut applied to the high frequency range.  
Range: -15–+15

**Output**

Specifies how the sound will be output.

**Range:** MONO, STEREO

With a setting of "MONO," the output sound will be monaural.

**Output Level [MULTI CTRL 3]**

Specifies the output volume from the Lo-Fi effect.

**Range:** 0-127

**Noise Generator (Add Various Types of Noise)**

In addition to a Lo-Fi effect, this effect also generates various types of noise such as hum, pink noise, and disc noise.

MULTI: NOISE  
Type ▶ NOISE

MULTI: NOISE  
Noise Type ▶ 1

MULTI: NOISE  
Noise Level ▶ 127

MULTI: NOISE  
N Filter ▶ BYPASS

MULTI: NOISE  
Lo-Fi Level ▶ 127

MULTI: NOISE  
Output Pan ▶ L64

MULTI: NOISE  
Output Level ▶ 127

**NOISE**

MULTI CTRL1  
Lo-Fi Level

MULTI CTRL2  
Noise Level

MULTI CTRL3  
Output Level

**Noise Type**

Determines the type of noise(s) that will be generated.

**Range:** 1-18

**Noise Level [MULTI CTRL 2]**

Specifies the volume of the noise.

**Range:** 0-127

**N Filter (Noise Filter)**

Adjusts the tone of the noise.

**Range:** 200-8000 (Hz), BYPASS

If you do not wish to filter the noise, select "BYPASS."

**Lo-Fi Level [MULTI CTRL 1]**

Increasing this setting will make the original sound rougher.

**Range:** 0-127

**Output Pan**

Specifies the stereo location of the sound output from the Noise Generator.

**Range:** L64-63R

**Output Level [MULTI CTRL 3]**

Specifies the output volume of the Noise Generator effect.

**Range:** 0-127

**Noise Type Table**

	Hum (50 Hz)	Hum (60 Hz)	Pink	Disc EP	Disc LP	RND Disc
1						O
2			O			
3					O	O
4			O		O	O
5				O		O
6			O	O		O
7	O					
8	O		O			
9	O				O	O
10	O		O		O	O
11	O			O		O
12	O		O	O		O
13		O				
14		O	O			
15		O			O	O
16		O	O		O	O
17		O		O		O
18		O	O	O		O

For each setting, the type(s) of noise marked by "O" will be generated.

**Hum (50 Hz):** hum noise (50 Hz)

**Hum (60 Hz):** hum noise (60 Hz)

**Pink:** pink noise

**Disc EP:** disc noise (45 RPM)

**Disc LP:** disc noise (33 RPM)

**RND Disc:** disc noise generated at random

## Radio Tuning (Simulate a Radio Being Tuned)

This effect simulates the sound of a radio being tuned.

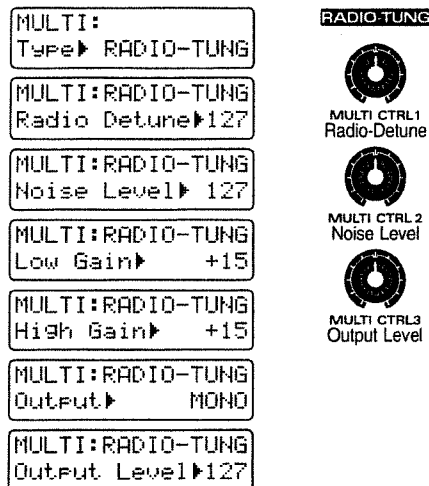

### Radio Detune [MULTI CTRL 1]

Specifies the frequency being tuned.

Range: 0–127

By rotating the [MULTI CTRL 1] knob in real time, you can make the effect appear more real.

### Noise Level [MULTI CTRL 2]

Specifies the volume of the tuning noise.

Range: 0–127

### Low Gain

Adjusts the boost or cut of the low frequency range.

Range: -15–+15

### High Gain

Adjusts the boost or cut of the high frequency range.

Range: -15–+15

### Output

Specifies how the sound will be output.

Range: MONO, STEREO

With a setting of “MONO,” the output will be monaural.

### Output Level [MULTI CTRL 3]

Specifies the output volume of the Radio Tuning effect.

Range: 0–127

## Phonograph (Simulates an Old Record)

This effect mutes the tone and adds disc noise to simulate the sound of music played on an old record player.

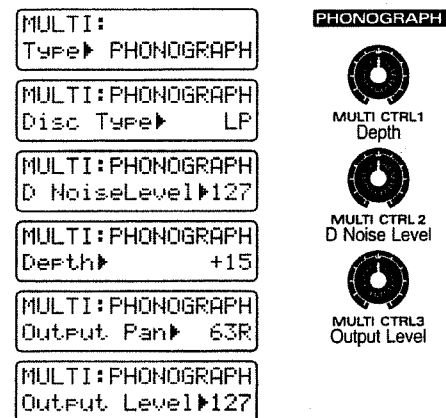

### Disc Type

Determines the type of disc noise.

Available Settings:

LP : 33 RPM record

EP : 45 RPM record

SP : 78 RPM record

### D NoiseLevel (Disc Noise Level) [MULTI CTRL 2]

Specifies the volume of the disc noise.

Range: 0–127

### Depth [MULTI CTRL 1]

Adjusts the tone.

Range: 0–+20

As this value is increased, the high range and low range will be cut, and the mid range will be emphasized.

### Output Pan

Specifies the stereo location of the output from the Phonograph effect.

Range: L64–63R

### Output Level [MULTI CTRL 3]

Specifies the output volume from the Phonograph effect.

Range: 0–127

## Compressor (Make the Volume Level More Consistent)

This effect suppresses loud volume levels and boosts soft volume levels, making the volume more consistent.

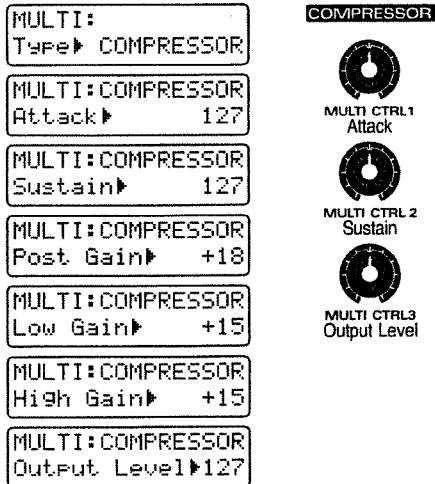

### Attack [MULTI CTRL 1]

Specifies the duration of the attack when sound is input.

Range: 0–127

### Sustain [MULTI CTRL 2]

Specifies the time over which low-level sounds will be boosted to reach the specified volume.

Range: 0–127

### Post Gain

Adjusts the output signal.

Range: 0, +6, +12, +18

### Low Gain

Adjusts the boost or cut of the low frequency range.

Range: -15–+15

### High Gain

Adjusts the boost or cut of the high frequency range.

Range: -15–+15

### Output Level [MULTI CTRL 3]

Specifies the output volume from the Compressor effect.

Range: 0–127

## Limiter (Smooth Out Irregularities in Volume)

This effect compresses the sound when it exceeds a specified volume level, thus preventing distortion.

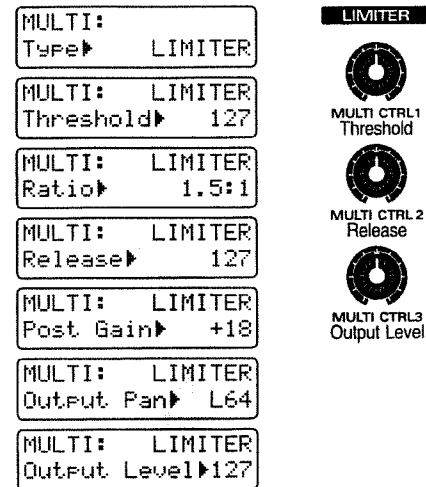

### Threshold (Threshold Level)

#### [MULTI CTRL 1]

Specifies the volume level at which compression will begin.

Range: 0–127

### Ratio (Compression Ratio)

Specifies the ratio of compression.

Range: 1.5:1, 2.0:1, 4.0:1, 100:1

### Release [MULTI CTRL 2]

Specifies the time from when the volume drops below the Threshold Level until compression is no longer applied.

Range: 0–127

### Post Gain

Adjusts the output signal.

Range: 0, +6, +12, +18

### Output Pan

Specifies the stereo location of the output from the Limiter effect.

Range: L64–63R

### Output Level [MULTI CTRL 3]



Specifies the output volume of the Limiter effect.

Range: 0–127



## Tremolo (Cyclic Changes in Volume)

This effect cyclically modulates the volume to create tremolo.

MULTI: Type ▶ TREMOLO	<b>TREMOLO</b>  MULTI CTRL1 Depth  MULTI CTRL2 Rate  MULTI CTRL3 Output Level
MULTI: TREMOLO LFO Type ▶ TRI	
MULTI: TREMOLO Rate ▶ 0.1	
MULTI: TREMOLO Depth ▶ 127	
MULTI: TREMOLO Low Gain ▶ +15	
MULTI: TREMOLO High Gain ▶ +15	
MULTI: TREMOLO Output Level ▶ 127	

### LFO Type

Determines the waveform that will be used to modulate the sound.

Range: TRI, TRP, SIN, SAW1, SAW2, SQW

### Rate [MULTI CTRL 2]

Specifies the frequency of modulation.

Range: 0.1–10.0

  
 2MES 3MES 4MES 8MES 16MES

If a note value or measure is selected as the value of this parameter, the Rate will synchronize with the tempo of the pattern at intervals of the specified note value or measure.

### Depth [MULTI CTRL 1]

Specifies the depth of modulation.

Range: 0–127

### Low Gain

Adjusts the boost or cut of the low frequency range.

Range: -15+15

### High Gain

Adjusts the boost or cut of the high frequency range.

Range: -15+15



### Output Level [MULTI CTRL 3]

Specifies the output volume of the Tremolo effect.

Range: 0–127

## Phaser (Modulate the Sound)

By adding a phase-shifted sound to the original sound, this effect modulates the sound to add depth and a sense of rotation.

MULTI: Type ▶ PHASER	<b>PHASER</b>  MULTI CTRL1 Depth  MULTI CTRL2 Rate  MULTI CTRL3 Output Level
MULTI: PHASER Manual ▶ 100	
MULTI: PHASER Rate ▶ 0.1	
MULTI: PHASER Depth ▶ 127	
MULTI: PHASER Resonance ▶ 127	
MULTI: PHASER Mix ▶ 127	
MULTI: PHASER Output Pan ▶ L64	
MULTI: PHASER Output Level ▶ 127	

### Manual

Specifies the center frequency at which the sound will be modulated.

Range: 100–8000 (Hz)

### Rate [MULTI CTRL 2]

Specifies the frequency of modulation.

Range: 0.1–10.0

  
 2MES 3MES 4MES 8MES 16MES

If a note value or measure is selected as the value of this parameter, the Rate will synchronize with the tempo of the pattern at intervals of the specified note value or measure.

### Depth [MULTI CTRL 1]

Specifies the depth of modulation.

Range: 0–127

### Resonance

This setting emphasizes the frequency range in the vicinity of the center frequency.

Range: 0–127

### Mix (Mix Level)

Adjusts the proportion of the original sound that will be combined with the phase-shifted sound.

Range: 0–127

### Output Pan

Specifies the stereo location of the output from the Phaser effect.

Range: L64-63R

### Output Level [MULTI CTRL 3]

Specifies the output volume of the Phaser effect.

Range: 0-127

## Chorus (Add Spaciousness and Depth to the Sound)

This effect creates an impression of multiple sound sources in unison (Chorus effect), giving spaciousness and depth to the sound.

MULTI: CHORUS  
Type▶ CHORUS

MULTI: CHORUS  
Pre Delay▶ 0.0

MULTI: CHORUS  
Rate▶ 0.1

MULTI: CHORUS  
Depth▶ 127

MULTI: CHORUS  
Phase▶ 180

MULTI: CHORUS  
Filter Type▶ LPF

MULTI: CHORUS  
Cutoff▶ 8000

MULTI: CHORUS  
Balance▶ D50:50E

MULTI: CHORUS  
Output Level▶ 127

**CHORUS**

MULTI CTRL1  
Depth

MULTI CTRL2  
Rate

MULTI CTRL3  
Output Level

### Depth [MULTI CTRL 1]

Specifies the depth of modulation.

Range: 0-127

### Phase

Adjusts the spaciousness of the sound.

Range: 0-180

As this setting is increased, the sound will spread more toward left and right.

### Filter Type

Determines the type of filter that will be applied to the chorus sound.

Available Settings:

OFF : A filter will not be used.

LPF : The frequency range above the cutoff frequency will be cut.

HPF : The frequency range below the cutoff frequency will be cut.

### Cutoff (Cutoff Frequency)

Specifies the cutoff frequency of the filter.

Range: 200-8000 (Hz)

### Balance (Effect Balance)

Adjusts the volume balance between the original sound and the chorus sound.

Range: D100:0E-D0:100E

With a setting of "D100:0E," no chorus sound will be output.

### Output Level [MULTI CTRL 3]

Specifies the output volume from the stereo chorus.

Range: 0-127

7

### Pre Delay (Pre Delay Time)

Specifies the time from the original sound until when the chorus sound is heard.

Range: 0.0-100

### Rate [MULTI CTRL 2]

Specifies the frequency of modulation.

Range: 0.1-10.0

♩ ♪ ♫ ♪ ♫ ♪ ♫ ♪ ♫ ♪ ♫ ♪ ♫ ♪ ♫ ♪ ♫ ♪ ♫  
2MES 3MES 4MES 8MES 16MES

If a note value or measure is selected as the value of this parameter, the Rate will synchronize with the tempo of the pattern at intervals of the specified note value or measure.



## Space-D (Add Transparent Depth)

This is a type of chorus, but unlike a conventional chorus, it does not create a sense of modulation. It produces a chorus effect with an impression of transparency.

MULTI: SPACE-D  
Type ▶ SPACE-D

MULTI: SPACE-D  
Pre Delay ▶ 0.0

MULTI: SPACE-D  
Rate ▶ 0.1

MULTI: SPACE-D  
Depth ▶ 127

MULTI: SPACE-D  
Phase ▶ 180

MULTI: SPACE-D  
Low Gain ▶ +15

MULTI: SPACE-D  
High Gain ▶ +15

MULTI: SPACE-D  
Balance ▶ D50:50E

MULTI: SPACE-D  
Output Level ▶ 127

SPACE-D

MULTI CTRL1  
Depth

MULTI CTRL2  
Rate

MULTI CTRL3  
Output Level

### Pre Delay (Pre Delay Time)

Specifies the time from the original sound until the chorus sound is heard.

Range: 0.0–100

### Rate [MULTI CTRL 2]

Specifies the rate of modulation.

Range: 0.1–10.0

♩ ♪ ♫ ♬ ♭ ♮ ♯ ♯♯ ♯♯♯ ♯♯♯♯ ♯♯♯♯♯  
2MES 3MES 4MES 8MES 16MES

If a note value or measure is selected as the value of this parameter, the Rate will synchronize with the tempo of the pattern at intervals of the specified note value or measure.

### Depth [MULTI CTRL 1]

Specifies the depth of modulation.

Range: 0–127

### Phase

Adjusts the spread of the sound.

Range: 0–180

As this value is increased, the sound will have a broader left/right spread.

### Low Gain

Adjusts the boost or cut of the low frequency range.

Range: -15–+15

### High Gain

Adjusts the boost or cut of the high frequency range.

Range: -15–+15

### Balance (Effect Balance)

Adjusts the volume balance between the original sound and the chorus sound.

Range: D100:0E–D0:100E

With a setting of “D100:0E” the chorus sound will not be heard.

### Output Level [MULTI CTRL 3]

Specifies the output volume from the Space-D effect.

Range: 0–127

## Tetra Chorus (Layer Chorus Sounds to Add Spaciousness)

This effect layers four chorus sounds to produce even more depth and spaciousness than a conventional chorus.

MULTI: TETRA-CHRS  
Type ▶ TETRA-CHRS

MULTI: TETRA-CHRS  
Pre Delay ▶ 0.0

MULTI: TETRA-CHRS  
Rate ▶ 0.1

MULTI: TETRA-CHRS  
Depth ▶ 127

MULTI: TETRA-CHRS  
Pre Delay Devi ▶ 20

MULTI: TETRA-CHRS  
Depth Devi ▶ +20

MULTI: TETRA-CHRS  
Pan Devi ▶ 20

MULTI: TETRA-CHRS  
Balance ▶ D50:50E

MULTI: TETRA-CHRS  
Output Level ▶ 127

TETRA-CHRS

MULTI CTRL1  
Depth

MULTI CTRL2  
Rate

MULTI CTRL3  
Output Level

### Pre Delay (Pre Delay Time)

Specifies the time from the original sound until the chorus sound is heard.

Range: 0.0–100

**Rate [MULTI CTRL 2]**

Specifies the rate of modulation.

Range: 0.1–10.0

♩ ♪ ♫ ♪ ♫ ♪ ♫ ♪ ♫ ♪ ♫ ♪ ♫ ♪ ♫ ♪ ♫

2MES 3MES 4MES 8MES 16MES

If a note value or measure is selected as the value of this parameter, the Rate will synchronize with the tempo of the pattern at intervals of the specified note value or measure.

**Depth [MULTI CTRL 1]**

Specifies the depth of modulation.

Range: 0–127

**Pre Dly Devi (Pre Delay Deviation)**

Adjusts the difference in pre delay between each of the chorus sounds.

Range: 0–20

**Depth Devi (Depth Deviation)**

Adjusts the difference in modulation depth between each of the chorus sounds.

Range: -20–+20

**Pan Devi (Pan Deviation)**

Adjusts the pan difference between each chorus sound.

Range: 0–20

As this value is increased, the sound will have a greater left/right spread.

**Balance (Effect Balance)**

Specifies the volume balance between the original sound and the chorus sound.

Range: D100:0E–D0:100E

With a setting of “D100:0E” no chorus sound will be output.

**Output Level [MULTI CTRL 3]**

Specifies the output volume from the Tetra Chorus effect.

Range: 0–127

**Flanger (Add Metallic Resonance to the Sound)**

This creates a sharper and more mechanical sound than the phaser. It can add a metallic resonance to the sound, or produce an effect that sounds like an jet airplane taking off and landing.

MULTI: FLANGER  
Type ▶ FLANGER

MULTI: FLANGER  
Pre Delay ▶ 0.0

MULTI: FLANGER  
Rate ▶ 0.1

MULTI: FLANGER  
Depth ▶ 127

MULTI: FLANGER  
Feedback ▶ +98

MULTI: FLANGER  
Phase ▶ 180

MULTI: FLANGER  
Filter Type ▶ LPF

MULTI: FLANGER  
Cutoff ▶ 8000

MULTI: FLANGER  
Balance ▶ D50:50E

MULTI: FLANGER  
Output Level ▶ 127

**FLANGER**

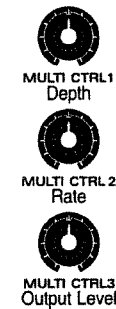

**Pre Delay (Pre Delay Time)**

Specifies the time from the original sound until the flanger sound is heard.

Range: 0.0–100

**Rate [MULTI CTRL 2]**

Specifies the rate of modulation.

Range: 0.1–10.0

♩ ♪ ♫ ♪ ♫ ♪ ♫ ♪ ♫ ♪ ♫ ♪ ♫ ♪ ♫ ♪ ♫

2MES 3MES 4MES 8MES 16MES

If a note value or measure is selected as the value of this parameter, the Rate will synchronize with the tempo of the pattern at intervals of the specified note value or measure.

**Depth [MULTI CTRL 1]**

Specifies the depth of modulation.

Range: 0–127

7

**Feedback (Feedback Level)**

Specifies the proportion of the flanger sound that is fed back into the input.

Range: 0–+98 (%)

**Phase**

Adjusts the width of the sound.

Range: 0–180

As this setting is increased, the left/right spread of the sound will increase.

**Filter Type**

Determines the type of filter that will be applied to the flanger sound.

**Available Settings:**

**OFF** : A filter will not be used.

**LPF** : The frequency range above the cutoff frequency will be cut.

**HPF** : The frequency range below the cutoff frequency will be cut.

**Cutoff (Cutoff Frequency)**

Specifies the cutoff frequency of the filter.

Range: 200–8000 (Hz)

**Balance (Effect Balance)**

Adjusts the volume balance between the original sound and the flanger sound.

Range: D100:0E–D0:100E

With a setting of “D100:0E,” no flanger sound will be output.



**Output Level [MULTI CTRL 3]**

Specifies the output volume from the stereo flanger.

Range: 0–127

**Step Flanger (Add Metallic Resonance to the Sound While Changing the Pitch in Steps)**

This is a flanger that changes the pitch of the sound in steps. The frequency of pitch change can also be synchronized to the tempo.

MULTI: Type ▶ ST-FLANGER	<b>ST-FLANGER</b>  MULTI CTRL 1 Depth  MULTI CTRL 2 Step Rate  MULTI CTRL 3 Output Level
MULTI: ST-FLANGER Pre Delay ▶ 0.0	
MULTI: ST-FLANGER Rate ▶ 0.1	
MULTI: ST-FLANGER Depth ▶ 127	
MULTI: ST-FLANGER Feedback ▶ +98	
MULTI: ST-FLANGER Phase ▶ 180	
MULTI: ST-FLANGER Step Rate ▶ 10.0	
MULTI: ST-FLANGER Balance ▶ D50:50E	
MULTI: ST-FLANGER Output Level ▶ 127	

**Pre Delay (Pre Delay Time)**

Specifies the time from the original sound until the flanger sound is heard.

Range: 0.0–100

**Rate**

Specifies the rate of modulation.

Range: 0.1–10.0

♩ ♪ ♫ ♬ ♭ ♮ ♯ ♯♯ ♯♯♯ ♯♯♯♯ ♯♯♯♯♯ ♯♯♯♯♯♯  
2MES 3MES 4MES 8MES 16MES

If a note value or measure is selected as the value of this parameter, the Rate will synchronize with the tempo of the pattern at intervals of the specified note value or measure.

**Depth [MULTI CTRL 1]**

Specifies the depth of modulation.

Range: 0–127

**Feedback (Feedback Level)**

Specifies the proportion of the flanger sound which will be fed back into the input.

Range: 0–+98 (%)

### Phase

Adjusts the spread of the sound.

Range: 0–180

As this value is increased, the left/right spread of the sound will increase.

### Step Rate [MULTI CTRL 2]

Specifies the rate at which the pitch will change.

Range: 0.05–10.0 (Hz)



If a note value is selected as the value of this parameter, the Step Rate will synchronize with the tempo of the pattern at intervals of the specified note value.

### Balance (Effect Balance)

Adjusts the volume balance between the original sound and the flanger sound.

Range: D100:0E–D0:100E

With a setting of “D100:0E” no flanger sound will be output.

### Output Level [MULTI CTRL 3]

Specifies the output volume of the Step Flanger effect.

Range: 0–127

## Short Delay (Add Echoes to the Sound)

This is a short delay which allows you to set the left and right delay times independently. You can also move the panning of the delay sound in synchronization with the tempo.

MULTI: Type ▶ SHORT-DELY	
MULTI: SHORT-DELY Time L ▶ 190	
MULTI: SHORT-DELY Time R ▶ 190	
MULTI: SHORT-DELY HF Damp ▶ BYPASS	
MULTI: SHORT-DELY Feedback ▶ +98	
MULTI: SHORT-DELY Auto Pan ▶ OFF	
MULTI: SHORT-DELY Low Gain ▶ +15	
MULTI: SHORT-DELY High Gain ▶ +15	
MULTI: SHORT-DELY Balance ▶ D50:50E	
MULTI: SHORT-DELY Output Level ▶ 127	

### Time L (Delay Time Left) [MULTI CTRL 1]

Specifies the time from the original sound until the left delay sound is heard.

Range: 0.1–190

### Time R (Delay Time Right) [MULTI CTRL 2]

Specifies the time from the original sound until the right delay sound is heard.

Range: 0.1–190

### HF Damp

Determines the frequency at which the high frequency portions of the delay sound will be cut.

Range: 200–8000 (Hz), BYPASS

As this parameter is set to a lower frequency, more of the high range will be cut, making the delay sound more muted in tone.

If you do not wish to cut the high frequency range, select “BYPASS.”

### Feedback (Feedback Level)

Adjusts the number of delay repeats.  
Range: 0→+98 (%)

### Auto Pan

This setting causes the panning of the delay sound to move in synchronization with the tempo.

Range: OFF  2MES 3MES 4MES 8MES 16MES

### Low Gain

Adjusts the boost or cut of the low frequency range.  
Range: -15→+15

### High Gain

Adjusts the boost or cut of the high frequency range.  
Range: -15→+15

### Balance (Effect Balance)

Adjusts the volume balance between the original sound and the delay sound.

Range: D100:0E-D0:100E

With a setting of "D100:0E" no delay sound will be output.

### Output Level [MULTI CTRL 3]

Specifies the output volume from the Short Delay effect.

Range: 0-127

### Auto Pan (Automatically Move the Stereo Location)

This effect automatically moves the stereo location of the sound. You can cause the sound to be panned left and right in time with low notes such as a Bass Drum, or in synchronization with the tempo of the pattern.

MULTI: Type▶	AUTO-PAN
MULTI: AUTO-PAN LFO Type▶	TRI
MULTI: AUTO-PAN Rate▶	0.1
MULTI: AUTO-PAN Bass Sens▶	OFF
MULTI: AUTO-PAN Depth▶	127
MULTI: AUTO-PAN Low Gain▶	+15
MULTI: AUTO-PAN High Gain▶	+15
MULTI: AUTO-PAN Output Level▶	127

**AUTO-PAN**



MULTI CTRL1  
Depth

MULTI CTRL2  
Rate

MULTI CTRL3  
Output Level

### LFO Type

Determines the waveform that will be used to pan the sound to left and right.

Range: TRI, TRP, SIN, SAW1, SAW2, SQR

### Rate [MULTI CTRL 2]

Specifies the rate at which the pan will be moved.

Range: 0.1-10.0

 2MES 3MES 4MES 8MES 16MES

If a note value or measure is selected as the value of this parameter, the Rate will synchronize with the tempo of the pattern at intervals of the specified note value or measure.

\* When the Bass Sensitivity parameter is set to "MODE2," the Rate setting will be ignored.

### Bass Sens (Bass Sensitivity)

Make this setting when you wish to shift the panning at the timing of the bass notes.

Available Settings:

OFF: The panning will change at the speed specified by Rate.

MODE1: The Rate value will increase at the timing of the bass notes.

MODE2: The panning will change at the timing of the bass notes.

### Depth [MULTI CTRL 1]

Specifies the depth of panning.

Range: 0-127

### Low Gain

Adjusts the boost or cut of the low frequency range.

Range: -15→+15

### High Gain

Adjusts the boost or cut of the high frequency range.

Range: -15→+15

### Output Level [MULTI CTRL 3]

Specifies the output volume of the Auto Pan effect.

Range: 0-127

## Feedback Pitch Shifter (Skew the Pitch)

This effect shifts the pitch of the original sound and layers it with the original sound. It can be used to play unison lines at an interval of an octave or fifth, or to layer a slightly pitch-shifted with the original sound to create a chorus effect.

MULTI:  
Type ▶ FB-P-SHIFT

MULTI:FB-P-SHIFT  
Coarse ▶ +12

MULTI:FB-P-SHIFT  
Fine ▶ +50

MULTI:FB-P-SHIFT  
Output Pan ▶ L64

MULTI:FB-P-SHIFT  
Pre Delay ▶ 0.0

MULTI:FB-P-SHIFT  
Mode ▶ 1

MULTI:FB-P-SHIFT  
Feedback ▶ +98

MULTI:FB-P-SHIFT  
Low Gain ▶ +15

MULTI:FB-P-SHIFT  
High Gain ▶ +15

MULTI:FB-P-SHIFT  
Balance ▶ D50:50E

MULTI:FB-P-SHIFT  
Output Level ▶ 127

### FB-P-SHIFT



MULTI CTRL1  
Coarse



MULTI CTRL2  
Fine



MULTI CTRL3  
Output Level

### Mode (Pitch Shifter Mode)

Specifies how the pitch will be shifted.

Range: 1–5

As this setting is increased, the response will be slower, but the sound will be more stable.

### Feedback (Feedback Level)

Specifies the proportion of the pitch-shifted sound that will be fed back into the input.

Range: 0–+98 (%)

### Low Gain

Adjusts the boost or cut of the low frequency range.

Range: -15–+15

### High Gain

Adjusts the boost or cut of the high frequency range.

Range: -15–+15

### Balance (Effect Balance)

Specifies the volume balance between the original sound and the pitch-shifted sound.

Range: D100:0E–D0:100E

When the setting is “D100:0E” the pitch-shifted sound will not be output.

### Output Level [MULTI CTRL 3]

Specifies the output volume of the Feedback Pitch Shifter effect.

Range: 0–127

7

### Coarse (Coarse Pitch) [MULTI CTRL 1]

Specifies the amount of pitch shift relative to the original sound, in semitone steps.

Range: -24–+12

### Fine (Fine Pitch) [MULTI CTRL 2]

Adjusts the amount of pitch shift in 2-cent steps.

Range: -100–+100

### Output Pan

Determines the stereo location of the pitch-shifted sound.

Range: L64–63R

### Pre Delay (Pre Delay Time)

Specifies the time from the original sound until the pitch-shifted sound is heard.

Range: 0.0–100

## Reverb (Add Reverberation)

This effect adds reverberation and ambiance to the sound, creating spatial depth.

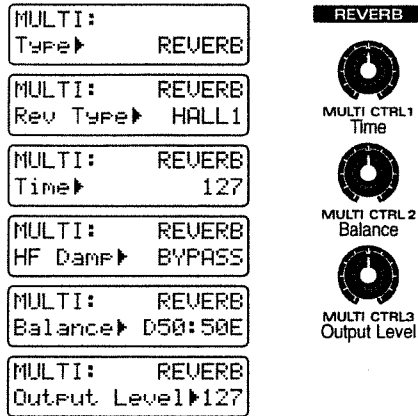

### Rev Type (Reverb Type)

You can select one of the following six basic types of reverb.

#### Available Settings:

- ROOM1:** Reverb with short decay and high density.
- ROOM2:** Reverb with short decay and low density.
- STAGE1:** Reverb with much subsequent reverberation.
- STAGE2:** Reverb with strong early reflections.
- HALL1:** Clear-sounding reverb.
- HALL2:** Rich-sounding reverb.

### Time (Reverb Time) [MULTI CTRL 1]

Specifies the duration of the reverberation.

Range: 0–127

### HF Damp

Determines the frequency at which the high frequency portions of the reverberation will be cut.

Range: 200–8000 (Hz), **BYPASS**

As this parameter is set to a lower frequency, more of the high range will be cut, making the reverberation more muted in tone.

If you do not wish to cut the high frequency range, select “BYPASS.”

### Balance (Effect Balance) [MULTI CTRL 2]

Specifies the volume balance between the original sound and the reverberation.

Range: **D100:0E–D0:100E**

With a setting of “D100:0E” no reverb sound will be output.

### Output Level [MULTI CTRL 3]

Specifies the output volume from the reverb effect.

Range: 0–127

## Gated Reverb (Sharply Cut the Reverberation)

This is a type of reverb, in which the reverberation is cut off before the natural completion of its decay.

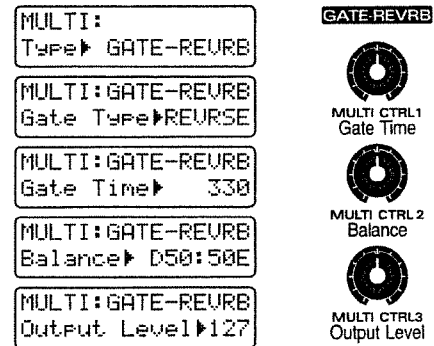

### Gate Type (Gate Reverb Type)

Select one of the following four basic types of gated reverb.

#### Available Settings:

- NORMAL:** Normal gated reverb
- REVRSE:** Reverse-playback reverb
- SWEEP1:** The reverberation will sweep from right to left.
- SWEEP2:** The reverberation will sweep from left to right.

### Gate Time (Gate Reverb Time)

#### [MULTI CTRL 1]

Specifies the time from when the reverberation begins until it ends.

Range: 5–330

### Balance (Effect Balance) [MULTI CTRL 2]

Specifies the volume balance between the original sound and the reverberation.

Range: **D100:0E–D0:100E**

With a setting of “D100:0E” no reverberation will be output.

### Output Level [MULTI CTRL 3]

Specifies the output volume of the Gate Reverb effect.

Range: 0–127

## Specifying the Part(s) to Which Multi-Effects Will Be Applied (Part Multi-Effects Switch)

Multi-effects can be switched on/off for each part.

### 1. Hold down [SHIFT] and press [MIXER].

The indicator will blink, and the Part Mixer page will appear in the display.

### 2. Press PAGE [<] [>] several times to select the "M-FX" page.

The display will graphically indicate the on/off status of the Part Multi-Effects Switch for each part.

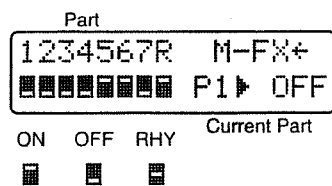

### 3. Use the eight knobs of the REALTIME MODIFY section and the QUANTIZE section to set the Part Multi-Effects Switch for each part.

Range:

OFF: Multi-effects will not be applied.

ON: Multi-effects will be applied.

RHY: The sound will be output according to the Rhythm Tone Multi-Effects Switch, Rhythm Tone Reverb Level, and Rhythm Tone Delay Level settings of the currently selected rhythm set (rhythm part only).

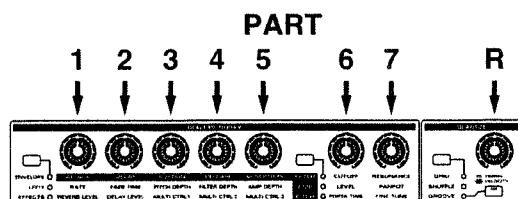

\* If the Multi-Effects Output Level setting is low, the sound of the patch/rhythm set to which multi-effects is applied will not be audible.

When you enter the Part Mixer page, all indicators of [ENVELOPE/LFO1/EFFECTS], [FILTER/AMP/PITCH] and [GRID/SHUFFLE/GROOVE] will blink, and you can use the eight knobs of the REALTIME MODIFY section and the QUANTIZE section to adjust the settings of each part. At this time, the QUANTIZE settings or REALTIME MODIFY cannot be modified by the knobs.

### 4. Press [EXIT] to exit the Part Mixer page.

☞ "Adjusting the Overall Multi-Effects Volume (Multi-Effects Output Level)" (p. 106)

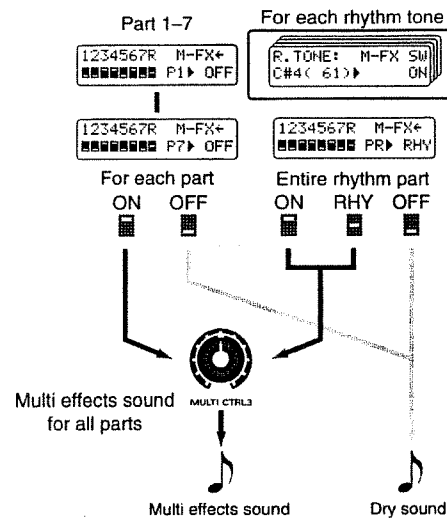

If you wish to apply multi-effects or adjust the reverb/delay volume for an individual rhythm tone, select "RHY."

☞ To adjust the reverb volume for individual rhythm tones...

☞ "R.TONE Rev Level (Rhythm Tone Reverb Level)" (p. 97)

☞ To adjust the delay volume for individual rhythm tones...

☞ "R.TONE Dly Level (Rhythm Tone Delay Level)" (p. 98)

☞ To turn multi-effects on/off for each rhythm tone...

☞ "R.TONE M-FX SW (Rhythm Tone Multi-Effects Switch)" (p. 98)



# Chapter 8. Recording Patterns

The JX-305 lets you create your own original patterns by recording your playing on the built-in sequencer. Broadly speaking, there are two ways to record: real-time recording lets you record your playing and operations just as you perform, and step recording lets you input notes one by one. The basic recording procedure is as follows.

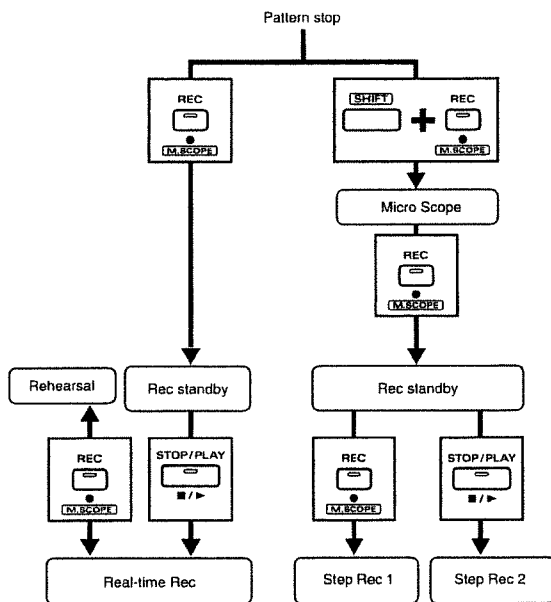

\* A pattern you record is held in the temporary pattern (TMP). If you wish to keep a pattern that you have recorded, you must use the Pattern Write operation.

**"Saving Patterns You've Modified (Pattern Write)"** (p. 36)

## Undo/Redo

If you are not happy with the pattern that was recorded, you can press the [UNDO/REDO] button to return the data to the state before it was recorded.

**"Canceling the Previous Operation (Undo/Redo)"** (p. 17)

## Recording Your Playing As You Perform (Real-Time Recording)

Real-time recording is a method in which your playing on the keyboard and your controller operations are recorded just as they occur. The JX-305 uses two types of real-time recording, and different types of data are recorded using different methods.

## Loop Mix recording

Recording will take place repeatedly from the beginning to the end of the pattern. If data was already recorded in the pattern from a previous pass, it will remain, and the newly recorded data will be combined with it. Note messages are recorded using this method.

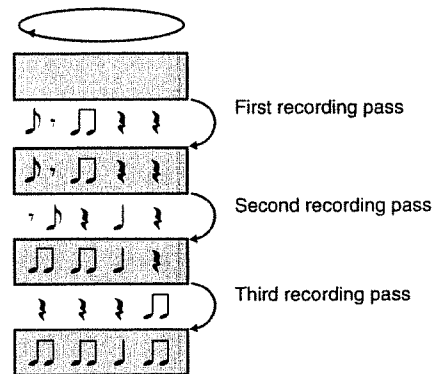

## Loop Replace recording

Recording will take place repeatedly from the beginning to the end of the pattern. If data was already recorded in the pattern from a previous pass, it will be erased and replaced by the recording. Controller operations, etc. are recorded using this method.

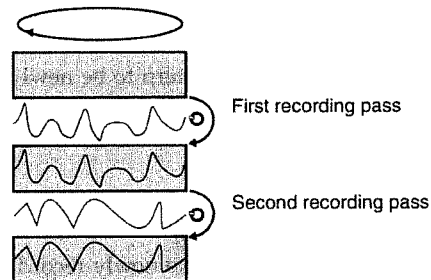

## Recording Procedure

Before you begin, select the pattern that will be recorded. If you wish to record a new pattern, select TMP (the temporary pattern). If you wish to re-record a preset pattern, etc., select that pattern.

\* If something has already been recorded in the temporary pattern, use the Pattern Initialize operation to clear any musical data from the temporary pattern (p. 38).

### 1. Press [REC].

The indicator will blink, and the Recording Standby page will appear.

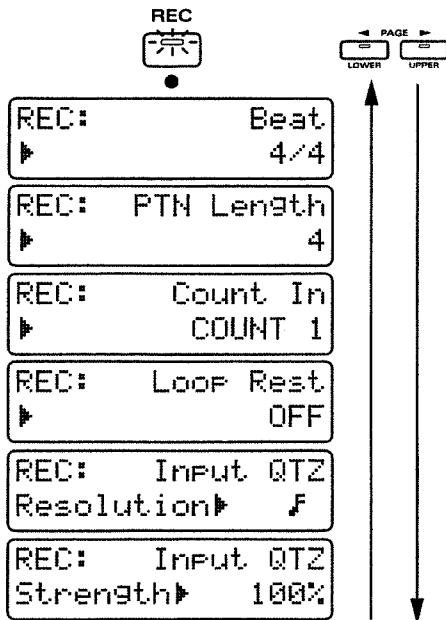

**2. Before you start recording, set the recording parameters.**

There are six recording parameters, as described below. Use PAGE [ < ] [ > ] to select a parameter, and use [ INC ] [ DEC ] or the [ VALUE ] dial to set the value.

8

**Beat**

Specifies the time signature of the pattern to be newly recorded.

Range: 2/4–7/4, 5/8–7/8, 9/8, 12/8, 9/16, 11/16, 13/16, 15/16, 17/16, 19/16

**PTN Length (Pattern Length)**

Specifies the length of the pattern to be newly recorded.

Range: 1–32 measures

**Count In**

Specifies how recording will begin.

Range:

COUNT 0 : Recording will begin the instant you press [ STOP/PLAY ].

COUNT 1, 2 : A count-in of one measure (or two measures) will sound when you press [ STOP/PLAY ], and recording will begin when the count-in ends.

WAIT NOTE: Recording will begin when you press the keyboard or the Hold pedal.

**Loop Rest**

Turn this on if you want to record smoothly across the boundary of a pattern.

Range: OFF, ON

For details on using Loop Rest...

"Recording Smoothly Across Pattern Boundaries" (p. 128)

**Input QTZ Resolution (Input Quantize Resolution)**

By using Input Quantize you can correct the timing of the notes you play as they are recorded.

Range: OFF

Set this to the shortest note value that will occur in the phrase you wish to record.

At this time, you can use the [ TIMING ] knob to specify the Strength value.

When this setting is "OFF," the notes will be recorded at the timing that you play them.

**Input QTZ Strength (Input Quantize Strength)**

Specify how closely the data will be corrected toward the timing specified by the Input Quantize Resolution.

Range: 0–100%

You can use the [ TIMING ] knob of the QUANTIZE section to set the Strength value.

\* It is not possible to modify the Beat of a pattern that has already been recorded. Nor is it possible to shorten the Pattern Length. If you wish to modify these values, use the Pattern Initialize (p. 38) operation to clear the contents of the pattern before you make settings.

**About the metronome**

During realtime recording, the metronome will sound automatically, so that you can record along with the timing of the performance.

**Setting the metronome**

You can specify how the metronome will sound, and adjust the metronome volume.

"Setting the Metronome (Metronome Mode)" (p. 167)

**3. Use PART [1]–[R] to select the part that you wish to record (the recording part).**

The indicator of the button you pressed will light.

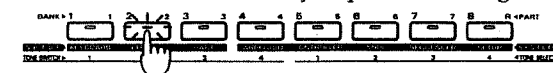

You are free to change the recording part while you record. By changing the recording part successively from drums, bass, chords and melody, etc., you can continue recording without stopping your creative-flow.

**4. When preparations are complete, you can start recording with the selected recording method. Recording can be started in one of the following two ways.**

**When the Count In setting is "COUNT 0-2"**

Press [STOP/PLAY], and recording will begin after the specified count-in.

\* The count-in will not sound when the metronome is off.

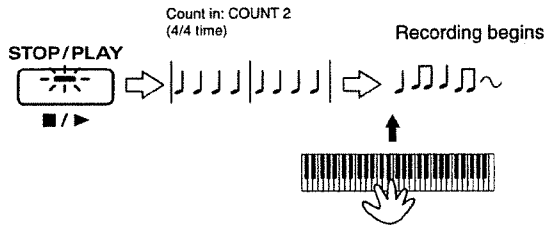

**When the Count In setting is "WAIT NOTE"**

Recording will begin the instant you play a note on the keyboard or press the Switch pedal.



When recording begins, the [REC] indicator will light. The display will show the number of measures in the entire pattern, the currently recorded measure and the beat.

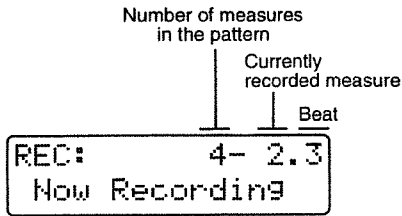

Recording can be continued repeatedly from the beginning to the end of the pattern. Once notes (note messages) have been recorded from the keyboard, they will remain without being erased, allowing you to continue "layering" your performance.

**5. When you are finished recording, press [STOP/PLAY].**

The pattern that you recorded will be held in the temporary pattern (TMP). If you are happy with the pattern that was recorded, use the Pattern Write operation to save it as a user pattern.

"Saving Patterns You've Modified (Pattern Write)" (p. 36)

**Auditioning Phrases During Recording (Rehearsal Function)**

When you use the Rehearsal function, your playing on the keyboard will not be recorded. This function allows you to make sure of the part or sound that you wish to play next, or to practice the phrase you wish to record next while you listen to the previously recorded performance.

**1. During recording, press [REC].**

The button indicator will blink, and you will enter Rehearsal mode. The following display will appear.

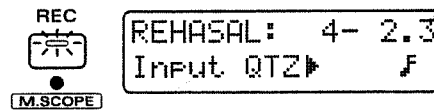

**2. Press [REC] once again to leave Rehearsal mode and return to normal Recording mode.**

In Rehearsal mode, you can use [INC] [DEC] or the [VALUE] dial to modify the Input Quantize Resolution settings.

**Recording an Arpeggio Performance**

**1. Before recording, make the desired arpeggio settings (p. 24).**

Press [ARP] to turn the arpeggiator on.

**2. Make preparations for recording (p. 125).**

**3. When you are ready, use one of the following methods to begin recording.**

**When the Count In setting is "COUNT 0-2"**

When you press [STOP/PLAY], recording will begin after the specified count-in. Press a chord at the moment that recording begins.

\* The count-in will not sound when the metronome is off.

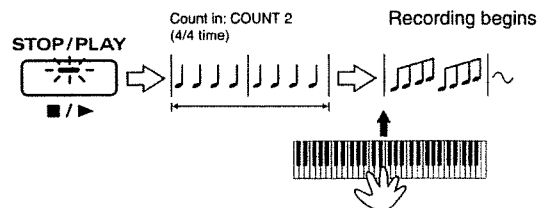

**When the Count In setting is "WAIT NOTE"**

Arpeggio performance and recording will begin at the moment that you play a chord on the keyboard.

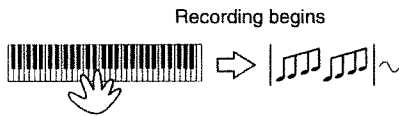

When recording begins, the [REC] indicator will light.

**4. When you are finished recording, press [STOP/PLAY].**

**Recording Knob Movements (Modify Data)**

**1. Make preparations for recording (p. 125).**

**2. When you are ready, begin recording.**

When recording begins, the [REC] indicator will light. When you operate the knobs during recording, the knob movements will be recorded from the time that they are moved.

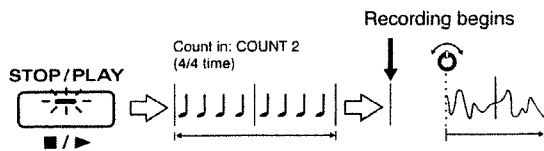

8

**3. When you are finished recording, press [STOP/PLAY].**

If the sound has been modified for the entire patch, the change will be recorded on the corresponding recording part as a Control Change. If the sound has been modified for a rhythm group, or if effect parameters have been modified, the change will be recorded on the [MUTE CTRL] part as a System Exclusive message.

- 📖 "Using the Knobs to Modify the Sound During Playback (Real-Time Modify)" (p. 38)
- 📖 "Musical Data Handled in Microscope Mode" (p. 147)

Recording will take place repeatedly from the beginning to the end of the pattern. Unlike recording of note messages, Modify data for the same knob will be rewritten (overwritten) each time the pattern repeats, but you may successively layer Modify data for different knobs.

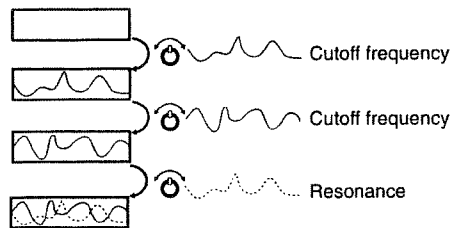

**Recording Smoothly Across Pattern Boundaries**

When you record knob movements or arpeggios, unwanted data may sometimes be recording at the boundary of the pattern if you attempted to record accurately from the beginning to the end. For example, if you wish to record across pattern boundaries, the following data might be recorded.

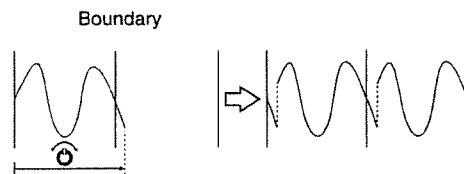

In such cases, turn the Loop Rest function on when you set the recording parameters.

When Loop Rest is on, a one-measure blank will be temporarily created between pattern boundaries. By recording across this blank measure, you can record smoothly across pattern boundaries. Only the count will sound while the blank measure elapses.

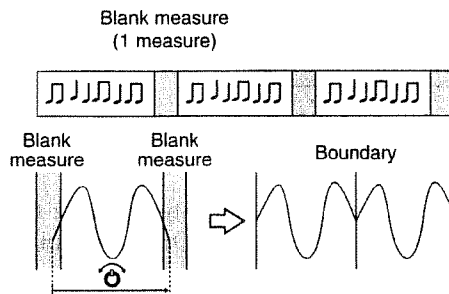

**Recording Part Mixer Operations**

**1. Make preparations for recording (p. 125).**

Any part [1]–[R] can be selected as the recording part. In actual recording, the part which corresponds to the knob that you operate will be recorded (regardless of the part you selected to be the recording part).

**2. When you are ready, begin recording.**

When recording begins, the [REC] indicator will light.

**3. Hold down [SHIFT] and press [MIXER] to enter the Part Mixer page (p. 33).**

When you use the part mixer to set a value during recording, the part mixer operation will be recorded from that point.

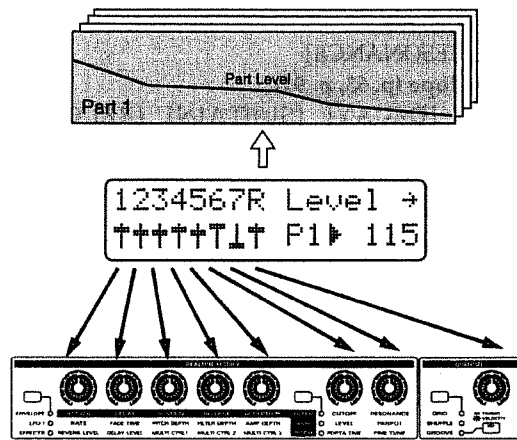

**4. When you are finished recording, press [STOP/PLAY].**

Recording will take place repeatedly from the beginning to the end of the pattern. You can change part mixer parameters as you record, for example recording Part Volume on the first pass, Part Pan on the second pass, etc.

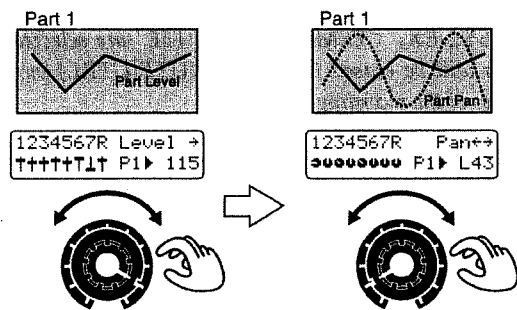

**Recording the Mute Settings**

Changes in the mute settings for parts or rhythm groups that you make during recording can be recorded in the pattern.

**1. Make preparations for recording (p. 125).**

For the recording part, specify [MUTE CTRL].

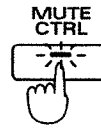

\* If the recording part is not set to [MUTE CTRL], changes in the mute settings for parts or rhythm groups will not be recorded. Also, [MUTE CTRL] can be selected only if the pattern is stopped.

**2. When you are ready, begin recording.**

**3. Press [PART MUTE] so you can make mute settings.**

If you mute a part or rhythm group during recording, the mute settings will be recorded.

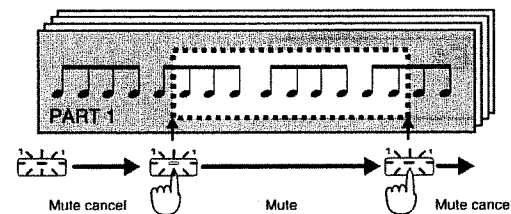

**4. When you are finished recording, press [STOP/PLAY].**

**Recording Changes in Tempo**

The standard tempo of a pattern is memorized when you perform the Pattern Write operation. However you can record tempo changes by modifying the tempo as you record.

**1. Make preparations for recording (p. 125).**

Specify [MUTE CTRL] as the recording part.

\* If the recording part is not set to [MUTE CTRL], tempo changes will not be recorded. Also, [MUTE CTRL] can be selected as the recording part only when the pattern is stopped.

**2. When you are ready, begin recording.**

When recording begins, the [REC] indicator will light. During recording, you can record tempo changes by pressing [TEMPO&MEASURE] and using [INC] [DEC] or the [VALUE] dial to modify the tempo.

\* Tempo changes made using Switch Pedal will not be recorded.

**3. When you are finished recording, press [STOP/PLAY].**

## Erasing Unwanted Data While You Record (Real-Time Erase)

Real-Time Erase is a function that lets you erase only the unwanted data that you specify a certain key or range of keys during real-time recording.

In particular, this is convenient when you are recording the rhythm part, since you can erase a specific rhythm tone.

### 1. During recording, hold down [SHIFT] and press [ERASE].

You will enter Real-Time Erase mode, and the following display will appear.

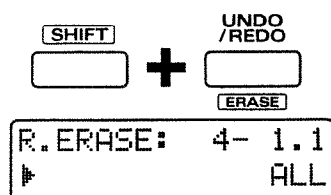

### 2. Use [INC] [DEC] or the [VALUE] dial to select the type of data that you wish to erase.

Range:

- ALL: All musical data in the recording part will be erased.
- NOTE: Notes in the specified range will be erased.
- PC: Program changes will be erased.
- CC: All control changes will be erased.
- BEND: Pitch bend will be erased.
- P-AFT: Polyphonic aftertouch will be erased.
- C-AFT: Channel aftertouch will be erased.
- SYS-EX: System exclusive messages will be erased.
- TEMPO: Tempo data will be erased.
- MUTE: Mute data will be erased.
- CC#0-CC#127: Control changes of the selected controller number will be erased.

\* If you select CC#1, you can erase Modulation lever data.

For knob settings, you can also operate the corresponding front panel knob to select that data (control change) for erasure.

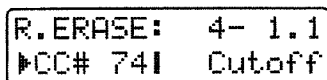
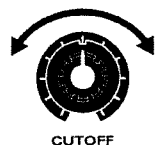

The following knobs settings can be selected.

- Pitch (p. 57, p. 87)  
[FINE TUNE]
- Pitch Envelope (p. 58, p. 87)  
[ATTACK] [DECAY] [SUSTAIN] [RELEASE]  
[DEPTH]
- Filter (p. 61, p. 90)  
[CUTOFF] [RESONANCE]
- Filter Envelope (p. 63, p. 91)  
[ATTACK] [DECAY] [SUSTAIN] [RELEASE]  
[DEPTH]
- Amplifier (p. 67, p. 94)  
[LEVEL] [PANPOT]
- Amplifier Envelope (p. 68, p. 95)  
[ATTACK] [DECAY] [SUSTAIN] [RELEASE]
- LFO1 (p. 71)  
[RATE] [FADE TIME] [PITCH DEPTH] [FILTER DEPTH] [AMP DEPTH]
- Portamento (p. 77)  
[PORTA TIME]
- Part Mixer (p. 33)  
[LEVEL] [PANPOT] [KEY SHIFT] [REVERB] [DELAY]  
[M-FX SW]

\* [LEVEL]-[M-FX SW] can be selected by operating the knobs in the Part Mixer page. At this time, this action will only select the parameter; the value of the selected parameter will not change.

### 3. Press [REC] to erase the unwanted data.

The specified data will be erased while you press the button.

\* When "SYS-EX," "TEMPO" or "MUTE" are selected, the data will be erased from the [MUTE CTRL] part regardless of the recording part.

.....  
If you select "NOTE" as the data to be erased, you can press the key to erase only the specified note messages. Notes will be erased while you press the key-board.

If you wish to erase notes of a specific range, press keys to indicate the top and bottom of the range.  
.....

### 4. When you have finished, press [EXIT] to return to normal recording mode.

## Recording Notes One at a Time (Step Recording)

Step Recording allows you to record notes one at a time. This method is a convenient way to enter notes for which accurate timing is essential, such as percussion instruments or bass.

Only note messages can be recorded using step recording.

The following two methods of step recording can be used. Use each method as appropriate.

### Step recording 1

Enter notes successively as you specify the location of each note. This method does not let you hear the performance as you record.

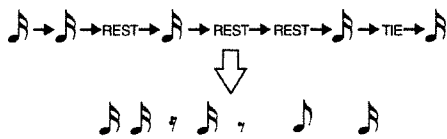

### Step recording 2

Select a note to be input, and while listening to the performance, specify locations on a grid where you wish to place that note. When used for the rhythm part, this method is suitable for drum recording, since it allows you to input notes for each rhythm tone separately. Even for parts 1-7, you can create sequenced phrases easily while listening to the performance.

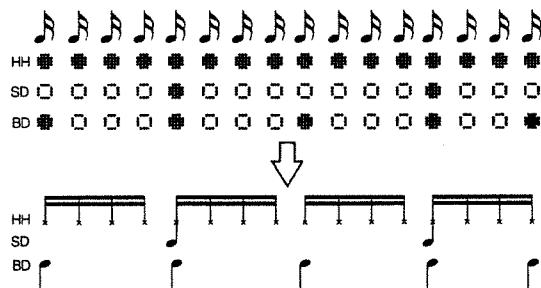

In addition to the above two methods of recording, there is a Microscope function that lets you modify the notes that you input. During recording, you can move freely between the step input page and the Microscope page.

*“Individually Editing Musical Data (Microscope Edit)”* (p. 146)

## Recording Procedure

First select the pattern that you wish to record. If you wish to record a new pattern, select TMP (temporary pattern). If you wish to re-record a preset pattern, etc., select that pattern.

\* If data has already been recorded in the temporary pattern, use the Pattern Initialize operation to clear the temporary pattern of all data.

If you wish to initialize a pattern...  
*“Copying and Initializing Settings”* (p. 37)

### 1. Hold down [SHIFT] and press [REC].

The Microscope page will appear, and the input location will appear in the display.

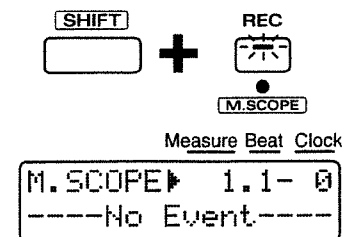

“Clock” is a unit of timing that indicates the location of a note. On the JX-305, one clock is 1/96th of a quarter note.

### 2. Press [REC].

The recording standby page (p. 125) will appear.

### 3. Before you begin recording, set the recording parameters.

\* During step recording, the Count In and Loop Rest settings are impossible.

### 4. Press a PART button to specify the part that you wish to record (the recording part).

The indicator of the button you pressed will light.



\* In Step Recording, the Key Mode will automatically be Single.

*“Playing Two Patches from the Keyboard (Key Mode)”* (p. 18)





 "Saving Patterns You've Modified (Pattern Write)" (p. 36)

### Step Time and Gate Time

In general, Step Time is the length from one note to the next, and Gate Time is the duration that the note will actually sound (i.e., the length from when the note is pressed until it is released).

For example, if you are inputting 16th notes (Step Time = 24) with Gate Time Ratio = 80%, the actual Gate Time will be input as 19.

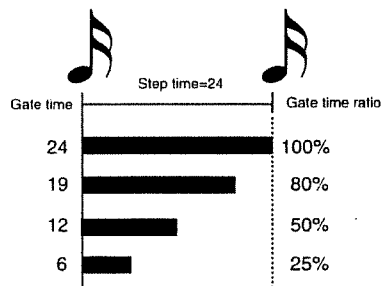

## Various Ways to Input Notes

### Inputting a chord

Hold down the notes that make up the chord, and release all notes simultaneously. The chord will not be input as long as even one note remains pressed, so you can change notes to correct the chord.

### Inputting a rest

Set the Step Time to the length of the desired rest, and press [FWD/REST].

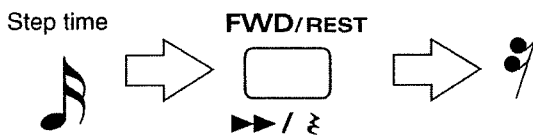

### Inputting a tie

Input the first note that you wish to tie, and press [BWD/TIE].

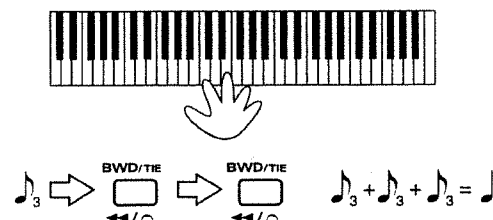

## Applying a slide effect

By setting the Gate Time Ratio to 100% or more (for example, to 105% for a 16th note phrase) and inputting steps, you can input legato phrases. An easy way to apply a slide effect is to use legato input in conjunction with a patch such as P:A18 or P:A27 which applies a slide effect for notes that are played legato.

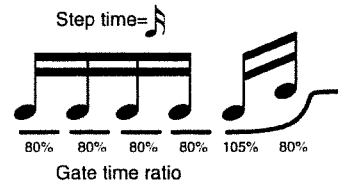

For the phrase which is applied a slide effect, you can operate the [PORTA TIME] knob during playback to control the depth of the slide effect.

For a patch that applies a slide effect for notes that are played legato, set parameters as follows (p. 78).

- Solo Switch: ON
- Solo Legato Switch: ON
- Portamento Switch: ON
- Portamento Time: 5 - 20
- Portamento Mode: LEGATO

### Slide effect

Slide refers to a performance technique used on string instruments such as guitar or bass, whereby after the string is plucked, the fingers are slid to another fret without picking a second time. This produces a smooth transition between the pitches of the two notes.

### If you make a mistake during input

Hold down [SHIFT] and press [BWD/TIE] to delete the note that was last input. At this time, the note that was deleted will be sounded as confirmation.

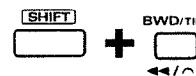

## Recording Individual Notes to Grid Locations (Step Recording 2)

### 5. Press [STOP/PLAY] to begin recording.

The [STOP/PLAY] and [REC] indicators will light. The display will indicate the current recording input area within the pattern and the playback location. In the following illustration, the current recording input area is measure 1, and the second beat of measure 1 is being played back.

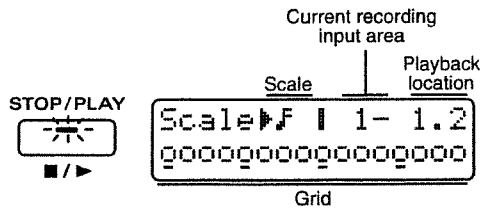

### 6. Before you input notes, select the Scale, the note (rhythm tone) to be input, the velocity, and the gate time ratio (for parts 1-7).

Use PAGE [<] [>] to select the parameter, and use [INC] [DEC] or the [VALUE] dial to set the value.

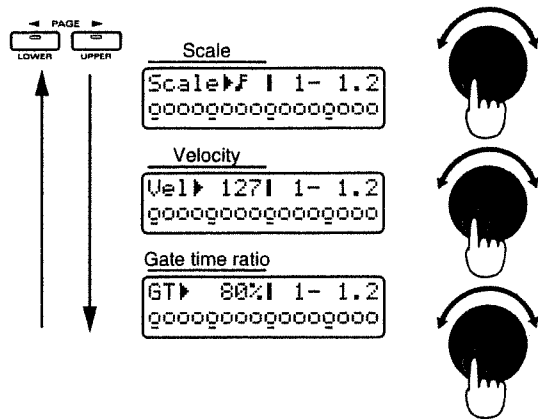

### Scale

Select the note value of the notes that you wish to input. The recording input area is determined by the scale that you select.

Range: **F F# F#3 F#3**

: Sixteenth notes can be input, with the white keys F3-G5 corresponding to one measure of recording input area.

: Thirty-second notes can be input, with the white keys F3-G5 corresponding to two beats of recording input area.

: Eighth note triplets can be input, with the white keys F3-C5 corresponding to one measure of recording input area.

: Sixteenth note triplets can be input, with the white keys F3-C5 corresponding to two beats of recording input area.

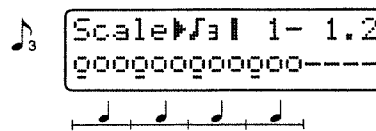
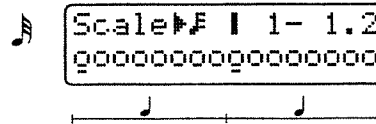
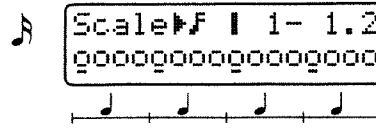

### Selecting the note for input (Rhythm Tone)

To select a note (rhythm tone), hold down [SHIFT] and press the desired note on the keyboard. While you hold down [SHIFT], the various notes (rhythm tones) will be assigned to the keyboard in the same way as during play, and the display will show the currently assigned note (rhythm tone). Play the keyboard to select the note that you wish to input. After sounding the note that you wish to input, release [SHIFT] and the last-sounded note will be selected.

To shift the key range, use OCTAVE [-] [+].

The screen display will differ according to whether the recording part is the rhythm part or another part.

Part 1-7

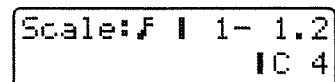

Note to be input

Rhythm part

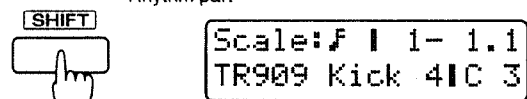

Rhythm tone name Note to be input



### Velocity

Specifies the strength of the note.

**Range:** REAL, 1-127

If you wish to input the velocity at which the note was actually played, select "REAL." If you wish to input a fixed velocity value, specify the desired value of 1-127.

\* During recording, the setting of "Changing the Loudness of Notes Played on the Keyboard (Keyboard Velocity)" (p. 163) is ignored.

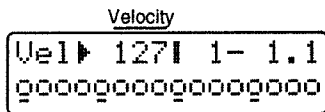

### Gate Time Ratio

Specifies the time from when the note is pressed until it is released (the Gate Time), as a ratio relative to the Step Time. Set a low value if you want notes to be cut off sharply, or a higher value if you want notes to be sustained.

**Range:** 1-200%

Normally you will select a value of approximately 80%.

To enter staccato notes select 50%, and to enter tenuto notes select 100%.

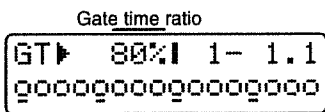

\* Since the rhythm part is always input with a fixed gate time, it is not necessary to set the gate time ratio value.

### 7. Press the key that correspond to the locations where you wish to enter a note message. You may start at any location.

The display will indicate "●" at the locations that have been input.

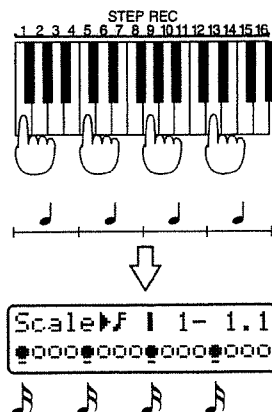

To cancel your input, press the key at the location that you wish to cancel. The "●" will disappear from the display.

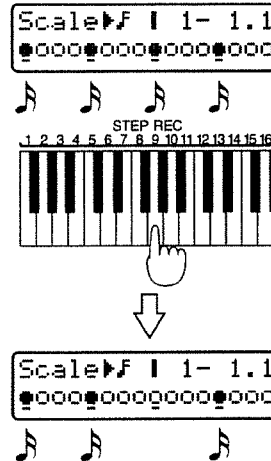

If the pattern length is 1 measure, the beat is 4/4 and the scale is 16th notes, you can input as follows.

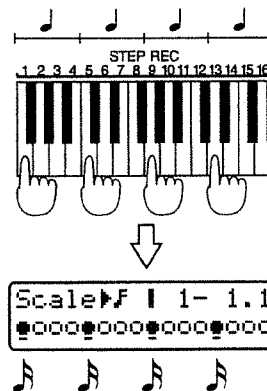

Notes that are input will be layered (mixed) onto previous notes.

During recording, the pattern will be played back repeatedly, and the newly recorded note messages will be added to the playback each time.

### 8. While you listen to the playback repeat, repeat steps 6 and 7 to input the notes.

Settings for scale, the note (rhythm tone) to be input, velocity and gate time ratio will be held over from the settings of the previous note. If you wish to use the same settings for the next note, you need not change the settings.

\* If you change the note (rhythm tone) that you are inputting, the locations of previously-input notes (rhythm tones) of other pitches will not be displayed.

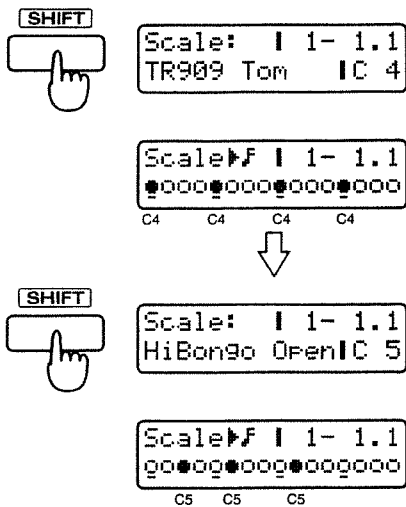

To move the recording input area, use [FWD] and [BWD].

Pressing [FWD] will advance the recording input area by 1 measure (or 2 beats).

Pressing [BWD] will return the recording input area by 1 measure (or 2 beats).

If the pattern length is set to "2 measures," the beat is "4/4" and the scale "32nd notes," the recording input area will move as follows. When the recording input area is on beat 3 and 4, "B" will be added at the right of the measure indication in the display. When the recording input area is on beat 1 and 2, "A" will be added at the right of the measure indication in the display.

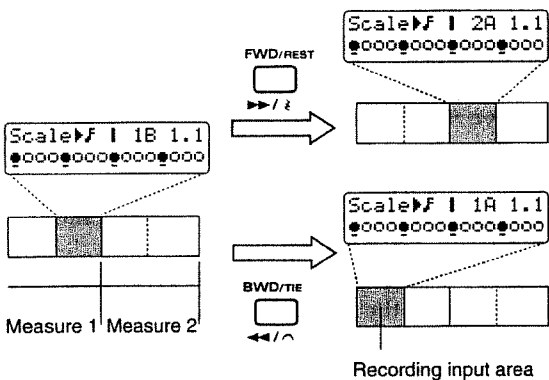

### 9. When you finish inputting notes, press [STOP/PLAY].

The pattern you record will be in the temporary pattern (TMP). If you are happy with the pattern you recorded, use the Pattern Write operation to save the pattern as a user pattern.

"Saving Patterns You've Modified (Pattern Write)" (p. 36)

## Inputting Complex Rhythms

By changing the scale while you record, you can input rhythms that use complex note values.

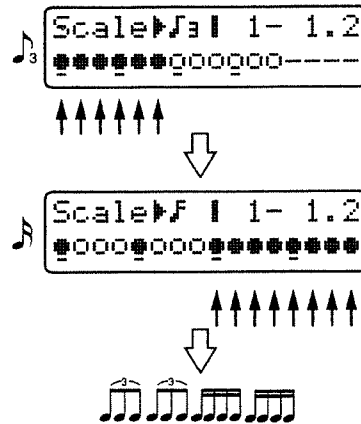

\* Ties cannot be input.

\* If you record the rhythm part in real time, and then use Step Recording 2, the previously input notes can be viewed on the display. However, you will see only those notes that coincide with grid locations of the currently selected scale.

Also, if you change the scale during recording, notes that had until then been visible may no longer be shown on the display.

For example, if you input 32nd notes and then change the scale to 16th notes, any notes that had been input at keyboard pad locations 2, 4, 6, 8, 10, 12, 14 or 16 will not be displayed.

### To change a note that you input

Hold down the key for the note that you wish to change, and press [SHIFT]. The currently input note will be displayed. Now you can use [INC] [DEC] or the [VALUE] dial to change the note that was input.

### Modifying the velocity or gate time ratio

In the Velocity or Gate Time Ratio setting pages, press the key for the location that you wish to modify the value, and the data of the currently input note will be displayed. Now you can use [INC] [DEC] or the [VALUE] dial to modify the value. Checking the Remaining Amount of Memory (Memory Information) Here's how you can check the amount of memory remaining in the pattern/song temporary area, in user memory, and in card memory.

## Checking the Remaining Amount of Memory (Memory Information)

Here's how you can check the amount of memory remaining in the pattern/song temporary area, in user memory, and in card memory.

1. Press [UTILITY].
2. Press PAGE [<] [>] several times to select "MEMORY INFO," and press [ENTER].  
The Memory Information page will appear.
3. Use PAGE [<] [>] to select the memory that you wish to check, and press [ENTER].

```
MEMORY INFO:Temp
          100% Free
```

```
MEMORY INFO:User
          702KB Free
```

```
MEMORY INFO:Card
          1664KB Free
```

4. To exit this display, press [EXIT].

### Temp (Temporary)

The remaining amount of musical data that can be recorded in the pattern currently loaded into the temporary area is displayed as a percentage. If the remaining amount reaches "0%," no further recording or pattern editing is possible.

### User (User Memory)

The remaining amount of internal user memory is displayed in KB (kilobytes). The maximum capacity of the user memory is approximately 75,000 notes (the capacity when all songs are EMPTY SONG).

### Card (Card Memory)

The remaining amount of memory in the card is displayed in KB (kilobytes).

\* If the remaining amount is "0 KB" or if the size of the pattern that you wish to save (the amount of data in the pattern loaded into the temporary area) is larger than the remaining capacity of user memory or card memory, it will not be possible to save that pattern. Also, if the remaining capacity of card memory is 1030 KB or less, it will not be possible to create a backup file.

 "Saving All Internal Settings to a Card (User Backup)" (p. 160)

### About KB (kilobytes)

KB is a unit for measuring data size.  
1000 KB is also expressed as 1 MB (megabyte).



### Maximum number of recorded notes

A maximum of approximately 8,000 notes of musical data can be recorded in the temporary pattern. This is the maximum number of notes that can be recorded in a single pattern. The JX-305 is not able to record or edit a pattern that is larger than this.

### About the number of patterns that can be saved

A maximum of 200 patterns that you create can be saved in user memory, and a maximum of 200 can be saved in card memory. This number will depend on the amount of data in the patterns that you create. For example, if you create many patterns containing large amounts of data, so there is no remaining capacity in user memory or card memory, no further patterns can be saved. Also, if the size of the pattern (the amount of data occupied by the pattern in the temporary area) is greater than the remaining amount of user memory or card memory, that pattern cannot be saved.

When you begin to approach the limits of user memory or card memory, you can increase the amount of space available by initializing unwanted patterns, etc.

 If you wish to initialize a pattern...  
 "Copying and Initializing Settings" (p. 37)

# Chapter 9. Editing Patterns

## Editing the Musical Data of a Specified Part (Pattern Edit)

The process of editing the musical data in a pattern is called Pattern Editing. You can modify the content of the musical data in a pattern, or combine various patterns to create an entirely different pattern.

\* *The edited pattern is kept in the temporary pattern (TMP). If you wish to keep the pattern that you created, you must use the Pattern Write operation.*

 **“Saving Patterns You’ve Modified (Pattern Write)”** (p. 36)

### Cautions for pattern editing

Pattern editing can be performed in Pattern mode (when the [MODE] indicator is dark) when the display shows the pattern select page (when the [PTN/SONG] indicator is lit). It is not possible to enter the various editing pages while a pattern is playing back.

### Setting parameters

To use or modify the parameters, use [INC] [DEC] or the [VALUE] dial.

### Selecting the part

To select the part you wish to edit, press the appropriate PART [1]–[R], [MUTE CTRL] button. The part whose indicator is lit will be selected for editing.

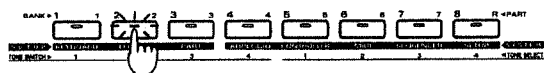

If during editing you wish to return to the previous parameter setting page, press PAGE [←].

If you wish to cancel your edits, press [EXIT].

### Undo/Redo

If you are not happy with the edited pattern, you can press the [UNDO/REDO] button in the pattern select page to return the musical data to the un-edited state.

\* *In some cases, such as when a very large amount of data was processed, the Undo operation may not be available.*

 **“Canceling the Previous Operation (Undo/Redo)”** (p. 17)

## Copying a Portion of a Pattern (Copy)

A specific portion of a pattern can be copied to another pattern. This is convenient when you wish to combine portions of various patterns to create a new pattern.

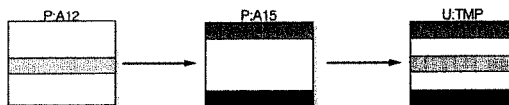

\* *The pattern that was copied will be written into the temporary pattern (TMP).*

\* *If the copy source pattern has more measures than the copy destination pattern, the number of measures in the copy destination pattern may increase.*

\* *It is not possible to copy between patterns that have different time signatures.*

\* *Setup parameters will not be copied when you execute the Copy operation. If you wish to move (copy) a specific pattern (without modifying it) to a user pattern, use the Pattern Write operation to move the data. Also, if you wish to copy a certain pattern to TMP without modification, press [REC] twice.*

### 1. Select the copy source pattern.

### 2. Press [EDIT].

The indicator will light, and the edit page will appear in the display.

### 3. Press NUMBER [1] (COPY).

The copy setting page will appear.

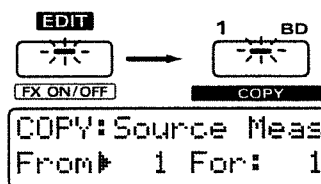

### 4. Select the part that you wish to copy.

\* *You can select more than one part simultaneously.*

### 5. Specify the measure at which copying will begin.

Range: 1–32

### 6. Press [ENTER].

The cursor will move to the right.

### 7. Specify the measure length (number of measures) to be copied.

Range: 1–31, ALL

\* *If the setting is “ALL,” the measure at which copying began and all subsequent measures will be copied.*

For example, if you wish to copy from measure 4 to the end of measure 6, make settings as follows.

```
COPY: Source Meas
From: 4 For 3
```

### 8. Press [ENTER].

The display will indicate the group, bank and number of the copy destination pattern.

### 9. Select the copy destination pattern.

Range: TMP, P:A11-P:L88, U:A11-U:D18, C:A11-C:D18

\* You can also change the group by pressing [PRESET/USER/CARD], [<PREV] [NEXT>] in the GROUP section.

```
COPY: Dest PTN
U:A11
```

### 10. Select the copy destination part.

\* If more than one part was selected as the copy source, the data will automatically be copied to the same parts as the copy source. If you are unable to select the copy destination part, make sure that you have not selected two or more copy source parts.

\* If [MUTE CTRL] was selected as the copy source part, only [MUTE CTRL] can be selected as the copy destination part.

### 11. Press [ENTER].

The display will indicate the copy start measure of the copy destination part.

### 12. Specify the copy start measure of the copy destination part.

Range: 1-31, END

\* If the setting is "END," the data will be copied onto the end of the copy destination part.

\* It is not possible to specify a measure number that would cause the length of the pattern to exceed 32 measures.

```
COPY: Dest Meas
END
```

### 13. Press [ENTER].

The display will indicate the type of musical data to be copied.

### 14. Select the type of musical data that you wish to copy.

```
COPY: Status
ALL
```

#### Range:

ALL: All musical data  
NOTE: Note  
PC: Program change  
CC: Control change  
BEND: Pitch bend  
P-AFT: Polyphonic aftertouch  
C-AFT: Channel aftertouch  
SYS-EX: System exclusive  
TEMPO: Tempo  
MUTE: Mute

### 15. Press [ENTER].

The display will show the Copy Mode setting.

### 16. Select the copy mode.

```
COPY: Mode
REPLACE
```

#### Range: REPLACE, MIX

REPLACE: Musical data in the copy destination will be erased (i.e., overwritten) when the copy takes place.

MIX: Musical data in the copy destination will be combined with the newly copied data.

### 17. Press [ENTER].

The display will let you specify the number of times that the data will be copied.

### 18. Specify the number of times that the data will be copied.

```
COPY: Times
1
```

#### Range: 1-32

\* It is not possible to specify a number of measures that would cause the length of the pattern to exceed 32 measures when the Copy was executed.

### 19. Press [ENTER].

The confirmation page will appear.

```
COPY:
Are You Sure ?
```

### 20. Press [ENTER] once again.

The copy operation will be carried out, and the normal display will reappear.

## Deleting Unwanted Measures (Delete Measure)

This operation deletes unwanted measures from a pattern, and moves any subsequent measures toward the beginning to close the gap. If there is data later than the area that was deleted, the musical data of that part will become shorter. If all parts were specified for the delete operation, the pattern itself will become shorter.

\* If you delete all measures of all parts, the pattern itself will be deleted, and will be a pattern containing no musical data (an empty pattern).

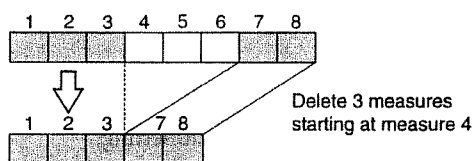

**1. Select the pattern from which you wish to delete data.**

**2. Press [EDIT].**

The indicator will light, and the edit page will appear in the display.

**3. Press NUMBER [2] (DELETE).**

The Delete Measure setting page will appear.

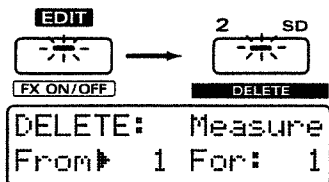

**4. Select the part from which you wish to delete data.**

\* You can select more than one part.

**5. Specify the measure at which deletion will begin.**

Range: 1-32

**6. Press [ENTER].**

The cursor will move to the right.

**7. Specify the measure length (number of measures) that will be deleted.**

Range: 1-31, ALL

\* If the setting is "ALL," the measure at which deletion began and all subsequent measures will be affected by the operation.

For example, if you wish to delete from measure 4 to the end of measure 6, make settings as follows.

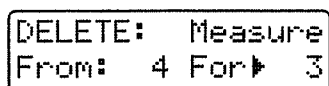

**8. Press [ENTER].**

The confirmation screen will appear in the display.

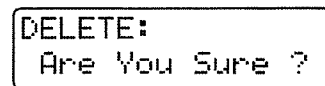

**9. Press [ENTER] once again.**

The Delete Measure operation will be carried out, and the normal display will reappear.

## Inserting Blank Measures (Insert Measure)

This operation inserts blank measures into the specified location of a pattern. If you wish to add more musical material in the middle of a pattern, use this operation to insert blank measures before recording the additional material.

The inserted measures will have the same time signature as the pattern.

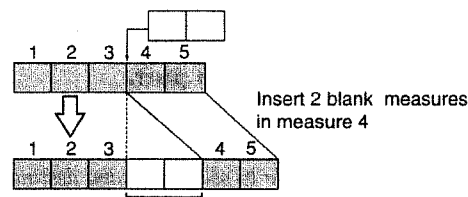

\* It is not possible to make settings that would make the pattern length exceed 32 measures.

**1. Select the pattern into which measures will be inserted.**

**2. Press [EDIT].**

The indicator will light, and the edit page will appear in the display.

**3. Press NUMBER [3] (INSERT).**

The display will show the Insert Measure setting page.

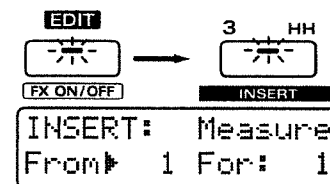

**4. Select the part into which you wish to insert measures.**

\* You may select more than one part.

**5. Specify the measure at which the blank measures will be inserted.**

Range: 1-31, END



\* If you specify "END," the blank measures will be added to the end of the musical data.

**6. Press [ENTER].**

The cursor will move to the right.

**7. Specify the measure length (number of measures) that will be inserted.**

Range: 0-32

For example, if you wish to insert two blank measures between measures 3 and 4, make the following settings.

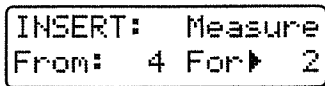

**8. Press [ENTER].**

The confirmation screen will appear in the display.

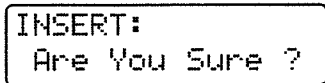

**9. Press [ENTER] once again.**

The Insert Measure operation will be carried out, and the normal display will reappear.

**Erasing Unwanted Data (Erase)**

This operation erases part of the pattern. This operation is useful when you wish to erase data that was input by mistake.

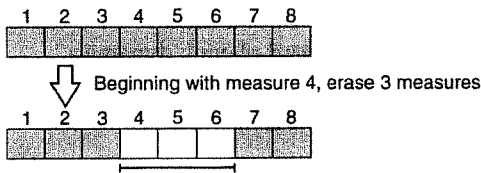

\* Erasing data will not affect the length of the pattern.

**1. Select the pattern from which you wish to erase data.**

**2. Press [EDIT].**

The indicator will light, and the edit page will appear in the display.

**3. Press NUMBER [4] (ERASE).**

The Erase page will appear in the display.

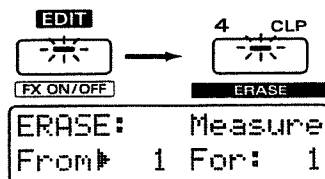

**4. Select the part from which you wish to erase data.**

\* You can select more than one part.

**5. Specify the measure at which erasure will begin.**

Range: 1-32

**6. Press [ENTER].**

The cursor will move to the right.

**7. Specify the measure length (number of measures) from which data will be erased.**

Range: 1-31, ALL

\* If this is set to "ALL," the specified starting measure and all subsequent measures will be affected by the operation.

For example, if you wish to erase from measure 4 to the end of measure 6, make settings as follows.

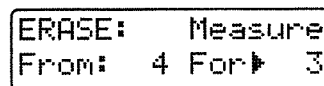

**8. Press [ENTER].**

The display will indicate the type of musical data that will be erased.

**9. Select the type of musical data that you wish to erase.**



Range:

- ALL: All musical data
- NOTE: Note
- PC: Program change
- CC: Control change
- BEND: Pitch bend
- P-AFT: Polyphonic aftertouch
- C-AFT: Channel aftertouch
- SYS-EX: System exclusive
- TEMPO: Tempo
- MUTE: Mute

If NOTE is selected as the type of musical data, and you wish to erase only a specific range of notes, you can press the keyboard to specify the range. For example, if you specify the range as follows, notes from D4 to G4 will be erased. If you do not specify the note range, all notes will be erased.

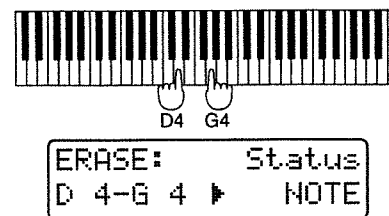

**10. Press [ENTER].**

The confirmation screen will appear in the display.

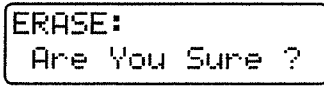

**11. Press [ENTER] once again.**

The Erase operation will be carried out, and the normal display will reappear.

**Transposing the Pitch (Transpose)**

This operation shifts the note numbers (pitch) of the data recorded in a pattern. You can specify a transposition of up to +/-2 octaves.

\* It is not possible to specify the range of measures that will be transposed.

Transpose 4 semitones upward (+4)

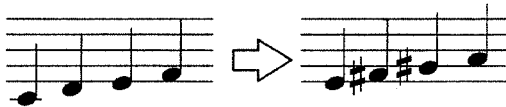

**1. Select the pattern that you wish to transpose.**

**2. Press [EDIT].**

The indicator will light, and the edit page will appear in the display.

**3. Press NUMBER [5] (TRANSCOPE).**

The display will show the Transpose setting page.

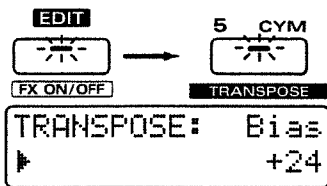

**4. Select the part that you wish to transpose.**

\* You can select more than one part.

**5. Specify the amount of transposition, in semitone steps.**

Range: -24--+24

\* If the setting value is "0," no transposition will occur.

\* If you apply Transpose to the Rhythm part, the sound will be exchanged for different rhythm tones. In some cases, notes may fail to sound.

If you wish to transpose only a specific range of notes, press the keyboard to specify the desired range. If you do not specify the note range, all notes will be transposed.

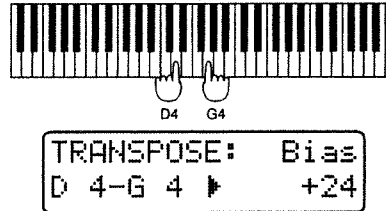

**6. Press [ENTER].**

The confirmation screen will appear in the display.

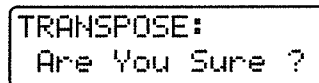

**7. Press [ENTER] once again.**

The Transpose operation will be carried out, and the normal display will reappear.

**Modifying the Strength of Notes (Change Velocity)**

This operation modifies the velocity (playing strength) of the notes recorded in the pattern. Increasing the velocity values will cause the notes to be played more strongly. This operation can be used to increase or decrease the overall keyboard playing dynamics.

\* If this operation would result in a velocity greater than 127 (or less than 1), the result will be limited to 127 (or 1).

\* It is not possible to specify the range of measures in which velocity will be modified.

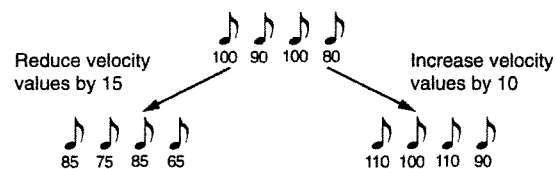

**1. Select the pattern in which you wish to modify the velocity.**

**2. Press [EDIT].**

The indicator will light, and the edit page will appear in the display.

**3. Press NUMBER [6] (CHG EVENT) to select the "CHG VELO" setting page.**

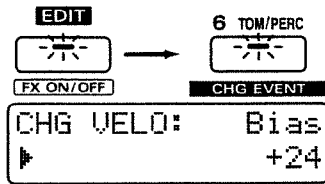

**4. Select the part whose velocity you wish to change.**

\* You may select more than one part.

**5. Specify the amount that will be added to (or subtracted from) the velocity.**

Range: -99+99

If this value is "0," the velocity will not be modified.

If you wish to modify the velocity of a specific range of notes, use the keyboard to specify the range. If you do not specify the note range, the velocity of all notes will be modified.

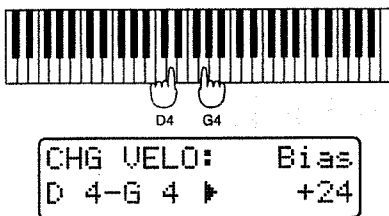

**6. Press [ENTER].**

The confirmation screen will appear in the display.

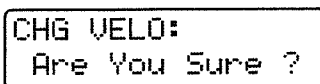

**7. Press [ENTER] once again.**

The Change Velocity operation will be carried out, and the normal display will reappear.

**Modifying the Note Length (Change Gate Time)**

This operation modifies the gate time (duration) of the notes recorded in the pattern. This can be used to make the overall performance more staccato or tenuto.

\* If this operation would result in a gate time longer than 21504 (or shorter than 1), the result will be limited to 21504 (or 1).

\* It is not possible to specify the range of measures that will be modified by this operation.

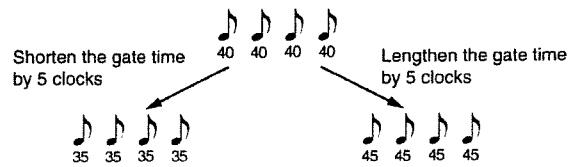

**1. Select the pattern in which you wish to modify the gate time.**

**2. Press [EDIT].**

The indicator will light, and the edit page will appear in the display.

**3. Press NUMBER [6] (CHG EVENT), and then press PAGE [>] several times to select the "CHG GATE" setting page.**

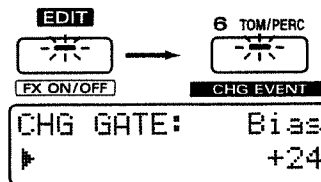

**4. Select the part in which you wish to modify the gate time.**

\* You may select more than one part.

**5. Specify the amount that you wish to add to (or subtract from) the gate time.**

Range: -99+99

With a setting of "0," the gate time will not be modified.

If you wish to modify the gate time of a specific range of notes, you can use the keyboard to specify the range. If you do not specify the range of notes, the gate time of all notes will be modified.

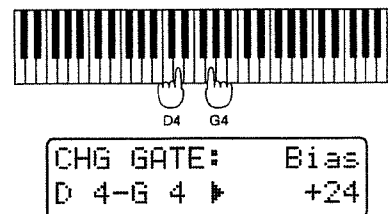

**6. Press [ENTER].**

The confirmation screen will appear in the display.

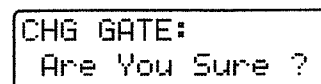

**7. Press [ENTER] once again.**

The Change Gate Time operation will be carried out, and the normal display will reappear.

### Shifting the Timing Slightly (Shift Clock)

Using this operation, the timing of the musical data in a pattern can be shifted forward or backward in time, in units of a single clock. Use this when you wish to slightly shift the overall timing.

\* Data which would otherwise be moved earlier than the beginning of the music data will be placed at the beginning. In the case of data which would be moved later than the end of the music data, the necessary number of measures will be added. However if the data would otherwise be moved beyond the end of the pattern, it will be placed at the end.

\* It is not possible to specify the range of measures that will have their timing shifted.

\* 24 clocks correspond to the length of one 16th note.

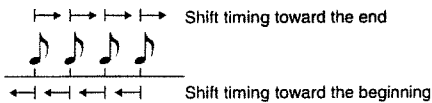

1. Select the pattern whose timing you wish to shift.

2. Press [EDIT].

The indicator will light, and the edit page will appear in the display.

3. Press NUMBER [6] (CHG EVENT), and then press PAGE [>] several times to select the "SHIFT CLK" setting page.

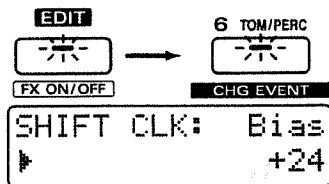

4. Select the part whose timing you wish to shift.

\* You may select more than one part.

5. Specify the number of clocks that you wish to shift the data.

Range: -99~+99

Specify a negative (-) setting if you wish to shift the data toward the beginning. Specify a positive (+) setting if you wish to shift the data toward the end. If this is set to "0" the data will not be shifted.

6. Press [ENTER].

The display will indicate the type of musical data that will be shifted.

7. Select the type of musical data that you wish to shift.

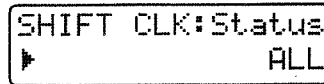

Range:

- ALL: All musical data
- NOTE: Note
- PC: Program change
- CC: Control change
- BEND: Pitch bend
- P-AFT: Polyphonic aftertouch
- C-AFT: Channel aftertouch
- SYS-EX: System exclusive
- TEMPO: Tempo
- MUTE: Mute

NOTE is selected as the type of musical data, and if you wish to shift only a specific range of notes, use the keyboard to specify the desired range. If you do not specify a range of notes, all notes will be shifted.

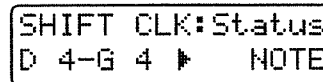
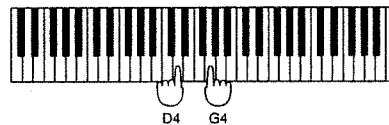

8. Press [ENTER].

The confirmation screen will appear in the display.

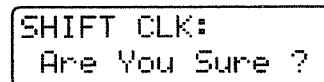

9. Press [ENTER] once again.

The Shift Clock operation will be carried out, and the normal display will reappear.

### Thinning Out Unneeded Data (Data Thin)

Since messages such as pitch bend or control change use continuously changing values, they can occupy an unexpectedly large amount of memory. The Data Thin operation lets you thin out such data in a way that will not affect the audible result, yet will reduce the amount of data.

\* It is not possible to specify the range of measures affected by this operation.

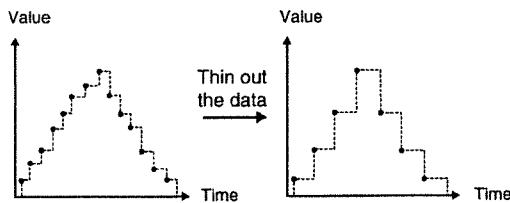

1. Select the pattern in which you wish to thin data.
2. Press [EDIT].  
The indicator will light, and the edit page will appear in the display.
3. Press NUMBER [6] (CHG EVENT), and then press PAGE [>] several times to select the "DATA THIN" setting page.

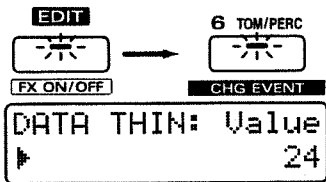

4. Select the part whose data will be thinned.  
\* You may select more than one part.
5. Specify the amount of data to be thinned.  
Range: 0-99  
Higher settings will cause more data to be thinned. If the setting is "0," the data will not be thinned.

6. Press [ENTER].  
The display will indicate the type of musical data that is to be thinned.
7. Select the type of musical data that you wish to thin.

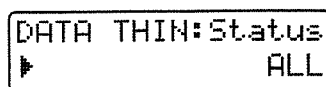

- Range:
- ALL: All of the following musical data
  - CC: Control change
  - BEND: Pitch bend
  - P-AFT: Polyphonic aftertouch
  - C-AFT: Channel aftertouch

8. Press [ENTER].  
The confirmation screen will appear in the display.

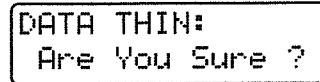

9. Press [ENTER] once again.  
The Data Thin operation will be carried out, and the normal display will reappear.

### Converting the Note Timing of a Pattern (Reclock)

You can double or halve the timing of the musical data recorded in a pattern. For example, you can convert a four-measure pattern of tempo=120 to two measures so it will play back identically at a tempo of 60. When you wish to connect patterns of radically differing tempo, it is a good idea to use the Reclock operation to match the timing values of the two patterns.

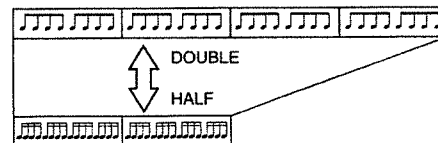

\* Executing the Reclock operation will not affect the original tempo of the pattern.

1. Select the pattern whose timing values you wish to convert.
2. Press [EDIT].  
The indicator will light, and the edit page will appear in the display.
3. Press NUMBER [6] (CHG EVENT), and then press PAGE [>] several times to select the "RELOCK" setting page.

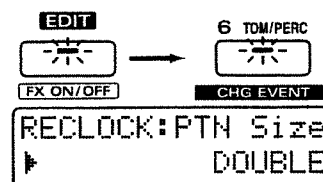

**4. Select the part whose timing values you wish to convert.**

\* You may select more than one part.

**5. Specify how the timing values will be converted.**

Range:

HALF: Timing values will be halved

DOUBLE: Timing values will be doubled

\* It will not be possible to make parameter settings for which the Reclock operation would make the length of the pattern exceed 32 measures or be shorter than 1 measure.

**6. Press [ENTER].**

The confirmation screen will appear in the display.

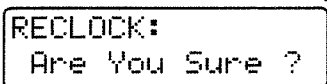

**7. Press [ENTER] once again.**

The Reclock operation will be carried out, and the normal display will reappear.

## Using Play Quantize Settings to Modify a Pattern (Edit Quantize)

You can modify the musical data of a pattern according to the Play Quantize settings.

Normally, Play Quantize does not affect the contents of the musical data, but only modifies the timing at which the pattern is played back. By using Edit Quantize, you can modify the musical data itself, so the data will play back with the same groove even if you do not apply Play Quantize.

\* It is not possible to specify the area of measures in which the musical data will be modified.

**1. Select the pattern whose data you wish to modify.**

**2. Play back the pattern, apply Play Quantize, and adjust the groove as desired (p. 40).**

\* If you attempt to execute Edit Quantize without applying Play Quantize, the following message will appear. You must apply Play Quantize before executing Edit Quantize.

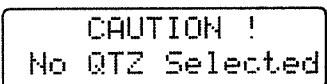

**3. Press [STOP/PLAY] to stop the pattern.**

**4. Press [EDIT].**

The indicator will light, and the edit page will appear in the display.

**5. Press NUMBER [7] (QUANTIZE), and then press PAGE [>] several times to select the "EDIT QTZ" setting page.**

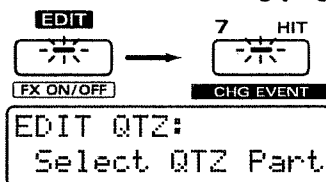

**6. Select the part(s) for which you wish to carry out Edit Quantize.**

\* You may select more than one part.

\* The indicators will already be lit for the parts to which Play Quantize had been applied (the parts selected by [QTZ SELECT]). If you wish to apply the operation to these same parts, you may simply continue to the next step.

**7. Press [ENTER].**

The confirmation screen will appear in the display.

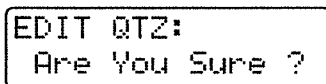

**8. Press [ENTER] once again.**

The Edit Quantize operation will be carried out, and the normal display will reappear. When the operation is completed, Play Quantize will automatically be turned off.

## Individually Editing Musical Data (Microscope Edit)

By using Microscope Edit, individual data events can be moved to a different location or edited in detail, and you can also delete or insert individual notes, etc.

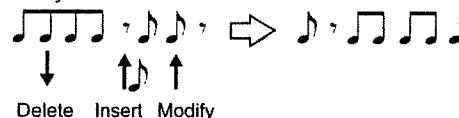

**1. Hold down [SHIFT] and press [M.SCOPE].**

The indicator will light.

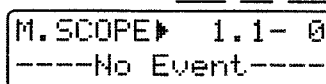
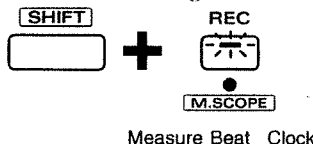

\* When you enter Microscope mode, the Key Mode will be set to Single.

During step recording, you can press [REC] to access the Microscope page, and the display will indicate the current input location (measure, beat, clock). This input location is referred to as the "position."

### View the Musical Data That You Input

Rotate the [VALUE] dial to move the position to a location where musical data (notes and controller data, etc.) was input. The display will show the position and the type of musical data.

Rotating the [VALUE] clockwise will successively display the musical data that is located in the direction of the pattern playback.

Rotating the [VALUE] dial counterclockwise will successively display the musical data that is located in the opposite direction of the pattern playback.

You can also use [FWD] and [BWD] to step through the musical data instead of using the [VALUE] dial.

By holding down [SHIFT] and rotating the [VALUE] dial, you can move the position in units of one clock.

\* If two or more MIDI messages exist at the same position, an "\*" will appear at the right of the "▶" of the display.

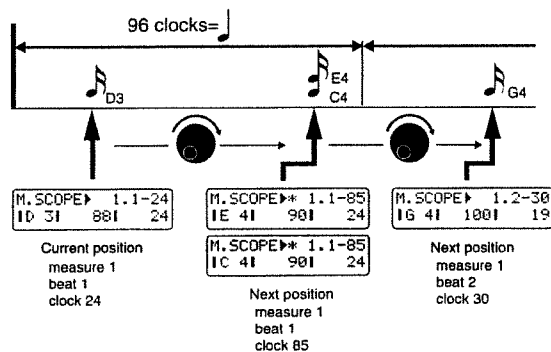

At this time you can press PART [1]-[R] to change the part. This lets you view the recorded data of other parts. If you select the rhythm part, you can also select rhythm tones.

To return to recording mode, press [REC].

☞ "Recording Notes One at a Time (Step Recording)" (p. 131)

### 2. To exit the Microscope page, press [STOP/PLAY].

If you wish to save the modified pattern, use the Pattern Write operation.

☞ "Saving Patterns You've Modified (Pattern Write)" (p. 36)

## Musical Data Handled in Microscope Mode

The Microscope lets you view and edit the following 9 types of musical data (MIDI message).

### Note

Data that plays a sound.

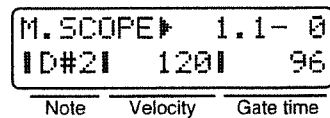

Range:

Note: C-1-G9

Velocity: 1-127

Gate time: 1-21504

### Control Change

These MIDI messages correspond to various controller numbers, and are used to apply effects such as modulation or portamento. These are used mainly to operate knobs.

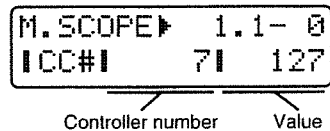

Range:

Controller Number: 0-127

Value: 0-127

☞ If you would like to know more about the function of each controller number...

☞ "Transmit/Receive Setting List" (p. 235)

### Program Change

These MIDI messages are used to select sounds (patches).

The patch corresponding to the program number will be selected.

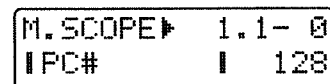

Range:

PC#: 1-128 (Program Number)

### Pitch Bend

These MIDI messages change the pitch.

```
M.SCOPE▶ 1.1- 0
|Pch Bend | 0
```

Range: -8192+8191

### Poly A-Touch (Polyphonic Aftertouch)

These MIDI messages apply aftertouch to individual notes.

```
M.SCOPE▶ 1.1- 0
|PA | C#2| 127
      Note      Value
```

Range:

Note: C-1-G9

Value: 0-127

The display will indicate the note name.

### Ch A-Touch (Channel Aftertouch)

These MIDI messages apply aftertouch to an entire MIDI channel.

```
M.SCOPE▶ 1.1- 0
|Ch After | 127
```

Range: 0-127

\* The JX-305's keyboard transmits Channel Aftertouch messages.

### Tempo Change

This data controls the tempo. This is used only in the MUTE CTRL part.

```
M.SCOPE▶ 1.1- 0
|Tempo | 120.0
```

Range: 20.0-240.0

### Mute

This is Mute data for each part and rhythm group. It is used only in the MUTE CTRL part.

```
M.SCOPE▶ 1.1- 0
|Mute|OTHERS|OFF
      Part, Group
```

Range:

Part Group: P1-PR, BD, SD, HH, CLP, CYM, TOM/PC, HIT, OTHERS

Value: OFF, ON

### Sys Exclusive (System Exclusive)

These are MIDI messages unique to the JX-305. If the entire message cannot be shown on one line, a "→" will appear at the right edge of the display.

You can press PAGE [<] [>] to scroll the display screen. It is used only in the MUTE CTRL part.

```
M.SCOPE▶ 1.1- 0
|ExIF0 41 10 00→
```

### No Event

If there is no MIDI message at the current position, the following display will appear.

```
M.SCOPE▶ 1.1- 0
----No Event----
```

## Modifying the Value of Musical Data (Change Event)

1. In the Microscope page, rotate the [VALUE] dial to select the musical data that you wish to change.

2. Press PAGE [>].

The cursor will appear at the location of the parameter which can be modified.

```

< PAGE >
LOWER UPPER
M.SCOPE| 1.1- 0
|PC# | 128

```

3. Use [INC] [DEC] or the [VALUE] dial to modify the value.

For messages that have more than one parameter value that can be modified (such as Notes, Control Changes, Polyphonic Aftertouch, etc.), use [ENTER] or PAGE [<] [>] to move the cursor.

```

M.SCOPE| 1.1- 0
▶D#2| 120| 96
      PAGE
      UPPER
M.SCOPE| 1.1- 0
|D#2▶ 120| 96

```

4. Press [ENTER] or PAGE [<] [>] to return the cursor to the position.



**Using the keyboard or knobs to directly modify the musical data**

To change a note number, press a note. The corresponding note number will be input.

To input a control change, rotate a patch parameter knob. The controller number and value of that knob will be input.

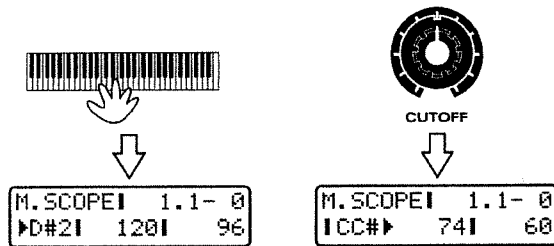

If you rotate a knob that is different than the controller number which is displayed, the controller number which had been input at that location will be replaced.

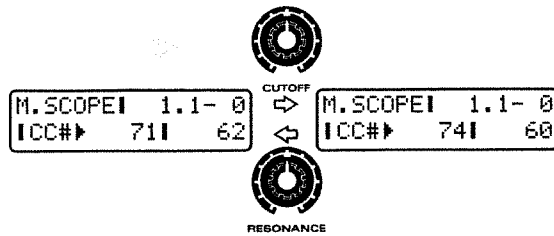

**Modifying system exclusive data**

System exclusive messages begin with F0, and end with F7. Data values are shown in hexadecimal notation (00-7F).

**1. In the Microscope page, rotate the [VALUE] dial to select the system exclusive message that you wish to modify.**

**2. Press PAGE [ > ].**

The system exclusive input page will appear, and the cursor will appear in the display.

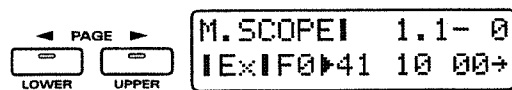

**3. Press PAGE [ < ] [ > ] or [ENTER] to move the cursor to the location that you wish to modify.**

**4. Use [INC] [DEC] or the [VALUE] dial to modify the value.**

\* If you press NUMBER [3] (INSERT), "00" will be input at the cursor location, allowing you to add data.

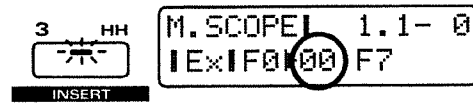

\* By pressing NUMBER [2] (DELETE) or [UNDO/REDO] you can delete the data at the cursor location.

**5. Move the cursor to the F7 location and press [ENTER], and the modified settings will be finalized.**

When the settings have been finalized, you will return to the normal Microscope display.

\* It is not possible to change the F0 that begins the message or the F7 that ends it.

To cancel the operation without changing the data, press [EXIT].

**Examples of exclusive messages**

Here are some examples of exclusive messages.

\* For a detailed explanation of exclusive messages, refer to p. 253.

**Set Reverb Level (p. 102) (address: 01H 00H 00H 29H) to 127 (7FH).**

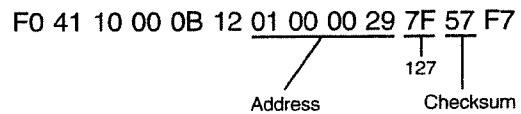

To set Reverb Level to 0, change the 7F in the above example to 00.

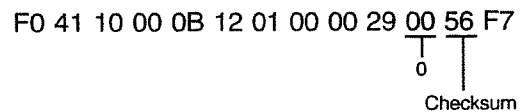

\* In the above example, the Device ID number has been written as 17 (10H) (the factory setting).

"Differentiating Between Units of the Identical Model (Device ID Number)" (p. 165)

**About the checksum**

When inputting a Roland Type IV exclusive message, you must input a checksum immediately before the F7. Since the JX-305 will calculate the checksum automatically, there is no need for you to modify the checksum value. When you input a new exclusive message, you can simply input an arbitrary number immediately before F7, and the JX-305 will calculate the correct number automatically.

## Deleting Musical Data (Delete Event)

1. In the Microscope display, rotate the [VALUE] dial to select the musical data that you wish to delete.

2. Press NUMBER [2] (DELETE).

The confirmation page will appear.

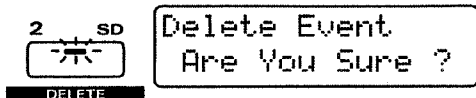

3. Press [ENTER].

The musical data will be deleted.

## Inserting Musical Data (Insert Event)

1. In the Microscope display, rotate the [VALUE] dial to move to the position where you wish to insert musical data.

2. Press NUMBER [3] (INSERT).

The Insert Event page will appear, and the following display will appear.

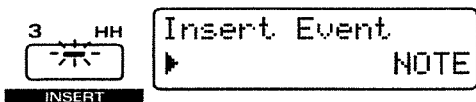

3. Use [INC] [DEC] or the [VALUE] dial to select the type of musical data that will be inserted.

Range:

When you are viewing a part 1-R in the Microscope

- Note: Note
- PC: Program change
- CC: Control change
- Pch Bend: Pitch bend
- P-AFT: Polyphonic aftertouch
- ChAfter: Channel aftertouch

When you are viewing a MUTE CTRL part in the Microscope

- Sys-Ex System exclusive
- Tempo: Tempo
- Mute: Mute

4. Press [ENTER].

A message with basic settings for the selected type of musical data will appear.

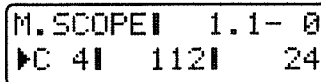

5. Press PAGE [<] [>] to move the cursor to the location that you wish to modify.

6. Use [INC] [DEC] or the [VALUE] dial to modify the value.

7. Press [ENTER] to finalize the settings.

### Using the keyboard and knobs to directly insert musical data

To input a note number, simply press a note to input the corresponding note number.

To input a control change, rotate a patch parameter knob, and the controller number and value for that knob will be input.

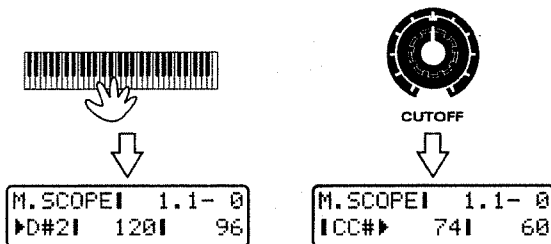

If you rotate a knob that is different than the controller number which is displayed, the controller number which had been input at that location will be replaced.

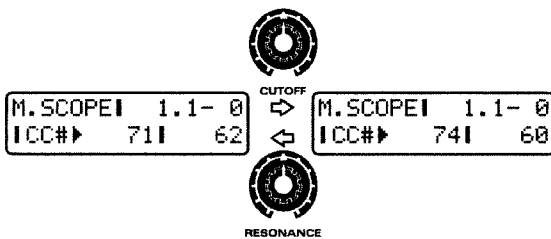

If you select "Sys-Ex" (System Exclusive), the following message will appear. In the same way as for the Change Event operation, use [INC] [DEC] or the [VALUE] dial and [ENTER] to successively enter hexadecimal data.

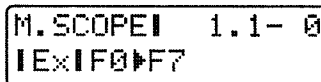

## Moving Musical Data (Move Event)

1. In the Microscope page, rotate the [VALUE] dial to access the musical data that you wish to move.
2. Hold down [SHIFT] and [REC], and rotate the [VALUE] dial to move the data.

While you hold down the buttons, the display will indicate the position to which the data is being moved.

```
M.SCOPE▶ 4.1-20
IG 4| 100| 19
```

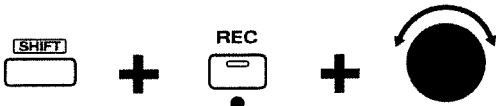

## Hiding Unwanted Musical Data (View Filter)

If a large amount of musical data has been recorded in a pattern, it may be difficult for you to find the data you are looking for if all types of data are displayed. In such cases, you can use the View Filter to specify the types of musical data that will be displayed. Since you can specify that only certain MIDI messages will be displayed, this lets you rapidly find the data that you are looking for.

1. In the Microscope page, press NUMBER [8] (VIEW FILTER).

The View Filter page will appear in the display.

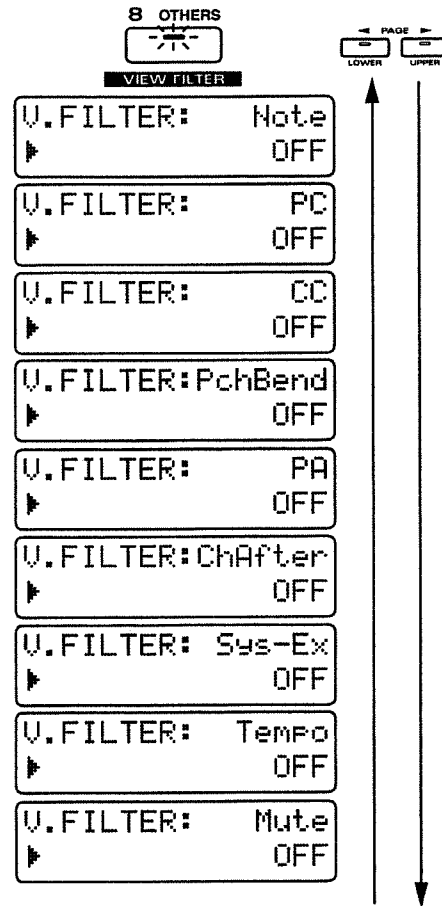

2. Press PAGE [<] [>] to select the type of musical data.

Note: Note  
 PC: Program change  
 CC: Control change  
 PchBend: Pitch bend  
 PA: Polyphonic aftertouch  
 ChAfter: Channel aftertouch  
 Sys-Ex: System exclusive  
 Tempo: Tempo  
 Mute: Mute

3. Use [INC] [DEC] or the [VALUE] dial to turn off the display of musical data that you do not need to view.

4. When you finish making settings, press [EXIT] to exit the page.

Data that you turned off will no longer be displayed in the Microscope page.

# Chapter 10. Collecting Frequently Used Patterns in a Set (Pattern Set)

A Pattern Set is a collection of patterns; sixteen patterns can be registered in a pattern set. The patterns that have been registered can be recalled by pressing the sixteen BANK and NUMBER [1]–[8] buttons.

Pattern set example

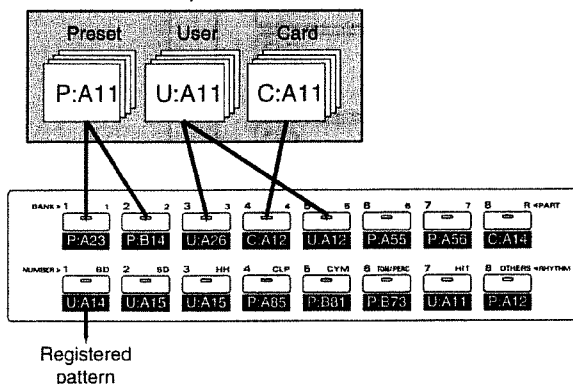

## Using a Pattern Set to Recall Patterns

### 1. Press [PTN SET].

The indicator will light, and the number and name of the currently selected pattern set will appear in the display.

Now you can use the BANK and NUMBER [1]–[8] buttons to recall patterns.

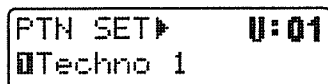

10

### 2. Use [INC] [DEC] or the [VALUE] dial to select a pattern set number.

Range: U:01–U:30

The display indication will change.

The pattern set has now been displayed.

### 3. Press the BANK and NUMBER [1]–[8] buttons to recall the patterns that have been registered.

You can recall patterns and switch pattern sets even while a pattern is playing back.

\* If a pattern that is only one measure long is playing, it may be impossible to select patterns using the BANK and NUMBER [1]–[8] buttons.

## Assigning a Pattern to be Recalled

You are free to re-assign the patterns in each pattern set. You may find it convenient to collect favorite patterns into a pattern set, or to put frequently-used patterns into a pattern set. As an example, here's how to assign pattern P:A22 in a pattern set.

First select the pattern set into which you will newly assign a pattern.

### 1. Select pattern P:A22 (p. 30).

### 2. Press [PTN SET].

The indicator will light, and the number and name of the currently selected pattern set will appear in the display.

### 3. Hold down [PTN SET], and press the BANK or NUMBER [1]–[8] button to which you wish to assign that pattern.

The pattern will be registered for the button that you press. For example if you wish to register the pattern to the BANK [7] button, use the following procedure.

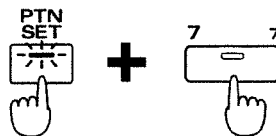

You can register patterns even while a pattern is playing back.

### 4. If you wish to register another pattern, press [PTN/SONG] to re-select the pattern, and repeat steps 2–3.

## Registering a variation of a pattern

If you assign a pattern with modified setup data (patch number and mute status etc. of each part), the pattern will be called from the pattern set in the same state as when it was assigned. By taking advantage of this, you can create a variety of variations based on a single user pattern, without having to save additional new patterns.

\* Patterns that were assigned with modified settings cannot be selected by the normal pattern select procedure.

### Example settings

#### Registering with modified mute settings

### 1. Select pattern P:A14.

### 2. Use [PART MUTE] and PART [1]–[R] to mute parts as shown in the diagram.

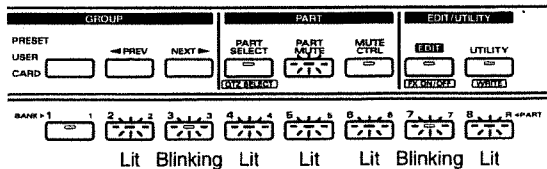

3. Hold down [PTN SET] and press BANK [1] to register the pattern in the pattern set.

4. Use [PART MUTE] and PART [1]-[R] to mute parts as shown in the diagram.

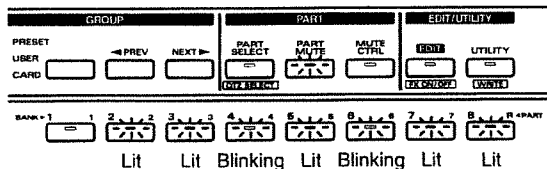

5. Hold down [PTN SET] and press BANK [2] to register the pattern in the pattern set.

6. Press BANK [1] [2] to select patterns with different mute settings that are based on the same single pattern.

## Saving a Pattern Set That Was Modified (Pattern Set Write)

When you have assigned patterns to create a pattern set that you like, you should save the result as a user pattern set.

1. Make sure that the pattern is stopped.
2. Press [PTN SET] to access the pattern set select page.

When you modify the contents of a pattern set, an asterisk "\*" will appear at the left of the number, indicating that the selected pattern set has been modified (edited). Be aware that if you turn off the power without saving the modified pattern set, the previous settings will reappear.

3. Hold down [SHIFT] and press [WRITE].

The indicator will blink.

The following display will appear, and "▄" (cursor) will appear at the left of the number.



If you do not wish to change the number or name, you can skip steps 4-7.

If you decide not to save the pattern, press [EXIT].

4. Use [INC] [DEC] or the [VALUE] dial to select the save destination number.

At this time, you can press [UNDO/REDO] to check the name of the pattern set that is currently in the save destination number. After you have found a pattern set that you do not mind overwriting, press [UNDO/REDO] once again to return to the previous display.

5. Press PAGE [>].

The cursor will move to the beginning of the second line of the display.

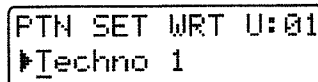

6. Assign a name to the pattern set.

Use [INC] [DEC] or the [VALUE] dial to specify the character.

The following characters are available.

Space, A-Z, a-z, 0-9, ! " # \$ % & ' ( ) \* +, - . / : ; < = > ? @ [ \ ] ^ \_ ` { | }

7. Repeat steps 5-6 to enter the name.

By pressing PAGE [<] you can move the cursor back toward the left.

8. Press [ENTER].

The confirmation screen will appear in the display.

If you decide to cancel the operation, press [EXIT].

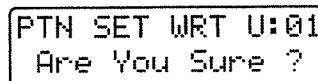

9. Press [ENTER] once again.

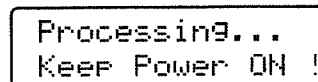

The pattern set write operation will be carried out, then the normal display will reappear.

The pattern set has now been saved.

# Chapter 11. Connecting Patterns in Playback Order to Create a Song

A set of patterns that are connected in the order of playback is called a “song.”

When you play back a song, the patterns will change automatically in sequence, so it will not be necessary for you to select patterns yourself. You can register up to 50 patterns in each song, in the order in which they are to be played back.

## Playing Back a Song

1. In the **SEQUENCER** section, press **[MODE]** to make the indicator light (Song mode).

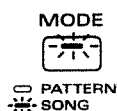

2. Press **[PTN/SONG]**.

The indicator will light.

The display will show the group, bank, number and name of the currently selected song.

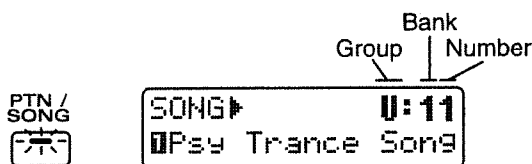

\* For songs, it is not possible to select the preset group or card group.

3. Use **[INC]** **[DEC]** or the **[VALUE]** dial to select a bank and number (**U:11-U:72**).

The number and name shown in the display will change.

\* You can also use the **BANK** and **NUMBER [1]-[8]** buttons to select songs.

The song is now selected.

\* With the factory settings, **U:35-U:72** will be blank songs (**EMPTY SONG**) that contain no musical data. Even if you select **EMPTY SONG** and then play back, no song will play back.

4. Press **[STOP/PLAY]**, and the song will begin playing back.

When song playback begins, the display will indicate the current pattern name, just as during pattern playback. As playback continues, the patterns will switch automatically in the recorded sequence. Tempo changes and the measure display within the pattern can be controlled in the same way as when playing back a pattern (p. 31).

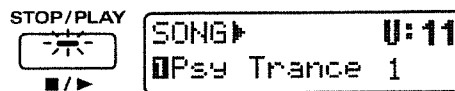

If you press **[PTN/SONG]** while a song is playing back, the display will show the playback order of the currently-playing pattern. In the following example, the display is indicating that pattern **P:A12** is played back second.

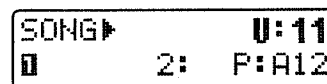

Press **[PTN/SONG]** once again, and the display will return to the current pattern name.

5. Press **[STOP/PLAY]**, and song playback will stop.

\* It is not possible for you to select patterns yourself. Nor is it possible to switch songs during playback.

### Fast-forward and rewind

Each time you press **[FWD]**, you will fast-forward in units of a pattern.

Each time you press **[BWD]**, you will rewind in units of a pattern.

By holding down **[FWD]** and pressing **[BWD]**, you can advance to the beginning of the last pattern.

By holding down **[BWD]** and pressing **[FWD]**, you can return to the beginning of the song. If you use **[FWD]** and **[BWD]** to move while the song is stopped, the display will show the playback order of that pattern.

### Cautions for song playback

Songs do not actually contain the musical data of the patterns; they contain only the order in which the patterns are to be played back. This means that if you modify a pattern that has been registered in a song, the playback of the song will also be affected. If you delete all of the musical data of the pattern, playback will stop at the moment that that pattern is selected.

If a song uses patterns that are saved in a memory card, song playback will stop if the memory card is not inserted into the memory card slot. Be sure that the memory card is inserted into the memory card slot.

## Recording a Song

On the JX-305, you can record a song by inputting the order in which patterns will be played back.

**1. Select the song that you wish to record.**

**2. Press [REC].**

The indicator will light, and recording will begin.

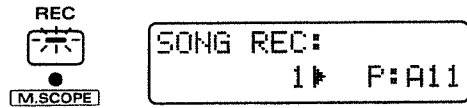

The display will show the pattern input number (the order of playback).

If you have selected a new song and begun recording, this will be "1."

**3. Use [INC] [DEC] or the [VALUE] dial to select the pattern that will be registered first.**

**4. Press [ENTER].**

The pattern input number will advance by one.

**5. Select the pattern that will be registered next.**

After making your selection, press [ENTER].

**6. Repeat step 3, 4 to complete the song.**

When you have finalized the last pattern, press [EXIT] or [REC] to end recording.

If you input a pattern by mistake, hold down [SHIFT] and press [BWD] to return to the input page for the previous step.

*\* If you wish to keep the song that you recorded, you must perform the Song Write operation.*

**"Saving a Song That You Recorded (Song Write)"** (p. 157)

**Re-recording from the middle**

If you are re-recording a song from the middle, or when you wish to add a new pattern to the end of a song, use [FWD] to advance to the location (pattern input number) where you wish to begin recording. Then you can enter recording mode to re-record from that location.

**Auditioning a pattern**

After selecting a pattern during recording, you can press [STOP/PLAY] to audition that pattern. As in Pattern mode, you can select different patterns while you audition them. When you are finished auditioning, press [STOP/PLAY].

While the pattern is being auditioned, the name of the pattern being auditioned will be shown in the display.



**Assigning a pattern with modified Setup parameters**

While auditioning a pattern, you can modify the mute, part mixer and effect settings, etc. for that part and press [ENTER] to assign the part with those settings. This will not affect the original pattern in any way, since the setup parameters for each pattern are stored as part of the song data.

Using this function, you can modify the mute settings or multi-effects type of one single pattern and create a song just by developing the same pattern in different ways.

## Editing Songs (Song Edit)

In the same way that you edited a pattern in Pattern mode, you can edit a song in Song mode. The process of making changes in Song mode is called "song editing."

*\* An edited song is held in the temporary area. If you wish to keep the song that you created, you must perform the Song Write operation.*

**"Saving a Song That You Recorded (Song Write)"** (p. 157)

**Cautions for song editing**

Song can be edited when the song select page of Song mode is displayed (i.e., when the [PTN/SONG] indicator is lit). It is not possible to enter the various editing pages during song playback.

**Setting the parameters**

To set or modify each parameter, use [INC] [DEC] or the [VALUE] dial.

You can also use [FWD] [BWD] to specify the location at which you will begin editing (the pattern playback number).

During editing, if you wish to return to the previous parameter setting page, press PAGE [<].

If you wish to cancel your editing, press [EXIT].

## Copying a Song (Song Copy)

This operation copies a song to a specified location in a different song. This can be used to combine two songs into a single song, or to combine parts of various songs to create a different song.

\* If there is already data in the copy destination song, the song data of the copy destination will be rewritten.

The number of patterns in the copy destination song may increase, such as when the copy source song contains more patterns than the copy destination song.

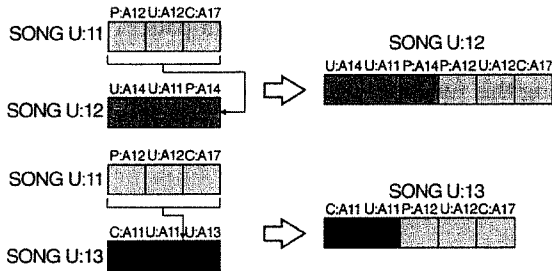

### 1. Select the copy source song.

### 2. Press [EDIT].

The indicator will light, and the display will show the edit page.

### 3. Press NUMBER [1] (COPY).

The Song Copy setting page will appear in the display.

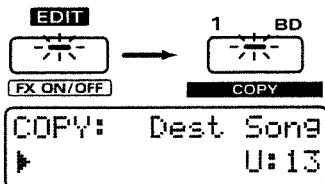

### 4. Select the copy destination song.

Range: U:11-U:72

### 5. Press [ENTER].

The display will indicate the pattern playback number of the copy destination song and the corresponding pattern.

### 6. Specify the location (pattern playback number) at which copying will begin.

Range: 1-50, END

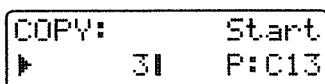

If the setting is "END," the data will be copied onto the end of the copy destination song.

\* It is not possible to specify a Copy operation that would result in a song containing more than 50 patterns.

### 7. Press [ENTER].

The confirmation screen will appear in the display.

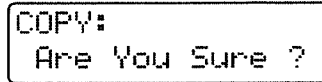

### 8. Press [ENTER] once again.

The Song Copy operation will be carried out, and the normal display will reappear.

## Deleting Unwanted Patterns from a Song (Delete Pattern)

This operation deletes a pattern from a song. When a pattern is deleted, subsequent patterns will be moved forward. Use this when you wish to remove unwanted patterns from a song.



### 1. Select the song from which you wish to delete a pattern.

### 2. Press [EDIT].

The indicator will light, and the display will show the edit page.

### 3. Press NUMBER [2] (DELETE).

The Delete Pattern setting page will appear, and the display will indicate the pattern playback number and the corresponding pattern.

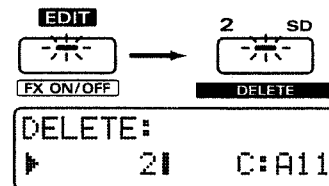

### 4. Select the pattern (pattern playback number) that you wish to delete.

Range: 1-50, ALL

With a setting of "ALL," all patterns in the song will be deleted.



**5. Press [ENTER].**

The confirmation screen will appear in the display.

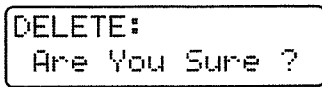

**6. Press [ENTER] once again.**

The Delete Pattern operation will be carried out, and the normal display will reappear.

**Inserting a Pattern (Insert Pattern)**

This operation insert a pattern into the specified location of a song. Use this when you want to add additional patterns to the song.

*\* A maximum of 50 patterns can be recorded in a song. If the song already contains 50 patterns, no more patterns can be inserted.*

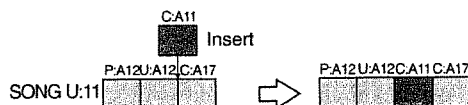

**1. Select the song into which you wish to insert a pattern.**

**2. Press [EDIT].**

The indicator will light, and the display will show the edit page.

**3. Press NUMBER [3] (INSERT).**

The Insert Pattern setting page will appear, and the display will indicate the pattern playback number and the corresponding pattern.

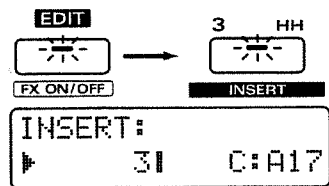

**4. Specify the location (pattern playback number) at which the pattern will be inserted.**

Range: 1–50, END

With a setting of END, the pattern will be added to the end of the song.

**5. Press [ENTER].**

The cursor will move to the right.

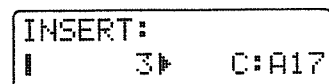

**6. Select the pattern that will be inserted.**

Range: P:A11–P:L88, U:A11–U:D18, C:A11–C:D18

*\* You can press [PRESET/USER/CARD] and [<PREV] [NEXT>] to switch groups.*

**7. Press [ENTER].**

The confirmation screen will appear in the display.

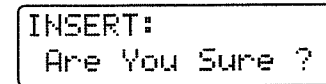

**8. Press [ENTER] once again.**

The Insert Pattern operation will be carried out, and the normal display will reappear.

**Saving a Song That You Recorded (Song Write)**

If you are happy with the song that you recorded, you can save that song as a user song.

**1. Make sure that the song is stopped.**

**2. Press [PTN/SONG] to access the song select page.**

If you modify song settings, an "\*" (asterisk) will appear at the left of the number, indicating that the selected song has been modified (edited). Be aware that if you turn off the power without saving the modified song, the previous settings will reappear.

**3. Hold down [SHIFT] and press [WRITE].**

The indicator will blink.

The following display will appear, and a "▶" (cursor) will appear at the left of the number.



If you do not wish to modify the number or name, you can skip steps 4–7.

If you decide not to save the song, press [EXIT].

**4. Use [INC] [DEC] or the [VALUE] dial to select the save destination bank and number.**

At this time, you can press [UNDO/REDO] to check the name of the song that is currently in the save destination number. After you have found a song that you do not mind overwriting, press [UNDO/REDO] once again to return to the previous display.

**5. Press PAGE [>].**

The cursor will move to the beginning of the second line of the display.

```
SONG WRITE  U:12
▶Psy Trance Song
```

**6. Assign a name to the song.**

Use [INC] [DEC] or the [VALUE] dial to specify characters.

The following characters can be selected.

Space, A-Z, a-z, 0-9, ! " # \$ % & ' ( ) \* + , - . / : ; < = > ?  
@ [ ¥ ] ^ \_ ` { | }

**7. Repeat steps 5-6 to enter the name.**

To move the cursor back toward the left, press PAGE [ < ].

**8. Press [ENTER].**

The confirmation screen will appear in the display.

To cancel the operation, press [EXIT].

```
SONG WRITE  U:12
Are You Sure ?
```

**9. Press [ENTER] once again.**

```
Processing...
Keep Power ON !
```

The Song Write operation will be carried out, and the normal display will reappear.

The song has now been saved.

**6. Select "SONG," and press [ENTER].**

The following display will appear.

```
SONG INIT   U:12
Are You Sure ?
```

**7. Press [ENTER].**

```
Processing...
Keep Power ON !
```

The Song Initialize operation will be carried out, then the normal display will reappear.

**11**

**Initializing Settings  
(Song Initialize)**

This initializes the song to a state in which no patterns are recorded.

**1. Make sure that the song is stopped.**

**2. Press [PTN/SONG] to access the song select page.**

**3. Select the song that you wish to initialize.**

**4. Press [UTILITY].**

The indicator will light.

**5. Press PAGE [ < ] [ > ] several times to select "INITIALIZE," and press [ENTER].**

# Chapter 12. Using Memory Cards

The rear panel of the JX-305 has a memory card slot that allows you to use memory cards (SmartMedia : optional). Memory cards can be used in the following ways.

- 1) In addition to the User groups in internal memory, you will be able to use Card groups to store user patches and user patterns.

**Patches:** C:A11-C:H88 (p. 18)

**Rhythm Sets:** C:A11-C:A34 (p. 28)

**Patterns:** C:A11-C:D18 (p. 30)

Patches and patterns that are stored in a card group can be used in the same way as patches and patterns from the user group.

- 2) All settings of the JX-305 including System settings can be saved (backed up) to a card, and restored into internal memory (Backup Load) when desired.

\* *Except while performing the Card Duplicate operation (p. 161), be sure to turn off the power before inserting or removing a card.*

\* *If a write protect sticker is affixed to the write protect area of the memory card, it will no longer be possible to record or erase the data of that card. When saving/initializing a pattern or patch, be sure that the write protect sticker does not remain on the card. For details on the write protect sticker, refer to the owner's manual for your memory card.*

*If you attempt to carry out an operation such as saving to the card group with a write protect sticker affixed, the following message will appear.*

CAUTION !  
Memory Protected

## Cautions When Using a Memory Card

### Memory Cards the JX-305 Can Use

The JX-305 can use the following memory cards (sold separately). Memory cards other than those specified should not be inserted into the memory card slot.

**S2M-5** (2 MB type)

**S4M-5** (4 MB type)

2 MB and 4 MB cards differ in the maximum number of patterns that they can store.

**2 MB :** Maximum 220,000 notes  
(100,000 notes if there is a backup file)

**4 MB :** Maximum 480,000 notes  
(360,000 notes if there is a backup file)

## Inserting and Removing a Card

Except when performing the Card Duplicate operation, be sure that the power is turned off when you insert or remove a card.

1. **With the power turned off, insert the memory card into the rear panel memory card slot as shown in the diagram. Push the card firmly all the way into the slot.**

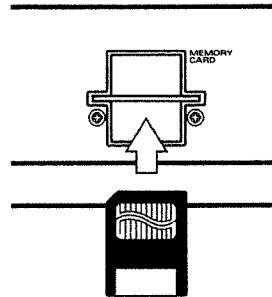

## Before Using a New Card (Format)

Before a newly purchased memory card can be used by the JX-305, you must use the "Format" operation to prepare it for use with the JX-305. When a memory card is formatted, all data that was on the card will be erased. This means that you can also use the Format operation to erase a card that has already been used on the JX-305.

\* *Even if the memory card was already formatted when you purchased it, it must be re-formatted on the JX-305.*

When an unformatted card is inserted, the following display will appear.

CAUTION !  
Wrong Card

1. **Make sure that the memory card you wish to format is inserted into the memory card slot.**

2. **Press [UTILITY].**

The indicator will light.

3. Press PAGE[<] [>] several times to select "CARD," and press [ENTER].

4. Press PAGE [<] [>] several times to select "FORMAT," and press [ENTER].

The formatting page will appear.

```
CARD:      Format
Are You Sure ?
```

5. Press [ENTER].

The following display will appear, and the Format operation will be carried out.

```
Processing...
Keep Power ON !
```

6. When formatting ends, the following display will appear.

```
CARD:      Format
Complete !
```

To exit the formatting page, press [UTILITY].

## Saving All Internal Settings to a Card (User Backup)

All internal data (user patches, user patterns, user songs, user pattern sets, user RPS sets etc.) and system settings can be saved as a whole to a memory card. This data is collectively known as a "backup file." Each memory card can contain one such backup file.

\* In order to create a backup file, there must be at least 1030 KB of remaining card memory. If you attempt to make a user backup when there is less than 1030 KB of remaining memory in the card, the following message will appear. If this happens, initialized unneeded patterns to increase the free card memory to 1030 KB or more.

```
CAUTION !
Cannot Backup
```

 If you wish to verify the amount of remaining card memory...

☞ "Checking the Remaining Amount of Memory (Memory Information)" (p. 137)

.....  
If from the beginning you wish to reserve memory for creating a backup file, you can perform the User Backup operation to create a backup file immediately after formatting the card.  
.....

1. Make sure that a memory card is inserted into the memory card slot.

2. Press [UTILITY].

The indicator will light.

3. Press PAGE [<] [>] several times to select "CARD," and press [ENTER].

4. Press PAGE [<] [>] several times to select "USER BACKUP," and press [ENTER].

The User Backup page will appear.

```
CARD:User Backup
Are You Sure ?
```

5. Press [ENTER].

The following display will appear, and the User Backup operation will be carried out.

```
Processing...
Keep Power ON !
```

6. When User Backup has been completed, the following display will appear.

```
CARD:User Backup
Complete !
```

If you wish to exit the User Backup page, press [UTILITY].

\* If you perform a User Backup operation on a card that already contains a backup file, the contents of the previous backup file will be lost.

\* User patches or user patterns which have been saved on a card by the User Backup operation cannot be recalled as a card group.

## Restoring the Saved Settings Back to Internal Memory (Backup Load)

This operation loads the contents of a backup file that was saved on a card back into internal memory.

**1. Make sure that the memory card is inserted in the memory card slot.**

**2. Press [UTILITY].**

The indicator will light.

**3. Press PAGE [<] [>] several times to select "CARD," and press [ENTER].**

**4. Press PAGE [<] [>] several times to select "BACKUP LOAD," and press [ENTER].**

The Backup Load page will appear.

```
CARD: Backup Load
Are You Sure ?
```

**5. Press [ENTER].**

The following display will appear, and the Backup Load operation will be carried out.

```
Processing...
Keep Power ON !
```

**6. When Backup Load is completed, the following display will appear.**

```
CARD: Backup Load
Complete !
```

To exit the Backup Load page, press [UTILITY].

## Deleting the Backup File from the Card (Backup Delete)

When you no longer need a backup file that you created, you can delete the backup file. By deleting the backup file, you can increase the capacity of the card by 120,000 notes.

**1. Make sure that a memory card is inserted into the memory card slot.**

**2. Press [UTILITY].**

The indicator will light.

**3. Press PAGE [<] [>] several times to select "CARD," and press [ENTER].**

**4. Press PAGE [<] [>] several times to select "BACKUP DELETE," and press [ENTER].**

The Backup Delete page will appear.

```
CARD: Backup Del
Are You Sure ?
```

**5. Press [ENTER].**

The following display will appear, and the Backup Delete operation will be carried out.

```
Processing...
Keep Power ON !
```

**6. When Backup Delete is completed, the following display will appear.**

```
CARD: Backup Del
Complete !
```

To exit the Backup Delete page, press [UTILITY].

## Copying an Entire Card (Card Duplicate)

This operation copies all data from a memory card to another memory card, to create an exact duplicate of the first card. If a card contains important data, it is a good idea to create a duplicate as a safety measure.

\* *The Card Duplicate operation can be used only with cards that are the same capacity. For example, it is not possible to copy a 2 MB card to a 4 MB card, or vice versa.*

**1. Prepare a copy source memory card and an empty memory card of the same capacity.**

The copy destination card must already be formatted.

**2. While holding down [UTILITY], press the [POWER] button to turn on the power.**

The following display will appear.

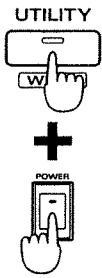

```
CARD: Duplicate
Insert Src Card
```

**3. Insert the copy source memory card into the memory card slot.**

The following display will appear.

```
Processing...
Keep Power ON !
```

**4. After a time, the following display will appear, so remove the copy source card and insert the copy destination card.**

```
CARD: Duplicate
Insert Dest Card
```

The following display will appear.

```
Processing...
Keep Power ON !
```

**5. After a time, the following display will appear, so repeat steps 3-4.**

```
CARD: Duplicate
Insert Src Card
```

12

**6. When the Card Duplicate operation has been completed, the following display will appear.**

```
CARD: Duplicate
Complete !
```

To exit the Card Duplicate page, press [UTILITY].

**Installing the card protector**

The JX-305 provides a card protector to prevent theft of the memory card. To install the card protector, use the following procedure.

- 1. Use a screwdriver to remove both screws that are at either side of the memory card slot.**
- 2. Insert the memory card into the memory card slot.**
- 3. Use the screws to fasten the card protector as shown below.**

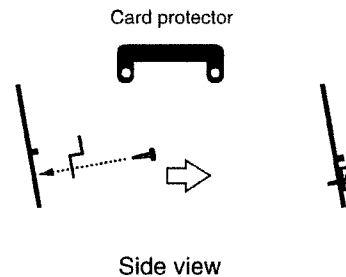

**Using MC-505 cards**

The JX-305 can read patch, rhythm set and pattern data from a memory card that has been written on the MC-505.

Conversely, patch, rhythm set and pattern data that was written by the JX-305 to a memory card can also be read by the MC-505.

\* Data which uses waves (C:001-C:131) or patches (P:111-P:188) that were added on the JX-305 cannot be read correctly by the MC-505.

\* It is not possible to read a backup file that was written by the MC-505.

# Chapter 13. Setting the Operating Environment of the JX-305 (System)

Here you can make settings that affect the operation of the entire JX-305, such as tuning and the synchronization method. The settings of the various System parameters are remembered even while the power is turned off.

\* It is not possible to access the various System setting pages while a pattern or song is playing back.

## Controller-Related Settings

### 1. Press [EDIT].

The indicator will light and the display will show the Edit page.

### 2. Press BANK [5] (CONTROLLER).

The display will show the CONTROLLER setting page.

### 3. Use PAGE [<] [>] to select parameters, and use [INC] [DEC] or the [VALUE] dial to set each parameter.

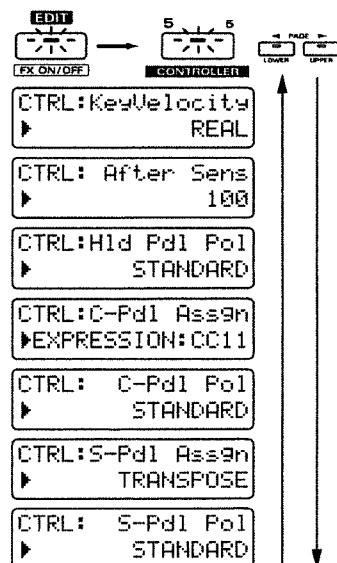

To exit the setting page, press [EXIT].

## Changing the Loudness of Notes Played on the Keyboard (Keyboard Velocity)

When you play notes on the keyboard, the loudness of each note is affected by the force (velocity) at which you strike the note. If you want the velocity value of each note to depend on how strongly you play the keyboard, set this parameter to REAL. If you want each note to have a fixed velocity regardless of how strongly you play the keyboard, set this parameter to the desired value.

Range: REAL, 1–127

## Setting Aftertouch Sensitivity (Aftertouch Sens)

You can specify aftertouch sensitivity.

Range: 0–100

Higher values allow aftertouch to be easier applied. Default setting is 100.

As this value is increased, notes played from the keyboard will be stronger.

## Specifying How the Pedal Will Function

### Hld Pdl Pol (Hold Pedal Polarity)

Select the polarity of the Hold pedal.

Range: STANDARD, REVERSE

If you are using a pedal with inverted polarity (so the pedal functions in a way opposite from what you expect), select “REVERSE.”

### C-Pdl Assgn (Control Pedal Assign)

Specify the function of the pedal (control pedal) connected to the CONTROL PEDAL jack.

Range:

CC01–CC95: Controller Number 1–95 (except 6, 32, 38)

PITCH BEND UP: Pitch Bend Up

PITCH BEND DOWN: Pitch Bend Down

AFTERTOUCH: Aftertouch

### C-Pdl Pol (Control Pedal Polarity)

Select the polarity of the Control pedal.

Range: STANDARD, REVERSE

If you are using a pedal with inverted polarity (so the pedal functions in a way opposite from what you expect), select “REVERSE.”

### S-Pdl Assgn (Switch Pedal Assign)

This specifies the function of a pedal (switch pedal) connected to the SWITCH PEDAL jack.

Range:

- STOP/PLAY:** The pedal will act like the [STOP/PLAY] button.
- PTN INC:** (Pattern Increment) The patterns of the currently selected pattern set will be successively selected as the next pattern.
- TRANSPOSE:** The pedal will act like the [TRANSPOSE] button.
- SHIFT:** The pedal will act like the [SHIFT] button.
- RPS HOLD:** If you press the pedal while holding a note to which a phrase is registered, that phrase will be held (p. 49).
- TAP:** The tempo will be modified to the interval at which you press the pedal (p. 46).

### S-Pdl Pol (Switch Pedal Polarity)

Select the polarity of the Switch pedal.

Range: STANDARD, REVERSE

If you are using a pedal with inverted polarity (so the pedal functions in a way opposite from what you expect), select "REVERSE."

## MIDI-Related Settings

### 1. Press [EDIT].

The indicator will light and the display will show the Edit page.

### 2. Press BANK [6] (MIDI).

The MIDI setting page will appear.

### 3. Use PAGE [<] [>] to select parameters, and use [INC] [DEC] or the [VALUE] dial to set each parameter.

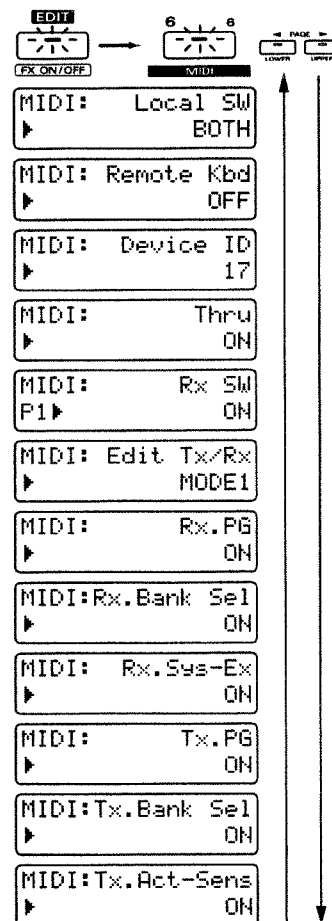

To exit the setting page, press [EXIT].



### **Disconnecting the Keyboard from the Internal Sound Generator (Local Switch)**

This specifies the destination to which MIDI messages from the controller section (keyboard, pitch bend/modulation lever, knobs, pedals etc.) will be transmitted.

**Range:**

- INT:** Messages from the controller section will be transmitted only to the internal sound generator.
- EXT:** Messages from the controller section will be transmitted only to MIDI OUT.
- BOTH:** Messages from the controller section will be transmitted both to the internal sound generator and to MIDI OUT.

Normally you will leave this set at "BOTH."

If you do not want messages from the controller section to be transmitted from MIDI OUT, select "INT."

If you want to use the controller section to control only the external sound generator, select "EXT."

### **Using an External MIDI Keyboard in Place of the Keyboard of the JX-305 (Remote Keyboard Switch)**

An external MIDI keyboard can be used instead of the JX-305's keyboard.

**Range:** OFF, ON

When this setting is "ON," so regardless of the transmit channel setting of the external MIDI keyboard, it will play the patch of the current part.

If you wish to use the JX-305 as a 8-part multitimbral sound generator controlled by an external sequencer, turn this "OFF." This will allow MIDI messages transmitted from the external sequencer to play patches independently for each channel (part).

\* If you wish to control RPS or arpeggios from an external MIDI device, turn this "ON."

### **Differentiating Between Units of the Identical Model (Device ID Number)**

This parameter sets the Device ID Number.

MIDI devices have an identifying number called the Model ID, which is different for each model of device. When system exclusive messages are transmitted and received, this number is used to distinguish between different models. However, when two or more devices of the identical model need to receive and transmit system exclusive data independently, the Model ID by itself is not a sufficient distinction. For this reason, the Device ID Number is used to distinguish between two or more JX-305 units.

**Range:** 17–32

With the factory settings the Device ID Number is set at "17." If you are using only one JX-305, there is no need to change this setting.

### **Re-Transmitting Messages Received at MIDI IN from MIDI OUT (Thru Function)**

When this function is "ON," MIDI messages received at the MIDI IN connector will be re-transmitted from MIDI OUT without change.

**Range:** OFF, ON

\* When the arpeggiator is on, messages received at MIDI IN will not be re-transmitted from MIDI OUT even if this Thru setting is ON.

### **Specifying the Reception Status for Each Part (Rx Switch)**

Specifies whether each part [1]–[R] is to receive MIDI messages (ON) or not (OFF). If this is OFF, the part will respond to the keyboard, but not to the internal sequencer or external MIDI devices.

Use [PART SELECT] and PART [1]–[R] to select the part whose setting you wish to change.

### **Specifying How Knob Data Is Transmitted (Edit Transmit/Receive Mode)**

This specifies the type of MIDI messages which will be exchanged with external devices when panel knobs or the control pedal are operated during normal play.

\* When panel knobs are operated during patch editing, their settings will be transmitted as system exclusive messages that contain data for each tone. Similarly, data from the REVERB LEVEL, DELAY LEVEL and MULTI CTRL knobs is always transmitted as system exclusive messages regardless of the mode.

**Range:** MODE1, MODE2

**MODE1 :** Knob or the control pedal data will be transmitted and received as control changes and as system exclusive data.

**MODE2 :** Knob or the control pedal data will be transmitted and received as control changes.

With the factory settings this is set to "MODE1."

\* With MODE1, some control changes will be automatically converted to a system exclusive message for transmission. Also, when such a converted exclusive message is received, it will automatically be converted to a control change inside the JX-305.

\* With MODE2, knobs will transmit and receive MIDI messages in a way that differs from the official MIDI specification. Be aware that MODE2 is a non-standard use of MIDI.

 If you would like to know the control number assignments for each knob in MODE1 and MODE2...  
 ⓘ "Transmit/Receive Setting List" (p. 235)

\* If you want the JX-305 to receive MIDI messages that were transmitted from the knobs to an external device (and then re-transmitted back to the JX-305), you must select the same Edit Transmit/Receive Mode with which the data was originally transmitted. If this setting is different, MIDI messages will not be received correctly.

## Reception Settings for Each Type of Message

### Rx.PG (Receive Program Change Switch)

Specifies whether or not each part will receive program changes.

Range: OFF, ON

When this is "OFF," program changes will not be received.

### Rx.Bank Sel (Receive Bank Select Switch)

Specifies whether or not each part will receive bank select messages.

Range: OFF, ON

When this is "OFF," bank select messages will not be received.

### Rx.Sys-Ex (Receive System Exclusive Switch)

Specifies whether or not each part will receive system exclusive messages.

Range: OFF, ON

When this setting is "OFF," system exclusive messages will not be received.

## Transmission Settings for Each Type of Message

### Tx.PG (Transmit Program Change Switch)

Specifies whether or not program changes will be transmitted from MIDI OUT when the patch of each part is changed.

Range: OFF, ON

When this setting is "OFF," program changes will not be transmitted.

### Tx.Bank Sel (Transmit Bank Select Switch)

Specifies whether or not bank select messages will be transmitted from MIDI OUT when the patch of each part is changed.

Range: OFF, ON

When this setting is "OFF," bank select messages will not be transmitted.

### Tx.Act-Sens (Transmit Active Sensing Switch)

Specifies whether or not Active Sensing messages will be transmitted from MIDI OUT.

Range: OFF, ON

When this setting is "OFF," these messages will not be transmitted.

## Sequencer-Related Settings

### 1. Press [EDIT].

The indicator will light and the display will show the Edit page.

### 2. Press BANK [7] (SEQUENCER).

The SEQUENCER setting page will appear.

### 3. Use PAGE [<] [>] to select parameters, and use [INC] [DEC] or the [VALUE] dial to set each parameter.

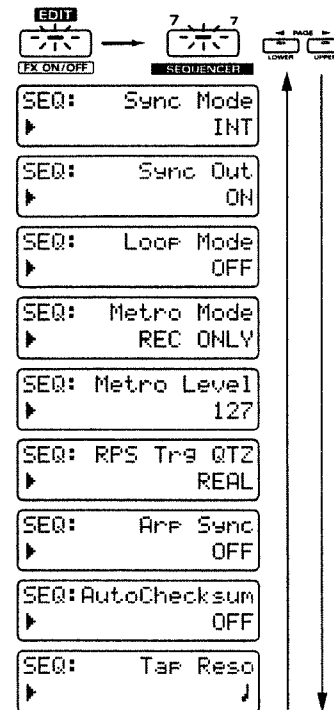

To exit the setting page, press [EXIT].

## Synchronization Settings (Sync Mode)

This specifies how the internal sequencer will operate and how MIDI Clock messages will be transmitted and received.

**Range:**

**INT:** The internal sequencer will synchronize to the internal tempo clock, and will transmit MIDI Clock messages. Any MIDI Clock messages received from an external device will be ignored.

**REMOTE:** Operation will be essentially the same as "INT." However, Start/Stop messages from the external MIDI device will control playback/stop for the internal sequencer.

**SLAVE:** The internal sequencer will synchronize to MIDI Clock messages received from an external device. If no MIDI Clock messages are being received, pattern/song playback will not occur even if you press the [STOP/PLAY] button.

## Transmitting Synchronization Messages (Sync Out)

This specifies whether or not synchronization-related MIDI messages will be transmitted.

**Range:** OFF, ON

When this is ON, the following messages will be transmitted from the MIDI OUT connector.

Timing Clock: F8  
 Start: FA  
 Continue: FB  
 Stop: FC  
 Song Position Pointer: F2

## Making Songs Play Continuously (Loop Mode)

This specifies how songs will play back.

You can make the same song play back continuously, or make all songs play back in succession.

**Range:**

**OFF:** This is the normal playback mode. The currently selected song will play back only once.

**LOOP1:** The currently selected song will play back repeatedly.

**LOOP2:** All songs will play back in succession.

\* When using LOOP2 to play back songs, we recommend that a pattern which mutes all parts (i.e., a silent pattern) be inserted at the end of each song, so that songs are joined smoothly.

## Setting the Metronome (Metronome Mode)

Here you can specify how the metronome will sound.

**Range:**

**OFF:** The metronome will not sound.

**REC ONLY:** The metronome will sound only during recording.

**REC&PLAY:** The metronome will sound during playback and recording.

**ALWAYS:** The metronome will sound constantly.

## Adjusting the Metronome Volume (Metronome Level)

This sets the volume of the metronome.

**Range:** 0–127

Increasing this setting will raise the volume.

## Specifying the Timing for RPS Playback (RPS Trigger Quantize)

When using RPS while a pattern is playing back, the playback of the pattern and the phrase may be skewed, depending on the timing at which you press the keyboard. On the JX-305 you can specify the playback timing of the phrase, so it will play back in precise synchronization with the pattern.

**Range:** REAL    MEASURE

**REAL:** The phrase will play back immediately, at the timing at which you pressed the keyboard.

: The pattern will be divided into 16th note units, and when you press the keyboard, the phrase will begin playing at the beginning of the next 16th note unit.

: The pattern will be divided into 8th note units, and when you press the keyboard, the phrase will begin playing at the beginning of the next 8th note unit.

: The pattern will be divided into quarter note units, and when you press the keyboard, the phrase will begin playing at the beginning of the next quarter note unit.

**MEASURE:** The pattern will be divided into one-measure units, and when you press the keyboard, the phrase will begin playing at the beginning of the next measure. This lets you ensure that the phrase will begin playing at the beginning of the next measure.

\* Except when this parameter is set to "REAL," pressing the keyboard slightly before the actual desired timing will help you synchronize the phrase to the pattern.

\* If the pattern is stopped, the phrase will play back immediately, regardless of this setting.

## Synchronizing Arpeggios to the Pattern (Arpeggio Sync)

You can specify whether or not arpeggios will be synchronized to the pattern playback.

Range: OFF, ON

With the factory settings, this will be "ON." If you do not want arpeggios to be synchronized to the pattern playback, turn Arpeggio Sync "OFF."

## Calculating a Checksum Automatically (Auto Checksum)

This specifies whether or not the checksum will be calculated automatically when you use the Microscope page to input a system exclusive message.

Range: OFF, ON

With the factory settings this will be "ON." If you do not want the checksum to be calculated automatically, turn this "OFF."

## Specifying the Resolution of the Tap Tempo (Tap Resolution)

This specifies the basic note value that will be used when the Switch pedal is used to modify the tempo.

Range: ♩ ♪

When you press the Switch pedal, the tempo will be changed to intervals of the specified note value.

## Tuning and Sound Generator Related Settings

### 1. Press [EDIT].

The indicator will light and the display will show the Edit page.

### 2. Press BANK [8] (SETUP).

The SETUP setting page will appear.

### 3. Use PAGE [←] [→] to select parameters, and use [INC] [DEC] or the [VALUE] dial to set each parameter.

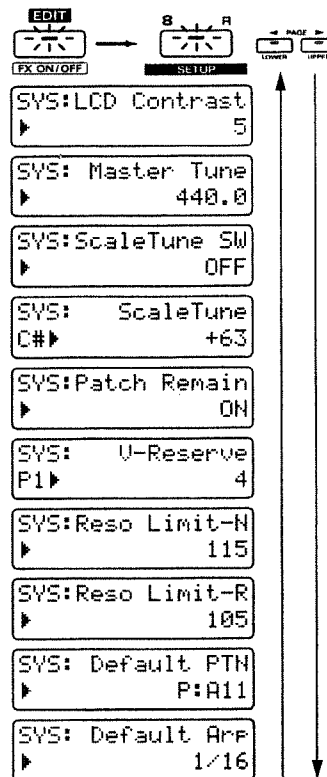

To exit the setting page, press [EXIT].

## Adjusting the Display Contrast (LCD Contrast)

This adjusts the contrast (brightness) of the LCD display. Increasing this value will increase the contrast of the display.

Range: 1-16

## Adjusting the Overall Tuning (Master Tune)

This adjusts the tuning of the JX-305's sound generator. The display shows the frequency of the A4 note.

Range: 427.4-440.0-452.6 Hz

## Tuning Each Note (Scale Tune)

By modifying the tuning of each of the 12 notes from C to B, you can play using a variety of temperaments.

## Scale Tune SW (Scale Tune Switch)

Turn this ON when you wish to use the Scale Tune function.

Range: OFF, ON

### Scale Tune (Scale Tune)

Adjusts the pitch of each note. The pitch is specified in 1-cent units relative to the equal tempered pitch.

**Range:** -64+63

Press the appropriate key to select the note that you wish to adjust.

.....  
One cent is 1/100th of a semitone.  
.....

### About various temperaments

#### Equal temperament

This temperament divides the octave into 12 equal parts, and is the temperament that is most widely used today, particularly for Western music. When the Scale Tune Switch is OFF, the JX-305 will use equal temperament.

#### Just intonation (Tonic of C)

Compared to equal temperament, the principle triads will harmonize more perfectly. However this effect is obtained only in a single key, and if you modulate to a different key, the chords will be discordant.

#### Arabian-style temperament

This is an Arabian-style temperament. On the JX-305, you can enjoy Arabian-style temperament in the three keys of G, C and F.

#### Example

Note	Equal tempered	Just intonation (C is tonic)	Arabian-style temperament
C	0	0	-6
C#	0	-8	+45
D	0	+4	-2
D#	0	+16	-12
E	0	-14	-51
F	0	-2	-8
F#	0	-10	+43
G	0	+2	-4
G#	0	+14	+47
A	0	-16	0
A#	0	+14	-10
B	0	-12	-49

.....

### Specifying How Patches Will Be Switched (Patch Remain)

You can specify whether or not currently sounding notes will be turned off when another patch or rhythm set is selected.

**Range:** OFF, ON

If this is on, currently sounding notes will continue.

### Specifying the Number of Notes for Each Part (Voice Reserve)

Specifies the number of notes that will be reserved for each part when the total number of requested notes exceeds 64.

**Range:** 0-64

Use [PART SELECT] and PART [1]-[R] to select the part whose settings you wish to modify.

Voice Reserve settings can be made up to a total of 64 notes for all parts.

### Specifying the Variable Range of Resonance (Resonance Limiter)

You can specify the range in which the [RESONANCE] knob can be adjusted.

You can make separate settings for the rhythm part [Reso Limit-R] and for the other parts [Reso Limit-N].

**Range:** 50-127

As this setting is increased, the variable range of the [RESONANCE] knob will increase.

Reso Limit-R = 100

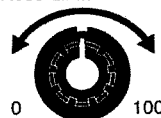

RESONANCE

### Specifying the Pattern at Power-On (Default Pattern)

Specify the pattern which will be selected when the power is turned on.

**Range:** P:A11-P:L88, U:A11-U:D18, C:A11-C:D18

## Specifying the Arpeggio Style at Power-On (Default Arpeggio Style)

Specify the arpeggio style which will be selected when the power is turned on.



Range: 1/4, 1/6, 1/8, 1/12, 1/16, 1/32, PORTAMENTO A, B, GLISSANDO, SEQUENCE A-D, ECHO, SYN BASS, HEAVY SLAP, LIGHT SLAP, WALK BASS, RHYTHM GTR 1-5, 3 FINGER, STRUMMING GTR, PIANO BACKING, CLAVI CHORD, WALTZ, SWING WALTZ, REGGAE, PERCUSSION, HARP, SHAMISEN, BOUND BALL, RANDOM, BOSSA NOVA, SALSA, MANBO, LATIN PERCUSSION, SAMBA, TANGO, HOUSE, LIMITLESS, USER STYLE 1-10

\* When the power is turned on, the arpeggiator switch will be off.

## Restoring the Factory Settings (Factory Preset)

The sound settings and pattern data stored in the JX-305 can be restored to the factory set condition.

\* If your JX-305 contains important data, use the Bulk Dump procedure to save the data on an external MIDI sequencer etc., or use the User Backup procedure to save the data on a memory card.

 "Saving Pattern and Patch Data on an External Sequencer (Bulk Dump)" (p. 176)  
 "Saving All Internal Settings to a Card (User Backup)" (p. 160)

### 1. Press [UTILITY].

The indicator will light.

### 2. Press PAGE [<] [>] several times to select "FACTORY PRESET," and press [ENTER].

### 3. Use PAGE [<] [>] to select the item that you wish to restore to the factory set condition.

The following three items can be selected.

**ALL:** All internal settings will be restored to the factory settings.

**PATCH:** The user patches of internal memory will be restored to the factory settings.

**SYSTEM:** The System settings will be restored to their factory settings.

```
FACTORY PRESET:
      ALL →
```

### 4. Press [ENTER].

The execute page will appear in the display.

If you wish to cancel the operation, press [EXIT].

```
FACTORY PRESET:
Are You Sure ?
```

### 5. Press [ENTER], and the Factory Preset operation will be executed.

While this is being executed, the following display will appear.

```
Processing...
Keep Power ON !
```

When the Factory Preset operation is completed, the normal display will automatically reappear.

\* If you select "ALL" and execute, approximately one minute will be required for the operation to be completed. Once the Factory Preset operation has been executed, never turn off the power until the normal display has reappeared.

# Chapter 14. Advanced Applications

## Taking Advantage of MIDI

### What Is MIDI?

The JX-305 records and plays back MIDI musical data, and when MIDI musical data is received its sound generator will produce sound.

What is MIDI?

MIDI (Musical Instrument Digital Interface) is a standard specification that allows musical data to be exchanged between electronic musical instruments and computers. Devices that have a MIDI connector can be connected using a MIDI cable, allowing them to transmit and receive data. Today, MIDI is found on virtually all electronic musical instruments. Without MIDI, it would not be possible to use an external keyboard to play the JX-305, or to use the JX-305 to record and play back a performance played on an external keyboard. Although you can use the JX-305 without knowing much at all about MIDI, you might also want to take full advantage of the possibilities offered by electronic musical instruments. This chapter will provide a simple explanation of the JX-305's MIDI-related functionality.

### MIDI connectors

The JX-305 has three MIDI connectors, which function as follows.

#### MIDI OUT connector

This connector transmits MIDI messages to external MIDI devices.

#### MIDI IN connector

This connector receives MIDI messages that are transmitted from external MIDI devices. The JX-305 can receive these messages to play notes or select sounds, etc.

#### MIDI THRU connector

MIDI messages received at MIDI IN are re-transmitted without change from this connector.

### MIDI channels

MIDI is able to transmit large amounts of independent musical data over a single MIDI cable. This is made possible by the concept of "MIDI channels." MIDI channels allow messages intended for a given instrument to be distinguished from messages intended for another instrument. There are sixteen MIDI channels (1-16), and normally the transmitting device must be set to the same MIDI channel as the receiving device in order for messages to be received.

When Remote Keyboard setting is "ON," an external

MIDI keyboard will be able to play the patch of the current part, regardless of its transmit channel setting.

☞ "Using an External MIDI Keyboard in Place of the Keyboard of the JX-305 (Remote Keyboard Switch)" (p. 165)

\* The transmit/receive channel settings of each part are as follows. It is not possible to change the channel settings of each part.

Part 1:	ch. 1
Part 2:	ch. 2
Part 3:	ch. 3
Part 4:	ch. 4
Part 5:	ch. 5
Part 6:	ch. 6
Part 7:	ch. 7
Rhythm part:	ch. 10

The flow of MIDI signals inside the JX-305 is as follows.

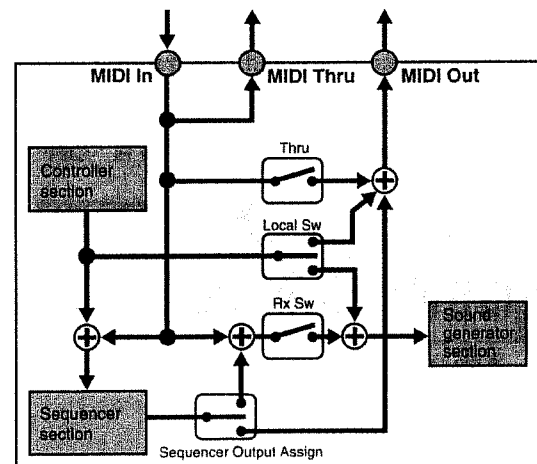

☞ If you would like to know more about each parameter...

☞ "Re-Transmitting Messages Received at MIDI IN from MIDI OUT (Thru Function)" (p. 165)

☞ "Disconnecting the Keyboard from the Internal Sound Generator (Local Switch)" (p. 165)

☞ "Specifying the Reception Status for Each Part (Rx Switch)" (p. 165)

☞ "Specifying the output destination for musical data (Sequeencer Output Assign)" (p. 36)

## Controlling the JX-305 from an External MIDI Device

### Playing the JX-305 from an External MIDI Keyboard

#### When the Remote Keyboard Switch is "ON"

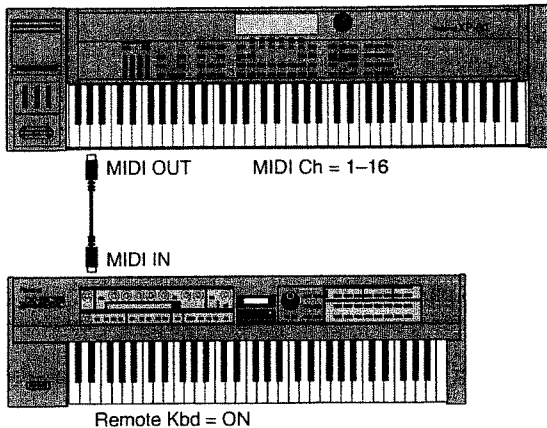

By changing the current part on the JX-305, you can change the part that will sound. The transmit channel of the external MIDI keyboard does not matter.

#### When the Remote Keyboard Switch is "OFF"

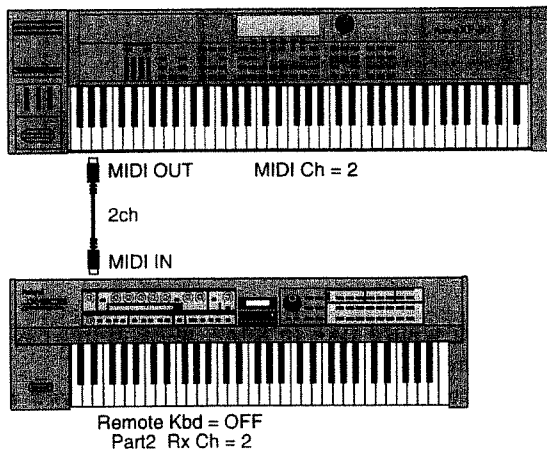

#### Selecting patches from an external MIDI device

By transmitting control change Bank Select messages (CC#0, CC#32) and Program Change messages (PC) from an external MIDI device to the JX-305, you can change the patch (rhythm set) of each part. At this time, the Receive Program Change Switch and the Receive Bank Select Switch must be turned ON (p. 166). For details on how bank select and program change messages are transmitted from your external MIDI device, refer to the owner's manual for your device.

- 📖 If you would like to know how the incoming bank select and program change messages correspond to each patch (rhythm set), refer to:
- ☞ "Preset Patch List" (p. 190)
  - ☞ "Preset Rhythm Set List" (p. 195)
  - ☞ "MIDI Implementation" (p. 236)

Set the transmit channel of the external MIDI keyboard to match the receive channel of the JX-305 that you wish to play. For example, if you wish to play part 2, set the transmit channel of the external MIDI keyboard to "2" since the receive channel of part 2 is "2."

- 📖 ☞ "Using an External MIDI Keyboard in Place of the Keyboard of the JX-305 (Remote Keyboard Switch)" (p. 165)



### Playing the JX-305 from a Workstation (or Personal Computer)

If you wish to use a workstation or an external MIDI sequencer to play the JX-305 (instead of using the JX-305's internal sequencer), or to connect the JX-305 to a personal computer that is running sequencer software, make connections as follows.

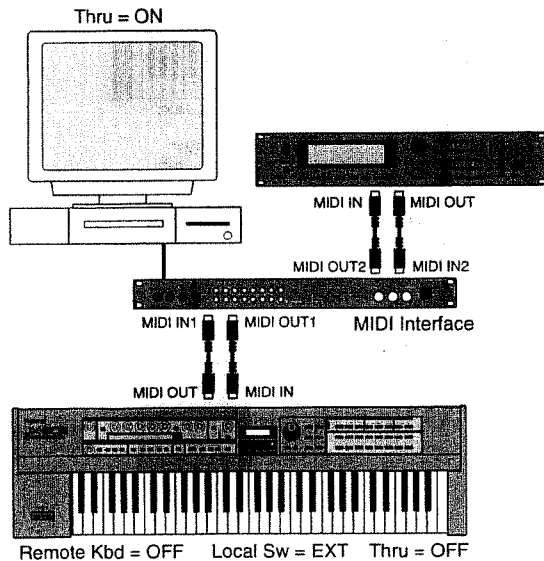
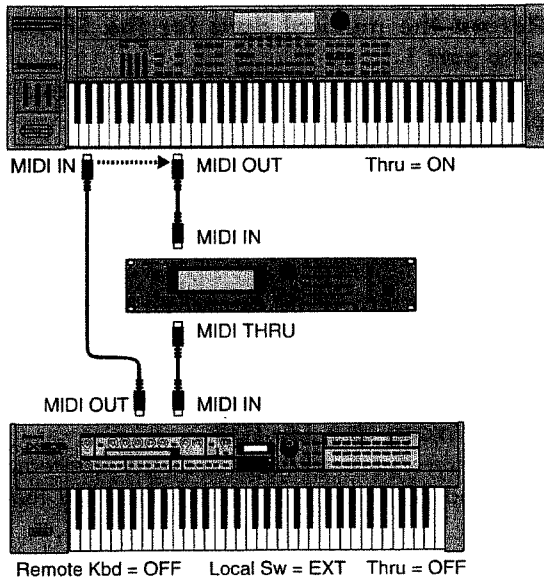

\* If you wish to connect a computer and play the JX-305 from a MIDI sequencer program etc., you will need to use a MIDI interface appropriate for your computer.

1. Turn on the Thru function of your workstation (or MIDI sequencer software).

2. Make the following settings on the JX-305.

Local Switch: EXT (p. 165)

Remote Keyboard Switch: OFF (p. 165)

Thru Function: OFF (p. 165)

3. Set the transmit channel(s) of your workstation (or MIDI sequencer software) to match the receive channel of the part(s) you wish to play.

If you have connected a workstation, you can play the keyboard of the workstation to sound the JX-305 while you record your playing on the workstation, or operate the knobs or arpeggiator etc. of the JX-305 and record this data on the workstation.

If the JX-305's MIDI OUT is connected to the MIDI IN of the MIDI interface or the external MIDI sequencer, you can operate the knobs/sliders and arpeggiator of the JX-305 and record this data.

\* If you are also using an external MIDI sound module, you can avoid problems by turning off the receive channel and receive switch for parts that you will not be using.

### Tempo synchronization when using the JX-305 as a sound module

By setting Sync Mode to "SLAVE" and then setting parameters such as LFO Rate, Delay Time and Multi Effects Rate to be synchronized to the tempo, you can synchronize these parameters to the tempo of an external sequencer. However in this case, the JX-305 will respond to synchronization messages from the external sequencer and play back patterns. If you simply want to synchronize the sounds to the tempo, you should select an empty pattern that contains no musical data.

- ☞ "Adjusting the Speed of Modulation (LFO1 Rate)" (p. 72)
- ☞ "Adding an Echo to the Sound (Delay)" (p. 103)
- ☞ "Applying Various Effects to the Sound (Multi-Effects)" (p. 106)
- ☞ "Synchronization Settings (Sync Mode)" (p. 167)

## Controlling an External MIDI Device from the JX-305

Although it is fully enjoyable to play the JX-305 by itself, even more interesting uses become possible when it is used to control other MIDI devices as well.

### Playing a sampler from the JX-305

By using the JX-305 in conjunction with a digital sampler such as the SP-202 (sold separately), samples such as human voice or sound effects that were recorded on the sampler can be played from the keyboard of the JX-305. Or, you can create patterns that use both JX-305 sounds and sampled sounds, for more variation. Here we will give an example showing how part 1 of the JX-305 can control the SP-202.

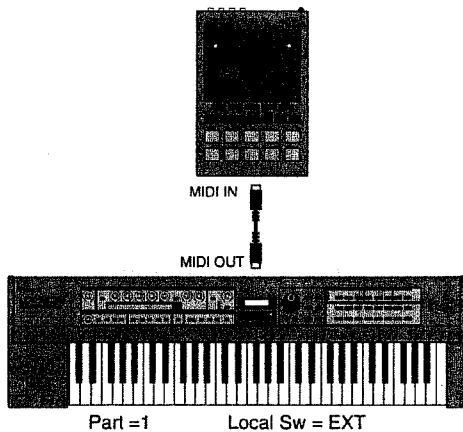

1. Set the MIDI channel of the SP-202 to "1."
2. Set the Local Switch of the JX-305 to "EXT" (p. 165).
3. Select part 1 as the current part, and play the keyboard.

The sampled sounds of each pad of the SP-202 will sound.

While you play back a pattern, try playing samples as well. Even after switching patterns, you can still control the SP-202 from part 1.

\* The notes C2–G4 of the JX-305 can be used to play the SP-202. Playing notes outside this range will not make the SP-202 sound.

Next, let's record musical data on the JX-305 that will play the SP-202, and create a pattern that will add SP-202 sampled sounds to the performance of the JX-305.

1. Select the pattern to which you want to add SP-202 sampled sounds.

For this example as well, we will record the musical

data for the SP-202 on part 1. If musical data has already been recorded on part 1, erase that data before you begin.

"Erasing Unwanted Data (Erase)" (p. 141)

2. Set the Sequencer Output Assign setting of the JX-305's part 1 to "EXT" (p. 36).
3. Record the musical data for the SP-202 onto part 1.

It is probably best to use real-time recording to record by playing the keyboard.

4. When you are finished recording, press [STOP/PLAY] to play back the pattern.

The SP-202 sampled sounds will play in addition to the sounds of the JX-305.

5. Use the Pattern Write operation to save the pattern (p. 36).

### Playing an External MIDI Sound Module from the JX-305

The same procedure can be used to control an external MIDI sound module or a digital sampler other than the SP-202.

In the following example, part 1 controls the external MIDI sound module, and part 7 controls the SP-202.

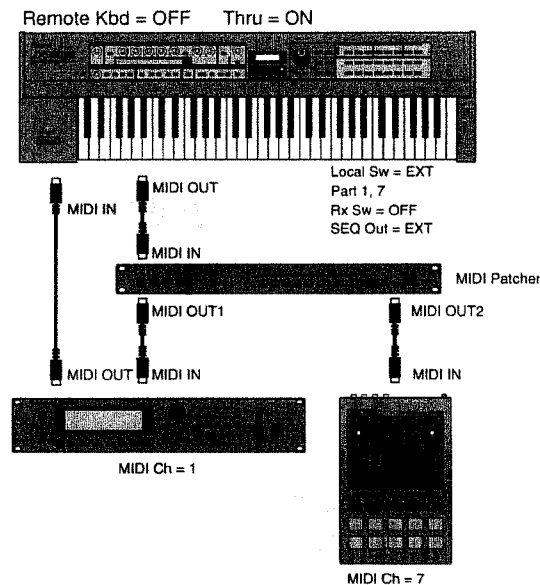

When the JX-305's current part is part 1 or part 7, you will be able to play the external MIDI sound module or the SP-202 from the keyboard.

When you record, the external MIDI sound module will be recorded on part 1, and the SP-202 on part 7.

If you wish to play the internal sound source of the JX-305, set the Local Switch to "INT" (p. 165).

### About MIDI patchers

When multiple external MIDI devices are connected in a "daisy-chain," there is a tendency for the signal to become corrupted and for transmission errors to occur as the signal is made to travel a greater distance. If you need to connect three or more devices, we recommend that you use a MIDI patcher (A-880: optional).

### Synchronizing an External Sequencer

By synchronizing an external MIDI sequencer to the MIDI Clock messages that are transmitted from the JX-305, you can synchronize the external sequencer to the JX-305.

The following example shows how an external MIDI sequencer can be synchronized with the JX-305's pattern playback. (The external MIDI sound module will be played by MIDI messages from the external MIDI sequencer.)

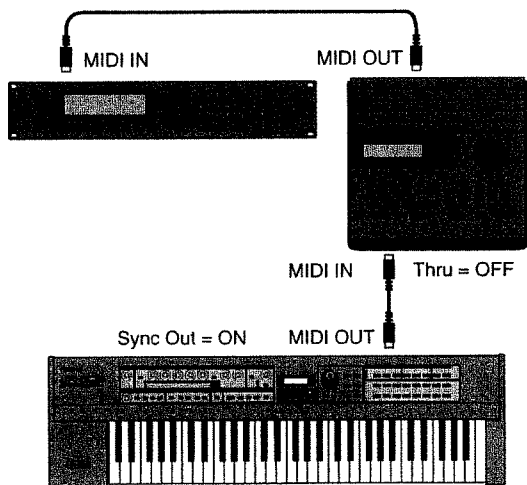

1. Press [MODE] to select Pattern mode.
2. Turn the Sync Out setting "ON" (p. 167).
3. Set the external MIDI sequencer so it will synchronize to the MIDI Clock messages that it receives. For details, refer to the owner's manual for your MIDI sequencer.
4. When you press [STOP/PLAY] on the JX-305, the JX-305's sequencer and the external MIDI sequencer will begin playback simultaneously.
5. To stop playback, press the JX-305's [STOP/PLAY].

If you are using the JX-305 in conjunction with a JP-8000 synthesizer (optional), you can synchronize the

JP-8000's arpeggios, patterns and motions to the JX-305. For details refer to the JP-8000 owner's manual section entitled "Synchronizing to External MIDI Devices" (p. 95).

### Synchronizing to an External Sequencer

The playback of the JX-305's sequencer can be synchronized to the MIDI Clock messages transmitted from an external MIDI sequencer or from a VS-880 hard disk recorder (optional).

In the following example, we will synchronize the JX-305 pattern playback to an external source of timing.

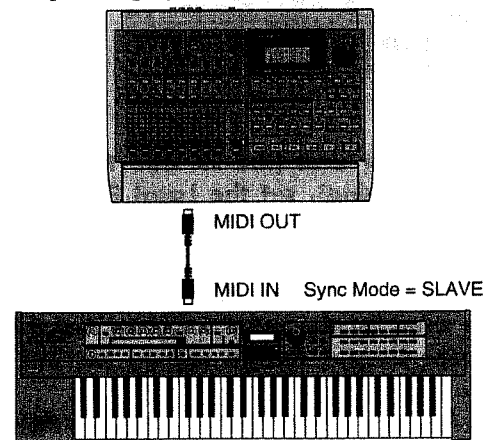

1. Press [MODE] to enter Pattern mode.
2. Set the Sync Mode setting to "SLAVE" (p. 167).
3. Make settings on your external MIDI sequencer so it will transmit MIDI Clock messages. For details on the setting, refer to the owner's manual for your external MIDI sequencer.
4. Return the JX-305 pattern to the beginning of measure 1.
5. Play back the external MIDI sequencer, and the JX-305's sequencer will begin playback simultaneously.
6. To stop playback, stop the external MIDI sequencer.

If you want only to control the pattern start/stop operations from the external MIDI sequencer without synchronizing to MIDI Clock messages from the external MIDI sequencer (so the tempo will be controlled by the JX-305 itself), set the Sync Mode to "REMOTE."

### Synchronized playback with two JX-305 units

Two JX-305 units can be connected to each other, and used to play different patterns in synchronization.

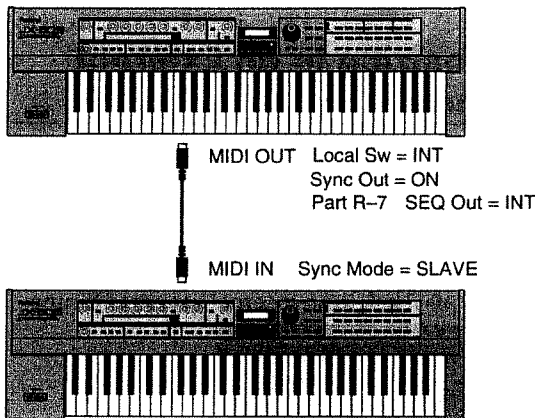

1. On the master unit (the JX-305 that will control the timing), set the Local Switch to "INT," and turn Sync Out "ON" (p. 165, 167).
2. For all parts (including MUTE CTRL) of the pattern used by the master device, set the Sequencer Output Assign setting to "INT" (p. 36).
3. On the slave unit (the JX-305 whose timing will be controlled), set the Sync Mode to "SLAVE" (p. 167).
4. Press [STOP/PLAY] on the master unit, and the two JX-305s will begin playback together.

During synchronized playback, operating the knobs, arpeggio or RPS on the master unit will not affect the slave unit.

5. To stop synchronized playback, press [STOP/PLAY] on the master unit.

You can use the same procedure to synchronize a JX-305 and an MC-505 or MC-303. In this case, use the MC-505 or MC-303 as the slave device, and set its Sync Mode setting to "SLAVE."

.....  
 If the two patterns being synchronized have a different time signature or a different number of measures, the performance will move apart even if synchronization is maintained. When synchronizing in this way, it is recommended that you use patterns that have the same time signature and number of measures.  
 .....

### Saving Pattern and Patch Data on an External Sequencer (Bulk Dump)

The JX-305 is able to transmit or receive data for the currently selected pattern or patch. This is referred to as "Bulk Dump." By using this function, you can save JX-305 data on an external MIDI sequencer that has a floppy disk, or exchange data between two JX-305 units.

#### Recording JX-305 Data on an External Sequencer

Use a MIDI cable to connect the JX-305's MIDI OUT to the external sequencer's MIDI IN.

1. Select the pattern that you wish to save.
2. Make sure that the pattern is stopped.
3. Press [UTILITY].  
The indicator will light.
4. Press PAGE [<] [>] several times to select "BULK DUMP," and press [ENTER].  
The Bulk Dump page will appear in the display.

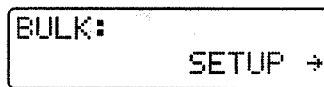

5. Press the PAGE [<] [>] to select the type of parameters that you wish to transmit and press [ENTER].

Range:  
 SETUP: Setup parameters for all parts of the currently selected pattern will be transmitted.  
 SETUP&PATCH: In addition to the contents transmitted by SETUP, data for the patches (rhythm set) of all parts of the currently selected pattern will be transmitted.  
 ALL: In addition to the contents transmitted by SETUP&PATCH, the musical data of the currently selected pattern will be transmitted.

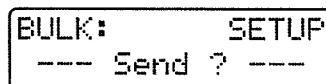

6. Start real-time recording on the external MIDI sequencer.

**7. Press [ENTER] on the JX-305.**

The following display will appear, and the bulk data will be transmitted from MIDI OUT.

```
Now Sending
Keep Power ON !
```

To halt data transmission, press [STOP/PLAY] or [EXIT].

When data transmission has been completed, the following display will appear, and then the normal display will reappear automatically.

```
BULK:      SETUP
Complete !
```

**8. Stop recording on the external MIDI sequencer, assign a name to the data that was recorded, and save it to floppy disk etc.**

**Restoring Data from a MIDI Sequencer to the JX-305**

When you wish to restore the bulk dump that was saved back to the JX-305, use the following procedure to send the bulk dump into the temporary pattern.

Use a MIDI cable to connect the JX-305's MIDI IN to the MIDI OUT of the external sequencer.

- 1. Select the temporary pattern (TMP).**
- 2. Make sure that the pattern is stopped.**
- 3. Press [UTILITY].**  
The indicator will light.
- 4. Press PAGE [<] [>] several times to select "BULK DUMP," and press [ENTER].**  
The Bulk Dump page will appear in the display.
- 5. Press PAGE [<] [>] several times to select "RECEIVE," and press [ENTER].**

The Bulk Dump Reception page will appear in the display.

```
BULK:      RECEIVE
-- Waiting --
```

**6. Operate the external MIDI sequencer to load and play back the bulk dump that you wish to restore.**

While the bulk dump is being loaded to the JX-305, the following display will appear.

```
Now Receiving
Keep Power ON !
```

When loading has been completed, the Receive page will reappear.

**7. Press [EXIT] to return to the normal display.**

The temporary area will contain the setup, patch and pattern data that was loaded.

**8. After verifying that the data was loaded correctly, save the patch and pattern data on the JX-305.**

After SETUP data has been received, use the Pattern Write operation to save the setup to user pattern memory.

After SETUP&PATCH or ALL data has been received, first use the Patch Write operation to save the patches of all parts to vacant user patches. Then use the Pattern Write operation to save the setup and musical data as a user pattern.

## Example of Real-Time Modify

In this section we will explain how the sound will change when you move the various Realtime Modify knobs, using a suitable preset patch.

### Filter Envelope

The filter envelope is used to modify the way in which the brightness changes over time (p. 63).

1. Press [FILTER/AMP/PITCH] several times to make the FILTER indicator light.
2. Press [ENVELOPE/LFO1/EFFECTS] several times to make the ENVELOPE indicator light.
3. Select patch P:B61.

The filter envelope parameters of patch P:B61 are set as follows.

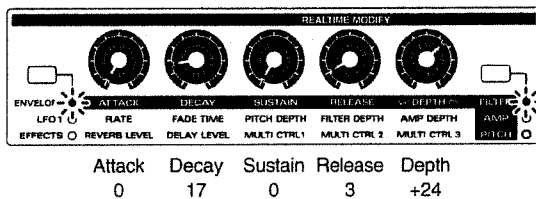

4. Rotate the [DECAY] knob within the range depicted in the illustration.

As you rotate the [DECAY] knob clockwise, the change in brightness will take place over a longer time.



5. Rotate the [DEPTH] knob within the range depicted in the illustration.

As you rotate the [DEPTH] knob clockwise, the change in brightness will become greater, and the sound will become brighter.

\* If the [DEPTH] knob is in the center position, the amount of change in brightness will be "0," and there will be no sound.

14



6. Rotate the [ATTACK] knob within the range depicted in the illustration.

As you rotate the [ATTACK] knob clockwise, the time over which the brightness increases will become longer.



### Amplifier Envelope

The amplifier envelope is used to create time-varying changes in volume (p. 68).

1. Press [FILTER/AMP/PITCH] several times to make the AMP indicator light.
2. Press [ENVELOPE/LFO1/EFFECTS] several times to make the ENVELOPE indicator light.
3. Select patch P:B22.

The amplifier envelope parameters of patch P:B22 are set as follows.

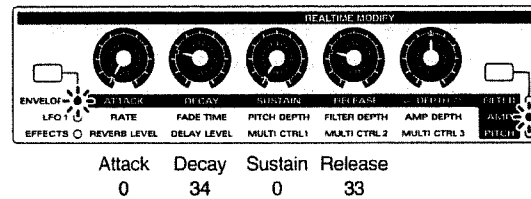

4. Rotate the [DECAY] knob within the range depicted in the illustration.

As you rotate the [DECAY] knob clockwise, the time over which the volume decays will become longer.



5. Rotate the [ATTACK] knob within the range depicted in the illustration.

As you rotate the [ATTACK] knob clockwise, the attack of the sound will become slower.



6. Rotate the [RELEASE] knob within the range depicted in the illustration.

As you rotate the [RELEASE] knob clockwise, the time from when you release the note until the sound disappears will become longer.



## Pitch Envelope

The pitch envelope is used to create time-varying change in pitch (p. 58).

1. Press **[FILTER/AMP/PITCH]** several times to make the **PITCH** indicator light.
2. Press **[ENVELOPE/LFO1/EFFECTS]** several times to make the **ENVELOPE** indicator light.
3. Select patch **P:F24**.

The pitch envelope parameters of patch P:F24 are set as follows.

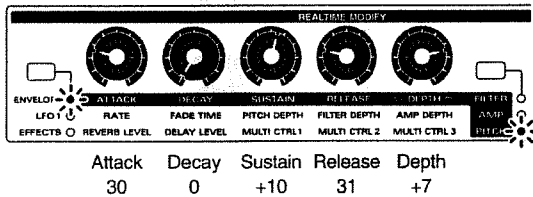

4. Rotate the **[DEPTH]** knob within the range depicted in the illustration.

As you rotate the **[DEPTH]** knob toward the right of center, the change will increase, and the pitch will become higher. Rotating the knob toward the left of center will invert the waveform, and as the knob is rotated further toward the left the change will increase, and the pitch will become lower.

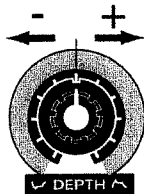

5. Rotate the **[ATTACK]** knob within the range depicted in the illustration.

As you rotate the **[ATTACK]** knob clockwise, the pitch change will occur more slowly.



## LFO1

LFO1 is used to add cyclic change to the sound (p. 71).

1. Press **[ENVELOPE/LFO1/EFFECTS]** several times to make the **LFO1** indicator light.
2. Select patch **P:G72**.

The LFO1 parameters of patch P:G72 are set as follows.

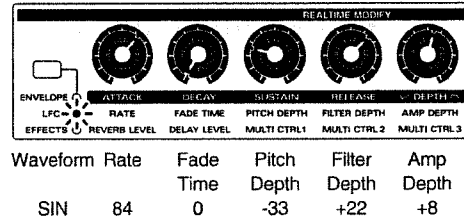

3. Rotate the **[RATE]** knob within the range depicted in the illustration.

As you rotate the **[RATE]** knob clockwise, the sound will be modulated more rapidly.



4. Rotate the **[PITCH DEPTH]** knob within the range depicted in the illustration.

Moving the **[PITCH DEPTH]** knob will increase/decrease the modulation of the sound.

\* When the **[PITCH DEPTH]** knob is in the center position, the sound will not be modulated at all.



5. Hold down **[ENVELOPE/LFO1/EFFECTS]** and use **[INC]** **[DEC]** or the **[VALUE]** dial to select the **LFO1** waveform.

This will change the way in which the sound is modulated.

Try out various waveforms.

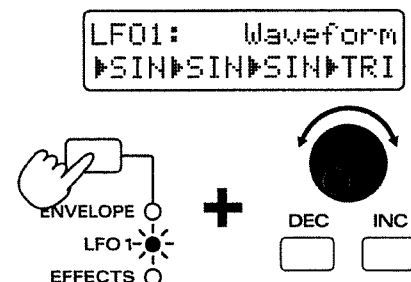

## Example of Multi-Effects Settings

### Producing a Muffled Tonal Character

By severely cutting the mid-range and boosting the low range, you can simulate a muffled sound, as if it were heard from the next room.

Apply to parts: all parts

MULTI:  
Type ▶ SPECTRUM

MULTI: SPECTRUM  
Low-High ▶ +15

MULTI: SPECTRUM  
Middle Gain ▶ -15

MULTI: SPECTRUM  
Width ▶ 1

MULTI: SPECTRUM  
Output Pan ▶ 0

MULTI: SPECTRUM  
Output Level ▶ 100

#### SPECTRUM



### Using Spectrum to Create a Lo-Fi Sound

In the opposite of the previous example, here we cut the high and low range and boost only the mid-range. This is effective when applied to rhythm or bass. You can also accentuate the effect by using the part mixer Key Shift to slightly lower the pitch of the rhythm part.

Apply to parts: all parts

MULTI:  
Type ▶ SPECTRUM

MULTI: SPECTRUM  
Low-High ▶ -15

MULTI: SPECTRUM  
Middle Gain ▶ +13

MULTI: SPECTRUM  
Width ▶ 1

MULTI: SPECTRUM  
Output Pan ▶ 0

MULTI: SPECTRUM  
Output Level ▶ 127

#### SPECTRUM



### Hardening the Overall Character

Use an Enhancer to sharpen the definition of the sound, bringing it to the front. This is effective when applied to brass-type sounds or piano-type sounds.

Apply to parts: all parts

MULTI:  
Type ▶ ENHANCER

MULTI: ENHANCER  
Sens ▶ 127

MULTI: ENHANCER  
Mix ▶ 85

MULTI: ENHANCER  
Low Gain ▶ +7

MULTI: ENHANCER  
High Gain ▶ +7

MULTI: ENHANCER  
Output Level ▶ 65

#### ENHANCER



### Distorted TB-303 Type Sounds

This is effective when applied to a patch such as P:A18.

MULTI:  
Type ▶ OVERDRIVE

MULTI: OVERDRIVE  
Input Level ▶ 100

MULTI: OVERDRIVE  
Drive ▶ 100

MULTI: OVERDRIVE  
AMP Type ▶ 3STACK

MULTI: OVERDRIVE  
Output Pan ▶ 0

MULTI: OVERDRIVE  
Output Level ▶ 90

#### OVERDRIVE







## Low-resolution Sampler Sound

Here's a simulation of the sound of an early sampler with a low sampling rate. This is effective when applied to rhythm.

It will sound more like the real thing if you apply no reverb or delay.



Apply to parts: rhythm part, bass part

MULTI: Type ▶ Lo-Fi	<b>Lo-Fi</b>  MULTI CTRL1 Bit Down  MULTI CTRL2 S-Rate Down  MULTI CTRL3 Output Level
MULTI: Lo-Fi Bit Down ▶ 4	
MULTI: Lo-Fi S-Rate Down ▶ 8	
MULTI: Lo-Fi Post Gain ▶ +6	
MULTI: Lo-Fi Low Gain ▶ +5	
MULTI: Lo-Fi High Gain ▶ -9	
MULTI: Lo-Fi Output ▶ MONO	
MULTI: Lo-Fi Output Level ▶ 127	

## Radio Simulation

This sounds like it's being heard from a small radio. While playing back a pattern, rotate the [MULTI CTRL 1] knob (Radio Detune) slowly left and right.





Apply to parts: all parts

MULTI: Type ▶ RADIO-TUNG	<b>RADIO-TUNG</b>  MULTI CTRL1 Radio-Detune  MULTI CTRL2 Noise Level  MULTI CTRL3 Output Level
MULTI: RADIO-TUNG Radio Detune ▶ 52	
MULTI: RADIO-TUNG Noise Level ▶ 50	
MULTI: RADIO-TUNG Low Gain ▶ -6	
MULTI: RADIO-TUNG High Gain ▶ -6	
MULTI: RADIO-TUNG Output ▶ MONO	
MULTI: RADIO-TUNG Output Level ▶ 100	

## Modifying the Groove of a Pattern

Use the Slicer to modify the groove of the entire pattern. While playing back pattern P:A11, you can also rotate the [MULTI CTRL 1] knob to modify the Timing PTN.



Apply to parts: all parts except the rhythm part

MULTI: Type ▶ SLICER	<b>SLICER</b>  MULTI CTRL1 Timing PTN  MULTI CTRL2 Accent PTN  MULTI CTRL3 Output Level
MULTI: SLICER O _ _ _ O _ _ _ O _ _ _	
MULTI: SLICER Timing PTN Rate ▶ J	
MULTI: SLICER Accent PTN 	
MULTI: SLICER Accent Level ▶ 127	
MULTI: SLICER Attack ▶ 5	
MULTI: SLICER Output Level ▶ 127	

## Jet Sound

This is a simulation of a jet airplane.

This will sound more like the real thing when applied to a white-noise type patch such as P:E13.

MULTI: Type ▶ FLANGER	<b>FLANGER</b>  MULTI CTRL1 Depth  MULTI CTRL2 Rate  MULTI CTRL3 Output Level
MULTI: FLANGER Pre Delay ▶ 1.0	
MULTI: FLANGER Rate ▶ 0.7	
MULTI: FLANGER Depth ▶ 127	
MULTI: FLANGER Feedback ▶ 0	
MULTI: FLANGER Phase ▶ 0	
MULTI: FLANGER Filter Type ▶ OFF	
MULTI: FLANGER Cutoff ▶ 3000	
MULTI: FLANGER Balance ▶ D50:50E	
MULTI: FLANGER Output Level ▶ 127	

## Auto Panning Delay Sound

Since this uses the Auto Pan of short delay, the location of the delay sound will move at one-measure intervals. The effect will be more obvious if you turn off the conventional reverb and delay.

MULTI:  
Type ▶ SHORT-DELY

MULTI:SHORT-DELY  
Time L ▶ 90

MULTI:SHORT-DELY  
Time R ▶ 180

MULTI:SHORT-DELY  
HF Damp ▶ 4000

MULTI:SHORT-DELY  
Feedback ▶ +60

MULTI:SHORT-DELY  
Auto Pan ▶ 2MES

MULTI:SHORT-DELY  
Low Gain ▶ 0

MULTI:SHORT-DELY  
High Gain ▶ 0

MULTI:SHORT-DELY  
Balance ▶ D50:50E

MULTI:SHORT-DELY  
Output Level ▶ 127

### SHORT-DELY

MULTI CTRL1  
Time-L

MULTI CTRL2  
Time-R

MULTI CTRL3  
Output Level

## Auto Panning Drums

This will pan the rhythm tone to left and right during playback. Try it out on a pattern where the hi-hat marks the 16th notes, etc. The effect will be more obvious if you turn off the conventional reverb and delay.

Apply to parts: rhythm part

MULTI:  
Type ▶ AUTO-PAN

MULTI: AUTO-PAN  
LFO Type ▶ SQR

MULTI: AUTO-PAN  
Rate ▶ J

MULTI: AUTO-PAN  
Bass Sens ▶ OFF

MULTI: AUTO-PAN  
Depth ▶ 110

MULTI: AUTO-PAN  
Low Gain ▶ -3

MULTI: AUTO-PAN  
High Gain ▶ +2

MULTI: AUTO-PAN  
Output Level ▶ 100

### AUTO-PAN

MULTI CTRL1  
Depth

MULTI CTRL2  
Rate

MULTI CTRL3  
Output Level

## Reverse Playback Sound

This uses Gate Reverb to create a reverse-playback effect. You can adjust the [MULTI CTRL 2] knob (Balance) to control the proportion of the normal sound and the reverse sound.

Apply to parts: rhythm part

MULTI:  
Type ▶ GATE-REVRB

MULTI:GATE-REVRB  
Gate Type ▶ REVRSE

MULTI:GATE-REVRB  
Gate Time ▶ 100

MULTI:GATE-REVRB  
Balance ▶ D0:100E

MULTI:GATE-REVRB  
Output Level ▶ 127

### GATE-REVRB

MULTI CTRL1  
Gate Time

MULTI CTRL2  
Balance

MULTI CTRL3  
Output Level

# Troubleshooting

If there is no sound, or if the instrument does not function as you expect, first check the following points. If this does not resolve the problem, contact your dealer or the nearest Roland Service Center.

*\* Roland shall bear no responsibility whatsoever with regard to any loss of memory contents, or any consequent damages, whether direct or indirect.*

## Problem

---

- : Reason

☞ : Action

## No Sound

---

- The power of the JX-305 or connected devices is not turned on.

☞ Turn on the power (Quick Start; p. 5).

- The volume of the JX-305 or connected device is turned down.

☞ Raise the volume (Quick Start; p. 5).

- MIDI cables and/or audio cables are not connected correctly.

☞ Make the correct connections (Quick Start; p. 3).

- The Part Level of the corresponding part is lowered.

☞ Use the part mixer to raise the Part Level (p. 33).

- All tones of the patch are turned off.

☞ Turn each tone on (p. 55).

- The patch parameter settings are not appropriate.

☞ Raise the Sustain Level of the A-ENV parameter (p. 68).

☞ Raise the Cutoff Frequency of the FILTER parameter (p. 62).

☞ Raise the Tone Level of the AMPLIFIER-LEVEL parameter (p. 67).

☞ Raise the Rate of the LFO1/2 parameter (p. 72).

- The pitch of the patch has exceeded the range in which it can be sounded normally.

☞ Use Octave Shift to lower (raise) the range being played (p. 21).

- The Local Switch is set to "EXT."

☞ Set it to "INT" or "BOTH" (p. 165).

- The Rx Switch of the corresponding part is set to "OFF."

☞ Turn it "ON" (p. 165).

- The receive channel setting of the corresponding part does not match the MIDI channel of the messages that are being transmitted from the external MIDI device.

☞ Set the MIDI channel of the messages being transmitted to match the receive channel of each part (p.171).

- The Sequencer Output Assign setting of the corresponding part is set to "EXT."

☞ Set it to "INT" or "BOTH" (p. 36).

- The Keyboard Velocity setting is too low.

☞ Raise the Keyboard Velocity setting (p. 163).

- The Bank Select and Program Change messages transmitted from an external device have the wrong values.

☞ Transmit the correct Bank Select and Program Change messages (p. 190, 194).

## Notes Drop Out

---

- You are attempting to play more than 64 notes simultaneously (p. 14).

☞ Reduce the number of notes that are played simultaneously.

☞ Reduce the number of notes in the pattern being played.

☞ Increase the Voice Reserve setting for parts that must not drop out (p. 169).

## When You Play the Keyboard, Notes Do Not Stop

---

- The pedal polarity of the Hold Pedal is reversed.

☞ Make the correct Hold Pedal Polarity setting (p. 163).

## Notes Are "Stuck" During Pattern Playback

---

- A Hold Off message was deleted by pattern editing etc.

☞ Use the Microscope page to insert a Hold Off message (p. 150).

CC#64 (HOLD1) Value=0

---

## Sequencer Does Not Function (Pattern Playback, RPS Playback, etc.)

---

- The Sync Mode is set to "SLAVE."
- ☞ Set the Sync Mode to "INT" (p. 167).  
If nothing happens if you press [STOP/PLAY] when the [STOP/PLAY] indicator is lit, turn the power off and on again, and set Sync Mode to "INT."

---

## Reverb/Delay/Multi-Effects Do Not Apply

---

- Reverb/Delay/Multi-Effects are turned off.  
☞ Turn Reverb/Delay/Multi-Effects on (p. 101).
- The Reverb Level setting and the Part Reverb Level settings of each part are set to "0."  
☞ Increase the settings (p. 102).
- The Delay Level setting and the Part Delay Level settings of each part are set to "0."  
☞ Increase the settings (p. 104).
- The Multi-Effects Output Level is "0." Part Multi-Effects Switch of each part are not set to "ON."  
☞ Increase the Multi-Effects Output Level. Set Part Multi-Effects Switch to "ON" (p. 106, 124).
- The Rhythm Tone Reverb Level or Rhythm Tone Delay Level of each note of the rhythm set you are using is set to "0." Rhythm Tone Multi-Effects Switch for each note is not set to "ON."  
☞ Increase the Rhythm Tone Reverb Level and the Rhythm Tone Delay Level of each note. Set Rhythm Tone Multi-Effects Switch to "ON" (p. 97, 98).

---

## Pitch Is Incorrect

---

- The tuning of the JX-305 or of the external MIDI sound generator is incorrect.  
☞ Check the tuning setting (p. 168).

---

## The Pitch Has Been Changed by a Pitch Bend Message That Was Transmitted from the Sequencer or from an External MIDI Device.

---

- ☞ Perform A MIDI Update (p. 40).

---

## Play Quantize Does Not Apply

---

- Either the Strength setting is at 0%, or the Shuffle Rate setting is at 50%.  
☞ Set an appropriate value for the Strength or Shuffle Rate (p. 41, 42, 45).
- [QTZ SELECT] has not been used to specify the part(s) to which Play Quantize will be applied.  
☞ Specify the parts to which Play Quantize will be applied (p. 41).

---

## During Real-Time Recording, the Display Indicates PTN Rec Full

---

- An excessive amount of aftertouch data is being transmitted.  
☞ Lower the Aftertouch Sensitivity setting (p. 163).

---

## Cannot Select a Copy Destination Part for a Pattern Copy

---

- More than one part is selected as the copy source part (including [MUTE CTRL] part).  
☞ Make sure only one part is selected as the copy source part (p. 138).

---

## Notes Are Delayed or Unsteady During Playback

---

- If you create a pattern that contains an extremely large amount of data, or if you input an excessive amount of knob data, notes may be delayed or unsteady during playback. This problem can also occur if the tempo is speeded up excessively.  
☞ Delete unneeded note data or knob data. Use Data Thin to thin out knob data (p. 145).
- ☞ Use Move Event to move notes that were input at the same location as chords, so that they are staggered by 1 clock (p. 151).
- ☞ Use Shift Clock to move data of parts other than the rhythm part backward by 1 clock (p. 144).

# Error Message List

If an incorrect operation has been performed or if processing could not be carried out as specified, an error message will appear. Refer to this list and take the appropriate action.

## CAUTION ! MIDI Off Line

- There is a problem with the MIDI cable connections.
- ☞ Make sure that MIDI cables have not been pulled out or broken (Quick Start; p. 3).

## CAUTION ! MIDI Buffer Full

- More MIDI messages were received at once than the JX-305 was able to process.
- ☞ Reduce the amount of MIDI messages that are being transmitted to the JX-305.

## CAUTION ! Rec Overflow

- More recording data was received at once than the JX-305 was able to process.
- ☞ Reduce the amount of recording data that is being transmitted to the JX-305.

## CAUTION ! Checksum Error

- The checksum value of the received system exclusive message is incorrect.
- ☞ Correct the checksum value.

## CAUTION ! PTN Rec Full

- Since the maximum number of notes that can be recorded in a single pattern has been reached, further pattern recording is not possible.
- ☞ Delete unneeded data from the pattern that you are recording (p. 141).

## CAUTION ! Song Rec Full

- Since the maximum number of patterns that can be registered in a single song has been reached, further song recording is not possible.
- ☞ A maximum of 50 patterns can be registered in a single song. No further patterns can be registered.

## CAUTION ! User Memory Full

- Since there is insufficient user memory, the pattern cannot be saved.
- ☞ Either initialize an unneeded pattern, or save the data to a memory card.

## CAUTION ! Card Memory Full

- Since there is insufficient card memory capacity, the pattern cannot be saved.
- ☞ Either initialize an unneeded pattern, or save the data to internal memory.

## CAUTION ! Beat Differs

- Since a different time signature is set for the copy source and copy destination patterns, the pattern copy is not possible.
- ☞ The pattern copy operation can only be used for patterns with the same time signature.

## CAUTION ! Cannot Assign

- Since there are two or more un-muted parts, the phrase cannot be assigned to an RPS set.
- ☞ Decide on one part in the phrase that you wish to register, and mute all other parts (p. 49).
- The TMP pattern cannot be registered in a PTN SET.
- ☞ First save the pattern as a User pattern, and then register it in the PTN SET.

CAUTION !  
No QTZ Selected

- Quantize is not selected.
- ☞ Press [GRID/SHUFFLE/GROOVE] to select the quantization that you wish to use (p. 40).

CAUTION !  
Memory Protected

- Since a write protect sticker is affixed to the memory card, data cannot be saved to the card bank.
- ☞ Remove the write protect sticker from the memory card (p. 159).

CAUTION !  
Empty Pattern

- Since the pattern contains no musical data, it cannot be played back or modified.

CAUTION !  
Cannot UNDO

- Cannot undo.

CAUTION !  
Wrong Card

- The card manufacturer/model is not specified for use with the JX-305.
- ☞ Use a specified card (p. 159).
- The card has not been formatted for the JX-305.
- ☞ Format the card (p. 159).
- It is possible that the contents of the card have been damaged.
- ☞ Format the card (p. 159).
- The card does not contain JX-305 data.
- ☞ Use a card that contains JX-305 data.

CAUTION !  
Card Not Ready

- No card is inserted.
- ☞ Turn off the power, and insert a card (p. 159).

CAUTION !  
Card Damaged

- There is a defective block in the copy destination card.
- ☞ The memory card has reached the end of its lifespan. Please purchase a new memory card.

CAUTION !  
Memory Damaged!

- It is possible that the contents of internal memory have been damaged.
- ☞ Try executing the Factory Preset operation (Quick Start, p. 6). If this does not resolve the problem, contact a nearby Roland service center.

CAUTION !  
Cannot Backup

- Since card memory is insufficient, it is not possible to create a backup file.
- ☞ Initialize unneeded patterns.

CAUTION !  
Not Src Card

- A card other than the copy source was inserted.
- ☞ Insert the copy source card (p. 161).

CAUTION !  
Not Dest Card

- A card other than the copy destination was inserted.
- ☞ Insert the copy destination card (p. 161).

CAUTION !  
Can't Initialize

- Since a Preset pattern is selected, it is not possible to initialize.

# Waveform List

## Group A

No	Name	No	Name	No	Name	No	Name	No	Name
001	TB Dst Saw	052	Ac Bass	103	Trumpet	154	Dist Hit	205	TR808 Tom
002	TB Dst Sqr 1	053	Voco Bass	104	Mute Trumpet	155	Thin Beef	206	TR606 Tom
003	TB Dst Sqr 2	054	Fingered Bs	105	Soprano Sax	156	Tekno Hit	207	TR606 CmpTom
004	TB Reso Sqr1	055	Pick Bass	106	Solo Sax	157	Back Hit	208	TR707 Tom
005	TB Reso Sqr2	056	Fretless Bs	107	Baritone Sax	158	TAO Hit	209	Syn Tom
006	TB Saw	057	Slap Bass	108	Brass Fall	159	Philly Hit	210	Deep Tom
007	TB SolidSaw1	058	Juno Rave	109	Flute	160	INDUST. MENU	211	Can Tom
008	TB SolidSaw2	059	Blaster	110	Pan Flute	161	Analog Bird	212	Kick Tom
009	TB Square 1	060	Fat JP-6	111	Shakuhachi	162	Retro UFO	213	Natural Tom
010	TB Square 2	061	OB Strings	112	Bagpipe	163	PC-2 Machine	214	PERCUS MENU1
011	TB Sqr Decay	062	Orch Strings	113	Breath	164	Hoo	215	PERCUS MENU2
012	TB Natural	063	Pizzy Techno	114	Feedbackwave	165	Metal Sweep	216	TR808 Conga
013	JP8000 Saw 1	064	Choir	115	Atmosphere	166	Afro Feet	217	HiBongo Open
014	JP8000 Saw 2	065	Syn Vox 1	116	Rezo Noise	167	Bomb	218	LoBongo Open
015	MG Saw	066	Syn Vox 2	117	MG White Nz	168	Bounce	219	HiConga Mute
016	Synth Saw 1	067	Syn Vox 3	118	P5 Noise	169	ElectricDunk	220	HiConga Open
017	JP-8 Saw	068	Ac Piano	119	MG Pink Nz	170	Iron Door	221	LoConga Open
018	P5 Saw	069	D-50 EP	120	Bomb Noise	171	Dist Swish	222	HiBongo LoFi
019	Synth Saw 2	070	E.Piano	121	Sea	172	Drill Hit	223	LoBongo LoFi
020	OB Saw	071	Clavi	122	Brush Noise	173	Thrill	224	HiCnga Mt LF
021	D-50 Saw	072	Full Stop	123	Space Noise	174	PCM Press	225	HiCnga Op LF
022	JP-6 Square	073	FM Club Org	124	Scream	175	Air Gun	226	LoConga LoFi
023	MG Square	074	E.Organ 1	125	Jet Plane	176	VOICE MENU	227	Timpani
024	P5 Square	075	E.Organ 2	126	Toy Gun 1	177	One!	228	Mute Surdo
025	JP-8 Pulse	076	Church Org	127	Crash	178	Two!	229	Open Surdo
026	JP-6 Pulse	077	Power B fst	128	Toy Gun 2	179	Three!	230	Hi Timbale
027	MG Pulse	078	Power B slw	129	Toy Gun 3	180	Kick it!	231	Lo Timbale
028	260 Pulse	079	Org Chord	130	Emergency	181	Come on!	232	HiTimbale LF
029	JU-2 Sub OSC	080	Tubular	131	Buzzer	182	Wao!	233	LoTimbale LF
030	Frog wave	081	Glockenspiel	132	Insect	183	Shout	234	Tabla
031	Digiwave	082	Vibraphone	133	Tonality	184	Ooh! 1	235	TablaBaya
032	FM Pulse	083	FantabellSub	134	Ring Osc	185	Ooh! 2	236	Udo
033	JP8000 PWM	084	DIGI Bell	135	Reso FX	186	Voice loop	237	AfroDrum Rat
034	JP8000 FBK	085	Steel Drum	136	SCRATCH MENU	187	Pa!	238	Chenchen
035	260 Sub OSC	086	Marimba	137	Vinyl Noise	188	Canvas	239	Op Pandeiro
036	Dist Synth	087	Balaphone	138	Scratch BD f	189	Punch	240	Mt Pandeiro
037	Dist Square	088	Kalimba	139	Scratch BD r	190	Chiki!	241	Tambourine 1
038	MG Triangle	089	Steel Gtr	140	Scratch SD f	191	Hey!	242	Tambourine 2
039	Jungle Bass	090	Clean TC	141	Scratch SD r	192	Laugh	243	Tambourine 3
040	260 Sine Bs	091	Dst Solo Gtr	142	Scratch ALT	193	Aah Formant	244	Tambourine 4
041	MC-202 Bass	092	Dist TekGtr	143	Tape Rewind	194	Eeh Formant	245	CR78 Tamb
042	SH-101 Bass	093	Gtr FX	144	Vinyl Stop	195	Iih Formant	246	COWBELL MENU
043	Octa Bass	094	Harmo Gtr	145	HIT MENU	196	Ooh Formant	247	TR808Cowbell
044	Funky Bass	095	Wah Gtr 1	146	MG Blip	197	Uuh Formant	248	TR707Cowbell
045	Poly Bass	096	Wah Gtr 2	147	Beam HIQ	198	Dist Ooh Vox	249	CR78 Cowbell
046	MG Bass	097	Wah Gtr 2a	148	MG Attack	199	Auh Voice	250	Cowbell
047	FM Super Bs	098	Wah Gtr 2b	149	Air Blip	200	Stream	251	TR727 Agogo
048	Solid Bass	099	Wah Gtr 2c	150	Org Click	201	Bird	252	CR78 Beat
049	Organ Bass	100	Wah Gtr 2d	151	Syn Hit	202	TOM MENU	253	Triangle 1
050	Dirty Bass	101	Sitar	152	Techno Scene	203	TR909 Tom	254	Triangle 2
051	Upright Bs	102	Brass	153	Techno Chord	204	TR909 DstTom		

**Group B**

No	Name	No	Name	No	Name	No	Name	No	Name
001	SHKR+MENU	052	R8 Brush CHH	103	TR707 Clap	154	Rap Snare	205	ElectroSnr 2
002	808 Maracas	053	Jungle Hat	104	Cheap Clap	155	Jungle Snr 1	206	Synth Snare
003	Maracas	054	PHH MENU	105	Funk Clap	156	Antigua Snr	207	Roll Snare
004	Cabasa Up	055	TR909 PHH 1	106	Little Clap	157	Real Snare	208	KICK MENU 1
005	TechnoShaker	056	TR909 PHH 2	107	Real Clap 1	158	Tiny Snare 1	209	KICK MENU 2
006	TR626 Shaker	057	TR808 PHH 1	108	Real Clap 2	159	Tiny Snare 2	210	KICK MENU 3
007	Dance Shaker	058	TR808 PHH 2	109	Funky Clap	160	Break Snare1	211	TR909 Kick 1
008	CR78 Guiro	059	TR606 PHH 1	110	Comp Clap	161	Break Snare2	212	TR909 Kick 2
009	Long Guiro	060	TR606 PHH 2	111	Hip Clap	162	MC Snare	213	TR909 Kick 3
010	Short Guiro	061	TR707 PHH	112	Down Clap	163	East Snare	214	TR909 Kick 4
011	Mute Cuica	062	Hip PHH	113	Group Clap	164	Phat Snare	215	Plastic BD 1
012	Open Cuica	063	Tight PHH	114	Big Clap	165	Brush Slap 1	216	Plastic BD 2
013	Whistle	064	Pedal Hat 1	115	Claptail	166	Brush Slap 2	217	Plastic BD 3
014	TR727Quijada	065	Real PHH	116	Clap Snare 1	167	Deep Snare	218	Plastic BD 4
015	Jingle Bell	066	Pedal Hat 2	117	Fuzzy Clap	168	Fat Snare	219	TR909 Kick 5
016	Belltree	067	OHH MENU 1	118	Snap	169	Disco Snare	220	TR808 Kick 1
017	Wind Chime	068	OHH MENU 2	119	Finger Snap	170	DJ Snare	221	TR808 Kick 2
018	RIM MENU	069	TR909 OHH 1	120	SNR MENU 1	171	Macho Snare	222	TR808 Kick 3
019	TR909 Rim	070	TR909 OHH 2	121	SNR MENU 2	172	Hash Snare	223	TR808 Kick 4
020	TR808 Rim	071	TR909 OHH 3	122	SNR MENU 3	173	Lo-Hard Snr	224	TR808 Kick 5
021	TR808 RimLng	072	TR909 DstOHH	123	SNR MENU 4	174	Indus Snare	225	TR606 Kick
022	TR707 Rim	073	TR808 OHH 1	124	SNR MENU 5	175	Rage Snare	226	TR606 Dst BD
023	Analog Rim	074	TR808 OHH 2	125	SNR MENU 6	176	TekRok Snare	227	TR707 Kick 1
024	Natural Rim	075	TR606 OHH	126	TR909 Snr 1	177	Big Trash SD	228	TR707 Kick 2
025	Ragga Rim 1	076	TR606 DstOHH	127	TR909 Snr 2	178	Ragga Rim 2	229	Toy Kick
026	Lo-Fi Rim	077	TR707 OHH	128	TR909 Snr 3	179	Gate Rim	230	Analog Kick
027	Wood Block	078	CR78 OHH	129	TR909 Snr 4	180	SideStiker	231	Boost Kick
028	Jungle Snap	079	Hip OHH	130	TR909 Snr 5	181	HipJazz Snr	232	West Kick
029	TR808 Claves	080	Pop Hat Open	131	TR909 Snr 6	182	HH Soul Snr	233	JungleKick 1
030	Hyoshigi	081	Open Hat	132	TR909 Snr 7	183	Cross Snare	234	Optic Kick
031	CHH MENU 1	082	Cym OHH	133	TR909 DstSnr	184	Jungle Rim 1	235	Wet Kick
032	CHH MENU 2	083	DR550 OHH	134	TR808 Snr 1	185	Ragga Snr 2	236	Lo-Fi Kick 1
033	TR909 CHH 1	084	Funk OHH	135	TR808 Snr 2	186	Upper Snare	237	Hazy Kick
034	TR909 CHH 2	085	Real OHH	136	TR808 Snr 3	187	Lo-Fi Snare	238	Hip Kick
035	TR808 CHH 1	086	R8 OHH	137	TR808 Snr 4	188	RaggaTightSD	239	Video Kick
036	TR808 CHH 2	087	CYMBAL MENU	138	TR808 Snr 5	189	Flange Snr	240	Tight Kick
037	TR808 CHH 3	088	TR606 Cym 1	139	TR808 Snr 6	190	Machine Snr	241	Break Kick
038	TR606 CHH 1	089	TR606 Cym 2	140	TR808 Snr 7	191	Clap Snare 3	242	Turbo Kick
039	TR606 CHH 2	090	TR909 Ride	141	TR808 Snr 8	192	Solid Snare	243	Ele Kick
040	TR606 DstCHH	091	TR707 Ride	142	TR808 Snr 9	193	Funk Clap 2	244	Dance Kick 1
041	TR707 CHH	092	Natural Ride	143	TR606 Snr 1	194	Jungle Rim 2	245	Kick Ghost
042	CR78 CHH	093	Cup Cym	144	TR606 Snr 2	195	Jungle Rim 3	246	Lo-Fi Kick 2
043	DR55 CHH 1	094	TR909 Crash	145	TR606 Snr 3	196	Jungle Snr 2	247	JungleKick 2
044	Closed Hat	095	NaturalCrash	146	DanceHall SD	197	Urban Snare	248	TR909 Dst BD
045	Pop CHH	096	Jungle Crash	147	TR707 Snare	198	Urban RollSD	249	Amsterdam BD
046	Real CHH	097	Asian Gong	148	CR78 Snare	199	R&B Snare	250	Gabba Kick
047	Bristol CHH	098	CLAP MENU 1	149	Clap Snare 2	200	R8 Brush Tap	251	Roll Kick
048	DR550 CHH 2	099	CLAP MENU 2	150	Jngl Tiny SD	201	R8 BrshSwill		
049	Tight CHH	100	TR909 Clap 1	151	Jazz Snare	202	R8 BrushRoll		
050	Hip CHH	101	TR909 Clap 2	152	Headz Snare	203	Sim Snare		
051	Room CHH	102	TR808 Clap	153	Whack Snare	204	ElectroSnr 1		



---

**Group C**

<b>No</b>	<b>Name</b>	<b>No</b>	<b>Name</b>	<b>No</b>	<b>Name</b>
001	Violin A	052	Gtr Harm A	103	Taiko
002	Violin B	053	Gtr Harm B	104	Tang Gu Mute
003	Violin C	054	Gtr Harm C	105	Tang Gu Open
004	Cello A	055	Pop Strat A	106	Dholak Hi Op
005	Cello B	056	Pop Strat B	107	Dholak Hi Mt
006	Cello C	057	Pop Strat C	108	Dholak Lo Mt
007	Multi Str A	058	Gt.FretNoise	109	Dholak Lo Op
008	Multi Str B	059	Gtr FX MENU	110	Tabla Hi Op
009	Multi Str C	060	Sitar 2 A	111	Tabla Hi Mt
010	Multi Str Lp	061	Sitar 2 B	112	Tabla Lo Op
011	Str Attack	062	Sitar 2 C	113	Tabla Lo Mt
012	GrandPiano A	063	Sitar Drone	114	Xiao Bo
013	GrandPiano B	064	Santur A	115	Nao Bo
014	GrandPiano C	065	Santur B	116	China Cym
015	Suitcase p A	066	Santur C	117	Hu Yin Luo
016	Suitcase p B	067	Shamisen A	118	Bend Gong
017	Suitcase p C	068	Shamisen B	119	Piccolo Snr
018	Suitcase mfA	069	Shamisen C	120	Ballad Snr
019	Suitcase mfB	070	Koto A	121	Solo Snare
020	Suitcase mfC	071	Koto B	122	Brush Slap 3
021	Suitcase f A	072	Koto C	123	Brush Swish
022	Suitcase f B	073	Harp A	124	Old Kick
023	Suitcase f C	074	Harp B	125	Hybrid Kick
024	Harpsi A	075	Harp C	126	TAIKO MENU
025	Harpsi B	076	D-50 Brass A	127	DHOLAK MENU
026	Harpsi C	077	D-50 Brass B	128	TABLA MENU
027	Clavi 2 A	078	D-50 Brass C	129	CHINA MENU
028	Clavi 2 B	079	D-50 BrassLp	130	SNR MENU 7
029	Clavi 2 C	080	Solo Tpt A	131	KICK MENU 4
030	Rotary Org A	081	Solo Tpt B		
031	Rotary Org B	082	Solo Tpt C		
032	Rotary Org C	083	Trombone A		
033	TheaterOrg A	084	Trombone B		
034	TheaterOrg B	085	Trombone C		
035	TheaterOrg C	086	Tuba A		
036	F.AccordionA	087	Tuba B		
037	F.AccordionB	088	Tuba C		
038	F.AccordionC	089	FrenchHorn A		
039	Bandoneon A	090	FrenchHorn B		
040	Bandoneon B	091	FrenchHorn C		
041	Bandoneon C	092	Blow Sax A		
042	Harmonica A	093	Blow Sax B		
043	Harmonica B	094	Blow Sax C		
044	Harmonica C	095	Oboe A		
045	Celesta A	096	Oboe B		
046	Celesta B	097	Oboe C		
047	Celesta C	098	Clarinet A		
048	Nylon Gtr A	099	Clarinet B		
049	Nylon Gtr B	100	Clarinet C		
050	Nylon Gtr C	101	Timpani Big		
051	Mute Gtr	102	Shimedaiko		

# Preset Patch List

## Preset A&B (CC#0=81, CC#32=0)

No. (PC#) Name	No. (PC#) Name	No. (PC#) Name	No. (PC#) Name
A11 (001) Lead TB 1	A51 (033) Lucky	B11 (065) Dist Lead 3	B51 (097) Def Bass 2
A12 (002) Dist TB 1	A52 (034) Synth Lead 1	B12 (066) Mosquito	B52 (098) Sine Bass 1
A13 (003) Dist Sqr TB	A53 (035) Moon Lead	B13 (067) Phazyn Vox	B53 (099) Sine Bass 2
A14 (004) Dist TB 2	A54 (036) Rezo SynLead	B14 (068) Voc Saw	B54 (100) RollModRezBs
A15 (005) Dist TB 3	A55 (037) Wspy Synth	B15 (069) VT Vox	B55 (101) Gate Me Buzz
A16 (006) TB + Voco	A56 (038) Enorjizor	B16 (070) Pure Voice	B56 (102) System Bass
A17 (007) Dist TB 4	A57 (039) JP8 Sprang	B17 (071) Robo Vox	B57 (103) Spike Bass
A18 (008) Lead TB 2	A58 (040) PortaSynLead	B18 (072) Hallucinate	B58 (104) Solid Goa
A21 (009) Devil TB	A61 (041) Wah Lead	B21 (073) Seq.Synth	B61 (105) Rezo Bass
A22 (010) Dual TB	A62 (042) Beep Mod	B22 (074) Analog Seq	B62 (106) Blip Bass
A23 (011) HiLo303ModSw	A63 (043) Dist Lead 1	B23 (075) Ana Punch	B63 (107) Pizz Bass
A24 (012) Arpness TB	A64 (044) Freaky Fry	B24 (076) Atom Brain	B64 (108) Voco Bass
A25 (013) Acid Line	A65 (045) JU2 SubOsc 1	B25 (077) Fooled MC	B65 (109) VoCoRoBo
A26 (014) Dist TB 5	A66 (046) JU2 SubOsc 2	B26 (078) 101 Bass 1	B66 (110) Dust Bass
A27 (015) Lead TB 3	A67 (047) Froggy	B27 (079) House Bass	B67 (111) ArtCoré Bass
A28 (016) Lead TB 4	A68 (048) Synth Lead 2	B28 (080) 101 Bass 2	B68 (112) NU-NRG Bass
A31 (017) TB Tra Bass	A71 (049) Singin' MINI	B31 (081) 202 Bass	B71 (113) TalkBox Bass
A32 (018) Acid TB	A72 (050) Plastic Tone	B32 (082) Psycho Funk	B72 (114) Incontinence
A33 (019) Psyche-TB	A73 (051) SinusoidRave	B33 (083) Talking Line	B73 (115) Bari Voice
A34 (020) TB + Sine	A74 (052) Sine Me Up	B34 (084) Inside Bass	B74 (116) Ac.Bass
A35 (021) Hi-Pass TB	A75 (053) Spooky Sine	B35 (085) Bubble Bass	B75 (117) E.Ac.Bass
A36 (022) Moog Saw	A76 (054) Sine Tone	B36 (086) Bass Bleep	B76 (118) Acid Jazz Bs
A37 (023) OB Saw	A77 (055) D50 Saw Lead	B37 (087) Wiggle Bass	B77 (119) Soup's Bass
A38 (024) MG Lead	A78 (056) Dst Syn Lead	B38 (088) Twist Bass	B78 (120) Fingered Bs
A41 (025) Poly Key	A81 (057) Big Up Massv	B41 (089) Octa Bass	B81 (121) FingBsVeloSw
A42 (026) Synth Pulse	A82 (058) Warm SawLead	B42 (090) BT's Sticky	B82 (122) PickedBass 1
A43 (027) Dual Profs	A83 (059) Hartnoll Era	B43 (091) MG Bass	B83 (123) PickedBass 2
A44 (028) Axe of 80	A84 (060) Skegness 97	B44 (092) FM Super Bs	B84 (124) Fretless Bs
A45 (029) MG Square	A85 (061) Simply June	B45 (093) Solid Bass	B85 (125) Phot Bass
A46 (030) Square Lead1	A86 (062) The Brothers	B46 (094) T Nite Bass	B86 (126) Slap Bass
A47 (031) Square Lead2	A87 (063) Dist Lead 2	B47 (095) Front 505	B87 (127) R&B B-Slides
A48 (032) Square Lead3	A88 (064) Dark SawLead	B48 (096) Def Bass 1	B88 (128) Syn Stack 1

## Preset C&D (CC#0=81, CC#32=1)

No. (PC#) Name	No. (PC#) Name	No. (PC#) Name	No. (PC#) Name
C11 (001) Strong Brass	C51 (033) Str/Brs Pad	D11 (065) NU-NRG Str	D51 (097) Trek Storm
C12 (002) You Can Fly	C52 (034) Syn Brs Pad	D12 (066) Violin	D52 (098) Abduction
C13 (003) Syn stack 2	C53 (035) Simple Pad	D13 (067) Contrabass	D53 (099) 1st Contact
C14 (004) Dawn Of Man	C54 (036) OB Rezo Pad	D14 (068) Tremolo Str	D54 (100) Ice Cave
C15 (005) Saw Stack 1	C55 (037) Sweet Vocode	D15 (069) Pizzicato 1	D55 (101) Rev Cord
C16 (006) Saw Stack 2	C56 (038) Thin Pad	D16 (070) Pizzicato 2	D56 (102) Blue Random
C17 (007) DLM Stack	C57 (039) Attack Pad	D17 (071) Pizz It	D57 (103) Sync Tone
C18 (008) DOC Stack	C58 (040) Metal Pad	D18 (072) Guardians	D58 (104) Seq Up
C21 (009) LN2 Stack	C61 (041) Atmosphere	D21 (073) Gat Passion	D61 (105) SawLFOSaw
C22 (010) Bend Stack	C62 (042) Fantasia	D22 (074) Syn Harp	D62 (106) Calculating
C23 (011) Freedom	C63 (043) Feedbackwave	D23 (075) Voice Oohs	D63 (107) Touch EF
C24 (012) Good Bean	C64 (044) Pacifica	D24 (076) Solo Vox	D64 (108) Welding
C25 (013) JP8000 5th	C65 (045) Atmosphere 2	D25 (077) Syn Vox	D65 (109) Press Machin
C26 (014) Mega 5th	C66 (046) Sub Atmosphe	D26 (078) Choir Aahs	D66 (110) EF Tribe
C27 (015) 5th Saw	C67 (047) Machine Pad	D27 (079) Space Voice	D67 (111) Scratch Alt
C28 (016) 4th Saw	C68 (048) Detuned Pad	D28 (080) Star Voice	D68 (112) Analog FX
C31 (017) Soundtrack	C71 (049) Scoop Pad	D31 (081) Brightness	D71 (113) Non TB
C32 (018) Rise Pad	C72 (050) Psycho Trevo	D32 (082) Vox Lead	D72 (114) Nasty Filt
C33 (019) Warm Pad	C73 (051) Floating Pad	D33 (083) Auhbient	D73 (115) Psy-Ence
C34 (020) JP + OB Pad	C74 (052) Fancy Pad	D34 (084) Auh Luv Rave	D74 (116) Music Hi
C35 (021) Planet	C75 (053) Strings 1	D35 (085) PCM Life	D75 (117) Uber Zone
C36 (022) Additive	C76 (054) Strings 2	D36 (086) Noisevox	D76 (118) Down Gown
C37 (023) Noise Pad	C77 (055) Old StringSW	D37 (087) Trance Voice	D77 (119) For Giving
C38 (024) Sweep Pad 1	C78 (056) Swim Strings	D38 (088) Effect Acer	D78 (120) Sound Alarm
C41 (025) Sweep Pad 2	C81 (057) Eclip-Str	D41 (089) Alternative	D81 (121) Acid Drone
C42 (026) Alles Padde	C82 (058) Slow Strings	D42 (090) Hard Pure	D82 (122) X-Mod
C43 (027) Sky Light	C83 (059) OB Slow Str	D43 (091) Metal EF	D83 (123) X-FM/Org
C44 (028) Stargate MC	C84 (060) Syn.Strings1	D44 (092) Dly Tone	D84 (124) X-FM Bass
C45 (029) Middle Grow	C85 (061) Syn.Strings2	D45 (093) Osci Frog	D85 (125) Hard BD?
C46 (030) AiRye Bread	C86 (062) OB Strings	D46 (094) Cal + After	D86 (126) S&H Voc
C47 (031) NU-NRG Org	C87 (063) Rhap Strings	D47 (095) 8b Pad	D87 (127) X-TikBxBass
C48 (032) Halo Pad	C88 (064) Banded Jupe	D48 (096) SpaceHighway	D88 (128) X-Kick/TB

**Preset E&F (CC#0=81, CC#32=2)**

No. (PC#)	Name	No. (PC#)	Name	No. (PC#)	Name	No. (PC#)	Name
E11 (001)	X-Org/Nz	E51 (033)	Harpsichord	F11 (065)	Timpani	F51 (097)	Bright Brass
E12 (002)	X-Pizz/Rng	E52 (034)	Clavi	F12 (066)	Steel Drum	F52 (098)	Hush Brass
E13 (003)	White Noise	E53 (035)	Digi Clavi	F13 (067)	Digi Bell	F53 (099)	Synth Brass1
E14 (004)	Pink Noise	E54 (036)	FM Clavi	F14 (068)	Acid Perc	F54 (100)	Synth Brass2
E15 (005)	P5 Noise	E55 (037)	AnalogClavi1	F15 (069)	MetaL-SD	F55 (101)	Synth Brass3
E16 (006)	Toy Noise	E56 (038)	AnalogClavi2	F16 (070)	Classy Pulse	F56 (102)	Syn Brs Lead
E17 (007)	Rezo Noise	E57 (039)	Funky Clavi	F17 (071)	Glockenspiel	F57 (103)	Obilator
E18 (008)	Vinyl Noise	E58 (040)	RotaryOrg Sl	F18 (072)	Fanta Bell	F58 (104)	OpenUp Brass
E21 (009)	Tornado Jet	E61 (041)	RotaryOrg Fs	F21 (073)	Crystal	F61 (105)	Brass Fall
E22 (010)	Smooth Jet	E62 (042)	Gospel Spin	F22 (074)	Tubular-Bell	F62 (106)	Trumpet
E23 (011)	Sweep Noise	E63 (043)	L Org F	F23 (075)	Shank Bells	F63 (107)	MutedTrumpet
E24 (012)	ModWhtSweep	E64 (044)	Organ 1	F24 (076)	MKS-30 Melts	F64 (108)	Soprano Sax
E25 (013)	Perk Breath	E65 (045)	Lp-Hp Organ	F25 (077)	Trip Lead	F65 (109)	Alto Sax
E26 (014)	Pink Bomb	E66 (046)	Organ 2	F26 (078)	Steel-Str.Gt	F66 (110)	Baritone Sax
E27 (015)	64voicePiano	E67 (047)	Percsv Organ	F27 (079)	Clean Gtr	F67 (111)	SlideBiteSax
E28 (016)	Ac.Piano 1	E68 (048)	Ballad B	F28 (080)	Jazz Gtr 1	F68 (112)	Sax & Tp
E31 (017)	Ac.Piano 2	E71 (049)	FM Club Org	F31 (081)	Jazz Gtr 2	F71 (113)	Tuba
E32 (018)	Epic House	E72 (050)	Pop Organ	F32 (082)	Muted Gtr	F72 (114)	Syn F.Horn
E33 (019)	Hush Piano	E73 (051)	Cheese Organ	F33 (083)	Lo-Fi Gtr	F73 (115)	Oboe
E34 (020)	Happy Piano	E74 (052)	Reed Organ	F34 (084)	Terror Dome	F74 (116)	Whistle
E35 (021)	BPF Piano	E75 (053)	Telstar	F35 (085)	Psycho-G	F75 (117)	Ocarina
E36 (022)	Honky-tonk	E76 (054)	Church Org	F36 (086)	Dist Gtr Chd	F76 (118)	Recorder
E37 (023)	NY Piano+Str	E77 (055)	Organ Bass	F37 (087)	Going Bald	F77 (119)	Jazz SynLead
E38 (024)	Voice Piano	E78 (056)	Strict Organ	F38 (088)	Gt.Harmonic1	F78 (120)	Solo Flute
E41 (025)	Old E.Piano	E81 (057)	SmkyChrd Org	F41 (089)	Gt.Harmonic2	F81 (121)	Pan Flute
E42 (026)	E.Piano 1	E82 (058)	Sweep Organ	F42 (090)	Shafted Gtr	F82 (122)	Bottle Blow
E43 (027)	E.Piano 2	E83 (059)	Accordion	F43 (091)	WahGT 2 Menu	F83 (123)	Funky Pipe
E44 (028)	Cool Rhodes	E84 (060)	Vibraphone	F44 (092)	Gtr Up	F84 (124)	Breath Noise
E45 (029)	Psycho EP	E85 (061)	FM Marimba	F45 (093)	Gtr Down	F85 (125)	Shakuhachi
E46 (030)	Trip E.Piano	E86 (062)	Marimba	F46 (094)	Gtr Sweep	F86 (126)	Sitar 1
E47 (031)	Rotary Rhode	E87 (063)	Xylophone	F47 (095)	Orch Gtr	F87 (127)	Sitar 2
E48 (032)	EP-Organ	E88 (064)	Balaphone	F48 (096)	Brass	F88 (128)	Santur

## Preset G&H (CC#0=81, CC#32=3)

No. (PC#) Name	No. (PC#) Name	No. (PC#) Name	No. (PC#) Name
G11 (001) Kalimba	G51 (033) Noisy Drill	H11 (065) MutePandeiro	H51 (097) Jungle Snr 2
G12 (002) Bagpipes	G52 (034) Thump Bounce	H12 (066) Open Surdo	H52 (098) TR808 Kick
G13 (003) PnoBendM7-m7	G53 (035) Tape Rewind	H13 (067) Brazil Perc	H53 (099) Plastic BD
G14 (004) Org Chd m7	G54 (036) Stop	H14 (068) Tablabaya	H54 (100) Gate Kick
G15 (005) BalapChd 9th	G55 (037) Ao!	H15 (069) Mute Cuica	H55 (101) Jungle Kick
G16 (006) Wah Gtr Hit	G56 (038) Ha!	H16 (070) Long Whistle	H56 (102) Scrtch/Vo Mn
G17 (007) Orch Hit 1	G57 (039) Seashore	H17 (071) Agogo	H57 (103) Flexi Vox Mn
G18 (008) Orch Hit 2	G58 (040) Bird	H18 (072) Short Tamb	H58 (104) Hit Menu
G21 (009) Rave-X-Tasy	G61 (041) Telephone	H21 (073) 808 Cowbell	H61 (105) Indust Menu
G22 (010) Philly Hit 1	G62 (042) Helicopter	H22 (074) CR78 Cowbell	H62 (106) Tom Menu
G23 (011) Philly Hit 2	G63 (043) Applause	H23 (075) CR78 Beat	H63 (107) Percus1 Menu
G24 (012) Attack Hit	G64 (044) Gun Shot	H24 (076) Wind-Chime	H64 (108) Percus2 Menu
G25 (013) Funky Hit	G65 (045) Machine Gun	H25 (077) Rim Shot	H65 (109) Cowbell Menu
G26 (014) Tekno ChdHit	G66 (046) Laser Gun	H26 (078) TR909 Rim	H66 (110) Shaker+ Menu
G27 (015) Dist Hit	G67 (047) Sci-Fi Laser	H27 (079) Hyoshigi	H67 (111) Rim Menu
G28 (016) Glasgow Hit	G68 (048) Breath	H28 (080) TR626 Shaker	H68 (112) Cymbal Menu
G31 (017) Happy Hit	G71 (049) Rain	H31 (081) 727 Quijada	H71 (113) CHH 1 Menu
G32 (018) Scene Hit 1	G72 (050) Siren	H32 (082) Real CH	H72 (114) CHH 2 Menu
G33 (019) Scene Hit 2	G73 (051) TR909 Tom	H33 (083) TR909 OH	H73 (115) PHH Menu
G34 (020) Drill Hit	G74 (052) TR808 Tom	H34 (084) Syn OH	H74 (116) OHH 1 Menu
G35 (021) Gaia Message	G75 (053) Syn Tom 1	H35 (085) TR909 Crash	H75 (117) OHH 2 Menu
G36 (022) Rezo Perc	G76 (054) Syn Tom 2	H36 (086) Reverse Cym	H76 (118) Clap 1 Menu
G37 (023) Syn Perc	G77 (055) Old Syn Tom	H37 (087) Asian Gong	H77 (119) Clap 2 Menu
G38 (024) MG Blip	G78 (056) Taiko	H38 (088) TR808 Clap	H78 (120) Snare 1 Menu
G41 (025) Rev Blip	G81 (057) Slow Down	H41 (089) Down Clap	H81 (121) Snare 2 Menu
G42 (026) Air Blip	G82 (058) Boom Drop	H42 (090) Clap Tail	H82 (122) Snare 3 Menu
G43 (027) Radical Perc	G83 (059) B-Tom-D	H43 (091) Rap&Real Clp	H83 (123) Snare 4 Menu
G44 (028) Machine	G84 (060) Mr.Bong Bass	H44 (092) Maddening	H84 (124) Snare 5 Menu
G45 (029) Metal Hit	G85 (061) Friends of 0	H45 (093) TR909 Snare	H85 (125) Snare 6 Menu
G46 (030) Tanz Devil	G86 (062) Latin Perc	H46 (094) TR808 Snare	H86 (126) Kick 1 Menu
G47 (031) Headz Direkt	G87 (063) Bongo Fury	H47 (095) House Snare	H87 (127) Kick 2 Menu
G48 (032) ShoppingCart	G88 (064) High Timbale	H48 (096) Jungle Snr 1	H88 (128) Kick 3 Menu

**Preset I&J (CC#0=82, CC#32=0)**

No. (PC#)	Name	No. (PC#)	Name	No. (PC#)	Name	No. (PC#)	Name
I11 (001)	Ac.Piano 3	I51 (033)	Nylon Gtr 1	J11 (065)	LoFi Strings	J51 (097)	Horn Pad 1
I12 (002)	Ac.Piano 4	I52 (034)	Nylon Gtr 2	J12 (066)	Strings&Chor	J52 (098)	Horn Pad 2
I13 (003)	St.Ac.Piano	I53 (035)	NylonGtr /SW	J13 (067)	Hybrid Str 1	J53 (099)	T.Sax SW
I14 (004)	Bright Piano	I54 (036)	NyInGtr&Str1	J14 (068)	Hybrid Str 2	J54 (100)	Oboe 2
I15 (005)	Metal Piano	I55 (037)	NyInGtr&Str2	J15 (069)	Str Stack	J55 (101)	Oboe & Flt
I16 (006)	Ac.Pno & Str	I56 (038)	6Gtr Harm	J16 (070)	Chambers 1	J56 (102)	Clarinet
I17 (007)	PianoStack 1	I57 (039)	Mute/Pop Gtr	J17 (071)	Chambers 2	J57 (103)	Oboe & Cla
I18 (008)	PianoStack 2	I58 (040)	Mute Guitar	J18 (072)	Str+Cello 1	J58 (104)	Oboe&Cla&Flt
I21 (009)	Rhodes	I61 (041)	Pop Guitar	J21 (073)	Str+Cello 2	J61 (105)	7th Flute Ld
I22 (010)	Hard Rhodes	I62 (042)	Far Dist Gtr	J22 (074)	Violin 2	J62 (106)	X Pipe
I23 (011)	Tremolo EP	I63 (043)	Gtr Fret Nz	J23 (075)	Violin 3	J63 (107)	Digi Pad 1
I24 (012)	Sine Rhodes	I64 (044)	Guitar FX	J24 (076)	Viola	J64 (108)	Rhodes Pad
I25 (013)	MIDI E.Piano	I65 (045)	Harp 1	J25 (077)	Cello	J65 (109)	Digi Pad 2
I26 (014)	Cellesta	I66 (046)	Harp 2	J26 (078)	Contrabass 2	J66 (110)	5th Pad 305
I27 (015)	Key Stack	I67 (047)	Harp Pad	J27 (079)	BrassSect. 1	J67 (111)	Soundtrk 305
I28 (016)	Tria Bells	I68 (048)	Koto	J28 (080)	BrassSect. 2	J68 (112)	PianoFX Pad
I31 (017)	Harpsichord2	I71 (049)	Shamisen	J31 (081)	4 Trumpets	J71 (113)	RND Str Pad
I32 (018)	Harpsi 8&4	I72 (050)	Sitar/Drone	J32 (082)	Sax Sect.	J72 (114)	HiPass Str
I33 (019)	Clavi 2	I73 (051)	Sitar 3	J33 (083)	Soft Brass	J73 (115)	Sweeping Str
I34 (020)	Clavi 3	I74 (052)	Sitar Drone	J34 (084)	D50 Brass	J74 (116)	Sweep Saws
I35 (021)	E.Organ 1	I75 (053)	Santur 2	J35 (085)	Hybrid Brass	J75 (117)	Strobe 305
I36 (022)	E.Organ 2	I76 (054)	Harp&Santur	J36 (086)	Hybrid Bone	J76 (118)	Babble
I37 (023)	E.Organ 3	I77 (055)	IndianUnison	J37 (087)	Rugby Horn	J77 (119)	Sweeping
I38 (024)	E.Organ 4	I78 (056)	Steel Stack	J38 (088)	Speed Trom	J78 (120)	SF Alert
I41 (025)	E.Organ 5	I81 (057)	St.Strings 1	J41 (089)	Tp & Tb	J81 (121)	Noise Hit
I42 (026)	Positive Org	I82 (058)	St.Strings 2	J42 (090)	Trumpet 2	J82 (122)	Chord Hit
I43 (027)	Pipe Organ	I83 (059)	Mono Strings	J43 (091)	Trumpet SW	J83 (123)	Timpani 2
I44 (028)	F.Accordion1	I84 (060)	MarcatoStr 1	J44 (092)	Strong Tp	J84 (124)	Taiko Menu
I45 (029)	F.Accordion2	I85 (061)	MarcatoStr 2	J45 (093)	Trombone	J85 (125)	Dolak Menu
I46 (030)	Bandoneon	I86 (062)	St.Slow Str	J46 (094)	Tuba 2	J86 (126)	Tabla Menu
I47 (031)	Harmonica	I87 (063)	Oct. Strings	J47 (095)	F.Horn	J87 (127)	China Menu
I48 (032)	Bright Harmo	I88 (064)	Film Octaves	J48 (096)	Horn Lead	J88 (128)	Drum Menu

**Bank Select table**

Patch	CC#0	CC#32
Preset A&B	81	0
Preset C&D	81	1
Preset E&F	81	2
Preset G&H	81	3
Preset I&J	82	0
User A&B	85	0
User C&D	85	1
Card A&B	86	0
Card C&D	86	1
Card E&F	86	2
Card G&H	86	3

Rhythm Set	CC#0	CC#32
Preset A	81	0
Preset B	82	0
User A	85	0
Card A	86	0

**Patch transmit example**

P:C28 (016) 4th Saw	
CC#0	81
CC#32	1
PC#	16

**Rhythm Set transmit example**

P:A24 (012) Jungle	
CC#0	81
CC#32	0
PC#	12

# Preset Rhythm Set List

\* The Rhythm Group column shows the button that can be pressed to mute that rhythm tone.

Note No.	Rhythm Group	P:A11 (001) TR-909	P:A12 (002) TR-808	P:A13 (003) TR-606	P:A14 (004) CR78&Cheaps
35	BD	Plastic BD 4	TR808 Kick 5	TR808 Kick 3	Toy Kick
36	BD	Plastic BD 3	TR808 Kick 3	Analog Kick	Plastic BD 4
37	TOM/PERC	TR808 Rim	TR808 RimLng	TR808 Rim	TR808 Rim
38	SD	TR909 Snr 1	TR808 Snr 8	TR606 Snr 3	TR808 Snr 5
39	CLP	TR909 Clap 2	TR909 Clap 1	Cheap Clap	TR909 Clap 1
40	SD	TR909 Snr 3	TR808 Snr 9	TR808 Snr 5	Deep Snare
41	TOM/PERC	TR707 Tom	TR606 Tom	TR606 CmpTom	MG Blip
42	HH	TR909 CHH 2	TR808 CHH 2	TR606 CHH 2	TR808 CHH 1
43	TOM/PERC	TR707 Tom	TR606 Tom	TR606 CmpTom	MG Blip
44	HH	TR909 PHH 2	TR808 PHH 2	Hip PHH	TR606 PHH 2
45	TOM/PERC	TR707 Tom	TR606 Tom	TR606 CmpTom	MG Blip
46	HH	TR909 OHH 1	TR808 OHH 2	TR606 DstOHH	TR606 OHH
47	BD	TR909 Kick 4	TR808 Kick 1	TR606 Dst BD	TR606 Kick
48	BD	TR909 Kick 2	TR808 Kick 4	TR606 Kick	Analog Kick
49	TOM/PERC	TR909 Rim	TR808 Rim	Analog Rim	Analog Rim
50	SD	TR909 Snr 2	TR808 Snr 6	TR606 Snr 2	TR808 Snr 1
51	CLP	TR909 Clap 1	TR808 Clap	TR808 Clap	TR808 Clap
52	SD	TR909 Snr 3	TR808 Snr 2	TR606 Snr 1	CR78 Snare
53	TOM/PERC	TR909 Tom	TR808 Tom	TR606 Tom	TR606 Tom
54	HH	TR909 CHH 1	TR808 CHH 1	TR606 CHH 1	DR55 CHH 1
55	TOM/PERC	TR909 Tom	TR808 Tom	TR606 Tom	TR606 Tom
56	HH	TR909 OHH 2	TR808 CHH 2	TR606 PHH 1	CR78 CHH
57	TOM/PERC	TR909 Tom	TR808 Tom	TR606 Tom	TR606 Tom
58	HH	TR909 OHH 2	TR808 OHH 1	TR606 OHH	CR78 OHH
59	TOM/PERC	TR909 Tom	TR808 Tom	TR606 Tom	TR606 Tom
60	TOM/PERC	TR909 Tom	TR808 Tom	TR606 Tom	TR606 Tom
61	CYM	TR909 Crash	TR606 Cym 1	TR606 Cym 2	TR606 Cym 1
62	TOM/PERC	TR909 Tom	TR808 Tom	TR606 Tom	TR606 Tom
63	CYM	TR909 Ride	TR606 Cym 1	TR909 Ride	TR606 Cym 1
64	CYM	TR909 Crash	TR909 Crash	TR606 Cym 1	Cup Cym
65	CYM	TR909 Ride	TR909 Ride	TR707 Ride	TR909 Ride
66	TOM/PERC	Tambourine 2	CR78 Tamb	CR78 Tamb	TR909 Tamb
67	CYM	NaturalCrash	TR909 Crash	TR909 Crash	TR909 Crash
68	TOM/PERC	TR808Cowbell	TR808Cowbell	TR808Cowbell	CR78 Cowbell
69	CYM	TR606 Cym 1	TR909 Crash	TR909 Crash	TR909 Ride
70	TOM/PERC	PC-2 Machine	CR78 Guiro	CR78 Guiro	TR808Cowbell
71	CYM	Natural Ride	Natural Ride	Natural Ride	TR707 Ride
72	TOM/PERC	HiBongo Open	TR808 Conga	TR808 Conga	TR808 Conga
73	TOM/PERC	LoBongo Open	TR808 Conga	TR808 Conga	TR808 Conga
74	TOM/PERC	HiConga Mute	TR808 Conga	TR808 Conga	TR808 Conga
75	TOM/PERC	HiConga Open	TR808 Conga	TR808 Conga	TR808 Conga
76	TOM/PERC	LoConga Open	TR808 Conga	TR808 Conga	TR808 Conga
77	TOM/PERC	Hi Timbale	Hi Timbale	Hi Timbale	CR78 Beat
78	TOM/PERC	Lo Timbale	Lo Timbale	Lo Timbale	CR78 Beat
79	TOM/PERC	TR727 Agogo	TR727 Agogo	CR78 Beat	TR727 Agogo
80	TOM/PERC	TR727 Agogo	TR808 Claves	CR78 Beat	TR727 Agogo
81	TOM/PERC	Cabasa Up	Cabasa Up	Cabasa Up	CR78 Guiro
82	TOM/PERC	808 Maracas	808 Maracas	808 Maracas	808 Maracas
83	HIT	Beam HiQ	Beam HiQ	Beam HiQ	Syn Hit
84	HIT	Air Blip	Air Blip	Buzzer	Beam HiQ
85	HIT	MG Blip	Syn Hit	Air Blip	Analog Bird
86	HIT	Techno Scene	Techno Scene	Rezo Noise	MG Attack
87	HIT	Air Gun	Beam HiQ	Hyoshigi	Tape Rewind
88	HIT	Tekno Hit	PC-2 Machine	Analog Bird	Air Blip
89	OTHERS	Come on!	P5 Noise	Retro UFO	Reso FX
90	OTHERS	Wao!	Toy Gun 1	PC-2 Machine	Ring Osc
91	OTHERS	Ooh! 1	Syn Tom	Syn Hit	MG Blip
92	OTHERS	Canvas	Cup Cym	Retro UFO	MG White Nz
93	OTHERS	JP8000 FBK	TR808 OHH 1	Thrill	Rezo Noise
94	OTHERS	Funky Clap	Hip Clap	Comp Clap	Cheap Clap
95	BD	TR808 Kick 1	TR808 Kick 2	TR808 Kick 1	TR808 Kick 1
96	BD	Gabba Kick	TR909 Kick 4	Plastic BD 4	TR909 Kick 1
97	SD	Synth Snare	CR78 Snare	TR909 Snr 3	TR909 Snr 1
98	SD	TR808 Snr 2	TR808 Snr 3	CR78 Snare	Sim Snare

Note No.	Rhythm Group	P:A15 (005)	P:A16 (006)	P:A17 (007)	P:A18 (008)
35	BD	Techno 1 Plastic BD 3	Techno 2 TR808 Kick 5	Techno 3 Plastic BD 3	Hardcore TR909 Kick 5
C2 36	BD	Plastic BD 2	TR707 Kick 1	Plastic BD 4	Gabba Kick
37	TOM/PERC	TR707 Rim	TR909 Rim	Jungle Snr 2	SideStiker
38	SD	TR909 Snr 6	Real Snare	TR808 Snr 7	Jungle Snr 1
39	CLP	TR909 Clap 1	Down Clap	Comp Clap	Fuzzy Clap
40	SD	TR909 Snr 7	Rap Snare	Indus Snare	TR909 Snr 4
41	TOM/PERC	TR909 DstTom	TR808 Tom	Air Blip	TR606 CmpTom
42	HH	TR909 CHH 2	TR808 CHH 2	CHH MENU 2	TR909 CHH 2
43	TOM/PERC	TR909 DstTom	TR808 Tom	MG Blip	TR606 CmpTom
44	HH	TR909 PHH 1	TR808 PHH 1	Jungle Rim 2	TR909 PHH 1
45	TOM/PERC	TR909 DstTom	TR808 Tom	HIT MENU	TR606 CmpTom
46	HH	TR909 OHH 2	TR808 OHH 1	TR909 OHH 2	TR909 OHH 1
47	BD	TR909 Kick 5	TR909 Kick 2	KICK MENU 2	Amsterdam BD
C3 48	BD	TR909 Kick 4	Plastic BD 4	West Kick	TR909 Dst BD
49	TOM/PERC	TR909 Rim	TR808 RimLng	Natural Rim	Lo-Fi Rim
50	SD	TR909 Snr 4	TR909 Snr 4	TR808 Snr 8	TR909 DstSnr
51	CLP	Group Clap	Claptail	Comp Clap	Funk Clap 2
52	SD	TR909 Snr 5	Funky Clap	MC Snare	TR909 DstSnr
53	TOM/PERC	TR909 Tom	TR707 Tom	Uuh Formant	TR909 DstTom
54	HH	TR909 CHH 1	Closed Hat	TR606 PHH 2	TR909 PHH 1
55	TOM/PERC	TR909 Tom	TR707 Tom	Ooh Formant	TR909 DstTom
56	HH	TR909 PHH 2	TR909 OHH 2	CR78 CHH	TR909 PHH 2
57	TOM/PERC	TR909 Tom	TR707 Tom	lih Formant	TR909 DstTom
58	HH	TR909 OHH 3	TR909 OHH 2	TR606 OHH	TR909 DstOHH
59	TOM/PERC	TR909 Tom	TR707 Tom	Can Tom	TR909 DstTom
C4 60	TOM/PERC	TR909 Tom	TR707 Tom	ElectricDunk	TR909 DstTom
61	CYM	TR909 Crash	TR909 Crash	TR606 Cym 2	TR909 Crash
62	TOM/PERC	TR909 Tom	TR707 Tom	HiBongo LoFi	TR909 DstTom
63	CYM	TR707 Ride	TR707 Ride	CYMBAL MENU	TR707 Ride
64	CYM	TR909 Crash	TR909 Crash	Cup Cym	TR909 Crash
65	CYM	Asian Gong	Asian Gong	TR909 Ride	Asian Gong
66	TOM/PERC	Tambourine 3	Tambourine 2	Tambourine 4	CR78 Tamb
67	CYM	TR909 Crash	TR909 Crash	CYMBAL MENU	NaturalCrash
68	TOM/PERC	Cowbell	TR808Cowbell	CR78 Beat	TR808Cowbell
69	CYM	TR606 Cym 1	TR606 Cym 2	Natural Ride	Jungle Crash
70	TOM/PERC	TR808Cowbell	CR78 Tamb	CR78 Beat	TR727Quijada
71	CYM	Natural Ride	Cup Cym	Cup Cym	Natural Ride
C5 72	TOM/PERC	HiBongo LoFi	HiBongo Open	HiBongo LoFi	HiBongo LoFi
73	TOM/PERC	LoBongo LoFi	LoBongo Open	HiBongo LoFi	LoBongo LoFi
74	TOM/PERC	HiCnga Mt LF	HiConga Mute	HiBongo LoFi	HiCnga Mt LF
75	TOM/PERC	HiCnga Op LF	HiConga Open	HiCnga Mt LF	HiCnga Op LF
76	TOM/PERC	LoConga LoFi	LoConga Open	HiConga Mute	LoConga LoFi
77	TOM/PERC	HiTimbale LF	Hi Timbale	Triangle 2	HiTimbale LF
78	TOM/PERC	LoTimbale LF	Lo Timbale	ElectricDunk	LoTimbale LF
79	TOM/PERC	CR78 Beat	TR727 Agogo	Air Blip	TR727 Agogo
80	TOM/PERC	CR78 Beat	TR727 Agogo	MG Attack	TR727 Agogo
81	TOM/PERC	TechnoShaker	TechnoShaker	TechnoShaker	TechnoShaker
82	TOM/PERC	TR626 Shaker	Maracas	808 Maracas	Dance Shaker
83	HIT	Wao!	Beam HiQ	Reso FX	Beam HiQ
C6 84	HIT	Come on!	Techno Scene	Beam HiQ	Air Gun
85	HIT	Ooh! 1	Thin Beef	Toy Gun 3	ElectricDunk
86	HIT	MG White Nz	Come on!	MG Blip	Thin Beef
87	HIT	Bomb Noise	Ooh! 1	Toy Gun 3	Drill Hit
88	HIT	Wah Gtr 2b	Wao!	Air Blip	TAO Hit
89	OTHERS	Toy Gun 3	Analog Bird	Reso FX	Rezo Noise
90	OTHERS	Toy Gun 3	Retro UFO	Emergency	Toy Gun 1
91	OTHERS	Buzzer	Metal Sweep	MG Blip	Toy Gun 3
92	OTHERS	Bomb Noise	Emergency	MG Pink Nz	Gtr FX
93	OTHERS	Sea	Tonality	Jet Plane	Dist Synth
94	CLP	Flange Snr	TR909 Clap 1	Roll Snare	Funk Clap
95	BD	TR909 Dst BD	Wet Kick	TR808 Kick 1	TR909 Kick 2
C7 96	BD	Plastic BD 4	Hip Kick	TR909 Kick 1	Turbo Kick
97	SD	Break Snare2	TR909 Snr 5	TR909 Snr 1	Rage Snare
98	SD	Ragga Rim 2	Clap Snare 2	Urban RollSD	Big Trash SD



Note No.	Rhythm Group	P:A21 (009) Ambient	P:A22 (010) House 1	P:A23 (011) House 2	P:A24 (012) Jungle
35	BD	TR909 Kick 5	TR808 Kick 5	Wet Kick	TR909 Kick 3
36	BD	Wet Kick	TR909 Kick 2	Plastic BD 2	Lo-Fi Kick 2
37	TOM/PERC	Ragga Rim 1	TR808 Rim	TR808 Rim	SideStiker
38	SD	DJ Snare	SNR MENU 1	Clap Snare 2	Urban RollSD
39	CLP	Comp Clap	CLAP MENU 1	Group Clap	Down Clap
40	SD	SideStiker	TR909 Snr 6	TR808 Snr 7	Jungle Rim 1
41	TOM/PERC	TR707 Tom	TOM MENU	TR808 Tom	Jungle Snr 2
42	HH	Closed Hat	TR707 OHH	TR707 CHH	Tight CHH
43	TOM/PERC	TR707 Tom	TR909 Tom	TR808 Tom	Jungle Snr 2
44	HH	Pedal Hat 1	TR707 OHH	TR707 PHH	Tambourine 1
45	TOM/PERC	TR707 Tom	TR909 Tom	TR808 Tom	Jungle Snr 2
46	HH	Real OHH	TR707 OHH	TR707 OHH	Cym OHH
47	BD	Wet Kick	TR808 Kick 1	TR909 Kick 2	TR909 Kick 5
48	BD	TR808 Kick 3	TR909 Kick 3	TR909 Kick 5	JungleKick 2
49	TOM/PERC	TR808 RimLng	TR808 RimLng	TR909 Rim	Jungle Rim 2
50	SD	CR78 Snare	Break Snare2	Break Snare2	Urban Snare
51	CLP	TR909 Clap 1	Claptail	TR909 Clap 1	Jungle Rim 3
52	SD	Beam HiQ	TR909 Snr 4	TR909 Snr 4	Jungle Snr 1
53	TOM/PERC	TR808 Tom	TR808 Tom	TR707 Tom	TR606 CmpTom
54	HH	DR55 CHH 1	TR909 CHH 1	TR909 CHH 1	Real CHH
55	TOM/PERC	TR808 Tom	TR808 Tom	TR707 Tom	TR606 CmpTom
56	HH	TR606 PHH 2	OHH MENU 1	TR909 PHH 1	Jungle Hat
57	TOM/PERC	TR808 Tom	TR808 Tom	TR707 Tom	TR606 CmpTom
58	HH	CR78 OHH	OHH MENU 1	TR909 OHH 3	Hip OHH
59	TOM/PERC	TR808 Tom	TR707 Tom	TR707 Tom	TR606 CmpTom
60	TOM/PERC	TR808 Tom	TR707 Tom	TR707 Tom	TR606 CmpTom
61	CYM	TR606 Cym 1	TR909 Crash	TR909 Crash	Jungle Crash
62	TOM/PERC	TR808 Tom	TR707 Tom	TR707 Tom	TR606 CmpTom
63	CYM	TR909 Ride	TR909 Ride	TR909 Ride	Natural Ride
64	CYM	TR606 Cym 1	NaturalCrash	NaturalCrash	NaturalCrash
65	CYM	Asian Gong	Tambourine 2	Tambourine 3	Asian Gong
66	TOM/PERC	Tambourine 3	Tambourine 1	Tambourine 4	Tambourine 3
67	CYM	TR606 Cym 2	TR909 Crash	TR909 Crash	TR606 Cym 1
68	TOM/PERC	CR78 Cowbell	TR707Cowbell	TR707Cowbell	Cowbell
69	CYM	NaturalCrash	Cup Cym	Cup Cym	TR909 Crash
70	TOM/PERC	TR808Cowbell	TR808Cowbell	TR808Cowbell	CR78 Tamb
71	CYM	Natural Ride	Natural Ride	Natural Ride	TR707 Ride
72	TOM/PERC	HiBongo Open	HiBongo LoFi	HiBongo LoFi	HiBongo LoFi
73	TOM/PERC	LoBongo Open	LoBongo LoFi	LoBongo LoFi	LoBongo LoFi
74	TOM/PERC	HiConga Mute	HiConga Mute	HiCnga Mt LF	HiCnga Mt LF
75	TOM/PERC	HiConga Open	HiConga Open	HiCnga Op LF	HiCnga Op LF
76	TOM/PERC	LoConga Open	LoConga Open	LoConga LoFi	LoConga LoFi
77	TOM/PERC	Hi Timbale	HiTimbale LF	HiTimbale LF	HiTimbale LF
78	TOM/PERC	Lo Timbale	LoTimbale LF	LoTimbale LF	LoTimbale LF
79	TOM/PERC	TR727 Agogo	TR727 Agogo	TR727 Agogo	Open Surdo
80	TOM/PERC	TR727 Agogo	TR727 Agogo	TR727 Agogo	Mute Surdo
81	TOM/PERC	TechnoShaker	808 Maracas	Cabasa Up	TechnoShaker
82	TOM/PERC	808 Maracas	TR626 Shaker	TR626 Shaker	TR626 Shaker
83	HIT	Air Blip	TR606 CHH 1	Belltree	Beam HIQ
84	HIT	Wind Chime	TR727Quijada	TR727Quijada	Air Blip
85	HIT	Thrill	Short Guiro	Short Guiro	Thin Beef
86	HIT	CR78 Beat	Long Guiro	Long Guiro	Analog Bird
87	HIT	Retro UFO	TR808 Claves	TR808 Claves	Tape Rewind
88	HIT	Hyoshigi	Hyoshigi	Hyoshigi	Wao!
89	OTHERS	Pizzy Techno	Bomb Noise	Bomb Noise	Emergency
90	OTHERS	Org Chord	Come on!	Come on!	Toy Gun 3
91	OTHERS	Feedbackwave	Triangle 1	Ooh! 1	Reso FX
92	OTHERS	Stream	Cup Cym	Wao!	Toy Gun 2
93	OTHERS	Bird	TR808 OHH 1	Laugh	Toy Gun 1
94	CLP	Claptail	Hip Clap	Claptail	Big Clap
95	BD	TR808 Kick 1	TR808 Kick 2	TR808 Kick 1	TR808 Kick 2
96	BD	JungleKick 2	TR909 Kick 4	Plastic BD 3	Roll Kick
97	SD	TR808 Snr 2	CR78 Snare	TR808 Snr 6	Roll Snare
98	SD	Jungle Snr 1	TR808 Snr 3	TR909 Snr 7	Break Snare2

Note No.	Rhythm Group	P:A25 (013) Drum'n'Bass1	P:A26 (014) Drum'n'Bass2	P:A27 (015) Hip-Hop 1	P:A28 (016) Hip-Hop 2
35	BD	Roll Kick	TR909 Kick 3	Lo-Fi Kick 1	TR707 Kick 1
36	BD	Analog Kick	Lo-Fi Kick 2	TR808 Kick 3	Optic Kick
37	TOM/PERC	RaggaTightSD	SideStiker	Solid Snare	TR808 RimLng
38	SD	Cross Snare	Urban RollSD	HipJazz Snr	Headz Snare
39	CLP	Roll Snare	Down Clap	Funk Clap 2	Claptail
40	SD	Headz Snare	Jungle Snr 1	R&B Snare	TR808 Snr 7
41	TOM/PERC	TR606 Tom	Jungle Snr 2	TR808 Tom	TR808 Tom
42	HH	Pop CHH	Tight CHH	Pop CHH	TR808 CHH 1
43	TOM/PERC	TR606 Tom	Jungle Snr 2	TR808 Tom	TR808 Tom
44	HH	Tambourine 3	Tambourine 1	Pedal Hat 1	TR808 PHH 1
45	TOM/PERC	TR606 Tom	Jungle Snr 2	TR808 Tom	TR808 Tom
46	HH	Pop Hat Open	Cym OHH	Pop Hat Open	TR808 OHH 2
47	BD	Plastic BD 1	TR909 Kick 5	Break Kick	TR909 Kick 3
48	BD	Hip Kick	JungleKick 2	Hip Kick	TR808 Kick 3
49	TOM/PERC	Scratch SD r	Jungle Rim 2	Lo-Fi Rim	Gate Rim
50	SD	Break Snare2	Urban Snare	Jazz Snare	Tiny Snare 2
51	CLP	Funky Clap	Jungle Rim 3	Funky Clap	Little Clap
52	SD	Ragga Snr 2	Jungle Snr 1	East Snare	R&B Snare
53	TOM/PERC	Kick Tom	TR909 DstTom	Natural Tom	Natural Tom
54	HH	Real CHH	Real CHH	Tight CHH	Pop CHH
55	TOM/PERC	Kick Tom	TR909 DstTom	Natural Tom	Natural Tom
56	HH	TR808 PHH 1	Jungle Hat	Pedal Hat 2	Pedal Hat 1
57	TOM/PERC	Kick Tom	TR909 DstTom	Natural Tom	Natural Tom
58	HH	TR606 OHH	Hip OHH	Hip OHH	Pop Hat Open
59	TOM/PERC	Kick Tom	TR909 DstTom	Natural Tom	Natural Tom
60	TOM/PERC	Kick Tom	TR909 DstTom	Natural Tom	Natural Tom
61	CYM	TR909 Crash	Jungle Crash	TR909 Crash	NaturalCrash
62	TOM/PERC	Kick Tom	TR606 CmpTom	Natural Tom	Natural Tom
63	CYM	TR909 Ride	Natural Ride	TR707 Ride	TR909 Ride
64	CYM	TR909 Crash	NaturalCrash	TR909 Crash	TR909 Crash
65	CYM	Asian Gong	Asian Gong	Cup Cym	Cup Cym
66	TOM/PERC	Tambourine 2	Tambourine 3	Tambourine 3	Tambourine 4
67	CYM	TR909 Crash	TR606 Cym 1	Tambourine 4	TR909 Crash
68	TOM/PERC	CR78 Cowbell	Cowbell	TR808Cowbell	Cowbell
69	CYM	TR606 Cym 2	TR909 Crash	TR606 Cym 1	TR606 Cym 1
70	TOM/PERC	TR808Cowbell	CR78 Tamb	CR78 Cowbell	TR808Cowbell
71	CYM	Natural Ride	TR707 Ride	Natural Ride	Natural Ride
72	TOM/PERC	HiBongo Open	HiBongo LoFi	HiBongo LoFi	HiBongo Open
73	TOM/PERC	LoBongo Open	LoBongo LoFi	LoBongo LoFi	LoBongo Open
74	TOM/PERC	HiConga Mute	HiCnga Mt LF	HiCnga Mt LF	HiConga Mute
75	TOM/PERC	HiConga Open	HiCnga Op LF	HiCnga Op LF	HiConga Open
76	TOM/PERC	LoConga Open	LoConga LoFi	LoConga LoFi	LoConga Open
77	TOM/PERC	Hi Timbale	HiTimbale LF	HiTimbale LF	Hi Timbale
78	TOM/PERC	Lo Timbale	LoTimbale LF	LoTimbale LF	Lo Timbale
79	TOM/PERC	TR727 Agogo	Open Surdo	TR727 Agogo	TR727 Agogo
80	TOM/PERC	TR727 Agogo	Mute Surdo	TR727 Agogo	TR727 Agogo
81	TOM/PERC	Cabasa Up	Cabasa Up	Dance Shaker	TechnoShaker
82	TOM/PERC	Maracas	Maracas	808 Maracas	808 Maracas
83	HIT	MG Blip	Beam HIQ	Scratch BD f	Scratch BD f
84	HIT	Air Blip	ElectricDunk	Scratch BD r	Scratch BD r
85	HIT	Hyoshigi	Bomb	Scratch SD f	Scratch SD f
86	HIT	CR78 Guiro	Analog Bird	Scratch SD r	Scratch SD r
87	HIT	Mt Pandeiro	Tape Rewind	Scratch ALT	Scratch ALT
88	HIT	Chenchen	Wao!	Vinyl Stop	Funky Bass
89	OTHERS	Thrill	Emergency	Vinyl Noise	Vinyl Noise
90	OTHERS	Retro UFO	Toy Gun 3	Kick it!	Philly Hit
91	OTHERS	Rezo Noise	Reso FX	Ooh! 2	Brass Fall
92	OTHERS	Feedbackwave	Toy Gun 2	Ooh! 1	Ooh! 1
93	OTHERS	Space Noise	Toy Gun 1	Laugh	Ooh! 2
94	CLP	Little Clap	Big Clap	Funk Clap	Finger Snap
95	BD	TR808 Kick 2	TR808 Kick 2	TR808 Kick 1	TR808 Kick 1
96	BD	TR909 Kick 1	Roll Kick	Dance Kick 1	Hazy Kick
97	SD	Solid Snare	Roll Snare	Break Snare2	TR606 Snr 2
98	SD	Flange Snr	Break Snare2	HH Soul Snr	Machine Snr

Note No.	Rhythm Group	P:A31 (017) Funk	P:A32 (018) Electro	P:A33 (019) Jazz	P:A34 (020) Brush
35	BD	TR707 Kick 2	TR808 Kick 1	Lo-Fi Kick 1	Video Kick
C2 36	BD	West Kick	TR808 Kick 5	Hip Kick	West Kick
37	TOM/PERC	Lo-Fi Rim	TR808 RimLng	SideStiker	Natural Rim
38	SD	Deep Snare	TR808 Snr 8	Deep Snare	R&B Snare
39	CLP	Funky Clap	Down Clap	Real Clap 1	Brush Slap 1
40	SD	Disco Snare	TR808 Snr 5	HH Soul Snr	MC Snare
41	TOM/PERC	TR707 Tom	TR808 Tom	Natural Tom	TR707 Tom
42	HH	Tight CHH	TR808 CHH 1	Real CHH	Pop CHH
43	TOM/PERC	TR707 Tom	TR808 Tom	Natural Tom	TR707 Tom
44	HH	Hip PHH	TR808 PHH 1	Pedal Hat 1	Room CHH
45	TOM/PERC	TR707 Tom	TR808 Tom	Natural Tom	TR707 Tom
46	HH	Funk OHH	TR808 OHH 1	Real OHH	Pop Hat Open
47	BD	Hazy Kick	Ele Kick	Optic Kick	Hip Kick
C3 48	BD	Turbo Kick	TR707 Kick 2	Video Kick	Optic Kick
49	TOM/PERC	SideStiker	TR707 Rim	Gate Rim	R8 BrshSwill
50	SD	Whack Snare	ElectroSnr 2	Headz Snare	R8 Brush Tap
51	CLP	Funk Clap 2	TR707 Clap	Big Clap	Brush Slap 2
52	SD	Macho Snare	Sim Snare	Cross Snare	R8 BrushRoll
53	TOM/PERC	TR909 Tom	Deep Tom	TR707 Tom	Natural Tom
54	HH	Real CHH	Closed Hat	Closed Hat	R8 Brush CHH
55	TOM/PERC	TR909 Tom	Deep Tom	TR707 Tom	Natural Tom
56	HH	Pedal Hat 1	Pedal Hat 1	Bristol CHH	Pedal Hat 1
57	TOM/PERC	TR909 Tom	Deep Tom	TR707 Tom	Natural Tom
58	HH	Cym OHH	Open Hat	Cym OHH	R8 OHH
59	TOM/PERC	TR909 Tom	Deep Tom	TR707 Tom	Natural Tom
C4 60	TOM/PERC	TR909 Tom	Deep Tom	TR707 Tom	Natural Tom
61	CYM	NaturalCrash	TR909 Crash	NaturalCrash	NaturalCrash
62	TOM/PERC	TR909 Tom	Deep Tom	TR707 Tom	Natural Tom
63	CYM	TR909 Ride	TR707 Ride	TR909 Ride	TR909 Ride
64	CYM	TR909 Crash	NaturalCrash	NaturalCrash	NaturalCrash
65	CYM	Cup Cym	Asian Gong	Cup Cym	Cup Cym
66	TOM/PERC	CR78 Tamb	Tambourine 2	Tambourine 2	Tambourine 2
67	CYM	TR909 Crash	TR909 Crash	TR909 Crash	TR606 Cym 1
68	TOM/PERC	TR707Cowbell	TR808Cowbell	Cowbell	Cowbell
69	CYM	TR606 Cym 1	TR606 Cym 1	TR606 Cym 1	TR909 Crash
70	TOM/PERC	TR808Cowbell	TR727Quijada	TR808Cowbell	TR808Cowbell
71	CYM	Natural Ride	Natural Ride	Natural Ride	Natural Ride
C5 72	TOM/PERC	HiBongo Open	HiBongo Open	HiBongo Open	HiBongo Open
73	TOM/PERC	LoBongo Open	LoBongo Open	LoBongo Open	LoBongo Open
74	TOM/PERC	HiConga Mute	HiConga Mute	HiConga Mute	HiConga Mute
75	TOM/PERC	HiConga Open	HiConga Open	HiConga Open	HiConga Open
76	TOM/PERC	LoConga Open	LoConga Open	LoConga Open	LoConga Open
77	TOM/PERC	Hi Timbale	Hi Timbale	Hi Timbale	Hi Timbale
78	TOM/PERC	Lo Timbale	Lo Timbale	Lo Timbale	Lo Timbale
79	TOM/PERC	TR727 Agogo	TR727 Agogo	TR727 Agogo	TR727 Agogo
80	TOM/PERC	TR727 Agogo	TR727 Agogo	TR727 Agogo	TR727 Agogo
81	TOM/PERC	TechnoShaker	Cabasa Up	Cabasa Up	Cabasa Up
82	TOM/PERC	808 Maracas	808 Maracas	Maracas	Maracas
83	HIT	Scratch BD f	Air Blip	TR727Quijada	Whistle
C6 84	HIT	Scratch BD r	Thin Beef	Jingle Bell	Whistle
85	HIT	Scratch SD f	Back Hit	Short Guiro	Short Guiro
86	HIT	Scratch SD r	Analog Bird	Long Guiro	Long Guiro
87	HIT	Scratch ALT	Hoo	TR808 Claves	TR808 Claves
88	HIT	Vinyl Stop	Metal Sweep	Hyoshigi	Hyoshigi
89	OTHERS	Vinyl Noise	Emergency	Hyoshigi	Hyoshigi
90	OTHERS	Philly Hit	Buzzer	Mute Cuica	Mute Cuica
91	OTHERS	Brass Fall	Tonality	Open Cuica	Open Cuica
92	OTHERS	Kick it!	Ring Osc	Triangle 1	Triangle 1
93	OTHERS	Harmo Gtr	Toy Gun 3	Triangle 1	Triangle 1
94	CLP	Big Clap	Toy Gun 3	Triangle 1	Triangle 1
95	BD	Plastic BD 2	Hip Clap	Finger Snap	Real Clap 1
C7 96	BD	TR909 Kick 5	Lo-Fi Kick 1	TR909 Kick 1	TR909 Kick 2
97	SD	DanceHall SD	Synth Snare	R8 BrshSwill	TR707 Kick 1
98	SD	Machine Snr	TR808 Snr 6	R8 Brush Tap	Real Snare
					Deep Snare

Note No.	Rhythm Group	P:A35 (021)	P:A36 (022)	P:A37 (023)	P:A38 (024)
35	BD	TR707 Kick 2	Analog Kick	Optic Kick	TR909 Dst BD
C2 36	BD	TR808 Kick 3	TR707 Kick 2	TR909 Kick 4	Lo-Fi Kick 2
	TOM/PERC	TR707 Rim	Gate Rim	TR808 RimLng	Drill Hit
38	SD	Real Snare	Jungle Rim 1	Hash Snare	Big Trash SD
	CLP	Real Clap 1	Hip Clap	Funk Clap 2	Dist Swish
40	SD	Fat Snare	Ragga Snr 2	DJ Snare	Rage Snare
	TOM/PERC	TR707 Tom	TR808 Tom	Kick Tom	Can Tom
41	HH	Real CHH	Bristol CHH	TR909 CHH 2	Air Blip
	TOM/PERC	TR707 Tom	TR808 Tom	Kick Tom	Can Tom
43	HH	Pedal Hat 1	Pedal Hat 1	TR909 PHH 1	Beam HiQ
	TOM/PERC	TR707 Tom	TR808 Tom	Kick Tom	Can Tom
45	HH	Real OHH	Cym OHH	TR909 OHH 1	TR909 DstOHH
	BD	Turbo Kick	Plastic BD 4	TR909 Kick 5	Bomb
47	BD	TR707 Kick 1	Video Kick	Turbo Kick	Iron Door
C3 48	TOM/PERC	TR808 RimLng	Beam HiQ	SideStiker	Thrill
	SD	Deep Snare	DanceHall SD	Lo-Fi Snare	PCM Press
50	CLP	Big Clap	Little Clap	Claptail	Air Gun
	SD	TR707 Snare	Ragga Rim 2	Macho Snare	PCM Press
52	TOM/PERC	Deep Tom	Deep Tom	TR707 Tom	TekRok Snare
53	HH	TR808 CHH 1	TR707 CHH	TR909 PHH 1	Real PHH
	TOM/PERC	Kick Tom	Deep Tom	TR707 Tom	TekRok Snare
55	HH	Pop CHH	Pop CHH	TR909 OHH 3	TR909 PHH 1
	TOM/PERC	Deep Tom	Deep Tom	TR707 Tom	TekRok Snare
57	HH	TR707 OHH	TR707 OHH	Cym OHH	TR909 DstOHH
	TOM/PERC	Kick Tom	Deep Tom	TR707 Tom	TekRok Snare
59	TOM/PERC	Deep Tom	Deep Tom	TR707 Tom	TekRok Snare
C4 60	CYM	NaturalCrash	NaturalCrash	TR909 Crash	Bomb Noise
	TOM/PERC	Kick Tom	Deep Tom	TR707 Tom	TekRok Snare
62	CYM	TR909 Ride	TR909 Ride	TR909 Ride	TR909 Ride
	CYM	NaturalCrash	NaturalCrash	TR909 Crash	Drill Hit
64	CYM	Cup Cym	Asian Gong	Asian Gong	ElectricDunk
	TOM/PERC	Tambourine 2	Tambourine 3	Tambourine 3	Mt Pandeiro
65	CYM	TR909 Crash	TR909 Crash	TR909 Crash	TR606 Cym 1
	TOM/PERC	Cowbell	Cowbell	Cowbell	PC-2 Machine
67	CYM	TR606 Cym 1	TR606 Cym 1	TR606 Cym 2	TR909 Crash
	TOM/PERC	TR808Cowbell	TR808Cowbell	TR808Cowbell	Crash
69	CYM	Natural Ride	TR707 Ride	Natural Ride	Natural Ride
	TOM/PERC	HiBongo Open	HiBongo Open	HiBongo LoFi	HiBongo LoFi
71	CYM	LoBongo Open	LoBongo Open	LoBongo LoFi	LoBongo LoFi
	TOM/PERC	HiConga Mute	HiConga Mute	HiCnga Mt LF	HiCnga Mt LF
C5 72	TOM/PERC	HiConga Open	HiConga Open	HiCnga Op LF	HiCnga Op LF
	TOM/PERC	LoConga Open	LoConga Open	LoConga LoFi	LoConga LoFi
74	TOM/PERC	Hi Timbale	Hi Timbale	HiTimbale LF	HiTimbale LF
	TOM/PERC	Lo Timbale	Lo Timbale	LoTimbale LF	LoTimbale LF
76	TOM/PERC	TR727 Agogo	TR727 Agogo	TR727 Agogo	Analog Bird
	TOM/PERC	TR727 Agogo	TR727 Agogo	TR727 Agogo	Analog Bird
77	TOM/PERC	Cabasa Up	TechnoShaker	TR727Quijada	TechnoShaker
	TOM/PERC	Maracas	808 Maracas	TR626 Shaker	TR626 Shaker
78	TOM/PERC	Triangle 1	MG Attack	Bounce	One!
	HIT	Triangle 1	Air Blip	ElectricDunk	Two!
79	HIT	Beam HiQ	Syn Hit	Iron Door	Three!
	HIT	Back Hit	TAO Hit	Drill Hit	Kick it!
80	HIT	Back Hit	Chiki!	Thrill	Wao!
	HIT	Philly Hit	Hey!	PCM Press	Come on!
81	OTHERS	Brass Fall	Toy Gun 1	Dist TekGtr	Fuzzy Clap
	OTHERS	Rezo Noise	Toy Gun 2	Dist TekGtr	Roll Kick
82	OTHERS	lih Formant	Toy Gun 3	Dist TekGtr	Bomb
	OTHERS	Analog Bird	Reso FX	Dist TekGtr	LoTimbale LF
83	OTHERS	Emergency	Emergency	Gtr FX	TR909 DstOHH
	CLP	Down Clap	Big Clap	Air Gun	Fuzzy Clap
84	BD	TR808 Kick 1	TR808 Kick 1	TR909 Kick 2	TR909 Kick 2
	BD	TR909 Kick 1	TR909 Kick 1	Gabba Kick	Roll Kick
C6 85	SD	TR909 Snr 3	HH Soul Snr	ElectroSnr 2	TR909 DstSnr
	SD	TR808 Snr 5	TR909 Snr 4	Big Trash SD	Flange Snr
86	HIT	Triangle 1	MG Attack	Bounce	One!
	HIT	Beam HiQ	Syn Hit	Iron Door	Three!
87	HIT	Back Hit	TAO Hit	Drill Hit	Kick it!
	HIT	Back Hit	Chiki!	Thrill	Wao!
88	HIT	Philly Hit	Hey!	PCM Press	Come on!
	OTHERS	Brass Fall	Toy Gun 1	Dist TekGtr	Fuzzy Clap
89	OTHERS	Rezo Noise	Toy Gun 2	Dist TekGtr	Roll Kick
	OTHERS	lih Formant	Toy Gun 3	Dist TekGtr	Bomb
90	OTHERS	Analog Bird	Reso FX	Dist TekGtr	LoTimbale LF
	OTHERS	Emergency	Emergency	Gtr FX	TR909 DstOHH
91	CLP	Down Clap	Big Clap	Air Gun	Fuzzy Clap
	BD	TR808 Kick 1	TR808 Kick 1	TR909 Kick 2	TR909 Kick 2
92	BD	TR909 Kick 1	TR909 Kick 1	Gabba Kick	Roll Kick
	SD	TR909 Snr 3	HH Soul Snr	ElectroSnr 2	TR909 DstSnr
93	SD	TR808 Snr 5	TR909 Snr 4	Big Trash SD	Flange Snr
C7 94	HIT	Triangle 1	MG Attack	Bounce	One!
	HIT	Beam HiQ	Syn Hit	Iron Door	Three!
95	HIT	Back Hit	TAO Hit	Drill Hit	Kick it!
	HIT	Back Hit	Chiki!	Thrill	Wao!
96	HIT	Philly Hit	Hey!	PCM Press	Come on!
	OTHERS	Brass Fall	Toy Gun 1	Dist TekGtr	Fuzzy Clap
97	OTHERS	Rezo Noise	Toy Gun 2	Dist TekGtr	Roll Kick
	OTHERS	lih Formant	Toy Gun 3	Dist TekGtr	Bomb
98	OTHERS	Analog Bird	Reso FX	Dist TekGtr	LoTimbale LF
	OTHERS	Emergency	Emergency	Gtr FX	TR909 DstOHH
	CLP	Down Clap	Big Clap	Air Gun	Fuzzy Clap
	BD	TR808 Kick 1	TR808 Kick 1	TR909 Kick 2	TR909 Kick 2
	BD	TR909 Kick 1	TR909 Kick 1	Gabba Kick	Roll Kick
	SD	TR909 Snr 3	HH Soul Snr	ElectroSnr 2	TR909 DstSnr
	SD	TR808 Snr 5	TR909 Snr 4	Big Trash SD	Flange Snr

Note No.	Rhythm Group	P:A41 (025)	P:A42 (026)	P:B11 (001)	P:B12 (002)
35	BD	Open Surdo	Ele Kick	TR707 Kick 2	TR909 Kick 3
36	BD	Mute Surdo	Turbo Kick	Hybrid Kick	Optic Kick
C2 37	TOM/PERC	Jungle Snap	TR909 Rim	Gate Rim	Natural Rim
38	SD	Natural Rim	TR606 Snr 2	Ballad Snr	Fat Snare
39	CLP	Big Clap	Comp Clap	TR808 Clap	Real Clap 1
40	SD	Jungle Snr 1	Real Snare	Solo Snare	DJ Snare
41	TOM/PERC	Jungle Snr 2	Can Tom	Natural Tom	Deep Tom
42	HH	Mt Pandeiro	TR808 CHH 2	Pop CHH	Closed Hat
43	TOM/PERC	Jungle Snr 2	Can Tom	Natural Tom	Deep Tom
44	HH	R8 Brush CHH	TR808 PHH 1	Room CHH	Pedal Hat 1
45	TOM/PERC	Jungle Snr 2	Can Tom	Natural Tom	Deep Tom
46	HH	Metal Sweep	TR808 OHH 1	Pop Hat Open	Open Hat
47	BD	Afro Feet	TR707 Kick 1	Hip Kick	Video Kick
C3 48	BD	Mute Surdo	Plastic BD 3	Old Kick	Old Kick
49	TOM/PERC	Jungle Snap	TR707 Rim	Gate Rim	Ragga Rim 1
50	SD	Op Pandeiro	TR909 Snr 4	Piccolo Snr	Deep Snare
51	CLP	Real Clap 2	TR707 Clap	TR909 Clap 1	TR808 Clap
52	SD	Hi Timbale	Comp Clap	MC Snare	HH Soul Snr
53	TOM/PERC	TablaBaya	TR707 Tom	TR707 Tom	Natural Tom
54	HH	Chenchen	TR909 CHH 1	Real CHH	Pop CHH
55	TOM/PERC	TablaBaya	TR707 Tom	TR707 Tom	Natural Tom
56	HH	Tambourine 1	TR909 PHH 1	Pedal Hat 2	Room CHH
57	TOM/PERC	TablaBaya	TR707 Tom	TR707 Tom	Natural Tom
58	HH	Tambourine 4	TR909 DstOHH	Open Hat	Pop Hat Open
59	TOM/PERC	TablaBaya	TR707 Tom	TR707 Tom	Natural Tom
C4 60	TOM/PERC	Udo	TR707 Tom	TR707 Tom	Natural Tom
61	CYM	Asian Gong	TR909 Crash	NaturalCrash	NaturalCrash
62	TOM/PERC	Udo	TR707 Tom	TR707 Tom	Natural Tom
63	CYM	Cup Cym	TR707 Ride	Natural Ride	TR707 Ride
64	CYM	NaturalCrash	TR909 Crash	NaturalCrash	TR909 Crash
65	CYM	Cup Cym	Asian Gong	Cup Cym	Asian Gong
66	TOM/PERC	Tambourine 2	Tambourine 2	Tambourine 2	Tambourine 2
67	CYM	TR606 Cym 1	TR909 Crash	TR909 Crash	TR909 Crash
68	TOM/PERC	Cowbell	TR808Cowbell	Cowbell	Cowbell
69	CYM	NaturalCrash	TR606 Cym 2	TR606 Cym 1	TR606 Cym 1
70	TOM/PERC	CR78 Beat	CR78 Tamb	TR808Cowbell	TR808Cowbell
71	CYM	Natural Ride	Cup Cym	TR909 Ride	Natural Ride
C5 72	TOM/PERC	HiBongo LoFi	HiBongo Open	HiBongo Open	HiBongo Open
73	TOM/PERC	LoBongo LoFi	LoBongo Open	LoBongo Open	LoBongo Open
74	TOM/PERC	HiCnga Mt LF	HiConga Mute	HiConga Mute	HiConga Mute
75	TOM/PERC	HiCnga Op LF	HiConga Open	HiConga Open	HiConga Open
76	TOM/PERC	LoConga LoFi	LoConga Open	LoConga Open	LoConga Open
77	TOM/PERC	HiTimbale LF	Hi Timbale	Hi Timbale	Hi Timbale
78	TOM/PERC	LoTimbale LF	Lo Timbale	Hi Timbale	Hi Timbale
79	TOM/PERC	TR727 Agogo	TR727 Agogo	TR727 Agogo	TR727 Agogo
80	TOM/PERC	TR727 Agogo	TR727 Agogo	TR727 Agogo	TR727 Agogo
81	TOM/PERC	Cabasa Up	TechnoShaker	Cabasa Up	Cabasa Up
82	TOM/PERC	TR626 Shaker	Maracas	Maracas	Maracas
83	HIT	Whistle	Beam HiQ	TR727Quijada	TR727Quijada
C6 84	HIT	Whistle	Tape Rewind	Jingle Bell	Tambourine 1
85	HIT	Short Guiro	Vinyl Stop	Short Guiro	Short Guiro
86	HIT	Long Guiro	Come on!	Long Guiro	Long Guiro
87	HIT	TR808 Claves	One!	TR808 Claves	TR808 Claves
88	HIT	Hyoshigi	Pa!	Hyoshigi	Hyoshigi
89	OTHERS	AfroDrum Rat	Analog Bird	Hyoshigi	Hyoshigi
90	OTHERS	Mute Cuica	Retro UFO	Mute Cuica	Mute Cuica
91	OTHERS	Open Cuica	Metal Sweep	Open Cuica	Open Cuica
92	OTHERS	Triangle 2	Dst Solo Gtr	Triangle 1	Triangle 1
93	OTHERS	Triangle 1	Emergency	Triangle 1	Triangle 1
94	OTHERS	Triangle 1	Emergency	Triangle 1	Triangle 1
95	CLP	Real Clap 1	Down Clap	Finger Snap	Real Clap 2
96	BD	Boost Kick	Wet Kick	TR808 Kick 1	Hip Kick
C7 97	BD	Kick Ghost	Hip Kick	TR909 Kick 1	TR707 Kick 1
98	SD	Voice loop	TR909 Snr 5	Brush Slap3	Solo Snare
	SD	Chikil	Jazz Snare	Brush Swish	Real Snare

Note No.	Rhythm Group	P:B13 (003)	P:B14 (004)	P:B15 (005)	P:B16 (006)
35	BD	TR707 Kick 2	Hip Kick	Hip Kick	Dholak Lo Op
C2 36	BD	Turbo Kick	Plastic BD 3	West Kick	Dholak Lo Mt
37	TOM/PERC	Gate Rim	SideStiker	Brush Swish	Dholak Hi Mt
38	SD	Piccolo Snr	Hash Snare	R8 Brush Tap	Dholak Hi Mt
39	CLP	Big Clap	Group Clap	R8 BrshSwill	Real Clap 2
40	SD	DJ Snare	Big Trash SD	Brush Slap 1	Dholak Hi Op
	TOM/PERC	Kick Tom	Kick Tom	Natural Tom	Dholak Lo Op
41	HH	Room CHH	Closed Hat	R8 Brush CHH	AfroDrum Rat
42	TOM/PERC	Kick Tom	Kick Tom	Natural Tom	Dholak Lo Op
43	HH	Real PHH	Pedal Hat 2	Pedal Hat 1	Chenchen
44	TOM/PERC	Kick Tom	Kick Tom	Natural Tom	Dholak Lo Op
45	HH	R8 OHH	Cym OHH	R8 OHH	AfroDrum Rat
46	BD	Hazy Kick	Break Kick	Video Kick	Tabla Lo Op
C3 47	BD	Dance Kick 1	Lo-Fi Kick 1	Hybrid Kick	TablaBaya
48	TOM/PERC	Gate Rim	Lo-Fi Rim	R8 Brush Tap	Tabla Hi Mt
49	SD	Macho Snare	DJ Snare	Brush Slap 2	Tabla Lo Mt
50	CLP	Group Clap	Real Clap 2	R8 BrushRoll	Tabla
51	SD	Big Trash SD	TekRok Snare	Brush Slap 3	Tabla Hi Op
52	TOM/PERC	Deep Tom	TR707 Tom	Natural Tom	TablaBaya
53	HH	Room CHH	Real CHH	Pop CHH	Tambourine 4
54	TOM/PERC	Deep Tom	TR707 Tom	Natural Tom	TablaBaya
55	HH	Room CHH	Real PHH	Room CHH	Tambourine 1
56	TOM/PERC	Deep Tom	TR707 Tom	Natural Tom	TablaBaya
57	HH	Open Hat	Open Hat	Pop Hat Open	Tambourine 2
58	TOM/PERC	Deep Tom	TR707 Tom	Natural Tom	TablaBaya
C4 59	TOM/PERC	Deep Tom	TR707 Tom	Natural Tom	TablaBaya
60	CYM	NaturalCrash	TR909 Crash	NaturalCrash	China Cym
61	TOM/PERC	Deep Tom	TR707 Tom	Natural Tom	TablaBaya
62	CYM	TR707 Ride	TR909 Ride	TR909 Ride	Bend Gong
63	CYM	Jungle Crash	TR909 Crash	NaturalCrash	Asian Gong
64	CYM	Asian Gong	Bend Gong	Cup Cym	Hu Yin Luo
65	TOM/PERC	Tambourine 3	Tambourine 1	Tambourine 2	Tambourine 4
66	CYM	TR909 Crash	NaturalCrash	TR606 Cym 1	TR606 Cym 1
67	TOM/PERC	Cowbell	TR727 Agogo	Cowbell	Nao Bo
68	CYM	TR606 Cym 2	TR606 Cym 1	TR909 Crash	NaturalCrash
69	TOM/PERC	TR707Cowbell	TR808Cowbell	TR808Cowbell	CR78 Beat
70	CYM	Cup Cym	Natural Ride	Natural Ride	Natural Ride
C5 71	TOM/PERC	HiBongo Open	HiBongo LoFi	HiBongo Open	Taiko
72	TOM/PERC	LoBongo Open	LoBongo LoFi	LoBongo Open	Taiko
73	TOM/PERC	HiConga Mute	HiCnga Mt LF	HiConga Mute	Taiko
74	TOM/PERC	HiConga Open	HiCnga Op LF	HiConga Open	Shimedaiko
75	TOM/PERC	LoConga Open	LoConga LoFi	LoConga Open	Shimedaiko
76	TOM/PERC	Hi Timbale	HiTimbale LF	Hi Timbale	Tang Gu Open
77	TOM/PERC	Hi Timbale	LoTimbale LF	Hi Timbale	Tang Gu Mute
78	TOM/PERC	TR727 Agogo	TR727 Agogo	TR727 Agogo	Xiao Bo
79	TOM/PERC	TR727 Agogo	TR727 Agogo	TR727 Agogo	Xiao Bo
80	TOM/PERC	Cabasa Up	TechnoShaker	Cabasa Up	Cabasa Up
81	TOM/PERC	Maracas	808 Maracas	Maracas	TR626 Shaker
82	TOM/PERC	TR727Quijada	TR727Quijada	Whistle	Whistle
83	HIT	Jingle Bell	Belltree	Whistle	Whistle
C6 84	HIT	Short Guiro	Short Guiro	Short Guiro	Short Guiro
85	HIT	Long Guiro	Long Guiro	Long Guiro	Long Guiro
86	HIT	TR808 Claves	TR808 Claves	TR808 Claves	TR808 Claves
87	HIT	Hyoshigi	Hyoshigi	Hyoshigi	Hyoshigi
88	OTHERS	Hyoshigi	Hyoshigi	Hyoshigi	Sitar Drone
89	OTHERS	Whistle	Whistle	Mute Cuica	Triangle 2
90	OTHERS	Whistle	Whistle	Open Cuica	Gt.FretNoise
91	OTHERS	Come on!	Kick it!	Triangle 1	Belltree
92	OTHERS	Vinyl Stop	Scratch BD f	Triangle 1	Wao!
93	OTHERS	Real Clap 1	Funky Clap	Big Clap	Snap
94	CLP	TR808 Kick 2	TR808 Kick 5	Turbo Kick	Old Kick
95	BD	TR909 Kick 3	Turbo Kick	Lo-Fi Kick 1	Analog Kick
C7 96	SD	TR808 Snr 7	TR808 Snr 3	R8 Brush Tap	Hi Timbale
97	SD	TR909 Snr 5	Deep Snare	R&B Snare	Jungle Snr 2

# Effects Template List

## For Patches

Button	Patch name	Multi-Effects type
BANK [1]	P:I13 St.Ac.Piano	REVERB
BANK [2]	P:E28 Ac.Piano 1	COMPRESSOR
BANK [3]	P:I21 Rhodes	AUTO-PAN
BANK [4]	P:I23 Tremolo EP	PHASER
BANK [5]	P:I28 Tria Bells	TETRA-CHRS
BANK [6]	P:I35 E.Organ 1	Lo-Fi
BANK [7]	P:I51 Nylon Gtr 1	4-BAND-EQ
BANK [8]	P:I72 Sitar/Drone	4-BAND-EQ
NUMBER [1]	P:I82 St.Strings 2	4-BAND-EQ
NUMBER [2]	P:I88 Film Octaves	4-BAND-EQ
NUMBER [3]	P:J27 BrassSect.1	4-BAND-EQ
NUMBER [4]	P:J53 T.Sax SW	4-BAND-EQ
NUMBER [5]	P:A86 The Brothers	DISTORTION
NUMBER [6]	P:J66 5th Pad 305	FLANGER
NUMBER [7]	P:C66 Sub Atmosphe	ST-FLANGER
NUMBER [8]	P:C41 Sweep Pad 2	SLICER

## For Rhythm Sets

Button	Rhythm set name	Multi-Effects type
BANK [1]	P:B13 Power 1	ENHANCER
BANK [2]	P:B15 Brush 2	4-BAND-EQ
BANK [3]	P:A12 TR-808	GATE-REVRB
BANK [4]	P:A17 Techno 3	FB-P-SHIFT
BANK [5]	P:A33 Jazz	PHASER
BANK [6]	P:A37 Rock	SPECTRUM
BANK [7]	P:A25 Drum'n'Bass1	ENHANCER
BANK [8]	P:A24 Jungle	DISTORTION
NUMBER [1]	P:A27 Hip-Hop 1	OVERDRIVE
NUMBER [2]	P:A12 TR-808	SPACE-D
NUMBER [3]	P:A27 Hip-Hop 1	Lo-Fi
NUMBER [4]	P:A36 Ragga	COMPRESSOR
NUMBER [5]	P:A27 Hip-Hop 1	NOISE
NUMBER [6]	P:A38 Industrial	Lo-Fi
NUMBER [7]	P:A12 TR-808	AUTO-PAN
NUMBER [8]	P:B16 Indasia	4-BAND-EQ

# Preset Pattern List

The sounds, phrases and patterns contained in this product are sound recordings protected by copyright. Roland hereby grants to purchasers of this product the permission to utilize the sound recordings contained in this product for the creation and recording of original musical works; provided however, the sound recordings contained in this product may not be sampled, downloaded or otherwise re-recorded, in whole or in part, for any other purpose, including but not limited to the transmission of all or any part of the sound recordings via the internet or other digital or analog means of transmission, and/or the manufacture, for sale or otherwise, of any collection of sampled sounds, phrases or patterns, on CD-ROM or equivalent means.

The sound recordings contained in this product are the original works of Roland Corporation. Roland is not responsible for the use of the sound recordings contained in this product, and assumes no liability for any infringement of any copyright of any third party arising out of use of the sounds, phrases and patterns in this product.

## Techno

No.	Name	BPM	Measures	Mute	Programmer
P:A11	Psy Trance 1	142	4	3, 6, 7	MASA
P:A12	Psy Trance 2	145	4	4, 5, 7	MASA
P:A13	Psy Trance 3	145	4	3, 4, 7	MASA
P:A14	Psy Trance 4	145	4	4, 6, 7	MASA
P:A15	Psy Trance 5	138	4	5, 6, 7	MASA
P:A16	Psy Trance 6	142	4	3, 4	MASA
P:A17	Psy Trance 7	144	4	3, 4, 7	MASA
P:A18	Psy Trance 8	143	4	4, 6, 7	MASA
P:A21	Psy Trance 9	145	4	3, 6, 7	MASA
P:A22	Psy Trance 10	145	4	4, 6	MASA
P:A23	Psy Trance 11	145	4	4, 6	MASA
P:A24	Psy Trance 12	142	4	5, 6, 7	MASA
P:A25	Psy Trance 13	143	4	3, 6, 7	MASA
P:A26	Psy Trance 14	145	4	5, 6	MASA
P:A27	Psy Trance 15	135	4	3, 7	MASA
P:A28	Psy Trance 16	142	4	5	MASA
P:A31	Psy Trance 17	147	4	4, 6	MASA
P:A32	Psy Trance 18	141	4	5, 6	MASA
P:A33	Trance 1	146	4	6, 7	MASA
P:A34	Trance 2	136	8	CY	DJ Q'HEY
P:A35	Trance 3	138	4	3, 4, CY	DJ Q'HEY
P:A36	Trance 4	140	8		DJ Q'HEY
P:A37	Trance 5	145	4	3, 4, 6	MASA
P:A38	Trance 6	119	4	4, 5, 7	MASA
P:A41	Trance 7	129	4	4, 6, 7	MASA
P:A42	Trance 8	129	4	7	MASA
P:A43	Trance 9	130	8	3, 7, CY, TP	YOJI BIOMEHANIKA
P:A44	NU-NRG 1	150	2	5	YOJI BIOMEHANIKA
P:A45	NU-NRG 2	152	2	3, 5, 7	YOJI BIOMEHANIKA
P:A46	NU-NRG 3	145	8	6, 7, SD, CY	YOJI BIOMEHANIKA
P:A47	NU-NRG 4	150	8	3, 5, TP	YOJI BIOMEHANIKA
P:A48	NU-NRG 5	140	8	4	YOJI BIOMEHANIKA
P:A51	NU-NRG 6	152	8	5, 6	YOJI BIOMEHANIKA
P:A52	Epic Trance 1	150	4	3, 5	YOJI BIOMEHANIKA
P:A53	Epic Trance 2	148	8	6, C Y	YOJI BIOMEHANIKA
P:A54	Epic Trance 3	148	8	3	YOJI BIOMEHANIKA
P:A55	Minimal 1	135	8	2	DJ Q'HEY
P:A56	Minimal 2	140	4	4	DJ Q'HEY
P:A57	Minimal 3	135	4	SD, TP	HEIGO TANI
P:A58	Minimal 4	135	4	5, CY	DJ Q'HEY
P:A61	Minimal 5	130	2	TP	DJ Q'HEY
P:A62	Minimal 6	138	4	2, CY, TP	DJ Q'HEY
P:A63	Minimal 7	132	4	SD, CY	DJ Q'HEY
P:A64	Minimal 8	140	16		DJ Q'HEY



No.	Name	BPM	Measures	Mute	Programmer
P:A65	Minimal 9	135	4		DJ Q'HEY
P:A66	Minimal 10	140	4	5	DJ Q'HEY
P:A67	Minimal 11	135	4	4, TP	DJ Q'HEY
P:A68	Minimal 12	138	4	4, CY	DJ Q'HEY
P:A71	DetroitTechno 1	132	4	6	HEIGO TANI
P:A72	DetroitTechno 2	150	4	3	HEIGO TANI
P:A73	DetroitTechno 3	140	4	3, CY	HEIGO TANI
P:A74	DetroitTechno 4	132	4	4	DJ Q'HEY
P:A75	DetroitTechno 5	136	8	3	HEIGO TANI
P:A76	DetroitTechno 6	140	4	6	HEIGO TANI
P:A77	Gabba 1	200	2	4, 6, HI	HEIGO TANI
P:A78	Gabba 2	200	4	3, 5	HEIGO TANI
P:A81	Gabba 3	180	4	4	HEIGO TANI
P:A82	Gabba 4	167	4	3, 5	MASA
P:A83	Gabba 5	167	4	5, 6	MASA
P:A84	HappyHardcore 1	175	4	5	YOJI BIOMEHANIKA
P:A85	HappyHardcore 2	190	4	5, 7, CY	YOJI BIOMEHANIKA
P:A86	HappyHardcore 3	175	2	3, 4	YOJI BIOMEHANIKA
P:A87	HappyHardcore 4	175	4	3, 7	YOJI BIOMEHANIKA
P:A88	HappyHardcore 5	175	2	3, 7	YOJI BIOMEHANIKA
P:B11	Rave 1	130	8	7	Roland Corporation
P:B12	Rave 2	130	8	5	Roland Corporation
P:B13	Rave 3	179	8	3	Ryeland Alison
P:B14	Rave 4	179	8	5	Ryeland Alison
P:B15	Rave 5	172	8	6	Ryeland Alison
P:B16	Rave 6	185	8		Ryeland Alison
P:B17	Rave 7	170	8	TP	Ryeland Alison
P:B18	Dream Pop 1	145	4	4, 6	YOJI BIOMEHANIKA
P:B21	Dream Pop 2	130	8	4, 6	YOJI BIOMEHANIKA
P:B22	Dream Pop 3	140	8	5	YOJI BIOMEHANIKA
P:B23	Rock 1	132	4	5, CY, OT	HEIGO TANI
P:B24	Rock 2	130	4	3, CY	HEIGO TANI
P:B25	Rock 3	137	4	6, 7, CY	MASA
P:B26	Rock 4	126	4	3, 4	MASA
P:B27	Rock 5	137	4	4, 6, 7	MASA
P:B28	Rock 6	128	8	6	Vince LaDuca
P:B31	Rock 7	112	4	4	Vince LaDuca
P:B32	Rock 8	128	4	5, 6	Vince LaDuca
P:B33	Industrial 1	125	4	3, 6	HEIGO TANI
P:B34	Industrial 2	132	8	CL, TP	DJ Q'HEY
P:B35	Industrial 3	112	4	5, 7	MASA
P:B36	Industrial 4	90	8	4, 5	HEIGO TANI
P:B37	Industrial 5	128	4	5, 6	MASA
P:B38	Industrial 6	128	4	5, 6	MASA
P:B41	Industrial 7	128	4	5, 6	MASA
P:B42	Industrial 8	128	4	6, 7	MASA
P:B43	Electro 1	122	4	6	Roland Corporation
P:B44	Electro 2	119	8	4	A • L • M • A
P:B45	AmbientTechno 1	130	8	BD	HEIGO TANI
P:B46	AmbientTechno 2	120	16		DJ Q'HEY
P:B47	AmbientTechno 3	120	16		DJ Q'HEY
P:B48	AmbientTechno 4	128	4	4, 5, 7	MASA
P:B51	AmbientTechno 5	120	4	3, 4, 5	MASA
P:B52	AmbientTechno 6	120	4	4, 6, CY	MASA

## Drum'n'Bass

No.	Name	BPM	Measures	Mute	Programmer
P:B53	Artcore 1	165	8	5	DJ khuv
P:B54	Artcore 2	170	8	CL	Roland Corporation
P:B55	Artcore 3	165	16		DJ khuv
P:B56	Artcore 4	165	8	5	DJ khuv
P:B57	Artcore 5	158	16		DJ Q'HEY
P:B58	Drum'n'Bass 1	165	8	4	DJ khuv
P:B61	Drum'n'Bass 2	156	4	5, 6, 7	MASA
P:B62	Drum'n'Bass 3	156	8	4, 6, 7	MASA
P:B63	Drum'n'Bass 4	180	16	5	DJ khuv
P:B64	Drum'n'Bass 5	180	16	5	DJ khuv
P:B65	Drum'n'Bass 6	165	8	4	DJ khuv
P:B66	Darkcore 1	195	8	3	Ryeland Alison
P:B67	Darkcore 2	160	4	3	DJ Q'HEY
P:B68	Darkcore 3	161	8	4	DJ khuv
P:B71	Darkcore 4	148	4	4, 6	MASA
P:B72	Darkcore 5	185	8	4	Ryeland Alison
P:B73	Darkcore 6	185	8	4	Ryeland Alison
P:B74	Hard Step 1	179	8	3	Ryeland Alison
P:B75	Hard Step 2	165	8	4	DJ khuv
P:B76	Hard Step 3	160	4	6	Vince LaDuca
P:B77	Hard Step 4	190	8	4	Ryeland Alison
P:B78	Tech Step 1	165	8		Ryeland Alison
P:B81	Tech Step 2	165	8	3	Ryeland Alison
P:B82	Tech Step 3	157	8	6	Ryeland Alison
P:B83	Jazz Step 1	156	4	6, 7	MASA
P:B84	Jazz Step 2	160	8	5, 6	Vince LaDuca
P:B85	Jazz Step 3	165	8	4	Ryeland Alison
P:B86	Jazz Step 4	197	8		Ryeland Alison
P:B87	Jazz Step 5	170	8		Ryeland Alison
P:B88	Ragga/Jungle 1	180	8	4	Ryeland Alison
P:C11	Ragga/Jungle 2	179	8	4	Ryeland Alison
P:C12	Ragga/Jungle 3	163	8	4	DJ khuv
P:C13	Ragga/Jungle 4	165	8		Ryeland Alison
P:C14	Ragga/Jungle 5	200	8	5	Ryeland Alison

## Hip Hop

No.	Name	BPM	Measures	Mute	Programmer
P:C15	HipHop East 1	93	2		DJ KENT
P:C16	HipHop East 2	93	2		DJ KENT
P:C17	HipHop East 3	95	4		DJ KENT
P:C18	HipHop East 4	95	2		DJ KENT
P:C21	HipHop East 5	95	2	5	DJ KENT
P:C22	HipHop East 6	95	2		DJ KENT
P:C23	HipHop East 7	84	8	7	A • L • M • A
P:C24	HipHop East 8	85	4		A • L • M • A
P:C25	HipHop East 9	89	2		DJ KENT
P:C26	HipHop East 10	89	4	4	DJ KENT
P:C27	HipHop West 1	99	2		DJ KENT
P:C28	HipHop West 2	99	4	5	DJ KENT
P:C31	HipHop West 3	95	4		DJ KENT
P:C32	HipHop West 4	96	4	6, 7	Vince LaDuca
P:C33	HipHop West 5	89	4	3, 5	Vince LaDuca
P:C34	HipHop West 6	96	4		DJ KENT
P:C35	HipHop West 7	92	2		DJ KENT
P:C36	HipHop West 8	92	2	5	DJ KENT
P:C37	HipHop West 9	92	2	6	DJ KENT

No.	Name	BPM	Measures	Mute	Programmer
P:C38	Abstract 1	79	2	3	DJ KENT
P:C41	Abstract 2	77	4	4, 6	A • L • M • A
P:C42	Abstract 3	79	2	3	DJ KENT
P:C43	Abstract 4	94	4	5	Vince LaDuca
P:C44	Abstract 5	94	4	4	Vince LaDuca
P:C45	Abstract 6	92	4	4, 5	Vince LaDuca
P:C46	Abstract 7	67	2	6, 7	A • L • M • A
P:C47	Abstract 8	105	4	7	Vince LaDuca
P:C48	Abstract 9	104	4	4, 5, 7	Vince LaDuca
P:C51	Abstract 10	77	4		Vince LaDuca
P:C52	Abstract 11	100	4	2, 5, 6, 7	Vince LaDuca
P:C53	HipHop Early 1	107	8	CY, OT	A • L • M • A
P:C54	HipHop Early 2	98	4	7	A • L • M • A
P:C55	HipHop Early 3	103	8		A • L • M • A
P:C56	HipHop Early 4	98	8	6	A • L • M • A
P:C57	HipHop Early 5	106	8	6	A • L • M • A
P:C58	HipHop Early 6	100	2		DJ KENT
P:C61	HipHop Early 7	87	2		DJ KENT
P:C62	HipHop Early 8	99	2		DJ KENT
P:C63	NewJack Swing 1	105	8	5	A • L • M • A
P:C64	NewJack Swing 2	110	4	6	A • L • M • A
P:C65	Miami Bass 1	138	8	7	A • L • M • A
P:C66	Miami Bass 2	127	4	5	A • L • M • A
P:C67	HipHop Jazz 1	102	4	3, 5	Vince LaDuca
P:C68	HipHop Jazz 2	99	8	CY	A • L • M • A
P:C71	HipHop Jazz 3	103	8	7	A • L • M • A
P:C72	HipHop Soul 1	76	4	6	A • L • M • A
P:C73	HipHop Soul 2	90	8	7	A • L • M • A
P:C74	HipHop Soul 3	80	4	4, 6	Vince LaDuca
P:C75	HipHop Soul 4	80	4	6	Vince LaDuca

### House

No.	Name	BPM	Measures	Mute	Programmer
P:C76	House 1	123	8	4	SOULMATES MUSICA
P:C77	House 2	123	8	5, CY	SOULMATES MUSICA
P:C78	House 3	123	8	5, 6, 7	SOULMATES MUSICA
P:C81	House 4	128	4	3	SOULMATES MUSICA
P:C82	House 5	122	8	4	SOULMATES MUSICA
P:C83	House 6	122	4	7	A • L • M • A
P:C84	House 7	123	8	5, 7	SOULMATES MUSICA
P:C85	Garage House 1	123	8	SD, CL	SOULMATES MUSICA
P:C86	Garage House 2	125	8	CY, OT	SOULMATES MUSICA
P:C87	Garage House 3	123	8	CY	SOULMATES MUSICA
P:C88	Garage House 4	123	8	5, CY	SOULMATES MUSICA
P:D11	Garage House 5	123	8	BD	SOULMATES MUSICA
P:D12	Garage House 6	120	4	4, CY	SOULMATES MUSICA
P:D13	Hard House 1	128	4	5	HEIGO TANI
P:D14	Hard House 2	130	4	4, 6	HEIGO TANI
P:D15	Hard House 3	128	8	4, 5	SOULMATES MUSICA
P:D16	Hard House 4	128	8	5	SOULMATES MUSICA
P:D17	Hard House 5	123	8	4, 6	SOULMATES MUSICA
P:D18	Hard House 6	128	8	5, SD	SOULMATES MUSICA
P:D21	Hard House 7	130	4	6, TP	HEIGO TANI
P:D22	Hard House 8	130	4	4, TP	HEIGO TANI
P:D23	Hard House 9	130	4	4	HEIGO TANI
P:D24	Hard House 10	130	4	4, 6	HEIGO TANI

No.	Name	BPM	Measures	Mute	Programmer
P:D25	Happy Handbag 1	130	2	6, 7, CY	YOJI BIOMEHANIKA
P:D26	Happy Handbag 2	130	4	4, 7	YOJI BIOMEHANIKA
P:D27	Happy Handbag 3	130	8	CY	SOULMATES MUSICA
P:D28	Happy Handbag 4	128	8	5	SOULMATES MUSICA
P:D31	Happy Handbag 5	128	8	4	SOULMATES MUSICA
P:D32	Euro Beat 1	145	4	5, 7, TP	Roland Corporation
P:D33	Euro Beat 2	128	8	7	Roland Corporation
P:D34	Latin House 1	123	4	3	Roland Corporation
P:D35	Latin House 2	122	8	SD	Roland Corporation
P:D36	Latin House 3	122	8	7	Roland Corporation
P:D37	Latin House 4	122	8	5, CY	SOULMATES MUSICA
P:D38	Latin House 5	125	8	4	Roland Corporation

### Jazz

No.	Name	BPM	Measures	Mute	Programmer
P:D41	Funk 1	126	8	TP	A • L • M • A
P:D42	Funk 2	118	8	7	A • L • M • A
P:D43	Funk 3	118	8	7	A • L • M • A
P:D44	Funk 4	90	8	7	Roland Corporation
P:D45	Funk 5	100	4	6	Roland Corporation
P:D46	Funk 6	95	8	7	Roland Corporation
P:D47	Funk 7	103	8	4	A • L • M • A
P:D48	Jazz 1	103	8	6	A • L • M • A
P:D51	Jazz 2	123	8	4, 5, 7	A • L • M • A
P:D52	Jazz 3	89	8	7	A • L • M • A
P:D53	Jazz 4	130	8	4	Roland Corporation
P:D54	Jazz 5	130	8	7	A • L • M • A

### Reggae

No.	Name	BPM	Measures	Mute	Programmer
P:D55	Dance Hall 1	185	8	HI	A • L • M • A
P:D56	Dance Hall 2	158	8	6	A • L • M • A
P:D57	Dance Hall 3	180	8	5	Vince LaDuca
P:D58	Dance Hall 4	170	8	5	Vince LaDuca
P:D61	Dance Hall 5	188	8	4, 5	Vince LaDuca
P:D62	Lovers 1	181	8	3, 7	A • L • M • A
P:D63	Lovers 2	176	8	6	A • L • M • A
P:D64	Reggae 1	126	8	4,6	A • L • M • A
P:D65	Reggae 2	172	16	4	A • L • M • A

### Latin

No.	Name	BPM	Measures	Mute	Programmer
P:D66	Salsa 1	112	4	5	Scott Tibbs
P:D67	Salsa 2	112	4	5	Scott Tibbs
P:D68	Salsa 3	104	4	5	Scott Tibbs
P:D71	Salsa 4	95	4	4, 6	Scott Tibbs
P:D72	Salsa 5	88	4	4, 6	Scott Tibbs
P:D73	Songo	112	4	5, 6	Scott Tibbs
P:D74	Samba	124	8	2, 3, 4	A • L • M • A
P:D75	ChaCha	84	4	5, 6	Scott Tibbs
P:D76	Merengue	110	2	4, 5, 6, 7	Jeff Fields
P:D77	Mambo 1	90	2	4, 5, 6, 7	Jeff Fields
P:D78	Mambo 2	90	2	4, 5, 6, 7	Jeff Fields

## JX-305 Collection

No.	Name	BPM	Measures	Mute	Programmer
P:D81	Grunge	68	4	3, 6, TP	Scott Tibbs
P:D82	Blues 1	120	16	6	Scott Tibbs
P:D83	Blues 2	128	8	3, 6, TP	Scott Tibbs
P:D84	Slick Groove	94	4	5, 7	Scott Tibbs
P:D85	A.O.R.	112	4	5	Idecs
P:D86	Motown 1	126	4	4, 6	Scott Tibbs
P:D87	Motown 2	130	4	4	Scott Tibbs
P:D88	80s Pop	112	4	5, TP	Idecs
P:E11	Swing	130	4	4	Scott Tibbs
P:E12	India Contemp	112	8	6, BD, SD, TP	Scott Tibbs
P:E13	JX Funk 1	94	4	4, 6, TP	Scott Tibbs
P:E14	JX Funk 2	94	8	4, 5, 6, TP	Scott Tibbs
P:E15	JX Funk 3	104	4		Idecs
P:E16	JX Funk 4	98	8	4, 6	Idecs
P:E17	JX Jazz 1	90	4	6	Idecs
P:E18	JX Jazz 2	106	4		Idecs
P:E21	JXgrooveTRAX 1	140	4	4, 5	Idecs
P:E22	JXgrooveTRAX 2	126	4	HI	Idecs
P:E23	JXgrooveTRAX 3	140	4	TP, HI	Idecs
P:E24	JXgrooveTRAX 4	138	8	5	Idecs
P:E25	JXgrooveTRAX 5	176	8	4	Idecs
P:E26	JXgrooveTRAX 6	106	4		Idecs
P:E27	JXgrooveTRAX 7	106	4	3	Idecs
P:E28	JXgrooveTRAX 8	128	4	6	Idecs
P:E31	JXgrooveTRAX 9	94	4	3	Idecs
P:E32	JXgrooveTRAX 10	90	4	4	Idecs

BD:BD            SD:SD            HH:HH            CLP:CL  
 CYM:CY        TOM/PERC:TP      HIT:HI            OTHERS:OT

## Category table

Category	No.
Techno	P:A11-P:B52
Drum'n'Bass	P:B53-P:C14
Hip Hop	P:C15-P:C75
House	P:C76-P:D38
Jazz	P:D41-P:D54
Reggae	P:D55-P:D65
Latin	P:D66-P:D78
JX-305 Collection	P:D81-P:E32

# RPS Pattern List

## RPS Drum Pattern (Used Rhythm Part)

	Name	BPM	Measures	RPS Set	Keyboard Pad
P:E33	Techno Drums 1	135	2	Trance 1	1
P:E34	Techno Drums 2	135	2	Trance 1	2
P:E35	Techno Drums 3	140	2	Trance 2	1
P:E36	Techno Drums 4	140	2	Trance 2	2
P:E37	Techno Drums 5	150	1	NU-NRG	1
P:E38	Techno Drums 6	150	1	NU-NRG	2
P:E41	Techno Drums 7	136	1	Minimal Techno	1
P:E42	Techno Drums 8	136	1	Minimal Techno	2
P:E43	Techno Drums 9	135	2	Detroit Techno	1
P:E44	Techno Drums 10	135	2	Detroit Techno	2
P:E45	Techno Drums 11	167	2	Hardcore	1
P:E46	Techno Drums 12	167	2	Hardcore	2
P:E47	Techno Drums 13	130	2	Rave	1
P:E48	Techno Drums 14	130	1	Rave	2
P:E51	Techno Drums 15	110	2	Rock	1
P:E52	Techno Drums 16	110	2	Rock	2
P:E53	Techno Drums 17	130	2	Industrial	1
P:E54	Techno Drums 18	130	2	Industrial	2
P:E55	Techno Drums 19	125	2	Ambient Techno	1
P:E56	Techno Drums 20	125	2	Ambient Techno	2
P:E57	D-Bass Drums 1	170	2	Drum'n' Bass 1	1
P:E58	D-Bass Drums 2	170	2	Drum'n' Bass 1	2
P:E61	D-Bass Drums 3	170	1	Drum'n' Bass 2	1
P:E62	D-Bass Drums 4	170	2	Drum'n' Bass 2	2
P:E63	D-Bass Drums 5	170	2	Drum'n' Bass 3	1
P:E64	D-Bass Drums 6	170	2	Drum'n' Bass 3	2
P:E65	D-Bass Drums 7	170	2	Jungle	1
P:E66	D-Bass Drums 8	170	2	Jungle	2
P:E67	HipHop Drums 1	90	2	HipHop East	1
P:E68	HipHop Drums 2	90	2	HipHop East	2
P:E71	HipHop Drums 3	95	1	HipHop West	1
P:E72	HipHop Drums 4	95	2	HipHop West	2
P:E73	HipHop Drums 5	80	2	HipHop Abstract 1	1
P:E74	HipHop Drums 6	80	1	HipHop Abstract 1	2
P:E75	HipHop Drums 7	70	1	HipHop Abstract 2	1
P:E76	HipHop Drums 8	70	2	HipHop Abstract 2	2
P:E77	HipHop Drums 9	95	1	HipHop Early	1
P:E78	HipHop Drums 10	95	2	HipHop Early	2
P:E81	HipHop Drums 11	100	1	HipHop Jazz&Soul	1
P:E82	HipHop Drums 12	100	2	HipHop Jazz&Soul	2
P:E83	House Drums 1	120	1	House	1
P:E84	House Drums 2	120	2	House	2
P:E85	House Drums 3	120	2	Garage House	1
P:E86	House Drums 4	120	2	Garage House	2
P:E87	House Drums 5	130	2	Hard House	1
P:E88	House Drums 6	130	2	Hard House	2
P:F11	House Drums 7	130	1	Happy Handbag	1
P:F12	House Drums 8	130	1	Happy Handbag	2
P:F13	Jazz Drums 1	125	2	Jazz Funk 1	1
P:F14	Jazz Drums 2	125	2	Jazz Funk 1	2
P:F15	Jazz Drums 3	125	2	Jazz Funk 2	1
P:F16	Jazz Drums 4	125	1	Jazz Funk 2	2
P:F17	Reggae Drums 1	190	4	Reggae 1	1
P:F18	Reggae Drums 2	190	4	Reggae 1	2
P:F21	Reggae Drums 3	155	2	Reggae 2	1
P:F22	Reggae Drums 4	155	2	Reggae 2	2
P:F23	Latin Drums 1	110	1	Salsa	1
P:F24	Latin Drums 2	110	1	Salsa	2
P:F25	Latin Drums 3	125	1	Samba	1
P:F26	Latin Drums 4	125	2	Samba	2

## RPS Bass Pattern (Used Part1)

	Name	BPM	Measures	RPS Set	Keyboard Pad
P:F27	Techno Bass 1	135	1	Trance 1	3
P:F28	Techno Bass 2	135	1	Trance 1	4
P:F31	Techno Bass 3	140	2	Trance 2	3
P:F32	Techno Bass 4	140	1	Trance 2	4
P:F33	Techno Bass 5	150	1	NU-NRG	3
P:F34	Techno Bass 6	150	1	NU-NRG	4
P:F35	Techno Bass 7	136	1	Minimal Techno	3
P:F36	Techno Bass 8	136	1	Minimal Techno	4
P:F37	Techno Bass 9	135	1	Detroit Techno	3
P:F38	Techno Bass 10	135	1	Detroit Techno	4
P:F41	Techno Bass 11	167	1	Hardcore	3
P:F42	Techno Bass 12	167	2	Hardcore	4
P:F43	Techno Bass 13	130	1	Rave	3
P:F44	Techno Bass 14	130	2	Rave	4
P:F34	Techno Bass 15	110	1	Rock	3
P:F35	Techno Bass 16	110	2	Rock	4
P:F47	Techno Bass 17	130	2	Industrial	3
P:F48	Techno Bass 18	130	2	Industrial	4
P:F51	Techno Bass 19	125	2	Ambient Techno	3
P:F52	Techno Bass 20	125	1	Ambient Techno	4
P:F53	D-Bass Bass 1	170	2	Drum'n' Bass 1	3
P:F54	D-Bass Bass 2	170	4	Drum'n' Bass 1	4
P:F55	D-Bass Bass 3	170	2	Drum'n' Bass 2	3
P:F56	D-Bass Bass 4	170	2	Drum'n' Bass 2	4
P:F57	D-Bass Bass 5	170	4	Drum'n' Bass 3	3
P:F58	D-Bass Bass 6	170	4	Drum'n' Bass 3	4
P:F61	D-Bass Bass 7	170	2	Jungle	3
P:F62	D-Bass Bass 8	170	2	Jungle	4
P:F63	HipHop Bass 1	90	1	HipHop East	3
P:F64	HipHop Bass 2	90	2	HipHop East	4
P:F65	HipHop Bass 3	95	2	HipHop West	3
P:F66	HipHop Bass 4	95	2	HipHop West	4
P:F67	HipHop Bass 5	80	2	HipHop Abstract 1	3
P:F68	HipHop Bass 6	80	2	HipHop Abstract 1	4
P:F71	HipHop Bass 7	70	1	HipHop Abstract 2	3
P:F72	HipHop Bass 8	70	2	HipHop Abstract 2	4
P:F73	HipHop Bass 9	95	2	HipHop Early	3
P:F74	HipHop Bass 10	95	2	HipHop Early	4
P:F75	HipHop Bass 11	100	2	HipHop Jazz&Soul	3
P:F76	HipHop Bass 12	100	2	HipHop Jazz&Soul	4
P:F77	House Bass 1	120	1	House	3
P:F78	House Bass 2	120	1	House	4
P:F81	House Bass 3	120	2	Garage House	3
P:F82	House Bass 4	120	2	Garage House	4
P:F83	House Bass 5	130	1	Hard House	3
P:F84	House Bass 6	130	1	Hard House	4
P:F85	House Bass 7	130	2	Happy Handbag	3
P:F86	House Bass 8	130	2	Happy Handbag	4
P:F87	Jazz Bass 1	125	2	Jazz Funk 1	3
P:F88	Jazz Bass 2	125	2	Jazz Funk 1	4
P:G11	Jazz Bass 3	125	2	Jazz Funk 2	3
P:G12	Jazz Bass 4	125	2	Jazz Funk 2	4
P:G13	Reggae Bass 1	190	4	Reggae 1	3
P:G14	Reggae Bass 2	190	2	Reggae 1	4
P:G15	Reggae Bass 3	155	2	Reggae 2	3
P:G16	Reggae Bass 4	155	2	Reggae 2	4
P:G17	Latin Bass 1	110	2	Salsa	3
P:G18	Latin Bass 2	110	1	Salsa	4
P:G21	Latin Bass 3	125	2	Samba	3
P:G22	Latin Bass 4	125	1	Samba	4

## RPS Rhythm Fill in (Used Part1)

	Name	BPM	Measures	RPS Set	Keyboard Pad
P:G23	BD Fill 1	150	1	NU-NRG	8
P:G24	BD Fill 2	136	1	Minimal Techno	8
P:G25	BD Fill 3	167	1	Hardcore	7
P:G26	BD Fill 4	130	2	Industrial	6
P:G27	BD Fill 5	125	1	Ambient Techno	6
P:G28	BD Fill 6	170	1	Drum'n' Bass 2	6
P:G31	BD Fill 7	170	1	Drum'n' Bass 3	7
P:G32	BD Fill 8	170	2	Jungle	8
P:G33	BD Loop 1	120	2	Garage House	8
P:G34	BD Loop 2	130	2	Hard House	7
P:G35	CHH Fill 1	140	1	Trance 2	7
P:G36	CHH Fill 2	100	1	HipHop Jazz&Soul	7
P:G37	CHH Fill 3	190	1	Reggae 1	8
P:G38	CHH Fill 4	155	1	Reggae 2	8
P:G41	LowCHH Loop 1	135	2	Detroit Techno	8
P:G42	LowCHH Loop 2	80	1	HipHop Abstract 1	8
P:G43	LowCHH Loop 3	130	1	Hard House	6
P:G44	RideCym Fill	70	1	HipHop Abstract 2	5
P:G45	RideCym Loop 1	136	1	Minimal Techno	7
P:G46	RideCym Loop 2	170	1	Jungle	7
P:G47	RideCym Loop 3	100	1	HipHop Jazz&Soul	8
P:G48	RideCym Loop 4	130	1	Happy Handbag	8
P:G51	RideCym Loop 5	125	2	Jazz Funk 1	7
P:G52	RideCym Loop 6	125	1	Jazz Funk 2	5
P:G53	Clap Fill 1	150	1	NU-NRG	7
P:G54	Clap Fill 2	167	1	Hardcore	6
P:G55	Clap Fill 3	80	1	HipHop Abstract 1	6
P:G56	Clap Fill 4	95	2	HipHop Early	5
P:G57	Clap Fill 5	100	1	HipHop Jazz&Soul	6
P:G58	Clap Fill 6	120	1	House	6
P:G61	Clap Fill 7	120	1	Garage House	7
P:G62	Clap Fill 8	130	1	Hard House	8
P:G63	Crash Loop 1	135	2	Trance 1	8
P:G64	Crash Loop 2	167	1	Hardcore	5
P:G65	Snare Fill 1	135	1	Trance 1	5
P:G66	Snare Fill 2	135	1	Trance 1	7
P:G67	Snare Fill 3	140	1	Trance 2	5
P:G68	Snare Fill 4	140	1	Trance 2	8
P:G71	Snare Fill 5	150	1	NU-NRG	5
P:G72	Snare Fill 6	150	1	NU-NRG	6
P:G73	Snare Fill 7	136	1	Minimal Techno	5
P:G74	Snare Fill 8	135	1	Detroit Techno	5
P:G75	Snare Fill 9	135	1	Detroit Techno	7
P:G76	Snare Fill 10	167	1	Hardcore	8
P:G77	Snare Fill 11	130	1	Rave	5
P:G78	Snare Fill 12	130	1	Rave	7
P:G81	Snare Fill 13	130	1	Rave	8
P:G82	Snare Fill 14	110	1	Rock	5
P:G83	Snare Fill 15	110	1	Rock	7
P:G84	Snare Fill 16	110	1	Rock	8
P:G85	Snare Fill 17	125	1	Ambient Techno	5
P:G86	Snare Fill 18	170	1	Drum'n' Bass 1	5
P:G87	Snare Fill 19	170	1	Drum'n' Bass 1	6
P:G88	Snare Fill 20	170	1	Drum'n' Bass 1	7
P:H11	Snare Fill 21	170	1	Drum'n' Bass 2	5
P:H12	Snare Fill 22	170	1	Drum'n' Bass 2	7
P:H13	Snare Fill 23	170	1	Drum'n' Bass 2	8
P:H14	Snare Fill 24	170	1	Drum'n' Bass 3	5
P:H15	Snare Fill 25	170	2	Drum'n' Bass 3	6
P:H16	Snare Fill 26	170	1	Drum'n' Bass 3	8
P:H17	Snare Fill 27	170	1	Jungle	5
P:H18	Snare Fill 28	170	1	Jungle	6



	Name	BPM	Measures	RPS Set	Keyboard Pad
P:H21	Snare Fill 29	80	1	HipHop Abstract 1	5
P:H22	Snare Fill 30	120	1	House	5
P:H23	Snare Fill 31	120	1	House	7
P:H24	Snare Fill 32	120	1	House	8
P:H25	Snare Fill 33	120	1	Garage House	5
P:H26	Snare Fill 34	130	4	Hard House	5
P:H27	Snare Fill 35	130	2	Happy Handbag	5
P:H28	Snare Fill 36	130	1	Happy Handbag	6
P:H31	Snare Fill 37	130	1	Happy Handbag	7
P:H32	Snare Fill 38	125	1	Jazz Funk 1	5
P:H33	Snare Fill 39	125	1	Jazz Funk 1	6
P:H34	Snare Fill 40	125	1	Jazz Funk 1	8
P:H35	Snare Fill 41	125	1	Jazz Funk 2	6
P:H36	Snare Fill 42	125	1	Jazz Funk 2	7
P:H37	Snare Fill 43	125	1	Jazz Funk 2	8
P:H38	Snare Fill 44	190	1	Reggae 1	6
P:H41	Snare Fill 45	155	1	Reggae 2	6
P:H42	Snare Fill 46	155	1	Reggae 2	7
P:H43	Snare Fill 47	125	1	Samba	7
P:H44	Snare Fill 48	125	1	Samba	8
P:H34	Tambourine 1	170	1	Drum'n' Bass 1	8
P:H35	Tambourine 2	90	1	HipHop East	5
P:H47	Tambourine 3	95	1	HipHop West	6
P:H48	Tom Fill 1	130	1	Rave	6
P:H51	Tom Fill 2	110	1	Rock	6
P:H52	Tom Fill 3	130	1	Industrial	8
P:H53	Tom Fill 4	95	1	HipHop West	8
P:H54	Tom Fill 5	95	1	HipHop Early	6
P:H55	Tom Fill 6	95	1	HipHop Early	7
P:H56	Tom Fill 7	190	2	Reggae 1	5
P:H57	Tom Fill 8	190	1	Reggae 1	7
P:H58	Tom Fill 9	155	1	Reggae 2	5
P:H61	Agogo Loop 1	110	1	Salsa	8
P:H62	Agogo Loop 2	125	2	Samba	14
P:H63	Bell Fill	135	1	Trance 1	6
P:H64	Bongo	125	2	Samba	13
P:H65	Cowbell Loop 1	136	1	Minimal Techno	6
P:H66	Cowbell Loop 2	110	1	Salsa	7
P:H67	Gunshot	95	1	HipHop West	7
P:H68	Industry Fill 1	130	1	Industrial	5
P:H71	Industry Fill 2	130	1	Industrial	7
P:H72	Perc Fill 1	140	1	Trance 2	6
P:H73	Perc Fill 2	125	1	Ambient Techno	7
P:H74	Perc Fill 3	70	1	HipHop Abstract 2	6
P:H75	Perc Fill 4	70	1	HipHop Abstract 2	8
P:H76	Perc Fill 5	100	1	HipHop Jazz&Soul	5
P:H77	Perc Fill 6	120	1	Garage House	6
P:H78	Perc Loop 1	135	1	Detroit Techno	6
P:H81	Perc Loop 2	125	1	Ambient Techno	8
P:H82	Perc Loop 3	70	1	HipHop Abstract 2	7
P:H83	Scratch 1	90	1	HipHop East	6
P:H84	Scratch 2	90	1	HipHop East	7
P:H85	Scratch 3	90	1	HipHop East	8
P:H86	Scratch 4	95	1	HipHop West	5
P:H87	Scratch 5	80	1	HipHop Abstract 1	7
P:H88	Scratch 6	95	1	HipHop Early	8
P:I11	Surdo Loop 1	125	2	Samba	5
P:I12	Surdo Loop 2	125	1	Samba	6
P:I13	Timbales Fill 1	110	1	Salsa	5
P:I14	Timbales Fill 2	110	1	Salsa	6
P:I15	Whistle Loop	167	1	Hardcore	15

## RPS Accompaniment (Used Part1)

	Name	BPM	Measures	RPS Set	Keyboard Pad
P:116	Brass 1	125	2	Jazz Funk 1	14
P:117	Brass 2	125	1	Jazz Funk 2	13
P:118	Brass 3	155	1	Reggae 2	15
P:121	Brass 4	110	2	Salsa	12
P:122	Brass 5	110	2	Salsa	13
P:123	E.Piano Lead 1	80	1	HipHop Abstract 1	11
P:124	E.Piano Lead 2	95	1	HipHop Early	12
P:125	E.Piano Chord 1	170	2	Jungle	9
P:126	E.Piano Chord 2	90	1	HipHop East	10
P:127	E.Piano Chord 3	80	1	HipHop Abstract 1	12
P:128	E.Piano Chord 4	70	2	HipHop Abstract 2	9
P:131	E.Piano Chord 5	100	2	HipHop Jazz&Soul	11
P:132	E.Piano Chord 6	120	2	Garage House	12
P:133	E.Piano Chord 7	120	2	Garage House	13
P:134	E.Piano Chord 8	125	2	Jazz Funk 2	11
P:135	SFX 1	140	2	Trance 2	14
P:136	SFX 2	136	1	Minimal Techno	13
P:137	SFX 3	136	1	Minimal Techno	14
P:138	SFX 4	135	1	Detroit Techno	13
P:141	SFX 5	135	1	Detroit Techno	14
P:142	SFX 6	167	2	Hardcore	14
P:143	SFX 7	130	2	Rave	14
P:144	SFX 8	110	1	Rock	14
P:145	SFX 9	130	1	Industrial	12
P:146	SFX 10	130	2	Industrial	13
P:147	SFX 11	130	2	Industrial	14
P:148	SFX 12	125	4	Ambient Techno	13
P:151	SFX 13	125	1	Ambient Techno	14
P:152	SFX 14	170	2	Drum'n' Bass 1	12
P:153	SFX 15	170	2	Drum'n' Bass 1	13
P:154	SFX 16	170	2	Drum'n' Bass 1	14
P:155	SFX 17	170	1	Drum'n' Bass 2	14
P:156	SFX 18	170	4	Drum'n' Bass 3	13
P:157	SFX 19	170	4	Drum'n' Bass 3	14
P:158	SFX 20	80	1	HipHop Abstract 1	14
P:161	SFX 21	70	2	HipHop Abstract 2	12
P:162	SFX 22	70	2	HipHop Abstract 2	13
P:163	SFX 23	70	2	HipHop Abstract 2	14
P:164	SFX 24	130	2	Hard House	14
P:165	Guitar Chord 1	90	1	HipHop East	12
P:166	Guitar Chord 2	95	2	HipHop West	9
P:167	Guitar Chord 3	95	1	HipHop Early	9
P:168	Guitar Chord 4	190	4	Reggae 1	13
P:171	Guitar Chord 5	155	2	Reggae 2	12
P:172	Guitar Lead	90	2	HipHop East	13
P:173	Guitar Riff 1	150	2	NU-NRG	11
P:174	Guitar Riff 2	130	2	Rave	10
P:175	Guitar Riff 3	110	2	Rock	9
P:176	Guitar Riff 4	110	1	Rock	10
P:177	Guitar Riff 5	100	1	HipHop Jazz&Soul	14
P:178	Guitar Riff 6	125	2	Jazz Funk 1	10
P:181	Guitar Riff 7	125	2	Jazz Funk 1	11
P:182	Guitar Riff 8	125	2	Jazz Funk 1	12
P:183	Guitar Riff 9	155	2	Reggae 2	13
P:184	Guitar Riff 10	155	2	Reggae 2	14
P:185	G Laughter	95	1	HipHop West	14
P:186	Marimba	110	1	Salsa	14
P:187	Organ Chord 1	90	2	HipHop East	9
P:188	Organ Chord 2	90	2	HipHop East	11
P:J11	Organ Chord 3	120	2	Garage House	14
P:J12	Organ chord 4	130	2	Hard House	9
P:J13	Organ Chord 5	125	2	Jazz Funk 1	9

	<b>Name</b>	<b>BPM</b>	<b>Measures</b>	<b>RPS Set</b>	<b>Keyboard Pad</b>
P:J14	Organ Chord 6	125	2	Jazz Funk 2	10
P:J15	Organ Chord 7	190	4	Reggae 1	11
P:J16	Organ Chord 8	190	4	Reggae 1	12
P:J17	Organ Chord 9	155	2	Reggae 2	10
P:J18	Organ Chord 10	155	2	Reggae 2	11
P:J21	Organ Lead 1	170	2	Jungle	14
P:J22	Organ Lead 2	95	2	HipHop West	11
P:J23	Organ Lead 3	120	1	House	14
P:J24	Piano Chord 1	170	2	Drum'n' Bass 2	9
P:J25	Piano Chord 2	170	2	Jungle	10
P:J26	Piano Chord 3	95	2	HipHop Early	11
P:J27	Piano Chord 4	100	2	HipHop Jazz&Soul	12
P:J28	Piano Chord 5	120	2	House	10
P:J31	Piano Chord 6	120	4	House	11
P:J32	Piano Chord 7	120	2	Garage House	11
P:J33	Piano Chord 8	130	2	Hard House	10
P:J34	Piano Chord 9	130	2	Happy Handbag	9
P:J35	Piano Chord 10	125	2	Jazz Funk 2	9
P:J36	Piano Chord 11	190	2	Reggae 1	9
P:J37	Piano Chord 12	190	4	Reggae 1	10
P:J38	Piano Chord 13	155	2	Reggae 2	9
P:J41	Piano Chord 14	110	4	Salsa	9
P:J42	Piano Chord 15	110	2	Salsa	10
P:J43	Piano Chord 16	110	2	Salsa	11
P:J44	Phono Noise	90	1	HipHop East	16
P:J45	Piano Seq	167	1	Hardcore	9
P:J46	Synth Lead 1	170	4	Drum'n' Bass 1	11
P:J47	Synth Lead 2	170	4	Jungle	13
P:J48	Synth Lead 3	95	2	HipHop West	12
P:J51	Synth Lead 4	70	2	HipHop Abstract 2	11
P:J52	Synth Lead 5	95	2	HipHop Early	13
P:J53	Synth Lead 6	95	1	HipHop Early	14
P:J54	Synth Lead 7	100	2	HipHop Jazz&Soul	13
P:J55	Synth Lead 8	125	2	Samba	11
P:J56	Str.Obligato 1	95	4	HipHop West	10
P:J57	Str.Obligato 2	80	2	HipHop Abstract 1	10
P:J58	Str.Obligato 3	130	4	Hard House	13
P:J61	Synth Pad 1	135	4	Trance 1	9
P:J62	Synth Pad 2	140	4	Trance 2	9
P:J63	Synth Pad 3	150	4	NU-NRG	9
P:J64	Synth Pad 4	135	4	Detroit Techno	9
P:J65	Synth Pad 5	130	2	Rave	9
P:J66	Synth Pad 6	125	4	Ambient Techno	9
P:J67	Synth Pad 7	170	4	Drum'n' Bass 1	9
P:J68	Synth Pad 8	170	2	Drum'n' Bass 1	10
P:J71	Synth Pad 9	170	2	Drum'n' Bass 3	9
P:J72	Synth Pad 10	70	2	HipHop Abstract 2	10
P:J73	Synth Pad 11	100	2	HipHop Jazz&Soul	9
P:J74	Synth Pad 12	100	4	HipHop Jazz&Soul	10
P:J75	Synth Pad 13	120	2	Garage House	9
P:J76	Synth Pad 14	120	2	Garage House	10
P:J77	Synth Pad 15	125	4	Jazz Funk 2	12
P:J78	Synth Pad 16	125	2	Samba	9
P:J81	Synth Pad 17	125	2	Samba	10
P:J82	Synth Riff 1	135	2	Trance 1	10
P:J83	Synth Riff 2	135	2	Trance 1	12
P:J84	Synth Riff 3	135	2	Trance 1	14
P:J85	Synth Riff 4	140	2	Trance 2	10
P:J86	Synth Riff 5	140	2	Trance 2	11
P:J87	Synth Riff 6	140	2	Trance 2	12
P:J88	Synth Riff 7	150	2	NU-NRG	10
P:K11	Synth Riff 8	150	2	NU-NRG	12

	Name	BPM	Measures	RPS Set	Keyboard Pad
P:K12	Synth Riff 9	150	2	NU-NRG	13
P:K13	Synth Riff 10	136	1	Minimal Techno	9
P:K14	Synth Riff 11	167	2	Hardcore	10
P:K15	Synth Riff 12	167	2	Hardcore	11
P:K16	Synth Riff 13	167	2	Hardcore	12
P:K17	Synth Riff 14	167	2	Hardcore	13
P:K18	Synth Riff 15	130	2	Rave	11
P:K21	Synth Riff 16	130	1	Rave	12
P:K22	Synth Riff 17	130	1	Rave	13
P:K23	Synth Riff 18	110	1	Rock	13
P:K24	Synth Riff 19	125	2	Ambient Techno	10
P:K25	Synth Riff 20	170	2	Drum'n' Bass 2	11
P:K26	Synth Riff 21	170	2	Drum'n' Bass 2	12
P:K27	Synth Riff 22	170	2	Drum'n' Bass 3	10
P:K28	Synth Riff 23	95	1	HipHop West	13
P:K31	Synth Riff 24	80	2	HipHop Abstract 1	9
P:K32	Synth Riff 25	95	1	HipHop Early	10
P:K33	Synth Riff 26	120	1	House	9
P:K34	Synth Riff 27	130	2	Hard House	11
P:K35	Synth Riff 28	136	2	Hard House	12
P:K36	Synth Riff 29	130	2	Happy Handbag	10
P:K37	Synth Riff 30	130	2	Happy Handbag	11
P:K38	Synth Riff 31	130	2	Happy Handbag	12
P:K41	Synth Riff 32	130	2	Happy Handbag	13
P:K42	Synth Riff 33	130	2	Happy Handbag	14
P:K43	Synth Seq 1	135	1	Trance 1	13
P:K44	Synth Seq 2	140	2	Trance 2	13
P:K45	Synth Seq 3	136	1	Minimal Techno	10
P:K46	Synth Seq 4	150	2	NU-NRG	14
P:K47	Synth Seq 5	136	1	Minimal Techno	11
P:K48	Synth Seq 6	136	1	Minimal Techno	12
P:K51	Synth Seq 7	135	2	Detroit Techno	10
P:K52	Synth Seq 8	135	1	Detroit Techno	11
P:K53	Synth Seq 9	135	1	Detroit Techno	12
P:K54	Synth Seq 10	110	1	Rock	11
P:K55	Synth Seq 11	130	2	Industrial	9
P:K56	Synth Seq 12	130	2	Industrial	10
P:K57	Synth Seq 13	130	1	Industrial	11
P:K58	Synth Seq 14	125	1	Ambient Techno	11
P:K61	Synth Seq 15	125	1	Ambient Techno	12
P:K62	Synth Seq 16	170	1	Drum'n' Bass 2	13
P:K63	Synth Seq 17	170	1	Jungle	11
P:K64	Synth Seq 18	170	4	Jungle	12
P:K65	Synth Seq 19	120	2	House	13
P:K66	Synth Seq 20	125	1	Jazz Funk 1	13
P:K67	Synth Seq 21	125	2	Samba	12
P:K68	Vibe Lead	90	2	HipHop East	14
P:K71	Vox 1	135	2	Trance 1	11
P:K72	Vox 2	110	2	Rock	12
P:K73	Vox 3	170	2	Drum'n' Bass 2	10
P:K74	Vox 4	170	2	Drum'n' Bass 3	11
P:K75	Vox 5	170	4	Drum'n' Bass 3	12
P:K76	Vox 6	80	2	HipHop Abstract 1	13
P:K77	Vox 7	120	2	House	12
P:K78	Voice Riff	125	1	Jazz Funk 2	14

## RPS Hit (Used Part1)

	Name	BPM	Measures	RPS Set	Keyboard Pad
P:K81	Bird	125	1	Ambient Techno	16
P:K82	Brass Fall 1	170	1	Jungle	15
P:K83	Brass Fall 2	110	1	Salsa	15
P:K84	Brass Hit	95	2	Reggae 1	14
P:K85	Blip Hit 1	135	1	Trance 1	16
P:K86	Blip Hit 2	190	1	Reggae 1	15
P:K87	Crash Cymbal	150	1	NU-NRG	16
P:K88	SFX Hit 1	140	1	Trance 2	16
P:L11	SFX Hit 2	136	1	Minimal Techno	15
P:L12	SFX Hit 3	136	1	Minimal Techno	16
P:L13	SFX Hit 4	135	1	Detroit Techno	15
P:L14	SFX Hit 5	135	1	Detroit Techno	16
P:L15	SFX Hit 7	170	1	Drum'n' Bass 1	15
P:L16	SFX Hit 8	70	1	HipHop Abstract 2	16
P:L17	SFX Hit 9	130	1	Hard House	15
P:L18	SFX Hit 10	155	1	Reggae 2	16
P:L21	HipHop Hit 1	90	2	HipHop East	15
P:L22	HipHop Hit 2	95	1	HipHop West	15
P:L23	HipHop Hit 3	95	1	HipHop Early	15
P:L24	Happy Hit	150	2	NU-NRG	15
P:L25	Industry Hit 1	135	1	Trance 1	15
P:L26	Industry Hit 2	110	1	Rock	15
P:L27	Industry Hit 3	130	1	Industrial	16
P:L28	Industry Hit 4	170	1	Drum'n' Bass 1	16
P:L31	Industry Hit 5	170	1	Drum'n' Bass 2	16
P:L32	Industry Hit 6	170	1	Drum'n' Bass 3	15
P:L33	Industry Hit 7	170	1	Drum'n' Bass 3	16
P:L34	Industry Hit 8	130	1	Hard House	16
P:L35	Orchestra Hit 1	167	1	Hardcore	16
P:L36	Orchestra Hit 2	130	1	Rave	15
P:L37	Orchestra Hit 3	170	2	Drum'n' Bass 2	15
P:L38	Orchestra Hit 4	120	1	Garage House	16
P:L41	Orchestra Hit 5	95	1	Happy Handbag	15
P:L42	Piano Delay	125	2	Ambient Techno	15
P:L43	Voice Hit 1	130	1	Rave	16
P:L44	Voice Hit 2	110	1	Rock	16
P:L45	Voice Hit 3	95	1	HipHop West	16
P:L46	Voice Hit 4	95	1	HipHop Early	16
P:L47	Voice Hit 5	100	1	HipHop Jazz&Soul	15
P:L48	Voice Hit 6	120	1	House	15
P:L51	Voice Hit 7	130	1	Happy Handbag	16
P:L52	Voice Hit 8	125	1	Jazz Funk 1	15
P:L53	Whistle Hit 1	170	1	Jungle	16
P:L54	Whistle Hit 2	125	1	Samba	15

---

## RPS JX-305 Collection (Used Part1)

	<b>Name</b>	<b>BPM</b>	<b>Measures</b>
P:L55	E.PianoChord 9	65	2
P:L56	E.PianoChord 10	95	4
P:L57	Piano Chord 17	110	4
P:L58	Piano Chord 18	110	4
P:L61	E.PianoChord 11	95	4
P:L62	Piano Chord 19	120	2
P:L63	Organ Chord 11	125	4
P:L64	Organ Chord 12	90	4
P:L65	Clavi Riff 1	90	2
P:L66	Clavi Riff 2	90	2
P:L67	Str.Obligato 4	90	2
P:L68	Guitar Riff 11	80	1
P:L71	Guitar Lead 2	75	2
P:L72	Guitar Chord 6	70	4
P:L73	Guitar Riff 12	90	2
P:L74	Harp Arp.	90	1
P:L75	Sitar Lead	60	2
P:L76	Brass 6	110	2
P:L77	Brass 7	70	1
P:L78	Brass 8	110	2
P:L81	Brass 9	125	4
P:L82	Brass 10	95	1
P:L83	Brass 11	95	2
P:L84	Brass 12	90	2
P:L85	Synth Lead 9	90	1
P:L86	Synth Seq 22	90	1
P:L87	Synth Riff 34	95	1
P:L88	Synth Seq 23	100	2

# RPS Set List

\* U:47–U:84 have the same contents as U:11–U:46.

\* The number at the right of each RPS set is the recommended tempo when using that set.

## U:11 Trance1 (BPM=135)

1	Techno Drums 1	P:E33
2	Techno Drums 2	P:E34
3	Techno Bass 1	P:F27
4	Techno Bass 2	P:F28
5	Snare Fill 1	P:G65
6	Bell Fill	P:H63
7	Snare Fill 2	P:G66
8	Crash Loop 1	P:G63
9	Synth Pad 1	P:J61
10	Synth Riff 1	P:J82
11	Vox 1	P:K71
12	Synth Riff 2	P:J83
13	Synth Seq 1	P:K43
14	Synth Riff 3	P:J84
15	Industry Hit 1	P:L25
16	Blip Hit 1	P:K85

## U:14 Minimal Techno (BPM=136)

1	Techno Drums 7	P:E41
2	Techno Drums 8	P:E42
3	Techno Bass 7	P:F35
4	Techno Bass 8	P:F36
5	Snare Fill 7	P:G73
6	Cowbell Loop 1	P:H65
7	RideCym Loop 1	P:G45
8	BD Fill 2	P:G24
9	Synth Riff 10	P:K13
10	Synth Seq 3	P:K45
11	Synth Seq 5	P:K47
12	Synth Seq 6	P:K48
13	SFX 2	P:I36
14	SFX 3	P:I37
15	SFX Hit 2	P:L11
16	SFX Hit 3	P:L12

## U:17 Rave (BPM=130)

1	Techno Drums 13	P:E47
2	Techno Drums 14	P:E48
3	Techno Bass 13	P:F43
4	Techno Bass 14	P:F44
5	Snare Fill 11	P:G77
6	Tom Fill 1	P:H48
7	Snare Fill 12	P:G78
8	Snare Fill 13	P:G81
9	Synth Pad 5	P:J65
10	Guitar Riff 2	P:I74
11	Synth Riff 15	P:K18
12	Synth Riff 16	P:K21
13	Synth Riff 17	P:K22
14	SFX 7	P:I43
15	Orchestra Hit 2	P:L36
16	Voice Hit 1	P:L43

## U:12 Trance2 (BPM=140)

1	Techno Drums 3	P:E35
2	Techno Drums 4	P:E36
3	Techno Bass 3	P:F31
4	Techno Bass 4	P:F32
5	Snare Fill 3	P:G67
6	Perc Fill 1	P:H72
7	CHH Fill 1	P:G35
8	Snare Fill 4	P:G68
9	Synth Pad 2	P:J62
10	Synth Riff 4	P:J85
11	Synth Riff 5	P:J86
12	Synth Riff 6	P:J87
13	Synth Seq 2	P:K44
14	SFX 1	P:I35
15	Industry Hit 1	P:L25
16	SFX Hit 1	P:K88

## U:15 Detroit Techno (BPM=135)

1	Techno Drums 9	P:E43
2	Techno Drums 10	P:E44
3	Techno Bass 9	P:F37
4	Techno Bass 10	P:F38
5	Snare Fill 8	P:G74
6	Perc Loop 1	P:H78
7	Snare Fill 9	P:G75
8	LowCHH Loop 1	P:G41
9	Synth Pad 4	P:J64
10	Synth Seq 7	P:K51
11	Synth Seq 8	P:K52
12	Synth Seq 9	P:K53
13	SFX 4	P:I38
14	SFX 5	P:I41
15	SFX Hit 4	P:L13
16	SFX Hit 5	P:L14

## U:18 Rock (BPM=110)

1	Techno Drums 15	P:E51
2	Techno Drums 16	P:E52
3	Techno Bass 15	P:F45
4	Techno Bass 16	P:F46
5	Snare Fill 14	P:G82
6	Tom Fill 2	P:H51
7	Snare Fill 15	P:G83
8	Snare Fill 16	P:G84
9	Guitar Riff 3	P:I75
10	Guitar Riff 4	P:I76
11	Synth Seq 10	P:K54
12	Vox 2	P:K72
13	Synth Riff 18	P:K23
14	SFX 8	P:I44
15	Industry Hit 2	P:L26
16	Voice Hit 2	P:L44

## U:13 NU-NRG (BPM=150)

1	Techno Drums 5	P:E37
2	Techno Drums 6	P:E38
3	Techno Bass 5	P:F33
4	Techno Bass 6	P:F34
5	Snare Fill 5	P:G71
6	Snare Fill 6	P:G72
7	Clap Fill 1	P:G53
8	BD Fill 1	P:G23
9	Synth Pad 3	P:J63
10	Synth Riff 7	P:J88
11	Guitar Riff 1	P:I73
12	Synth Riff 8	P:K11
13	Synth Riff 9	P:K12
14	Synth Seq 4	P:K46
15	Happy Hit	P:L24
16	Crash Cymbal	P:K87

## U:16 Hardcore (BPM=167)

1	Techno Drums 11	P:E45
2	Techno Drums 12	P:E46
3	Techno Bass 11	P:F41
4	Techno Bass 12	P:F42
5	Crash Loop 2	P:G64
6	Clap Fill 2	P:G54
7	BD Fill 3	P:G25
8	Snare Fill 10	P:G76
9	Piano Seq	P:J45
10	Synth Riff 11	P:K14
11	Synth Riff 12	P:K15
12	Synth Riff 13	P:K16
13	Synth Riff 14	P:K17
14	SFX 6	P:I42
15	Whistle Loop	P:I15
16	Orchestra Hit 1	P:L35

## U:21 Industrial (BPM=130)

1	Techno Drums 17	P:E53
2	Techno Drums 18	P:E54
3	Techno Bass 17	P:F47
4	Techno Bass 18	P:F48
5	Industry Fill 1	P:H68
6	BD Fill 4	P:G26
7	Industry Fill 2	P:H71
8	Tom Fill 3	P:H52
9	Synth Seq 11	P:K55
10	Synth Seq 12	P:K56
11	Synth Seq 13	P:K57
12	SFX 9	P:I45
13	SFX 10	P:I46
14	SFX 11	P:I47
15	Industry Hit 1	P:L25
16	Industry Hit 3	P:L27

**U:22 Ambient Techno (BPM=125)**

1	Techno Drums 19	P:E55
2	Techno Drums 20	P:E56
3	Techno Bass 19	P:F51
4	Techno Bass 20	P:F52
5	Snare Fill 17	P:G85
6	BD Fill 5	P:G27
7	Perc Fill 2	P:H73
8	Perc Loop 2	P:H81
9	Synth Pad 6	P:J66
10	Synth Riff 19	P:K24
11	Synth Seq 14	P:K58
12	Synth Seq 15	P:K61
13	SFX 12	P:I48
14	SFX 13	P:I51
15	Piano Delay	P:L42
16	Bird	P:K81

**U:25 Drum'n' Bass 3 (BPM=170)**

1	D-Bass Drums 5	P:E63
2	D-Bass Drums 6	P:E64
3	D-Bass Bass 5	P:F57
4	D-Bass Bass 6	P:F58
5	Snare Fill 24	P:H14
6	Snare Fill 25	P:H15
7	BD Fill 7	P:G31
8	Snare Fill 26	P:H16
9	Synth Pad 9	P:J71
10	Synth Riff 22	P:K27
11	Vox 4	P:K74
12	Vox 5	P:K75
13	SFX 18	P:I56
14	SFX 19	P:I57
15	Industry Hit 6	P:L32
16	Industry Hit 7	P:L33

**U:28 HipHop West (BPM=95)**

1	HipHop Drums 3	P:E71
2	HipHop Drums 4	P:E72
3	HipHop Bass 3	P:F65
4	HipHop Bass 4	P:F66
5	Scratch 4	P:H86
6	Tambourine 3	P:H47
7	Gunshot	P:H67
8	Tom Fill 4	P:H53
9	Guitar Chord 2	P:I66
10	Str.Obligato 1	P:J56
11	Organ Lead 2	P:J22
12	Synth Lead 3	P:J48
13	Synth Riff 23	PK28
14	G Laughter	P:I85
15	HipHop Hit 2	P:L22
16	Voice Hit 3	P:L45

**U:23 Drum'n' Bass 1 (BPM=170)**

1	D-Bass Drums 1	P:E57
2	D-Bass Drums 2	P:E58
3	D-Bass Bass 1	P:F53
4	D-Bass Bass 2	P:F54
5	Snare Fill 18	P:G86
6	Snare Fill 19	P:G87
7	Snare Fill 20	P:G88
8	Tambourine 1	P:H45
9	Synth Pad 7	P:J67
10	Synth Pad 8	P:J68
11	Synth Lead 1	P:J46
12	SFX 14	P:I52
13	SFX 15	P:I53
14	SFX 16	P:I54
15	SFX Hit 7	P:L15
16	Industry Hit 4	P:L28

**U:26 Jungle (BPM=170)**

1	D-Bass Drums 7	P:E65
2	D-Bass Drums 8	P:E66
3	D-Bass Bass 7	P:F61
4	D-Bass Bass 8	P:F62
5	Snare Fill 27	P:H17
6	Snare Fill 28	P:H18
7	RideCym Loop 2	P:G46
8	BD Fill 8	P:G32
9	E.Piano Chord 1	P:I25
10	Piano Chord 2	P:J25
11	Synth Seq 17	P:K63
12	Synth Seq 18	P:K64
13	Synth Lead 2	P:J47
14	Organ Lead 1	P:J21
15	Brass Fall 1	P:K82
16	Whistle Hit 1	P:L53

**U:31 Abstract1 (BPM=80)**

1	HipHop Drums 5	P:E73
2	HipHop Drums 6	P:E74
3	HipHop Bass 5	P:F67
4	HipHop Bass 6	P:F68
5	Snare Fill 29	P:H21
6	Clap Fill 3	P:G55
7	Scratch 5	P:H87
8	LowCHH Loop 2	P:G42
9	Synth Riff 24	P:K31
10	Str.Obligato 2	P:J57
11	E.Piano Lead 1	P:I23
12	E.Piano Chord 3	P:I27
13	Vox 6	P:K76
14	SFX 20	P:I58
15	Phono Noise	P:J44
16	Piano Delay	P:L42

**U:24 Drum'n' Bass 2 (BPM=170)**

1	D-Bass Drums 3	P:E61
2	D-Bass Drums 4	P:E62
3	D-Bass Bass 3	P:F55
4	D-Bass Bass 4	P:F56
5	Snare Fill 21	P:H11
6	BD Fill 6	P:G28
7	Snare Fill 22	P:H12
8	Snare Fill 23	P:H13
9	Piano Chord 1	P:J24
10	Vox 3	P:K73
11	Synth Riff 20	P:K25
12	Synth Riff 21	P:K26
13	Synth Seq 16	P:K62
14	SFX 17	P:I55
15	Orchestra Hit 3	P:L37
16	Industry Hit 5	P:L31

**U:27 HipHop East (BPM=90)**

1	HipHop Drums 1	P:E67
2	HipHop Drums 2	P:E68
3	HipHop Bass 1	P:F63
4	HipHop Bass 2	P:F64
5	Tambourine 2	P:H46
6	Scratch 1	P:H83
7	Scratch 2	P:H84
8	Scratch 3	P:H85
9	Organ Chord 1	P:I87
10	E.Piano Chord 2	P:I26
11	Organ Chord 2	P:I88
12	Guitar Chord 1	P:I65
13	Guitar Lead	P:I72
14	Vibe Lead	P:K68
15	HipHop Hit 1	P:L21
16	Phono Noise	P:J44

**U:32 Abstract2 (BPM=70)**

1	HipHop Drums 7	P:E75
2	HipHop Drums 8	P:E76
3	HipHop Bass 7	P:F71
4	HipHop Bass 8	P:F72
5	RideCym Fill	P:G44
6	Perc Fill 3	P:H74
7	Perc Loop 3	P:H82
8	Perc Fill 4	P:H75
9	E.Piano Chord 4	P:I28
10	Synth Pad 10	P:J72
11	Synth Lead 4	P:J51
12	SFX 21	P:I61
13	SFX 22	P:I62
14	SFX 23	P:I63
15	Piano Delay	P:L42
16	SFX Hit 8	P:L16



---

**U:33 HipHop Early (BPM=95)**

---

1	HipHop Drums 9	P:E77
2	HipHop Drums 10	P:E78
3	HipHop Bass 9	P:F73
4	HipHop Bass 10	P:F74
5	Clap Fill 4	P:G56
6	Tom Fill 5	P:H54
7	Tom Fill 6	P:H55
8	Scratch 6	P:H88
9	Guitar Chord 3	P:I67
10	Synth Riff 25	P:K32
11	Piano Chord 3	P:J26
12	E.Piano Lead 2	P:I24
13	Synth Lead 5	P:J52
14	Synth Lead 6	P:J53
15	HipHop Hit 3	P:L23
16	Voice Hit 4	P:L46

---

**U:36 Garage House (BPM=120)**

---

1	House Drums 3	P:E85
2	House Drums 4	P:E86
3	House Bass 3	P:F81
4	House Bass 4	P:F82
5	Snare Fill 33	P:H25
6	Perc Fill 6	P:H77
7	Clap Fill 7	P:G61
8	BD Loop 1	P:G33
9	Synth Pad 13	P:J75
10	Synth Pad 14	P:J76
11	Piano Chord 7	P:J32
12	E.Piano Chord 6	P:I32
13	E.Piano Chord 7	P:I33
14	Organ Chord 3	P:J11
15	Crash Cymbal	P:K87
16	Orchestra Hit 4	P:L38

---

**U:41 Jazz Funk 1 (BPM=125)**

---

1	Jazz Drums 1	P:F13
2	Jazz Drums 2	P:F14
3	Jazz Bass 1	P:F87
4	Jazz Bass 2	P:F88
5	Snare Fill 38	P:H32
6	Snare Fill 39	P:H33
7	RideCym Loop 5	P:G51
8	Snare Fill 40	P:H34
9	Organ Chord 5	P:J13
10	Guitar Riff 6	P:I78
11	Guitar Riff 7	P:I81
12	Guitar Riff 8	P:I82
13	Synth Seq 20	P:K66
14	Brass 1	P:I16
15	Voice Hit 8	P:L52
16	Brass Fall 1	P:K82

---

**U:34 Jazz&Soul (BPM=100)**

---

1	HipHop Drums 11	P:E81
2	HipHop Drums 12	P:E82
3	HipHop Bass 11	P:F75
4	HipHop Bass 12	P:F76
5	Perc Fill 5	P:H74
6	Clap Fill 5	P:G57
7	CHH Fill 2	P:G36
8	RideCym Loop 3	P:G47
9	Synth Pad 11	P:J73
10	Synth Pad 12	P:J74
11	E.Piano Chord 5	P:I31
12	Piano Chord 4	P:J27
13	Synth Lead 7	P:J54
14	Guitar Riff 5	P:I77
15	Voice Hit 5	P:L47
15	Brass Fall 1	P:K82

---

**U:37 Hard House (BPM=130)**

---

1	House Drums 5	P:E87
2	House Drums 6	P:E88
3	House Bass 5	P:F83
4	House Bass 6	P:F84
5	Snare Fill 34	P:H26
6	LowCHH Loop 3	P:G43
7	BD Loop 2	P:G34
8	Clap Fill 8	P:G62
9	Organ chord 4	P:J12
10	Piano Chord 8	P:J33
11	Synth Riff 27	P:K34
12	Synth Riff 28	P:K35
13	Str.Obligato 3	P:J58
14	SFX 24	P:I64
15	SFX Hit 9	P:L17
16	Industry Hit 8	P:L34

---

**U:42 Jazz Funk 2 (BPM=125)**

---

1	Jazz Drums 3	P:F15
2	Jazz Drums 4	P:F16
3	Jazz Bass 3	P:G11
4	Jazz Bass 4	P:G12
5	RideCym Loop 6	P:G52
6	Snare Fill 41	P:H35
7	Snare Fill 42	P:H36
8	Snare Fill 43	P:H37
9	Piano Chord 10	P:J35
10	Organ Chord 6	P:J14
11	E.Piano Chord 8	P:I34
12	Synth Pad 15	P:J77
13	Brass 2	P:I17
14	Voice Riff	P:K78
15	Brass Fall 1	P:K82
16	Voice Hit 5	P:L47

---

**U:35 House (BPM=120)**

---

1	House Drums 1	P:E83
2	House Drums 2	P:E84
3	House Bass 1	P:F77
4	House Bass 2	P:F78
5	Snare Fill 30	P:H22
6	Clap Fill 6	P:G58
7	Snare Fill 31	P:H23
8	Snare Fill 32	P:H24
9	Synth Riff 26	P:K33
10	Piano Chord 5	P:J28
11	Piano Chord 6	P:J31
12	Vox 7	P:K77
13	Synth Seq 19	P:K65
14	Organ Lead 3	P:J23
15	Voice Hit 6	P:L48
16	Crash Cymbal	P:K87

---

**U:38 Happy Handbag (BPM=130)**

---

1	House Drums 7	P:F11
2	House Drums 8	P:F12
3	House Bass 7	P:F85
4	House Bass 8	P:F86
5	Snare Fill 35	P:H27
6	Snare Fill 36	P:H28
7	Snare Fill 37	P:H31
8	RideCym Loop 4	P:G48
9	Piano Chord 9	P:J34
10	Synth Riff 29	P:K36
11	Synth Riff 30	P:K37
12	Synth Riff 31	P:K38
13	Synth Riff 32	P:K41
14	Synth Riff 33	P:K42
15	Orchestra Hit 5	P:L41
16	Voice Hit 7	P:L51

---

**U:43 Reggae 1 (BPM=190)**

---

1	Reggae Drums 1	P:F17
2	Reggae Drums 2	P:F18
3	Reggae Bass 1	P:G13
4	Reggae Bass 2	P:G14
5	Tom Fill 7	P:H56
6	Snare Fill 44	P:H38
7	Tom Fill 8	P:H57
8	CHH Fill 3	P:G37
9	Piano Chord 11	P:J36
10	Piano Chord 12	P:J37
11	Organ Chord 7	P:J15
12	Organ Chord 8	P:J16
13	Guitar Chord 4	P:I68
14	Brass Hit	P:K84
15	Blip Hit 2	P:K86
16	Orchestra Hit 5	P:L41

---

**U:44 Reggae 2 (BPM=155)**

---

1	Reggae Drums 3	P:F21
2	Reggae Drums 4	P:F22
3	Reggae Bass 3	P:G15
4	Reggae Bass 4	P:G16
5	Tom Fill 9	P:H58
6	Snare Fill 45	P:H41
7	Snare Fill 46	P:H42
8	CHH Fill 4	P:G38
9	Piano Chord 13	P:J38
10	Organ Chord 9	P:J17
11	Organ Chord 10	P:J18
12	Guitar Chord 5	P:I71
13	Guitar Riff 9	P:I83
14	Guitar Riff 10	P:I84
15	Brass 3	P:I18
16	SFX Hit 10	P:L18

---

**U:45 Salsa (BPM=110)**

---

1	Latin Drums 1	P:F23
2	Latin Drums 2	P:F24
3	Latin Bass 1	P:G17
4	Latin Bass 2	P:G18
5	Timbales Fill 1	P:I13
6	Timbales Fill 2	P:I14
7	Cowbell Loop 2	P:H66
8	Agogo Loop 1	P:H61
9	Piano Chord 14	P:J41
10	Piano Chord 15	P:J42
11	Piano Chord 16	P:J43
12	Brass 4	P:I21
13	Brass 5	P:I22
14	Marimba	P:I86
15	Brass Fall 2	P:K83
16	Crash Cymbal	P:K87

---

**U:46 Samba (BPM=125)**

---

1	Latin Drums 3	P:F25
2	Latin Drums 4	P:F26
3	Latin Bass 3	P:G21
4	Latin Bass 4	P:G22
5	Surdo Loop 1	P:I11
6	Surdo Loop 2	P:I12
7	Snare Fill 47	P:H43
8	Snare Fill 48	P:H44
9	Synth Pad 16	P:J78
10	Synth Pad 17	P:J81
11	Synth Lead 8	P:J55
12	Synth Seq 21	P:K67
13	Bongo	P:H64
14	Agogo Loop 2	P:H62
15	Whistle Hit 2	P:L54
15	Brass Fall 1	P:K82

# Parameter List

## Patch Parameters

#: Parameters which can also be operated from the front-panel knobs or buttons.

COMMON parameters	[EDIT] -> NUMBER [1] (COMMON) (p. 77)	
SOLO: Solo SW *	Solo Switch	OFF, ON
SOLO: Solo Legato *	Solo Legato Switch	OFF, ON
PORTAMENTO: SW #*	Portamento Switch	OFF, ON
PORTAMENTO: Mode *	Portamento Mode	NORMAL, LEGATO
PORTAMENTO: Type *	Portamento Type	RATE, TIME
PORTAMENTO: Start *	Portamento Start Pitch	PITCH, NOTE
PORTAMENTO: Time #*	Portamento Time	0-127
COM: Struct 1&2 *	Structure Type 1&2	1-10
COM: Struct 3&4 *	Structure Type 3&4	1-10
COM: Booster 1&2 *	Booster Gain 1&2	0, +6, +12, +18
COM: Booster 3&4 *	Booster Gain 1&2	0, +6, +12, +18
COM: Stretch Tune *	Stretch Tune Depth	OFF, 1-3
COM: V-Priority *	Voice Priority	LAST, LOUDEST
COM: Key Range L	Key Range Lower	C-1-UPR
COM: Key Range U	Key Range Upper	LWR-G9
COM: Velo Range *	Velocity Range Switch	OFF, ON
COM: Velo Range L	Velocity Range Lower	1-UPR
COM: Velo Range U	Velocity Range Upper	LWR-127
COM: Velo X-Fade	Velocity Crossfade	0-127

\*: Common settings for each tone

WAVE parameters	[EDIT] -> NUMBER [2] (WAVE) (p. 56)	
WAVE: Tone SW #	Tone Switch	OFF, ON
WAVE: Wave Select	Wave Select	A001-C131
WAVE: Wave Gain	Wave Gain	-6, 0, +6, +12
FXM: FXM SW	FXM Switch	OFF, ON
FXM: FXM Color	FXMColor	1-4
FXM: FXM Depth	FXMDepth	1-16

PITCH parameters	[EDIT] -> NUMBER [3] (PITCH) (p. 57)	
PITCH: Coarse Tune #	Coarse Tune	-48-+48
PITCH: Fine Tune #	Fine Tune	-50-+50
PITCH: Rnd Pitch	Random Pitch Depth	1*
PITCH: Key Follow	Pitch Key Follow	2*
P-ENV: Env Depth #	Envelope Depth	-12-+12
P-ENV: Velo Sens	Velocity Sens	-100-+150
P-ENV: Velo Time1	Velocity Time1 Sens	3*
P-ENV: Velo Time4	Velocity Time4 Sens	3*
P-ENV: Time KF	Time Key Follow	3*
P-ENV: [A]Time1 #	Time1 (Attack Time)	0-127
P-ENV: Time2	Time2	0-127
P-ENV: [D]Time3 #	Time3 (Decay Time)	0-127
P-ENV: [R]Time4 #	Time4 (Release Time)	0-127
P-ENV: Level1	Level1	-63-+63
P-ENV: Level2	Level2	-63-+63
P-ENV: [S]Level3 #	Level3 (Sustain Level)	-63-+63
P-ENV: Level4	Level4	-63-+63

1\*: 0, 1, 2, 3, 4, 5, 6, 7, 8, 9, 10, 20, 30, 40, 50, 60, 70, 80, 90, 100, 200, 300, 400, 500, 600, 700, 800, 900, 1000, 1100, 1200

2\*: -100, -70, -50, -30, -10, 0, +10, +20, +30, +40, +50, +70, +100, +120, +150, +200

3\*: -100, -70, -50, -40, -30, -20, -10, 0, +10, +20, +30, +40, +50, +70, +100

<b>FILTER parameters</b>	<b>[EDIT] -&gt; NUMBER [4] (FILTER) (p. 61)</b>	
FILTER: Type #	Filter Type	OFF, LPF, BPF, HPF, PKG
FILTER: Cutoff #	Cutoff Frequency	0-127
FILTER: Cutoff KF	Cutoff Key Follow	1*
FILTER: Resonance #	Resonance	0-127
FILTER: Reso Velo	Resonance Velocity Sens	-100-+150
F-ENV: Env Depth #	Envelope Depth	-63-+63
F-ENV: Velo Curve	Velocity Curve	1-7
F-ENV: Velo Sens	Velocity Sens	-100-+150
F-ENV: Velo Time1	Velocity Time1 Sens	2*
F-ENV: Velo Time4	Velocity Time4 Sens	2*
F-ENV: Time KF	Time Key Follow	2*
F-ENV: [A]Time1 #	Time1 (Attack Time)	0-127
F-ENV: Time2	Time2	0-127
F-ENV: [D]Time3 #	Time3 (Decay Time)	0-127
F-ENV: [R]Time4 #	Time4 (Release Time)	0-127
F-ENV: Level1	Level1	0-127
F-ENV: Level2	Level2	0-127
F-ENV: [S]Level3 #	Level3 (Sustain Level)	0-127
F-ENV: Level4	Level4	0-127

1\*: -100, -70, -50, -30, -10, 0, +10, +20, +30, +40, +50, +70, +100, +120, +150, +200

2\*: -100, -70, -50, -40, -30, -20, -10, 0, +10, +20, +30, +40, +50, +70, +100

<b>AMPLIFIER parameters</b>	<b>[EDIT] -&gt; NUMBER [5] (AMPLIFIER) (p. 67)</b>	
LEVEL: Tone Level #	Tone Level	0-127
LEVEL: Bias Dir	Bias Direction	LWR, UPR, L&U, ALL
LEVEL: Bias Point	Bias Point	C-1-G9
LEVEL: Bias Level	Bias Point Level	1*
PAN: Tone Pan #	Tone Pan	L64-63R
PAN: Pan KF	Pan Key Follow	1*
PAN: Rnd Pan SW #	Random Pan Switch	OFF, ON
PAN: Alt Pan Dpth	Alternate Pan Depth	L63-63R
A-ENV: Velo Curve	Velocity Curve	1-7
A-ENV: Velo Sens	Velocity Sens	-100-+150
A-ENV: Velo Time1	Velocity Time1 Sens	1*
A ENV: Velo Time4	Velocity Time4 Sens	1*
A-ENV: Time KF	Time Key Follow	1*
A-ENV: [A]Time1 #	Time1 (Attack Time)	0-127
A-ENV: Time2	Time2	0-127
A-ENV: [D]Time3 #	Time3 (Decay Time)	0-127
A-ENV: [R]Time4 #	Time4 (Release Time)	0-127
A-ENV: Level1	Level1	0-127
A-ENV: Level2	Level2	0-127
A-ENV: [S]Level3 #	Level3 (Sustain Level)	0-127

1\*: -100, -70, -50, -40, -30, -20, -10, 0, +10, +20, +30, +40, +50, +70, +100

LFO parameters	[EDIT] -> NUMBER [6] (LFO) (p. 71)	
LFO1: Waveform #	Waveform	TRI, SIN, SAW, SQR, TRP, S&H, RND, CHS
LFO1: Rate #	Rate	0-127, 1*
LFO1: Tempo Sync	Tempo Sync	OFF, ON
LFO1: Key Sync	Key Sync	OFF, ON
LFO1: Fade Mode	Fade Mode	OnI, OnO, OfI, OfO
LFO1: Delay Time	Delay Time	0-127
LFO1: Fade Time #	Fade Time	0-127
LFO1: Offset	Level Offset	-100, -50, 0, +50, +100
LFO1: Pitch Depth #	Pitch Depth	-63-+63
LFO1: FilterDepth #	Filter Depth	-63-+63
LFO1: Amp Depth #	Amplifier Depth	-63-+63
LFO1: Pan Depth	Pan Depth	-63-+63
LFO2: Waveform	Waveform	TRI, SIN, SAW, SQR, TRP, S&H, RND, CHS
LFO2: Rate	Rate	0-127, 1*
LFO2: Tempo Sync	Tempo Sync	OFF, ON
LFO2: Key Sync	Key Sync	OFF, ON
LFO2: Fade Mode	Fade Mode	OnI, OnO, OfI, OfO
LFO2: Delay Time	Delay Time	0-127
LFO2: Fade Time	Fade Time	0-127
LFO2: Offset	Level Offset	-100, -50, 0, +50, +100
LFO2: Pitch Depth	Pitch Depth	-63-+63
LFO2: FilterDepth	Filter Depth	-63-+63
LFO2: Amp Depth	Amplifier Depth	-63-+63
LFO2: Pan Depth	Pan Depth	-63-+63

1\*: Note

CONTROL parameters	[EDIT] -> NUMBER [7] (CONTROL) (p. 76)	
BEND: Bend Up *	Bend Range Up	0-+12
BEND: Bend Down *	Bend Range Down	0-48
MOD: Control 1	Control Destination1	1*
MOD: Ctrl1 Depth	Control1 Depth	-63-+63
MOD: Control 2	Control Destination2	1*
MOD: Ctrl2 Depth	Control2 Depth	-63-+63
MOD: Control 3	Control Destination3	1*
MOD: Ctrl3 Depth	Control3 Depth	-63-+63
MOD: Control 4	Control Destination4	1*
MOD: Ctrl4 Depth	Control4 Depth	-63-+63
BEND: Control 1	Control Destination1	1*
BEND: Ctrl1 Depth	Control1 Depth	-63-+63
BEND: Control 2	Control Destination2	1*
BEND: Ctrl2 Depth	Control2 Depth	-63-+63
BEND: Control 3	Control Destination3	1*
BEND: Ctrl3 Depth	Control3 Depth	-63-+63
BEND: Control 4	Control Destination4	1*
BEND: Ctrl4 Depth	Control4 Depth	-63-+63
AFT: Control 1	Control Destination1	1*
AFT: Ctrl1 Depth	Control1 Depth	-63-+63
AFT: Control 2	Control Destination2	1*
AFT: Ctrl2 Depth	Control2 Depth	-63-+63
AFT: Control 3	Control Destination3	1*
AFT: Ctrl3 Depth	Control3 Depth	-63-+63
AFT: Control 4	Control Destination4	1*
AFT: Ctrl4 Depth	Control4 Depth	-63-+63

\*: Common settings for each tone

1\*: OFF, PCH, CUT, RES, LEV, PAN, L1P, L2P, L1F, L2F, L1A, L2A, L1p, L2p, L1R, L2R

## Rhythm Set Parameters

#: Parameters which can also be operated from the front-panel knobs or buttons.

WAVE parameters	[EDIT] -> NUMBER [2] (WAVE) (p. 86)	
WAVE: Tone SW	Rhythm Tone Switch	OFF, ON
WAVE: Wave Select	Wave Select	A001-C131
WAVE: Wave Gain	Wave Gain	-6, 0, +6, +12
KEY: Env Mode	Envelope Mode	SUSTAIN, NO-SUS
KEY: Mute Group	Mute Group	OFF, 1-31

PITCH parameters	[EDIT] -> NUMBER [3] (PITCH) (p. 87)	
PITCH: CoarseTune #	Coarse Tune	-48-+48
PITCH: Fine Tune #	Fine Tune	-50-+50
PITCH: Rnd Pitch	Random Pitch Depth	1*
P-ENV: Env Depth #	Envelope Depth	-12-+12
P-ENV: Velo Sens	Velocity Sens	-100-+150
P-ENV: Velo Time	Velocity Time Sens	2*
P-ENV: [A]Time1 #	Time1 (Attack Time)	0-127
P-ENV: Time2	Time2	0-127
P-ENV: [D]Time3 #	Time3 (Decay Time)	0-127
P-ENV: [R]Time4 #	Time4 (Release Time)	0-127
P-ENV: Level1	Level1	-63-+63
P-ENV: Level2	Level2	-63-+63
P-ENV: [S]Level3 #	Level3 (Sustain Level)	-63-+63
P-ENV: Level4	Level4	-63-+63

1\*: 0, 1, 2, 3, 4, 5, 6, 7, 8, 9, 10, 20, 30, 40, 50, 60, 70, 80, 90, 100, 200, 300, 400, 500, 600, 700, 800, 900, 1000, 1100, 1200

2\*: -100, -70, -50, -40, -30, -20, -10, 0, +10, +20, +30, +40, +50, +70, +100

FILTER parameters	[EDIT] -> NUMBER [4] (FILTER) (p. 90)	
FILTER: Type #	Filter Type	OFF, LPF, BPF, HPF, PKG
FILTER: Cutoff #	Cutoff Frequency	0-127
FILTER: Resonance #	Resonance	0-127
FILTER: Reso Velo	Resonance Velocity Sens	-100-+150
F-ENV: Env Depth #	Envelope Depth	-63-+63
F-ENV: Velo Sens	Velocity Sens	-100-+150
F-ENV: Velo Time	Velocity Time Sens	1*
F-ENV: [A]Time1 #	Time1 (Attack Time)	0-127
F-ENV: Time2	Time2	0-127
F-ENV: [D]Time3 #	Time3 (Decay Time)	0-127
F-ENV: [R]Time4 #	Time4 (Release Time)	0-127
F-ENV: Level1	Level1	0-127
F-ENV: Level2	Level2	0-127
F-ENV: [S]Level3 #	Level3 (Sustain Level)	0-127
F-ENV: Level4	Level4	0-127

1\*: -100, -70, -50, -40, -30, -20, -10, 0, +10, +20, +30, +40, +50, +70, +100

AMPLIFIER parameters	[EDIT] -> NUMBER [5] (AMPLIFIER) (p. 94)	
LEVEL: Tone Level #	Rhythm Tone Level	0-127
PAN: Tone Pan #	Rhythm Tone Pan	L64-63R
PAN: Rnd Pan SW #	Random Pan Switch	OFF, ON
PAN: Alt Pan Dpth	Alternate Pan Depth	L63-63R
A-ENV: Velo Sens	Velocity Sens	-100-+150
A-ENV: Velo Time	Velocity Time Sens	1*
A-ENV: [A]Time1 #	Time1 (Attack Time)	0-127
A-ENV: Time2	Time2	0-127
A-ENV: [D]Time3 #	Time3 (Decay Time)	0-127
A-ENV: [R]Time4 #	Time4 (Release Time)	0-127
A-ENV: Level1	Level1	0-127
A-ENV: Level2	Level2	0-127
A-ENV: [S]Level3 #	Level3 (Sustain Level)	0-127

1\*: -100, -70, -50, -40, -30, -20, -10, 0, +10, +20, +30, +40, +50, +70, +100

CONTROL parameter	[EDIT] -> NUMBER [7] (CONTROL) (p. 97)	
BEND: Bend Range	Bend Range	0-+12

RHY TONE parameters	[EDIT] -> NUMBER [8] (RHY TONE) (p. 97)	
R.TONE: Rev Level	Rhythm Tone Reverb Level	0-127
R.TONE: Dly Level	Rhythm Tone Delay Level	0-127
R.TONE: M-FX SW	Rhythm Tone Multi Effects Switch	OFF, ON

## Setup Parameters

#: Parameters which can also be operated from the front-panel knobs or buttons.

P: Parameters that are set independently for each part.

KEYBOARD parameters	[EDIT] -> BANK [1] (KEYBOARD) (p. 20)	
KBD: Split Point #	Split Point	C-1-G9
KBD: Upper Part	Upper Part Number	PART 1-PART R
KBD: Lower Part	Lower Part Number	PART 1-PART R

EFFECTS parameters	[EDIT] -> BANK [2] (EFFECTS) (p. 103, 105, 107)	
REVERB: Type	Reverb Type	ROOM1, ROOM2, STAGE1, STAGE2, HALL1, HALL2
REVERB: Reverb Time	Reverb Time	0-127
REVERB: HF Damp	HF Damp	1*
REVERB: M-FX->Reverb	M-FX->Reverb Level	0-127
REVERB: Reverb Level#	Reverb Level	0-127
DELAY: Type	Delay Type	SHORT, LONG
DELAY: Delay Time	Delay Time	S:0.1-275, L:200-1000, 2*
DELAY: Feedback	Feedback Level	0-+98
DELAY: HF Damp	HF Damp	3*
DELAY: M-FX->Delay	M-FX->Delay Level	0-127
DELAY: Output	Delay Output Assign	LINE, REV, LINE+REV
DELAY: Delay Level #	Delay Level	0-127

1\*: 200, 250, 315, 400, 500, 630, 800, 1000, 1250, 1600, 2000, 2500, 3150, 4000, 5000, 6300, 8000, BYPASS

2\*: Note, 1/16, 1/12, 3/32, 1/8, 1/6, 3/16, 1/4, 1/3, 3/8, 1/2

3\*: 200, 250, 315, 400, 500, 630, 800, 1000, 1250, 1600, 2000, 2500, 3150, 4000, 5000, 6300, 8000, BYPASS

---

Type= 4-BAND-EQ #		
Low Freq	Low Frequency	200, 400
Low Gain #	Low Gain	-15--+15
High Freq	High Frequency	4000, 8000
High Gain #	High Gain	-15--+15
Peak1 Freq	Peaking1 Frequency	1*
Peak1 Q	Peaking1 Q	0.5, 1.0, 2.0, 4.0, 8.0
Peak1 Gain	Peaking1 Gain	-15--+15
Peak2 Freq	Peaking2 Frequency	1*
Peak2 Q	Peaking2	0.5, 1.0, 2.0, 4.0, 8.0
Peak2 Gain	Peaking2 Gain	-15--+15
Output Level #	Output Level	0-127

1\*: 200, 250, 315, 400, 500, 630, 800, 1000, 1250, 1600, 2000, 2500, 3150, 4000, 5000, 6300, 8000

---

Type= SPECTRUM #		
Low-High #	Low High Gain	-15--+15
Middle Gain #	Middle Gain	-15--+15
Width	Band Width	1-5
Output Pan	Output Pan	L64-63R
Output Level #	Output Level	0-127

---

Type= ENHANCER #		
Sens #	Sens	0-127
Mix #	Mix Level	0-127
Low Gain	Low Gain	-15--+15
High Gain	High Gain	-15--+15
Output Level #	Output Level	0-127

---

Type= OVERDRIVE #		
Input Level	Input Level	0-127
Drive #	Drive	0-127
AMP Type #	AMP Type	SMALL, BUILTIN, 2STACK, 3STACK
Output Pan	Output Pan	L64-R63
Output Level #	Output Level	0-127

---

Type= DISTORTION #		
Input Level	Input Level	0-127
Drive #	Drive	0-127
AMP Type #	AMP Type	SMALL, BUILTIN, 2STACK, 3STACK
Output Pan	Output Pan	L64-63R
Output Level #	Output Level	0-127

---

Type= Lo-Fi #		
Bit Down #	Bit Down	0-7
S-Rate Down #	Sample Rate Down	32, 16, 8, 4
Post Gain	Post Gain	0, +6, +12, +18
Low Gain	Low Gain	-15--+15
High Gain	High Gain	-15--+15
Output	Output	MONO, STEREO
Output Level #	Output Level	0-127



---

Type= NOISE #		
Noise Type	Noise Type	1-18
Noise Level #	Noise Level	0-127
N Filter	Noise Filter	1*
Lo-Fi Level #	Lo-Fi Level	0-127
Output Pan	Output Pan	L64-63R
Output Level #	Output Level	0-127

1\*: 200, 250, 315, 400, 500, 630, 800, 1000, 1250, 1600, 2000, 2500, 3150, 4000, 5000, 6300, 8000, BYPASS

---

Type= RADIO-TUNG #		
Radio Detune #	Radio Detune	0-127
Noise Level #	Noise Level	0-127
Low Gain	Low Gain	-15--+15
High Gain	High Gain	-15--+15
Output	Output	MONO, STEREO
Output Level #	Output Level	0-127

---

Type= PHONOGRAPH #		
Disc Type	Disc Type	LP, EP, SP
D NoiseLevel #	Disc Noise Level	0-127
Depth #	Depth	0--+20
Output Pan	Output Pan	L64-63R
Output Level #	Output Level	0-127

---

Type= COMPRESSOR #		
Attack #	Attack	0-127
Sustain #	Sustain	0-127
Post Gain	Post Gain	0, +6, +12, +18
Low Gain	Low Gain	-15--+15
High Gain	High Gain	-15--+15
Output Level #	Output Level	0-127

---

Type= LIMITER #		
Threshold #	Threshold Level	0-127
Ratio	Compression Ratio	1.5:1, 2:1, 4:1,100:1
Release #	Release	0-127
Post Gain	Post Gain	0, +6, +12, +18
Output Pan	Output Pan	L64-63R
Output Level #	Output Level	0-127

---

Type= SLICER #		
Timing PTN #	Timing Pattern	1-34
Rate	Rate	1/4, 1/2, 1/1
Accent PTN #	Accent Pattern	1-16
Accent Level	Accent Level	0-127
Attack	Attack	1-10
Output Level #	Output Level	0-127

---

Type= TREMOLO #		
LFO Type	LFO Type	TRI, TRP, SIN, SAW1, SAW2, SQR
Rate #	Rate	0.1-10.0, 1*
Depth #	Depth	0-127
Low Gain	Low Gain	-15--+15
High Gain	High Gain	-15--+15
Output Level #	Output Level	0-127

1\*: 1/16, 1/12, 3/32, 1/8, 1/6, 3/16, 1/4, 1/3, 3/8, 1/2, 2/3, 3/4, 1/1, 2MES, 3MES, 4MES, 8MES, 16MES

---

Type= PHASER #		
Manual	Manual	100-8000
Rate #	Rate	0.1-10.0, 1*
Depth #	Depth	0-127
Resonance	Resonance	0-127
Mix	Mix Level	0-127
Output Pan	Output Pan	L64-63R
Output Level #	Output Level	0-127

1\*: 1/16, 1/12, 3/32, 1/8, 1/6, 3/16, 1/4, 1/3, 3/8, 1/2, 2/3, 3/4, 1/1, 2MES, 3MES, 4MES, 8MES, 16MES

---

Type= CHORUS #		
Pre Delay	Pre Delay Time	0.0-100
Rate #	Rate	0.1-10.0, 1*
Depth #	Depth	0-127
Phase	Phase	0-180
Filter Type	Filter Type	OFF, LPF, HPF
Cutoff	Cutoff Frequency	2*
Balance	Effect Balance	D100:0E-D0:100E
Output Level #	Output Level	0-127

1\*: 1/16, 1/12, 3/32, 1/8, 1/6, 3/16, 1/4, 1/3, 3/8, 1/2, 2/3, 3/4, 1/1, 2MES, 3MES, 4MES, 8MES, 16MES

2\*: 200, 250, 315, 400, 500, 630, 800, 1000, 1250, 1600, 2000, 2500, 3150, 4000, 5000, 6300, 8000

---

Type= SPACE-D #		
Pre Delay	Pre Delay Time	0.0-100
Rate #	Rate	0.1-10.0, 1*
Depth #	Depth	0-127
Phase	Phase	0-180
Low Gain	Low Gain	-15--+15
High Gain	High Gain	-15--+15
Balance	Effect Balance	D100:0E-D0:100E
Output Level #	Output Level	0-127

1\*: 1/16, 1/12, 3/32, 1/8, 1/6, 3/16, 1/4, 1/3, 3/8, 1/2, 2/3, 3/4, 1/1, 2MES, 3MES, 4MES, 8MES, 16MES

---

Type= TETRA-CHRS #		
Pre Delay	Pre Delay Time	0.0-100
Rate #	Rate	0.1-10.0, 1*
Depth #	Depth	0-127
Pre Dly Devi	Pre Delay Deviation	0-20
Depth Devi	Depth Deviation	-20--+20
Pan Devi	Pan Deviation	0-20
Balance	Effect Balance	D100:0E-D0:100E
Output Level #	Output Level	0-127

1\*: 1/16, 1/12, 3/32, 1/8, 1/6, 3/16, 1/4, 1/3, 3/8, 1/2, 2/3, 3/4, 1/1, 2MES, 3MES, 4MES, 8MES, 16MES

---

Type= FLANGER #		
Pre Delay	Pre Delay Time	0.0-100
Rate #	Rate	0.1-10.0, 1*
Depth #	Depth	0-127
Feedback	Feedback Level	0-+98
Phase	Phase	0-180
Filter Type	Filter Type	OFF, LPF, HPF
Cutoff	Cutoff Frequency	2*
Balance	Effect Balance	D100:0E-D0:100E
Output Level #	Output Level	0-127

1\*: 1/16, 1/12, 3/32, 1/8, 1/6, 3/16, 1/4, 1/3, 3/8, 1/2, 2/3, 3/4, 1/1, 2MES, 3MES, 4MES, 8MES, 16MES

2\*: 200, 250, 315, 400, 500, 630, 800, 1000, 1250, 1600, 2000, 2500, 3150, 4000, 5000, 6300, 8000

---

Type= ST-FLANGER #		
Pre Delay	Pre Delay Time	0.0-100
Rate	Rate	0.1-10.0, 1*
Depth #	Depth	0-127
Feedback	Feedback Level	0-+98
Phase	Phase	0-180
Step Rate #	Step Rate	0.05-10.0, 2*
Balance	Effect Balance	D100:0E-D0:100E
Output Level #	Output Level	0-127

1\*: 1/16, 1/12, 3/32, 1/8, 1/6, 3/16, 1/4, 1/3, 3/8, 1/2, 2/3, 3/4, 1/1, 2MES, 3MES, 4MES, 8MES, 16MES

2\*: 1/16, 1/12, 3/32, 1/8, 1/6, 3/16, 1/4, 1/3, 3/8, 1/2

---

Type= SHORT-DELY #		
Time L #	Delay Time Left	0.1-190
Time R #	Delay Time Right	0.1-190
HF Damp	HF Damp	1*
Feedback	Feedback Level	0-+98
Auto Pan	Auto Pan	OFF, 2*
Low Gain	Low Gain	-15-+15
High Gain	High Gain	-15-+15
Balance	Effect Balance	D100:0E-D0:100E
Output Level #	Output Level	0-127

1\*: 200, 250, 315, 400, 500, 630, 800, 1000, 1250, 1600, 2000, 2500, 3150, 4000, 5000, 6300, 8000, BYPASS

2\*: 1/16, 1/12, 3/32, 1/8, 1/6, 3/16, 1/4, 1/3, 3/8, 1/2, 2/3, 3/4, 1/1, 2MES, 3MES, 4MES, 8MES, 16MES

---

Type= AUTO-PAN #		
LFO Type	LFO Type	TRI, TRP, SIN, SAW1, SAW2, SQR
Rate #	Rate	0.1-10.0, 1*
Bass Sens	Bass Sens	OFF, MODE1, MODE2
Depth #	Depth	0-127
Low Gain	Low Gain	-15-+15
High Gain	High Gain	-15-+15
Output Level	Output Level	0-127

1\*: 1/16, 1/12, 3/32, 1/8, 1/6, 3/16, 1/4, 1/3, 3/8, 1/2, 2/3, 3/4, 1/1, 2MES, 3MES, 4MES, 16MES

---

Type= FB-P-SHIFT #		
Coarse #	Coarse Pitch	-24--+12
Fine #	Fine Pitch	-100--+100
Output Pan	Output Pan	L64-63R
Pre Delay	Pre Delay Time	0.0-100
Mode	Pitch Shift Mode	1-5
Feedback	Feedback Level	0--+98
Low Gain	Low Gain	-15--+15
High Gain	High Gain	-15--+15
Balance	Effect Balance	D100:0E-D0:100E
Output Level #	Output Level	0-127

---

Type= REVERB #		
Rev Type	Reverb Type	ROOM1, ROOM2, STAGE1, STAGE2, HALL1, HALL2
Time #	Reverb Time	0-127
HF Damp	HF Damp	1*
Balance #	Effect Balance	D100:0E-D0:100E
Output Level #	Output Level	0-127

1\*: 200, 250, 315, 400, 500, 630, 800, 1000, 1250, 1600, 2000, 2500, 3150, 4000, 5000, 6300, 8000, BYPASS

---

Type= GATE-REVERB #		
Gate Type	Gate Reverb Type	NORMAL, REVRSE, SWEEP1, SWEEP2
Gate Time #	Gate Reverb Time	5-330
Balance #	Effect Balance	D100:0E-D0:100E
Output Level #	Output Level	0-127

---

<b>PART parameters</b>	<b>[EDIT] -&gt; BANK [3] (PART) (p. 34)</b>	
PART: Patch/Rhythm P	PART Patch/Rhythm Set	P:A11-C:D88
PART: Level #P	Part Level	0-127
PART: Panpot #P	Part Pan	L64-63R
PART: Key Shift #P	Part Key Shift	-48--+48
PART: Reverb #P	Part Reverb Level	0-127
PART: Delay #P	Part Delay Level	0-127
PART: Multi-FX SW #P	Part Multi Effects Switch	OFF, RHY, ON
PART: SEQ Output P	Sequencer Output Assign	INT, EXT, BOTH

## Arpeggiator Parameters

#: Parameters which can also be operated from the front-panel knobs or buttons.

ARPEGGIO parameters	[EDIT] -> BANK [4] (ARPEGGIO) (p. 26)
ARP: Style #	Arpeggio Style 1*
ARP: Motif	Motif 2*
ARP: Beat Pattern	Beat Pattern 3*
ARP: Shuffle Rate	Shuffle Rate 50-90 %
ARP: Accent Rate	Accent Rate 0-127
ARP: Octave Range #	Octave Range -3-+3
ARP: Velocity	Velocity REAL, 1-127
ARP: Destination #	Destination Part LOWER&UPPER, LOWER, UPPER

1\*: 1/4, 1/6, 1/8, 1/12, 1/16, 1/32, PORTAMENTO A-B, GRISSANDO, SEQUENCE A-D, ECHO, SYNTH BASS, HEAVY SLAP, LIGHT SLAP, WALK BASS, RHYTHM GTR 1-5, 3 FINGER, STRUMMING GTR, PIANO BACKING, CLAVI CHORD, WALTZ, SWING WALTZ, REGGAE, PERCUSSION, HARP, SHAMISEN, BOUND BALL, RANDOM, BOSSA NOVA, SALSA, MAMBO, LATIN PERCUSSION, SAMBA, TANGO, HOUSE, LIMITLESS, USER TYPE 1-20

2\*: SINGLE UP, SINGLE DOWN, SINGLE UP&DOWN, SINGLE RANDOM, DUAL UP, DUAL DOWN, DUAL UP&DOWN, DUAL RANDOM, TRIPLE UP, TRIPLE DOWN, TRIPLE UP&DOWN, TRIPLE RANDOM, NOTE ORDER, GLISSANDO, CHORD, BASS+CHORD 1-5, BASS+UP 1-8, BASS+RND 1-3, TOP+UP 1-6, BASS+UP+TOP

3\*: 1/4, 1/6, 1/8, 1/12, 1/16 1-3, 1/32 1-3, PORTA-A 1-11, PORTA-B 1-15, SEQ-A 1-7, SEQ-B 1-5, SEQ-C 1-2, SEQ-D 1-8, ECHO 1-3, MUTE 1-16, STRUM 1-8, REGGAE 1-2, REF 1-2, PERC 1-4, WALKBS, HARP, BOUND, RANDOM, BOSSA NOVA, SALSA 1-4, MAMBO 1-2, CLAVE, REV CLA, GUILO, AGOGO, SAMBA, TANGO 1-4, HOUSE 1-2

## System Parameters

P: Parameters that are set independently for each part.

CONTROLLER parameters	[EDIT] -> BANK [5] (CONTROLLER) (p. 163)
CTRL: KeyVelocity	Keyboard Velocity REAL, 1-127
CTRL: After Sens	Aftertouch Sens 0-100
CTRL: Hld Pdl Pol	Hold Pedal Polarity STANDARD, REVERSE
CTRL: C-Pdl Assgn	Control Pedal Assign CC01-CC95, PITCH BEND UP, PITCH BEND DOWN, AFTERTOUCH
CTRL: C-Pdl Pol	Control Pedal Polarity STANDARD, REVERSE
CTRL: S-Pdl Assgn	Switch Pedal Assign STOP/PLAY, PTN INC, TRANSPOSE, SHIFT, RPS HOLD, TAP
CTRL: S-Pdl Pol	Switch Pedal Polarity STANDARD, REVERSE

MIDI parameters	[EDIT] -> BANK [6] (MIDI) (p. 164)
MIDI: Local SW	Local Switch INT, EXT, BOTH
MIDI: Remote Kbd	Remote Keyboard Switch OFF, ON
MIDI: Device ID	Device ID Number 17-32
MIDI: Thru	Thru Function OFF, ON
MIDI: Rx SW P	PART Rx Switch OFF, ON
MIDI: Edit Tx/Rx	Edit Tx/Rx Mode MODE1, MODE2
MIDI: Rx.PG	Receive Program Change Switch OFF, ON
MIDI: Rx.Bank Sel	Receive Bank Select Switch OFF, ON
MIDI: Rx.Sys-Ex	Receive System Exclusive Switch OFF, ON
MIDI: Tx.PG	Transmit Program Change Switch OFF, ON
MIDI: Tx.Bank Sel	Transmit Bank Select Switch OFF, ON
MIDI: Tx.Act-Sens	Transmit Active Sensing Switch OFF, ON

SEQUENCER parameters	[EDIT] -> BANK [7] (SEQUENCER) (p. 166)	
SEQ: Sync Mode	Sync Mode	INT, REMOTE, SLAVE
SEQ: Sync Out	Sync Out	OFF, ON
SEQ: Loop Mode	Loop Mode	OFF, LOOP1, LOOP2
SEQ: Metro Mode	Metronome Mode	OFF, REC ONLY, REC&PLAY, ALWAYS
SEQ: Metro Level	Metronome Level	0-127
SEQ: RPS Trg QTZ	RPS Trigger Quantize	REAL, 16, 8, 4, MEASURE
SEQ: Arp Sync	Arpeggio Sync	OFF, ON
SEQ: AutoChecksum	Auto CheckSum	OFF, ON
SEQ: Tap Reso	Tap Resolution	1/4, 1/8

SETUP parameters	[EDIT] -> BANK [8] (SETUP) (p. 168)	
SYS: LCD Contrast	LCD Contrast	1-16
SYS: Master Tune	Master Tune	427.4-452.6
SYS: ScaleTune SW	Scale Tune Switch	OFF, ON
SYS: ScaleTune C-B	Scale Tune C-B	-64+63
SYS: Patch Remain	Patch Remain	OFF, ON
SYS: V-Reserve P	Voice Reserve	0-64
SYS: Reso Limit-N	Resonance Limiter N	50-127
SYS: Reso Limit-R	Resonance Limiter R	50-127
SYS: Default PTN	Default Pattern	P:A11-C:D18
SYS: Default Arp	Default Arpeggio Style	1*

1\*: 1/4, 1/6, 1/8, 1/12, 1/16, 1/32, PORTAMENTO A-B, GRISSANDO, SEQUENCE A-D, ECHO, SYNTH BASS, HEAVY SLAP, LIGHT SLAP, WALK BASS, RHYTHM GTR 1-5, 3 FINGER, STRUMMING GTR, PIANO BACKING, CLAVI CHORD, WALTZ, SWING WALTZ, REGGAE, PERCUSSION, HARP, SHAMISEN, BOUND BALL, RANDOM, BOSSA NOVA, SALSA, MAMBO, LATIN PERCUSSION, SAMBA, TANGO, HOUSE, LIMITLESS, USER TYPE 1-20

## Play Quantize Parameters

#: Parameters which can also be operated from the front-panel knobs or buttons.

QUANTIZE parameters	[EDIT] -> NUMBER [7] (QUANTIZE) (p. 41, 42, 43)	
GRID: Resolution #	Resolution	1/4, 1/6, 1/8, 1/12, 1/16, 1/24, 1/32
GRID: Strength #	Strength	0-100%
SHUFFLE: Resolution #	Resolution	1/12, 1/24
SHUFFLE: ShuffleRate #	Shuffle Rate	0-100 %
GROOVE: Groove Template #	Groove Template	01-71
GROOVE: Strength #	Strength	0-100 %
GROOVE: Velocity #	Velocity Strength	0-100 %

# Transmit/Receive Setting List

	Parameter	MODE1 (Factory setting)	MODE2	Value
FILTER	FILTER TYPE	EXCLUSIVE	CC#34	0-4 *1
	CUTOFF	CC#74	CC#74	0-127 *1
	RESONANCE	CC#71	CC#71	0-127 *1
F-ENVELOPE	DEPTH	CC#81	CC#81	1-127 (Center=64) *1
	A	CC#82	CC#82	0-127 *1
	D	CC#83	CC#83	0-127 *1
	S	EXCLUSIVE	CC#28	0-127 *1
	R	EXCLUSIVE	CC#29	0-127 *1
AMPLIFIER	TONE LEVEL	EXCLUSIVE	CC#36	0-127 *1
	TONE PAN	EXCLUSIVE	CC#35	0-127 (Center=64) *1
	RND PAN	EXCLUSIVE	CC#37	0 (OFF), 63 (ON) *1
A-ENVELOPE	A	CC#73	CC#73	0-127 *1
	D	CC#75	CC#75	0-127 *1
	S	EXCLUSIVE	CC#31	0-127 *1
	R	CC#72	CC#72	0-127 *1
PITCH	COARSE TUNE	EXCLUSIVE	CC#21	16-112 (Center=64) *1
	FINE TUNE	CC#77	CC#77	14-114 (Center=64) *1
P-ENVELOPE	DEPTH	EXCLUSIVE	CC#25	52-76 (Center=64) *1
	A	EXCLUSIVE	CC#26	0-127 *1
	D	EXCLUSIVE	CC#27	0-127 *1
	S	EXCLUSIVE	CC#39	0-127 (Center=64) *1
	R	EXCLUSIVE	CC#40	0-127 *1
LFO1	WAVEFORM	EXCLUSIVE	CC#15	0-7 *1
	RATE	CC#16	CC#16	0-127 *1
	FADE TIME	EXCLUSIVE	CC#20	0-127
	P-DEPTH	CC#18	CC#18	1-127 (Center=64) *1
	F-DEPTH	CC#19	CC#19	1-127 (Center=64) *1
	A-DEPTH	CC#80	CC#80	1-127 (Center=64) *1
PORTAMENTO	SW	CC#65	CC#65	0-63 (OFF), 64 -127 (ON)
	TIME	CC#5	CC#5	0-127
PART MIXER	LEVEL	CC#7	CC#7	0-127
	PAN	CC#10	CC#10	0-127 (Center=64)
	KEY SHIFT	EXCLUSIVE	CC#85	16-112 (Center=64)
	REVERB	CC#91	CC#91	0-127
	DELAY	CC#94	CC#94	0-127
	M-FX SW	EXCLUSIVE	CC#86	0 (OFF), 1 (ON), 4 (RHY)

\*1 During PATCH EDIT, system exclusive is used for transmission regardless of the mode.

\* The parameters for each knob of the Reverb, Delay and Multi-Effects are transmitted and received as system exclusive messages regardless of the mode.

# MIDI Implementation

Model: JX-305 (groovesynth)  
 Date: Mar. 6, 1998  
 Version: 1.00

Symbol	Description	Range
n	MIDI Channel	0H-6H,9H (ch.1~ch.7,ch.10)
vv	Control value	00H-7FH (0-127)
kk	Note Number	00H-7FH (0-127)
xx	ON/OFF	00H-3FH (0-63:OFF), 40H-7FH (64-127:ON)

## 1. Data reception (sound source section)

### ■ Channel voice messages

#### ● Note Off

status	2nd byte	3rd byte
8nH	kkH	vvH
9nH	kkH	00H

- Not received when the Rx Switch parameter is OFF.
- Not received by the Rhythm Part when the Envelope Mode parameter is NO-SUS.
- If the Remote Keyboard Switch is ON, the message will have the same effect as when a note is released on the JX-305's keyboard. This means that you can control the arpeggiator and RPS from an external MIDI keyboard.

#### ● Note On

status	2nd byte	3rd byte
9nH	kkH	vvH
vv=Note On velocity:	01H - 7FH (1 - 127)	

- Not received when the Rx Switch parameter is OFF.
- If the Remote Keyboard Switch is ON, the message will have the same effect as when a note is played on the JX-305's keyboard. This means that you can control the arpeggiator and RPS from an external MIDI keyboard.

#### ● Polyphonic Aftertouch

status	2nd byte	3rd byte
AnH	kkH	vvH

- Not received when the Rx Switch parameter is OFF.
- The effect will apply according to the Aftertouch Control setting.

#### ● Control Change

- Not received when the Rx Switch parameter is OFF.

#### ○ Bank Select (Controller number 0,32)

status	2nd byte	3rd byte
BnH	00H	mmH
BnH	20H	llH
mn,ll=Bank number:	00 00H-7F 7FH (bank.1-bank.16384)	

- Not received when the Rx Program Change Switch or Rx Bank Select Switch parameter is OFF.
- The Patches corresponding to each Bank Select are as follows.

Bank Select	Program No	Group	Patch No.	
MSB	LSB			
81	0	1 - 64	Preset A	11 - 88
81	0	65 - 128	Preset B	11 - 88
81	1	1 - 64	Preset C	11 - 88
81	1	65 - 128	Preset D	11 - 88
81	2	1 - 64	Preset E	11 - 88
81	2	65 - 128	Preset F	11 - 88
81	3	1 - 64	Preset G	11 - 88
81	3	65 - 128	Preset H	11 - 88
82	0	1 - 64	Preset I	11 - 88
82	0	65 - 128	Preset J	11 - 88
85	0	1 - 64	User A	11 - 88
85	0	65 - 128	User B	11 - 88
85	1	1 - 64	User C	11 - 88
85	1	65 - 128	User D	11 - 88
86	0	1 - 64	Card A	11 - 88
86	0	65 - 128	Card B	11 - 88
86	1	1 - 64	Card C	11 - 88
86	1	65 - 128	Card D	11 - 88
86	2	1 - 64	Card E	11 - 88
86	2	65 - 128	Card F	11 - 88
86	3	1 - 64	Card G	11 - 88
86	3	65 - 128	Card H	11 - 88

- The Rhythm set corresponding to each Bank Select are as follows.

Bank Select	Program No	Group	Patch No.	
MSB	LSB			
81	0	1 - 26	Preset A	11 - 42
82	0	1 - 6	Preset B	11 - 16
85	0	1 - 20	User A	11 - 34
86	0	1 - 20	Card A	11 - 34

#### ○ Modulation (Controller number 1)

status	2nd byte	3rd byte
BnH	01H	vvH

- The effect will apply according to the Modulation Control setting.

#### ○ Portamento Time (Controller number 5)

status	2nd byte	3rd byte
BnH	05H	vvH

- The Portamento Time parameter will change.

#### ○ Data Entry (Controller number 6,38)

status	2nd byte	3rd byte
BnH	06H	mmH
BnH	26H	llH

mm,ll= the value of the parameter specified by RPN mm=MSB, ll=LSB

#### ○ Volume (Controller number 7)

status	2nd byte	3rd byte
BnH	07H	vvH

- Volume messages are used to adjust the volume balance of each part.

#### ○ Panpot (Controller number 10)

status	2nd byte	3rd byte
BnH	0AH	vvH

- Adjust the stereo location over 128 steps, where 0 is far left, 64 is center, and 127 is far right.

#### ○ Expression (Controller number 11)

status	2nd byte	3rd byte
BnH	0BH	vvH

- Expression messages are used to adjust the volume of each part.

#### ○ General purpose Controller1 (Controller number 16)

status	2nd byte	3rd byte
BnH	10H	vvH

- The LFO1 Rate parameter will change.

#### ○ General purpose Controller3 (Controller number 18)

status	2nd byte	3rd byte
BnH	12H	vvH

- The LFO1 Pitch Depth parameter will change

#### ○ General purpose Controller4 (Controller number 19)

status	2nd byte	3rd byte
BnH	13H	vvH

- The LFO1 Filter Depth parameter will change relatively.

#### ○ Hold 1 (Controller number 64)

status	2nd byte	3rd byte
BnH	40H	xxH

- If the Remote Keyboard Switch is ON, it will be possible to control the Hold function of the arpeggiator.

#### ○ Portamento (Controller number 65)

status	2nd byte	3rd byte
BnH	41H	xxH

- The Portamento Switch Parameter will change.

#### ○ Sostenuto (Controller number 66)

status	2nd byte	3rd byte
BnH	42H	xxH



○ **Soft (Controller number 67)**

status    2nd byte    3rd byte  
BnH       43H       xxH

○ **Hold 2 (Controller number 69)**

status    2nd byte    3rd byte  
BnH       45H       xxH

- If the Remote Keyboard Switch is ON, operation will be the same as when the switch pedal of the JX-305 is operated.

○ **Sound Controller2 (Controller number 71)**

status    2nd byte    3rd byte  
BnH       47H       vvH

- The Resonance parameter will change.

○ **Sound Controller3 (Controller number 72)**

status    2nd byte    3rd byte  
BnH       48H       vvH

- The Amp Envelope Time1 parameter will change.

○ **Sound Controller4 (Controller number 73)**

status    2nd byte    3rd byte  
BnH       49H       vvH

- The Amp Envelope Time4 parameter will change.

○ **Sound Controller5 (Controller number 74)**

status    2nd byte    3rd byte  
BnH       4AH       vvH

- The Cutoff Frequency parameter will change.

○ **Sound Controller6 (Controller number 75)**

status    2nd byte    3rd byte  
BnH       4BH       vvH

- The Amp Envelope Time 3 parameter will change.

○ **Sound Controller8 (Controller number 77)**

status    2nd byte    3rd byte  
BnH       4DH       vvH

- The Fine Tune parameter will change.

○ **General purpose Controller5 (Controller number 80)**

status    2nd byte    3rd byte  
BnH       50H       vvH

- The LFO1 Amp Depth parameter will change.

○ **General purpose Controller6 (Controller number 81)**

status    2nd byte    3rd byte  
BnH       51H       vvH

- The Filter Envelope Depth parameter will change.

○ **General purpose Controller7 (Controller number 82)**

status    2nd byte    3rd byte  
BnH       52H       vvH

- The Filter Envelope Time 1 parameter will change.

○ **General purpose Controller8 (Controller number 83)**

status    2nd byte    3rd byte  
BnH       53H       vvH

- The Filter Envelope Time 3 parameter will change.

○ **Portamento Control (Controller number 84)**

status    2nd byte    3rd byte  
BnH       54H       kkH

- A Note On message received immediately after a Portamento control will be sounded with the pitch changing smoothly from the source note number. If a voice is already sounding at the same note number as the source note number, that voice will change pitch to the pitch of the newly received Note On, and continue sounding (i.e., will be played legato).
- The speed of the pitch change caused by Portamento is determined by the Portamento Time parameter.

○ **Effect 1 (Reverb Send Level) (Controller number 91)**

status    2nd byte    3rd byte  
BnH       5BH       vvH

- The Part Reverb Send Level will change.

○ **Effect 4 (Reverb Send Level)(Controller number 94)**

status    2nd byte    3rd byte  
BnH       5EH       vvH

- The Part Reverb Send Level will change.

○ **RPN MSB/LSB (Controller number 100,101)**

status    2nd byte    3rd byte  
BnH       65H       mmH  
BnH       64H       llH

mm=MSB of the parameter number specified by RPN

ll=LSB of the parameter number specified by RPN

<< RPN >>

Control Changes include RPN (Registered Parameter Numbers), which are extended parameters whose function is defined in the MIDI specification.

When using RPNs, first the RPN (Controller numbers 100 and 101; they can be sent in any order) is transmitted to specify the parameter you wish to control. Then, Data Entry messages (Controller numbers 6 and 38) are used to set the value of the specified parameter. Once a RPN parameter has been specified, all further Data Entry messages on that channel are considered to apply to that specified parameter. In order to prevent accidents, when the desired setting has been made for the parameter, it is recommended that RPN be set to Null.

This device receives the following RPNs.

RPN	Data entry	Notes
MSB LSB	MSB LSB	
00H 00H	mmH —	Pitch Bend Sensitivity mm : 00H-0CH (0-12 semitones) ll : ignored (processed as 00H) Up to 1 octave can be specified in semitone steps. • The Bend Range up parameter, Bend Range Down parameter will also be changed. • Not received by the Part R.
00H 01H	mmH llH	Master Fine Tuning mm, ll: 20 00H-40 00H-60 00H (-8192 x 50 / 8192-0-+8192 x 50 / 8192 cent ) • The Fine Tune parameter of each Part will change.
00H 02H	mmH —	Master Coarse Tuning mm : 10H-40H-70H (-48-0-+48 semitones) ll : ignored (processed as 00H) • The Key Shift parameter of each Part will change.
7FH 7FH	— —	RPN null RPN will be set as "unspecified". Once this setting has been made, subsequent Data Entry messages will be ignored. (It is not necessary to transmit Data Entry for RPN Null settings. Parameter values that were previously set will not change. mm, ll: ignored

● **Program Change**

status    2nd byte  
CnH       ppH  
pp=Program number:    00H-7FH (prog.1-prog.128)

- Not received when the Rx Program Change Switch parameter is OFF.
- Not received when the Rx Switch parameter is OFF.

### ● Channel Aftertouch

status	2nd byte
DnH	vvH

- Not received when the Rx Switch parameter is OFF.
- The effect will apply according to the Aftertouch Control setting.

### ● Pitch Bend Change

status	2nd byte	3rd byte
ErH	llH	mmH

mm,ll=Pitch Bend value: 00 00H-40 00H-7F 7FH (-8192-0-+8191)

- Not received when the Rx Switch parameter is OFF.
- The effect will apply according to the Pitch Bend Control setting.

## ■ Channel Mode messages

### ● All Sound Off (Controller number 120)

status	2nd byte	3rd byte
BnH	78H	00H

- When this message is received, all notes currently sounding on the corresponding channel will be turned off.
- Not received when the Rx Switch parameter is OFF.

### ● Reset All Controllers (Controller number 121)

status	2nd byte	3rd byte
BnH	79H	00H

- Not received when the Rx Switch parameter is OFF.
- When this message is received, the following controllers will be set to their reset values.

Controller	Reset value
Pitch Bend Change	±0 (center)
Polyphonic Key Pressure	0 (off)
Channel Pressure	0 (off)
Modulation	0 (off)
Expression	127 (maximum)
Hold 1	0 (off)
Sostenuto	0 (off)
Soft	0 (off)
Hold 2	0 (off)
RPN	Unset. Previously set data will not change.

### ● All Note Off (Controller number 123)

status	2nd byte	3rd byte
BnH	7BH	00H

- When All Note Off is received, all currently sounding notes of the corresponding channel will be turned off. However if Hold 1 or Sostenuto are on, the sound will be held until these are turned off.
- Not received when the Rx Switch parameter is OFF.

### ● Omni Off (Controller number 124)

status	2nd byte	3rd byte
BnH	7CH	00H

- The same processing as when All Note Off is received will be done.
- Not received when the Rx Switch parameter is OFF.

### ● Omni On (Controller number 125)

status	2nd byte	3rd byte
BnH	7DH	00H

- The same processing as when All Note Off is received will be done. The instrument will not be set to OMNI ON.
- Not received when the Rx Switch parameter is OFF.

### ● Mono (Controller number 126)

status	2nd byte	3rd byte
BnH	7EH	mmH

mm=Mono number: 00H-10H (0-16)

- The same processing as when All Note Off is received will be done, and the Solo Switch parameter will be set to ON.
- Not received when the Rx Switch parameter is OFF.

### ● Poly (Controller number 127)

status	2nd byte	3rd byte
BnH	7FH	00H

- The same processing as when All Note Off is received will be done, and the Solo Switch parameter will be set to OFF.
- Not received when the Rx Switch parameter is OFF.

## ■ System Realtime messages

### ● Timing Clock

status
F8H

- This is received when Sync Mode is SLAVE. Settings can be made to synchronize or the LFO rate or the effect rate.

### ● Active Sensing

status
FEH

- When an Active Sensing message is received, the unit will begin monitoring the interval at which MIDI messages are received. During monitoring, if more than 420 ms passes without a message being received, the same processing will be done as when All Sound Off, All Note Off, and Reset All Controllers messages are received. Then monitoring will be halted.

## ■ System Exclusive messages

status	data byte	status
F0H	iiH, ddH, ....., eeH	F7H

- F0H: System Exclusive message status
- ii = ID number: This is the ID number (manufacturer ID) that specifies the manufacturer whose exclusive message this is. Roland's manufacturer ID is 41H. ID numbers 7EH and 7FH are defined in an expansion of the MIDI standard as Universal Non-realtime messages (7EH) and Universal Realtime Messages (7FH).
- dd,...., ee = data: 00H-7FH (0-127)
- F7H: EOX (End Of Exclusive) This is the last status of system exclusive message.

### ● Universal Non-realtime System Exclusive Messages

#### ○ Inquiry Request Message

Status	Data byte	Status
F0H	7EH, dev, 06H, 01H	F7H

Byte	Explanation
F0H	Exclusive status
7EH	ID number (universal non-realtime message)
dev	Device ID (dev:10H(17)-1FH(32))
06H	Sub ID#1 (General Information)
01H	Sub ID#2 (Inquiry Request)
F7H	EOX (End Of Exclusive)

- The "dev" is own device number or 7FH (Broadcast)
- When Inquiry Request is received, Inquiry Reply message will be transmitted.

### ● Data Request 1 RQ1

This message requests the other device to transmit data. The address and size indicate the type and amount of data that is requested.

When a Data Request message is received, if the device is in a state in which it is able to transmit data, and if the address and size are appropriate, the requested data is transmitted as a Data Set 1 (DT1) message. If the conditions are not met, nothing is transmitted.

The model ID of the exclusive messages used by this instrument is 00 0BH.

status	data byte	status
F0H	41H, dev, 00H, 0BH, 11H, aaH, bbH, ccH, ddH, ssH, ttH, uuH, vvH, sum	F7H

Byte	Remarks
F0H	Exclusive status
41H	ID number (Roland)
dev	device ID (dev: 10H-1FH)
00H	model ID (JX-305)
0BH	model ID (JX-305)
11H	command ID (RQ1)
aaH	address MSB
bbH	address
ccH	address
ddH	address LSB
ssH	size MSB
ttH	size
uuH	size
vvH	size LSB
sum	checksum
F7H	EOX (End Of Exclusive)

- For the address, size, and checksum, refer to "Examples of system exclusive messages and calculating the checksum" (p. 253).
- This message is not received if the Rx.System Exclusive Switch parameter is OFF.

### ● Data Set 1 DT1

This message transmits the actual data, and is used when you wish to set the data of the receiving device.

status	data byte	status
F0H	41H, dev, 00H, 0BH, 12H, aaH, bbH, ccH, ddH, eeH, ... ffH, sum	F7H

Byte	Remarks
F0H	Exclusive status
41H	ID number (Roland)
dev	device ID (dev: 10H-1FH)
00H	model ID (JX-305)
0BH	model ID (JX-305)
12H	command ID (DT1)
aaH	address MSB
bbH	address
ccH	address
ddH	address LSB
eeH	data: The actual data to be transmitted. Multi-byte data is transmitted in the order of the address.
:	:
ffH	data
sum	checksum
F7H	EOX (End Of Exclusive)

- For the address, size, and checksum, refer to "Examples of system exclusive messages and calculating the checksum" (p. 253).
- Data whose size is greater than 128 bytes should be divided into packets of 128 bytes or less and transmitted. Successive "Data Set 1" messages should have at least 20 ms of time interval between them.
- This message is not received if the Rx.System Exclusive Switch parameter is OFF.

The only GS exclusive messages received by the JX-305 are Scale Tune settings (p. 253).

### ● Data Set 1 DT1

status	data byte	status
F0H	41H, dev, 42, 12H, aaH, bbH, ccH, ddH, ... eeH, sum	F7H

Byte	Remarks
F0H	Exclusive status
41H	ID number (Roland)
dev	device ID (dev: 10H-1FH)
42H	model ID (GS)
12H	command ID (DT1)
aaH	address MSB
bbH	address
ccH	address LSB
ddH	data: The actual data to be transmitted. Multi-byte data is transmitted in the order of the address.
:	:
eeH	data
sum	checksum
F7H	EOX (End Of Exclusive)

- This message is not received if the Rx.System Exclusive Switch parameter is OFF.

In addition to conventional system exclusive messages, the JX-305 also uses special system exclusive messages for operations which require realtime handling, such as knobs.

### ● Data Set 1 DT1

status	data byte	status
F0H	41H, dev, 3AH, 12H, aaH, bbH, ccH, ddH, sum	F7H

Byte	Remarks
F0H	Exclusive status
41H	ID number (Roland)
dev	device ID (dev: 10H-1FH)
3AH	model ID (JX-305 Quick)
12H	command ID (DT1)
aaH	address (Status/Channel)
bbH	address/Data H
ccH	Data L
ddH	Data E
sum	checksum
F7H	EOX (End Of Exclusive)

- For the address, size, and checksum, refer to "Examples of system exclusive messages and calculating the checksum" (p. 253).
- Transmission of consecutive addresses is not possible.
- This message is not received if the Rx.System Exclusive Switch parameter is OFF.

## 2. Data transmission (sound source section)

### ■ Channel Voice messages

#### ● Note Off

status	2nd byte	3rd byte
8nH	kkH	vvH

#### ● Note On

status	2nd byte	3rd byte
9nH	kkH	vvH
vv=Note On velocity:	01H - 7FH (1 - 127)	

#### ● Control Change

- By selecting a controller number that corresponds to the setting of the Control Pedal Assign parameter, you can transmit any desired control change.

○ **Bank Select (Controller number 0,32)**

<u>status</u>	<u>2nd byte</u>	<u>3rd byte</u>
BnH	00H	mmH
BnH	20H	llH
mm,ll=Bank number:	00 00H - 7F 7FH (bank.1 - bank.16384)	

- \* This message is not transmitted if Tx Program Change Switch parameter or Tx Bank Select Switch parameter is OFF.
- \* For the Bank Select that corresponds to each Patch, refer to section 1.

○ **Modulation (Controller number 1)**

<u>status</u>	<u>2nd byte</u>	<u>3rd byte</u>
BnH	01H	vvH

○ **Portamento Time (Controller number 5)**

<u>status</u>	<u>2nd byte</u>	<u>3rd byte</u>
BnH	05H	vvH

○ **Volume (Controller number 7)**

<u>status</u>	<u>2nd byte</u>	<u>3rd byte</u>
BnH	07H	vvH

○ **Panpot (Controller number 10)**

<u>status</u>	<u>2nd byte</u>	<u>3rd byte</u>
BnH	0AH	vvH

○ **Expression (Controller number 11)**

<u>status</u>	<u>2nd byte</u>	<u>3rd byte</u>
BnH	0BH	vvH

○ **General purpose Controller1, 3, 4 (Controller number 16, 18, 19)**

<u>status</u>	<u>2nd byte</u>	<u>3rd byte</u>
BnH	10H,12H,13H	vvH

○ **Hold 1 (Controller number 64)**

<u>status</u>	<u>2nd byte</u>	<u>3rd byte</u>
BnH	40H	xxH

○ **Portamento (Controller number 65)**

<u>status</u>	<u>2nd byte</u>	<u>3rd byte</u>
BnH	41H	xxH

○ **Sostenuto (Controller number 66)**

<u>status</u>	<u>2nd byte</u>	<u>3rd byte</u>
BnH	42H	xxH

○ **Soft (Controller number 67)**

<u>status</u>	<u>2nd byte</u>	<u>3rd byte</u>
BnH	43H	xxH

○ **Hold 2 (Controller number 69)**

<u>status</u>	<u>2nd byte</u>	<u>3rd byte</u>
BnH	45H	xxH

○ **Sound Controller2-6,8 (Controller number 71-75, 77)**

<u>status</u>	<u>2nd byte</u>	<u>3rd byte</u>
BnH	47H-4BH,4DH	vvH

○ **General purpose Controller5-8 (Controller number 80-83)**

<u>status</u>	<u>2nd byte</u>	<u>3rd byte</u>
BnH	50H-53H	vvH

○ **Portamento control (Controller number 84)**

<u>status</u>	<u>2nd byte</u>	<u>3rd byte</u>
BnH	54H	kkH

○ **Effect 1 (Controller number 91)**

<u>status</u>	<u>2nd byte</u>	<u>3rd byte</u>
BnH	5BH	vvH

○ **Effect 4 (Controller number 91)**

<u>status</u>	<u>2nd byte</u>	<u>3rd byte</u>
BnH	5EH	vvH

● **Program Change**

<u>status</u>	<u>2nd byte</u>
CnH	ppH
pp=Program number:	00H - 7FH (prog.1 - prog.128)

- \* This message is not transmitted when the Tx Program Change Switch parameter is OFF.

● **Channel Aftertouch**

<u>status</u>	<u>2nd byte</u>
DnH	vvH

● **Pitch Bend Change**

<u>status</u>	<u>2nd byte</u>	<u>3rd byte</u>
EnH	llH	mmH
mm,ll=Pitch Bend value:	00 00H - 40 00H - 7F 7FH (-8192 - 0 - +8191)	

■ **System Realtime messages**

● **Active Sensing**

<u>status</u>
FEH

- \* Transmitted at intervals of approximately 250ms.
- \* Not transmitted if the Tx Active Sensing Switch parameter is OFF.

■ **System Exclusive messages**

● **Universal Non-realtime System Exclusive Messages**

○ **Inquiry Reply**

<u>Status</u>	<u>Data byte</u>	<u>Status</u>
F0H	7EH, dev, 06H, 02H, 41H, 0BH, 01H, 01H, 00H, 00H, 03H, 00H, 00H	F7H

<u>Byte</u>	<u>Explanation</u>
F0H	Exclusive status
7EH	ID number (universal non-realtime message)
dev	Device ID (dev:10H(17)-1FH(32))
06H	Sub ID#1 (General Information)
02H	Sub ID#2 (Inquiry Reply)
41H	ID number (Roland)
0BH 01H	Device family code
01H 00H	Device family number code
00H 03H 00H 00H	Software revision level
F7H	EOX (End of Exclusive)

- \* When Inquiry Request is received, Inquiry Reply message will be transmitted.

### ● Data Set 1 DT1

status	data byte	status
F0H	41H, dev, 00H, 0BH, 12H, aaH, bbH, ccH, ddH, eeH, ... ffH, sum	F7H

Byte	Remarks
F0H	Exclusive status
41H	ID number (Roland)
dev	device ID (dev: 10H-1FH)
00H	model ID (JX-305)
0BH	model ID (JX-305)
12H	command ID (DT1)
aaH	address MSB
bbH	address
ccH	address
ddH	address LSB
eeH	data: The actual data to be transmitted. Multi-byte data is transmitted in the order of the address.
:	:
ffH	data
sum	checksum
F7H	EOX (End Of Exclusive)

- \* For the address, size, and checksum, refer to "Examples of system exclusive messages and calculating the checksum" (p. 253).
- \* Data whose size is greater than 128 bytes should be divided into packets of 128 bytes or less and transmitted. Successive "Data Set 1" messages should have at least 20 ms of time interval between them.

### ● Data Set 1 DT1

status	data byte	status
F0H	41H, dev, 3AH, 12H, aaH, bbH, ccH, ddH, sum	F7H

Byte	Remarks
F0H	Exclusive status
41H	ID number (Roland)
dev	device ID (dev: 10H-1FH)
3AH	model ID (JX-305 Quick)
12H	command ID (DT1)
aaH	address (Status/Channel)
bbH	address/Data H
ccH	Data L
ddH	Data E
sum	checksum
F7H	EOX (End Of Exclusive)

- \* For the address, size, and checksum, refer to "Examples of system exclusive messages and calculating the checksum" (p. 253).
- \* Transmission of consecutive addresses is not possible.

## 3. Data reception (Sequencer section)

### 3.1 Messages recorded during recording

#### ■ Channel voice messages

##### ● Note Off

status	2nd byte	3rd byte
8nH	kkH	vvH
9nH	kkH	00H

##### ● Note On

status	2nd byte	3rd byte
9nH	kkH	vvH
vv=Note On velocity:	01H - 7FH (1 - 127)	

##### ● Polyphonic Aftertouch

status	2nd byte	3rd byte
AnH	kkH	vvH

### ● Control Change

status	2nd byte	3rd byte
BnH	kkH	vvH
kk=control number:	00H-78H (0-120)	

### ● Program Change

status	2nd byte
CnH	ppH
pp=Program number:	00H-7FH (prog.1-prog.128)

### ● Channel Aftertouch

status	2nd byte
DnH	vvH

### ● Pitch Bend Change

status	2nd byte	3rd byte
EnH	lH	mmH
mm,ll=Pitch Bend value:	00 00H-40 00H-7F 7FH (-8192-0-+8191)	

#### ■ Channel Mode messages

##### ● All Sound Off (Controller number 120)

status	2nd byte	3rd byte
BnH	78H	00H

##### ● Reset All Controllers (Controller number 121)

status	2nd byte	3rd byte
BnH	79H	00H

##### ● Omni Off (Controller number 124)

status	2nd byte	3rd byte
BnH	7CH	00H

- \* The same processing will be done as when an All Note Off message is received.

##### ● Omni On (Controller number 125)

status	2nd byte	3rd byte
BnH	7DH	00H

- \* The same processing will be done as when an All Note Off message is received.

##### ● Mono (Controller number 126)

status	2nd byte	3rd byte
BnH	7EH	mmH
mm=mono number:	00H-10H (0-16)	

- \* The same processing will be done as when an All Note Off message is received.

##### ● Poly (Controller number 127)

status	2nd byte	3rd byte
BnH	7FH	00H

- \* The same processing will be done as when an All Note Off message is received.

#### ■ System Exclusive messages

status	data byte	status
F0H	iiH, ddH, ....., eeH	F7H

F0H: System Exclusive message status  
 ii = ID number: This is the ID number (manufacturer ID) that specifies the manufacturer whose exclusive message this is. Roland's manufacturer ID is 41H. ID numbers 7EH and 7FH are defined in an expansion of the MIDI standard as Universal Non-realtime messages (7EH) and Universal Realtime Messages (7FH).  
 dd, ..., ee = data: 00H-7FH (0-127)  
 F7H: EOX (End Of Exclusive)

## 3.2 Messages not recorded during recording

### ■ Channel Mode messages

#### ● Local On/Off (Controller number 122)

<u>status</u>	<u>2nd byte</u>	<u>3rd byte</u>
BnH	7AH	00H

vv=value: 00H,7FH (Local off, Local on)

#### ● All Note Off (Controller number 123)

<u>status</u>	<u>2nd byte</u>	<u>3rd byte</u>
BnH	7BH	00H

- \* When an All Note Off message is received, all notes of the corresponding channel that are on will be sent Note Off's, and the resulting Note Off messages will be recorded.

## 3.3 Messages acknowledged for synchronization

### ■ System Common messages

#### ● Song Position Pointer

<u>status</u>	<u>2nd byte</u>	<u>3rd byte</u>
F2H	mmH	llH

mm,ll=value: 00 00H-7F 7FH (0-16383)

### ■ System Realtime messages

#### ● Timing Clock

status  
F8H

- \* This message will be received if the Sync Mode parameter is SLAVE.

#### ● Start

status  
FAH

- \* This message will be received if the Sync Mode parameter is SLAVE or REMOTE.

#### ● Continue

status  
FBH

- \* This message will be received if the Sync Mode parameter is SLAVE or REMOTE.

#### ● Stop

status  
FCH

- \* This message will be received if the Sync Mode parameter is SLAVE or REMOTE.

## 4. Data transmission (Sequencer section)

### 4.1 Recorded messages are transmitted during playback.

4.2 If the Through parameter is ON, messages received (except for System Common messages and System Realtime messages) will be transmitted.

### 4.3 Messages that are generated and transmitted

#### 4.3.1 Messages automatically generated by the system

### ■ Channel Mode messages

#### ● Omni Off (Controller number 124)

<u>status</u>	<u>2nd byte</u>	<u>3rd byte</u>
BnH	7CH	00H

- \* At start-up, this message is transmitted to all channels.

#### ● Poly (Controller number 127)

<u>status</u>	<u>2nd byte</u>	<u>3rd byte</u>
BnH	7FH	00H

- \* At start-up, this message is transmitted to all channels.

#### 4.3.2 Messages generated and transmitted when the Sync Out is ON

### ■ System Common messages

#### ● Song Position Pointer

<u>status</u>	<u>2nd byte</u>	<u>3rd byte</u>
F2H	mmH	llH

mm,ll=value: 00 00H-7F 7FH (0-16383)

### ■ System Realtime messages

#### ● Timing Clock

status  
F8H

#### ● Start

status  
FAH

#### ● Continue

status  
FBH

#### ● Stop

status  
FCH

## 5. Parameter address map

### 1.JX-305 (Model ID=00H 0BH)

- For addresses marked by #, the data is transmitted in two parts. For example, the hexadecimal data ABH would be divided into 0AH and 0BH, and transmitted in this order.
- Addresses for which the Description field is listed as "Reserved" have no meaning for the JX-305. They will be ignored.
- Parameter values enclosed in < > have no meaning for the JX-305.

Start Address	Description	
00 00 00 00	System	1-1
01 00 00 00	Part Info	1-2
02 00 00 00	Temporary Patch(part 1)	1-3
02 01 00 00	Temporary Patch(part 2)	
:		
02 06 00 00	Temporary Patch(part 7)	
02 09 00 00	Temporary Rhythm Setup	1-4
30 00 00 00	Temporary Pattern Setup	1-5
40 00 00 00	Temporary Pattern Body	1-6

#### ■ 1-1.System

Offset Address	Description	
00 00	System Common	1-1-1
10 00	Part 1 Scale Tune	1-1-2
11 00	Part 2 Scale Tune	
:		
16 00	Part 7 Scale Tune	

#### ■ 1-1-1.System Common

Offset Address	Size	Description	Data (Value)
00 00-00 05	0aaa aaaa	Reserved	--
00 06	0aaa aaaa	Master Tune	0 - 126 *1
00 07	0000 000a	Scale Tune Switch	0 - 1 (OFF,ON)
00 08	0000 000a	M-FX Switch	0 - 1 (OFF,ON)
00 09	0000 000a	Delay Switch	0 - 1 (OFF,ON)
00 0A	0000 000a	Reverb Switch	0 - 1 (OFF,ON)
00 0B	0000 000a	Patch Remain	0 - 1 (OFF,ON)
00 0C-00 13	0aaa aaaa	Reserved	--
00 14	0000 000a	Receive Program Change Switch	0 - 1 (OFF,ON)
00 15	0000 000a	Receive Bank Select Switch	0 - 1 (OFF,ON)
00 16-00 27	0aaa aaaa	Reserved	--
00 28	0000 000a	Transmit Program Change Switch	0 - 1 (OFF,ON)
00 29	0000 000a	Transmit Bank Select Switch	0 - 1 (OFF,ON)
00 2A-00 61	0aaa aaaa	Reserved	--
Total size	00 00 00 62		

\*1:427.4 - 452.6

#### ■ 1-1-2.Scale Tune

Offset Address	Size	Description	Data (Value)
00 00	0aaa aaaa	Scale Tune for C	0 - 127 (-64 - +63)
00 01	0aaa aaaa	Scale Tune for C#	0 - 127 (-64 - +63)
00 02	0aaa aaaa	Scale Tune for D	0 - 127 (-64 - +63)
00 03	0aaa aaaa	Scale Tune for D#	0 - 127 (-64 - +63)
00 04	0aaa aaaa	Scale Tune for E	0 - 127 (-64 - +63)
00 05	0aaa aaaa	Scale Tune for F	0 - 127 (-64 - +63)
00 06	0aaa aaaa	Scale Tune for F#	0 - 127 (-64 - +63)
00 07	0aaa aaaa	Scale Tune for G	0 - 127 (-64 - +63)
00 08	0aaa aaaa	Scale Tune for G#	0 - 127 (-64 - +63)
00 09	0aaa aaaa	Scale Tune for A	0 - 127 (-64 - +63)
00 0A	0aaa aaaa	Scale Tune for A#	0 - 127 (-64 - +63)
00 0B	0aaa aaaa	Scale Tune for B	0 - 127 (-64 - +63)
Total size	00 00 00 0C		

#### ■ 1-2.Part Info

Offset Address	Description	
00 00	Part Info Common	1-2-1
10 00	Part Info Part 1	1-2-2
11 00	Part Info Part 2	
:		
16 00	Part Info Part 7	
19 00	Part Info Part R	

## ■ 1-2-1.Part Info Common

Offset Address	Size	Description	Data (Value)
00 00-00 0C	0aaa aaaa	Reserved	--
00 0D	00aa aaaa	M-FX Type	0 - 23
00 0E	0aaa aaaa	M-FX Parameter 1	0 - 127
00 0F	0aaa aaaa	M-FX Parameter 2	0 - 127
00 10	0aaa aaaa	M-FX Parameter 3	0 - 127
00 11	0aaa aaaa	M-FX Parameter 4	0 - 127
00 12	0aaa aaaa	M-FX Parameter 5	0 - 127
00 13	0aaa aaaa	M-FX Parameter 6	0 - 127
00 14	0aaa aaaa	M-FX Parameter 7	0 - 127
00 15	0aaa aaaa	M-FX Parameter 8	0 - 127
00 16	0aaa aaaa	M-FX Parameter 9	0 - 127
00 17	0aaa aaaa	M-FX Parameter 10	0 - 127
00 18	0aaa aaaa	M-FX Parameter 11	0 - 127
00 19	0aaa aaaa	M-FX Parameter 12	0 - 127
00 1A-00 1B	0aaa aaaa	Reserved	--
00 1C	0aaa aaaa	M-FX Delay Send Level	0 - 127
00 1D	0aaa aaaa	M-FX Reverb Send Level	0 - 127
00 1E-00 21	0aaa aaaa	Reserved	--
00 22	0aaa aaaa	Delay Level	0 - 127
00 23	0000 000a	Delay Type	0 - 1 *1
00 24	0aaa aaaa	Delay HF Damp	0 - 17 *4
00 25	0aaa aaaa	Delay Time	0 - 120
00 26	0aaa aaaa	Delay Feedback Level	0 - 98
00 27	0000 00aa	Delay Output Assign	0 - 2 *2
00 28	0000 0aaa	Reverb Type	0 - 7 *3
00 29	0aaa aaaa	Reverb Level	0 - 127
00 2A	0aaa aaaa	Reverb Time	0 - 127
00 2B	000a aaaa	Reverb HF Damp	0 - 17 *4
00 0C-00 2F	0aaa aaaa	Reserved	--
00 30	0aaa aaaa	Voice Reserve 1	0 - 64
00 31	0aaa aaaa	Voice Reserve 2	0 - 64
00 32	0aaa aaaa	Voice Reserve 3	0 - 64
00 33	0aaa aaaa	Voice Reserve 4	0 - 64
00 34	0aaa aaaa	Voice Reserve 5	0 - 64
00 35	0aaa aaaa	Voice Reserve 6	0 - 64
00 36	0aaa aaaa	Voice Reserve 7	0 - 64
00 37-00 38	0aaa aaaa	Reserved	--
00 39	0aaa aaaa	Voice Reserve R	0 - 64
00 3A-00 43	0aaa aaaa	Reserved	--
Total size	00 00 00 44		

\*1: SHORT, LONG

\*2: LINE, REV, LINE+REV

\*3: ROOM1, ROOM2, STAGE1, STAGE2, HALL1, HALL2

\*4: 200, 250, 315, 400, 500, 630, 800, 1000, 1250, 1600, 2000, 2500, 3150, 4000, 5000, 6300, 8000, BYPASS

M-FX Parameter	Value	Display
Type 0: 4-BAND-EQ		
prm1	Low Freq	0 - 1      200,400
prm2	Low Gain	0 - 30     -15 - +15
prm3	High Freq	0 - 1      4000,8000
prm4	High Gain	0 - 30     -15 - +15
prm5	Peak1 Freq	0 - 16     *1
prm6	Peak1 Q	0 - 4      0.5,1.0,2.0,4.0,8.0
prm7	Peak1 Gain	0 - 30     -15 - +15
prm8	Peak2 Freq	0 - 16     *1
prm9	Peak2 Q	0 - 4      0.5,1.0,2.0,4.0,8.0
prm10	Peak2 Gain	0 - 30     -15 - +15
prm11	Output Level	0 - 127
Type 1: SPECTRUM		
prm1	Low-High	0 - 30     -15 - +15
prm2	Middle Gain	0 - 30     -15 - +15
prm3	Width	0 - 4      1 - 5
prm4	Output Pan	0 - 127    L64 - R63
prm5	Output Level	0 - 127
Type 2: ENHANCER		
prm1	Sens	0 - 127
prm2	Mix	0 - 127
prm3	Low Gain	0 - 30     -15 - +15
prm4	High Gain	0 - 30     -15 - +15
prm5	Output Level	0 - 127
Type 3: OVERDRIVE		
prm1	Input Level	0 - 127
prm2	Drive	0 - 127
prm3	AMP Type	0 - 3      SMALL, BUILTIN, 2STACK, 3STACK
prm4	Output Pan	0 - 127    L64 - R63
prm5	Output Level	0 - 127
Type 4: DISTORTION		
prm1	Input Level	0 - 127
prm2	Drive	0 - 127
prm3	AMP Type	0 - 3      SMALL, BUILTIN, 2STACK, 3STACK
prm4	Output Pan	0 - 127    L64 - R63
prm5	Output Level	0 - 127
Type 5: Lo-Fi		
prm1	BitDown	0 - 7
prm2	S-Rate Down	0 - 3      32,16,8,4
prm3	Post Gain	0 - 3      0,-6,+12,+18
prm4	Low Gain	0 - 30     -15 - +15
prm5	High Gain	0 - 30     -15 - +15
prm6	Output	0 - 1      MONO, STEREO
prm7	Output Level	0 - 127



Type 6: NOISE			
prm1	Noise Type	0 - 17	1 - 18
prm2	Noise Level	0 - 127	
prm3	N Filter	0 - 17	*1,BYPASS
prm4	Lo-Fi Level	0 - 127	
prm5	Output Pan	0 - 127	L64 - R63
prm6	Output Level	0 - 127	
Type 7: RADIO-TUNG			
prm1	Radio Detune	0 - 127	
prm2	Noise Level	0 - 127	
prm3	Low Gain	0 - 30	-15 - +15
prm4	High Gain	0 - 30	-15 - +15
prm5	Output	0 - 1	MONO,STEREO
prm6	Output Level	0 - 127	
Type 8: PHONOGRAPH			
prm1	Disc Type	0 - 2	LP,EP,SP
prm2	D Noise Level	0 - 127	
prm3	Depth	0 - 20	0 - +20
prm4	Output Pan	0 - 127	L64 - R63
prm5	Output Level	0 - 127	
Type 9: COMPRESSOR			
prm1	Attack	0 - 127	
prm2	Sustain	0 - 127	
prm3	Post Gain	0 - 3	0,+6,+12,+18
prm4	Low Gain	0 - 30	-15 - +15
prm5	High Gain	0 - 30	-15 - +15
prm6	Output Level	0 - 127	
Type 10: LIMITER			
prm1	Threshold	0 - 127	
prm2	Ratio	0 - 3	1.5:1,2.0:1,4.0:1,100:1
prm3	Release	0 - 127	
prm4	Post Gain	0 - 3	0,+6,+12,+18
prm5	Output Pan	0 - 127	L64 - R63
prm6	Output Level	0 - 127	
Type 11: SLICER			
prm1	Timing Pattern	0 - 33	(pattern)
prm2	Rate	0 - 2	1/4,1/2,1/1
prm3	Accent Pattern	0 - 15	(pattern)
prm4	Accent Level	0 - 127	
prm5	Attack	0 - 9	1 - 10
prm6	Output Level	0 - 127	
Type 12: TREMOLO			
prm1	LFO Type	0 - 5	TRI,TRP,SIN,SAW1,SAW2,SQR
prm2	Rate	0 - 117	0.05 - 10.00,*2
prm3	Depth	0 - 127	
prm4	Low Gain	0 - 30	-15 - +15
prm5	High Gain	0 - 30	-15 - +15
prm6	Output Level	0 - 127	
Type 13: PHASER			
prm1	Manual	0 - 125	100 - 8000
prm2	Rate	0 - 117	0.05 - 10.00,*2
prm3	Depth	0 - 127	
prm4	Resonance	0 - 127	
prm5	Mix	0 - 127	
prm6	Output Pan	0 - 127	L64 - R63
prm7	Output Level	0 - 127	
Type 14: CHORUS			
prm1	Pre Delay	0 - 125	0.0 - 100
prm2	Rate	0 - 117	0.05 - 10.00,*2
prm3	Depth	0 - 127	
prm4	Phase	0 - 90	0 - 180
prm5	Filter Type	0 - 2	OFF,LPF,HPF
prm6	Cutoff	0 - 16	*1
prm7	Balance	0 - 100	D100:0E - D0:100E
prm8	Output Level	0 - 127	
Type 15: SPACE-D			
prm1	Pre Delay	0 - 125	0.0 - 100
prm2	Rate	0 - 117	0.05 - 10.00,*2
prm3	Depth	0 - 127	
prm4	Phase	0 - 90	0 - 180
prm5	Low Gain	0 - 30	-15 - +15
prm6	High Gain	0 - 30	-15 - +15
prm7	Balance	0 - 100	D100:0E - D0:100E
prm8	Output Level	0 - 127	
Type 16: TETRA-CHORUS			
prm1	Pre Delay	0 - 125	0.0 - 100
prm2	Rate	0 - 117	0.05 - 10.00,*2
prm3	Depth	0 - 127	
prm4	Pre Dly Devi	0 - 20	0 - 20
prm5	Depth Devi	0 - 40	-20 - +20
prm6	Pan Devi	0 - 20	0 - 20
prm7	Balance	0 - 100	D100:0E - D0:100E
prm8	Output Level	0 - 127	
Type 17: FLANGER			
prm1	Pre Delay	0 - 125	0.0 - 100
prm2	Rate	0 - 117	0.05 - 10.00,(rate)
prm3	Depth	0 - 127	
prm4	Feedback	0 - 98	0 - +98
prm5	Phase	0 - 90	0 - 180
prm6	Filter Type	0 - 2	OFF,LPF,HPF
prm7	Cutoff	0 - 16	*1
prm8	Balance	0 - 100	D100:0E - D0:100E
prm9	Output Level	0 - 127	
Type 18: ST-FLANGER			
prm1	Pre Delay	0 - 125	0.0 - 100
prm2	Rate	0 - 117	0.05 - 10.00,*2
prm3	Depth	0 - 127	
prm4	Feedback	0 - 98	0 - +98
prm5	Phase	0 - 90	0 - 180
prm6	Step Rate	0 - 125	0.05 - 10.00,*2
prm7	Balance	0 - 100	D100:0E - D0:100E
prm8	Output Level	0 - 127	
Type 19: SHORT-DELAY			
prm1	Time L	0 - 103	0.1 - 190

```

prm2 Time R      0 - 103      0.1 - 190
prm3 HF Damp    0 - 17       *1,BYPASS
prm4 Feedback   0 - 98       0 - +98
prm5 Auto Pan   0 - 18       OFF,(rate)
prm6 Low Gain   0 - 30       -15 - +15
prm7 High Gain  0 - 30       -15 - +15
prm8 Balance    0 - 100      D100:0E - D0:100E
prm9 Output Level 0 - 127

```

```

Type 20: AUTO-PAN
prm1 LFO Type    0 - 5       TRI,TRP,SIN,SAW1,SAW2,SQR
prm2 Rate        0 - 117      0.05 - 10.00,*2
prm3 Bass Sense  0 - 2       OFF,MODE1,MODE2
prm4 Depth       0 - 127
prm5 Low Gain    0 - 30       -15 - +15
prm6 High Gain   0 - 30       -15 - +15
prm7 Output Level 0 - 127

```

```

Type 21: FB-P-SHIFT
prm1 Coarse      0 - 36       -24 - +12
prm2 Fine        0 - 100      -100 - +100
prm3 Output Pan  0 - 127
prm4 Pre Delay   0 - 125      0.0 - 100
prm5 Mode        0 - 4        1 - 5
prm6 Feedback    0 - 98       0 - +98
prm7 Low Gain    0 - 30       -15 - +15
prm8 High Gain   0 - 30       -15 - +15
prm9 Balance     0 - 100      D100:0E - D0:100E
prm10 Output Level 0 - 127

```

```

Type 22: REVERB
prm1 Rev Type    0 - 5       ROOM1,ROOM2,STAGE1,STAGE2,HALL1,HALL2
prm2 Time        0 - 127
prm3 HF Damp     0 - 17       *1,BYPASS
prm4 Balance     0 - 100      D100:0E - D0:100E
prm5 Output Level 0 - 127

```

```

Type 23: GATE-REVERB
prm1 Gate Type   0 - 3       NORMAL,REVERSE,SWEEP1,SWEEP2
prm2 Gate Time   0 - 65      5 - 330
prm3 Balance     0 - 100      D100:0E - D0:100E
prm4 Output Level 0 - 127

```

\*1: 200, 250, 315, 400, 500, 630, 800, 1000, 1250, 1600, 2000, 2500, 3150, 4000, 5000, 6300, 8000  
\*2: 1/16, 1/12, 3/32, 1/8, 1/6, 3/16, 1/4, 1/3, 3/8, 1/2, 2/3, 3/4, 1/1, 2MES, 3MES, 4MES, 8MES, 16MES

### ■ 1-2-2.Part Info Part

Offset Address	Size	Description	Data (Value)
00 00	0000 000a	Receive Switch	0 - 1 (OFF,ON)
00 01	0aaa aaaa	Reserved	--
00 02	0000 00aa	Patch Group Type	0 - 3 *1
00 03	0aaa aaaa	Patch Group ID	0 - 127
# 00 04	0000 aaaa	Patch Number	0 - 254
	0000 bbbb		(001 - 255)
00 06	0aaa aaaa	Part Level	0 - 127
00 07	0aaa aaaa	Part Pan	0 - 127 (L64 - 63R)
00 08	0aaa aaaa	Part Key Shift	0 - 96 (-48 - +48)
00 09	0aaa aaaa	Part Fine Tune	0 - 100 (-50 - +50)
00 0A	0000 0aaa	M-FX Switch	0 - 4 *2
00 0B	0aaa aaaa	Reserved	--
00 0C	0aaa aaaa	Delay Send Level	0 - 127
00 0D	0aaa aaaa	Reverb Send Level	0 - 127
00 0E-00 19	0aaa aaaa	Reserved	--
Total size	00 00 00 1A		

\*1: PRESET, <Reserved, Reserved>, USER&CARD  
\*2: OFF, ON, <Reserved, Reserved>, RHY

### ■ 1-3.Patch

Offset Address	Description	Data (Value)
00 00	Patch Common	1-3-1
10 06	Patch Tone 1	1-3-2
12 06	Patch Tone 2	
14 00	Patch Tone 3	
16 00	Patch Tone 4	

### ■ 1-3-1.Patch Common

Offset Address	Size	Description	Data (Value)
00 00	0aaa aaaa	Patch Name 1	32 - 125
00 01	0aaa aaaa	Patch Name 2	32 - 125
00 02	0aaa aaaa	Patch Name 3	32 - 125
00 03	0aaa aaaa	Patch Name 4	32 - 125
00 04	0aaa aaaa	Patch Name 5	32 - 125
00 05	0aaa aaaa	Patch Name 6	32 - 125
00 06	0aaa aaaa	Patch Name 7	32 - 125
00 07	0aaa aaaa	Patch Name 8	32 - 125
00 08	0aaa aaaa	Patch Name 9	32 - 125
00 09	0aaa aaaa	Patch Name 10	32 - 125
00 0A	0aaa aaaa	Patch Name 11	32 - 125
00 0B	0aaa aaaa	Patch Name 12	32 - 125
00 0C-00 30	0aaa aaaa	Reserved	--
00 31	0000 aaaa	Bend Range Up	0 - 12

00 32	00aa aaaa	Bend Range Down	0 - 48 (0 - -48)
00 33	0000 000a	Solo Switch	0 - 1 (OFF,ON)
00 34	0000 000a	Solo Legato Switch	0 - 1 (OFF,ON)
00 35	0000 000a	Portamento Switch	0 - 1 (OFF,ON)
00 36	0000 000a	Portamento Mode	0 - 1 *1
00 37	0000 000a	Portamento Type	0 - 1 (RATE,TIME)
00 38	0000 000a	Portamento Start	0 - 1 (PITCH,NOTE)
00 39	0aaa aaaa	Portamento Time	0 - 127
00 3A-00 3F	0aaa aaaa	Reserved	--
00 40	0000 000a	Velocity Range Switch	0 - 1 (OFF,ON)
00 41	0aaa aaaa	Reserved	--
00 42	0000 00aa	Stretch Tune Depth	0 - 3 (OFF,1 - 3)
00 43	0000 000a	Voice Priority	0 - 1 *2
00 44	0000 aaaa	Structure Type 1&2	0 - 9 (1 - 10)
00 45	0000 00aa	Booster 1&2	0 - 3 *3
00 46	0000 aaaa	Structure Type 3&4	0 - 9 (1 - 10)
00 47	0000 00aa	Booster 3&4	0 - 3 *3
00 48-00 49	0aaa aaaa	Reserved	--
Total size	00 00 00 4A		

\*1: NORMAL, LEGATO

\*2: LAST, LOUDEST

\*3: 0, +6, +12, +18

### ■ 1-3-2.Patch Tone

Offset	Address	Size	Description	Data (Value)
00 00	0000 000a		Tone Switch	0 - 1 (OFF,ON)
00 01	0000 0000		Wave Group Type	0 - 3 *1
00 02	0000 00aa		Wave Group ID	0 - 254
# 00 03	0000 aaaa		Wave Number	0 - 254 (001 - 255)
	0000 bbbb			
00 05	0000 00aa		Wave Gain	0 - 3 *2
00 06	0000 000a		FXM Switch	0 - 1 (OFF,ON)
00 07	0000 00aa		FXM Color	0 - 3 (1 - 4)
00 08	0000 aaaa		FXM Depth	0 - 15 (1 - 16)
00 09-00 0A	0aaa aaaa		Reserved	--
00 0B	0aaa aaaa		Velocity Cross Fade	0 - 127
00 0C	0aaa aaaa		Velocity Range Lower	1 - 127 *3
00 0D	0aaa aaaa		Velocity Range Upper	1 - 127 *4
00 0E	0aaa aaaa		Keyboard Range Lower	0 - 127 *5
00 0F	0aaa aaaa		Keyboard Range Upper	0 - 127 *6
00 10-00 14	0aaa aaaa		Reserved	--
00 15	000a aaaa		Modulation Destination 1	0 - 15 *7
00 16	0aaa aaaa		Modulation Depth 1	0 - 126 (-63 - +63)
00 17	000a aaaa		Modulation Destination 2	0 - 15 *7
00 18	0aaa aaaa		Modulation Depth 2	0 - 126 (-63 - +63)
00 19	000a aaaa		Modulation Destination 3	0 - 15 *7
00 1A	0aaa aaaa		Modulation Depth 3	0 - 126 (-63 - +63)
00 1B	000a aaaa		Modulation Destination 4	0 - 15 *7
00 1C	0aaa aaaa		Modulation Depth 4	0 - 126 (-63 - +63)
00 1D	000a aaaa		Pitch Bend Destination 1	0 - 15 *7
00 1E	0aaa aaaa		Pitch Bend Depth 1	0 - 126 (-63 - +63)
00 1F	000a aaaa		Pitch Bend Destination 2	0 - 15 *7
00 20	0aaa aaaa		Pitch Bend Depth 2	0 - 126 (-63 - +63)
00 21	000a aaaa		Pitch Bend Destination 3	0 - 15 *7
00 22	0aaa aaaa		Pitch Bend Depth 3	0 - 126 (-63 - +63)
00 23	000a aaaa		Pitch Bend Destination 4	0 - 15 *7
00 24	0aaa aaaa		Pitch Bend Depth 4	0 - 126 (-63 - +63)
00 25	000a aaaa		Aftertouch Destination 1	0 - 15 *7
00 26	0aaa aaaa		Aftertouch Depth 1	0 - 126 (-63 - +63)
00 27	000a aaaa		Aftertouch Destination 2	0 - 15 *7
00 28	0aaa aaaa		Aftertouch Depth 2	0 - 126 (-63 - +63)
00 29	000a aaaa		Aftertouch Destination 3	0 - 15 *7
00 2A	0aaa aaaa		Aftertouch Depth 3	0 - 126 (-63 - +63)
00 2B	000a aaaa		Aftertouch Destination 4	0 - 15 *7
00 2C	0aaa aaaa		Aftertouch Depth 4	0 - 126 (-63 - +63)
00 2D	0000 0aaa		LF01 Waveform	0 - 7 *8
00 2E	0000 000a		LF01 Key Sync	0 - 1 (OFF,ON)
00 2F	0aaa aaaa		LF01 Rate	0 - 127
00 30	0000 0aaa		LF01 Offset	0 - 4 *9
00 31	0aaa aaaa		LF01 Delay Time	0 - 127
00 32	0000 00aa		LF01 Fade Mode	0 - 3 *10
00 33	0aaa aaaa		LF01 Fade Time	0 - 127
00 34	0000 000a		LF01 Tempo Sync	0 - 1 (OFF,ON)
00 35	0000 0aaa		LF02 Waveform	0 - 7 *8
00 36	0000 000a		LF02 Key Sync	0 - 1 (OFF,ON)
00 37	0aaa aaaa		LF02 Rate	0 - 127
00 38	0000 0aaa		LF02 Offset	0 - 4 *9
00 39	0aaa aaaa		LF02 Delay Time	0 - 127
00 3A	0000 00aa		LF02 Fade Mode	0 - 3 *10
00 3B	0aaa aaaa		LF02 Fade Time	0 - 127
00 3C	0000 000a		LF02 Tempo Sync	0 - 1 (OFF,ON)
00 3D	0aaa aaaa		Coarse Tune	0 - 96 (-48 - +48)
00 3E	0aaa aaaa		Fine Tune	0 - 100 (-50 - +50)
00 3F	000a aaaa		Random Pitch Depth	0 - 30 *11
00 40	0000 aaaa		Pitch Keyfollow	0 - 15 *12
00 41	000a aaaa		Pitch Envelope Depth	0 - 24 (-12 - +12)
00 42	0aaa aaaa		Pitch Envelope Velocity Sens	0 - 125 *13
00 43	0000 aaaa		Pitch Envelope Velocity Time1	0 - 14 *14
00 44	0000 aaaa		Pitch Envelope Velocity Time4	0 - 14 *14
00 45	0000 aaaa		Pitch Envelope Time Keyfollow	0 - 14 *14
00 46	0aaa aaaa		Pitch Envelope Time 1	0 - 127
00 47	0aaa aaaa		Pitch Envelope Time 2	0 - 127
00 48	0aaa aaaa		Pitch Envelope Time 3	0 - 127
00 49	0aaa aaaa		Pitch Envelope Time 4	0 - 127
00 4A	0aaa aaaa		Pitch Envelope Level 1	0 - 126 (-63 - +63)
00 4B	0aaa aaaa		Pitch Envelope Level 2	0 - 126 (-63 - +63)
00 4C	0aaa aaaa		Pitch Envelope Level 3	0 - 126 (-63 - +63)
00 4D	0aaa aaaa		Pitch Envelope Level 4	0 - 126 (-63 - +63)

00 4E	0aaa aaaa	Pitch LFO1 Depth	0 - 126 (-63 - +63)
00 4F	0aaa aaaa	Pitch LFO2 Depth	0 - 126 (-63 - +63)
00 50	0000 0aaa	Filter Type	0 - 4 *15
00 51	0aaa aaaa	Cutoff Frequency	0 - 127
00 52	0000 aaaa	Cutoff Keyfollow	0 - 15 *12
00 53	0aaa aaaa	Resonance	0 - 127
00 54	0aaa aaaa	Resonance Velocity Sens	0 - 125 *13
00 55	0aaa aaaa	Filter Envelope Depth	0 - 126 (-63 - +63)
00 56	0000 0aaa	Filter Envelope Velocity Curve	0 - 6 (1 - 7)
00 57	0aaa aaaa	Filter Envelope Velocity Sens	0 - 125 *13
00 58	0000 aaaa	Filter Envelope Velocity Time1	0 - 14 *14
00 59	0000 aaaa	Filter Envelope Velocity Time4	0 - 14 *14
00 5A	0000 aaaa	Filter Envelope Time Keyfollow	0 - 14 *14
00 5B	0aaa aaaa	Filter Envelope Time 1	0 - 127
00 5C	0aaa aaaa	Filter Envelope Time 2	0 - 127
00 5D	0aaa aaaa	Filter Envelope Time 3	0 - 127
00 5E	0aaa aaaa	Filter Envelope Time 4	0 - 127
00 5F	0aaa aaaa	Filter Envelope Level 1	0 - 127
00 60	0aaa aaaa	Filter Envelope Level 2	0 - 127
00 61	0aaa aaaa	Filter Envelope Level 3	0 - 127
00 62	0aaa aaaa	Filter Envelope Level 4	0 - 127
00 63	0aaa aaaa	Filter LFO1 Depth	0 - 126 (-63 - +63)
00 64	0aaa aaaa	Filter LFO2 Depth	0 - 126 (-63 - +63)
00 65	0aaa aaaa	Tone Level	0 - 127
00 66	0000 00aa	Bias Direction	0 - 3 *16
00 67	0aaa aaaa	Bias Point	0 - 127 (C-1 - G9)
00 68	0000 aaaa	Bias Level	0 - 14 *14
00 69	0000 0aaa	Amp Envelope Velocity Curve	0 - 6 (1 - 7)
00 6A	0aaa aaaa	Amp Envelope Velocity Sens	0 - 125 *13
00 6B	0000 aaaa	Amp Envelope Velocity Time1	0 - 14 *14
00 6C	0000 aaaa	Amp Envelope Velocity Time4	0 - 14 *14
00 6D	0000 aaaa	Amp Envelope Time Keyfollow	0 - 14 *14
00 6E	0aaa aaaa	Amp Envelope Time 1	0 - 127
00 6F	0aaa aaaa	Amp Envelope Time 2	0 - 127
00 70	0aaa aaaa	Amp Envelope Time 3	0 - 127
00 71	0aaa aaaa	Amp Envelope Time 4	0 - 127
00 72	0aaa aaaa	Amp Envelope Level 1	0 - 127
00 73	0aaa aaaa	Amp Envelope Level 2	0 - 127
00 74	0aaa aaaa	Amp Envelope Level 3	0 - 127
00 75	0aaa aaaa	Amp LFO1 Depth	0 - 126 (-63 - +63)
00 76	0aaa aaaa	Amp LFO2 Depth	0 - 126 (-63 - +63)
00 77	0aaa aaaa	Tone Pan	0 - 127 (L64 - 63R)
00 78	0000 aaaa	Pan Keyfollow	0 - 14 *14
00 79	00aa aaaa	Random Pan Switch	0,63 (OFF, ON)
00 7A	0aaa aaaa	Alternate Pan Depth	1 - 127 (L63 - 63R)
00 7B	0aaa aaaa	Pan LFO1 Depth	0 - 126 (L63 - 63R)
00 7C	0aaa aaaa	Pan LFO2 Depth	0 - 126 (L63 - 63R)
00 7D-01 00	0aaa aaaa	Reserved	--
Total size	00 00 01 01		

\*1: <Reserved>, INTA, INTB, INTC

\*2: -6, 0, +6, +12

\*3: 1 - Upper

\*4: Lower - 127

\*5: C-1 - Upper

\*6: Lower - G9

\*7: OFF, PCH, CUT, RES, LEV, PAN, L1P, LP2, L1F, L2F, L1A, L2A, L1p, L2p, L1R, L2R

\*8: TRI, SIN, SAW, SQR, TRP, S&H, RND, CHS

\*9: -100, -50, 0, +50, +100

\*10: ON-IN, ON-OUT, OFF-IN, OFF-OUT

\*11: 0, 1, 2, 3, 4, 5, 6, 7, 8, 9, 10, 20, 30, 40, 50, 60, 70, 80, 90, 100, 200, 300, 400, 500, 600, 700, 800, 900, 1000, 1100, 1200

\*12: -100, -70, -50, -30, -10, 0, +10, +20, +30, +40, +50, +70, +100, +120, +150, +200

\*13: -100 - +150

\*14: -100, -70, -50, -40, -30, -20, -10, 0, +10, +20, +30, +40, +50, +70, +100

\*15: OFF, LPE, BPF, HPP, PKG

\*16: LOWER, UPPER, LOW&UP, ALL

## ■ 1-4.Rhythm Setup

Offset	Address	Description	
00 00		Rhythm Common	1-4-1
23 00		Rhythm Note for Key# 35	1-4-2
24 00		Rhythm Note for Key# 36	
62 00		Rhythm Note for Key# 98	

## ■ 1-4-1.Rhythm Common

Offset	Address	Size	Description	Data (Value)
00 00	0aaa aaaa		Rhythm Name 1	32 - 125
00 01	0aaa aaaa		Rhythm Name 2	32 - 125
00 02	0aaa aaaa		Rhythm Name 3	32 - 125
00 03	0aaa aaaa		Rhythm Name 4	32 - 125
00 04	0aaa aaaa		Rhythm Name 5	32 - 125
00 05	0aaa aaaa		Rhythm Name 6	32 - 125
00 06	0aaa aaaa		Rhythm Name 7	32 - 125
00 07	0aaa aaaa		Rhythm Name 8	32 - 125
00 08	0aaa aaaa		Rhythm Name 9	32 - 125
00 09	0aaa aaaa		Rhythm Name 10	32 - 125
00 0A	0aaa aaaa		Rhythm Name 11	32 - 125
00 0B	0aaa aaaa		Rhythm Name 12	32 - 125
Total size	00 00 00 0C			

## ■ 1-4-2.Rhythm Note

Offset Address	Size	Description	Data (Value)
00 00	0000 000a	Tone Switch	0 - 1 (OFF,ON)
00 01	0000 0000	Wave Group Type	0
00 02	0000 00aa	Wave Group ID	0 - 3 *1
00 03	0000 aaaa	Wave Number	0 - 254 (001 - 255)
00 05	0000 00aa	Wave Gain	0 - 3 *2
00 06	0000 aaaa	Bend Range	0 - 12
00 07	000a aaaa	Mute Group	0 - 31 (OFF,1 - 31)
00 08	0000 000a	Envelope Mode	0 - 1 *3
00 09-00 0B	0aaa aaaa	Reserved	--
00 0C	0aaa aaaa	Coarse Tune	0 - 120 (-60 - +60)
00 0D	0aaa aaaa	Fine Tune	0 - 100 (-50 - +50)
00 0E	000a aaaa	Random Pitch Depth	0 - 30 *4
00 0F	000a aaaa	Pitch Envelope Depth	0 - 24 (-12 - +12)
00 10	0aaa aaaa	Pitch Envelope Velocity Sens	0 - 125 *5
00 11	0000 aaaa	Pitch Envelope Velocity Time	0 - 14 *6
00 12	0aaa aaaa	Pitch Envelope Time 1	0 - 127
00 13	0aaa aaaa	Pitch Envelope Time 2	0 - 127
00 14	0aaa aaaa	Pitch Envelope Time 3	0 - 127
00 15	0aaa aaaa	Pitch Envelope Time 4	0 - 127
00 16	0aaa aaaa	Pitch Envelope Level 1	0 - 126 (-63 - +63)
00 17	0aaa aaaa	Pitch Envelope Level 2	0 - 126 (-63 - +63)
00 18	0aaa aaaa	Pitch Envelope Level 3	0 - 126 (-63 - +63)
00 19	0aaa aaaa	Pitch Envelope Level 4	0 - 126 (-63 - +63)
00 1A	0000 0aaa	Filter Type	0 - 4 *7
00 1B	0aaa aaaa	Cutoff Frequency	0 - 127
00 1C	0aaa aaaa	Resonance	0 - 127
00 1D	0aaa aaaa	Resonance Velocity Sens	0 - 125 *5
00 1E	0aaa aaaa	Filter Envelope Depth	0 - 126 (-63 - +63)
00 1F	0aaa aaaa	Filter Envelope Velocity Sens	0 - 125 *5
00 20	0000 aaaa	Filter Envelope Velocity Time	0 - 14 *6
00 21	0aaa aaaa	Filter Envelope Time 1	0 - 127
00 22	0aaa aaaa	Filter Envelope Time 2	0 - 127
00 23	0aaa aaaa	Filter Envelope Time 3	0 - 127
00 24	0aaa aaaa	Filter Envelope Time 4	0 - 127
00 25	0aaa aaaa	Filter Envelope Level 1	0 - 127
00 26	0aaa aaaa	Filter Envelope Level 2	0 - 127
00 27	0aaa aaaa	Filter Envelope Level 3	0 - 127
00 28	0aaa aaaa	Filter Envelope Level 4	0 - 127
00 29	0aaa aaaa	Tone Level	0 - 127 *5
00 2A	0aaa aaaa	Amp Envelope Velocity Sens	0 - 125 *5
00 2B	0000 aaaa	Amp Envelope Velocity Time	0 - 14 *6
00 2C	0aaa aaaa	Amp Envelope Time 1	0 - 127
00 2D	0aaa aaaa	Amp Envelope Time 2	0 - 127
00 2E	0aaa aaaa	Amp Envelope Time 3	0 - 127
00 2F	0aaa aaaa	Amp Envelope Time 4	0 - 127
00 30	0aaa aaaa	Amp Envelope Level 1	0 - 127
00 31	0aaa aaaa	Amp Envelope Level 2	0 - 127
00 32	0aaa aaaa	Amp Envelope Level 3	0 - 127
00 33	0aaa aaaa	Tone Pan	0 - 127 (L64 - 63R)
00 34	00aa aaaa	Random Pan Switch	0,63 (OFF,ON)
00 35	0aaa aaaa	Alternate Pan Depth	1 - 127 (L63 - 63R)
00 36	0000 00aa	M-FX Switch	0 - 3 *8
00 37	0aaa aaaa	Reserved	--
00 38	0aaa aaaa	Delay Send Level	0 - 127
00 39	0aaa aaaa	Reverb Send Level	0 - 127
Total size	00 00 00 3A		

\*1: <Reserved>, INTA, INTB, INTC

\*2: -6, 0, +6, +12

\*3: NO-SUS, SUSTAIN

\*4: 0, 1, 2, 3, 4, 5, 6, 7, 8, 9, 10, 20, 30, 40, 50, 60, 70, 80, 90, 100, 200, 300, 400, 500, 600, 700, 800, 900, 1000, 1100, 1200

\*5: -100 - +150

\*6: -100, -70, -50, -40, -30, -20, -10, 0, +10, +20, +30, +40, +50, +70, +100

\*7: OFF, LPF, BPF, HPF, PKG

\*8: OFF, ON, <Reserved, Reserved>

## ■ 1-5. Sequencer Temporary Pattern Setup

Offset Address	Size	Description	Data (Value)
00 00	0aaa aaaa	Temporary Pattern Setup	0 - 127
:	:	:	:
Total size	0F 7F 7F 7F		

## ■ 1-6. Sequencer Temporary Pattern Body

Offset Address	Size	Description	Data (Value)
00 00	0aaa aaaa	Temporary Pattern Body	0 - 127
:	:	:	:
Total size	7F 7F 7F 7F		

## ■ 2. GS (Model ID=42H)

Start address	Description	
40 11 00	Scale Tune Part1	2-1
40 12 00	: Part2	
40 13 00	: Part3	
40 14 00	: Part4	
40 15 00	: Part5	
40 16 00	: Part6	
40 17 00	: Part7	

### ■ 2-1. Scale Tune

Offset Address	Size	Description	Data (Value)
40	0aaa aaaa	Scale Tune for C	0 - 127 (-64 - +63)
41	0aaa aaaa	Scale Tune for C#	0 - 127 (-64 - +63)
42	0aaa aaaa	Scale Tune for D	0 - 127 (-64 - +63)
43	0aaa aaaa	Scale Tune for D#	0 - 127 (-64 - +63)
44	0aaa aaaa	Scale Tune for E	0 - 127 (-64 - +63)
45	0aaa aaaa	Scale Tune for F	0 - 127 (-64 - +63)
46	0aaa aaaa	Scale Tune for F#	0 - 127 (-64 - +63)
47	0aaa aaaa	Scale Tune for G	0 - 127 (-64 - +63)
48	0aaa aaaa	Scale Tune for G#	0 - 127 (-64 - +63)
49	0aaa aaaa	Scale Tune for A	0 - 127 (-64 - +63)
4A	0aaa aaaa	Scale Tune for A#	0 - 127 (-64 - +63)
4B	0aaa aaaa	Scale Tune for B	0 - 127 (-64 - +63)
Total size		00 00 0C	

Note) In order for GS exclusive messages to be received correctly by the JX-305, the starting address of the message must be the starting address of each part (the address of Scale Tune C; i.e., offset 40).

## ■ 3. Quick SysEx (Model ID=3AH)

Start address	Description	
30 00	Quick SysEx Part1	3-1
31 00	: Part2	
:	:	
36 00	: Part7	
39 00	: PartR	3-2
70 00	: Sequencer	3-3

### ■ 3-1. Quick SysEx Part

Offset Address	Size DataL	DataE	Description	Data (Value L)
0F	0000 aaaa	0000 0000	LF01 Wave Form	0 - 7 *1
14	0aaa aaaa	0000 0000	LF01 Fade Time	0 - 127
15	0aaa aaaa	0000 0000	Coarse Tune	16 - 112 (-48 - +48)
19	0aaa aaaa	0000 0000	Pitch Env Depth	52 - 76 (-12 - +12)
1A	0aaa aaaa	0000 0000	Pitch Env Attack	0 - 127
1B	0aaa aaaa	0000 0000	Pitch Env Decay	0 - 127
1C	0aaa aaaa	0000 0000	Filter Env Sustain	1 - 127 (-63 - +63)
1D	0aaa aaaa	0000 0000	Filter Env Release	0 - 127
1F	0aaa aaaa	0000 0000	Amp Env Sustain	0 - 127
22	0000 0aaa	0000 0000	Filter Type	0 - 4 *2
23	0aaa aaaa	0000 0000	Tone Pan	0 - 127 (-64 - +63)
24	0aaa aaaa	0000 0000	Tone Level	0 - 127
25	0aaa aaaa	0000 0000	Random Pan Switch	0,63 (OFF,ON)
27	0aaa aaaa	0000 0000	Pitch Env Sustain	1 - 127 (-63 - +63)
28	0aaa aaaa	0000 0000	Pitch Env Release	0 - 127
55	0aaa aaaa	0000 0000	Part Key Shift	16 - 112 (-48 - +48)
56	0000 00aa	0000 0000	Part M-FX Switch	0 - 3 *3

\*1: TRI, SIN, SAW, SQR, TRP, S&H, RND, CHS

\*2: OFF, LPF, BPF, HPF, PKG

\*3: OFF, ON, <Reserved, Reserved>

Note) In order for quick exclusive messages to be received correctly by the JX-305, the starting address of the message must be the starting address of each part.

### ■ 3-2. Quick SysEx Rhythm

Offset Address	Size DataL	DataE *1	Description	Data (Value L)
15	0aaa aaaa	0000 aaaa	Coarse Tune	0 - 120 (-60 - +60)
19	0aaa aaaa	0000 aaaa	Pitch Env Depth	52 - 76 (-12 - +12)
1A	0aaa aaaa	0000 aaaa	Pitch Env Attack	0 - 127
1B	0aaa aaaa	0000 aaaa	Pitch Env Decay	0 - 127
1C	0aaa aaaa	0000 aaaa	Filter Env Sustain	0 - 127
1D	0aaa aaaa	0000 aaaa	Filter Env Release	0 - 127
1F	0aaa aaaa	0000 aaaa	Amp Env Sustain	0 - 127
22	0000 0aaa	0000 aaaa	Filter Type	0 - 4 *2
23	0aaa aaaa	0000 aaaa	Tone Pan	0 - 126 (-63 - +63)
24	0aaa aaaa	0000 aaaa	Tone Level	0 - 127
25	0aaa aaaa	0000 aaaa	Random Pan Switch	0,63 (OFF,ON)
27	0aaa aaaa	0000 aaaa	Pitch Env Sustain	0 - 127
28	0aaa aaaa	0000 aaaa	Pitch Env Release	0 - 127
47	0aaa aaaa	0000 aaaa	Resonance	0 - 127
48	0aaa aaaa	0000 aaaa	Amp Env Release Time	0 - 127
49	0aaa aaaa	0000 aaaa	Amp Env Attack Time	0 - 127
4A	0aaa aaaa	0000 aaaa	Cutoff Frequency	0 - 127
4B	0aaa aaaa	0000 aaaa	Amp Env Decay	0 - 127
4D	0aaa aaaa	0000 aaaa	Fine Tune	14 - 114 (-50 - +50)

51	0aaa aaaa 0000 aaaa	Filter Env Depth	1 - 127 (-63 - +63)
52	0aaa aaaa 0000 aaaa	Filter Env Attack	0 - 127
53	0aaa aaaa 0000 aaaa	Filter Env Decay	0 - 127
55	0aaa aaaa 0000 0000	Part Key Shift	16 - 112 (-48 - +48)
56	0000 00aa 0000 0000	Part M-FX Switch	0 - 4 *3

\*1: Rhythm Tone Select : BD, SD, HH, CLP, CYM, TOM/PEC, HIT, OTHERS = 0-7, ALL = 9

\*2: OFF, LPF, BPF, HPF, PKG

\*3: OFF, ON, <Reserved, Reserved>, RHY

Note) In order for quick exclusive messages to be received correctly by the JX-305, the starting address of the message must be the starting address of each part.

### ■ 3-3. Quick SysEx Sequencer

Offset Address	Size DataL DataE	Description	Data(Value L/E)
01	0000 aaaa 0000 000a	Part Mute	0-6,9 / 0,1
02	0000 aaaa 0000 000a	Drum Mute	0-7*1 / 0,1
03	0aaa aaaa 0aaa aaaa	Tempo	7-93 / 0-127

\*1: BD,SD,HH,CLP,CYM,TOM/PEC,HIT,OTHERS

### ■ Address block map

The following is an outline of the address map for Exclusive messages

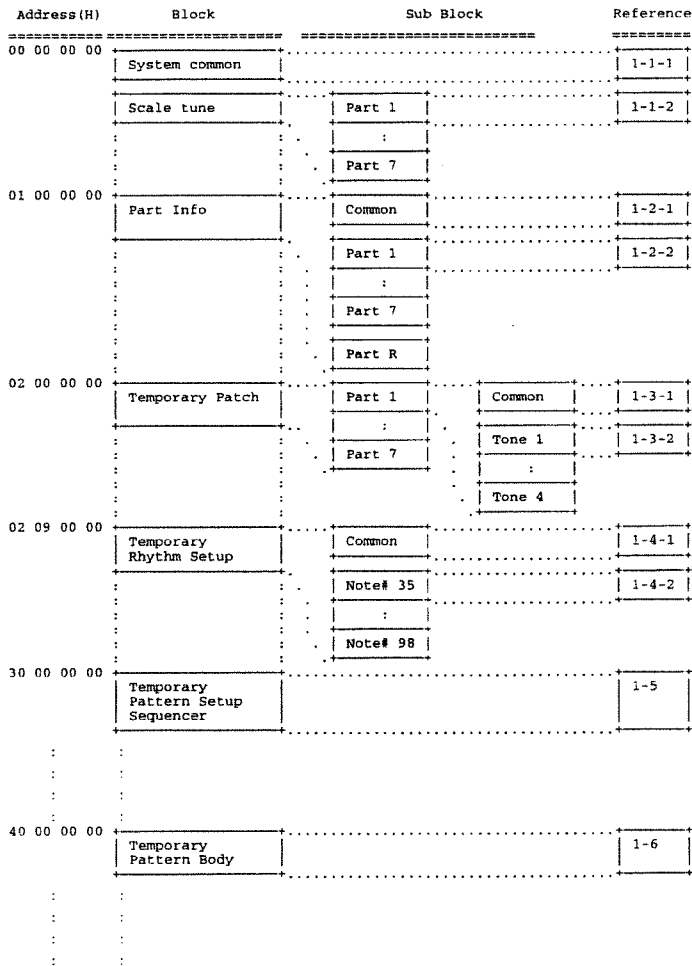

## 6. Supplementary material

### ■ Decimal/Hexadecimal table

MIDI uses 7-bit hexadecimal values to indicate data values and the address and size of exclusive messages. The following table shows the correspondence between decimal and hexadecimal numbers.

\* Hexadecimal values are indicated by a following 'H.'

D	H	D	H	D	H	D	H
0	00H	32	20H	64	40H	96	60H
1	01H	33	21H	65	41H	97	61H
2	02H	34	22H	66	42H	98	62H
3	03H	35	23H	67	43H	99	63H
4	04H	36	24H	68	44H	100	64H
5	05H	37	25H	69	45H	101	65H
6	06H	38	26H	70	46H	102	66H
7	07H	39	27H	71	47H	103	67H
8	08H	40	28H	72	48H	104	68H
9	09H	41	29H	73	49H	105	69H
10	0AH	42	2AH	74	4AH	106	6AH
11	0BH	43	2BH	75	4BH	107	6BH
12	0CH	44	2CH	76	4CH	108	6CH
13	0DH	45	2DH	77	4DH	109	6DH
14	0EH	46	2EH	78	4EH	110	6EH
15	0FH	47	2FH	79	4FH	111	6FH
16	10H	48	30H	80	50H	112	70H
17	11H	49	31H	81	51H	113	71H
18	12H	50	32H	82	52H	114	72H
19	13H	51	33H	83	53H	115	73H
20	14H	52	34H	84	54H	116	74H
21	15H	53	35H	85	55H	117	75H
22	16H	54	36H	86	56H	118	76H
23	17H	55	37H	87	57H	119	77H
24	18H	56	38H	88	58H	120	78H
25	19H	57	39H	89	59H	121	79H
26	1AH	58	3AH	90	5AH	122	7AH
27	1BH	59	3BH	91	5BH	123	7BH
28	1CH	60	3CH	92	5CH	124	7CH
29	1DH	61	3DH	93	5DH	125	7DH
30	1EH	62	3EH	94	5EH	126	7EH
31	1FH	63	3FH	95	5FH	127	7FH

D: decimal

H: hexadecimal

- Decimal expressions such as used for MIDI channel, Bank Select, and Program Change will be the value 1 greater than the decimal value given in the above table.
- Since each MIDI byte carries 7 significant data bits, each byte can express a maximum of 128 different values. Data for which higher resolution is required must be transmitted using two or more bytes. For example a value indicated as a two-byte value of aa bbH would have a value of  $aa \times 128 + bb$ .
- For a signed number (+/-), 00H = -64, 40H = +/-0, and 7FH = +63. I.e., the decimal equivalent will be 64 less than the decimal value given in the above table. For a two-byte signed number, 00 00H = -8192, 40 00H = +/-0, and 7F 7FH = +8191. For example the decimal expression of aa bbH would be  $aa \times 128 + bb - 64 \times 128$ .
- Hexadecimal notation in two 4-bit units is used for data indicated as "nibbled". The nibbled two-byte value of 0a 0b H would be  $a \times 16 + b$ .

#### <Example 1> What is the decimal equivalent of 5AH?

From the above table, 5AH = 90.

#### <Example 2> What is the decimal equivalent of the 7-bit hexadecimal values 12 34H?

From the above table, 12H = 18 and 34H = 52

Thus,  $18 \times 128 + 52 = 2356$

#### <Example 3> What is the decimal equivalent of the nibbled expression 0A 03 09 0DH?

From the above table, 0AH = 10, 03H = 3, 09H = 9, 0DH = 13

Thus, the result is  $(10 \times 16 + 3) \times 16 + 9 \times 16 + 13 = 41885$

#### <Example 4> What is the nibbled equivalent of the decimal number 1258?

```
16 ) 1258
16 ) 78 ...10
16 ) 4 ...14
    0 ... 4
```

From the above table, 0=00H, 4=04H, 14=0EH, 10=0AH

Thus the result is 00 04 0E 0AH

### ■ ASCII code table

D	H	Char	D	H	Char	D	H	Char
32	20H	SP	64	40H	@	96	60H	.
33	21H	!	65	41H	A	97	61H	a
34	22H	"	66	42H	B	98	62H	b
35	23H	#	67	43H	C	99	63H	c
36	24H	\$	68	44H	D	100	64H	d
37	25H	%	69	45H	E	101	65H	e
38	26H	&	70	46H	F	102	66H	f
39	27H	'	71	47H	G	103	67H	g
40	28H	(	72	48H	H	104	68H	h
41	29H	)	73	49H	I	105	69H	i
42	2AH	*	74	4AH	J	106	6AH	j
43	2BH	+	75	4BH	K	107	6BH	k
44	2CH	,	76	4CH	L	108	6CH	l
45	2DH	-	77	4DH	M	109	6DH	m
46	2EH	.	78	4EH	N	110	6EH	n
47	2FH	/	79	4FH	O	111	6FH	o
48	30H	0	80	50H	P	112	70H	p
49	31H	1	81	51H	Q	113	71H	q
50	32H	2	82	52H	R	114	72H	r
51	33H	3	83	53H	S	115	73H	s
52	34H	4	84	54H	T	116	74H	t
53	35H	5	85	55H	U	117	75H	u
54	36H	6	86	56H	V	118	76H	v
55	37H	7	87	57H	W	119	77H	w
56	38H	8	88	58H	X	120	78H	x
57	39H	9	89	59H	Y	121	79H	y
58	3AH	:	90	5AH	Z	122	7AH	z
59	3BH	;	91	5BH	[	123	7BH	[
60	3CH	<	92	5CH	\	124	7CH	\
61	3DH	=	93	5DH	]	125	7DH	]
62	3EH	>	94	5EH	^			
63	3FH	?	95	5FH	_			

D: decimal

H: hexadecimal

Note) SP indicates "space."

### ■ Examples of actual MIDI messages

#### <Example 1> 92 3E 5F

9n is the Note On status and 'n' is the MIDI channel number. Since 2H = 2, 3EH = 62, and 5FH = 95, this is a Note On message of MIDI CH = 3, note number 62 (note name D4) and velocity 95.

#### <Example 2> C9 49

CnH is the Program Change status and 'n' is the MIDI channel number. Since 9H = 9, and 49H = 73, this is a Program Change message of MIDI CH = 9, Program number 74.

#### <Example 3> EA 00 28

EnH is the Pitch Bend Change status and 'n' is the MIDI channel number. The 2nd byte (00H=0) is the LSB of the Pitch Bend value, and the 3rd byte (28H=40) is the MSB. However since the Pitch Bend is a signed number with 0 at 40 00H (=  $64 \times 128 + 0 = 8192$ ), the Pitch Bend value in this case is

$$28 \text{ 00H} - 40 \text{ 00H} = 40 \times 128 + 0 - (64 \times 128 + 0) = 5120 - 8192 = -3072$$

If we assume that the Pitch Bend Sensitivity is set to two semitones, the pitch will change only -200 cents for a Pitch Bend value of -8192 (00 00H). Thus, this message is specifying a Pitch Bend of  $-200 \times (-3072) + (-8192) = -75$  cents on MIDI CH = 11.

#### <Example 4> B3 64 00 65 00 06 0C 26 00 64 7F 65 7F

BnH is the Control Change status, and 'n' is the MIDI channel number. In Control Change messages, the 2nd byte is the controller number, and the 3rd byte is the parameter value. MIDI allows what is known as "running status," when if messages of the the same status follow each other, it is permitted to omit the second and following status bytes. In the message above, running status is being used, meaning that the message has the following content.

```
B3 64 00  MIDI CH = 4, RPN parameter number LSB: 00H
(B3) 65 00  MIDI CH = 4, RPN parameter number MSB: 00H
(B3) 06 0C  MIDI CH = 4, parameter value MSB: 0CH
(B3) 26 00  MIDI CH = 4, parameter value LSB: 00H
(B3) 64 7F  MIDI CH = 4, RPN parameter number LSB: 7FH
(B3) 65 7F  MIDI CH = 4, RPN parameter number MSB: 7FH
```

Thus, this message transmits a parameter value of 0C 00H to RPN parameter number 00 00H on MIDI CH = 4, and then sets the RPN parameter number to 7F 7FH.

The function assigned to RPN parameter number 00 00H is Pitch Bend Sensitivity, and the MSB of the parameter value indicates semitone steps. Since the MSB of this parameter value is 0CH = 12, the maximum width of pitch bend is being set to  $\pm 12$  semitones (1 octave).



Once the parameter number has been set for RPN or NRPN, all subsequent Data Entry messages on that channel will be effective. Thus, it is recommended that after you have made the change you want, you set the parameter number to 7F 7FH (an "unset" or "null" setting). The final (B3) 64 7F (B3) 65 7F is for this purpose.

It is not a good idea to store many events within the data of a song (e.g., a Standard MIDI File song) using running status as shown in <Example 4>. When the song is paused, fast-forwarded or rewound, the sequencer may not be able to transmit the proper status, causing the sound source to misinterpret the data. It is best to attach the proper status byte to all events.

It is also important to transmit RPN or NRPN parameter number settings and parameter values in the correct order. In some sequencers, data events recorded in the same clock (or a nearby clock) can sometimes be transmitted in an order other than the order in which they were recorded. It is best to record such events at an appropriate interval (1 tick at TPQN=96, or 5 ticks at TPQN=480).

\* TPQN : Ticks Per Quarter Note (i.e., the time resolution of the sequencer)

## ■ Examples of system exclusive messages and calculating the checksum

Roland exclusive messages (RQ1, DT1) are transmitted with a checksum at the end of the data (before F7) to check that the data was received correctly. The value of the checksum is determined by the address and data (or size) of the exclusive message.

### ● How to calculate the checksum

The checksum consists of a value whose lower 7 bits are 0 when the address, size and checksum itself are added.

The following formula shows how to calculate the checksum when the exclusive message to be transmitted has an address of aa bb cc ddH, and data or size of ee ffH.

$$\begin{aligned} aa + bb + cc + dd + ee + ff &= \text{total} \\ \text{total} + 128 &= \text{quotient} \dots \text{remainder} \\ 128 \cdot \text{remainder} &= \text{checksum} \end{aligned}$$

#### <Example 1> Setting the REVERB TYPE to HALL2 (DT1)

Referring to "3. Parameter address map," the starting address for Part Information is 01 00 00 00H, and offset address of Part Information Common is 00 00H, and the REVERB TYPE address is 00 28H. Therefore, the address will be

```

01 00 00 00H
  00 00H
+) 00 28H
01 00 00 28H

```

Since HALL2 is parameter value 05H,

```

F0 41 10 00H 0BH 12 01 00 00 28 05 ?? F7
(1) (2) (3) (4) (5) (6) address data checksum (7)

```

(1) Exclusive status (2) ID number (Roland) (3) device ID (17)  
(4), (5) model ID (JX-305) (6) command ID (DT1) (7) EOX

Next we calculate the checksum.

$$\begin{aligned} 01H + 00H + 00H + 28H + 05H &= 1 + 0 + 0 + 40 + 5 = 46(\text{sum}) \\ 46(\text{total}) + 128 &= 0(\text{quotient}) \dots 46(\text{remainder}) \\ \text{checksum} &= 128 - 46(\text{quotient}) = 82 = 52H \end{aligned}$$

This means that the message transmitted will be F0 41 10 00 0B 12 01 00 00 28 05 52 F7.

#### <Example 2> Obtaining part information data (RQ1)

Referring to "3. Parameter address map," the starting addresses for Part Information are assigned as follows.

```

01 00 00 00H Part Info Common
01 00 10 00H Part Info Part 1
01 00 11 00H Part Info Part 2

```

```

01 00 16 00H Part Info Part 7
01 00 19 00H Part Info Part R

```

Since the size of Part Information Part is 00 00 00 1AH, this size is added to the starting address of Part Information Part R, to obtain

```

01 00 19 00H
+) 00 00 00 1AH
01 00 19 1AH

```

Therefore, the size of the data to be obtained is

```

01 00 19 1AH
-) 01 00 00 00H
00 00 19 1AH

```

```

F0 41 10 00 0B 11 01 00 00 00 00 00 19 1A ?? F7
(1) (2) (3) (4) (5) (6) address data checksum (7)

```

(1) Exclusive status (2) ID number (Roland) (3) Device ID (17)  
(4), (5) Model ID (JX-305) (6) Command ID (RQ1) (7) EOX

When the checksum is calculated in the same way as in <Example 2>, we have the following message to be transmitted: F0 41 10 00 0B 11 01 00 00 00 00 19 1A 4C F7.

## ● Scale Tune function (Model ID : 42H (GS), address: 40 1x 40H)

Scale Tune is a function that makes fine adjustments to the pitch of each note C-B. Settings are made for one octave, and applied to the notes of all octaves. By making Scale Tune settings you can use tunings and temperaments other than the standard Equal Temperament. Here we give three types of settings as examples.

### ○ Equal temperament

This temperament divides the octave into 12 equal steps, and is the temperament most frequently used today, especially in western music. Initially, the Scale Tune function of this instrument is set to Equal Temperament.

### ○ Just intonation (tonic of C)

The primary triads sound more beautiful in just intonation than in equal temperament. However, this applies only in one key, and chords will be discordant if you play in a different key. The settings here are for a tonic of C.

### ○ Arabian-type scale

The Scale Tune function allow you to use various tunings of ethnic music. Here is one of the Arabian scales.

Setting examples

Note	Equal Temp.	Just (in C)	Arabian-type scale
C	0	0	-6
C#	0	-8	+45
D	0	+4	-2
Eb	0	+16	-12
E	0	-14	-51
F	0	-2	-8
F#	0	-10	+43
G	0	+2	-4
G#	0	+14	+47
A	0	-16	0
Bb	0	+14	-10
B	0	-12	-49

The values in the above table are in units of 1 cent. Convert these values to hexadecimal, and transmit them as exclusive data. For example to set the Scale Tune of Part 1 to an Arabian-type scale, transmit the following data.

```
F0 41 10 42 12 40 11 40 3A 6D 3E 34 0D 38 6B 3C 6F 40 36 0F 50 F7
```



# MIDI Implementation Chart

Function...	Transmitted	Recognized	Remarks
Basic Channel Default Changed	1-7, 10 X	1-7, 10 X	There is no basic channel.
Mode Default Messages Altered	Mode 3 OMNI OFF, POLY * 1 *****	X X	
Note Number : True Voice	0-127 *****	0-127 0-127	
Velocity Note ON Note OFF	O O	O O	
After Touch Key's Ch's	O O	O O	
Pitch Bend	O	O	
Control Change 0-119	O	O	
Prog Change : True #	O *****	O 0-127	
System Exclusive	O	O	
System Common : Song Pos : Song Sel : Tune	O X X	O X X	* 2
System Real Time : Clock : Commands	O O	O O	* 3 * 2
Aux Message : All sound off : Reset all controllers : Local ON/OFF : All Notes OFF : Active Sensing : Reset	O O X * 4 O * 5 X * 6 X	O O X O (123-127) O X	* 5 * 6
Notes	* 1 Omni Off, Poly is transmitted to all channels at start-up. * 2 When Sync Mode is SLAVE or REMOTE * 3 When Sync Mode is SLAVE * 4 Not stored/transmitted even if received, but can be created in the Microscope and transmitted. * 5 Mode messages (123-127) are stored/transmitted after All Note Off processing is performed. The All Note Off message itself is not stored/transmitted, but can be created in the Microscope and transmitted. * 6 Transmitted/received by the sound source section. The sequencer section will perform the action taken reception is interrupted.		

Mode 1 : OMNI ON, POLY  
Mode 3 : OMNI OFF, POLY

Mode 2 : OMNI ON, MONO  
Mode 4 : OMNI OFF, MONO

O : Yes  
X : No

# Main Specifications

## JX-305: GROOVESYNTH

### Keyboard

61 keys (with velocity and channel aftertouch)

**Parts: 24 (8 + 16 (RPS))**

**Maximum Polyphony: 64 voices**

### Patches

Preset: 640

User: 256

Card: 512

### Rhythm Sets

Preset: 32

User: 20

Card: 20

### Effects

Reverb

Delay

Multi-Effects (24 types)

### Sequencer

Tracks: 8 + MUTE CTRL Track

Resolution: 96 ticks per quarter note

Tempo: 20.0–240.0

Songs: 50

### Patterns

Preset: 274

RPS: 494

User: 200 (Maximum)

Card: 200 (Maximum)

### Maximum Note Storage

Internal: approx. 75,000 Notes

Card (Option: 2 MB): approx. 220,000 Notes

Card (Option: 4 MB): approx. 480,000 Notes

### Quantize

Grid

Shuffle

Groove (71 types)

Arpeggiator: 53 Style

RPS Set: 60

Pattern Set: 30

### Display

LCD: 16 characters, 2 lines

Beat LED

### Connectors

Output Jacks (L (MONO), R)

Phones Jack

MIDI Connectors (IN, OUT, THRU)

Pedal Hold Jack

Pedal Control Jack

Pedal Switch Jack

Memory Card Slot

### Power Supply

AC Adaptor (DC 9 V)

### Current Draw

450 mA

### Dimensions

1,011 (W) x 289 (D) x 83 (H) mm

39-13/16 x 11-7/16 x 3-5/16 inches

### Weight

6.9 kg / 15 lbs 4 oz (Excluding AC Adaptor)

### Accessories

Quick Start

Owner's Manual

AC adaptor: ACI-120C, ACI-230C, ACB-230E,  
ACB-240(A)

Card Protector

### Options

SmartMedia: S2M-5/S4M-5

*\* In the interest of product improvement, the specifications and/or appearance of this unit are subject to change without prior notice.*

# Index

“Q” represents the Quick Start.

4 Band EQ.....107

## A

accent rate.....25  
aftertouch .....22, 76  
aftertouch sensitivity .....163  
all mute.....32  
alternate pan depth.....70, 96  
amplifier .....67, 94  
amplifier envelope .....68, 95, 178  
amplifier envelope level 1-3 .....71, 97  
amplifier envelope time 1-4.....71, 97  
amplifier envelope time key follow.....71  
amplifier envelope velocity curve .....70  
amplifier envelope velocity sensitivity .....70, 96  
amplifier envelope velocity time 1 sensitivity .....71  
amplifier envelope velocity time 4 sensitivity .....71  
amplifier envelope velocity time sensitivity .....96  
arabian-style temperament.....169  
arpeggiator.....Q34, 24, 127  
arpeggio.....24  
arpeggio destination.....26  
arpeggio style .....25  
arpeggio sync.....168  
arpeggio write .....28  
attack time.....58, 64, 68, 88, 92, 95  
audition .....Q22, 29  
auto checksum.....168  
auto pan.....121

## B

backup delete.....161  
backup load.....161  
band pass filter.....62, 90  
bank select.....172  
beat.....126  
beat pattern .....27  
bend range.....76, 97  
bend range down .....76  
bend range up.....76  
bias .....69  
bias direction.....69  
bias level.....69  
bias point.....69  
booster .....81  
booster gain.....81  
BPM.....31  
bulk dump.....176

## C

card duplicate.....161  
card memory.....137  
card protector .....162

category .....209  
category jump.....Q11  
change event .....148  
change gate time.....143  
change velocity .....142  
channel aftertouch.....148  
checksum.....149  
chord .....133  
chorus.....116  
coarse tune .....57, 87  
common .....77  
compressor .....113  
control 1/2/3/4 depth .....77  
control change .....147  
control destination .....77  
control pedal .....23  
control pedal assign.....163  
control pedal polarity .....163  
controller .....13, 163  
copy .....138  
current part .....18  
current pattern.....30  
cutoff frequency .....Q23, 62, 90  
cutoff frequency key follow.....65

## D

data thin.....145  
decay time .....58, 64, 68, 88, 92, 95  
default arpeggio style.....170  
default pattern .....169  
delay.....Q29, 103  
delay level .....104  
delay output assign.....105  
delay start.....71  
delay time .....105  
delay type .....105  
delete event .....150  
delete measure .....140  
delete pattern .....156  
detune effect.....58  
device ID number.....165  
distortion .....110  
dual .....Q40, 19

## E

edit quantize .....146  
edit transmit/receive mode.....165  
effects .....Q27, 101  
effects template.....29  
enhancer .....109  
envelope mode .....86  
equal temperament .....169  
erase .....141  
exclusive message .....148, 149

<b>F</b>	
factory preset .....	Q6, 170
fast-forward .....	31, 154
feedback level .....	105
feedback pitch shifter .....	122
filter .....	61, 90
filter envelope .....	63, 91, 178
filter envelope depth .....	64, 92
filter envelope level 1-4 .....	66, 94
filter envelope time 1-4 .....	66, 94
filter envelope time key follow .....	67
filter envelope velocity curve .....	66
filter envelope velocity sensitivity .....	66, 93
filter envelope velocity time 1 sensitivity .....	66
filter envelope velocity time 4 sensitivity .....	66
filter envelope velocity time sensitivity .....	93
filter type .....	61, 90
fine tune .....	57, 87
flanger .....	118
format .....	159
frequency cross modulation .....	57
FXM .....	57
FXM color .....	57
FXM depth .....	57
FXM switch .....	57
<b>G</b>	
gate reverb .....	123
gate time .....	132, 133
gate time ratio .....	132, 135
grid quantize .....	41
groove quantize .....	43
<b>H</b>	
HF damp .....	103, 105
high pass filter .....	62, 90
hold pedal .....	23
hold pedal polarity .....	163
<b>I</b>	
initialize .....	38, 84, 100, 158
input quantize resolution .....	126
input quantize strength .....	126
insert event .....	150
insert measure .....	140
insert pattern .....	157
<b>J</b>	
just intonation .....	169
<b>K</b>	
KB (kilobytes) .....	137
key mode .....	Q40, 18
key range lower .....	81

key range upper .....	81
keyboard velocity .....	22, 163

<b>L</b>	
LCD contrast .....	168
LFO .....	71
LFO1 .....	Q25, 179
LFO1 amplifier depth .....	73
LFO1 depth .....	73
LFO1 fade time .....	74
LFO1 filter depth .....	73
LFO1 pitch depth .....	73
LFO1 rate .....	72
LFO1 waveform .....	72
LFO1/LFO2 delay time .....	75
LFO1/LFO2 fade mode .....	75
LFO1/LFO2 key sync .....	75
LFO1/LFO2 level offset .....	75
LFO1/LFO2 pan depth .....	76
LFO1/LFO2 tempo sync .....	74
limiter .....	113
lo-fi .....	110
local switch .....	165
loop mix recording .....	125
loop mode .....	167
loop replace recording .....	125
loop rest .....	126, 128
low pass filter .....	61, 90
lower part .....	19

<b>M</b>	
M-FX .....	101, 106
master .....	176
master tune .....	168
maximum number of recording notes .....	137
maximum simultaneous polyphony .....	14, 81
memory .....	15
memory card .....	16, 159
memory information .....	137
metronome .....	126
metronome level .....	167
metronome mode .....	167
microscope edit .....	146
microscope .....	146
MIDI .....	164, 171
MIDI channel .....	36, 171
MIDI update .....	40
modify .....	38
modify data .....	40, 128
modulation lever .....	22, 76
monitor .....	32
motif .....	27
move event .....	151
multi-effects .....	Q31, 106

multi-effects output level.....	106
multi-effects type .....	106
multi-effects->delay level .....	105
multi-effects->reverb level.....	103
mute .....	32, 129, 148
MUTE CTRL .....	129
mute exchange.....	32
mute group.....	86

## N

next pattern .....	30
no event .....	148
noise generator .....	111
note.....	147

## O

octave range.....	26
octave shift .....	21
overdrive .....	109

## P

pan.....	33
pan key follow .....	70
part .....	14
part delay level.....	34, 35, 104
part key shift .....	34, 35
part level.....	33, 35
part mixer.....	Q14, 33
part multi-effects switch .....	34, 35, 124
part mute.....	32
part pan .....	33, 35
part reverb level .....	34, 35, 102
patch.....	Q18, 13, 18
patch edit.....	53
patch initialize .....	84
patch parameter .....	53
patch remain .....	169
patch tone copy .....	83
patch write .....	82
pattern.....	Q10, 14, 30
pattern edit.....	138
pattern initialize .....	38
pattern length .....	126
pattern mode.....	30
pattern reset .....	39
pattern set.....	Q60, 15, 152
pattern set write .....	153
pattern write .....	36
peaking filter.....	62, 90
phaser.....	115
phonograph.....	112
pitch.....	57, 87
pitch bend.....	148
pitch bend lever.....	22, 76

pitch envelope .....	58, 87, 179
pitch envelope depth .....	59, 88
pitch envelope level 1-4.....	61, 90
pitch envelope time 1-4 .....	60, 90
pitch envelope time key follow .....	61
pitch envelope velocity sensitivity .....	60, 89
pitch envelope velocity time 1 sensitivity .....	61
pitch envelope velocity time 4 sensitivity .....	61
pitch envelope velocity time sensitivity .....	89
pitch key follow .....	60
play quantize .....	Q17, 40
polyphonic aftertouch .....	148
portamento.....	21, 77
portamento mode.....	79
portamento start pitch.....	79
portamento switch .....	77
portamento time.....	21, 78
portamento type.....	79
preset memory.....	15
program change .....	147, 172

## Q

quantize .....	40, 146
----------------	---------

## R

radio tuning .....	112
random pan switch .....	67, 95
random pitch depth .....	60, 89
real-time erase .....	130
real-time modify.....	38
real-time recording .....	125
real-time transpose .....	32
receive bank select switch.....	166
receive program change switch .....	166
receive system exclusive switch.....	166
reclock.....	145
recording parameter .....	126
recording part.....	126
recording standby .....	125
redo .....	17
rehearsal function .....	127
release time .....	58, 64, 68, 88, 92, 95
remote keyboard switch.....	165
resolution.....	41, 42
resonance.....	Q24, 63, 91
resonance limiter .....	169
resonance velocity sensitivity.....	66, 93
rest.....	133
reverb .....	Q28, 102, 123
reverb time .....	103
reverb type .....	103
rewind.....	31, 154
rhythm edit .....	85
rhythm group .....	39

rhythm key copy .....	99
rhythm mute .....	32
rhythm set .....	Q20, 14, 28
rhythm set write .....	98
rhythm tone .....	85, 97
rhythm tone delay level .....	98
rhythm tone initialize .....	100
rhythm tone level .....	94
rhythm tone multi-effects switch .....	98
rhythm tone pan .....	94
rhythm tone reverb level .....	97
rhythm tone switch .....	86
ring modulator .....	81
RPS .....	Q36, 48
RPS hold .....	Q38, 49
RPS part delay level .....	50
RPS part key shift .....	50
RPS part level .....	50
RPS part multi-effects switch .....	50
RPS part pan .....	50
RPS part reverb level .....	50
RPS set .....	48
RPS set write .....	52
RPS stop .....	48
RPS trigger quantize .....	167
Rx switch .....	165

## S

sawtooth wave .....	56
scale .....	134
scale tune .....	168
sequencer .....	13, 166
sequencer output assign .....	36
setup copy .....	37
setup parameter .....	37
shift clock .....	144
short delay .....	120
shuffle quantize .....	42
shuffle rate .....	27, 42
simultaneous polyphony .....	14
sine wave .....	56
single .....	18
slave .....	167, 175, 176
slicer .....	114
slide effect .....	133
solo legato switch .....	79
solo switch .....	78
song .....	Q65, 15, 154
song copy .....	156
song edit .....	155
song initialize .....	158
song write .....	157
sound generator .....	13
space-D .....	117

spectrum .....	108
split .....	Q41, 19
split point .....	19
square wave .....	56
staccato .....	132
standard tempo .....	31
step flanger .....	119
step recording .....	131
step recording 1 .....	131, 132
step recording 2 .....	131, 134
step time .....	132, 133
strength .....	42, 45
stretch tuning .....	81
stretch tuning depth .....	81
structure type .....	79
sustain level .....	58, 64, 68, 88, 92, 95
switch pedal .....	46
switch pedal assign .....	164
switch pedal polarity .....	164
sync mode .....	167
sync out .....	167
system exclusive .....	148, 149
system memory .....	15

## T

TAP .....	46
tap resolution .....	168
template .....	43
tempo .....	31, 129
tempo change .....	148
temporary .....	16, 137
temporary pattern .....	16
tenuto .....	132
tetra chorus .....	117
thru function .....	165
tie .....	133
tone .....	13, 53
tone level .....	67
tone pan .....	67
tone select .....	55
tone switch .....	55, 56
transmit active sensing switch .....	166
transmit bank select switch .....	166
transmit program change switch .....	166
transpose .....	142
transpose value .....	32
tremolo .....	115
triangle wave .....	56
turntable .....	Q39, 47

## U

undo .....	17
upper part .....	19
user backup .....	160



---

user memory .....15, 137  
utility .....37, 83, 99, 158, 160, 161, 170, 176

**V**

velocity .....22, 28, 132, 135, 163  
velocity crossfade .....82  
velocity range lower .....82  
velocity range switch .....82  
velocity range upper .....82  
velocity strength .....45  
view filter .....151  
voice priority .....81  
voice reserve .....169

**W**

wave .....56, 86  
wave gain .....56, 86  
wave select .....56, 86  
waveform .....56  
write .....28, 36, 52, 82, 98, 153, 157



# Information

When you need repair service, call your nearest Roland Service Center or authorized Roland distributor in your country as shown below.

## ARGENTINA

**Instrumentos Musicales S.A.**  
Florida 638  
(1005) Buenos Aires  
ARGENTINA  
TEL: (01) 394 4029

## BRAZIL

**Roland Brasil Ltda.**  
R. Coronel Octaviano da Silveira  
203 05522-010  
Sao Paulo BRAZIL  
TEL: (011) 843 9377

## CANADA

**Roland Canada Music Ltd.**  
(Head Office)  
5480 Parkwood Way Richmond  
B. C., V6V 2M4 CANADA  
TEL: (0604) 270 6626

**Roland Canada Music Ltd.**  
(Toronto Office)  
Unit 2, 109 Woodbine Downs  
Blvd, Etobicoke, ON  
M9W 6Y1 CANADA  
TEL: (0416) 213 9707

## MEXICO

**Casa Veerkamp, s.a. de c.v.**  
Av. Toluca No. 323 Col. Olivar de  
los Padres 01780 Mexico D.F.  
MEXICO  
TEL: (525) 668 04 80

**La Casa Wagner de  
Guadalajara s.a. de c.v.**  
Av. Corona No. 202 S.J.  
Guadalajara, Jalisco Mexico  
C.P. 44100 MEXICO  
TEL: (03) 613 1414

## PANAMA

**Productos Superiores, S.A.**  
Apartado 655 - Panama 1  
REP. DE PANAMA  
TEL: 26 3322

## U. S. A.

**Roland Corporation U.S.**  
7200 Dominion Circle  
Los Angeles, CA. 90040-3696,  
U. S. A.  
TEL: (0213) 685 5141

## VENEZUELA

**Musicland Digital C.A.**  
Av. Francisco de Miranda,  
Centro Parque de Cristal, Nivel  
C2 Local 20 Caracas  
VENEZUELA  
TEL: (02) 285 9218

## AUSTRALIA

**Roland Corporation  
Australia Pty. Ltd.**  
38 Campbell Avenue  
Dee Why West, NSW 2099  
AUSTRALIA  
TEL: (02) 9982 8266

## NEW ZEALAND

**Roland Corporation (NZ) Ltd.**  
97 Mt. Eden Road, Mt. Eden,  
Auckland 3, NEW ZEALAND  
TEL: (09) 3098 715

## CHINA

**Beijing Xinghai Musical  
Instruments Co., Ltd.**  
6 Huangmunchang Chao Yang  
District, Beijing, CHINA  
TEL: (010) 6774 7491

## HONG KONG

**Tom Lee Music Co., Ltd.**  
Service Division  
22-32 Pun Shan Street, Tsuen  
Wan, New Territories,  
HONG KONG  
TEL: 2415 0911

## INDIA

**Rivera Traders Pvt. Ltd.**  
409, Nirman Kendra,  
off Dr. Edwin Moses Road,  
Mumbai 400011, INDIA  
TEL: (022) 498 3079

## INDONESIA

**PT Galestra Inti**  
Kompleks Perkantoran  
Duta Merlin Blok E No.6-7  
Jl. Gajah Mada No.3-5,  
Jakarta 10130,  
INDONESIA  
TEL: (021) 6335416

## KOREA

**Cosmos Corporation  
Service Station**  
261 2nd Floor Nak-Won Arcade  
Jong-Ro ku, Seoul, KOREA  
TEL: (02) 742 8844

## MALAYSIA

**Bentley Music SDN BHD**  
140 & 142, Jalan Bukit Bintang  
55100 Kuala Lumpur, MALAYSIA  
TEL: (03) 2443333

## PHILIPPINES

**G.A. Yupangco & Co. Inc.**  
339 Gil J. Puyat Avenue  
Makati, Metro Manila 1200,  
PHILIPPINES  
TEL: (02) 899 9801

## SINGAPORE

**Swee Lee Company**  
BLOCK 231, Bain Street #03-23  
Bras Basah Complex,  
SINGAPORE 180231  
TEL: 3367886

## CRISTOFORI MUSIC PTE LTD

Blok 3014, Bedok Industrial Park E,  
#02-2148, SINGAPORE 489980  
TEL: 243 9555

## TAIWAN

**ROLAND TAIWAN  
ENTERPRISE CO., LTD.**  
Room 5, 9th. No. 112 Chung Shan  
N.Road Sec-2, Taipei, TAIWAN,  
R.O.C.  
TEL: (02) 2561 3339

## THAILAND

**Theera Music Co., Ltd.**  
330 Vereng Nakorn Kasem, Soi 2,  
Bangkok 10100, THAILAND  
TEL: (02) 2248821

## VIETNAM

**Saigon music distributor**  
160 Nguyen Dinh Chieu St. Dist 3  
Ho chi minh City  
VIETNAM  
TEL: 88-242531

## BAHRAIN

**Moon Stores**  
Bab Al Bahrain Road,  
P.O.Box 20077  
State of BAHRAIN  
TEL: 211 005

## ISRAEL

**Halilit P. Greenspoon &  
Sons Ltd.**  
8 Retzif Fa'aliya Hashnya St.  
Tel-Aviv-Yahou ISRAEL  
TEL: (03) 682366

## JORDAN

**AMMAN Trading Agency**  
Prince Mohammed St. P. O. Box  
825 Anuman 11118 JORDAN  
TEL: (06) 641200

## KUWAIT

**Easa Husain Al-Yousifi**  
P.O. Box 126 Safat 13002  
KUWAIT  
TEL: 5719499

## LEBANON

**A. Chahine & Fils**  
P.O. Box 16-5857 Gergi Zeidan St.  
Chahine Building, Achrafieh  
Beirut, LEBANON  
TEL: (01) 335799

## OMAN

**OHI Electronics & Trading  
Co. LLC**  
P. O. Box 889 Muscat  
Sultanate of OMAN  
TEL: 959085

## QATAR

**Badie Studio & Stores**  
P.O.Box 62,  
DOHA QATAR  
TEL: 423554

## SAUDI ARABIA

**Abdul Latif S. Al-Ghamdi  
Trading Establishment**  
Middle East Commercial Center  
Al-Khobar Dharran Highway  
P.O. Box 3631 Al-Khobar  
31952 SAUDIARABIA  
TEL: (03) 898 2332

**aDawlah Universal  
Electronics APL**  
P.O.Box 2154 ALKHOBAR 31952,  
SAUDI ARABIA  
TEL: (03) 898 2081

## SYRIA

**Technical Light & Sound  
Center**  
Khaled Ibn Al Walid St.  
P.O.Box 13520  
Damascus - SYRIA  
TEL: (011) 2235 384

## TURKEY

**Barkat Muzik aletleri ithalat  
ve ihracat limited ireketi**  
Siraselvier Cad. Guney Ishani No.  
86/6 Taksim, Istanbul TURKEY  
TEL: (0212) 2499324

## U.A.E

**Zak Electronics & Musical  
Instruments Co.**  
Zabeel Road, Al Sherooq Bldg.,  
No. 14, Grand Floor DUBAI  
U.A.E.  
P.O. Box 8050 DUBAI, U.A.E  
TEL: (04) 360715

## EGYPT

**Al Fanny Trading Office**  
P.O.Box 2904,  
El Horrieh Heliopolos, Cairo,  
EGYPT  
TEL: (02) 4171828  
(02) 4185531

## KENYA

**Musik Land Limited**  
P.O Box 12183 Moi Avenue  
Nairobi Republic of KENYA  
TEL: (2) 338 346

## REUNION

**Maison FO - YAM Marcel**  
25 Rue Jules MermanZL  
Chaudron - BP79 97491  
Ste Clotilde REUNION  
TEL: 28 29 16

## SOUTH AFRICA

**That Other Music Shop  
(PTY) Ltd.**  
11 Melle Street (Cnr Melle and  
Juta Street)  
Braamfontein 2001  
Republic of SOUTH AFRICA  
TEL: (011) 403 4105

**Paul Bothner (PTY) Ltd.**  
17 Werdmuller Centre Claremont  
7700  
Republic of SOUTH AFRICA  
TEL: (021) 64 4030

## AUSTRIA

**E. Dematte & Co.**  
Neu-Rum Siemens-Strasse 4  
6063 Innsbruck AUSTRIA  
TEL: (0512) 26 44 260

## BELGIUM/HOLLAND/ LUXEMBOURG

**Roland Benelux N. V.**  
Houtstraat 3 B-2260 Oevel  
(Westerlo) BELGIUM  
TEL: (014) 575811

## BELORUSSIA

**TUSHE**  
UL. Rabkorovskaya 17  
220001 MINSK  
TEL: (0172) 764-911

## CYPRUS

**Radex Sound Equipment Ltd.**  
17 Diagorou St., P.O.Box 2046,  
Nicosia CYPRUS  
TEL: (02) 453 426

## DENMARK

**Roland Scandinavia A/S**  
Langebrogade 6 Post Box 1937  
DK-1023 Copenhagen K.  
DENMARK  
TEL: 32 95 3111

## FRANCE

**Roland France SA**  
4, Rue Paul Henri SPAAK  
Parc de l'Esplanade F 77 462 St.  
Thibault Lagny Cedex FRANCE  
TEL: 01 600 73 508

## FINLAND

**Roland Scandinavia As,  
Filial Finland**  
Lautasaarentie 54 B  
Fin-00201 Helsinki, FINLAND  
TEL: (9) 682 4020

## GERMANY

**Roland Elektronische  
Musikinstrumente  
Handelsgesellschaft mbH.**  
Oststrasse 96, 22844 Norderstedt,  
GERMANY  
TEL: (040) 52 60090

## GREECE

**V. Dimitriadis & Co. Ltd.**  
20, Alexandras St. & Bouboulinas  
54 St. 106 82 Athens, GREECE  
TEL: (01) 8232415

## HUNGARY

**Intermusica Ltd.**  
Warehouse Area 'DEPO' Pf.83  
H-2046 Torokbalint, HUNGARY  
TEL: (23) 511011

## IRELAND

**The Dublin Service Centre  
Audio Maintenance Limited**  
11 Brunswick Place Dublin 2  
Republic of IRELAND  
TEL: (01) 677322

## ITALY

**Roland Italy S. p. A.**  
Viale delle Industrie, 8  
20020 Arese Milano, ITALY  
TEL: (02) 937 781

## NORWAY

**Roland Scandinavia Avd.  
Kontor Norge**  
Lilleakerveien 2 Postboks 95  
Lilleaker N-0216 Oslo  
NORWAY  
TEL: 273 0074

## POLAND

**P. P. H. Brzostowicz Marian**  
UL. Blokowa 32, 03624 Warszawa  
POLAND  
TEL: (022) 679 44 19

## PORTUGAL

**Caius - Tecnologias Audio e  
Musica, Lda.**  
Rue de SANTA Catarina 131  
4000 Porto, PORTUGAL  
TEL: (02) 38 4456

## RUSSIA

**Slami Music Company**  
Sadojava-Triumfalnaja st., 16  
103006 Moscow, RUSSIA  
TEL: 095 209 2193

## SPAIN

**Roland Electronics  
de España, S. A.**  
Calle Bolivia 239 08020 Barcelona,  
SPAIN  
TEL: (93) 308 1000

## SWEDEN

**Roland Scandinavia A/S  
SWEDISH SALES OFFICE**  
Danvik Center 28, 2 tr.  
S-131 30 Nacka SWEDEN  
TEL: (08) 702 0020

## SWITZERLAND

**Roland (Switzerland) AG  
Musitronic AG**  
Gerberstrasse 5, CH-4410 Liestal,  
SWITZERLAND  
TEL: (061) 921 1615

## UKRAINE

**TIC-TAC**  
Mira Str. 19/108  
P.O.Box 180  
295400 Munkachevo, UKRAINE  
TEL: (03131) 414-40

## UNITED KINGDOM

**Roland (U.K.) Ltd., Swansea  
Office**  
Atlantic Close, Swansea  
Enterprise Park SWANSEA  
West Glamorgan SA7 9FJ,  
UNITED KINGDOM  
TEL: (01792) 700139

For the U.K.

**IMPORTANT:** THE WIRES IN THIS MAINS LEAD ARE COLOURED IN ACCORDANCE WITH THE FOLLOWING CODE.

BLUE: NEUTRAL  
BROWN: LIVE

As the colours of the wires in the mains lead of this apparatus may not correspond with the coloured markings identifying the terminals in your plug, proceed as follows:

The wire which is coloured BLUE must be connected to the terminal which is marked with the letter N or coloured BLACK.  
The wire which is coloured BROWN must be connected to the terminal which is marked with the letter L or coloured RED.  
Under no circumstances must either of the above wires be connected to the earth terminal of a three pin plug.

For EU Countries



This product complies with the requirements of European Directive 89/336/EEC.

For the USA

## FEDERAL COMMUNICATIONS COMMISSION RADIO FREQUENCY INTERFERENCE STATEMENT

This equipment has been tested and found to comply with the limits for a Class B digital device, pursuant to Part 15 of the FCC Rules. These limits are designed to provide reasonable protection against harmful interference in a residential installation. This equipment generates, uses, and can radiate radio frequency energy and, if not installed and used in accordance with the instructions, may cause harmful interference to radio communications. However, there is no guarantee that interference will not occur in a particular installation. If this equipment does cause harmful interference to radio or television reception, which can be determined by turning the equipment off and on, the user is encouraged to try to correct the interference by one or more of the following measures:

- Reorient or relocate the receiving antenna.
- Increase the separation between the equipment and receiver.
- Connect the equipment into an outlet on a circuit different from that to which the receiver is connected.
- Consult the dealer or an experienced radio/TV technician for help.

Unauthorized changes or modification to this system can void the users authority to operate this equipment.  
This equipment requires shielded interface cables in order to meet FCC class B Limit.

For Canada

### NOTICE

This Class B digital apparatus meets all requirements of the Canadian Interference-Causing Equipment Regulations.

### AVIS

Cet appareil numérique de la classe B respecte toutes les exigences du Règlement sur le matériel brouilleur du Canada.

# Easy Operation List

## Whole

Modify value by larger steps	[SHIFT] + [VALUE] (p. 16)
LCD Contrast	[EDIT] -> BANK [8] (p. 168)
Tuning	[EDIT] -> BANK [8] -> BANK [8] (p. 168)

## Effects

Effects On/Off (Master)	[SHIFT] + [FX ON/OFF] (p. 101)
Select Multi Effects Type	[ENVELOPE/LFO1/EFFECTS] + [VALUE] when the "Effects" indicator is lit (p. 106)

## Pattern Play

Move to the last measure	[FWD] + [BWD] (p. 31)
Move to the first measure	[BWD] + [FWD] (p. 31)
All Mute	[SHIFT] + [PART MUTE] (p. 32)
Monitor	[PART MUTE] + PART [1]-[R] (p. 32)
Mute Exchange	[PART MUTE] + [PART SELECT] (p. 32)
Quickly listen to next pattern	[SHIFT] + PAGE [-] [=] during Pattern playback (p. 31)
MIDI Update	[SHIFT] + [STOP/PLAY] (p. 40)
Save Patterns	[SHIFT] + [WRITE] in PTN page -> Specify destination (p. 36)

## Pattern Set

Register Patterns	[PTN SET] + BANK, NUMBER button to be registered (p. 152)
Save Pattern Set	[SHIFT] + [WRITE] in PTN SET page -> Specify destination (p. 153)

## Song

Save Songs	[SHIFT] + [WRITE] in SONG page -> specify destination (p. 157)
------------	--

## Pattern Recording

Real-Time Recording	[REC] -> [STOP/PLAY] (p. 125)
Rehearsal	[REC] during recording (p. 127)
Real-Time Erase	[SHIFT] + [ERASE] during recording -> Data is erased while [REC] is pressed (p. 130)
Microscope	[SHIFT] + [M.SCOPE] (p. 146)
Change Event	PAGE[>] -> [VALUE] -> [ENTER] (p. 148)
Delete Event	NUMBER [4]-[ENTER] (p. 150)
Insert Event	NUMBER [3]-[ENTER] (p. 150)
Move Event	[SHIFT] + [REC] + [VALUE] (p. 151)
Step Recording1	[SHIFT] + [M.SCOPE] -> [REC] -> [REC] (p. 131)
Tie	[BWD] (p. 133)
Rest	[FWD] (p. 133)
Back	[SHIFT] + [BWD] (p. 133)
Step Recording2	[SHIFT] + [M.SCOPE] -> [REC] -> [STOP/PLAY] (p. 131)
Select Note	[SHIFT] + keyboard (p. 134)
Edit for Input Notes	key to be edited + [VALUE] (p. 136)

## Arpeggiator

Select Style	[ARP] + [VALUE] (p. 25)
Save Arpeggio Settings	[SHIFT] + [WRITE] in arpeggio setting page -> Specify destination (p. 28)

## RPS

Register RPS Set	Mute all parts except for the part to be registered -> [RPS] + destination keyboard (p. 49)
Change Setup for RPS part	[RPS] + [TEMPO&MEASURE] -> Select parameter -> Select RPS part using keyboard (p. 50)
Change Patch for RPS part	[RPS] + [PATCH] -> Select RPS part using keyboard (p. 51)
Save RPS Sets	[SHIFT] + [WRITE] in RPS SET page -> Specify destination (p. 52)

## Play Quantize

Select the Resolution/Template	[GRID/SHUFFLE/GROOVE] + [VALUE] (p. 40)
Select the Part for Quantize	[SHIFT] + [QTZ SELECT] -> PART [1]-[R] (p. 41)

## Part Mixer

Set using [INC] [DEC]	Select current part -> [INC] [DEC] (p. 33)
Key Shift in Octave step	Select K-Sh -> [SHIFT] + knob (p. 34)

## Patch Edit

Confirm Current Settings	[SHIFT] + knob (p. 55)
Set Envelope Depth	[ENVELOPE/LFO1/EFFECTS] + [VALUE] when the "ENVELOPE" indicator is lit (p. 59, 64, 68, 88, 92, 95)
Set LFO1 Waveform	[ENVELOPE/LFO1/EFFECTS] + [VALUE] when the "LFO1" indicator is lit (p. 72)
Set Filter Type	[FILTER/AMP/PITCH] + [VALUE] when the "FILTER" indicator is lit (p. 61)
Set Random Pan Switch	[FILTER/AMP/PITCH] + [VALUE] when the "AMP" indicator is lit (p. 67)
Set Coarse Tune	[FILTER/AMP/PITCH] + [VALUE] when the "PITCH" indicator is lit (p. 57)
Save Patches	[SHIFT] + [WRITE] in PATCH page -> Specify destination (p. 82)

## Turntable

Turntable On/Off	[SHIFT] + Modulation lever (p. 47)
------------------	------------------------------------

## Multi Effects Assignment

	4-BAND-EQ	SPECTRUM	ENHANCER	OVERDRIVE
CTRL1	High Gain	Low-High Gain	Sens	Drive
CTRL2	Low Gain	Middle Gain	Mix Level	AMP Type
	<b>DISTORTION</b>	<b>Lo-Fi</b>	<b>NOISE</b>	<b>RADIO-TUNG</b>
CTRL1	Drive	Bit Down	Lo-Fi Level	Radio-Detune
CTRL2	AMP Type	S-Rate Down	Noise Level	Noise Level
	<b>PHONOGRAPH</b>	<b>COMPRESSOR</b>	<b>LIMITER</b>	<b>SLICER</b>
CTRL1	Depth	Attack	Threshold	Timing PTN
CTRL2	D Noise Level	Sustain	Release	Accent PTN
	<b>TREMOLO</b>	<b>PHASER</b>	<b>CHORUS</b>	<b>SPACE-D</b>
CTRL1	Depth	Depth	Depth	Depth
CTRL2	Rate	Rate	Rate	Rate
	<b>TETRA-CHRS</b>	<b>FLANGER</b>	<b>ST-FLANGER</b>	<b>SHORT-DELY</b>
CTRL1	Depth	Depth	Depth	Time-L
CTRL2	Rate	Rate	Step Rate	Time-R
	<b>AUTO-PAN</b>	<b>FB-P-SHIFT</b>	<b>REVERB</b>	<b>GATE-REVRB</b>
CTRL1	Depth	Coarse	Time	Gate Time
CTRL2	Rate	Feedback	Balance	Balance



 Roland®

---

71451534

UPC

71451534



18981

**Roland**