

Roland®



SUPER JV <sup>64 VOICE</sup> SYNTHESIZER MODULE

**JV-1080**

*4x EXPANSION*

OWNER'S MANUAL



---

## Before You Begin...

Thank you, and congratulations on your choice of the Roland **JV-1080** Expandable Synthesizer Module. The JV's high-quality sounds and outstanding ease of operation are sure to satisfy every musician, from absolute beginner to accomplished pro. And thanks to its enhanced multi-timbral sound generating capabilities, creating complex ensemble pieces has never been easier!

To ensure proper operation and years of trouble-free service from your new **JV-1080**, it is important that you take the time to read this manual carefully.

---

## ■ Features

### ● High-Quality Sounds

The JV includes a wide variety of preset Patches (sounds) and Rhythm Sets, ranging from amazingly realistic acoustic sounds to completely synthesized timbres.

### ● 64-Voice Polyphony and 16-Part Multi-Timbral Capability

With 16 Parts and 64 voices available at any one time, the JV will effortlessly recreate even the most demanding of ensemble performances.

### ● Complete Effects Selection

The JV's state-of-the-art DSP (Digital Signal Processor) section creates an amazing array of the most stunning digital effects, including shimmering chorus and warm, natural reverb.

### ● Outstanding Expandability

In addition to conventional DATA and PCM cards, the **JV-1080** can also house up to four Wave Expansion cards simultaneously. With the addition of raw wave data, the sonic palette of the JV is expanded dramatically.

### ● Multiple Outputs

The **JV-1080** has three sets of stereo outputs — MIX OUT, OUTPUT 1, and OUTPUT 2. These independent output jacks let you add different external effects to different sounds for sophisticated mixing.

### ● Easy Operation

Each operational mode is directly activated by its own button, while Function Select buttons also simplify operation.

### ● General MIDI System Supported

The JV features a General MIDI System mode that makes playing music with other MIDI modules, devices and computers a breeze.

\* **The General MIDI System** is a recommended standard for the functions of MIDI sound modules. It was designed for the creation of music data that is not restricted to a particular manufacturer or model. Sound modules and song data that conform to the General MIDI System carry the GM logo (). Any song data bearing the GM logo can be played on any sound module also bearing the GM logo.

---

## ■ About the Conventions Used in This Manual

In order to explain the JV's operation as clearly and concisely as possible, this manual makes use of the following symbols and conventions.

- Words or numbers enclosed in [square brackets] indicate panel buttons or controls. For example, [PATCH] refers to the "Patch" button, and [ENTER] means the "Enter" button.
- A slash between buttons names — such as [◀]/[▶] or [INC]/[DEC] — means that either of the two buttons indicated may be pressed.
- A plus sign (+) between two button names means that the two buttons should be pressed at the same time. For example, [SHIFT]+[ENTER] means "hold down the [SHIFT] button and then press [ENTER]."
- A reference such as "p. \*\*\*" means refer to the indicated page number.

- Starting in Chapter 3, parameters are expressed as follows.

Screen abbreviation	Full name	Permissible values
<Rat>	Chorus Rate	— 0 to 127
<Typ>	FilterType	— OFF/LPF/BPF/HPF/PKG 

↑  
This means that the Palette Edit screen is displayed.

## ■ About the Screen Displays

Please be aware that some of the display screens shown in this manual may differ from what you actually see. Displays depend upon the unit's configuration (the addition of wave cards, etc.) and internal settings.

---

© 1994 ROLAND CORPORATION

All rights reserved. No part of this publication may be reproduced in any form without the written permission of Roland Corporation.

# Table of Contents

Before You Begin .....	3
Features .....	3
About the Conventions Used in This Manual .....	3
About the Screen Displays .....	3
Panel Descriptions .....	6
Important Notes .....	8

## Quick Start

1. Getting Ready to Play .....	10
■ Connecting with Audio Equipment .....	10
■ Turning On the Power .....	11
■ Turning Off the Power .....	11
2. Playing the Demo Songs (ROM Play) .....	12
3. Auditioning the Sounds .....	13
4. Changing Sounds (Patches) .....	15
5. Saving Sounds and Settings .....	18

## Chapter 1 — Overview of the JV-1080

1. Units of Sound .....	20
■ The Smallest Units of Sound — Tones .....	20
■ Combinations of Tones That Make Sounds — Patches .....	20
■ Play Percussion Instruments Assigned to Each Key — Rhythm Sets .....	21
■ Assigning Patches and a Rhythm Set Equivalent to 16 Devices — Performances .....	21
■ Using Performances .....	22
2. Sound Module and Memory .....	23
3. Modes on the JV-1080 .....	24
4. About the Effects .....	25
5. Concerning Tone Editing .....	26

## Chapter 2 — Basic Operation

1. Choosing a Mode .....	28
2. Play .....	29
■ Choosing a Sound .....	29
■ Using Cards and Expansion Boards .....	31
■ Choosing the Tones and Parts to Play .....	31
■ Changing the Pitch of a Sound — Octave Shift .....	32
3. Editing .....	33
■ Entering the Edit Mode .....	33
■ Choosing the Tones and Parts to Edit .....	33
■ Moving the Cursor and Changing Settings .....	35
■ Changing Pages .....	36
■ Editing a Patch While in the Performance Mode .....	37
■ Switching Effects On and Off .....	38
■ Confirming Current Settings or MIDI Information — The Information Function .....	38

## Chapter 3 — Modes and Parameters

1. Patch Edit Mode .....	42
■ Making Settings for an Entire Patch (COMMON) .....	42
■ Selecting Effects Added to the Patch (EFFECTS) .....	44
■ Using Controllers to Change How Sounds Are Played (CONTROL) .....	47
■ Selecting Waveforms (WAVE) .....	50

■ Adding Undulations to a Sound (LFO) .....	51
■ Changing the Pitch (PITCH) .....	52
■ Changing the Sound (TVF) .....	53
■ Changing the Volume (TVA) .....	55
2. Performance Edit Mode .....	57
■ Making Settings for an Entire Performance (COMMON) .....	57
■ Selecting Effects Added to the Performance (EFFECTS) .....	57
■ Setting the MIDI Channel for a Part (MIDI) .....	59
■ Selecting the Patch Assigned to a Part (PART) .....	60
■ Setting the Pitch for a Part (PITCH) .....	60
■ Setting the Stereo Position for a Part (PAN) .....	60
■ Setting the Volume for a Part (LEVEL) .....	60
3. Rhythm Edit Mode .....	61
■ Naming a Rhythm Set (COMMON) .....	61
■ Selecting Effects Added to the Rhythm Set (EFFECTS) .....	61
■ Using Controllers to Change How Sounds Are Played (CONTROL) .....	63
■ Selecting Waveforms for a Rhythm Tone (WAVE) .....	63
■ Changing the Pitch of a Rhythm Tone (PITCH) .....	64
■ Changing the Sound of a Rhythm Tone (TVF) .....	64
■ Changing the Volume of a Rhythm Tone (TVA) .....	65
4. System Mode .....	66
■ Making Selections for Settings and the Display (SETUP) .....	66
■ Making Settings for MIDI (MIDI) .....	66
■ Adjusting the Tuning (TUNE) .....	68
■ Using the JV-1080's Controls to Play Test Sounds (PREVIEW) .....	69
5. Utility Mode .....	70
■ Saving the Data You've Created (WRITE) .....	70
■ Copying Data (COPY) .....	71
■ Initializing Data (INITIALIZE) .....	72
■ Protecting Data (PROTECT) .....	72
■ Using a DATA Card (CARD) .....	72
■ Copying a Specific Range of Data (BLOCK COPY) .....	74
■ Sending Data to an External MIDI Device (BULK DUMP) .....	74
■ Returning Settings to Their Factory Defaults (FACTORY PRESET) .....	74

## Chapter 4 — Other Functions of the JV-1080

1. Using the JV-1080 with a DTMS (playing back GM scores) .....	76
■ Selecting GM mode .....	76
■ Initializing GM mode .....	76
2. Enhancing Musical Expression in GM mode .....	77
■ Adjusting the Effects .....	77
■ Selecting a Patch for each Part (PART) .....	78
■ Adjusting the Pitch of each Part (PITCH) .....	78
■ Adjusting the pan position of each Part (PAN) .....	78
■ Adjusting the volume of each Part (LEVEL) .....	78
3. Live Performance Techniques .....	79
■ Selecting JV-1080 sounds from an external device .....	79

■ Maximum simultaneous notes and Part priorities .....	79
■ Using MIDI Controllers .....	80
4. Using Effects .....	81

## Chapter 5 — Multi-Effector EFX

1. EFX Effect Types .....	84
■ 1:STEREO-EQ (Stereo Equalizer) .....	84
■ 2:OVERDRIVE .....	84
■ 3:DISTORTION .....	84
■ 4:PHASER .....	85
■ 5:SPECTRUM .....	85
■ 6:ENHANCER .....	85
■ 7:AUTO-WAH .....	86
■ 8:ROTARY .....	86
■ 9:COMPRESSOR .....	87
■ 10:LIMITER .....	87
■ 11:HEXA-CHORUS .....	87
■ 12:TREMLOLO-CHORUS .....	88
■ 13:SPACE-D .....	88
■ 14:STEREO-CHORUS .....	88
■ 15:STEREO-FLANGER .....	89
■ 16:STEP-FLANGER .....	89
■ 17:STEREO-DELAY .....	90
■ 18:MODULATION-DELAY .....	91
■ 19:TRIPLE-TAP-DELAY .....	91
■ 20:QUADRUPLE-TAP-DELAY .....	92
■ 21:TIME-CONTROL-DELAY .....	93
■ 22:2VOICE-PITCH-SHIFTER .....	93
■ 23:FBK-PITCH-SHIFTER (Feedback Pitch Shifter) .....	94
■ 24:REVERB .....	94
■ 25:GATE-REVERB .....	95
■ 26:OVERDRIVE -> CHORUS .....	95
■ 27:OVERDRIVE -> FLANGER .....	95
■ 28:OVERDRIVE -> DELAY .....	96
■ 29:DISTORTION -> CHORUS .....	96
■ 30:DISTORTION -> FLANGER .....	96
■ 31:DISTORTION -> DELAY .....	96
■ 32:ENHANCER -> CHORUS .....	96
■ 33:ENHANCER -> FLANGER .....	97
■ 34:ENHANCER -> DELAY .....	97
■ 35:CHORUS -> DELAY .....	98
■ 36:FLANGER -> DELAY .....	98
■ 37:CHORUS -> FLANGER .....	99
■ 38:CHORUS/DELAY .....	99
■ 39:FLANGER/DELAY .....	99
■ 40:CHORUS/FLANGER .....	99

## Chapter 6 — Supplementary Materials

Troubleshooting .....	102
Parameter Lists .....	105
Default Settings for the Sound Settings .....	122
The Demo Song Names / Composer Profiles .....	129
Roland Exclusive Messages .....	130
MIDI Implementation .....	132
MIDI Implementation Chart .....	156
Index .....	157
Specifications .....	164

## ■ How to Use This Manual

### Quick Start

This section explains the basic operation of the **JV-1080**. It covers topics such as setup, methods of play, editing sounds, and saving your data. Be sure to read this section before using your **JV-1080**.

### Chapter 1 — Overview of the JV-1080

This chapter explains the structure of the **JV-1080**'s sound module, as well as Patches, Performances, and Rhythm Sets. Be sure to read this chapter too!

### Chapter 2 — Basic Operation

This chapter explains the basic operation of the panel controls, including how to choose sounds and change parameter settings. This chapter is also required reading.

### Chapter 3 — Modes and Parameters

This chapter describes the various modes and parameters. Refer to it as necessary.

### Chapter 4 — Other Functions of the JV-1080

This chapter describes how to use the **JV-1080** as a General MIDI compatible sound module, how to change its sounds remotely, and how to make use of a variety of controllers. Again, refer to this chapter as necessary.

### Chapter 5 — Multi-Effector EFX

This chapter explains the effects processors (EFXs) and their parameters. This is another chapter that you can refer to when necessary.

### Chapter 6 — Supplementary Materials

This chapter contains information such as an error message list, data lists, MIDI Implementation, and an index. This is a reference section.

# Panel Descriptions

## Front Panel

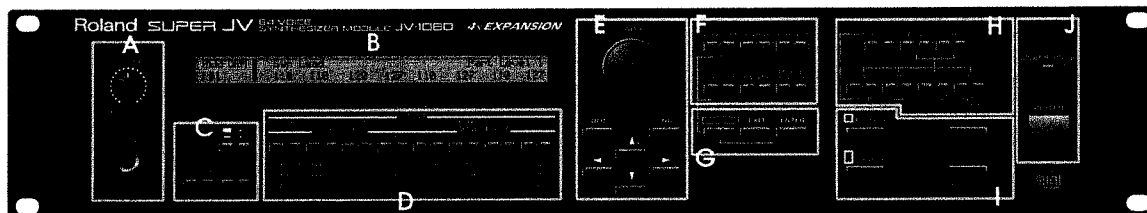

### A.

#### ○ [VOLUME] Knob

This knob adjusts the overall volume output from the MIX OUT and PHONES jacks. The volume from the OUTPUT 1 and OUTPUT 2 jacks cannot be adjusted.

#### ○ PHONES Jack

Connect stereo headphones (Roland RH-20/80/120 or similar) to this jack. (Be sure the headphones you use have an impedance between 8 and 15 Ohms.)

### B.

#### ○ Display

The display indicates a variety of information (selected sounds, parameter values etc.) and operational instructions.

### C.

#### ○ [1-8/9-16] Button

This button switches you between the Part Groups (1—8 or 9—16) that can be selected in the Performance mode or GM mode.

#### ○ [PALETTE] Button

Pressing this button during editing displays a number of Tone (or Part) values for a single parameter.

#### ○ [PARAMETER] Button

Once this button has been pressed, the [FUNCTION SELECT] buttons can be used to select the parameter group you wish to edit.

### D.

#### ○ [FUNCTION SELECT] Buttons

When the [PARAMETER] button is dark, these buttons can be used to select the Tone or Part to be played (TONE SWITCH and PART SWITCH), or to select the Tone or Part to be edited (TONE SELECT and PART SELECT). When the [PARAMETER] button is lit, these buttons can be used to choose a parameter group for editing.

### E.

#### ○ [VALUE] Knob

This knob is used to change the value of a parameter. Rotating the knob while pressing it in causes the parameter value to change more rapidly.

#### ○ [INC] and [DEC] Buttons

These buttons are used for 'fine-tuning' the value of a parameter. Pressing [INC] increases the selected parameter by 1, and each press of [DEC] decreases the value by 1.

#### ○ PAGE Buttons ([▲] and [▼])

Pressing either of these buttons while "↑" or "↓" is shown on the left side of the display causes the display (page) to change. [▲] shows the previous page and [▼] shows the next page.

#### ○ CURSOR Buttons ([◀] and [▶])

These buttons are used to move the cursor (underline) that appears in the display, or to select a command. Press [◀] to move to the left or [▶] to move to the right.

### F.

#### ○ [PERFORM] Button (GM Button)

Press this button to select the Performance mode. Pressing this button while holding down the [SHIFT] button selects the GM mode.

#### ○ [PATCH] Button

Press this button to select the Patch mode. Pressing this button while holding down the [PERFORM] button calls up the Patches assigned to the selected Part.

#### ○ [RHYTHM] Button

Press this button to select the Rhythm Set mode.

#### ○ [SYSTEM] Button

Press this button to set functions that affect the entire JV-1080.

#### ○ [UTILITY] Button

Press this button to write, copy, or perform a bulk dump of data.

## Rear Panel

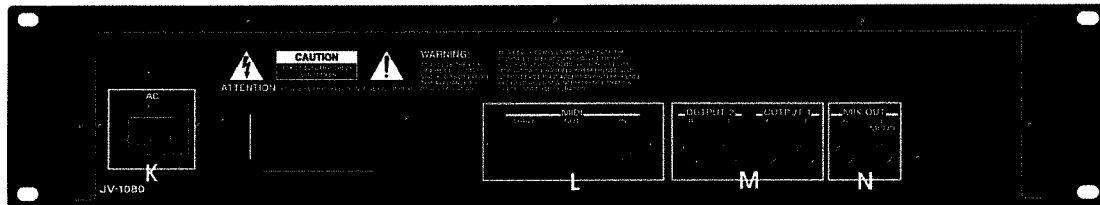

### ○ [EFFECT ON/OFF] Button

Pressing this button displays the effect status (EFX, Chorus, and Reverb ON/OFF). You can use this screen to switch these effects on or off.

### G.

#### ○ [SHIFT] Button

This button is always pressed in combination with another panel button; together they access an additional function.

#### ○ [EXIT] Button

Press this button to return to the previous screen or to 'escape' from the Edit mode to the Play mode.

#### ○ [ENTER] Button

This button is used to confirm or execute a command.

### H.

#### ○ [SOUND GROUP] Buttons

These buttons are used to select the Tone Memory Group; User, Card, Preset, or Expansion.

### I.

#### ○ PCM Card Slot

This slot is for inserting a PCM card (containing additional PCM waveforms).

#### ○ DATA Card Slot

This slot is for inserting a DATA card (for storing or loading Patch data).

### J.

#### ○ MIDI Message Indicator

This indicator lights when MIDI messages are being received.

#### ○ [POWER] Switch

This switch turns the JV on and off.

### K.

#### ○ AC Inlet

Connect the included power cord to this inlet.

### L.

#### ○ MIDI Jacks (IN/OUT/THRU)

These jacks are used to connect the **JV-1080** to other MIDI devices when exchanging MIDI messages. (Special MIDI cables are used.)

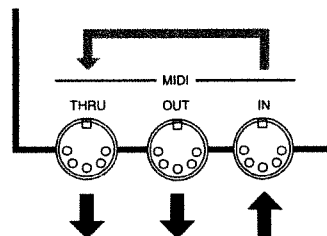

**MIDI IN:** Receives messages from external MIDI devices.

**MIDI OUT:** Transmits messages from the **JV-1080** to external MIDI devices.

**MIDI THRU:** Re-transmits the messages received via MIDI IN.

### M.

#### ○ OUTPUT 1 and OUTPUT 2 Jacks

These jacks are for stereo output of sounds; dry sounds (without effects) or effect sounds only.

### N.

#### ○ MIX OUT Jacks

These jacks are for stereo (L/R) output of the JV's audio signals to an amp or mixer. For monaural output, connect the external device to the L jack.

# Important Notes

In addition to the items listed under Safety Precautions inside the front cover, please read and observe the following:

## ■ Power Supply

- Before connecting this unit to other devices, turn off the power to all units; this will help prevent damage or malfunction.
- Do not use this unit on the same power circuit with any device that will generate line noise; an electric motor or variable lighting system, for example.
- Avoid damaging the power cord: do not step on it, place heavy objects on it, etc.

## ■ Placement

- Do not subject the unit to temperature extremes (e.g., direct sunlight in an enclosed vehicle). Avoid using or storing the unit in dusty or humid areas, or areas that are subject to high levels of vibration.
- Using the unit near power amplifiers (or other equipment containing large power transformers) may induce hum.
- This device may interfere with radio and television reception. Do not use this device in the vicinity of such receivers.

## ■ Maintenance

- For everyday cleaning wipe the unit with a soft, dry cloth or one that has been slightly dampened with water. To remove stubborn dirt, use a mild, non-abrasive detergent. Afterwards, be sure to wipe the unit thoroughly with a soft, dry cloth.
- Never use benzene, thinners, alcohol or solvents of any kind, to avoid the possibility of discoloration and/or deformation.

## ■ Additional Precautions

- Protect the unit from strong impact.
- Do not allow objects or liquids of any kind to penetrate the unit. In the event of such an occurrence, discontinue use immediately. Contact qualified service personnel as soon as possible.
- Never strike or apply strong pressure to the display.
- A small amount of heat will radiate from the unit during normal operation.
- Before using the unit in a foreign country, consult with qualified service personnel.
- Should a malfunction occur, or if you suspect there is a problem, discontinue use immediately. Contact qualified service personnel as soon as possible.
- A small amount of noise may be heard from the display during normal operation.
- To avoid the risk of electric shock, do not open the unit.

## ■ Memory Backup

- This unit contains a battery which powers the unit's memory circuits while the main (AC) power is off. The expected life of this battery is 5 years or more.
- When the battery becomes weak the following message will appear in the display:  
"Internal Battery Low."  
Please change the battery as soon as possible to avoid the loss of memory data.
- Please be aware that the contents of memory may at times be lost; when the unit is sent for repairs or when by some chance a malfunction has occurred. Important data should be stored on a RAM card, in another MIDI device (e.g., a sequencer).
- During repairs, due care is taken to avoid the loss of data. However, in certain cases (such as when circuitry related to memory itself is out of order), we regret that it may not be possible to restore the data.

## ■ Expansion Board

- Never install any circuit board which has not been manufactured and/or approved by Roland.
- Always turn the unit off and unplug the power cord before attempting any circuit board installation.
- Do not touch any of the printed circuit pathways or connection terminals.
- Remove only the specified screws. Carefully handle the components as instructed.
- Never use excessive force when installing a circuit board. If it doesn't fit properly on the first attempt, remove the board and try again.
- When circuit board installation is complete, check your work.





# Quick Start

This section explains basic operation so that you can have the **JV-1080** up and running in a very short time. It should take about an hour to work through the explanations in this section.

---

# 1. Getting Ready to Play

## ■ Connecting with Audio Equipment

The **JV-1080** has no built-in amp or speakers, so in order to produce sound you'll have to use a keyboard amp or audio system, or at least a pair of headphones. Refer to the following connection diagram.

\* No connection cables (such as the **PJ-1M**) are included with this product. These cables must be acquired separately.

- 1** Before making any connections, make sure that all the devices are turned off. This will help prevent damage or malfunction.
- 2** Connect the included AC cord to the inlet on the back of the unit, and plug the other end into an electrical outlet.
- 3** Hook up the audio cables as shown below. If you're going to use headphones, plug them into the **PHONES** jack on the front panel.

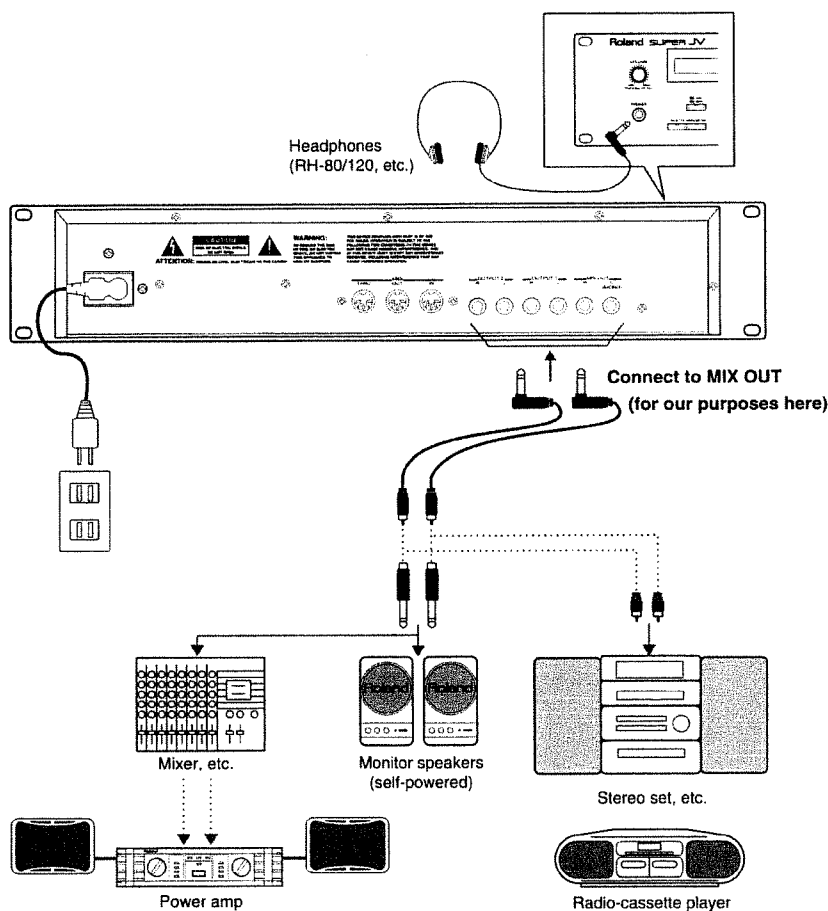

### ● About the Output Jacks

These jacks are for the output of audio signals. You can connect them to monitor speakers, a PA system, or other audio equipment (Ordinarily, you can connect with **MIX OUT**). To get the best sound from the **JV-1080**, we recommend that you use its output in stereo. But if you want monaural output, connect a cable to the **L (MONO)** jack.

---

## ■ Turning On the Power

- 1** Press the [POWER] switch.

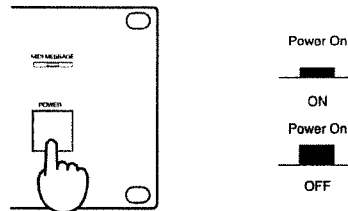

In a few seconds the following display will appear:



- 2** Turn on the stereo, amp, or other audio equipment you've got connected.

\* The JV-1080 contains circuitry protection which momentarily mutes the output stage during power up. The unit will function normally in a few seconds.

- 3** Play something on the JV-1080 and adjust the volume of your equipment. You can play a test (preview) sound by pressing the [VOLUME] knob.

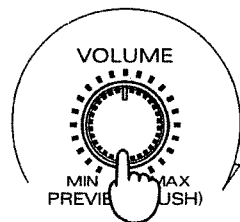

Rotate clockwise to increase the volume

Press to play a test sound

\* You can also change the sound that's played when you press the [VOLUME] knob (see p. 69).

\* Take care when setting volume levels; excessive levels can damage your hearing and equipment.

## ■ Turning Off the Power

- 1** Before switching off the power, confirm the following:

- Are all volume controls set to zero?
- Has all important Tone or Patch data been saved?  
(For an explanation on how to save data, see p. 18.)

- 2** Switch off any amps and other external equipment.

- 3** Switch off the JV-1080.

## 2. Playing the Demo Songs (ROM Play)

The **JV-1080** contains three demonstration songs in its permanent memory. Playing back these demo songs is called "ROM Play." These songs were included to highlight the unit's outstanding sounds and performance capabilities.

\* For song names and profiles of their composers, see page 129.

### ■ How to Listen to the Demo Songs

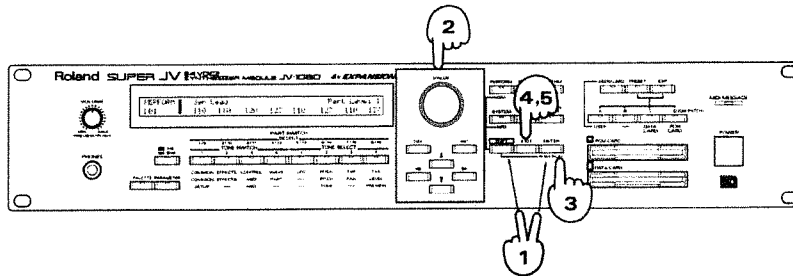

- 1 Hold down the [SHIFT] button and press [ENTER] to select the ROM Play screen.
- 2 Rotate the [VALUE] knob or press [INC]/[DEC] to pick the song you wish to hear. (You can also select "CHAIN PLAY" to hear all of the songs in sequence.)
- 3 Press [ENTER] to start playback.
- 4 Press [EXIT] to stop playback and return to 2.
- 5 Pressing [EXIT] again (while play is stopped) clears the ROM Play screen.

During playback of the demo songs you can change the volume of each Part, as well as the Pan (sound image orientation) settings.

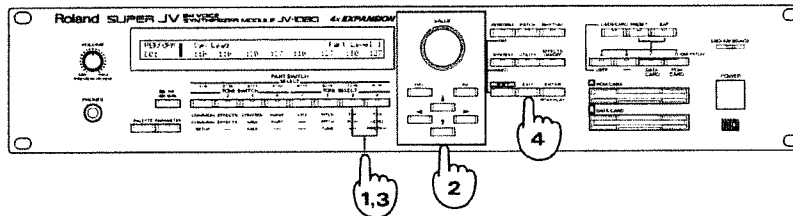

- 1 Pressing the FUNCTION SELECT [LEVEL] button during playback displays the volume level of each Part.
  - \* The eight values on the upper row are for Parts 1-8, while those on the lower row correspond to Parts 9-16.
- 2 Use [1-8/9-16] or [◀]/[▶] to move the cursor to the Part you want to change. You can then use the [VALUE] knob or the [INC]/[DEC] buttons to change the parameters. Note, however, that you cannot save your changes.
  - \* Press [1-8/9-16] to toggle the cursor's position between the upper row (Parts 1-8), and lower row (Parts 9-16). Use [◀]/[▶] to move to the desired Part within the row the cursor is in.
- 3 After you've changed the volume or pan settings for the Parts, press [LEVEL] or [PAN] again to return to the ROM Play screen.
- 4 Press [EXIT] to stop playback.

\* None of the panel buttons — except those described here — will work during ROM Play. Note also that no demo song data is output from the MIDI OUT port.

\* These demo songs are protected by applicable copyright laws. None of these songs may be used in any way — except for demo purposes/personal enjoyment — without the permission of the song's copyright holder.

# 3. Auditioning the Sounds

One of the best ways to play the **JV-1080** is to connect a MIDI keyboard. That way you have all the JV's great sounds at your finger tips!

*\* MIDI cables are not included with this product and must be purchased separately.*

## ■ Connecting a MIDI Keyboard

Switch off the power to all equipment before connecting any MIDI device.

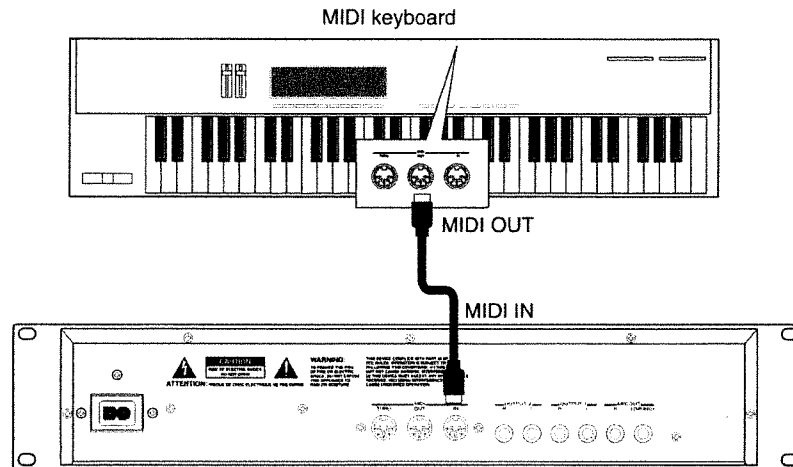

## ■ Selecting the MIDI Channel for Playing the Keyboard

In order for the **JV-1080** to receive instructions (MIDI messages) from your MIDI keyboard, the two devices must be set to the same MIDI channel. In this example, let's set both the JV and the keyboard to MIDI channel 1.

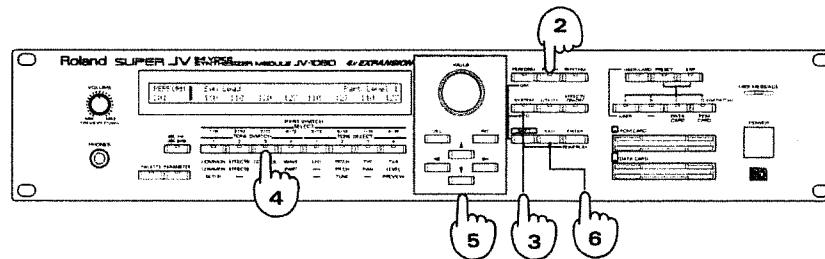

- 1** Set the 'send' channel on the MIDI keyboard to "1."  
*\* If you don't know how to do this, take a look at the manual for your MIDI keyboard.*
- 2** On the **JV-1080**, press the [PATCH] button (so the indicator lights).
- 3** Press the [SYSTEM] button on the **JV-1080** (so its indicator lights too).
- 4** Press the FUNCTION SELECT [MIDI] button to display the following screen:



*\* If this screen doesn't appear right away, press [▲] until it does.*

- 5** Use [◀]/[▶] to move the cursor (the flashing underline) to the number under "Receive Channel." Then use the [VALUE] knob or the [INC]/[DEC] buttons to change the value to "1."
- 6** After you've made the setting, press [EXIT].

## ■ Playing the Keyboard

The **JV-1080** has many on-board sounds. Try listening to some of these sounds by changing the Tones (Patches) during normal play.

- 1** Press [PATCH] (so the indicator lights).

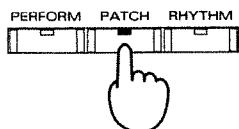

- 2** Play a key on the MIDI keyboard to hear a sound.

- 3** Rotate the [VALUE] knob or press [INC]/[DEC] to switch to the next sound.

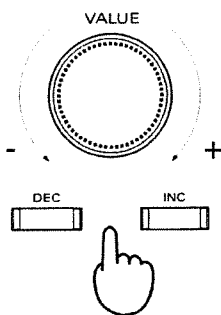

\* The sound groups are: User, Card, Preset (A to D), and EXP (A to D). You can use the SOUND GROUP buttons on the left side of the front panel to select a wide range of sounds (see p. 29).

## ■ Playing a Variety of Percussion Instruments on the Keyboard

The **JV-1080** also has a number of Rhythm Sets that contain a wide array of percussion sounds. If you set the keyboard's MIDI send channel to "10" while in the Rhythm Set mode, you can use the keyboard to play percussion instruments and other special sounds!

- 1** Set the send channel on the MIDI keyboard to "10."

\* If you don't know how to do this, take a look at the manual for your MIDI keyboard.

- 2** On the JV-1080, press the [RHYTHM] button (so the indicator lights).

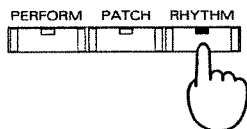

- 3** You can now hear a wide range of percussion sounds when you play the MIDI keyboard! (You'll notice that a different sound has been assigned to each key.)

- 4** You can switch between Rhythm Sets by rotating the [VALUE] knob or pressing [INC]/[DEC].

\* To find out what sound is assigned to each key in each of the Rhythm Sets, refer to the "Rhythm Set List" in the chapter six.

In addition, you can use the **JV-1080** to play Performances made up of a number of Patches. Take a look at "2. Play" (see p. 29) in Chapter 2 and try out for yourself the many possible sound combinations.

# 4. Changing Sounds (Patches)

A “Patch” is the normal unit of play for the **JV-1080**. A Patch is made up of a combination of up to four “Tones.” Quite a few Patches are made up of three or four Tones. To change the various parameters that form a Patch (this is called “Patch editing”), you need to consider the Patch in two ways — as a single entity, and as something made up of individual Tones.

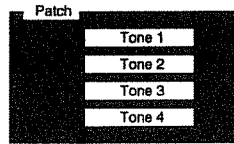

For instance, let’s say that you’re editing the sound of a Patch composed of a single Tone. When you call up the Tone and edit it, then in most cases the sound of the Patch changes just as you expect it to.

But what happens when you edit a Patch composed of a number of Tones? Even when you call up and edit one of the Tones making up the Patch, the overall sound may hardly change at all. In cases like this, you need to call up and edit the remaining Tones one by one, and keep checking the overall sound as you’re editing to make sure that the Tones all balance with each other.

Keeping this in mind, let’s pick a Patch and try editing it.

- 1** Use the procedure described in “■ Playing the Keyboard” (p. 14) to call up a Patch.
- 2** Decide on the Tone that you want to edit.

Make sure that the **PARAMETER** indicator is not lit up. Here’s how the **FUNCTION SELECT** buttons work: the four buttons on the left are used to choose the Tones to be played (“**TONE SWITCH**”), and the four on the right choose the Tones to be edited (“**TONE SELECT**”).

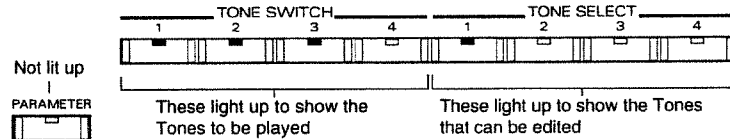

You can press the **TONE SWITCH** [1] to [4] buttons to toggle the four Tones on and off. Listen to each Tone in turn to check out how it sounds.

In this example we’ll edit only Tone 1 as we play it, so press **TONE SWITCH** [1] and **TONE SELECT** [1] to light up each of their indicators.

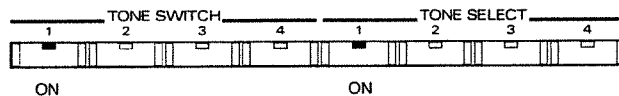

- 3** Choose the Parameter Group that you want to edit.

Press the **[PARAMETER]** button to light up its indicator. Now you can use the **FUNCTION SELECT** buttons to choose the Parameter Group you want to edit.

- 4** Try changing the waveform for Tone 1. Press the **FUNCTION SELECT** [**WAVE**] button.

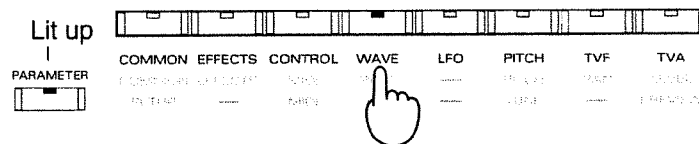

Make sure that the screen shown below appears in the display. If you don't see it, press the [▲] button until it appears.

This shows that Tone 1 is to be edited.

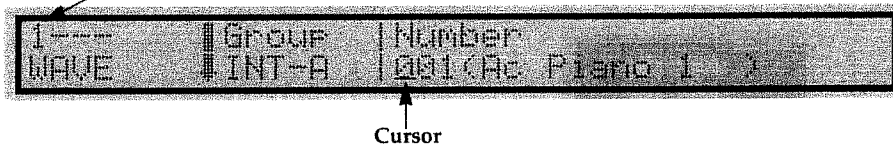

Press [◀]/[▶] to move the cursor to the number underneath "Number." Play the MIDI keyboard to check the sound as you vary the value with the VALUE knob or the [INC]/[DEC] buttons. You will hear sounds with a wide range of waveforms.

**5** Now try changing the effect sounds. Press the FUNCTION SELECT [EFFECTS] button.

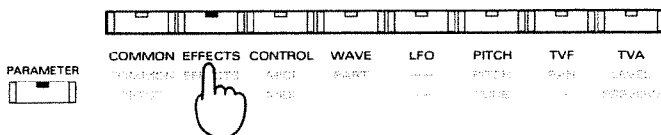

Confirm that the next screen has appeared. If it hasn't, press [▲] until it does.

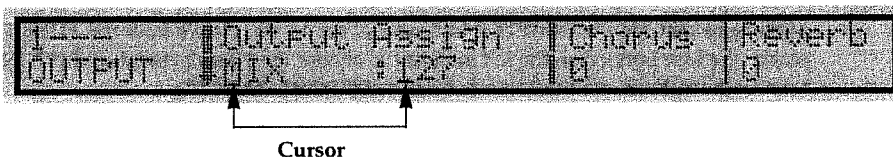

Press [◀]/[▶] to move the cursor to the position shown in the figure, then use the VALUE knob or the [INC]/[DEC] buttons to choose either "EFX" or a number from 1 to 127. Then press [▼].



Turn the VALUE knob or press [INC]/[DEC] as you play the MIDI keyboard. This allows you to obtain a variety of effects.

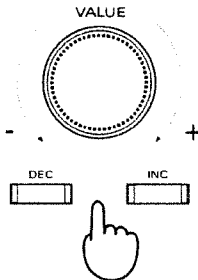

\* If you don't hear any effects, pick another Patch. Note that you won't hear the effect if the master switch for the effect is not turned on (see p. 38).

In this way, you can pick Tones and use the FUNCTION SELECT and [▲]/[▼] buttons to call up Parameters, then use the VALUE knob or the [INC]/[DEC] buttons to change the value at the cursor.

**6** To escape from the Edit screen, press [EXIT] or [PATCH].

\* If you want to save the sound that you've made, follow the procedure in "5. Saving Sounds and Settings" (see p. 18).



The JV-1080 has a wide variety of other editing functions and other handy features. Here are some of the basic ones.

If you want to do this:	The parameter to change is:	The page to see is:
Change the volume of each Tone	Tone Level	☞ p. 55
Change the placement of each Tone in the stereo field	Tone Pan	☞ p. 55
Change the Pitch of each Tone	Coarse/Fine Tune	☞ p. 52
Make a sound harder or softer	Cutoff Frequency	☞ p. 54
Add a stronger “character” to each Tone	Resonance	☞ p. 54
Change the attack time for each Tone	TVA Envelope T1	☞ p. 56
Change the release time for each Tone	TVA Envelope T4	☞ p. 56
Produce an analog synth sound	Analog Feel Depth	☞ p. 56
Change the name of a Patch	Patch Name	☞ p. 42
Return the settings for the JV-1080 to their factory defaults	Factory Preset	☞ p. 74
Make the screen display easier to see	LCD Contrast	☞ p. 66

● **If You Want to Return a Change to Its Original Value...**

If you’re not happy with a change you’ve made with the VALUE knob or the [INC]/[DEC] buttons, you can return a setting to the value first indicated by the cursor by quickly pressing the VALUE knob two times. Each press of this knob toggles the setting between the values before and after the change. This is called the “Undo/Redo” function.

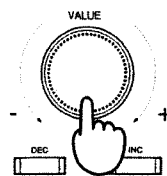

Each press of the knob toggles between the values before and after change  
Press twice

\* If you want to know more about other operations, see the list of operations at the end of this manual, or turn to the explanations of the parameters starting in Chapter 3.

# 5. Saving Sounds and Settings

Any sound you've created will be lost if you turn off the power or switch to a different sound. You can save the sounds you've made in the built-in User Memory or on a DATA Card (sold separately). The process of saving a sound is called a "write operation."

- 1** Press the [UTILITY] button to light up the indicator.

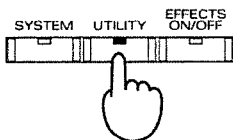

- 2** Utility Menu 1 appears in the display.

Press the FUNCTION SELECT button that is under "WRITE" in the display to call up the Write screen.

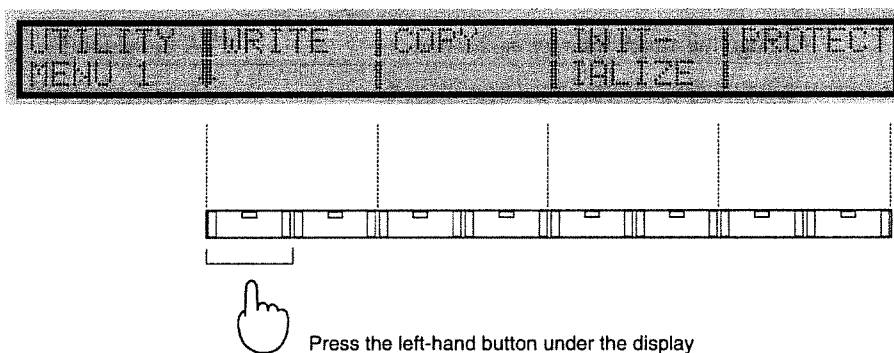

- 3** Use the VALUE knob or the [INC]/[DEC] buttons to choose the write destination.

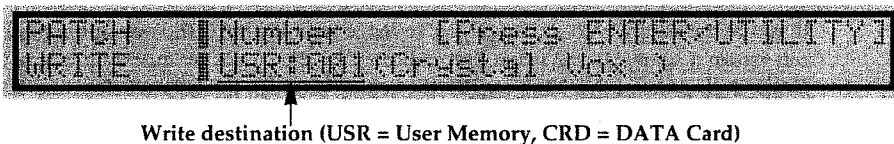

Turning the VALUE knob while pressing it inward causes the value to change more rapidly.

\* If you press [UTILITY] while at step **3**, the following screen appears.



While this screen is shown, you can play a MIDI keyboard to confirm the sound for the write destination.

Press [UTILITY] again to return to the Write screen.

- 4** Press the [ENTER] button to perform the write operation.

To cancel, press [EXIT].

\* The message "User Memory Write Protected" may appear when executing a write operation. This message means that the write destination is write-protected, and cannot be written to (see p. 72). If this happens, you can press [UTILITY] to override the write-protect and force the data to be written.

- 5** When the write operation is finished, the message "COMPLETE" appears, and you will then see the Play screen for the write destination.



# Chapter 1

## **Overview of the JV-1080**

This chapter will give you a good understanding of the organization and terminology of the **JV-1080** before getting into the actual details of parameters.

---

# 1. Units of Sound

The **JV-1080** has a wide array of functions and a large number of parameters. In order to provide more efficient control over the variety of sound types, they are grouped into several units.

## ■ The Smallest Units of Sound — Tones

The smallest unit of sound on the **JV-1080** is called a "Tone." A single Tone functions much like a conventional synthesizer. However, you can't play individual Tones. The smallest unit of sound that can be played on the **JV-1080** is the Patch, and Tones should be viewed as the "sound ingredients" that make up a Patch.

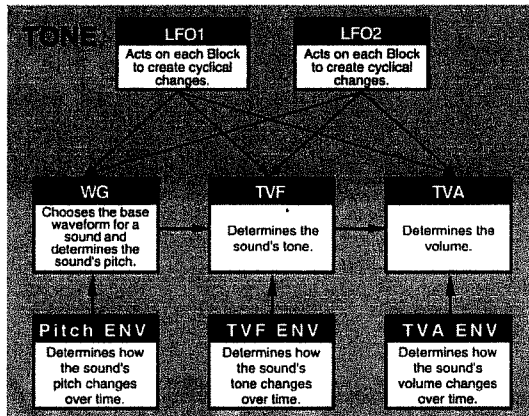

The PCM waveforms (or "waves") stored in internal memory are acted upon in different ways depending on the settings for the filters and envelopes. Waves come from a variety of sources — from acoustic instruments like a piano or saxophone, from vintage synthesizers like the D-50 or JP-8, or from drums and other percussion instruments. Some can originate as sawtooth or rectangular waveforms, while others are looped sounds or are special effects containing certain components of instrument sounds (such as guitar fret noise, piano hammer sounds, and so on). In addition to these, you can install a PCM Card (available separately) or Expansion Board (also sold separately) to obtain new waves.

## ■ Combinations of Tones That Make Sounds — Patches

The unit of sound for normal play on the **JV-1080** is the Patch.

One Patch is a combination of up to four Tones. This means that editing a Patch involves not just making a single sound, but also requires combining a number of sound ingredients to make the sound.

A Patch can be made up of only a single Tone, but fresher, more complex sounds can be created by using a number of Tones. The Preset Patches included when the **JV-1080** was shipped from the factory contain not only fat sounds created by layering several Tones, but also a large number made through sophisticated sound creation, including those that play different Tones in different registers, and those that play different Tones depending on how hard the keyboard is struck. The Patch Parameters also include a full set of "tools" to make the best use of these components, including effects, output panning, and many others that control how a sound is played.

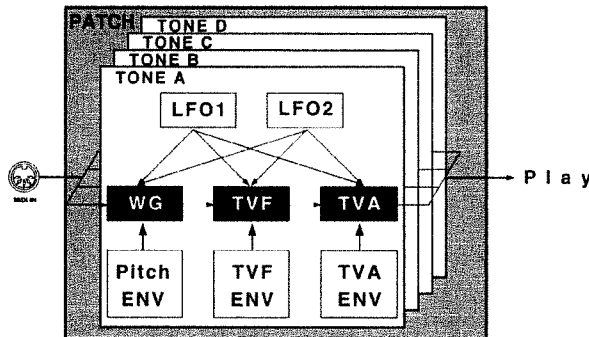

With the **JV-1080**, you can also use a parameter called “Structure” to create sounds with pairs of Tones. See “1. Patch Edit Mode” in Chapter 3 (p. 43) for details.

## ■ Play Percussion Instruments Assigned to Each Key — Rhythm Sets

Each Rhythm Set has a number of percussion instrument sounds assigned to it. Each of these percussion sounds is called a “Rhythm Tone.” Because there is no need for a Rhythm Set to control high and low pitch, as with ordinary sounds, a Rhythm Tone is assigned to each key (in other words, each MIDI note message).

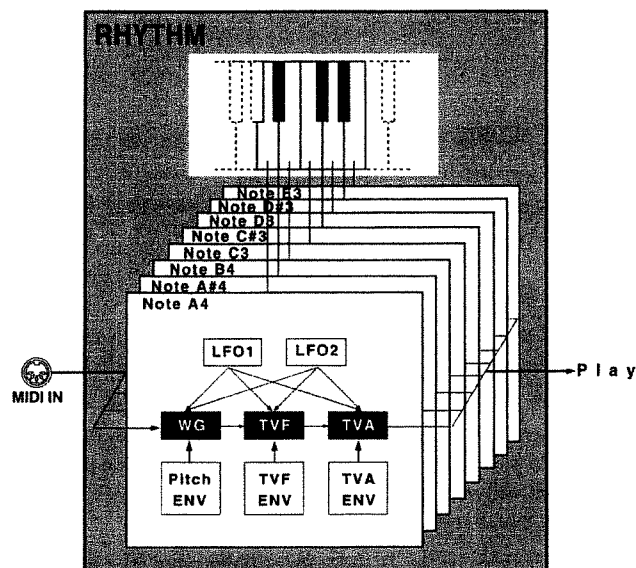

When you play keys on the synthesizer or other instrument connected to the JV-1080, you’ll hear the same sound at different pitches if you’re using a Patch, but if you’re using a Rhythm Set then each key plays a Rhythm Tone with a completely different sound. Rhythm Tones in a Rhythm Set differ from the Tones of a Patch in a very important way — you can’t combine them to create a single percussion sound.

## ■ Assigning Patches and a Rhythm Set Equivalent to 16 Devices — Performances

A Performance is composed of 16 Parts, each of which is in turn assigned a Patch or Rhythm Set. These 16 Parts can be used in combination for ensemble play. One of these 16-Parts is for the exclusive use of a Rhythm Set, and the other 15 are assigned with Patches. What this means is that you can use the **JV-1080** like 16 different sound modules. This kind of synth, one that can function like a number of different sound modules, is called a “multi-timbral sound module.”

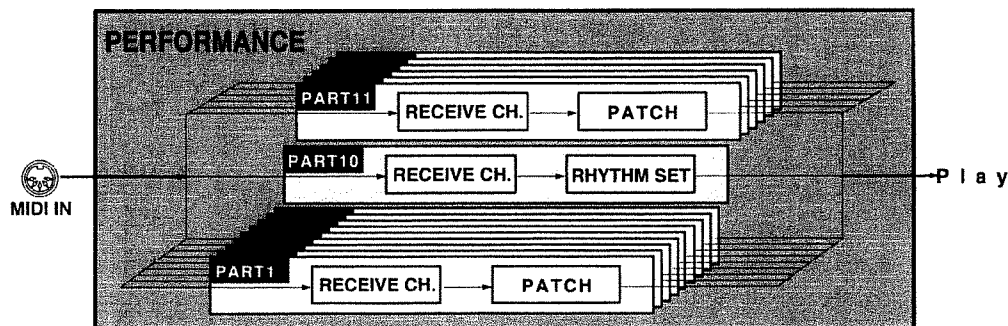

\* Patches are assigned to Parts 1 to 9 and 11 to 16, and a Rhythm Set is assigned to Part 10.

---

Another important role of a Performance is to perform some of the overall functions of sound mixing, such as determining how to balance the audio output with effects from the various Patches, and deciding which jacks to use for output.

### ● Performers of Patches and a Rhythm Set — Parts

You can think of a Part as one of 16 boxes in a Performance that is used to hold a Patch or Rhythm Set. These Parts can be used to turn the **JV-1080** into a multi-timbral sound module.

It may help to think of the Parts as performers, and the Performance as the entire orchestra. The orchestra (Performance) can play different works by having different instruments (Patches and Rhythm Sets) assigned to the different performers (Parts).

## ■ Using Performances

You've been told that the **JV-1080** orchestra has 16 performers. Then who is the conductor of this orchestra?

It's you — the live-stage keyboard player! You can also have a sequencer or computer (DTMS) substitute for you. This section explains a typical method of using Performances.

### ● Using the JV-1080 Live on Stage

On a live stage, there aren't all that many occasions for ensemble play with multiple Parts. Normally just one Part is used, often with changes in the Patches used for playing made during the performance. In cases like this, there is no special need to be aware that the **JV-1080** is a multi-timbral sound module.

Sometimes, though, you may want to use a keyboard that can control more than one sound module Part. For instance, you might want to play the bass line with the left hand and the piano part with the right. Or even if you control just one Part with the keyboard, you might want to have a sequencer control the other Parts to make your setup a one-man band.

If you want to use the Performances of the **JV-1080** for sophisticated live play, see "Live Performance Techniques" (see p. 79).

### ● Using the JV-1080 as a Sound Module Expanding a Desktop Music System (DTMS)

One big obstacle that probably every DTMS user runs into is an inadequate number of sounds that can be played at the same time. The **JV-1080** can play 64 sounds simultaneously, which is double that of many previous DTMS sound modules. This ensures ample response for majestic orchestrations and piano keyboard runs with the damper pedal depressed. The **JV-1080** also supports the General MIDI System, the de-facto standard for DTMS sound modules. This means that you can play back any of the rich array of existing music data (GM scores) with even better sound quality.

If you want to use your unit with DTMS, see "Using the **JV-1080** with a DTMS" (see p. 76).

# 2. Sound Module and Memory

The preset memory stores 32 types of Performances, 128 Patches, and two Rhythm Sets (the preset C/D has only Patches and Rhythm Sets). There are also PCM Cards and Wave Expansion Boards available separately that contain data for more Patches and Rhythm Sets. You can't rewrite the contents of these memory devices, but you can read the data stored on them and store it in User Memory or on a DATA Card.

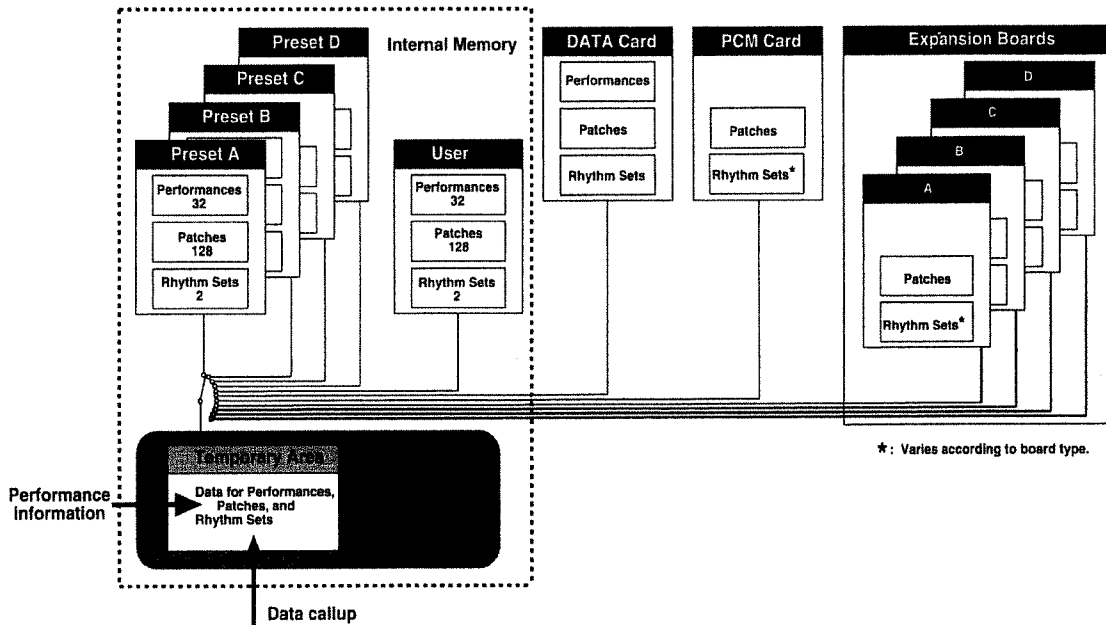

The sound data stored in these memory devices is first read into a temporary area and then played. When editing as well, the sound data called into the temporary area is changed.

\* The data in the temporary area is lost if you change Patches or switch off the power. If you want to save this data, you need to perform a write operation (see p. 70).

# 3. Modes on the JV-1080

Parameters on the **JV-1080** are grouped into various blocks depending on their function. These are called “modes.” If you want to change the style or sound of what you play, you need to choose the right mode.

## ■ Patch Modes

### Patch Play Mode (☞ p. 30)

This is the mode for calling up and playing a single Patch. Choose this when you want to play using a single sound.

### Patch Edit Mode (☞ p. 42)

This is the mode for synthesizer sound creation. Choose this mode to set various parameters that determine the sound and create your own original Patches.

## ■ Performance Modes

### Performance Play Mode (☞ p. 30)

This is the mode for calling up and playing a single Performance. Choose this mode if you want to hook up a sequencer for automatic ensemble play, or if you want to play fat sounds with multiple Patches.

### Performance Edit Mode (☞ p. 57)

This mode is used to allocate Patches and a Rhythm Set to the 16 Parts. Choose this mode to create thick sounds with multiple layered Patches or to make settings for ensemble play.

## ■ Rhythm Set Modes

### Rhythm Play Mode (☞ p. 30)

This mode is for calling up and playing the Rhythm Set assigned to Part 10 of a Performance. Choose this mode when you want to hook up a MIDI keyboard and play it as a percussion instrument.

### Rhythm Edit Mode (☞ p. 61)

This mode is for changing the settings for the Rhythm Set assigned to Part 10 of a Performance. Choose this mode when you want to change the sequence or sound of a rhythm, or to create a new Rhythm Set.

## ■ GM Modes

### GM Play Mode (☞ p. 30)

This mode is for playing that uses GM sounds. Choose this mode if you want to connect a computer or sequencer and play back GM scores (song data for GM sound modules).

### GM Edit Mode (☞ p. 77)

This mode is for changing the settings for GM Parts. Choose this mode to determine the sounds assigned to each of the 16 Parts and make settings for volume, effects, and so on.

## ■ System Mode (☞ p. 66)

This mode is for tuning the JV-1080, adjusting the brightness of the display, manipulating MIDI receive switches, and setting common parameters for the Patch, Performance, Rhythm Set, and GM modes.

## ■ Utility Mode (☞ p. 70)

This mode is for managing the data used in the Patch, Performance, Rhythm Set, and GM modes. It lets you do things like store sounds that have been edited and copy portions of data.



# 4. About the Effects

The effects built into the JV-1080 are grouped into the following three systems.

- A. EFX (a multi-effector with 40 effect types)
- B. Chorus (an effect that makes sound fatter and broader)
- C. Reverb (an effect that adds lingering reverberations to a sound)

The EFX provides distortion, delay, and many other effect types, including combinations of single effects. The EFX also has effect types named "Chorus" and "Reverb," but these can be applied separately from the Chorus (B) and Reverb (C) listed above.

Here's how to use the effector in the different modes:

- **In the Patch Mode**

You can set EFX, Chorus, and Reverb for each Patch. Also, by changing the level of the signal sent to each effect (the "send level"), you can vary the amount of effect applied to the Tone (see Fig. 1).

Figure 1— In the Patch Mode

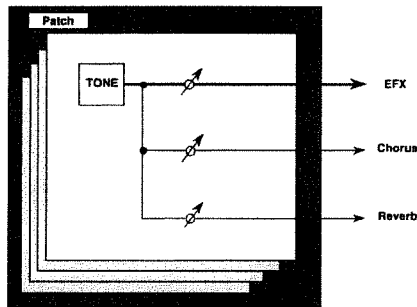

- **In the Performance Mode or GM Mode**

This lets you set EFX, Chorus, and Reverb for each Performance or the GM mode. The amount of effect applied is set for each Part (Fig. 2), and you can make the send level of a Tone effective by changing the settings (Fig. 3). The effect settings for the Patches assigned to each Part are ignored, but you can take the EFX applied to a Patch in a certain Part and apply it to the entire Performance.

Figure 2 – When Output Assign is set to "EFX" in the Performance mode (the output settings for Tone are ignored)

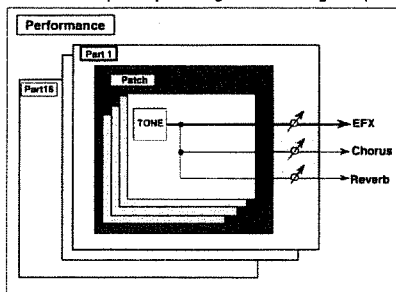
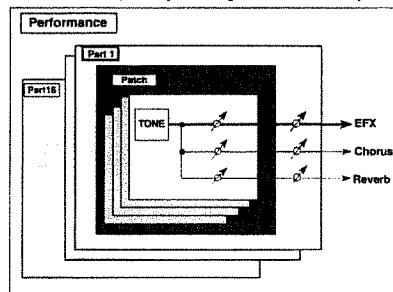

Figure 3 – When Output Assign is set to "Patch" in the Performance mode (the output settings for Tone are valid)



- **In the Rhythm Set Mode**

Because the Rhythm Set mode calls Part 10 of the Performance to the screen, the effect settings reference the settings for the Performance in the temporary area.

# 5. Concerning Tone Editing

The **JV-1080** provides the tools which allow you to create some excitingly realistic sounds. However, it is important to remember that a complex PCM waveform serves as the foundation for every sound, and if you attempt to edit without regard for the characteristics of the original waveform, you may not obtain the results you expect.

## ● Types of Waveforms

The waveforms in the internal memory of the **JV-1080** can be classified into the following two types.

**One-shot Waveforms:** These waveforms contain sounds that have short decays. A one-shot waveform records the initial rise and fall of the sound. Some of the **JV-1080**'s one-shot waveforms are sounds that are complete in themselves, such as percussive instrument sounds. The **JV-1080** contains many other one-shot waveforms that are only partial elements of sounds, however. For example, attack components such as the sound of a piano hammer or the fret noise of a guitar.

**Looped Waveforms:** These waveforms contain sounds that have long decays. With looped waveforms, the latter part of the sound is generated repeatedly over a specified portion of the waveform for as long as the note is held. (Looping allows the wave memory to be used more efficiently.) The looped waveforms in the **JV-1080** provide the sustain portion (i.e., the main body of the sound) for many different instruments.

The following diagram shows an example of a sound (electric organ) that consists of a one-shot waveform used together with a looped waveform.

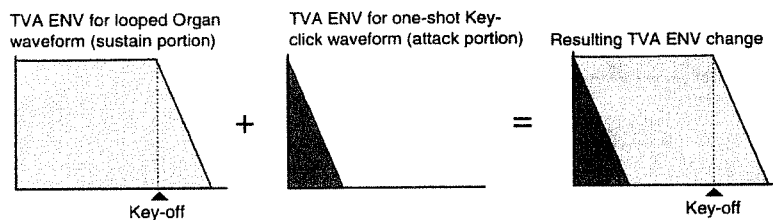

## ● Caution when editing a Tone that uses a one-shot waveform

An envelope cannot be used to give a one-shot waveform a longer decay than the original waveform, or make it a sustaining sound. Even if you made such envelope settings, you would simply be controlling a non-existent portion of the sound, so such settings would have no meaning.

## ● Caution when editing a Tone that uses a looped waveform

With many instruments (including piano or sax) the timbre changes dramatically during the first few moments of the note. It is this initial "attack" that defines much of the character of the instrument. The **JV-1080** provides a variety of waveforms containing lifelike acoustic instrument attacks. To obtain the maximum realism when using these waveforms, it is best to leave the filter completely open during the attack. That way, all the complex timbral changes can be heard. For the sustain and decay portion of the sound, you can use the envelope to produce the desired changes. Should you use the envelope to modify the attack portion as well, the natural attack contained in the waveform itself will not be heard to full advantage, and you may not achieve the result you expect.

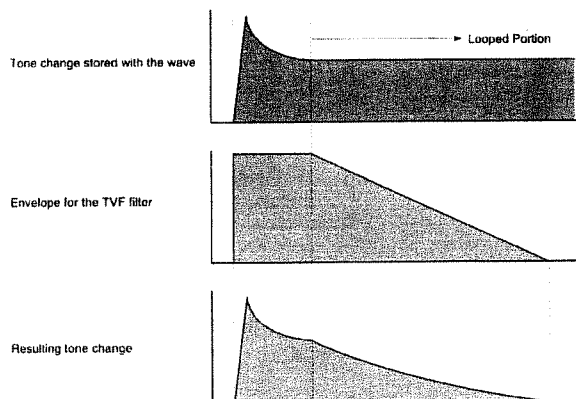

You also need to keep the timbral character of the original waveform in mind when you wish to use the TVF filter to brighten just the attack or subdue only the decay. In particular, if you hope to brighten part of the sound to a brightness greater than the original waveform (refer to "FXM" p.50), you will have to create new upper-range partials that were not present in the original waveform. If you wish to make the entire sound brighter than the original waveform, you should start by adjusting the enhancer or equalizer before you edit the TVF parameters.



# Chapter 2

## Basic Operation

This chapter explains the basic operations you need to use the JV-1080.

---

# 1. Choosing a Mode

The **JV-1080** has several **MODE** buttons that are used differently depending on what you want to do.

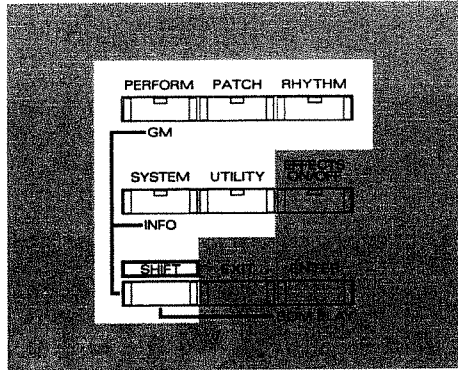

[PERFORM]	Performance mode
[PATCH]	Patch mode
[RHYTHM]	Rhythm Set mode
[SYSTEM]	System mode
[UTILITY]	Utility mode
[SHIFT]+[PERFORM]	GM mode

 When you press a **MODE** button and the indicator lights up, the corresponding screen appears on the display.

\* See "3. Modes on the **JV-1080** in Chapter 1 (p. 24) for a description of the different modes.

See the pages listed below for explanations of the parameters used by each of the modes.

Performance mode	(p. 57)
Patch mode	(p. 42)
Rhythm Set mode	(p. 61)
System mode	(p. 66)
Utility mode	(p. 70)
GM mode	(p. 77)

# 2. Play

This section describes how to work with the sounds built into the **JV-1080** as you play.

## ■ Choosing a Sound

Here's how to call up a sound.

- 1** Press the **MODE** button to select the mode you want.



\* If you press [RHYTHM], it selects the Rhythm Set assigned to Part 10 of the Performance currently in the temporary area.

- 2** Use the **SOUND GROUP** buttons in combination to choose the sound group.

**SOUND GROUP** buttons

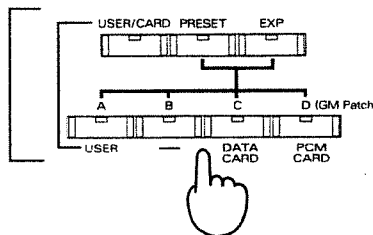

- User Memory
- Preset Memory
- DATA Card (only when installed)
- PCM Card (only when installed)
- Expansion Boards (only when installed)

Top line		Bottom line
[USER/CARD]	->	[USER]
[PRESET]	->	[A] to [D]
[USER/CARD]	->	[DATA]
[USER/CARD]	->	[PCM]
[EXP]	->	[A] to [D]

\* When the **JV-1080** is purchased, the User Memory and Preset contain the same sounds. In addition, the sound mapping in Preset D conforms with GM Instruments.

\* Presets C and D do not function in the Performance mode.

- 3** Turn the **VALUE** knob or press [INC]/[DEC] to pick a sound.

Turning the VALUE knob while pressing it inward causes the value to change more rapidly.

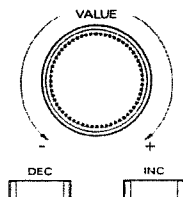

● Patch Play Mode Screen

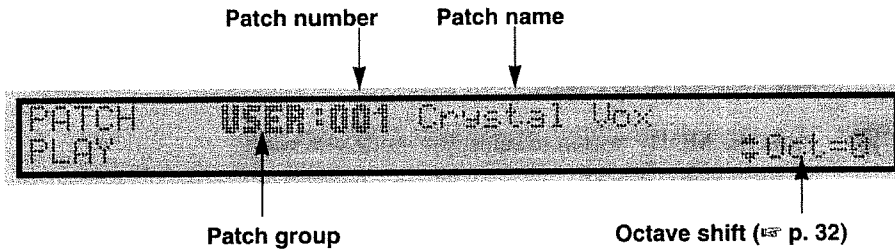

● Performance Play Mode Screen

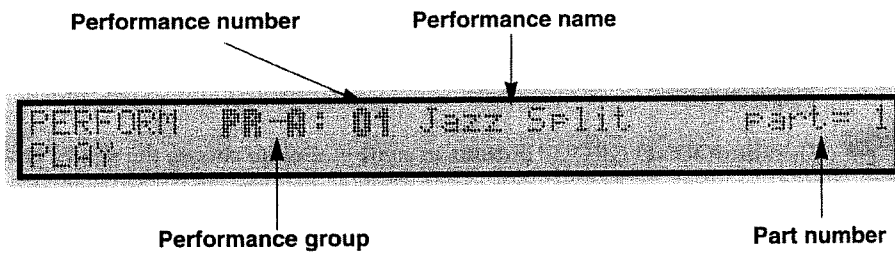

\* You can use the [◀]/[▶] buttons to change the Part number.

● Rhythm Play Mode Screen

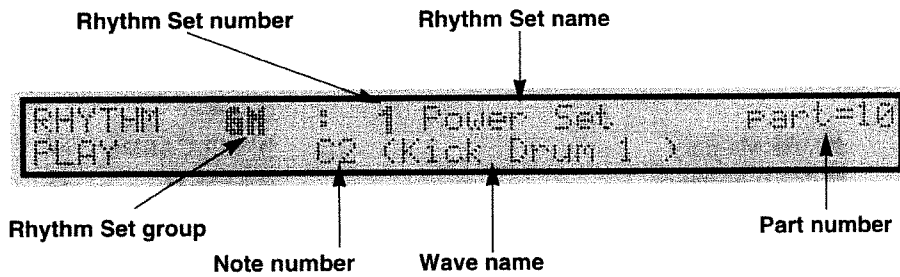

\* When playing a Rhythm Set, see the Performance "CONTROL" page (see p. 59) to set the Receive switch and MIDI channel for Part 10.

● GM Play Mode Screen

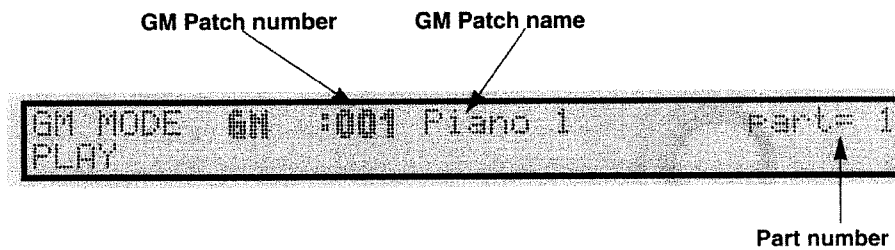

\* You can use the [◀]/[▶] buttons to change the Part number.

## ■ Using Cards and Expansion Boards

When using a separately available PCM Card (SO-PCM1 series) or DATA Card (PN-JV80 series, M-256E, or M-512E), be sure to insert the card face-up into the appropriately labelled slot.

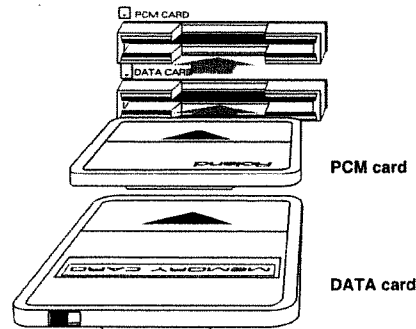

\* Never pull a DATA Card or PCM Card out of the slot while you are playing.

## ● Important Notes on Installing Wave Expansion Boards

When using a Wave Expansion Board (SR-JV80 series, sold separately), be sure to first turn off the power to the **JV-1080** before taking off the top cover and installing or removing the board. When doing this, take care to avoid injury when working with the unit while it is opened.

The installation locations "A" through "D" in the figure correspond to EXP buttons [A] through [D].

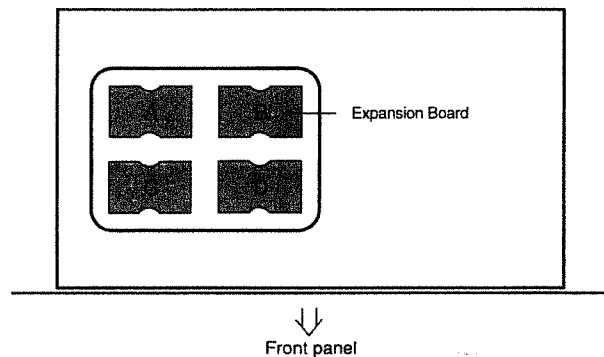

\* Some DATA Cards (such as the PN-JV80 series) may contain patches that use Expansion Board waves. To use such DATA cards when you have multiple Expansion Boards, be sure to install the board that corresponds to the card in the location with the lowest letter of the alphabet.

\* The **JV-1080** can also read patch and rhythm set data stored on DATA cards by the JV-1000/JV-90, JV-80, JV-880. However, while reading in such data the unit also performs a conversion, since there are differences in the way the parameters are organized. As a result, some of this data may sound slightly different than the way it did on the earlier JV unit.

## ■ Choosing the Tones and Parts to Play

To choose the Tones and Parts to be played, first make sure that the indicator for the [PARAMETER] button is not lit up, then use the TONE SWITCH and PART SWITCH buttons under the display.

## ● In the Patch Mode

When the [PARAMETER] button indicator is dark, you can use the TONE SWITCH [1] to [4] buttons to toggle the sound for each Tone on and off.

This is handy when you want to check what Tones the currently selected Patch consists of.

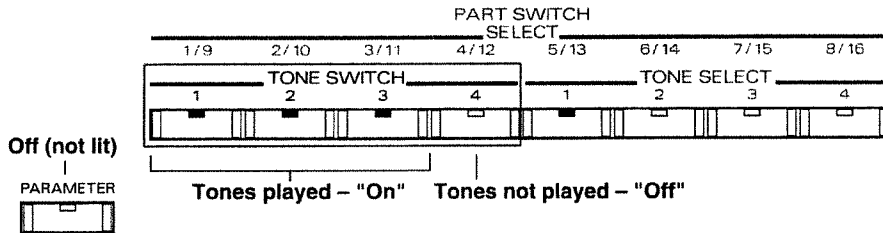

The indicators for the buttons are illuminated when on and dark when off. Each press of a button toggles it on or off.

## ● In the Performance Mode or GM Mode

When the [PARAMETER] button indicator is not lit up, you can press the PART SWITCH [1/9] to [8/16] buttons to select whether each Part receives and plays MIDI information.

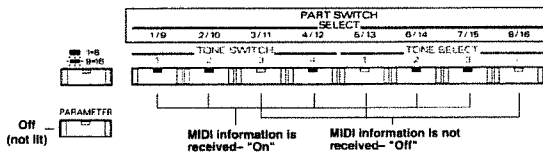

\* The PART SWITCH buttons work only in the Play mode.

The indicators for the buttons are illuminated when on and dark when off. Each press of a button toggles it on or off.

If you want to switch Parts 9 to 16 on or off, first illuminate the indicator for the [1-8/9-16] button, then use the PART SWITCH buttons.

\* During a write operation, the on/off settings for the TONE SWITCH and PART SWITCH buttons are stored respectively as Patch and Performance settings (see p. 70).

## ■ Changing the Pitch of a Sound — Octave Shift

In the Patch Play mode, you can easily change the pitch of an entire Patch. Each press of the cursor [▲]/[▼] buttons shifts the sound up or down by one octave. You can vary the settings by three octaves up or down.

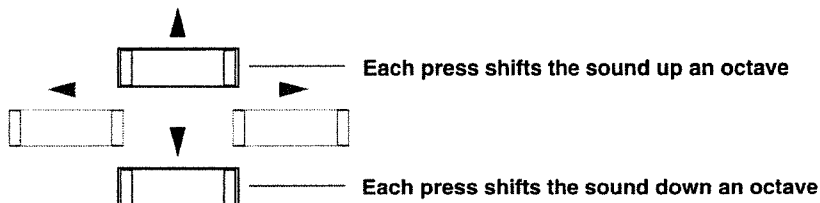

\* When you write a Patch, this parameter is stored as a common parameter.



# 3. Editing

This section explains the operations you'll need to know when editing sound data.

## ■ Entering the Edit Mode

After pressing the [PARAMETER] button and confirming its indicator has lighted, you can use the FUNCTION SELECT buttons to choose a parameter group for editing. When you press the button to select any single parameter group, you enter the Edit mode and the Edit screen for the selected parameter group appears.

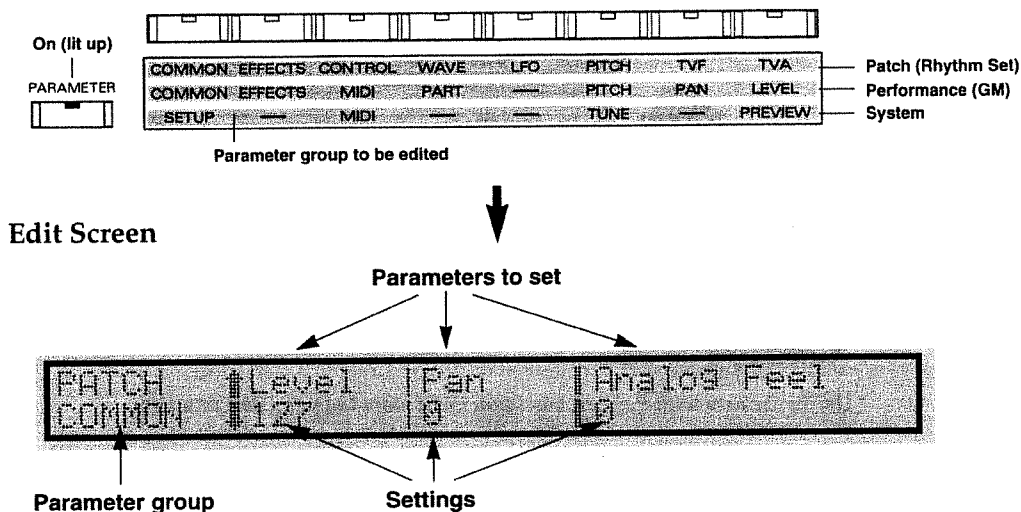

 To return to the Play mode from the Edit mode, press [EXIT] or a MODE button.

## ■ Choosing the Tones and Parts to Edit

To choose a Tone or Part to be edited, first make sure that the [PARAMETER] button indicator is not lit up. Then use the TONE SELECT or PART SELECT buttons under the display to make your selection.

### ● In the Patch Mode

At the Patch Edit screen, a display such as "1—" appears in the upper left part of the screen showing the page for setting the parameters for each Tone. This shows the number of the Tone currently called to the screen. To change the Tone that is called up, press the [PARAMETER] button to make the indicator go dark and then use the TONE SELECT [1] to [4] buttons.

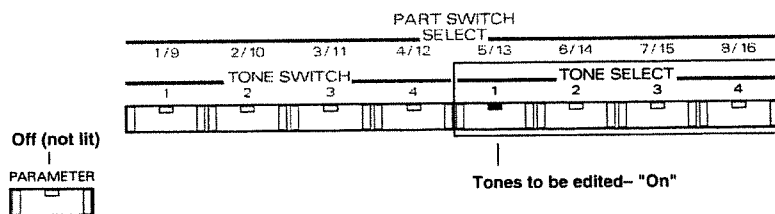

The indicators for the buttons are illuminated when on and dark when off.

If you want to edit more than one Tone at a time, then hold down the button for one of the Tones to be edited and press the button for another Tone at the same time. When you do this, the number for the first Tone selected appears in the upper left part of the screen, and the other tone is indicated by a "\*." This makes it possible to change more than one Tone at the same time while maintaining the differences in their respective values.

## ● In the Performance Mode or GM Mode

At the Performance or GM Edit screen, a display such as "PART 1" appears in the upper left part of the screen showing the page for setting the parameters for each Part. This shows the number of the Part currently called to the screen. To change the Part that is called up, press the [PARAMETER] button to make the indicator go dark and then use the PART SELECT [1/9] to [8/16] buttons.

\* The PART SELECT buttons are active only when the Edit mode is selected.

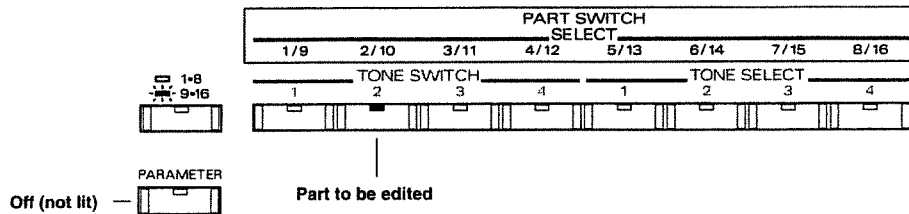

The indicators for the buttons are illuminated when on and dark when off.

If you want to edit a Part from 9 to 16, illuminate the indicator for the [1-8/9-16] button, then use the PART SELECT buttons.

\* Unlike the case with Patches, you cannot edit more than one Part at a time.

## ● In the Rhythm Set Mode

At the Rhythm Set Edit screen, a display such as "C4" appears in the upper left part of the screen showing the page for setting the parameters for each Rhythm Tone. This shows the number of the Rhythm Tone currently called to the screen. To change the Rhythm Tone that is called up, use either of the two methods described below.

- Use the keys on a MIDI keyboard connected to the JV-1080 to make the selection.

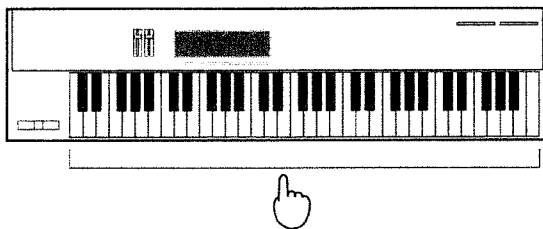

\* If you are using a MIDI keyboard to make your selection, set the System Parameter for Rhythm Edit Key to "PANEL&MIDI" (p. 66)."

- After making the [PARAMETER] button indicator go dark, use the TONE SELECT [1] to [4] buttons.

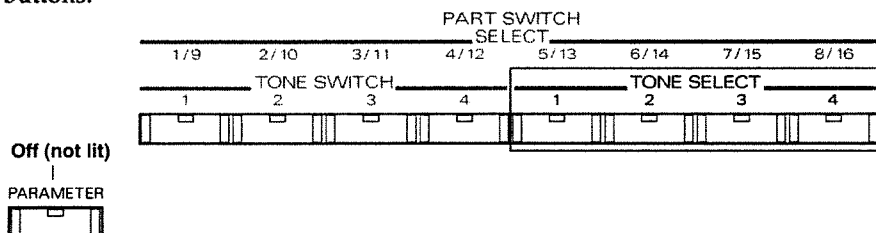

#### TONE SELECT [1]:

Each press of the button changes the note currently displayed to a note one octave lower.

#### TONE SELECT [2]:

Each press of the button changes the note currently displayed to a note one half-step lower.

#### TONE SELECT [3]:

Each press of the button changes the note currently displayed to a note one half-step higher.

#### TONE SELECT [4]:

Each press of the button changes the note currently displayed to a note one octave higher.

*\* The indicators for the TONE SELECT buttons are always dark in the Rhythm Set Mode.*

## ■ Moving the Cursor and Changing Settings

Use the [◀]/[▶] buttons to move the cursor to the parameter you want to change, then use the VALUE knob or [INC]/[DEC] buttons to change the value.

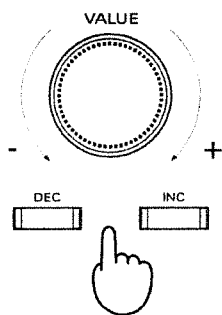

#### The VALUE knob...

Turning the VALUE knob while pressing it inward or while holding down the [SHIFT] button causes the value to change more rapidly.

#### The [INC] button...

Each press of the button increments the number by one (in other words, it takes the number to the next higher value).

#### The [DEC] button...

Each press of the button decrements the number by one (it takes the number to the next lower value).

If you hold down [INC]/[DEC], the number changes continuously. The values change by larger steps if you hold down the [SHIFT] button and press [INC]/[DEC]. The values can also be changed rapidly by holding down one of these buttons and pressing the other one.

*\* If you change a value and then return to the Play mode without executing a write operation, a "\*" appears next to the sound group name on the screen.*

## ● The Handy Undo/Redo Function

If you're not happy with a change you've made, you can return a setting to the value first indicated by the cursor by quickly pressing the VALUE knob two times. Each press of this knob toggles the setting between the values before the change ("undo") and after ("redo").

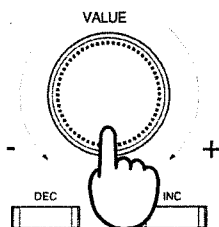

Each press of the knob toggles between the values before and after change  
Press twice

## ■ Changing Pages

On the **JV-1080**, each screenful of parameter settings is called a “page.”

On screens that show a “**▲**” or “**▼**” symbol, you can press the [**▲**]/[**▼**] buttons to change pages.

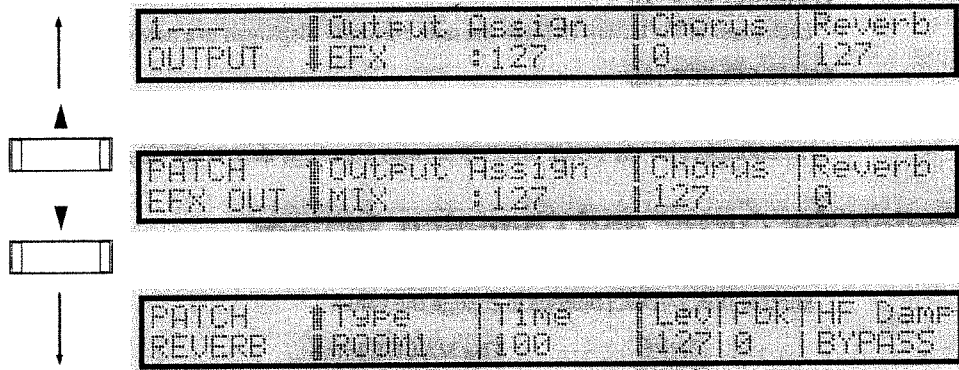

**But that’s not all. If you hold down the [SHIFT] button and...**

...Press [**▲**], you move to the top page of the selected parameter group.

...Press [**▼**], you move to the last page of the selected parameter group.

...Press [**◀**], you move to the page for the parameter group found one to the left of the FUNCTION SELECT buttons.

...Press [**▶**], you move to the page for the parameter group found one to the right of the FUNCTION SELECT buttons.

There are two types of Edit screens:

### Single Edit Screen

Multiple parameters are displayed for a single Tone (or Part, in the case of a Performance)

This is convenient for in-depth editing of a single Tone.

### Palette Edit Screen

The values for four Tones (or Parts) are displayed for a single parameter.

This is convenient for editing while keeping an eye on the balance between several Tones.

When you press [PALETTE] and light up the button’s indicator, you move to the Palette Edit screen for the parameter currently indicated by the cursor. Each press of the [PALETTE] button toggles between the Single Edit and Palette Edit screens.

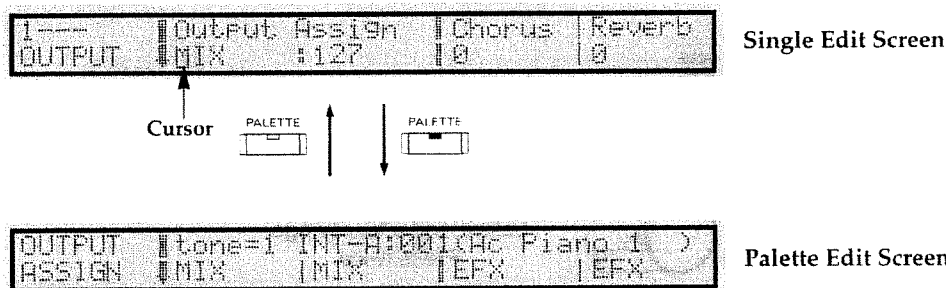

\* The Palette Edit screen does not show anything except the parameters for each Tone (or Part) to be edited. Additionally, no Palette Edit screen is displayed in the Rhythm Set mode.

## ● The Handy Page Changing Function

Several pages are allocated to the FUNCTION SELECT buttons under the display. Each press of the FUNCTION SELECT button (for which the button indicator is currently lit) will toggle you between two of these pages.

You can take advantage of this to compare the parameters of two pages as you edit; or for often-used pages you can press the [▲]/[▼] buttons to switch pages instantly without having to flip through any intervening pages.

Here's how the pages change when you press the FUNCTION SELECT buttons.

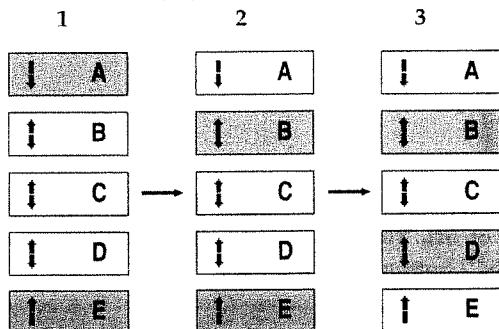

1. When the power is first turned on, each press of the FUNCTION SELECT button toggles you between the first page (A) and the last page (E).
2. If you press [▼] at page A to change to page B, then each press of the FUNCTION SELECT button toggles you between B and E.
3. If you press [▲] at page E to change to page D, then each press of the FUNCTION SELECT button toggles you between D and B.

## ■ Editing a Patch While in the Performance Mode

When editing a Performance, it is easy to call up and edit the Patch assigned to a Part. This is handy when moving back and forth between the Performance mode and the Patch mode to edit a Patch.

**1** Let's say that you are now editing Part 3 of a Performance.

If you want to edit the Patch assigned to Part 3, hold down the [PERFORM] button and press [PATCH].

The indicators for the [PERFORM] and [PATCH] buttons light up at the same time, and the Play screen for the Patch selected for Part 3.

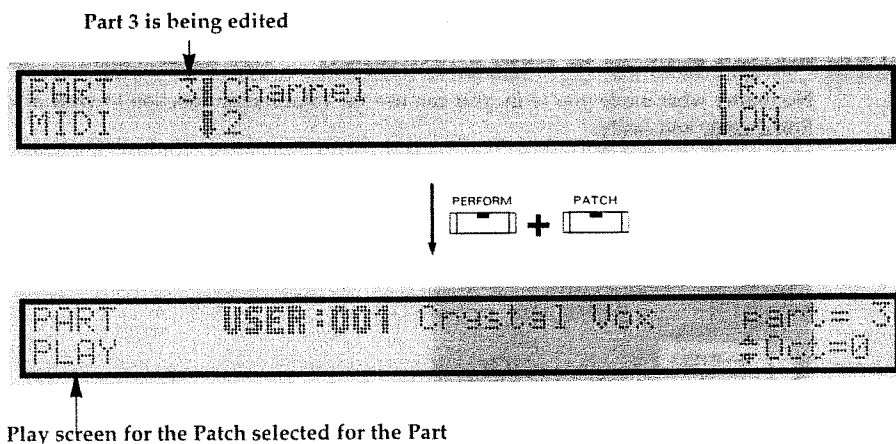

\* You can use the [◀] / [▶] buttons to change the Part.

**2** Edit the Patch just as you would during normal Patch editing.

**3** Press [EXIT] to return to the Performance screen.

## ■ Switching Effects On and Off

This is the switch which determines whether the built-in effects (EFX, Chorus, and Reverb) will be used. You can turn this switch on or off regardless of what mode you may happen to be in.

- 1** Press [EFFECTS ON/OFF] to illuminate the indicator.

The on/off status for the three effects is displayed.

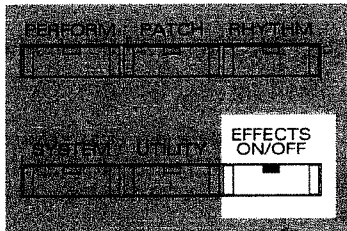

- 2** Press the FUNCTION SELECT button corresponding to the location of the effect on the display to switch that effect on or off. You can also use the CURSOR [◀]/[▶] buttons, the VALUE knob, or the [INC]/[DEC] buttons for switching.

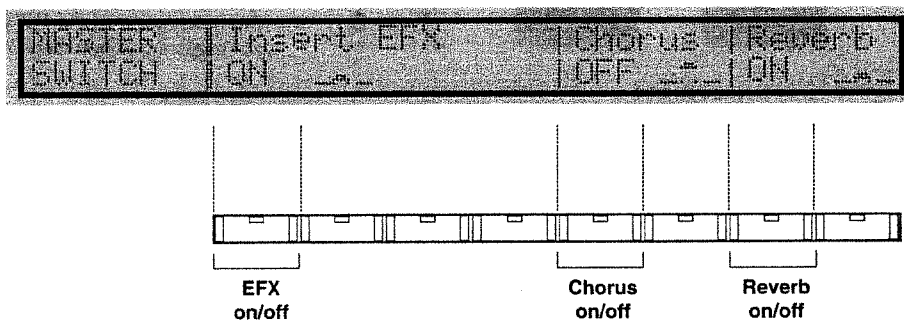

- 3** Press [EXIT] or [EFFECTS ON/OFF] to make the indicator go dark and return to the original screen.

## ■ Confirming Current Settings or MIDI Information — The Information Function

No matter what mode you're in, you can use the Information function to view a wide range of information quickly and easily.

- 1** Hold down the [SHIFT] button and press [INFO].

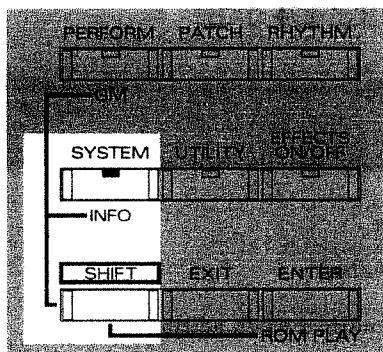

- 2** Use the CURSOR [▲]/[▼] buttons to move to the screen containing the information you want to see.

The following pages are displayed consecutively:

- INFO CARD (names of any inserted DATA or PCM cards)

```
INFO  DataCard=Not Read
CARD  PCM Card=Card 04 Ver1.00
```

- INFO EXP 1 (names of any A or B expansion boards installed)

```
INFO  Expansion Board=JUSG-01 Cop
EXP1  Expansion Board=JUSG-01 Orche
```

- INFO EXP 2 (names of any C or D expansion boards installed)

```
INFO  Expansion Board=JUSG-03 Flana
EXP2  Expansion Board=JUSG-01 Synth
```

- BATTERY CHECK (status of JV-1080 and DATA card batteries: LOW or OK)

```
BATTERY Internal Data Card
CHECK   ON          LOW
```

Also, if you're in the Performance, GM, or Rhythm Set modes, you can check the following MIDI information being received by the Parts. This is useful if you need to check why a sound doesn't change even though MIDI messages should be coming in, or for other MIDI troubleshooting.

- INFO MOD (Modulation: 0 to 127)

```
INFO  0 0 0 0 0 0 0 0 0
MOD   0 0 0 0 0 0 0 0 0
```

- INFO BREATH (Breath: 0 to 127)

```
INFO  0 0 0 0 0 0 0 0 0
BREATH 0 0 0 0 0 0 0 0 0
```

- INFO FOOT (Foot: 0 to 127)

```
INFO  0 0 0 0 0 0 0 0 0
FOOT  0 0 0 0 0 0 0 0 0
```

- INFO VOLUME (Volume: 0 to 127)

```
INFO  127 127 127 127 127 127 127 127
VOLUME 127 127 127 127 127 127 127 127
```

● INFO BALANCE (Balance: 0 to 127)

INFO	64	64	64	64	64	64	64	64
BALANCE	64	64	64	64	64	64	64	64

● INFO PANPOT (Panpot: L64 to 0 to 63R)

INFO	0	0	0	0	0	0	0	0
PANPOT	0	0	0	0	0	0	0	0

● INFO EXPRESS (Expression: 0 to 127)

INFO	0	0	0	0	0	0	0	0
EXPRESS	0	0	0	0	0	0	0	0

● INFO HOLD-1 (Hold-1: OFF/ON)

INFO	OFF	OFF	OFF	OFF	OFF	OFF	OFF	OFF
HOLD-1	OFF	OFF	OFF	OFF	OFF	OFF	OFF	OFF

● INFO AFTER (Aftertouch: 0 to 127)

INFO	0	0	0	0	0	0	0	0
AFTER	0	0	0	0	0	0	0	0

● INFO BENDER (Pitch Bender: -64 to 0 to +63)

INFO	0	0	0	0	0	0	0	0
BENDER	0	0	0	0	0	0	0	0

● INFO VOICE (Voice: 0 to 64)

INFO	0	0	0	0	0	0	0	0
VOICE	64	0	0	0	0	0	0	0

\* Any type of MIDI message for which the RECEIVE MIDI switch (☐ p. 67) is turned off will be ignored. Note also that no MIDI messages at all will be received by a Part for which the MIDI Receive switch (☐ p. 59) is turned off.

**3** Press [EXIT] to go back to where you were before pressing [INFO].





# Chapter 3

## Modes and Parameters

This chapter explains the various parameters that you work with while editing.

---

# 1. Patch Edit Mode

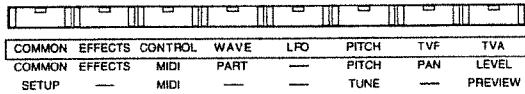

## ■ Making Settings for an Entire Patch (COMMON)

The following parameters are all related to a single Patch.

### ● PATCH NAME

You can give a Patch a name of up to 12 characters. Use the [◀]/[▶] buttons to move the cursor to the proper position, and then rotate the [VALUE] knob or press [INC]/[DEC] to select the desired character.

#### Available characters:

Space, A to Z, a to z, 0 to 9, +-\* / ! = ? < > ( ) [ ] | ; : , ' ' ' # % & \$ ¥ @ ^ \_

Pressing [SHIFT] displays the following in the bottom right corner of the screen.



Hold down [SHIFT] and press any of these...

You can execute the following commands by holding down the [SHIFT] button and pressing the FUNCTION SELECT button that corresponds to the function displayed:

#### TOP:

Press this button to successively go to the first character of the character groups ("A," "a," "0," or "+").

#### END:

Press this button to successively go to the final character of the character groups ("Z," "z," "9," or "\_").

#### DEL:

Pressing this button erases the character under the cursor and shifts the following text forward.

#### INS:

Pressing this button inserts a space at the cursor location and shifts any following text backward.

#### CHG:

Pressing this button switches the character under the cursor from upper to lower case and vice versa.

### ● PATCH COMMON

#### <Level> Patch Level — 0 to 127

This parameter sets the overall volume for the entire Patch.

#### <Pan> Patch Pan — L64 to 0 to 63R

This parameter sets the stereo position of the entire Patch: L64 is far left, 0 is center, and 63R is far right.

\* Although a separate Pan setting is made for each of the Tones that make up a Patch, the stereo position of these Tones is shifted by this overall Pan setting.

#### <Analog Feel> Analog Feel Depth — 0 to 127

This parameter adds a very subtle (yet pleasing) pitch fluctuation to the basic waveform. This helps create a sound that is more natural in nature. (This is also called the "1/f fluctuation").

#### <Octave> Octave Shift — -3/-2/-1/0/+1/+2/+3

This parameter changes the pitch of the Patch in one-octave steps. You can raise or lower the pitch by up to three octaves.

\* When Octave Shift is used in the Patch Play screen, this setting also changes automatically.

#### <Stretch> Stretch Tune Depth — OFF/1/2/3

This parameter changes the pitch using the 'stretch tuning' method typically used on acoustic pianos. This makes high-range sounds slightly higher in pitch, and low-range sounds slightly lower in pitch.

A diagram that illustrates the actual changes in pitch is called a "tuning curve." Changing the tuning curve causes subtle alterations in the resonance of harmonics.

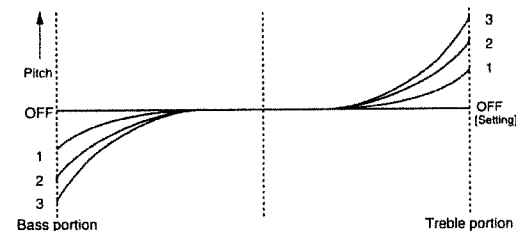

#### <Priority> Voice Priority — LAST/LOUDEST

This setting determines the order or priority of sounds to be played when the maximum number of voices (64) is exceeded.

##### LAST:

The voices played last are given priority, with earlier voices being cut sequentially.

##### LOUDEST:

The voices with the highest volume are given priority, with quieter voices being cut sequentially.

#### <Velocity Range> Velocity Range Switch — OFF/ON

This setting determines whether the Velocity Range setting is enabled ("ON") or disabled ("OFF").

#### <Default Tempo> Default Tempo — 20 to 250 bpm

This parameter determines the tempo clock setting, which controls the parameters for Tones and Effects.

With the JV-1080, you can control Delay Time (and other time-related parameters) with the internal tempo clock or with an external device. When no external tempo clock is used, the tempo set here is used for such control.

\* When using the internal tempo clock, set the clock source system parameter (p. 67) to "INT"

\* The internal tempo clock data is not output through the MIDI OUT port.

### ● VELOCITY (Velocity Range)

#### <Lower> Velocity Range Lower — 1 to 127 [PALETTE]

This parameter determines the maximum range of sound when playing softly. Sound is heard only when playing velocity exceeds the threshold (value) set here.

\* If you try to make this value higher than the setting for Velocity Range Upper, the value for Velocity Range Upper changes at the same time.

<Upper> Velocity Range Upper — 1 to 127

[PALETTE]

This parameter determines the maximum range of sound when playing forcefully. Sound is heard only when playing velocity does not exceed the value set here.

\* If you try to make this value lower than the setting for Velocity Range Lower, the value for Velocity Range Lower changes at the same time.

<X-Fade> Velocity Cross Fade Depth — 0 to 127

[PALETTE]

This parameter sets the fade 'width' between the upper and lower velocity ranges.

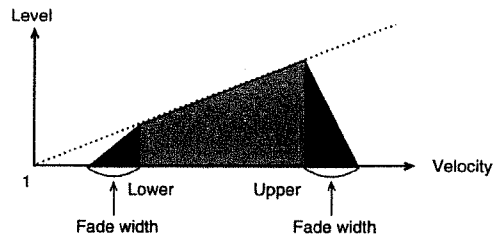

● KEY RANG (Key Range)

<Lower> Key Range Lower — C-1 to G9 [PALETTE]

This parameter sets the key for the lowest playable sound.

\* If you try to make this value higher than the key set for Key Range Upper, the value for Key Range Upper changes at the same time.

<Upper> Key Range Upper — C-1 to G9 [PALETTE]

This parameter sets the key for the highest playable sound.

\* If you try to make this value lower than the key set for Key Range Lower, the value for Key Range Lower changes at the same time.

● STRUCT (Structure)

This parameter determines the structure of the Tones in the Patch. Differences in structure can make the sound vary greatly.

\* With Structure, two Tones are edited as a set. This means that it doesn't matter whether you press TONE SELECT [1] or [2]; in either case, "12—" appears in the left-hand corner of the screen. (With TONE SELECT [3] or [4], "—34" appears.)

\* If you switch off one of the Tones in a pair while TYPE 2-10 is selected, the other Tone is played as TYPE1.

<Struct> Structure — 1 to 10 [PALETTE]

This parameter determines how Tones 1 and 2 or Tones 3 and 4 are combined. The following combination types are possible.

\* Because of space considerations, the characters on the screen are abbreviated. Here's what these abbreviations mean:

- W1 or W2: WG (Wave Generator) 1 or 2
- F1 or F2: TVF 1 or 2
- A1 or A2: TVA 1 or 2
- B: Booster
- R: Ring Modulator

Type 1

With this type, Tones 1 and 2 (or 3 and 4) are independent. Use this type when you want to preserve PCM sounds or create and combine sounds for each Tone.

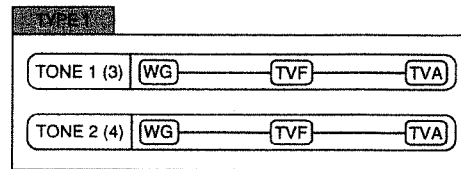

Type 2

This type combines two filters to enhance filter response. The TVA for Tone 1 (or 3) controls the volume balance of the two Tones.

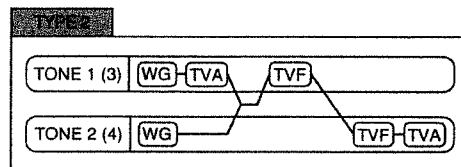

Type 3

This type combines two filters and distorts the waveforms by passing them through the booster (\*\* p. 44).

The TVA for Tone 1 (or 3) controls the volume balance of the two Tones and adjusts the amount of effect that the booster has.

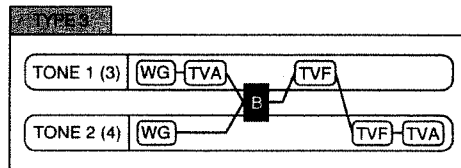

Type 4

This type applies a filter to the mixed sound of Tone 1 (or 3) and Tone 2 (or 4), and distorts the waveforms by passing them through the booster.

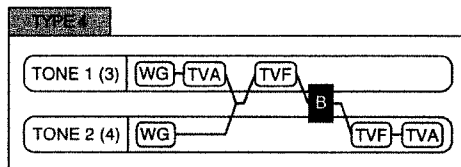

Type 5

This type combines two filters and boosts the upper harmonics by passing the sound through the ring modulator (\*\* p. 44).

The TVA for Tone 1 (or 3) controls the volume balance of the two Tones and adjusts the depth of the ring modulator.

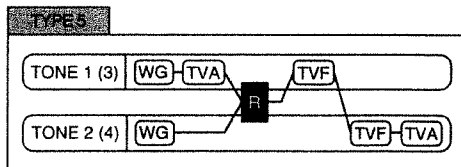

Type 6

This type combines two filters, boosts the harmonics by passing the sound through the ring modulator, and mixes in the sound of Tone 2 (or 4).

Because the sound from the ring modulator and Tone 2 (or 4) can be mixed, the TVA for Tone 1 (or 3) can adjust the amount of ring sound.

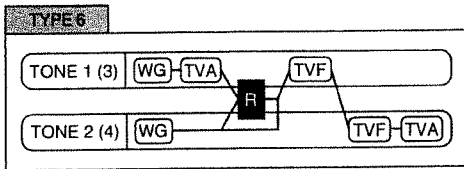

### Type 7

This type sends the filtered sound of Tone 1 (or 3) and the sound of Tone 2 (or 4) through the ring modulator to boost the harmonics.

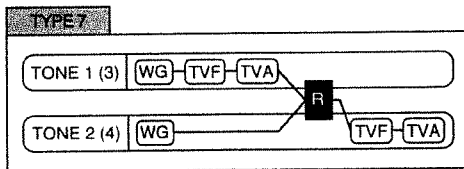

### Type 8

This type sends the filtered sound of Tone 1 (or 3) and the sound of Tone 2 (or 4) through the ring modulator, then mixes it with Tone 2 (or 4) and filters the result.

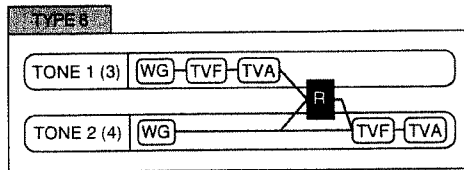

### Type 9

This type sends the filtered sounds of the Tones through the ring modulator to boost the harmonics. The TVA for Tone 1 (or 3) controls the volume balance of the two Tones and adjusts the depth of the ring modulator.

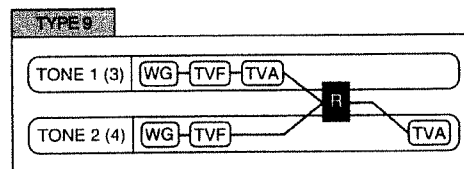

### Type 10

This type sends the filtered Tones through the ring modulator to boost the harmonics, then mixes the result with Tone 2 (or 4). Because the sound from the ring modulator and Tone 2 (or 4) can be mixed, the TVA for Tone 1 (or 3) can adjust the amount of ring sound.

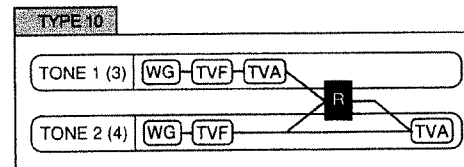

## ○ What is a Booster?

The booster is a circuit that distorts the input signal.

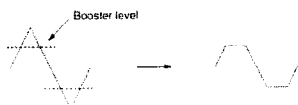

In addition to using this for distortion, effects similar to PWM (Pulse Width Modulation; where the harmonic structure changes continuously) can be obtained by setting the waveform for one Tone (WG1) to a subsonic frequency and shifting the waveform for the other Tone (WG2) up and down. It is also interesting to amplify the waveform with Wave Gain (see p. 50).

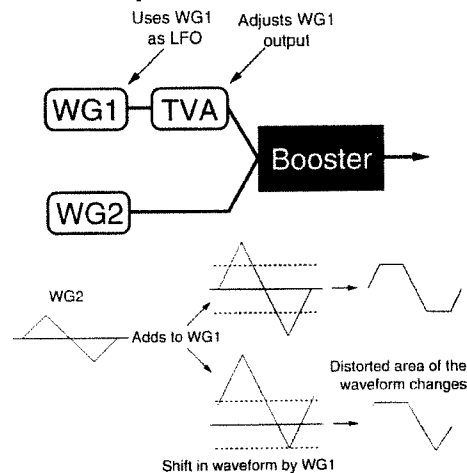

## ○ What is a Ring Modulator?

By combining the waveforms of the two Tones, a ring modulator can produce many harmonics (inharmonic partials) not contained in either of the waveforms. (As long as one of the waveforms is not a sine wave, virtually no frequency components sound at regular intervals.) Because differences in the pitch of the waveform cause the harmonic structure to change, a toneless metallic resonance occurs. This works well when creating metallic timbres, such as for bells.

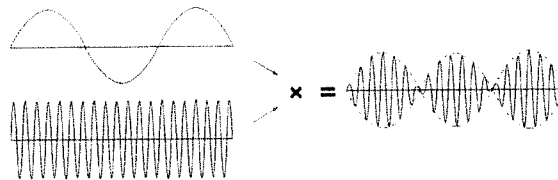

<Booster> Booster Level — 0 / +6 / +12 / +18 [PALETTE]

This parameter sets the booster level; a larger value results in greater distortion of the sound.

## ■ Selecting Effects for a Patch (EFFECTS)

\* When editing the parameters for an effect, an "x" may appear on the left side of the screen. This indicates that the parameters for the effect are being edited while the effect's switch (see p. 38) is off. Because this makes it impossible to check the results of the effect, press the [EFFECTS ON/OFF] button to turn the effect on.

## ● OUTPUT

<Output Assign> Output Assign — MIX/EFX/OUTPUT1/OUTPUT2 [PALETTE]

Output Level — 0 to 127 [PALETTE]

Output Assign determines the output destination for each Tone, and Output Level sets the level of the output signal.

### MIX:

This parameter sends the original sound to MIX OUT. The sound is also simultaneously sent to Chorus and Reverb.

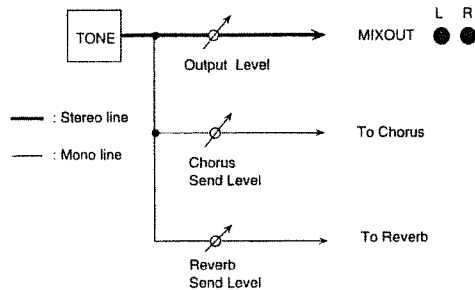

### EFX:

This parameter sends the original sound to EFX. The sound is also simultaneously sent to Chorus and Reverb. The output destination of the sound passing through EFX follows the Output Assign setting for PATCH EFX OUT.

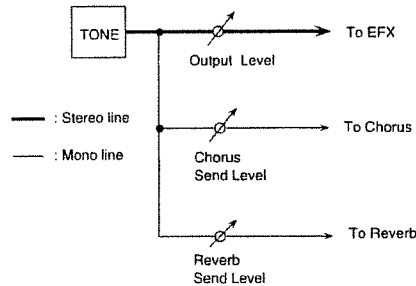

### OUTPUT1:

This setting sends the original sound to OUTPUT1.

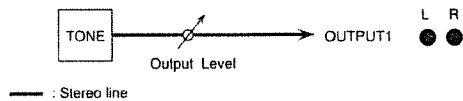

### OUTPUT2:

This setting sends the original sound to OUTPUT2.

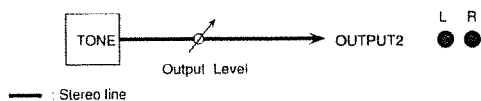

\* When OUTPUT1 or OUTPUT2 is selected as the output destination, all settings for Chorus and Reverb are ignored.

\* When TYPE 2 to 10 is selected with Structure (p. 43), the settings for Tone 1 (or Tone 3) are ignored.

<Chorus> Chorus Send Level — 0 to 127 [PALETTE]

This parameter sets the level of the signal sent to Chorus for each Tone.

<Reverb> Reverb Send Level — 0 to 127 [PALETTE]

This parameter sets the level of the signal sent to Reverb for each Tone.

## ● PATCH EFX TYPE

<Type> EFX Type

This parameter determines the type of EFX applied to the Patch.

For a description of the EFX types, check out "Chapter 5 — Multi-Effector EFX (p. 83)."

## ● PATCH EFX PRM (Patch EFX Parameter)

This setting selects the parameter for the EFX chosen with EFX Type. The parameters that can be set vary from one EFX to another.

For a description of EFX parameters, see "Chapter 5 — Multi-Effector EFX (p. 83)."

## ● PATCH EFX OUT (Patch EFX Output)

This parameter determines how sound will be output when "EFX" is selected with Output Assign for OUTPUT.

<Output Assign> Output Assign — MIX/OUTPUT1/OUTPUT2

Output Level — 0 to 127

Output Assign determines the output destination for the EFX sound, and Output Level sets the level of the output signal.

### MIX:

This setting sends the EFX sound to MIX OUT. The sound is also simultaneously sent to Chorus and Reverb.

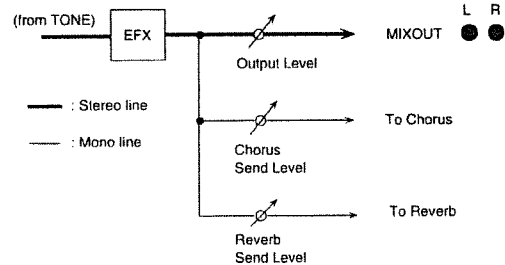

### OUTPUT1:

This setting sends the EFX sound to OUTPUT1.

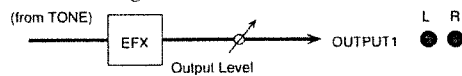

### OUTPUT2:

This setting sends the EFX sound to OUTPUT2.

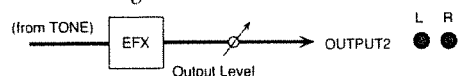

\* When OUTPUT1 or OUTPUT2 is selected as the output destination, all settings for Chorus and Reverb are ignored.

<Chorus> Chorus Send Level — 0 to 127

This parameter sets the signal level sent to Chorus from EFX.

<Reverb> Reverb Send Level — 0 to 127

This parameter sets the signal level sent to Reverb from EFX.

● PATCH EFX CTRL (Patch EFX Control)

The JV-1080 lets you use any one of a number of MIDI Controllers to vary EFX parameters in real time.

\* The number and type of EFX parameters that can be changed is predetermined according to the EFX type. One or two EFX parameters are shown on the top line of the screen, and these vary according to the type of EFX that you choose. For details on the EFX parameters that can be changed, see "Chapter 5 — Multi-Effector EFX (p. 83)."

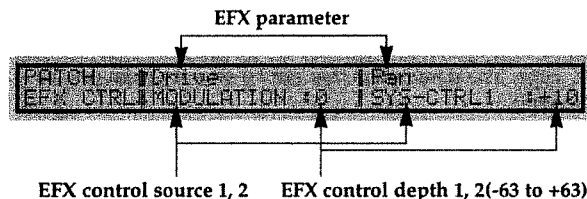

Use EFX Control Source for each of the EFX parameters (that appear on the top line of the screen) to choose a Controller, and set the degree of action of the Controller with EFX Control Depth.

You can choose any of the following as the EFX Control Source:

**OFF:**

No Controller is used.

**SYS-CTRL1:**

The Controller set with System Control Source 1, a system parameter, is used (p. 68).

**SYS-CTRL2:**

The Controller set with System Control Source 2, a system parameter, is used (p. 68).

**MODULATION:**

Modulation (Control Change # 1)

**BREATH:**

Breath (Control Change # 2)

**FOOT:**

Foot (Control Change # 4)

**VOLUME:**

Volume (Control Change # 7)

**PAN:**

Pan (Control Change # 10)

**EXPRESSION:**

Expression (Control Change # 11)

**BENDER:**

Pitch bend

**AFTERTOUC:**

Aftertouch

\* Choose "SYS-CTRL1" or "SYS-CTRL2" if there is no need to use a different Controller for each Patch, or if you want to perform control with something other than the control changes described here. Use the system's Control Assign 1 page to set the Controller (p. 68).

● PATCH CHORUS

<Rat> Chorus Rate — 0 to 127

This parameter sets the speed of the Chorus effect.

<Dpt> Chorus Depth — 0 to 127

This parameter sets the depth of the Chorus effect.

<Dly> Pre delay — 0 to 127

This parameter determines the time interval between when the original sound is heard and when the effect sound is heard. Larger values result in longer delays (creating a broader sound).

<Fbk> Chorus Feedback — 0 to 127

This parameter determines the amount of Chorus sound that is returned (fed back) to the Chorus unit. Larger values result in more complex Chorus effects.

<Level> Chorus Level — 0 to 127

This parameter sets the volume of the Chorus sound.

<Output> Chorus Output Assign — MIX/ REVERB/ MIX+REV

This setting determines how the Chorus sound is output.

**MIX:**

This setting sends the Chorus sound to MIX OUT.

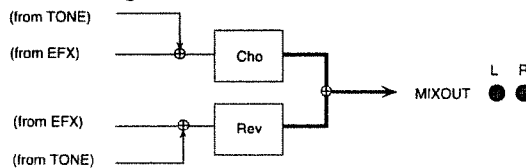

**REVERB:**

This setting sends the Chorus sound to Reverb.

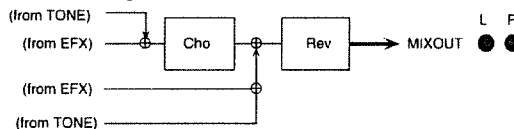

**MIX+REV:**

This setting sends the Chorus sound to both MIX OUT and Reverb.

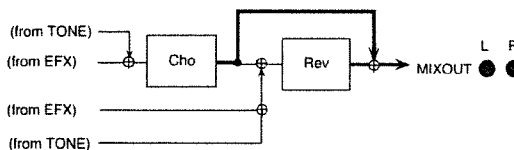

● PATCH REVERB

<Type> Reverb Type

This parameter selects the type of reverberation.

**ROOM1:**

Short, high-density reverb

**ROOM2:**

Short, low-density reverb

**STAGE1:**

Reverb with many late reflections

**STAGE2:**

Reverb with strong initial reflection

**HALL1:**

Sparkling reverb

**HALL2:**

Richly resounding reverb

**DELAY:**

Standard delay

**PAN-DLY:**

A delay that pans (moves) the reflections to left and right.

**<Time> Reverb Time — 0 to 127**

For a type from "ROOM1" to "HALL2," this parameter sets the reverb time (i.e., how long the reverb continues). For "DELAY" or "PAN-DLY," this parameter sets the delay time. Larger values produce a greater sense of spaciousness.

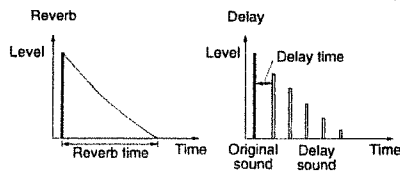
**<Lev> Reverb Level — 0 to 127**

This parameter sets the volume of the reverb sound.

**<Fbk> Delay Feedback — 0 to 127**

When "DELAY" or "PAN-DLY" has been selected as the type, this parameter sets the amount of delayed sound that is returned (fed back) to the Delay unit. Larger values result in longer delay times.

**<HF Damp> High-frequency Damp-200/250/315/400/500/630/800/1000/1250/1600/2000/2500/3150/4000/5000/6300/8000/BYPASS**

This parameter sets the point (frequency) at which the high-frequency components of the reverb sound are cut off.

The HF Damp (high-frequency damp) parameter is used to simulate the acoustic properties of different materials. (For example, glass reflects more high frequencies than heavy carpeting.)

A lower cutoff frequency results in a "darker" sound, and a higher frequency produces a "brighter" sound. When set to "BYPASS," no high frequencies are cut.

## ■ Using Controllers to Change How Sounds are Played (CONTROL)

This selects the functions of the JV-1080's Controllers.

## ● KEY MODE & BENDER

**<Assign> Key Assign Mode — POLY/SOLO**

This parameter determines whether the Patch is played as a polyphonic (POLY) or monophonic (SOLO) sound. Harmonies can be played when set to "POLY," and when "SOLO" is selected, only one sound at a time can be played.

**<Legato> Solo Legato — ON/OFF**

This parameter determines whether the Legato function is used (ON) or not (OFF). However, the Legato function cannot be used when the Key Assign Mode is set to "POLY."

**○ What is Legato?**

When you hold down one key and play another, the Legato function preserves any envelope or LFO, and changes only the pitch played. This makes it possible to emulate guitar techniques such as hammering-on or pulling-off.

**<Bend Range> Bend Range — -48 to 0 (Down)/0 to 12 (Up)**

Bend Range Down lets you set how far the pitch drops when the Bender lever is moved to the left (or when the wheel is lowered). You can set a pitch drop of up to four octaves, in semitone increments. Bend Range Up lets you set how far the pitch rises when the Bender lever is moved to the right (or when the wheel is raised). You can set a pitch rise of up to one octave (in semitone increments).

## ● PORTAMENTO

Portamento is an effect that causes pitch to change smoothly when one played key is followed by another.

**<Sw> Portamento Switch — OFF/ON**

This parameter determines whether the Portamento effect is ON or OFF.

Portamento can be used in the SOLO Key Assign Mode to achieve a smooth 'sliding' effect reminiscent of a violin playing style. Portamento can also be used in the POLY Key Assign Mode (when playing chordal accompaniments).

**<Tm> Portamento Time — 0 to 127**

This parameter determines the time required for the pitch to change from one note to the next when using the Portamento function.

**<Mode> Portamento Mode — NORMAL/LEGATO**

This parameter selects the Portamento mode. Portamento is always applied when "NORMAL" is selected, but when set to "LEGATO," Portamento is applied only when you play in a legato style (with the notes smoothly connected).

**<Type> Portamento Type — RATE/TIME**

This parameter selects the type of Portamento effect. When set to "RATE," the time required to move from the first pitch to the second is proportionate to the distance between the two pitches. When "TIME" is selected, the change takes places over a fixed amount of time (regardless of the pitch interval).

**<Start> Portamento Start — PITCH/NOTE**

This parameter sets the point at which the Portamento effect begins.

This setting controls what happens when a new key is played while a change to another pitch is already in progress. When set to "PITCH," the new portamento sweep starts at the pitch in effect when the new key is played. When set to "NOTE," the new portamento sweep starts from the pitch in effect when the original pitch change is complete.

When Portamento Start is set to "PITCH"

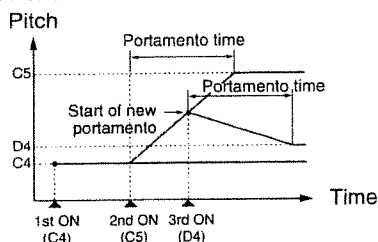

When Portamento Start is set to "NOTE"

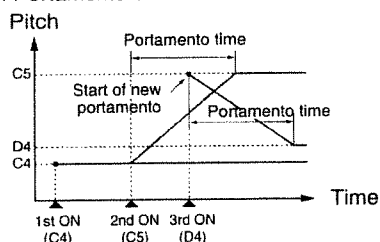

## ● RxSWITCH (Receive Switch)

<Volume> Volume Control Switch — OFF/ON

[PALETTE]

This parameter determines whether volume changes (ON) or not (OFF) when MIDI volume messages for the Tones are received.

\* This setting is ignored when the Volume setting for Receive MIDI, a system parameter, is set to "OFF" (☞ p. 68).

<Pan> Pan Control Switch — OFF/CONT/KEY-ON

[PALETTE]

This parameter determines how MIDI pan messages are received for each of the Tones.

**OFF:**

The stereo position does not change when a pan message is received.

**CONT:**

Pan messages are received and the stereo position changes.

**KEY-ON:**

The stereo position changes when a key is played according to received pan messages. However, even if a new pan message is received while a sound is being played, there is no change in the pan position until the next time a key is played.

\* This setting is ignored when the Control Change setting for Receive MIDI, a system parameter, is set to "OFF" (☞ p. 68).

<Bender> Bender Control Switch — OFF/ON [PALETTE]

This parameter determines whether pitch changes (ON) or not (OFF) when MIDI bender messages for each of the Tones are received.

\* This setting is ignored when the Bender setting for Receive MIDI, a system parameter, is set to "OFF" (☞ p. 68).

\* Ordinarily, volume messages control volume, pan messages control the stereo position, and bender messages control the

pitch being played. With the JV-1080, however, you can use these messages to control other Tone parameters and effects (☞ p. 49). If you attempt this kind of use when the Receive Switches are set to "ON," then the volume, panning, or pitch may change along with the parameter you want to control. To avoid this, be sure to set these switches to "OFF."

## ● DAMPER

<Hold-1 Switch> Hold 1 Control Switch — OFF/ON

[PALETTE]

This parameter determines whether a sound is held (ON) or not (OFF) when MIDI Hold 1 messages are received for the Tones.

\* This setting is ignored when the Hold 1 setting for Receive MIDI, a system parameter, is set to "OFF" (☞ p. 68).

<ReDamper> Re-damper Control Switch — OFF/ON

[PALETTE]

This setting determines (for each of the Tones) whether a decaying sound (the key has been released) is held (ON) or not (OFF) when a Hold 1 message is received.

\* When the Hold 1 Control Switch is set to "OFF," no Re-damper effect takes place even if the Re-damper Control Switch is set to "ON." This setting is also ignored when the Hold 1 setting for Receive MIDI, a system parameter, is set to "OFF" (☞ p. 68).

## ● PEAK & HOLD

With the JV-1080, you can use the hold pedal to sustain not only note messages, but also Control messages (such as modulation or aftertouch) when a Hold message is received.

<EfxCtrl> EFX Control Hold/Peak — OFF/HOLD/PEAK

This setting determines how the value of an EFX parameter to be changed with the EFX Control Source; (☞ p. 46) is maintained when a Hold message is received.

**OFF:**

Hold messages are not received.

**HOLD:**

The parameter value is maintained when a Hold message is received.

**PEAK:**

The parameter value is revised and maintained each time it changes to a new maximum value, even after a Hold message is received.

\* When you select the HOLD or PEAK settings, you will also need to specify what hold pedal information you will be using by means of these System parameters: Hold Control Source, and Peak Control Source (☞ p. 67). Also, you will need to turn ON the Hold 1 Control switch and Receive MIDI switch (System parameter) so you are set for the hold pedal you are using (☞ p. 68).

<Ctrl1> Control 1 Hold/Peak — OFF/HOLD/PEAK

This setting determines how the value of a Tone parameter to be changed with the Patch Control Source 1 (Modulation) is maintained when a Hold message is received. The setting values are the same as those for the EFX Control Hold/Peak setting.

<Ctrl2> Control 2 Hold/Peak — OFF/HOLD/PEAK

This setting determines how the value of a Tone parameter to be changed with the Patch Control Source 2 is maintained when a Hold message is received. The setting values are the same as those for the EFX Control Hold/Peak setting.



### <Ctrl3> Control 3 Hold/Peak — OFF/HOLD/PEAK

This setting determines how the value of a Tone parameter to be changed with the Patch Control Source 3 is maintained when a Hold message is received. The setting values are the same as those for the EFX Control Hold/Peak setting.

## ● CONTROL SOURCE

The **JV-1080** lets you use a variety of MIDI Controllers to change sounds in real time. This setting selects the Controller used to change the Tone parameters.

\* Patch Control Source 1 is set to Modulation (Control Change 1) and cannot be changed.

### <Control2> Patch Control Source 2

### <Control3> Patch Control Source 3

The Controllers assigned to Patch Controllers 2 and 3 can be selected from the following list.

#### OFF:

No Controller is used.

#### SYS-CTRL1:

The Controller set with System Control Source 1, a system parameter, is used (see p.68).

#### SYS-CTRL2:

The Controller set with System Control Source 2, a system parameter, is used (see p.68).

#### MODULATION:

Modulation (Control Change # 1)

#### BREATH:

Breath (Control Change # 2)

#### FOOT:

Foot (Control Change # 4)

#### VOLUME:

Volume (Control Change # 7)

#### PAN:

Pan (Control Change # 10)

#### EXPRESSION:

Expression (Control Change # 11)

#### BENDER:

Pitch bend

#### AFTERTOUCHE:

Aftertouch

#### LFO1:

The rate for LFO1 (The LFOs for Tones 1-4 act with respect to parameters within the same Tone.)

#### LFO2:

The rate for LFO2 (The LFOs for Tones 1-4 act with respect to parameters within the same Tone.)

#### VELOCITY:

Velocity

#### KEYFOLLOW:

Keyfollow (the parameter value changes according to the position on the keyboard, with C4 as "0")

#### PLAY-MATE:

Playmate (the parameter value changes according to the interval between Note On and Note Off)

\* Choose "SYS-CTRL1" or "SYS-CTRL2" if there is no need to use a different Controller for each Patch, or if you want to have control with something other than the Control Changes described here. Use the System's Control Assign 1 page to set the Controller (see p. 68).

\* When the setting for Receive MIDI, a system parameter, is set to "OFF," then there is no effect when any Controller is used.

## ● CONTROL 1 to 3

### <Destination> Control Destination 1 to 4 [PALETTE]

This parameter lets you simultaneously set up to four parameters for the Tone changed by Patch Control Sources 1/2/3.

### <Depth> Control Depth 1 to 4 — -63 to +63 [PALETTE]

This parameter sets the amount of change for any parameters set with Control Destination.

Assignable Tone parameters (and ranges) are as follows:

Destination (controlled parameter)		Depth (setting range)
Display	Meaning	
OFF	No parameters are controlled	—
PCH	Pitch	-63 — +63 (*1)
CUT	Cutoff frequency	
RES	Resonance	
LEV	Level (volume)	
PAN	Pan (stereo position)	
MIX	Volume output from MIX OUT	
CHO	Chorus depth	
REV	Reverb depth	-63 — +63 (*2)
PL1	Depth of LFO1 applied to pitch	
PL2	Depth of LFO2 applied to pitch	
FL1	Depth of LFO1 applied to cutoff	
FL2	Depth of LFO2 applied to cutoff	
AL1	Depth of LFO1 applied to volume	
AL2	Depth of LFO2 applied to volume	
PL1	Depth of LFO1 applied to panning	-63 — +63 (*3)
PL2	Depth of LFO2 applied to panning	
L1R	LFO1 rate	-63 — +63 (*3)
L2R	LFO2 rate	

\*1 Change is larger (higher) for positive (+) values and smaller (lower) for negative (-) values.

\*2 The LFO phase is reversed for positive and negative values.

In either case, however, depth increases as the value moves farther from 0 (zero).

\*3 The LFO cycle is shorter for positive values and longer for negative values.

## ■ Selecting Waveforms (WAVE)

This function lets you select the waveform that serves as the basis for a Tone, apply effects to the waveform, and control its pitch.

### ● WAVE

<Group> Wave Group — INT-A or B/CARD/EXP-A to D [PALETTE]

This parameter determines the memory from which a waveform is selected.

#### INT-A or B:

Selects a waveform stored in the JV-1080.

#### CARD:

Selects a waveform stored on a PCM Card.

#### EXP-A to D:

Selects a waveform stored on Expansion Board A, B, C, or D.

<Number> Wave Number — 1 to 255 [PALETTE]

Selects the waveform that forms the basis of a Tone. Along with the wave number, the wave name appears in the display (in parentheses).

<Gain> Wave Gain — -6/0/+6/+12 [PALETTE]

This parameter changes the gain of a waveform and is effective when adjusting the level of a Tone (or using an amplified waveform after sending it through the Booster (\* p. 44). The value is displayed in decibels (dB).

<Switch> Tone Switch — OFF/ON [PALETTE]

This parameter determines whether each Tone is to be played (ON) or not (OFF).

\* When TONE SWITCH [1] to [4] is used to switch a Tone on or off, this setting also changes automatically.

\* The number of Tones played can be limited by switching off unused Tones.

### ● FXM (Frequency Cross Modulation)

FXM combines a specified wave with another waveform to create a third waveform. This is useful for generating metallic timbres or making special effect sounds.

<Switch> FXM Switch — OFF/ON [PALETTE]

This parameter determines whether FXM is used (ON) or not (OFF).

<Color> FXM Color — 1 to 4 [PALETTE]

This parameter determines the ambience of FXM. A larger value results in a 'rougher' sound, and a smaller value makes the sound more metallic.

<Depth> FXM Depth — 1 to 16 [PALETTE]

This parameter sets the depth of FXM application.

### ● TONE DELAY

This parameter sets the delay applied to each Tone. Tone Delay is different from the Effector's delay because it can also be used to change the tone of the delayed sound and play one-key arpeggios while changing the pitch of each Tone.

The delay time can also be made to synchronize with the internal or external MIDI clock.

<Mode> Tone Delay Mode [PALETTE]

Any of the following can be selected for Tone Delay.

#### NORMAL:

The Tone is always played according to the delay time.

#### HOLD:

The delay effect is applied only while the note is on. No Tone is played if the note switches off before the end of the delay time.

#### PLAY-MATE:

If the time interval between the previous Note On and the current Note On is less than two seconds, the Tone is played with that interval taken as the delay time.

#### CLOCK-SYNC:

The Tone is played using the on-board (or external) tempo clock (\* p. 67) setting.

#### TAP-SYNC:

The Tone is played with the interval set by tapping the foot pedal (Tap Control Source \* p. 67).

#### KEY-OFF-NORMAL:

The Tone is played with the delay time after the note is off.

#### KEY-OFF-DECAY:

The TVA envelope starts from the time the note is on (during which time nothing is played), and the Tone is played with the delay time after the note is off.

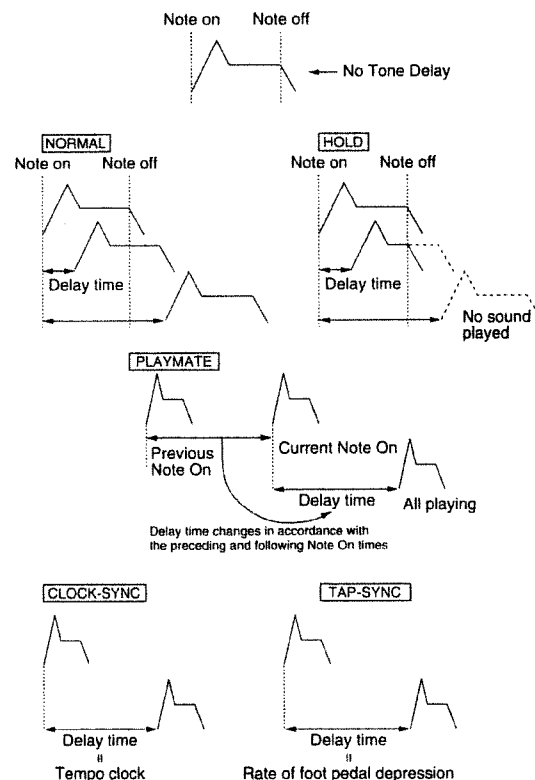

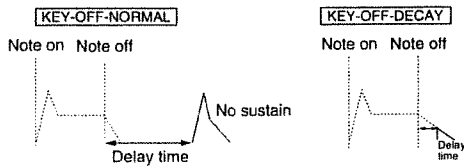

**<Time> Tone Delay Time — 0 to 127/0 to 880 (Note Display) [PALETTE]**

This parameter sets the time interval between a Note On and when sound is actually heard (or from a Note Off if KEY-OFF-NORMAL or KEY-OFF-DECAY has been selected). If "PLAYMATE" has been selected, setting this to "64" causes the interval between the previous Note On and the current Note On to be taken as the delay time. When set to "127," an interval approximately twice as long as for "64" is set as the delay time.

\* When "CLOCK-SYNC" or "TAP-SYNC" has been selected as the mode, the setting value is displayed as a Quarter-note resolution. A note corresponding to this is displayed next to the setting value. For instance, if set to 96 = ♩, the delay time would be 0.5 seconds at a tempo of 120.

Note setting value	Quarter-note resolution
♩ (Double note)	768
♩ (Dotted whole note)	576
♩ (Double-note triplet)	512
♩ (Whole note)	384
♩ (Dotted half note)	288
♩ (Whole-note triplet)	256
♩ (Half note)	192
♩ (Dotted quarter note)	144
♩ (Half-note triplet)	128
♩ (Quarter note)	96
♩ (Dotted eighth note)	72
♩ (Quarter-note triplet)	64
♩ (Eighth note)	48
♩ (Dotted sixteenth note)	36
♩ (Eighth-note triplet)	32
♩ (Sixteenth note)	24
♩ (Dotted thirty-second note)	18
♩ (Sixteenth-note triplet)	16
♩ (Thirty-second note)	12

\* When any of Type 2 to 10 has been selected with Structure (p. 43), the Tone Delay setting for Tone 2 is used for TONES 1 & 2, and Tone Delay setting for Tone 4 is used for TONES 3 & 4

## ■ Adding Vibrato to a Sound (LFO)

An LFO (low-frequency oscillator) cyclically changes the pitch, cutoff frequency, and level to produce modulation

effects such as vibrato, wow, and tremolo.

The JV-1080 has two independent LFOs, called LFO1 and LFO2.

### ● LFO1

**<Form> LFO Waveform [PALETTE]**

Any of the following LFO waveforms can be selected.

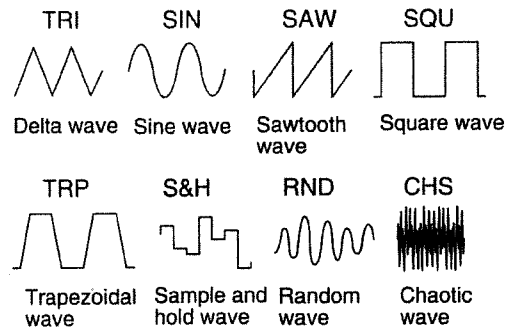

**<KeyTrig> Key Trigger — OFF/ON [PALETTE]**

This parameter determines whether the timing with which the keyboard is played matches (ON) the LFO cycle or not (OFF).

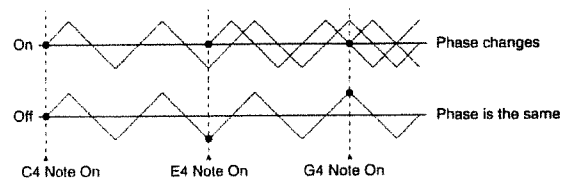

**<Rate> LFO Rate — 0 to 127/0 to 880 (Note Display)**

This parameter sets the speed of the cycle of the LFO. When "CLOCK" or "TAP" has been selected with LFO External Sync, the setting value is displayed as a Quarter-note resolution. A note corresponding to this is displayed next to the setting value.

*See the Tone Delay Chart on the left side of this page for information on note resolution.*

\* When "CHS" has been selected for LFO Waveform, LFO Rate has no effect.

**<ExtSync> LFO External Sync — OFF/CLOCK/TAP**

This parameter determines whether the LFO cycle is synchronized with the on-board (or external) tempo clock (CLOCK), or with the depression rate of the foot pedal (TAP). No synchronization takes place when set to "OFF."

\* When set to "CLOCK," use the system parameter Clock Source (p. 67) to choose whether the internal or external tempo clock is to be used.

\* When set to "TAP," use the system parameter Tap Control Source (p. 67) to select the foot pedal.

**<Mode> Fade Mode [PALETTE]**

This parameter selects how the LFO is applied.

**ON-IN:**

The LFO is applied gradually after the key is played.

**ON-OUT:**

The LFO is applied after the key is played, then gradually fades away.

**OFF-IN:**

The LFO is applied gradually after the key is released.

**OFF-OUT:**

The LFO is applied from the time the key is played until it is released, and after the release, it fades away gradually.

**<Delay> Delay Time — 0 to 127 [PALETTE]**

For ON-IN, this parameter sets the interval from the time the key is played until the LFO starts to be applied (for ON-OUT, the hold time). For OFF-IN, this parameter sets the interval from the time the key is released until the LFO starts to be applied (for OFF-OUT, the hold time).

**<Fade> Fade Time — 0 to 127 [PALETTE]**

This parameter sets the interval after the delay time until the LFO amplitude reaches its maximum (or minimum) value.

**ON-IN**

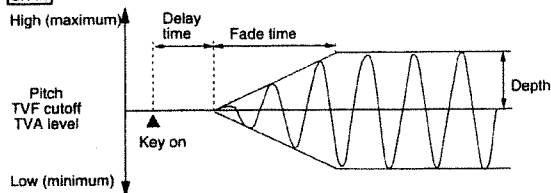

**ON-OUT**

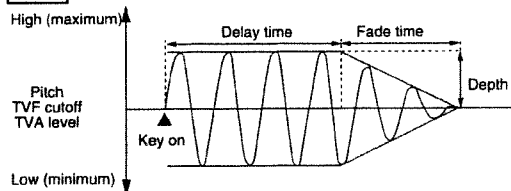

**OFF-IN**

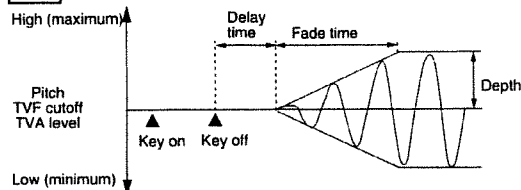

**OFF-OUT**

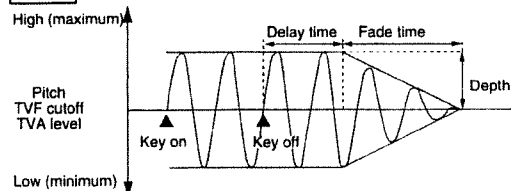

**<Offset> Level Offset — -100/-50/0/+50/+100 [PALETTE]**

This parameter shifts the LFO waveform up or down from the central values (pitch, cutoff frequency, and level). Positive values cause the waveform to shift for undulations above the central values, and negative values cause the waveform to shift for undulations below the central values.

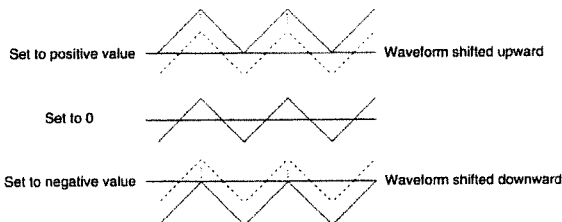

● **LFO 2 Pages**

These make settings for LFO2.

\* The parameters that can be set are identical to those for LFO1.

● **LFO DEPTH 1:2 (LFO Depth)**

**<Pitch> Pitch LFO Depth 1 or 2 — -63 to +63 [PALETTE]**

This parameter sets the extent of application when LFO1 or LFO2 is applied to the pitch.

**<TVF> Filter LFO Depth 1 or 2 — -63 to +63 [PALETTE]**

This parameter sets the extent of application when LFO1 or LFO2 is applied to the cutoff frequency.

**<TVA> Amplitude LFO Depth 1 or 2 — -63 to +63 [PALETTE]**

This parameter sets the extent of application when LFO1 or LFO2 is applied to the level (volume).

**<PAN> Pan LFO Depth 1 or 2 — -63 to +63 [PALETTE]**

This parameter sets the extent of application when LFO1 or LFO2 is applied to the pan (stereo position).

\* Negative and positive values for depth have opposite effects on the changes in pitch and volume. For example, if a positive depth value is set for one Tone and a negative value of the same magnitude is set for another Tone, the phase of the undulations is reversed. This makes it possible to alternately sound different Tones and shift panning cyclically.

■ **Changing the Pitch (PITCH)**

This function sets parameters related to the pitch of a Tone.

● **PITCH**

**<Coarse> Coarse Tune — -48 to +48 [PALETTE]**

This parameter raises/lowers the pitch of a Tone by up to four octaves (in semitone steps).

**<Fine> Fine Tune — -50 to +50 [PALETTE]**

This parameter raises/lowers the pitch of a Tone in increments of one cent (1/100th of a semitone). You can fine-tune the Tone by up to a quarter-tone in either direction.

**<Random> Random Pitch Depth — 0 to 1200 [PALETTE]**

This deliberately causes the pitch of the Tone being played to fluctuate irregularly. The value is displayed in hundredths of a half-step.

**<KeyFlw> Pitch Key Follow — -100/-70/-50/-30/-10/0/+10/+20/+30/+40/+50/+70/+100/+120/+150/+200 [PALETTE]**

This sets how high the pitch rises when the keyboard has been shifted up an octave (12 keys). When set to "+100," then when shifted upward one octave like an ordinary keyboard instrument, the pitch also rises by one octave. When set to "+200," however, the pitch rises two octaves, and when set to "-100" it drops an octave. When set to "0," every key plays at the same pitch. This is normally left set at "+100."

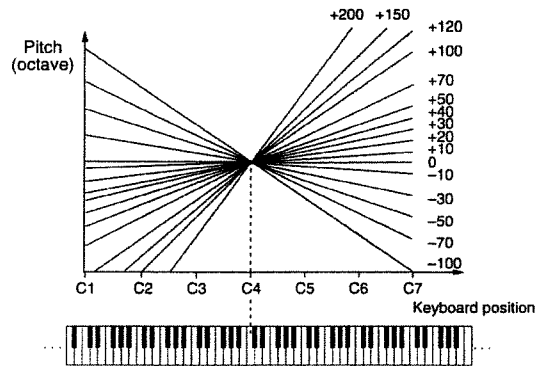

**● PCH ENV DPT (Pitch Envelope Depth)**

**<Envelope Depth> Pitch Envelope Depth— -12 to +12 [PALETTE]**

This sets the extent of the effectiveness of the Pitch Envelope. Larger values, either positive or negative, result in a greater range of change for the Pitch Envelope. Negative values reverse the form of the envelope.

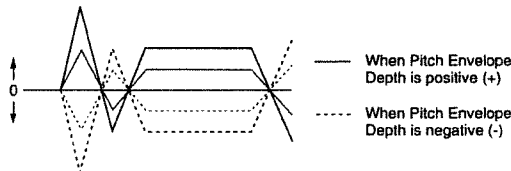

**<Velocity Sens> Pitch Envelope Velocity Sensitivity — -100 to +150 [PALETTE]**

This changes the level of the Pitch Envelope according to velocity. When the value is positive, a larger velocity value results in a larger Pitch Envelope level. When negative, a larger velocity value results in a smaller Pitch Envelope level.

**● PCH TIME ENV (Pitch Time Envelope)**

**<V-T1> Velocity Time 1 Sensitivity — -100/-70/-50/-40/-30/-20/-10/0/+10/+20/+30/+40/+50/+70/+100 [PALETTE]**

This varies the Pitch Envelope T1 according to velocity. When the value is positive, a larger velocity value results in faster change for T1. The change is slowed when the value is negative.

**<V-T4> Velocity Time 4 Sensitivity — -100/-70/-50/-40/-30/-20/-10/0/+10/+20/+30/+40/+50/+70/+100 [PALETTE]**

This varies the Pitch Envelope T4 according to the key off velocity. When the value is positive, a larger velocity value results in faster change for T4. The change is slowed when the value is negative.

\* This effect is not applied when connected to a keyboard that cannot send key off velocity.

**<Time Keyfollow> Envelope Time Key Follow — -100/-70/-50/-40/-30/-20/-10/0/+10/+20/+30/+40/+50/+70/+100 [PALETTE]**

This varies the Pitch Envelope according to the keyboard position. The envelope time of the C4 key is used as the reference. When the value is positive, keys farther to the right side of the keyboard (the high range) produce shorter times up to T2 to T4. Negative values result in longer times.

**● PCH ENVELOPE (Pitch Envelope)**

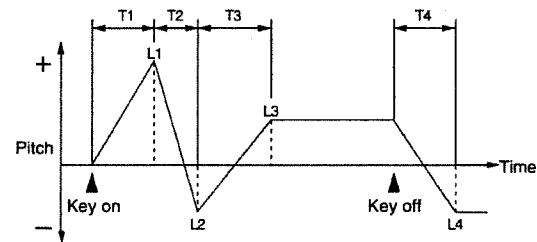

**<T1, T2, T3, or T4> Pitch Envelope Time 1, 2, 3, or 4 — 0 to 127 [PALETTE]**

This sets the time T1, T2, T3, or T4 for the Pitch Envelope. Larger values result in longer times until the next pitch is reached (for instance, T2 controls the time from L1 until L2 is reached).

**<L1, L2, L3, or L4> Pitch Envelope Level 1, 2, 3, or 4 — 0 to 127 [PALETTE]**

This sets the level L1, L2, L3, or L4 for the Pitch Envelope. It determines how much the pitch changes from the reference pitch (set with Coarse Tune or Fine Tune) at each point. The change is higher than the reference pitch when this value is positive and lower than the reference pitch when negative.

**■ Changing the Sound (TVF)**

You can manipulate Tones with a TVF (Time Variant Filter), changing the brightness, thickness, and other aspects of the sound.

## ● FILTER

<Typ> Filter Type — OFF/LPF/BPF/HPF/PKG

[PALETTE]

This selects the type of filter. A filter is a function that cuts off a specific frequency band to change a sound's brightness, thickness, and other qualities. If you don't want to use a filter, set this to "OFF."

### LPF (Low-pass Filter):

Components higher than the cutoff frequency are eliminated. High-range frequencies are cut off, so the sound is rounder. This is the most often-used filter.

### BPF (Bandpass Filter):

Only components near the cutoff frequency are allowed to remain — all others are eliminated. This is good for making highly distinctive sounds.

### HPF (High-pass Filter):

Components lower than the cutoff frequency are eliminated. This filter is good for making percussion instruments with distinctive high ranges.

### PKG (Peaking Filter):

The components near the cutoff frequency are emphasized. This expresses the special sound of a drum, and can even be used to create a wow effect.

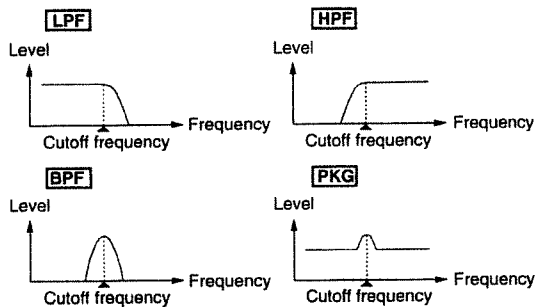

<Cut> Cutoff Frequency — 0 to 127 [PALETTE]

This specifies the frequency at which the filter effect starts (the cutoff frequency) with respect to the frequency components of a waveform.

When using LPF, lowering the cutoff frequency reduces high harmonics for a "rounder" sound, and a higher cutoff frequency produces a brighter sound.

With BPF, the harmonic components that you hear vary according to the value for the cutoff frequency. This is good for making highly distinctive sounds.

When using HPF, raising the cutoff frequency reduces the low harmonics, so the bright components of the sound are emphasized.

With PKG, the emphasized harmonics that are played vary according to the value of the cutoff frequency.

\* The effects of the filters and cutoff frequencies vary greatly from one type of waveform to another.

<Res> Resonance — 0 to 127 [PALETTE]

This lifts up the components of the sound near the cutoff frequency, making the sound more distinctive.

\* Setting this value too high may cause vibration and distortion of the sound.

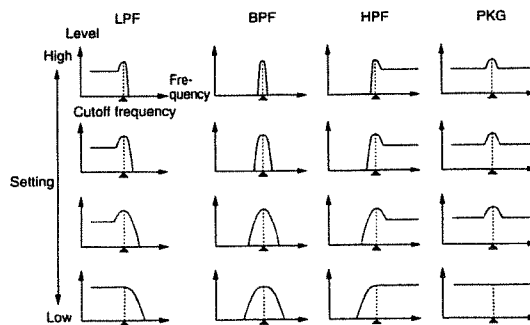

<KeyFlw> Cutoff Key Follow — -100/-70/-50/-30/-10/0/+10/+20/+30/+40/+50/+70/+100/+120/+150/+200 [PALETTE]

This makes the cutoff frequency change according to the position of the key played on the keyboard.

The cutoff frequency for the C4 key is used as the reference. When the value is positive, keys farther to the right side of the keyboard (the high range) result in higher cutoff frequencies, and negative values give lower cutoff frequencies.

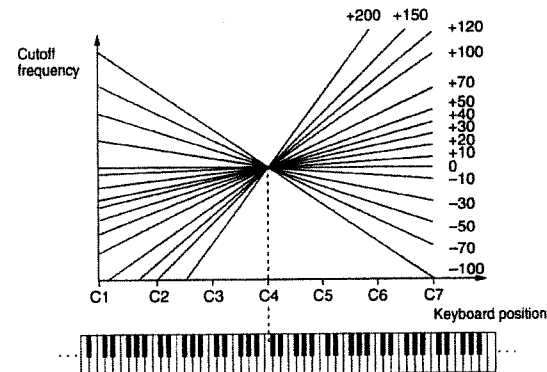

<Env Dpt> TVF Envelope Depth — -63 to +63 [PALETTE]

[PALETTE]

This sets the extent of the effectiveness of the TVF Envelope (see p.55). Larger values, either positive or negative, result in a greater range of change for the TVF Envelope. Negative values reverse the form of the envelope.

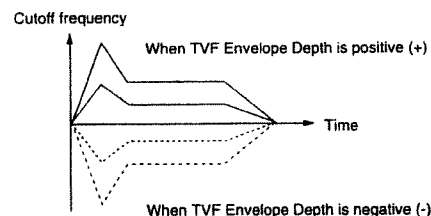

## ● TVF VELOCITY

<V-Sens> TVF Envelope Velocity Sensitivity — -100 to +150 [PALETTE]

This changes the level of the TVF Envelope according to velocity.

When the value is positive, a larger velocity value results in a larger TVF Envelope level for a brighter sound. When negative, a larger velocity value results in a smaller TVF Envelope level for a darker sound.

### <V-Curve> TVF Envelope Velocity Curve — 1 to 7

[PALETTE]

This chooses the curve used when changing the cutoff frequency with velocity. The shape of the curve corresponding to the curve number (1 to 7) appears on the screen.

### <V-Resonance> Resonance Velocity Sensitivity — -100 to +150 [PALETTE]

This changes the amount of resonance applied according to the velocity.

When the value is positive, a larger velocity produces greater resonance. When negative, resonance is reduced. The effect is not applied when the value is zero.

## ● TVF TIME ENV (TVF Time Envelope)

### <V-T1> Velocity Time 1 Sensitivity — -100/-70/-50/-40/-30/-20/-10/0/+10/+20/+30/+40/+50/+70/+100

[PALETTE]

This varies the TVF Envelope T1 according to velocity. When the value is positive, a larger velocity value results in faster change for T1. The change is slowed when the value is negative.

### <V-T4> Velocity Time 4 Sensitivity — -100/-70/-50/-40/-30/-20/-10/0/+10/+20/+30/+40/+50/+70/+100

[PALETTE]

This varies the TVF Envelope T4 according to the key off velocity. When the value is positive, a larger velocity value results in faster change for T4. The change is slowed when the value is negative.

\* This effect is not applied when connected to a keyboard that cannot send key off velocity.

### <Time Keyfollow> Envelope Time Key Follow — -100/-70/-50/-40/-30/-20/-10/0/+10/+20/+30/+40/+50/+70/+100 [PALETTE]

This varies the TVF Envelope according to the keyboard position. The envelope time of the C4 key is used as the reference. When the value is positive, keys farther to the right side of the keyboard (the high range) produce shorter times up to T2 to T4. Negative values result in longer times.

## ● TVF ENVELOPE

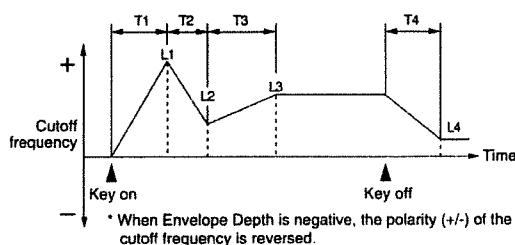

### <T1, T2, T3, or T4> TVF Envelope Time 1, 2, 3, or 4 — 0 to 127 [PALETTE]

This sets the time T1, T2, T3, or T4 for the TVF Envelope. Larger values result in longer times until the next cutoff frequency is reached (for instance, T2 controls the time from L1 until L2 is reached).

### <L1, L2, L3, or L4> TVF Envelope Level 1, 2, 3, or 4 — 0 to 127 [PALETTE]

This sets the level L1, L2, L3, or L4 for the TVF Envelope. It

determines how much the cutoff frequency changes from the reference cutoff frequency (set with Cutoff Frequency) at each point. The change is higher than the reference cutoff frequency when this value is positive and lower than the reference cutoff frequency when negative.

## ■ Changing the Volume (TVA)

You can use a TVA (Time Variant Amplifier) to select the change in volume for each of the Tones.

## ● TVA

### <Level> Tone Level — 0 to 127 [PALETTE]

This sets the volume of the Tone. It is mainly used to balance the volume with other Tones.

\* The volume of an entire Patch is determined by the Patch Common Patch Level (see p. 42).

### <Pan> Tone Pan — L64 to 0 to 63R

Sets the panning (localizes sound image) for each of the Tones. L64 is leftmost, 0 is centered, and 63R is rightmost.

### <V-Sens> TVA Envelope Velocity Sensitivity — -100 to +150 [PALETTE]

This changes the level of the TVA Envelope according to velocity.

When the value is positive, a larger velocity value results in a larger TVA Envelope level for a louder sound. When negative, a larger velocity value results in a smaller TVA Envelope level for lower volume.

### <V-Curve> TVA Envelope Velocity Curve — 1 to 7

[PALETTE]

This chooses the curve used when changing the cutoff frequency with velocity. The shape of the curve corresponding to the curve number (1 to 7) appears on the screen.

## ● BIAS

### <Bias> Bias Level — -100/-70/-50/-40/-30/-20/-10/0/+10/+20/+30/+40/+50/+70/+100 [PALETTE]

When you want to make the volume change according to the keyboard position, this sets how much the volume changes as you move away from the bias point. When you set a positive value, the volume gets louder as you move from the bias point. A negative value makes the volume grow softer.

\* Even when set to a positive value, the level will not exceed the maximum.

### <Point> Bias Point — C-1 to G9 [PALETTE]

This sets the key used as the reference for varying the volume when you want to change the volume according to the keyboard position.

### <Direction> BiasDirection—LOWER/UPPER/LOWER & UPPER/ALL [PALETTE]

This sets the level for the direction to be changed — left or right — when you want to change the volume according to the keyboard position.

#### LOWER:

The volume changes when you move to the left (lower register) from the bias point.

**UPPER:**

The volume changes when you move to the right (upper register) from the bias point.

**LOWER&UPPER:**

The volume changes symmetrically when you move in either direction from the bias point.

**ALL:**

The volume changes linearly as you move from the lower register to the upper register, with the bias point at the center.

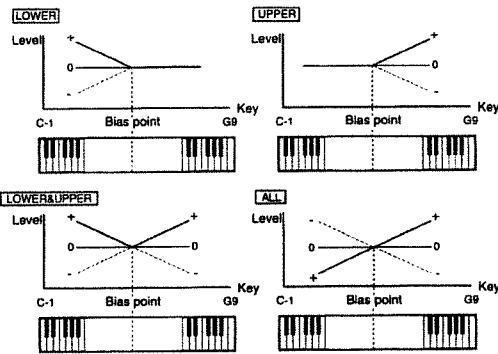

**● PAN MODULATION**

**<KeyFlw> Pan Key Follow** — -100/-70/-50/-30/-10/0/+10/+20/+30/+40/+50/+70/+100 [PALETTE]

This makes the panning change according to the position of the key played on the keyboard. The C4 key is used as the reference. When the value is positive, keys farther to the right side of the keyboard (the high range) result in panning to the right, and negative values give panning to the left.

**<Random> Random Pan Depth** — 0 to 63 [PALETTE]

Panning changes irregularly each time a key is played. The value you set for this determines the range of change. There is no change when set to zero.

**<Alternate> Alternate Pan Depth** — L63 to 0 to R63 [PALETTE]

The sound image is panned alternatingly to the right and left each time a key is played. The changes are made with the value set for Tone Pan at the center. There is no change when set to zero. If you set two Tones respectively to L and R, the stereo position is swapped each time they are played.

**● TVA TIME ENV (TVA Time Envelope)**

**<V-T1> Velocity Time 1 Sensitivity** — -100/-70/-50/-40/-30/-20/-10/0/+10/+20/+30/+40/+50/+70/+100 [PALETTE]

This varies the TVA Envelope T1 according to velocity. When the value is positive, a larger velocity value results in faster change for T1. The change is slowed when the value is negative.

**<V-T4> Velocity Time 4 Sensitivity** — -100/-70/-50/-40/-30/-20/-10/0/+10/+20/+30/+40/+50/+70/+100 [PALETTE]

This varies the TVA Envelope T4 according to the key off velocity. When the value is positive, a larger velocity value results in faster change for T4. The change is slowed when the value is negative.

\* This effect is not applied when connected to a keyboard that cannot send key off velocity.

**<Time Keyfollow> Envelope Time Key Follow** — -100/-70/-50/-40/-30/-20/-10/0/+10/+20/+30/+40/+50/+70/+100 [PALETTE]

This varies the TVA Envelope according to the keyboard position. The envelope time of the C4 key is used as the reference. When the value is positive, keys farther to the right side of the keyboard (the high range) produce shorter times up to T2 to T4. Negative values result in longer times.

**● TVA ENVELOPE**

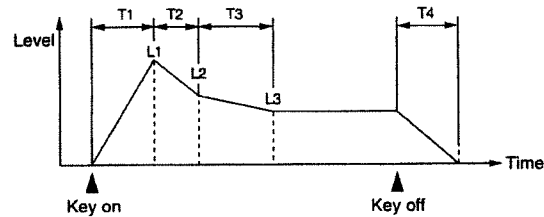

**<T1, T2, T3, or T4> TVA Envelope Time 1, 2, 3, or 4** — 0 to 127 [PALETTE]

This sets the time T1, T2, T3, or T4 for the TVA Envelope. Larger values result in longer times until the next volume is reached (for instance, T2 controls the time from L1 until L2 is reached).

**<L1, L2, or L3> TVA Envelope Level 1, 2, or 3** — 0 to 127 [PALETTE]

This sets the level L1, L2 or L3 for the TVA Envelope. It determines how much the volume changes from the reference volume (set with Tone Level) at each point.



# 2. Performance Edit Mode

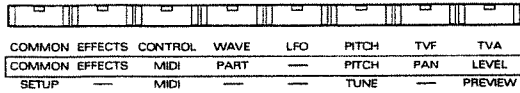

## ■ Making Settings for an Entire Performance (COMMON)

These set parameters and key ranges for an entire Performance.

### ● PERFORM NAME (Performance Name)

You can give a Performance a name up to 12 characters in length.

The same procedure that you use to change a Patch name can be used to change a Performance name.

Available characters:

Space, A to Z, a to z, 0 to 9, +-\* / ! = ? < > ( ) [ ] ; : , ' " ^ # % & \$ % @ ^ \_

### ● PERFORM TEMPO (Performance Tempo)

<Default Tempo> Default Tempo — 20 to 250

This sets the speed of the tempo clock built into the unit, which controls the parameters for Tones and Effects. The Patch parameters also have a Tempo Clock setting, but in the Performance mode the Default Tempo values for the Patches in each Part are ignored, and the parameters for the Parts are controlled by the Default Tempo you set here.

\* When using the internal tempo clock, set the Clock Source system parameter (see p. 66) to "INT."

\* The internal tempo clock is not output from MIDI OUT.

### ● PERFORM KEY MODE (Performance Key Mode)

<Key Range> Key Range Switch — OFF/ON

This selects whether the setting for Key Range is enabled (ON) or disabled (OFF).

### ● KEY RANG (Key Range)

<Key Lower> Key Range Lower — C-1 to G9 [PALETTE]

This sets the key of the lowest sound played for the Parts.

\* If you try to make this value higher than the key set for Key Range Upper, the value for Key Range Upper changes at the same time.

<Key Upper> Key Range Upper — C-1 to G9 [PALETTE]

This sets the key of the highest sound played for the Parts.

\* If you try to make this value lower than the key set for Key Range Lower, the value for Key Range Lower changes at the same time.

The relationship with Key Range set with Patch Common is as shown below.

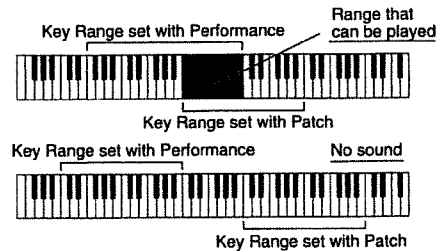

### ● RESERVE (Voice Reserve)

<Voice Reserve> Voice Reserve — 0 to 64 [PALETTE]

This setting determines the number of voices set aside for each Part during a performance that has more than 64 voices. Because each time a Patch is played it uses a number of voices equal to the number of Tones that make up the Patch, you should set this to a number of voices equal to the number of Tones multiplied by the number of played sounds that are required. However, the total of Voice Reserve settings for each Part cannot be higher than 64. The number in parentheses indicates the number of voices that are left and are available for setting.

\* The number of sounds that the JV-1080 can play simultaneously varies by the number of Tones in the Patches. Using one Tone means using one voice. The JV-1080 can use up to 64 voices. This means that if a Patch uses only one Tone, 64 sounds can be played at the same time. But if a Patch uses two Tones, then only 32 sounds can be played simultaneously.

## ■ Selecting Effects Added to the Performance (EFFECTS)

### ● OUTPUT

<Output Assign> Output Assign — MIX/EFX/OUTPUT1/OUTPUT2 [PALETTE]

Output Level — 0 to 127 [PALETTE]

Output Assign determines the output destination for each Part, and Output Level sets the level of the output signal.

MIX:

This sends the original sound to EFX. The sound is also simultaneously output to Chorus and Reverb.

EFX:

This sends the original sound to MIX OUT. The sound is also simultaneously output to Chorus and Reverb. The output destination of the sound passing through EFX follows the Output Assign setting for PERFORM EFX OUT.

OUTPUT1:

This sends the original sound to OUTPUT1.

OUTPUT2:

This sends the original sound to OUTPUT2.

#### **PATCH:**

This sends the original sound according to the output destinations of the Output Assign settings made for the Patches selected for the Part (see p. 45). When this setting is made, the Output Level, Chorus Send Level, and Reverb Send Level values are added to the corresponding values for the Patch.

- \* When OUTPUT1 or OUTPUT2 is selected as the output destination, the settings for Chorus and Reverb are ignored.
- \* If you want to keep the Output settings for each of the Tones, set this to PATCH. If you set it to something else other than PATCH, the Output settings for the Tones (Output Assign, Output Level, Chorus Send Level, and Reverb Send Level) are disabled, and the Output settings for the Part become effective.

<Chorus> Chorus Send Level — 0 to 127 [PALETTE]  
This sets the level of the signal sent to Chorus for each Part.

<Reverb> Reverb Send Level — 0 to 127 [PALETTE]  
This sets the level of the signal sent to Reverb for each Part.

### ● PERFORM EFX TYPE (Performance EFX Type)

#### <Type> EFX Type

This determines the type of EFX applied to the Performance. For a description of the EFX types, check out “Chapter 5 — Multi-Effector EFX” (see p. 83).

- \* This is disabled when EFX Source is set to 1-9/11-16.

#### <Source> EFX Source — PERFORM/1-9/11-16

This selects whether the EFX set for the Performance is applied to the entire Performance (PERFORM), or whether one of the EFXs set for the Patches of the Parts is selected and applied to the entire Performance (1-9/11-16).

- \* The EFX set for a Patch and the EFX set for the Performance cannot be used at the same time.
- \* When set to 1-9/11-16, the settings for the EFX Type and the following Performance EFX Parameter, Performance EFX Output and Performance EFX Control are disabled, and the settings for the Patch EFX are enabled.

### ● PERFORM EFX PRM (Performance EFX Parameter)

This selects the parameter for the EFX chosen with EFX Type. The parameters that can be set vary from one EFX to another. For a description of EFX parameters, see “Chapter 5 — Multi-Effector EFX” (see p. 83).

- \* This setting is ignored when EFX Source is set to 1-9/11-16.

### ● PERFORM EFX OUT (Performance EFX Output)

This sets how sound through EFX will be output when “EFX” is selected with Output Assign for OUTPUT.

- \* This setting is ignored when EFX Source is set to 1-9/11-16.

<Output Assign> Output Assign — MIX/OUTPUT1/OUTPUT2

Output Level — 0 to 127

Output Assign determines the output destination for the EFX

sound, and Output Level sets the level of the output signal.

#### **MIX:**

This sends the EFX sound to MIX OUT. The sound is also simultaneously output to Chorus and Reverb.

#### **OUTPUT1:**

This sends the EFX sound to OUTPUT1.

#### **OUTPUT2:**

This sends the EFX sound to OUTPUT2.

- \* When OUTPUT1 or OUTPUT2 is selected as the output destination, all settings for Chorus and Reverb are ignored.

<Chorus> Chorus Send Level — 0 to 127

This sets the level of the signal sent to Chorus from EFX.

<Reverb> Reverb Send Level — 0 to 127

This sets the level of the signal sent to Reverb from EFX.

### ● PERFORM EFX CTRL (Performance EFX Control)

The JV-1080 lets you use any of a variety of MIDI Controllers to vary EFX parameters in real time.

Just as with Patch EFX Control, you use EFX Control Source to choose a Controller, and set the degree of action of the Controller with EFX Control Depth (-63 to +63).

You can choose any of the following as the EFX Control Source.

#### **OFF:**

No Controller is used.

#### **SYS-CTRL1:**

The Controller set with System Control Source 1, a system parameter, is used (see p. 68).

#### **SYS-CTRL2:**

The Controller set with System Control Source 2, a system parameter, is used (see p. 68).

#### **MODULATION:**

Modulation (Control Change # 1)

#### **BREATH:**

Breath (Control Change # 2)

#### **FOOT:**

Foot (Control Change # 4)

#### **VOLUME:**

Volume (Control Change # 7)

#### **PAN:**

Pan (Control Change # 10)

#### **EXPRESSION:**

Expression (Control Change # 11)

#### **BENDER:**

Pitch bend

#### AFTERTOUCHE:

Aftertouch

- \* Choose "SYS-CTRL1" or "SYS-CTRL2" if there is no need to use a different Controller for each Performance, or if you want to perform control with something other than the control changes described here. Use the system parameter's Control Assign 1 page to set the Controller (\* p. 68).
- \* When the switch for Receive MIDI, a system parameter, is set to "OFF," then there is no effect when any Controller is used.
- \* This setting is ignored when EFX Source is set to 1-9/11-16.

### ● PERFORM CHORUS (Performance Chorus)

<Rat> Chorus Rate — 0 to 127

This sets the speed for the undulations of the Chorus sound.

<Dpt> Chorus Depth — 0 to 127

This sets the depth of the undulations of the Chorus sound.

<Dly> Pre delay — 0 to 127

This sets the time from the playing of the original sound to the playing of the Chorus sound. Larger values result in broader sounds.

<Fbk> Chorus Feedback — 0 to 127

This sets the amount of sound from Chorus that is returned (fed back) to Chorus. Larger values result in Chorus effects of greater complexity.

<Level> Chorus Level — 0 to 127

This sets the volume of the Chorus sound.

<Output> Chorus Output Assign — MIX/REVERB/  
MIX+REV

This setting determines how the Chorus sound is output.

#### MIX:

This outputs the Chorus sound to MIX OUT.

#### REVERB:

This outputs the Chorus sound to Reverb.

#### MIX+REV:

This outputs the Chorus sound to both MIX OUT and Reverb.

### ● PERFORM REVERB (Performance Reverb)

<Type> Reverb Type

This parameter selects the type of reverberation.

#### ROOM1:

Short, high-density reverb

#### ROOM2:

Short, low-density reverb

#### STAGE1:

Reverb with many late reflections

#### STAGE2:

Reverb with strong initial reflection

#### HALL1:

Sparkling reverb

#### HALL2:

Richly resounding reverb

#### DELAY:

Standard delay

#### PAN-DLY:

A delay that pans (moves) the reflections to left and right.

<Time> Reverb Time — 0 to 127

For a type from "ROOM1" to "HALL2," this sets the reverb time (i.e., how long the reverb continues). For "DELAY" or "PAN-DLY," this sets the delay time. Larger values produce a feeling of greater space.

<Lev> Reverb Level — 0 to 127

This sets the volume of the reverb sound.

<Fbk> Delay Feedback — 0 to 127

When "DELAY" or "PAN-DLY" has been chosen as the type, this sets the amount of delayed sound that is returned (fed back) to the delay. Larger values result in a delay sustained for a longer time.

<HF Damp> High-frequency Damp — 200/250/315/  
400/500/630/800/1000/1250/1600/2000/2500/3150/4000/5000/6300/8000/BYPASS

This sets the frequency at which the high-frequency components of the reverb sound are cut off.

A lower cutoff frequency results in a "darker" sound, and a higher frequency produces a brighter sound. When set to "BYPASS," no high-frequency components are cut off.

### ■ Setting the MIDI Channel for a Part (MIDI)

These set the MIDI message receive switch and receive channel for each of the Parts.

#### ● CONTROL

<Channel> MIDI Channel — 1 to 16 [PALETTE]

This sets the MIDI receive channel for each Part.

- \* Be careful when using this setting, because if you set it to the same channel as "Control Channel," a system parameter (\* p. 66), then the Control Channel setting takes priority and when a program change message is received the Performance will be switched, too.

<Rx> MIDI Receive Switch — OFF/ON [PALETTE]

This determines whether MIDI messages for each Part are received (ON) or not received (OFF).

- \* The setting you make here changes automatically if you switch PART SWITCH [1/9] to [8/16] on or off while in the Performance Play mode.

---

## ● Rx MIDI (Receive MIDI)

<Volume> Receive Volume — OFF/ON [PALETTE]

This determines whether MIDI volume messages for each Part are received (ON) or not received (OFF).

\* This setting is ignored when the Volume setting for Receive MIDI, a system parameter, is set to "OFF" (see p. 68).

<Hold-1> Receive Hold 1 — OFF/ON [PALETTE]

This determines whether MIDI hold 1 messages for each Part are received (ON) or not received (OFF).

\* This setting is ignored when the Hold 1 setting for Receive MIDI, a system parameter, is set to "OFF" (see p. 68).

<Program Change> Receive Program Change — OFF/ON [PALETTE]

This setting determines whether MIDI program change messages for each Part are received (ON) or not received (OFF).

\* This setting is ignored when the Program Receive setting for Receive MIDI, a system parameter, is set to "OFF" (see p. 68).

---

## ■ Selecting the Patch Assigned to a Part (PART)

This assigns a Patch or Rhythm Set to each of the Parts.

### ● PATCH

<Group> Patch Group [PALETTE]

This selects the group of the Patch (or Rhythm Set, for Part 10) to assign to each Part.

USR:

User Memory Patch

CRD:

DATA Card Patch

PCM:

PCM Card Patch

PRA to PRC:

Patch from Preset Memory A to C

GM:

Patch from Preset Memory D (GM sound)

XPA to XPD:

Patch from Expansion Board A to D

<Number> Patch Number — 001 to 255 [PALETTE]

This selects the number of the Patch to assign to each Part. The name of the selected Patch appears on the display in parentheses.

\* For USR, PRA to PRC, and GM, you can choose a number from 001 to 128. For CRD, PCM, and XPA to XPD, you can choose any Patch number up to the number of Patches stored on the device.

\* You can't select a Patch from a DATA Card, PCM Card, or Expansion Board unless that device is installed in your JV-1080.

---

## ■ Setting the Pitch for a Part (PITCH)

This makes settings related to the pitch of each Part.

### ● PITCH

<Pitch Coarse> Pitch Coarse Tune — -48 to +48 [PALETTE]

This shifts the pitch of a Part by up to four octaves up or down, in semitone steps.

The pitch varies relatively, with the pitch of the Patch taken to be zero.

<Pitch Fine> Pitch Fine Tune — -50 to +50 [PALETTE]

This shifts the pitch of a Part up or down in increments of one cent (1/100th of a semitone).

You can fine-tune the Tone by up to half a half-step (one quarter-tone) in either direction.

---

## ■ Setting the Stereo Position for a Part (PAN)

This sets the panning (localizes sound image) for each of the Parts.

### ● PAN

<Part Pan> Part Pan — L64 to 0 to 63R [PALETTE]

Sets the panning (localizes sound image) for each of the Parts. L64 is leftmost, 0 is centered, and 63R is rightmost.

\* Because panning is also set within each Patch, the stereo position of each Patch is shifted from its current position by the value you set here.

---

## ■ Setting the Volume for a Part (LEVEL)

This sets the level (volume) for each Part.

### ● LEVEL

<Level> Part Level — 0 to 127 [PALETTE]

This sets the volume of the Part. It is mainly used to balance the volume with other Parts.

# 3. Rhythm Edit Mode

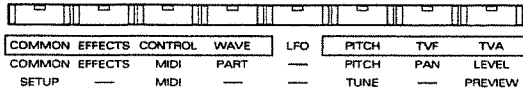

## ■ Naming a Rhythm Set (COMMON)

### ● RHYTHM NAME (Rhythm Set Name)

You can give a Rhythm Set a name up to 12 characters in length.

The same procedure that you use to change a Patch name can be used to change a Rhythm Set name.

#### Available characters:

Space, A to Z, a to z, 0 to 9, +-\* / | =? <> () [] | : ; , ' " ~ # % & \$ % @ ^ \_

## ■ Selecting Effects Added to the Rhythm Set (EFFECTS)

\* The parameters at the pages for the Effects you set here, except for the OUTPUT page, are Performance parameters currently called up to the temporary area. This means that if you want to save the data for these parameters, you must first change over to the Performance mode and save it as Performance data. However, if you've called this Rhythm Set from another Performance, then its Effect settings belong to that Performance.

### ● OUTPUT

<Output Assign> Output Assign — MIX/EFX/OUTPUT1/OUTPUT2

Output Level — 0 to 127

Output Assign determines the output destination for each Rhythm Tone, and Output Level sets the level of the output signal.

#### MIX:

This sends the original sound to MIX OUT. The sound is also simultaneously output to Chorus and Reverb.

#### EFX:

This sends the original sound to EFX. The sound is also simultaneously output to Chorus and Reverb. The output destination of the sound passing through EFX follows the Output Assign setting for PERFORM EFX OUT.

#### OUTPUT1:

This sends the original sound to OUTPUT1.

#### OUTPUT2:

This sends the original sound to OUTPUT2.

\* When OUTPUT1 or OUTPUT2 is selected as the output destination, the settings for Chorus and Reverb are ignored.

<Chorus> Chorus Send Level — 0 to 127

This sets the level of the signal sent to Chorus for each

Rhythm Tone.

<Reverb> Reverb Send Level — 0 to 127

This sets the level of the signal sent to Reverb for each Rhythm Tone.

### ● PERFORM EFX TYPE (Performance EFX Type)

<Type> EFX Type

This determines the type of EFX applied to the Performance.

For a description of the EFX types, check out "Chapter 5 — Multi-Effector EFX" (p. 83).

\* This is disabled when EFX Source is set to 1-9/11-16.

<Source> EFX Source — PERFORM/1-9/11-16

This selects whether the EFX set for the Performance is applied to the entire Performance (PERFORM), or whether one of the EFXs set for the Patches of the Parts is selected and applied to the entire Performance (1-9/11-16).

\* The EFX set for a Patch and the EFX set for the Performance cannot be used at the same time.

\* When set to 1-9/11-16, the settings for the EFX Type and the following Performance EFX Parameter, Performance EFX Output and Performance EFX Control are disabled, and the settings for the Patch EFX are enabled.

### ● PERFORM EFX PRM (Performance EFX Parameter)

This selects the parameter for the EFX chosen with EFX Type. The parameters that can be set vary from one EFX to another. For a description of EFX parameters, see "Chapter 5 — Multi-Effector EFX" (p. 83).

\* This setting is ignored when EFX Source is set to 1-9/11-16.

### ● PERFORM EFX OUT (Performance EFX Output)

This sets how sound through EFX will be output when "EFX" is selected with Output Assign for OUTPUT.

\* This setting is ignored when EFX Source is set to 1-9/11-16.

<Output Assign> Output Assign — MIX/OUTPUT1/OUTPUT2

Output Level — 0 to 127

Output Assign determines the output destination for the EFX sound, and Output Level sets the level of the output signal.

#### MIX:

This sends the EFX sound to MIX OUT. The sound is also simultaneously output to Chorus and Reverb.

#### OUTPUT1:

This sends the EFX sound to OUTPUT1.

#### OUTPUT2:

This sends the EFX sound to OUTPUT2.

\* When OUTPUT1 or OUTPUT2 is selected as the output destination, all settings for Chorus and Reverb are ignored.

**<Chorus> Chorus Send Level — 0 to 127**

This sets the level of the signal sent to Chorus from EFX.

**<Reverb> Reverb Send Level — 0 to 127**

This sets the level of the signal sent to Reverb from EFX.

**● PERFORM EFX CTRL (Performance EFX Control)**

The **JV-1080** lets you use any of a variety of MIDI Controllers to vary EFX parameters in real time.

Just as with Patch EFX Control, you use EFX Control Source to choose a Controller, and set the degree of action of the Controller with EFX Control Depth (-63 to +63).

You can choose any of the following as the EFX Control Source.

**OFF:**

No Controller is used.

**SYS-CTRL1:**

The Controller set with System Control Source 1, a system parameter, is used (see p. 68).

**SYS-CTRL2:**

The Controller set with System Control Source 2, a system parameter, is used (see p. 68).

**MODULATION:**

Modulation (Control Change # 1)

**BREATH:**

Breath (Control Change # 2)

**FOOT:**

Foot (Control Change # 4)

**VOLUME:**

Volume (Control Change # 7)

**PAN:**

Pan (Control Change # 10)

**EXPRESSION:**

Expression (Control Change # 11)

**BENDER:**

Pitch bend

**AFTERTOUCHE:**

Aftertouch

- \* Choose "SYS-CTRL1" or "SYS-CTRL2" if there is no need to use a different Controller for each Performance, or if you want to perform control with something other than the control changes described here. Use the system parameter's Control Assign page to set the Controller (see p. 68).
- \* When the switch for Receive MIDI, a system parameter, is set to "OFF," then there is no effect when any Controller is used.
- \* This setting is ignored when EFX Source is set to 1-9/11-16.

**● PERFORM CHORUS (Performance Chorus)**

**<Rat> Chorus Rate — 0 to 127**

This sets the speed for the undulations of the Chorus sound.

**<Dpt> Chorus Depth — 0 to 127**

This sets the depth of the undulations of the Chorus sound.

**<Dly> Pre delay — 0 to 127**

This sets the time from the playing of the original sound to the playing of the Chorus sound. Larger values result in broader sounds.

**<Fbk> Chorus Feedback — 0 to 127**

This sets the amount of sound from Chorus that is returned (fed back) to Chorus. Larger values result in Chorus effects of greater complexity.

**<Level> Chorus Level — 0 to 127**

This sets the volume of the Chorus sound.

**<Output> Chorus Output Assign — MIX/REVERB /MIX+REV**

This setting determines how the Chorus sound is output.

**MIX:**

This outputs the Chorus sound to MIX OUT.

**REVERB:**

This outputs the Chorus sound to Reverb.

**MIX+REV:**

This outputs the Chorus sound to both MIX OUT and Reverb.

**● PERFORM REVERB (Performance Reverb)**

**<Type> Reverb Type**

This parameter selects the type of reverberation.

**ROOM1:**

Short, high-density reverb

**ROOM2:**

Short, low-density reverb

**STAGE1:**

Reverb with many late reflections

**STAGE2:**

Reverb with strong initial reflection

**HALL1:**

Sparkling reverb

**HALL2:**

Richly resounding reverb

**DELAY:**

Standard delay

**PAN-DLY:**

A delay that pans (moves) the reflections to left and right.

**<Time> Reverb Time — 0 to 127**

For a type from "ROOM1" to "HALL2," this sets the reverb time (i.e., how long the reverb continues). For "DELAY" or "PAN-DLY," this sets the delay time. Larger values produce a feeling of greater space.

**<Lev> Reverb Level — 0 to 127**

This sets the volume of the reverb sound.

**<Fbk> Delay Feedback — 0 to 127**

When "DELAY" or "PAN-DLY" has been chosen as the type, this sets the amount of delayed sound that is returned (fed back) to the delay. Larger values result in a delay sustained for a longer time.

**<HF Damp> High-frequency Damp — 200/250/315/400/500/630/800/1000/1250/1600/2000/2500/3150/4000/5000/6300/8000/BYPASS**

This sets the frequency at which the high-frequency components of the reverb sound are cut off.

A lower cutoff frequency results in a "darker" sound, and a higher frequency produces a brighter sound. When set to "BYPASS," no high-frequency components are cut off.

## ■ Using Controllers to Change How Sounds Are Played (CONTROL)

These make settings for the Controllers and for how Rhythm Tones are played.

### ● CONTROL

**<Bender> Bender Range — 0 to 12**

This lets you set how far the pitch changes when the Bender lever is moved to the right or left (or when the wheel is turned). You can set a range up/down to one octave in semitone increments.

**<EnvMode> Envelope Mode — NO-SUS/SUSTAIN**

This sets whether the time of the sustain level (L3) for the Pitch/TVF/TVA Envelope is ignored (NO-SUS) or recognized (SUSTAIN). With one-shot sounds this is effective when set to "NO-SUS."

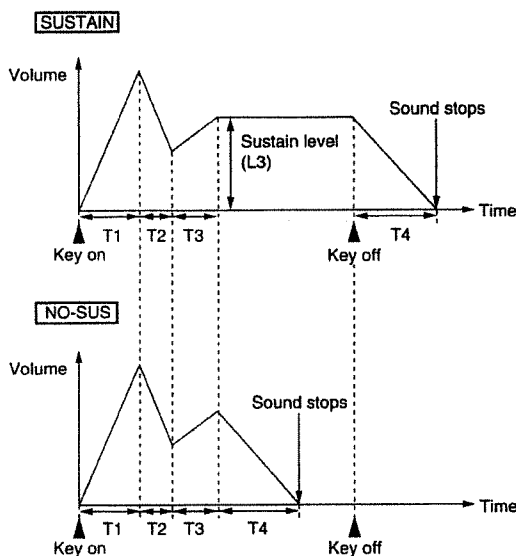

**<Mute Group> Mute Group — OFF/1 to 31**

This lets you assign numbers to Rhythm Tones and differen-

tiate by groups so that rhythm sounds with identical numbers are not played simultaneously. Up to 31 groups can be set. There is no muting when set to "OFF."

### ● RxSWITCH (Receive Switch)

**<Volume> Volume Control Switch — OFF/ON**

This determines whether the volume changes (ON) or doesn't change (OFF) when MIDI volume messages are received for the Rhythm Tones.

\* This setting is ignored when the Volume setting for Receive MIDI, a system parameter, is set to "OFF" (☞ p. 68).

**<Pan> Pan Control Switch — OFF/CONT/KEY-ON**

This sets how MIDI pan messages for each of the Rhythm Tones are received.

**OFF:**

The stereo position does not change when a pan message is received.

**CONT:**

Pan messages are received and the stereo position changes.

**KEY-ON:**

The stereo position changes according to pan messages when the key is on, but even if a new pan message is received while the sound is played, there is no change in the stereo position until the next time the key is on.

\* This setting is ignored when the Control Change setting for Receive MIDI, a system parameter, is set to "OFF" (☞ p. 68).

**<Hold-1 Switch> Hold 1 Control Switch — OFF/ON**

This determines whether a sound is held (ON) or not held (OFF) when MIDI hold 1 messages are received for the Rhythm Tones.

\* This setting is ignored when the Hold 1 setting for Receive MIDI, a System parameter, is set to "OFF" (☞ p. 68).

## ■ Selecting Waveforms for a Rhythm Tone (WAVE)

This lets you select the waveform that serves as the basis for a Rhythm Tone, apply effects to the waveform, and control its pitch.

### ● WAVE

**<Group> Wave Group — INT-A or B/CARD/EXP-A to D**

This determines the form of memory from which a waveform is to be chosen.

**INT-A or B:**

Selects a waveform stored in the JV-1080.

**CARD:**

Selects a waveform stored on a PCM Card.

**EXP-A to D:**

Selects a waveform stored on Expansion Board A, B, C, or D.

**<Number> Wave Number — 1 to 255**

Selects the waveform that forms the basis of a Rhythm Tone. Along with the wave number, the wave name appears on the display in parentheses.

**<Gain> Wave Gain — -6/0/+6/+12**

This changes the gain of a waveform, and is effective when adjusting the level of a Rhythm Tone. The value is displayed in decibels (dB).

**<Switch> Tone Switch — OFF/ON**

This determines whether each Rhythm Tone is to be played (ON) or not played (OFF).

---

## ■ Changing the Pitch of a Rhythm Tone (PITCH)

---

This sets parameters related to the pitch of a Rhythm Tone.

### ● PITCH

**<Coarse> Source Key — C-1 to G9**

This sets the pitch of the key in which the Rhythm Tone is to be played.

**<Fine> Fine Tune — -50 to +50**

This shifts the pitch of a Rhythm Tone up or down in increments of one cent (1/100th of a semitone). You can fine-tune the Rhythm Tone by up to half a half-step (one quarter-tone) in either direction.

**<Random> Random Pitch Depth — 0 to 1200**

This deliberately causes the pitch of the Rhythm Tone being played to fluctuate irregularly. The value is displayed in hundredths of a half-step.

**<Env Dpt> Pitch Envelope Depth — -12 to +12**

This sets the extent of the effectiveness of the Pitch Envelope. Larger values, either positive or negative, result in a greater range of change for the Pitch Envelope. Negative values reverse the form of the envelope.

### ● PCH VELOCITY (Pitch Velocity)

**<Velocity Sens> Pitch Envelope Velocity Sensitivity — -100 to +150**

This changes the level of the Pitch Envelope according to velocity. When the value is positive, a larger velocity value results in a larger Pitch Envelope level. When negative, a larger velocity value results in a smaller Pitch Envelope level.

**<Velocity Time> Velocity Time Sensitivity — -100/-70/-50/-40/-30/-20/-10/0/+10/+20/+30/+40/+50/+70/+100**

This varies the entire Pitch Envelope time according to velocity.

When the value is positive, a larger velocity value results in faster change in the Pitch Envelope time. The change is slowed when the value is negative.

### ● PCH ENVELOPE (Pitch Envelope)

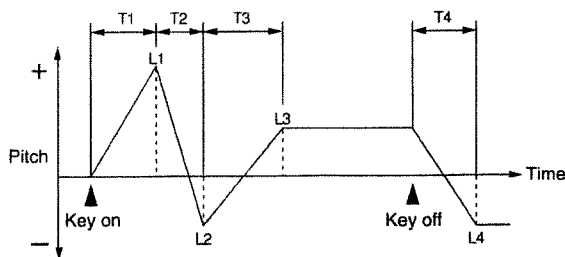

**<T1, T2, T3, or T4> Pitch Envelope Time 1, 2, 3, or 4 — 0 to 127**

This sets the time T1, T2, T3, or T4 for the Pitch Envelope. Larger values result in longer times until the next pitch is reached (for instance, T2 controls the time from L1 until L2 is reached).

**<L1, L2, L3, or L4> Pitch Envelope Level 1, 2, 3, or 4 — 0 to 127**

This sets the level L1, L2, L3, or L4 for the Pitch Envelope. It determines how much the pitch changes from the reference pitch (set with Coarse Tune or Fine Tune) at each point. The change is higher than the reference pitch when this value is positive and lower than the reference pitch when negative.

---

## ■ Changing the Sound of a Rhythm Tone (TVF)

---

You can manipulate Rhythm Tones with a TVF (Time Variant Filter), changing the brightness, thickness, and other aspects of the sound.

### ● FILTER

**<Type> Filter Type — OFF/LPF/BPF/HPF/PKG**

This selects the type of filter. If you don't want to use a filter, set this to "OFF."

**LPF (Low-pass Filter):**

Components higher than the cutoff frequency are eliminated. High-range frequencies are cut off, so the sound is rounder. This is the most often-used filter.

**BPF (Bandpass Filter):**

Only components near the cutoff frequency are allowed to remain — all others are eliminated. This is good for making highly distinctive sounds.

**HPF (High-pass Filter):**

Components lower than the cutoff frequency are eliminated. This filter is good for making percussion instruments with distinctive high ranges.

**PKG (Peaking Filter):**

The components near the cutoff frequency are emphasized. This expresses the special sound of a drum, and can even be used to create a wow effect.

**<Cutoff> Cutoff Frequency — 0 to 127**

This specifies the frequency at which the filter effect starts (the cutoff frequency) with respect to the frequency components of a waveform.

\* The effects of the filters and cutoff frequencies vary greatly from one type of waveform to another.



**<Res> Resonance — 0 to 127**

This lifts up the components of the sound near the cutoff frequency, making the sound more distinctive.

**<Env Dpt> TVF Envelope Depth— -63 to +63**

This sets the extent of the effectiveness of the TVF Envelope. Larger values, either positive or negative, result in a greater range of change for the TVF Envelope. Negative values invert the shape of the envelope.

**● TVF VELOCITY**

**<V-Sens> TVF Envelope Velocity Sensitivity — -100 to +150**

This changes the level of the TVF Envelope according to velocity.

When the value is positive, a larger velocity value results in a larger TVF Envelope level for a brighter sound. When negative, a larger velocity value results in a smaller TVF Envelope level for a darker sound.

**<V-Time> Velocity Time Sensitivity — -100/-70/-50/-40/-30/-20/-10/0/+10/+20/+30/+40/+50/+70/+100**

This varies the entire TVF Envelope time according to velocity. When the value is positive, a larger velocity value results in faster change in the TVF Envelope time. The change is slowed when the value is negative.

**<V-Resonance> Resonance Velocity Sensitivity — -100 to +150**

This changes the amount of resonance applied according to the velocity.

When the value is positive, a larger velocity produces greater resonance. When negative, resonance is reduced. The effect is not applied when the value is zero.

**● TVF ENVELOPE**

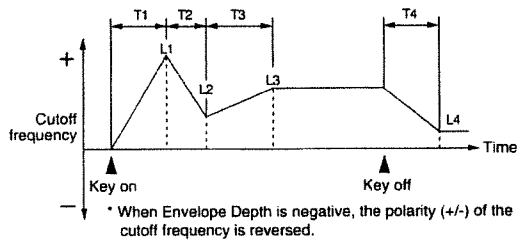

**<T1, T2, T3, or T4> TVF Envelope Time 1, 2, 3, or 4 — 0 to 127**

This sets the time T1, T2, T3, or T4 for the TVF Envelope. Larger values result in longer times until the next cutoff frequency is reached (for instance, T2 controls the time from L1 until L2 is reached).

**<L1, L2, L3, or L4> TVF Envelope Level 1, 2, 3, or 4 — 0 to 127**

This sets the level L1, L2, L3, or L4 for the TVF Envelope. It determines how much the cutoff frequency changes from the reference cutoff frequency (set with Cutoff Frequency) at each point. The change is higher than the reference cutoff frequency when this value is positive and lower than the reference cutoff frequency when this value is negative.

**■ Changing the Volume of a Rhythm Tone (TVA)**

You can use a TVA (Time Variant Amplifier) to select the change in volume for each of the Rhythm Tones.

**● TVA**

**<Level> Tone Level — 0 to 127**

This sets the volume of the Rhythm Tone.

**<Pan> Tone Pan — L64 to 0 to 63R**

Sets the panning (stereo position) for each of the Rhythm Tones.

L64 is leftmost, 0 is centered, and 63R is rightmost.

**<Random> Random Pan Depth — 0 to 63**

Panning changes irregularly each time a key is played. The value you set for this determines the range of change. There is no change when set to zero.

**<Alt> Alternate Pan Depth — L63 to 0 to R63**

The sound image is panned alternatingly to the right and left each time a key is played. The changes are made with the value set for Tone Pan at the center. There is no change when set to zero. If you set two Tones respectively to L and R, the stereo position is swapped each time they are played.

**● TVA VELOCITY**

**<Velocity Sens> TVA Envelope Velocity Sensitivity — -100 to +150**

This changes the level of the TVA Envelope according to velocity. When the value is positive, a larger velocity value results in a larger TVA Envelope level for a louder sound. When negative, a larger velocity value results in a smaller TVA Envelope level for a softer sound.

**<Velocity Time> Velocity Time Sensitivity — -100/-70/-50/-40/-30/-20/-10/0/+10/+20/+30/+40/+50/+70/+100**

This varies the entire TVA Envelope time according to velocity. When the value is positive, a larger velocity value results in faster change in the TVA Envelope time. The change is slowed when the value is negative.

**● TVA ENVELOPE**

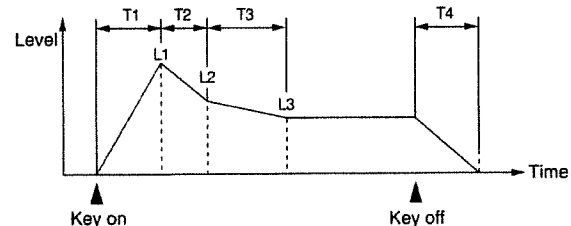

**<T1, T2, T3, or T4> TVA Envelope Time 1, 2, 3, or 4 — 0 to 127**

This sets the time T1, T2 or T3 for the TVA Envelope. Larger values result in longer times until the next volume is reached (for instance, T2 controls the time from L1 until L2 is reached).

**<L1, L2, or L3> TVA Envelope Level 1, 2, or 3 — 0 to 127**

This sets the level L1, L2, L3, or L4 for the TVA Envelope. It determines how much the volume changes from the reference volume (set with Tone Level) at each point.

# 4. System Mode

Pressing the [SYSTEM] button calls up the parameters for the System mode, no matter what mode you may be in at the time. The parameters you set here affect the entire **JV-1080**, so they remain effective even if you switch to the Patch mode or Performance mode, etc.(except for some parameters for the GM mode) These settings remain in memory even if you end your session without performing a write operation.

COMMON	EFFECTS	CONTROL	WAVE	LFO	PITCH	TVF	TVA
COMMON	EFFECTS	MIDI	PART	---	PITCH	PAN	LEVEL
SETUP	---	MIDI	---	---	TUNE	---	PREVIEW

## ■ Making Selections for Settings and the Display (SETUP)

This lets you make various settings for the **JV-1080**, and also adjust the brightness of the display.

### ● SYSTEM SETUP

#### <LCD> LCD Contrast — 1 to 10

This adjusts the contrast (brightness) for the display. A larger value results in a brighter screen.

#### <PowerUp> Powerup Mode — DEFAULT/LAST

This selects the screen displayed when you turn on the power.

##### DEFAULT:

The Patch "USER: 001" Play screen is displayed.

##### LAST:

The Play screen for the Patch, Performance, or GM mode selected before you last switched off the power is displayed.

#### <Patch Remain> Patch Remain Switch — OFF/ON

This selects whether the sounds of a previously played Patch or Rhythm Set are kept (ON) or not kept (OFF) when you change the Patch or Rhythm Set.

### ● RHYTHM EDIT KEY

#### <Source> Rhythm Edit Source — PANEL/PANEL & MIDI

This sets whether Rhythm Tones to be edited are to be chosen by operating the controls on the **JV-1080** (PANEL), or whether they can also be chosen with the keys on a MIDI keyboard connected to the unit (PANEL&MIDI).

##### PANEL:

Rhythm Tones can only be selected with the TONE SELECT buttons on the **JV-1080**.

##### PANEL&MIDI:

Rhythm Tones can be selected with the TONE SELECT buttons on the **JV-1080**, or by pressing the corresponding key on a MIDI keyboard connected to the **JV-1080** (see p. 34).

## ■ Making Settings for MIDI (MIDI)

This makes settings for MIDI receive channels and controllers.

The screen that is displayed depends on the mode you were in before you pressed the [SYSTEM] button.

### ● PERFORM MIDI (Performance MIDI)

This screen is displayed when you press [SYSTEM] while in the Performance mode.

#### <Control Channel> Control Channel — 1 to 16/OFF

This sets the channel for switching a Performance, which is different from the channels for the Parts of the Performance. If this channel matches the receive channel for any of the Parts, then Performance switching takes priority. Nothing is received when set to "OFF."

\* The MIDI receive channels for the Parts are set with Performance parameters.

#### <Clock> Clock Source — INT/MIDI

When controlling Tone or EFX parameters (such as Delay Time or LFO Rate) with the tempo clock, this selects whether the unit's built-in clock (INT) or the clock for an external MIDI device (MIDI) will be used.

\* The internal tempo clock is determined by the Default Tempo Performance Common parameter (see p. 57). However, this tempo clock is not output from MIDI OUT.

#### <Stack> Stack — OFF/1 of 2/2 of 2/1 of 3/.../8 of 8

The Stack function lets you combine two or more **JV-1080** units and increase the number of sounds that can be played simultaneously. You can hook up and use up to eight units.

#### [Usage with Three Connected Units]

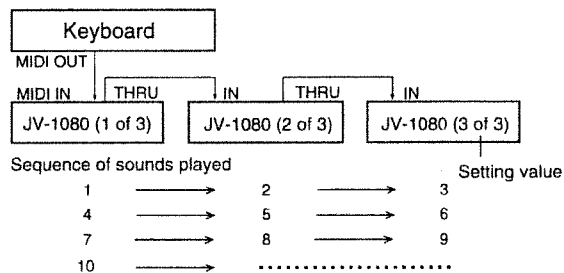

When set to "OFF," the Stack function is disabled and each **JV-1080** plays in sequence all of the note messages that are received.

\* The Stack function does not work with Patches or Rhythm Tones for which Solo or Portamento has been turned on.

Rhythm Sets are played on the first **JV-1080**, and Patches for which Solo or Portamento has been turned on are played on the second **JV-1080**.

### ● PATCH MIDI

This screen is displayed when you press [SYSTEM] while in the Patch mode.

<Receive Channel> Patch Receive Channel — 1 to 16  
This sets the MIDI receive channel in the Patch Play mode.

<Clock> Clock Source — INT/MIDI

When controlling Tone or EFX parameters (such as Delay Time or LFO Rate) with the tempo clock, this selects whether the unit's built-in clock (INT) or the clock for an external MIDI device (MIDI) will be used.

\* *The internal tempo clock is determined by the Default Tempo Patch parameter (see p. 42). However, this tempo clock is not output from MIDI OUT.*

<Stack> Stack — OFF/1 of 2/2 of 2/1 of 3/.../8 of 8

The Stack function lets you combine two or more JV-1080 units and increase the number of sounds that can be played simultaneously. See the description of the Performance MIDI Stack function.

## ● GM MODE MIDI

This screen is displayed when you press [SYSTEM] while in the GM mode.

<Clock> Clock Source — MIDI

Provides for control of EFX parameters (such as Delay Time) using the MIDI clock from an external device. In the GM mode, this parameter is always fixed to "MIDI". However, if no MIDI clock has arrived, the parameters will be controlled in accord with a calculation which converts a note's duration to what it should be at a tempo of 120 bpm.

<Stack> Stack — OFF/1 of 2/2 of 2/1 of 3/.../8 of 8

The Stack function lets you combine two or more JV-1080 units and increase the number of sounds that can be played simultaneously. See the description of the Performance MIDI Stack function.

## ● SYS-EXC MIDI (System Exclusive MIDI)

MIDI messages such as Performance and Patch data that are specific to certain devices are called "exclusive" messages, or SysEx messages. This sets how the JV-1080 exchanges SysEx messages with external MIDI devices.

<Unit #> Unit Number — 17 to 32

This setting ensures a match with the device ID number of the other device when exchanging SysEx messages.

<Rx.Exc> Receive System Exclusive — OFF/ON

This setting determines whether SysEx messages from an external device are received (ON) or not received (OFF).

<Tx.Exc> Transmit System Exclusive — OFF/ON

When a Patch or Rhythm Set parameter has been changed, this setting determines whether that information is sent (ON) or not sent (OFF) as a SysEx message.

<Rx.GM> Receive GM Message — OFF/ON

This setting determines whether GM MIDI messages from an external device are received (ON) or not received (OFF).

\* *Set Receive GM Message to "ON" when you want to play back a GM score, or if you want the JV-1080 to switch to the GM mode automatically.*

## ● CONTROL SOURCE

<Tap> Tap Control Source — OFF/HOLD-1/SOST/SOFT/HOLD-2

This setting determines what pedal information is used for control when the tempo of the MIDI clock is determined by how rapidly the pedal is depressed.

OFF:

No control

HOLD-1:

Hold 1 (Control Change # 64)

SOST:

Sostenuto (Control Change # 66)

SOFT:

Soft pedal (Control Change # 67)

HOLD-2:

Hold 2 (Control Change # 69)

When using Tap Control Source, the time intervals are calculated as shown below in order to determine what is recognized as being the duration of quarter notes. The tempo is altered to accord with this.

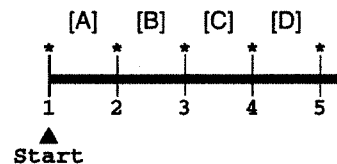

\* : Timing at which pedal is tapped

First: nothing occurs  
Second: interval of A  
Third: average of B and A intervals  
Fourth: average of C, B, and A intervals  
Fifth: average of D, C, B, and A intervals

From the fifth tap onwards, the value is always an average that includes the values for the four previous taps.

\* *Note, however, that if the value for the current interval will cause a reduction of more than 10% in the tempo, the unit will begin a new record of the averages (as in the second tap above).*

<Hold> Hold Control Source — OFF/HOLD-1/SOST/SOFT/HOLD-2

This setting determines what pedal information is used for control when the pedal is used to maintain (hold) sound parameters. The settings are the same as for Tap Control Source.

<Peak> Peak Control Source — OFF/HOLD-1/SOST/SOFT/HOLD-2

This setting determines what pedal information is used for control when the pedal is used to hold the maximum values of sound parameters. The settings are the same as for Tap Control Source.

\* *When each Control Source has been set to "HOLD-1," you should also set Hold 1 for Receive MIDI to "ON." When set to "SOST," "SOFT," or "HOLD-2," set Control Change for Receive MIDI (see p. 68) to "ON."*

## ● RECEIVE MIDI

<P.C Bnk C.C Vol Hld Bnd Mod Aft> — OFF/ON

This sets whether MIDI messages of each type are received (ON) or not received (OFF).

P.C:	Program Change
Hld:	Hold 1
Bnk:	Bank Select
Bnd:	Bender
C.C:	Control Change
Mod:	Modulation
Vol:	Volume
Aft:	Aftertouch

## ● CONTROL ASSIGN 1

<Control 1> System Control Source 1 — CC00 to CC95/BENDER/AFTERTOUCH

<Control 2> System Control Source 2 — CC00 to CC95/BENDER/AFTERTOUCH

These set two Controllers for making Tone and EFX parameters change in real time. You can assign a Control Change number (0 to 95), Bender, or Aftertouch.

Patches and Performances also have Controller settings, and when "SYS-CTRL1" is selected for them, the Controller set with System Control Source 1 is used. In the same way, choosing "SYS-CTRL2" causes the Controller set with System Control Source 2 to be used.

\* A Controller for which the switch for Receive MIDI, a System parameter, is set to "OFF" has no effect even if used.

\* The Tone parameters to be changed are set with the Patch Control Destination (☞ p. 49). EFX parameters to be changed are predetermined according to the EFX type (☞ p. 83).

\* Control Change messages contain predetermined functions, but the JV-1080 can assign and use functions that are different from these. You should be aware, however, that such usage does not conform to the operation of Control Change messages as prescribed by MIDI standards.

## ● CONTROL ASSIGN 2

<Volume> Volume Control Source — VOLUME/VOL+EXP

This makes the volume of Patches and Performance Parts change according to Control Change messages.

### VOLUME:

Change is effected only by Volume messages (Control Change # 7).

### VOL+EXP:

Change is effected by the addition of Volume messages and Expression messages (Control Change # 11).

<Aftertouch> Aftertouch Source — CH-AFTER/POLY-AFTER/CH&POLY

Aftertouch is a function that adds qualities such as vibrato, pitch bending, or other sound changes when a key that has already been played is then pressed with greater force. This setting lets you select the type of aftertouch to be received.

### CH-AFTER:

Only Channel Aftertouch is received. (With Channel Aftertouch, the effect is applied to all the notes on the same MIDI channel.)

### POLY-AFTER:

Only Polyphonic Aftertouch is received. (With Polyphonic Aftertouch, the effect is applied separately for each individual key.)

### CH&POLY:

Both Channel Aftertouch and Polyphonic Aftertouch are received.

## ■ Adjusting the Tuning (TUNE)

These settings let you tune the unit or fine-tune the pitch of a scale.

The screen that is displayed depends on the mode you were in before you pressed the [SYSTEM] button.

### ● TUNE

<Master Tune> Master Tune — 427.4 to 452.6

This sets the overall tuning for the JV-1080. The frequency of the A4 key is displayed as the value.

<Scale Tune> Scale Tune Switch — OFF/ON

This selects whether the Scale Tune function is to be used (ON) or not used (OFF).

### Scale Tune Function

Scale Tune is a function for fine-tuning each pitch from C to B. Tuning the notes of a single octave causes the pitch of all octaves to be fine-tuned. By making the settings for Scale Tune, you can set a variety of pitch tunings other than equal temperament.

#### ○ Equal Temperament

With this system, an octave is divided into 12 equal parts. This is the tuning system that is most widely used in Western music. The JV-1080 uses equal temperament when Scale Tune Switch is set to "OFF."

#### ○ Pure Temperament (C is Tonic)

The three fundamental chords resound beautifully compared with even temperament. However, this effect can be obtained in only one key, and transposition makes the chord ambiguous. Some sample settings for keys that take C as the tonic are given here.

#### ○ Arabian Scale

In this scale, E and B are a quarter-tone lower and C#, F#, and G# are a quarter-tone higher than in even temperament. The intervals from G to B, C to E, F to G#, A# to C#, and D# to F# have a neutral third (the interval between a major third and a minor third). With the JV-1080, you can enjoy the Arabian scale in three keys — G, C, and F.

Note	Even Temperament	Pure Temperament (C is Tonic)	Arabian Scale
C	0	0	-6
C#	0	-8	+45
D	0	+4	-2
D#	0	+16	-12
E	0	-14	-51
F	0	-2	-8
F#	0	-10	+43
G	0	+2	-4
G#	0	+14	+47
A	0	-16	0
A#	0	+14	-10
B	0	-12	-49

## ● PART SCALE

This screen is displayed when you press the [SYSTEM] button while in the Performance mode.

### Scale Tune C to B — -63 to +63 [PALETTE]

This sets the pitch of each note for the currently selected Performance Part. The setting is in increments of one cent (1/100th of a semitone). There are two screens — one for the black keys and one for the white keys.

## ● PATCH SCALE

This screen is displayed when you press the [SYSTEM] button while in the Patch mode.

### Scale Tune C to B — -63 to +63 [PALETTE]

This sets the pitch of each note for the currently selected Patch. The setting is in increments of one cent (1/100th of a semitone). There are two screens — one for the black keys and one for the white keys.

\* Pressing a key from C to B on the MIDI keyboard causes the on-screen cursor to move to the selected key.

## ■ Using the JV-1080's Controls to Play Test Sounds (PREVIEW)

Even when no MIDI keyboard is connected to the JV-1080, you can play test sounds by pressing the VOLUME knob. The settings you make here determine how these test sounds are played.

## ● PREVIEW MODE

### <Mode> Preview Sound Mode — SINGLE/CHORD

This sets how the test sounds will be played. When set to "SINGLE," the sounds are played sequentially, one at a time. The sounds are played together when set to "CHORD." The sound itself is set with Preview Key described below.

## ● PREVIEW KEY

### <Note 1-4> Preview Key Set 1 to 4 — C-1 to G9

This sets the pitches and note numbers for the test sounds. You can set up to four sounds.

## ● PREVIEW VELOCITY

### <Note 1-4> Preview Velocity Set 1 to 4 — 1 to 127

This sets the volume for the test sounds, with separate settings for notes 1 to 4.

# 5. Utility Mode

You can enter the Utility mode from any other mode simply by pressing the [UTILITY] button. The Utility mode lets you perform operations such as writing edited data to memory, copying data, or sending data to another device. In addition, the parameters you set in this mode remain in force even if you switch to another mode later.

Here's how to get around in the Utility mode.

1. Press [UTILITY] to make the indicator light up and display the menu screen.



Press the FUNCTION SELECT button on the left side under the display

2. Press the FUNCTION SELECT button corresponding to the position of the display menu items to call up the Parameter Setting screen for the selected menu item. Another way to get to the Parameter Setting screen is to use the [◀]/[▶] buttons to move the cursor and make the desired menu item blink, then press the [ENTER] button.
3. Use the [◀]/[▶] buttons to move the cursor to the desired parameter, then use the VALUE knob or the [INC]/[DEC] buttons to change the value. (The details of the settings are explained for each item.)
4. The message "[Press ENTER]" appears in the right-hand corner of the Parameter Setting screen. After making the setting, press [ENTER] to put it into effect. When the operation is finished, the message "COMPLETE" is displayed.

- \* If you want to stop an operation that is in progress, press the [EXIT] button.
- \* If you press [UTILITY] while in the GM mode, only one GM Setup screen is displayed. For details, see "Chapter 4 — Other functions of the JV-1080" (p. 76).

## ■ Saving the Data You've Created (WRITE)

This writes edited data to the unit's User Memory, or to a DATA Card. The screen that is displayed depends on the mode you were in before you pressed the [UTILITY] button.

- \* If you want to write data to the User Memory, first make sure that Internal Protect (p. 72) is set to "OFF." If you leave it on, then the following screen appears when you try to write the data.



To cancel, press [EXIT]. Pressing [UTILITY] forces the data to be written.

- \* If you want to write data to a DATA Card, first insert a DATA Card into the DATA Card slot, and make sure that the

DATA Card's protect switch is off. After writing the data, turn the protect switch back on to prevent data loss.

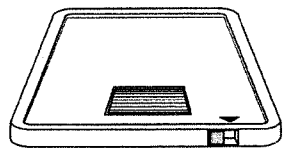

OFF → ON

When [UTILITY] is pressed while in the Performance mode...

### ● PERFORM WRITE (Performance Write)

This takes the Performance data in the temporary area and writes it to memory. Use the VALUE knob, the [INC]/[DEC] buttons, or the SOUND GROUP buttons to select the Performance Number ("Number") for the write destination.



Performance Name of the write destination

Performance Number of the write destination (USR = User Memory, CRD = DATA Card)

The name of the selected Performance appears in parentheses.

When [UTILITY] is pressed while in the Patch mode...

### ● PATCH WRITE

This takes the Patch data in the temporary area and writes it to memory.



Patch Name of the write destination

Patch Number of the write destination (USR = User Memory, CRD = DATA Card)

Use the VALUE knob, the [INC]/[DEC] buttons, or the SOUND GROUP buttons to select the Patch Number ("Number") for the write destination.

The name of the selected Patch appears in parentheses.

If you want to check the sound of the write destination Patch...

When you're performing a Patch Write operation, pressing [UTILITY] before executing the write operation displays the Patch Compare screen. Patch Write is the only operation that lets you do this. When you've displayed this screen, you can play the MIDI keyboard to check the sound of the write destination Patch. This handy feature can help prevent the overwriting of important Patches. You can also change Patches while at this screen. To return to the Patch Write screen, press [UTILITY].



Patch Name of the write destination

Patch Number of the write destination (USR = User Memory, CRD = DATA Card)

- \* Note that from the Compare screen the sound may not always sound the same as it does in the Play mode.

.....  
When [UTILITY] is pressed while in the Rhythm Set mode...



Rhythm Set Number of the write destination  
(USR = User Memory, CRD = DATA Card)  
Rhythm Set Name of the write destination

### ● RHYTHM WRITE (Rhythm Set Write)

This takes the Rhythm Set data in the temporary area and writes it to memory.

Use the VALUE knob, the [INC]/[DEC] buttons, or the SOUND GROUP buttons to select the Rhythm Set Number ("Number") for the write destination.

The name of the selected Rhythm Set appears in parentheses.

## ■ Copying Data (COPY)

This copies Patch Performance, or Rhythm Set data to the temporary area. The screen that appears depends on the mode you were in before you pressed the [UTILITY] button.

.....  
When [UTILITY] is pressed while in the Performance mode...

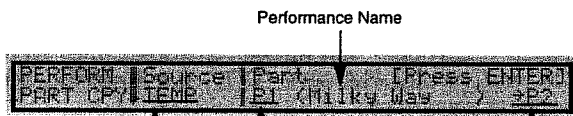

Performance Name  
Copy source  
TEMP: Performance in temporary area  
USR: Performance in User Memory  
CRD: Performance on DATA Card  
PRA/PRB: Preset A/B Performance  
Copy source Part  
Copy destination Part (temporary area)

### ● PERFORM PART CPY (Performance Part Copy)

This copies the settings for one Performance Part to some other Performance Part in the temporary area.

Use the VALUE knob, [INC]/[DEC] buttons, or SOUND GROUP buttons to select the copy source ("Source").

Use the VALUE knob or [INC]/[DEC] buttons to choose the Parts ("Part") for the copy source and copy destination.

The name of the selected Performance appears in parentheses.

### ● PERFORM FX COPY (Performance Effect Copy)

This takes the settings for an Effect already in memory and copies them to a Performance in the temporary area. You can also copy Patch Effect settings.

Use the VALUE knob or [INC]/[DEC] buttons to select the copy source ("Source").

Use the VALUE knob, [INC]/[DEC] buttons, or SOUND

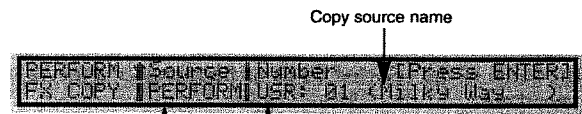

Copy source name  
Copy source  
PERFORM: Performance Effect settings  
PATCH: Patch Effect settings  
Copy source number  
USR: User Memory  
CRD: DATA Card  
PRA to PRC: Preset A to C  
GM: Preset D

GROUP buttons to choose the copy source number ("Number").

The name of the selected Performance or Patch appears in parentheses.

.....  
When [UTILITY] is pressed while in the Patch mode...

### ● PATCH TONE COPY

This copies the settings for one Patch Tone to another Patch Tone in the temporary area.

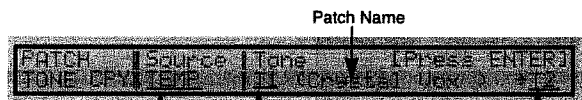

Patch Name  
Copy source  
TEMP: Patch in temporary area  
USR: Patch in User Memory  
CRD: Patch on DATA Card  
PRA to PRC: Preset A to C Patch  
GM: Patch in Preset D  
Copy source Tone  
Copy destination Tone (temporary area)

Use the VALUE knob, [INC]/[DEC] buttons, or SOUND GROUP buttons to select the copy source ("Source").

Use the VALUE knob or [INC]/[DEC] buttons to choose the Tones ("Tone") for the copy source and copy destination.

The name of the selected Patch appears in parentheses.

### ● PATCH FX COPY (Patch Effect Copy)

This takes the settings for an Effect already in memory and copies them to a Patch in the temporary area. You can also copy Performance Effect settings.



Copy source name  
Copy source  
PATCH: Patch Effect settings  
PERFORM: Performance Effect settings  
Copy source number  
USR: User Memory  
CRD: DATA Card  
PRA to PRC: Preset A to C  
GM: Preset D

Use the VALUE knob or [INC]/[DEC] buttons to select the copy source ("Source").

Use the VALUE knob, [INC]/[DEC] buttons, or SOUND GROUP buttons to choose the copy source number ("Number").

The name of the selected Patch or Performance appears in parentheses.

When [UTILITY] is pressed while in the Rhythm Set mode...

### ● RHYTHM KEY COPY

This copies the settings for one Rhythm Key to some other Rhythm Key in the temporary area.

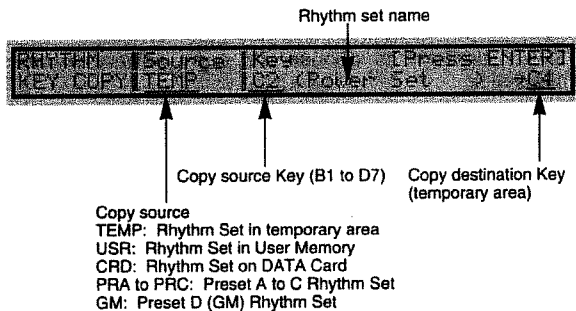

Use the VALUE knob, [INC]/[DEC] buttons, or SOUND GROUP buttons to select the copy source ("Source").

Use the VALUE knob, the [INC]/[DEC] buttons, or the keys on the keyboard to choose the keys ("Key") for the copy source and copy destination.

## ■ Initializing Data (INITIALIZE)

This returns Patch, Performance, and Rhythm Set parameters in the temporary area to their standard values and factory default data.

Because only data in the temporary area is initialized, data written to memory is not overwritten by the Initialize operation.

There are two methods for Initialize (Mode):

#### DEFAULT:

All parameters in the temporary area are returned to their standard values.

#### PRESET:

Only data in the temporary area is returned to the values of the data in the User Memory in effect when the unit was shipped from the factory (i.e., items with the same Program Numbers are affected). However, with Patches such as those on an expansion board, where the Program numbers exceed 128, all of them above number 128 will be given the values for USER: 128.

Use the VALUE knob or the [INC]/[DEC] buttons to make the Mode setting at the respective setting screens.

When [UTILITY] is pressed while in the Performance mode...

### ● PERFORM INIT (Performance Initialize)

This initializes the Performance data called up to the temporary area.

When [UTILITY] is pressed while in the Patch mode...

### ● PATCH INIT (Patch Initialize)

This initializes the Patch data called up to the temporary area.

When [UTILITY] is pressed while in the Rhythm Set mode...

### ● RHYTHM KEY INIT (Rhythm Key Initialize)

This initializes the data for the Rhythm Tones in the Rhythm Set called up to the temporary area that are assigned to specific keys..

\* Use the VALUE knob, [INC]/[DEC] buttons, or the keys on the keyboard to choose the keys (B1 to D7) to be initialized.

### ● RHYTHM SET INIT (Rhythm Set Initialize)

This initializes the Rhythm Set data called up to the temporary area.

## ■ Protecting Data (PROTECT)

"Protection" means to prohibit writing to the JV-1080, thereby preventing valuable data from being mistakenly overwritten.

### ● WRITE PROTECT

<Internal> Internal Protect — OFF/ON

This prevents the contents of User Memory from being accidentally overwritten. This function is enabled when set to "ON" and cancelled when set to "OFF." It is always on when the power is turned on.

\* Set this to "OFF" when writing data for Patches or the like from a DATA Card or the temporary area to User Memory.

<Exclusive> Exclusive Protect — OFF/ON

This prevents the contents of User Memory or a DATA Card from being overwritten by an Exclusive (SysEx) message from an external MIDI device. This function is enabled when set to "ON" and cancelled when set to "OFF." It is always OFF when the power is turned on.

\* When Exclusive Protect is set to "OFF," the internal memory can be overwritten by SysEx messages even if Internal Protect is set to "ON."

## ■ Using a DATA Card (CARD)

This lets you perform operations such as copying the data in the JV-1080 to a DATA Card, or swapping data between the JV-1080 and a DATA Card.

### ● CARD FUNCTION



Four menu items for the DATA Card are displayed.



### FORMAT:

Initializes a DATA Card for use by the **JV-1080**.

### RENAME:

Changes the name of a DATA Card.

### COPY:

Copies data from a DATA Card to User Memory, or from User Memory to a DATA Card.

### SWAP:

Swaps data between a DATA Card and User Memory.

When you use the FUNCTION SELECT or [◀]/[▶] buttons to select a menu item and press [ENTER], the display changes to the setting screen for the menu item you've chosen.

## ● FORMAT

This formats (initializes) a new DATA Card or a DATA Card that has previously been used with a different model, thereby enabling it to be used by the **JV-1080**. When you format a DATA Card, you can give it a name up to 12 characters in length. The same procedure that you use to change a Patch name can be used to change a DATA Card name.

### Available characters:

Space, A to Z, a to z, 0 to 9, +-\* / ! = ? < > ( ) [ ] { } ; : , " ' ~ # % & \$ % ^ \_

If the DATA Card had a previous name, it appears in parentheses.

## ● RENAME

This overwrites the existing name of a DATA Card. You can give the card a new name up to 12 characters in length. The procedure is the same as when naming a new DATA Card.

The previous name of the DATA Card is displayed in parentheses.

## ● CARD COPY

This copies data in User Memory to a DATA Card. You can also use it to copy data from a DATA Card to User Memory.

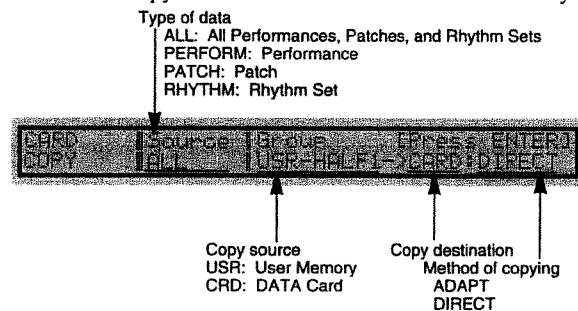

Use the VALUE knob, [INC]/[DEC] buttons, or SOUND GROUP buttons to select the type of data ("Source"), copy source and destination ("Group"), and method of copying.

The **JV-1080** can store 128 Patches, 32 Performances, and two Rhythm Sets in User Memory. However, the amount of data that can be contained in an M-256E DATA Card is 64 Patches, 16 Performances, and one Rhythm Set. As you can see, the M-256E has only half the storage space of User Memory. This means that when you exchange data with the M-256E, the data in User Memory is copied as a first half (USR-HALF1) and a second half (USR-HALF2).

When you select "ALL" for Source, the following methods of copying are used.

There are two methods of copying — ADAPT and DIRECT. The method of copying the Patches selected for the Performance Parts varies according to the setting.

### ADAPT:

The Patches selected for the Parts are stored as "CRD" on the DATA Card or as "USR" in User Memory.

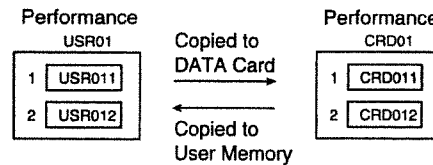

### DIRECT:

Performances are stored as "CRD" on the DATA Card or as "USR" in User Memory, but the Patches selected for the Parts are stored under their own names, which remain unchanged.

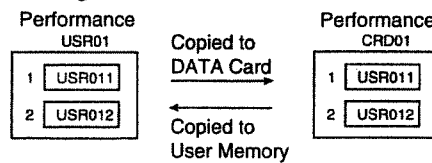

\* When "ALL" has been selected for Source, please be aware that if a Performance using a Patch in the second half (No. 65 to 128) is copied to USR-HALF1, the Patches in the second half are not saved on the M-256E DATA Card. Similarly, if a Performance using a Patch in the first half (No. 1 to 64) is copied to USR-HALF2, the Patches in the first half are not saved on the M-256E DATA Card.

## ● CARD SWAP

This takes Patch, Performance, and Rhythm Set data in User Memory and swaps it with the corresponding data on a DATA Card.

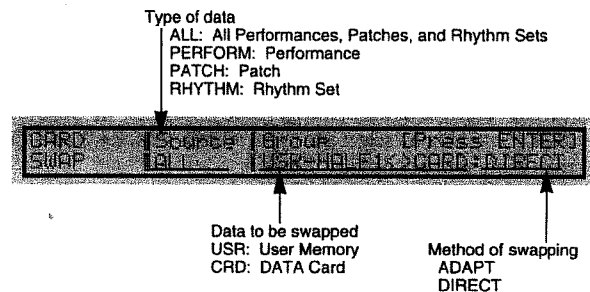

\* See CARD COPY for information on how to set each parameter.

### Important!

The **JV-1080** lets you combine User Memory data and DATA Card data to create Performances. However, if set the Copy (SWAP) method to ADAPT, and you try to copy such data from User Memory to the DATA Card or from the DATA Card to User Memory, the following may occur.

### Example:

Let's say that there is a Performance USR01, which specifies a Patch using USR012 for Part 1 and CRD011 for Part 2. When copying from User Memory to the DATA Card, this Performance is stored on the DATA Card as CRD01. At this time the Part 1 Patch is stored as CRD012, and Part 2 is stored without change as CRD011.

Thereafter, if you copy the data on the DATA Card to User Memory, the Performance is stored in User Memory as USR01 and Part 1 is stored as USR012, but Part 2 is stored as USR011. This means that even though the number of the Performance is the same as the original data, the Patch number specified by Part 2 has changed.

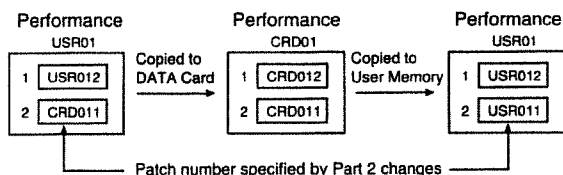

If you want to store data in User Memory just as it is, select DIRECT as the copy (or swap) method, or perform a Bulk Dump.

## ■ Copying a Specific Range of Data (BLOCK COPY)

This defines and copies a range of Performance, Patch, or Rhythm Set data.

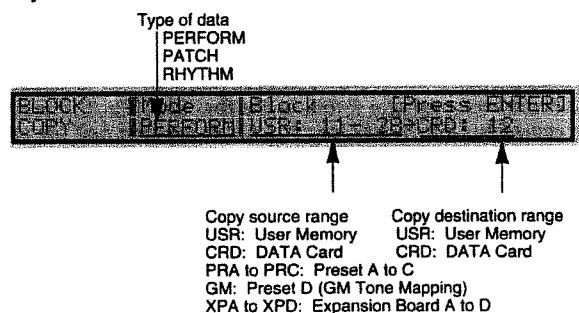

### ● BLOCK COPY

Use the VALUE knob, [INC]/[DEC] buttons, or SOUND GROUP buttons to select the type of data ("Mode") and the range of data to be copied ("Block").

\* The following message will appear if you attempt to carry out the procedure when the amount of data at the source is larger than that at the copy destination.

Block Copy Range is Overflow

Should this happen, the JV-1080 will try to send each item of data in order until the copy destination reaches its capacity.

In the example shown above, there are eighteen Performances included in the copy source (USER: 11-28), and the first number at the copy destination is set as CRD: 12. However, since Performances can be stored on an M-256E card only up to the CRD: 16 location, the number of Performances that can be copied is five (CRD: 12-16).

## ■ Sending Data to an External MIDI Device (BULK DUMP)

This takes data in the JV-1080 or on a card and uses MIDI to send it to a sequencer or some other MIDI device. When you use this function, make sure that both the sending device and the receiving device are set to the same MIDI channel and device ID number (\* p. 67).

### ● BULK DUMP

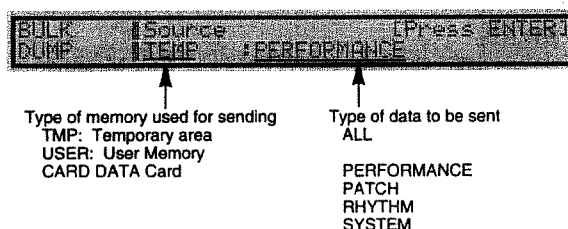

Use the VALUE knob, [INC]/[DEC] buttons to select the type of memory and data for sending ("Source").

The following types of data can be sent.

**When TMP is selected:**

PERFORM: Data for Performances or Patches/Rhythm Sets in Parts in the temporary area is sent.

PATCH: Data for Patches in the temporary area is sent.

RHYTHM: Data for Rhythm Sets in the temporary area is sent.

SYSTEM: System data is sent.

**When USER is selected:**

ALL: All data in user memory is sent.

PERFORM: All Performance data in user memory is sent. Data for Patches/Rhythm Sets in Parts is not sent.

PATCH: All Patch data in user memory is sent.

RHYTHM: All Rhythm Set data in user memory is sent.

**When CARD is selected:**

ALL: All data on a DATA card is sent.

PERFORM: All Performance data on a DATA card is sent. Data for Patches/Rhythm Sets in Parts is not sent.

PATCH: All Patch data on a DATA card is sent.

RHYTHM: All Rhythm Set data on a DATA card is sent.

While sending is in progress, the following message appears on the display:

Transmitting \*\*\*\*\*

When sending data is finished, the following message will appear:

COMPLETE

If you want to stop sending data, press [EXIT].

## ■ Returning Settings to Their Factory Defaults (FACTORY PRESET)

This returns all settings for the JV-1080 to the data in effect when the unit was shipped from the factory.

### ● FACTORY PRESET

Press [ENTER] to execute and return the data to its factory defaults.

# Chapter 4

## Other functions of the JV-1080

This chapter explains various ways to take advantage of the **JV-1080**'s functionality, such as using GM mode to play back performance data, selecting sounds from an external device, and using the built-in effects.

---

# 1. Using the JV-1080 with a DTMS (playing back GM scores)

The **JV-1080**'s GM mode allows it to be used as the sound source for a DTMS (Desk Top Music System). In GM mode, the **JV-1080** can play back a GM score (performance data created for a GM sound generator). You can also modify the settings of various parameters as explained later in this section for even more musical expressivity.

The following diagram is an example of connections with a Macintosh.

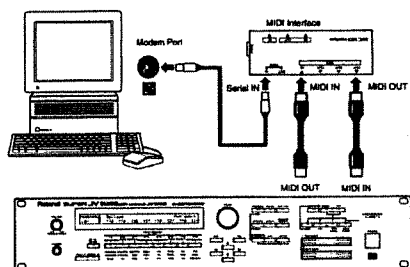

## ■ Selecting GM mode

The sound source of the **JV-1080** can be set to be compatible with the GM system standard. In GM mode, the sound source is organized in essentially the same way as for performance mode. GM patches are assigned to each Part from 1—16, and a GM rhythm set is assigned to Part 10.

**1** If you wish to manually select GM mode, press [SHIFT] + [PERFORM].

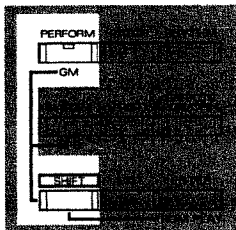

As an alternative to the above procedure, the **JV-1080** will automatically enter GM mode when it receives a GM System On message, for example when a GM score that contains a GM System On message at the beginning of the song is played back by a sequencer.

### GM System On message:

This is a MIDI message that causes a sound source to put itself in GM mode and initialize itself to the settings appropriate for a GM sound source.

- \* If the GM score is played back from the middle of the song, the playback may not be correct since the **JV-1080** will not have switched to GM mode.
- \* To correctly play back a GM score, we recommend that you select GM mode manually.
- \* If the System parameter Receive GM Message (p. 67) has been set "OFF," GM System On messages will not be received.
- \* In GM mode you can make following System parameter settings for GM mode that are independent of the Patch/Performance/Rhythm Set modes. System Parameter values that have been set for GM mode are preserved even when GM mode is exited, and will be restored when GM mode is entered once again.

Receive MIDI page:

All of receive switch

CONTROL ASSIGN 1 page:  
System Control Source 1

CONTROL ASSIGN 2 page:  
Volume Control Source

Aftertouch Source

SCALE TUNE page:

Scale Tune Switch

- \* When the **JV-1080** enters GM mode, the following System parameters will be automatically fixed at the following settings. It is not possible to change these settings.

GM MODE MIDI Page:

Clock Source: MIDI

SYS-EXC MIDI Page:

Receive System Exclusive: OFF

RECEIVE MIDI Page:

Receive Bank Select: OFF

When you exit GM mode, these System parameters will be restored to their previous settings.

## ■ Initializing the GM mode

In order for a GM score to be played back correctly, the **JV-1080** must be reset to the basic GM settings. This operation is called Initialize GM Mode, and will occur at the following times.

- When a GM System On is received from an external MIDI device.
- When a GM System On message has been recorded in the performance data being played back.
- When the **JV-1080**'s power is turned on.
- When you execute the Utility mode command GM Setup.

When you press [UTILITY] while in GM mode, the utility display will be different than at other times. The following display will appear:



Press [ENTER], and the current GM mode settings will be initialized. Press [EXIT], and you will return to the previous display.

- \* When you execute Initialize GM Mode, all previous GM mode settings will be overwritten.
- \* When you initialize GM mode, the following System parameters will be automatically set to the following values.

RECEIVE MIDI Page:

Receive Bank Select: OFF

Other MIDI receive switches: ON

CONTROL ASSIGN1 Page:

System Control Source 1: AFTERTOUCH

CONTROL ASSIGN2 Page:

Volume Control Source: VOL&EXP

Aftertouch Source: CH-AFTER

When you exit GM mode, these System parameters will be restored to their previous settings.

### Playing back a GM score

GM performance data that is intended for playback on a GM system will carry the GM logo. Performance data carrying the GM logo is referred to as GM Score data, and can be played back with the same musical result on any sound source that carries the GM logo (i.e., any GM-compatible sound source). **JV-1080** is a GM-compatible sound source, and can play back GM scores correctly.

However the **JV-1080** also has a variety of enhanced functions which are not part of the GM system definition. Performance data created utilizing these functions may not play back correctly on other GM systems.

## 2. Enhancing Musical Expression in GM Mode

The **JV-1080** provides parameters that can be edited for each GM part. By adjusting effect and sound parameters you can create a more musically expressive performance.

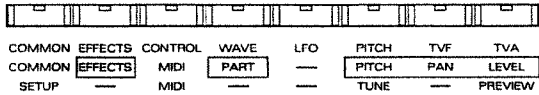

\* If you execute the Initialize command all these settings will be lost.

### ■ Adjusting the Effects (EFFECTS)

#### ● OUTPUT

<Output Assign> Output Assign —  
MIX/EFX/OUTPUT1/OUTPUT2/PATCH [PALETTE]  
Output Level — 0 to 127 [PALETTE]

The Output Assign parameter specifies the output destination of each Part, and the Output Level sets the output level.

##### MIX:

The unprocessed sound will be sent to MIX OUT, and also sent to chorus and reverb.

##### EFX:

The unprocessed sound will be sent to EFX, and also sent to chorus and reverb. The output destination of the sound passing through EFX will depend on the Output Assign setting for the GM EFX OUT.

##### OUTPUT1:

The unprocessed sound alone will be sent to OUTPUT 1.

##### OUTPUT2:

The unprocessed sound alone will be sent to OUTPUT 2.

##### PATCH:

The unprocessed sound will be sent to the destination specified by the Output Assign (p. 45) of the Patch selected for the Part. The output level, chorus send level, and reverb send level of the Part will be multiplied by the values of the Patch.

\* If you select OUTPUT 1 or 2 as the output destination, the chorus and reverb settings will be ignored.

\* If you wish to use the output settings of each Tone, select PATCH. If you select a setting other than PATCH, the output settings of each Tone (output assign, output level, chorus/reverb send level) will be ignored, and the output settings of the Part will be used instead.

<Chorus> Chorus Send Level — 0 to 127 [PALETTE]

This parameter sets the level of the signal sent to the chorus for each Part.

<Reverb> Reverb Send Level — 0 to 127 [PALETTE]

This parameter sets the level of the signal sent to the reverb for each Part.

#### ● GM EFX TYPE

<Type> EFX Type

This parameter selects the type of EFX used in GM mode. For the available EFX types, refer to "Chapter 5. Multi-Effector EFX (p. 83)."

#### ● GM EFX PRM (GM EFX Parameter)

This is where you make parameter settings for the EFX that was selected in EFX Type.

The available parameters will depend on the EFX type. For details on EFX parameters, refer to "Chapter 5. Multi-Effector EFX (p. 83)."

#### ● GM EFX OUT (GM EFX Output)

This is where you specify the output routing of the sound from the EFX when the OUTPUT parameter Output Assign has been set to EFX.

<Output Assign> Output Assign —  
MIX/OUTPUT1/OUTPUT2

Output Level — 0 to 127

The Output Assign parameter determines the output destination of the EFX sound, and the Output Level parameter sets the level of the output signal.

##### MIX:

The EFX sound will be sent to MIX OUT, and also to chorus and reverb.

##### OUTPUT1:

The EFX sound will be sent to OUTPUT1.

##### OUTPUT2:

The EFX sound will be sent to OUTPUT2.

\* If you select OUTPUT 1 or 2 as the output destination, the chorus and reverb settings will be ignored.

<Chorus> Chorus Send Level — 0 to 127

This parameter sets the level of the signal sent from EFX to the chorus.

<Reverb> Reverb Send Level — 0 to 127

This parameter sets the level of the signal sent from EFX to the reverb.

#### ● GM CHORUS

Chorus adds depth and spaciousness to the sound.

<Rat> Chorus Rate — 0 to 127

This parameter sets the modulation speed of the chorus.

<Dpt> Chorus Depth — 0 to 127

This parameter sets the modulation depth of the chorus.

<Dly> Pre Delay — 0 to 127

This parameter sets the time delay from when the original sound begins to when the chorus sound begins. Higher values result in a more spacious sound.

<Fbk> Chorus Feedback — 0 to 127

This parameter sets the amount of sound returned (fed back) from the chorus output back into the chorus input. Higher values result in a more complex chorus sound.

<Level> Chorus Level — 0 to 127

This parameter sets the volume of the chorus sound.

<Output> Chorus Output Assign —  
MIX/REVERB / MIX+REV

This parameter sets the output routing of the chorus sound.

##### MIX:

The chorus sound will be output from MIX OUT.

##### REVERB:

The chorus sound will be output to the reverb.

##### MIX+REV:

Chorus sound output to both MIX OUT and reverb.

## ● GM REVERB

Reverb simulates the reverberation of a variety of acoustic spaces, adding spatial ambience to the sound.

### <Type> Reverb Type

This parameter selects the type of reverb.

#### ROOM1:

A short reverb with high density reflections.

#### ROOM2:

A short reverb with low density reflections.

#### STAGE1:

A reverb with strong late reverberation.

#### STAGE2:

A reverb with strong early reflections.

#### HALL1:

A reverb with clear reverberation.

#### HALL2:

A reverb with rich reverberation.

#### DELAY:

A conventional delay.

#### PAN-DLY:

A delay that pans (moves) the reflections to left and right.

### <Time> Reverb Time — 0 to 127

When the Type is ROOM1—HALL2, this parameter sets the time length of the reverberation. When the Type is DELAY or PAN-DLY, this parameter sets the delay time. Higher values result in a wider-sounding acoustic space.

### <Lev> Reverb Level — 0 to 127

This parameter sets the volume of the reverberation.

### <Fbk> Delay Feedback — 0 to 127

When the Type is DELAY or PAN-DLY, this parameter sets the amount of delayed sound that is returned (fed back) to the delay. Higher values result in more delay repeats.

### <HF Damp> High-Frequency Damp —

200/250/315/400/500/630/800/100/1250/1600/2000/2500/3150/4000/5000/6300/8000/BYPASS

This parameter sets the frequency at which the high frequencies will be cut.

Higher settings will result in a brighter-sounding reverb. When BYPASS is selected, the high frequencies will not be cut.

#### Internal effects in GM sound sources

The references in this manual to "GM chorus" and "GM reverb" may have caused you to conclude that these are part of the General MIDI specification.

It is true that most recent GM-compatible sound sources do have internal effects such as chorus and reverb, but the use of effect units is not specified in the General MIDI System Level 1 guidelines. This means that performance data created for the GM mode of the JV-1080 may not play back correctly on other GM sound sources.

## ■ Selecting a Patch for each Part (PART)

### <Number> Patch Number — 001 to 128 [PALETTE]

Select a GM patch number for each Part. The name of the selected GM patch will be displayed in parentheses ( ).

\* In GM mode, it is not possible to select User, Card, Preset A—C or Expansion Board patches.

## ■ Adjust the pitch of each Part (PITCH)

These parameters adjust the pitch of each Part.

### ● PITCH

#### <Pitch Coarse> Pitch Coarse Tune — -48 to +48

[PALETTE]

This parameter adjusts the pitch of each Part in semitone steps over a range of +/-4 octaves.

This parameter adjusts the pitch relative to a Patch pitch setting of 0.

#### <Pitch Fine> Pitch Fine Tune — -50 to +50

[PALETTE]

This parameter is a further fine adjustment to the pitch specified by Pitch Coarse Tune, in steps of 1 cent (1/100th of a semitone) over a range of 1/2 semitone up or down.

## ■ Adjusting the pan position of each Part (PAN)

This parameter sets the pan position of each Part.

### ● PAN

#### <Part Pan> Part Pan — L64 to 0 to 63R

This parameter sets the pan (stereo location) of each Part.

A setting of L64 is full left, 0 is center, and 63R is full right.

\* There is also a pan setting inside each Patch, and the Part Pan setting of will adjust the Patch pan setting by the specified amount.

## ■ Adjusting the volume of each Part (LEVEL)

This parameter sets the volume level of each Part.

### ● LEVEL

#### <Level> Part Level — 0 to 127 [PALETTE]

This parameter adjusts the volume level of each Part. You will use this parameter mainly to adjust the volume balance between Parts.

# 3. Live Performance Techniques

## ■ Selecting JV-1080 sounds from an external device

If you wish to select sounds or drum kits from an external MIDI device, use the following procedure.

On the **JV-1080**, Patches, Performances, and Rhythm Sets are selected by the values of the Bank Select (control changes # 0 and # 32) message and Program Change message. When you press a sound select button on a MIDI keyboard, these MIDI messages will be transmitted automatically. However if you wish to select **JV-1080** sounds from a sequencer or personal computer, use the following procedure to transmit the appropriate MIDI messages.

- 1 Set the transmitting and receiving devices to the same MIDI channel.
- 2 Transmit a Control Change # 0 (Bank Select MSB) message with the desired value.
- 3 Transmit a Control Change # 32 (Bank Select LSB) message with the desired value.
- 4 Transmit a Program Change message with the desired value.

\* When the **JV-1080** receives a Program Change message without having received a Bank Select message, it will select a sound only from the currently specified memory (Preset A, User, etc.).

## ● Selecting a Patch

Bank Select MSB	Bank Select LSB	Program Change	Patch Group	Patch Number
80	0	0—127	User	#1—#128
81	0	0—127	Preset A	#1—#128
81	1	0—127	Preset B	#1—#128
81	2	0—127	Preset C	#1—#128
81	3	0—127	Preset D (GM)	#1—#128
82	0	0—127	DATA card	#1—#128
83	0	0—127	PCM card	#1—#128
84	0	0—127	Expansion A	#1—#128
84	1	0—127	Expansion A	#129—#256
84	2	0—127	Expansion B	#1—#128
84	3	0—127	Expansion B	#129—#256
84	4	0—127	Expansion C	#1—#128
84	5	0—127	Expansion C	#129—#256
84	6	0—127	Expansion D	#1—#128
84	7	0—127	Expansion D	#129—#256

For example if you wanted to select Patch number 10 of Preset B, you would transmit the following data to the **JV-1080**.

(Numbers are given in decimal.)

Control Change # 0 (Bank Select MSB) value: 81

Control Change # 32 (Bank Select LSB) value: 1

Program Change value: 9

\* The Program Change number transmitted should be one less than the Patch number.

## ● Selecting a Performance

Bank Select MSB	Bank Select LSB	Program Change	Performance Group	Performance Number
80	0	0—31	User	#1—#32
81	0	0—31	Preset A	#1—#32
81	1	0—31	Preset B	#1—#32
82	0	0—31	DATA card	#1—#32

If you wish to select a Performance, set the transmitting MIDI device to the same channel as the Performance Control Channel (see p. 66). If you wish to select the Patch or Rhythm Set of a Part, set the transmit channel to match the receive channel of the Part. However if the Control Channel is the same as the receive channel of a Part, the Control Channel will take priority and a Performance (not a Patch) will be selected by the incoming program change message.

## ● Selecting a Rhythm Set

Bank Select MSB	Bank Select LSB	Program Change	Rhythm Set Group	Rhythm Set Number
80	0	0, 1	User	#1, #2
81	0	0, 1	Preset A	#1, #2
81	1	0, 1	Preset B	#1, #2
81	2	0, 1	Preset C	#1, #2
81	3	0, 1	Preset D (GM)	#1, #2
82	0	0—127	DATA card	#1—#128
83	0	0—127	PCM card	#1—#128
84	0	0—127	Expansion A	#1—#128
84	1	0—127	Expansion A	#129—#256
84	2	0—127	Expansion B	#1—#128
84	3	0—127	Expansion B	#129—#256
84	4	0—127	Expansion C	#1—#128
84	5	0—127	Expansion C	#129—#256
84	6	0—127	Expansion D	#1—#128
84	7	0—127	Expansion D	#129—#256

If you wish to select a Rhythm Set, set the channel of the transmitting MIDI device to match the receive channel of Part 10 of the Performance. (With the factory settings, Part 10 is set to channel 10.)

## ■ Maximum simultaneous notes and Part priorities

### ● About maximum simultaneous notes

The **JV-1080** is able to produce up to 64 notes simultaneously. However some Patches consist of two Tones, and when such Tones are played, only 32 simultaneous notes are possible. The Patch List at the end of this manual gives the number of Tones used in each Patch.

### ● About Patch note priority

If the number of currently-requested notes exceeds 64, existing notes will be turned off to make room for the newly requested notes. The **JV-1080**'s Patch note priority function will start turning off notes beginning with the lowest-priority Part. When you create a song, keep in mind the Part note priority order as you decide which Part to use for each musical part.

If there is an important Part in your song that you do not want notes to be "stolen" from, you can use the Voice Reserve function (see p. 57) to reserve notes for it.

## Using MIDI Controllers

### Controllers and destinations

The **JV-1080** allows you to use a variety of MIDI controllers to modify Tone and EFX parameters in real time. Parameters being controlled are referred to as Destinations, and you can specify four Destinations in each Tone (up to 16 Destinations for each Patch).

Controllers that are used to control Tone parameters are referred to as Patch Control Sources. For example if you make Patch Control Source and Destination settings as shown in the following diagram, moving the bender lever to left or right (or up/down if you are using a wheel) will simultaneously control four Tone parameters: PCH (pitch), CUT (cutoff frequency), LEV (volume) and PAN (stereo position).

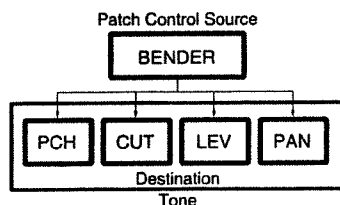

For this example, make settings as follows.

- 1 Turn on the receive switches for the controllers you wish to use.  
System parameter / RECEIVE MIDI Page  
Receive Bender (# p. 68): ON
- 2 Select the controller you wish to use.  
Patch parameter / CONTROL SOURCE Page  
Patch Control Source 2 (# p. 49): BENDER
- 3 Set the Controller Destination (# p. 49) and Control Depth (# p. 49).  
Patch parameter / CONTROL 2 Page  
Control Destination 1: PCH  
Control Destination 2: CUT  
Control Destination 3: LEV  
Control Destination 4: PAN  
Control Depth 1: other than 0  
Control Depth 2: other than 0  
Control Depth 3: other than 0  
Control Depth 4: other than 0

The **JV-1080** has three Patch Control Sources. Patch Control Source 1 is fixed at Modulation (control change #01), but Patch Control Sources 2 and 3 can be freely assigned.

### Control EFX parameters

To control EFX parameters, use an EFX Control Source. Two types of controllers can be freely assigned to these EFX Control Sources as well. The destination will be determined by the type of EFX that is selected. For example if you select Overdrive for EFX, the destinations will be set to DRIVE (the degree of distortion) and PAN (stereo location).

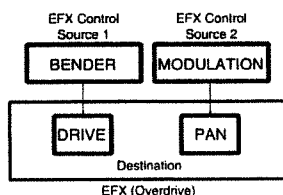

To make settings for this example, use the following procedure.

- 1 Turn on the receive switch for the controller you wish to use.  
System parameter / RECEIVE MIDI Page  
Receive Bender (# p. 68): ON  
Receive Modulation (# p. 68): ON
- 2 Select the EFX type.  
Patch parameter / PATCH EFX TYPE Page  
EFX Type (# p. 45): 2:OVERDRIVE
- 3 Select the controllers you wish to use  
Patch parameter / PATCH EFX CTRL Page  
EFX Control Source 1 (# p. 46): BENDER  
EFX Control Source 2 (# p. 46): MODULATION
- 4 Set the controller depth.  
Patch parameter / PATCH EFX CTRL Page  
EFX Control Depth 1 (# p. 46): other than 0  
EFX Control Depth 2 (# p. 46): other than 0

### Using controllers in System mode

Patch Control Source 2, Patch Control Source 3 and EFX Control Sources allow you to select the SYS-CTRL1 and SYS-CTRL2 settings. When these settings are selected, the Tone or EFX will be controlled as specified by the controller selections you make in System mode. In System mode, you can select any control change number (# 00 — # 95), bender or aftertouch as the two controller sources, System Control Source 1 and System Control Source 2.

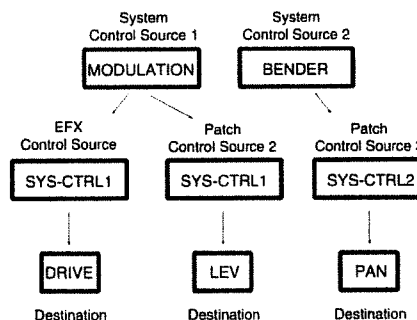

It is convenient to use System controllers when you do not need to specify controllers independently for each Patch, or when you want to be free to use any control change number as the controller.

\* With some exceptions, the function of each MIDI Control Change message is predefined. For example the Bank Select message (control change # 00, # 32) is used to switch sound banks. However the **JV-1080** allows you to assign control change messages to a variety of other functions, so that sounds can be controlled in realtime. If you do so, however, you should be aware that such uses are outside of the controller operations defined in the MIDI specification.

### Controllers in Performance mode

In Performance mode, the control sources specified in the Patch used by each Part can apply various effects to each Part. However if you use the EFX settings of the Performance, the EFX controller settings of the Patch will be ignored, and the EFX controller settings of the Performance will be used. Also, if you wish to use controllers in Performance mode, the MIDI receive switch of each Part must be turned on.



# 4. Using Effects

The routing of the **JV-1080**'s effects will depend on the settings of each Tone and on the effect output assign and level settings.

For each routing, you may think of a level setting of 0 as being disconnected, and a level setting of 1-127 as being connected. Effect routing is determined by the various level settings and output assign settings. The following diagrams are example settings in Patch mode which you may use as guidelines for your effect settings. The output assign and level settings shown at the left of each diagram will result in the effect routing shown in the diagrams at right. Parameter values listed as 1-127 can be set to any desired value.

\* Parameters listed as "--" will be ignored even if you set a value.

\* Only the sound to which the effect has been applied will be output with chorus and reverb, while EFX contains the original sound as well.

- Output the unprocessed sound from MIX OUT

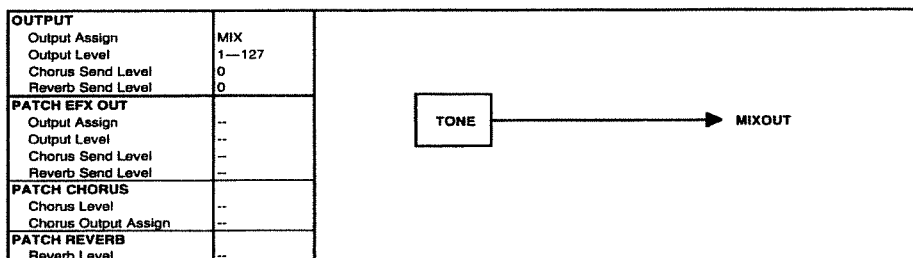

- Use chorus and reverb in series

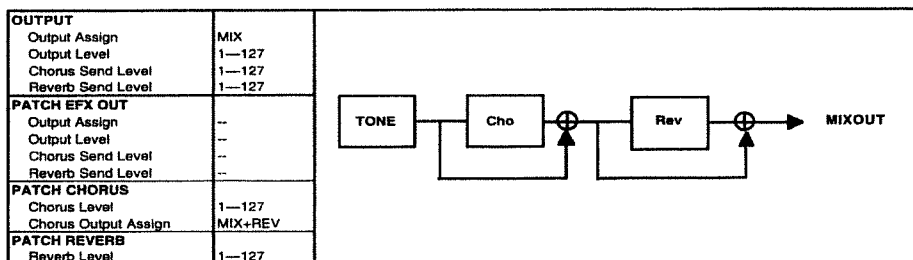

- Use only EFX

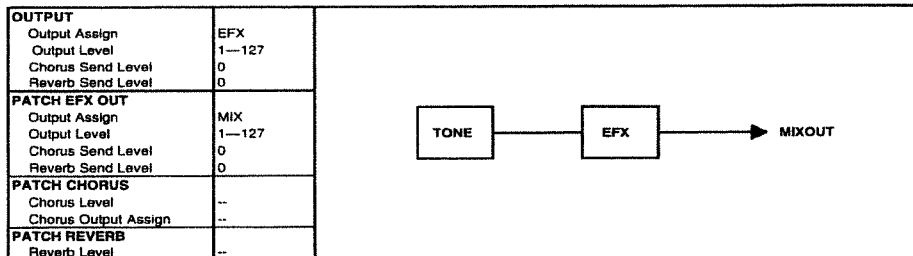

- Apply reverb only to the chorused sound and use in parallel with EFX

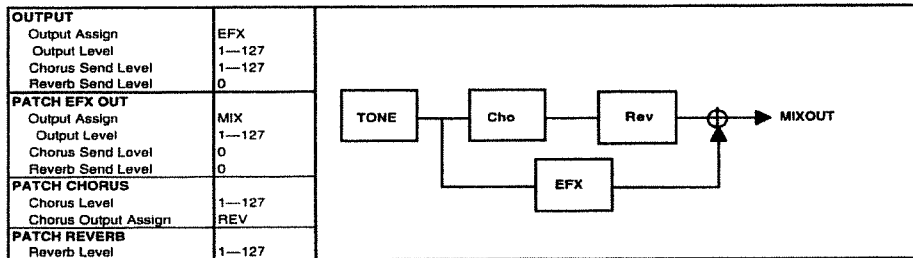

- Use EFX, chorus and reverb in series

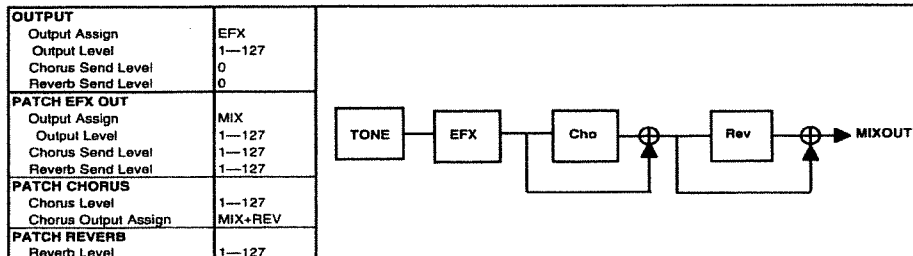

- Use chorus and reverb in parallel, and EFX in series

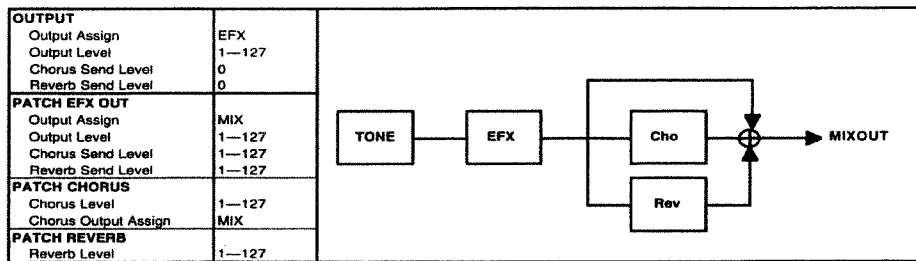

- Use EFX, chorus and reverb in parallel

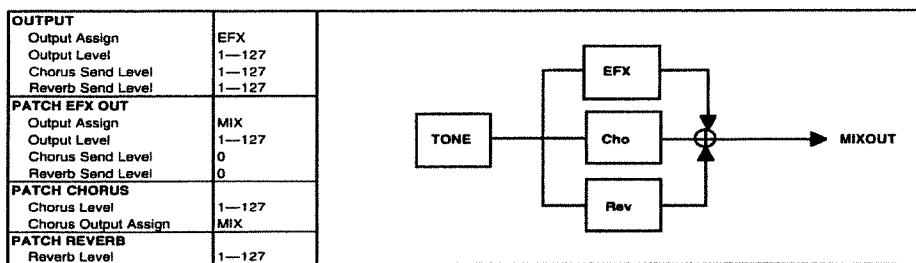

- Simultaneously use both parallel and series

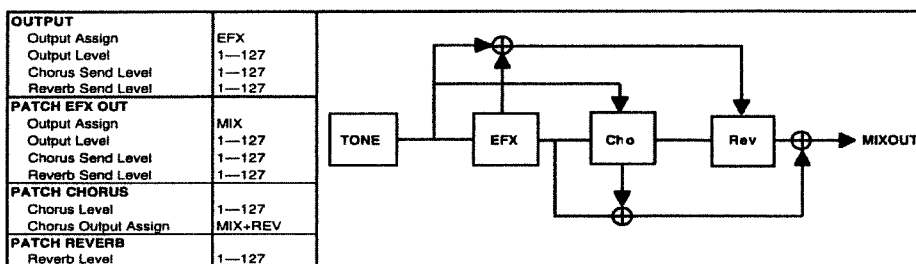

- Output the unprocessed sound from OUTPUT 1/2

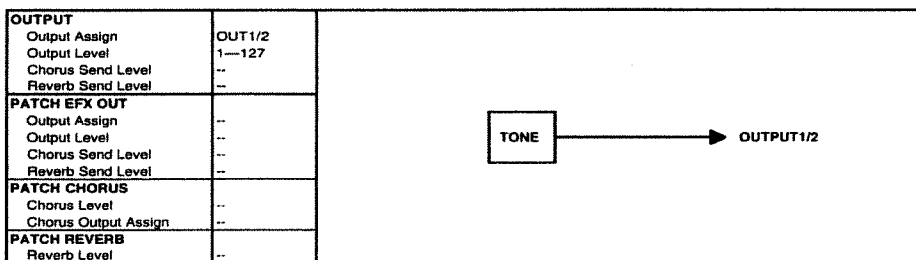

- Use EFX and output from OUTPUT 1/2

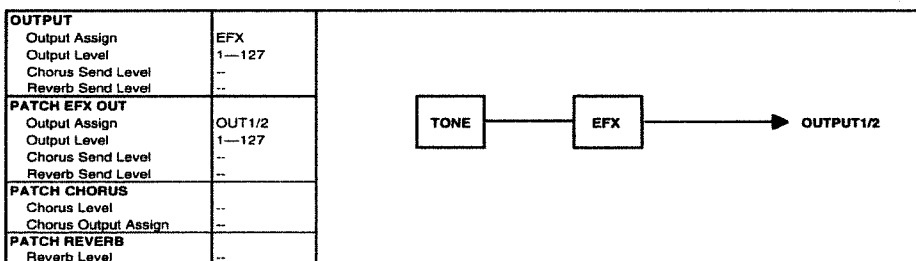

The examples here use one Tone from the Patch mode. Since the Output Level, Chorus Send Level, and Reverb Send Level can be set independently for each Tone, you can make whatever settings you need for each one when using multiple Tones. Individual settings for the Tone level are basically ignored when in the Performance mode—the level is controlled by the settings for output made for each Part. (It may be helpful to substitute PART for TONE when viewing the illustration.)

Only when Output Assign is set to "Patch" will the balance for the level of individual Tones set for Patches be reflected in the Parts. Note also that if a different EFX type is set for Patches and Performances, unexpected effects could be obtained from Parts. To avoid this, you can either set Output Assign to MIX, or use only Patches which are specifically set for the way that the Performance is to be used.

# Chapter 5

## Multi-Effector EFX

The EFX is a multi-effects processor offering 40 types of effects. Combinations of effects and the sequence of the routes taken by their signals are predetermined for each effect type.

---

Some of the parameters described in this chapter are marked with an asterisk (“\*”) to the left. This asterisk means that the parameter can be controlled by EFX Control Source (\* p. 46).

# 1. EFX Effect Types

The EFX has the 40 effect types described below. Some of the effects types are compounds in which two kinds of effects are linked together.

## ■ 1: STEREO-EQ (Stereo Equalizer)

This is the Stereo Equalizer, which adjusts the sound quality for bass, midrange, and treble.

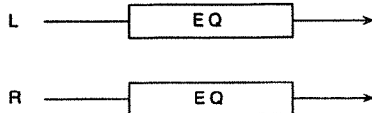

### <LowFreq> Low Frequency — 200 Hz/400 Hz

This sets the reference frequency for emphasizing bass sound quality.

### <LowGain> Low Gain — -15 dB to +15 dB

This sets the bass sound quality. A larger positive value results in greater emphasis of the lower band.

### <Hi Freq> High Frequency — 4 kHz/8 kHz

This sets the reference frequency for emphasizing treble sound quality.

### <Hi Gain> High Gain — -15 dB to +15 dB

This sets the treble sound quality. A larger positive value results in greater emphasis of the higher band.

### <P1 Freq> Peaking 1 Frequency — 200/250/315/400/500/630/800/1000/1250/1600/2000/2500/3150/4000/5000/6300/8000 (200 Hz to 8 kHz)

This sets the reference frequency for when emphasizing the sound quality of a specific frequency band.

### <P1 Q> Peaking 1 Q — 0.5/1.0/2.0/4.0/9.0

This determines the bandwidth for the reference frequency set with Peaking 1 Frequency.

A larger value gives a greater width for the band emphasized with Peaking 1 Gain.

### <P1 Gain> Peaking 1 Gain — -15 dB to +15 dB

This sets the sound quality for a specific frequency band. A larger positive value results in greater emphasis for the frequency band set with Peaking 1 Frequency and Peaking 1 Q.

### <P2 Freq> Peaking 2 Frequency — 200/250/315/400/500/630/800/1000/1250/1600/2000/2500/3150/4000/5000/6300/8000 (200 Hz to 8 kHz)

This sets the reference frequency for when emphasizing the sound quality of a specific frequency band.

### <P2 Q> Peaking 2 Q — 0.5/1.0/2.0/4.0/9.0

This determines the bandwidth for the reference frequency set with Peaking 2 Frequency.

A larger value gives a greater width for the band emphasized with Peaking 2 Gain.

### <P2 Gain> Peaking 2 Gain — -15 dB to +15 dB

This sets the sound quality for a specific frequency band. A larger positive value results in greater emphasis for the frequency band set with Peaking 2 Frequency and Peaking 2 Q.

### \*<Level> Output Level — 0 to 127

This sets the overall level for the effect sound.

## ■ 2: OVERDRIVE

This produces natural distortion like what you can get from a vacuum-tube amp.

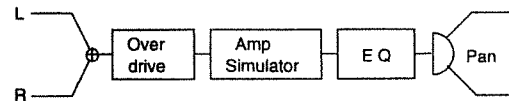

### \*<Drive> Drive — 0 to 127

This sets the strength of the sound distortion.

### <Level> Output Level — 0 to 127

This sets the overall level for the effect sound.

\* *Increasing the value for Drive also causes the overall volume to rise. It may be helpful to use Output Level to adjust for the difference in volume between when Overdrive is applied and when it is not applied.*

### <LowGain> Low Gain — -15 dB to +15 dB

This sets the bass sound quality. A larger positive value results in greater emphasis of the lower band.

### <Hi Gain> High Gain — -15 dB to +15 dB

This sets the treble sound quality. A larger positive value results in greater emphasis of the higher band.

### <Amp Type> Amp Type — SMALL/BUILT-IN/2-STACK/3-STACK

This simulates the characteristics of a guitar amp.

#### SMALL:

This simulates a compact amp.

#### BUILT-IN:

This simulates a built-in amp.

#### 2-STACK:

This simulates a large two-stack amp.

#### 3-STACK:

This simulates a large three-stack amp.

### \*<Pan> Output Pan — L64 to 0 to 63R

This sets the stereo position where the effect sound is output. L64 is leftmost, 0 is centered, and 63R is rightmost.

## ■ 3: DISTORTION

This increases odd harmonics to add strong distortion to the original sound.

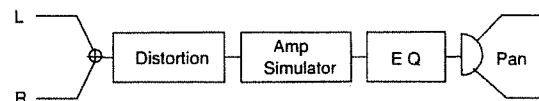

### \*<Drive> Drive — 0 to 127

This sets the strength of the sound distortion.

### <Level> Output Level — 0 to 127

This sets the overall level for the effect sound.

\* *Increasing the value for Drive also causes the overall volume to rise. It may be helpful to use Output Level to adjust for the difference in volume between when Distortion is applied and when it is not applied.*

**<LowGain> Low Gain — -15 dB to +15 dB**

This sets the bass sound quality. A larger positive value results in greater emphasis of the lower band.

**<Hi Gain> High Gain — -15 dB to +15 dB**

This sets the treble sound quality. A larger positive value results in greater emphasis of the higher band.

**<Amp Type> Amp Type — SMALL/BUILT-IN/2-STACK/3-STACK**

This simulates the characteristics of a guitar amp.

**SMALL:**

This simulates a compact amp.

**BUILT-IN:**

This simulates a built-in amp.

**2-STACK:**

This simulates a large two-stack amp.

**3-STACK:**

This simulates a large three-stack amp.

**\*<Pan> Output Pan — L64 to 0 to 63R**

This sets the stereo position where the effect sound is output. L64 is leftmost, 0 is centered, and 63R is rightmost.

## ■ 4: PHASER

This takes the original sound and adds a phase-shifted sound to it to make the tone change over time, producing undulations in the sound.

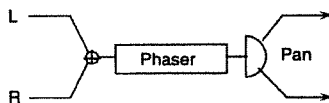

**\*<Manual> Manual — 100 Hz to 8 kHz**

This selects the frequency band to which undulations are added.

100 to 290 Hz:	In 10 Hz steps
300 to 980 Hz:	In 20 Hz steps
1 k to 8 kHz:	In 100 Hz steps

**\*<Rate> Phaser Rate — 0.05 Hz to 10.0 Hz**

This selects the cycle for the phaser sound undulations.

0.05 to 4.95 Hz:	In 0.05 Hz steps
5.0 to 6.9 Hz:	In 0.1 Hz steps
7.0 to 10.0 Hz:	In 0.5 Hz steps

**<Depth> Phaser Depth — 0 to 127**

This sets the depth of the undulations.

**<Res> Resonance — 0 to 127**

This sets the amount of Phaser feedback. Larger values produce a more distinctive sound.

**<Mix> Mix Level — 0 to 127**

This sets the level of the phase-shifter effect sound with respect to the original sound.

**<Pan> Output Pan — L64 to 0 to 63R**

This sets the stereo position where the Phaser sound is output. L64 is leftmost, 0 is centered, and 63R is rightmost.

**<Level> Output Level — 0 to 127**

This sets the overall level for the effect sound.

## ■ 5: SPECTRUM

This is a type of filter that raises and lowers the level of a specific frequency to change the tone.

Spectrum works like an equalizer, but because the frequency for each of the bands is set at an optimal position for adding distinctiveness, you can create sounds with more characteristics than just simple compensation.

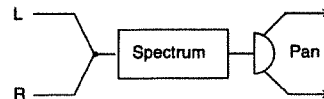

The sounds are set with Bands 1 to 6.

**<Band 1> Band 1 Level — -15 dB to +15 dB**

This sets the frequency at 250 Hz.

**<Band 2> Band 2 Level — -15 dB to +15 dB**

This sets the frequency at 500 Hz.

**<Band 3> Band 3 Level — -15 dB to +15 dB**

This sets the frequency at 1000 Hz (1 kHz).

**<Band 4> Band 4 Level — -15 dB to +15 dB**

This sets the frequency at 1250 Hz.

**<Band 5> Band 5 Level — -15 dB to +15 dB**

This sets the frequency at 2000 Hz.

**<Band 6> Band 6 Level — -15 dB to +15 dB**

This sets the frequency at 3150 Hz.

**<Band 7> Band 7 Level — -15 dB to +15 dB**

This sets the frequency at 4000 Hz.

**<Band 8> Band 8 Level — -15 dB to +15 dB**

This sets the frequency at 8000 Hz.

**<Width> Bandwidth — 1 to 5**

This setting, which is common for each Band, sets the width of the frequency band which is raised and lowered by the Level value.

**\*<Pan> Output Pan — L64 to 0 to 63R**

This sets the stereo position where the effect sound is output. L64 is leftmost, 0 is centered, and 63R is rightmost.

**\*<Level> Output Level — 0 to 127**

This sets the overall level for the effect sound.

## ■ 6: ENHANCER

This controls the treble harmonic components to add modulation to the sound, thus enhancing it.

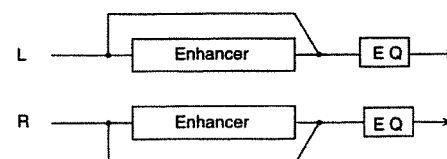

\*<Sens> Sensitivity — 0 to 127

This sets the depth to which the Enhancer is applied.

\*<Mix> Mix Level — 0 to 127

This sets the ratio for mixing the original sound with the generated harmonics.

<LowGain> Low Gain — -15 dB to +15 dB

This sets the bass sound quality. A larger positive value results in greater emphasis of the lower band.

<Hi Gain> High Gain — -15 dB to +15 dB

This sets the treble sound quality. A larger positive value results in greater emphasis of the higher band.

<Level> Output Level — 0 to 127

This sets the overall level for the effect sound.

## ■ 7: AUTO-WAH

This lets you obtain an Auto-Wah effect in which the sound is changed cyclically by cyclic movement of the filter.

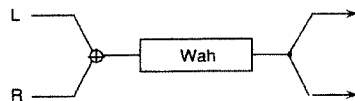

<Filter> Filter Type — LPF/BPF

This selects the type of filter to be used.

**LPF (Low-pass Filter):**

A wah effect is obtained for a wide frequency range.

**BPF (Bandpass Filter):**

A wah effect is obtained for a narrow frequency range.

<Sens> Sensitivity — 0 to 127

This sets the depth to which the effect is applied.

\*<Manual> Manual — 0 to 127

This sets the reference frequency for the wah effect.

<Peak> Peak — 0 to 127

This sets the extent to which the wah effect is applied near the reference frequency.

Using a smaller value results in a wah effect in a wider range near the reference frequency, and using a larger value produces the effect for a narrower range.

\*<Rate> LFO Rate — 0.05 Hz to 10.0 Hz

This sets the cycle for the undulations of the wah effect.

0.05 to 4.95 Hz:	In 0.05 Hz steps
5.0 to 6.9 Hz:	In 0.1 Hz steps
7.0 to 10.0 Hz:	In 0.5 Hz steps

<Depth> LFO Depth — 0 to 127

This sets the depth of the undulations of the wah effect.

<Level> Output Level — 0 to 127

This sets the overall level for the effect sound.

## ■ 8: ROTARY

This simulates an old-fashioned rotary speaker, which adds undulations to the sound by rotating the speaker as it plays.

This has the greatest effect when used with an organ sound. The horn (the treble-range speaker) and the rotor (the bass-range speaker) can be combined to re-create these subtle effects.

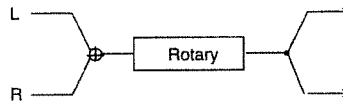

<LowSlow> Low Frequency Slow Rate — 0.05 Hz to 10.0 Hz

This sets the speed of rotation for the rotor (the bass-range speaker) when the Speed setting is at "SLOW."

0.05 to 4.95 Hz:	In 0.05 Hz steps
5.0 to 6.9 Hz:	In 0.1 Hz steps
7.0 to 10.0 Hz:	In 0.5 Hz steps

<LowFast> Low Frequency Fast Rate — 0.05 Hz to 10.0 Hz

This sets the speed of rotation for the rotor (the bass-range speaker) when the Speed setting is at "FAST."

0.05 to 4.95 Hz:	In 0.05 Hz steps
5.0 to 6.9 Hz:	In 0.1 Hz steps
7.0 to 10.0 Hz:	In 0.5 Hz steps

<LowAcc> Low Frequency Acceleration — 0 to 15

This sets the time until the rotation cycle of the rotor (the bass-range speaker) reaches a steady state when the Speed setting is switched (SLOW <-> FAST). Smaller values result in longer times.

<LowLvl> Low Frequency Level — 0 to 127

This sets the volume for the rotor (the bass-range speaker).

<HiSlow> High Frequency Slow Rate — 0.05 Hz to 10.0 Hz

This sets the speed of rotation for the horn (the treble-range speaker) when the Speed setting is at "SLOW."

0.05 to 4.95 Hz:	In 0.05 Hz steps
5.0 to 6.9 Hz:	In 0.1 Hz steps
7.0 to 10.0 Hz:	In 0.5 Hz steps

<HiFast> High Frequency Fast Rate — 0.05 Hz to 10.0 Hz

This sets the speed of rotation for the horn (the treble-range speaker) when the Speed setting is at "FAST."

0.05 to 4.95 Hz:	In 0.05 Hz steps
5.0 to 6.9 Hz:	In 0.1 Hz steps
7.0 to 10.0 Hz:	In 0.5 Hz steps

<HiAcc> High Frequency Acceleration — 0 to 15

This sets the time until the rotation cycle of the horn (the treble-range speaker) reaches a steady state when the Speed setting is switched (SLOW <-> FAST). Smaller values result in longer times.

<HiLvl> High Frequency Level — 0 to 127

This sets the volume for the horn (the treble-range speaker).

<Separation> Separation — 0 to 127

This sets how widely the sound expands.

\*<Speed> Speed — SLOW/FAST

This toggles the rotation speed for the Rotary effect.

**SLOW:**

When switched from FAST, the speed of rotation slows down to a slow steady state (the value for LowSlow/HiSlow).

**FAST:**

When switched from SLOW, the speed of rotation speeds up to a fast steady state (the value for LowFast/HiFast).

\* You can toggle between SLOW and FAST with any Controller assigned by the Source setting for EFX Control Source (see p. 46).

For instance, if Source is set to FOOT, you can toggle between SLOW and FAST by sending a foot message (Control Change # 4) from an external Controller.

\*<Level> Output Level — 0 to 127

This sets the overall level for the effect sound.

## 9: COMPRESSOR

This stabilizes the overall level by suppressing the high level and boosting the low level.

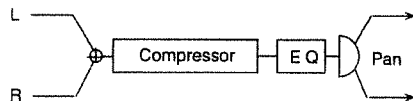

<Attack> Attack Rate — 0 to 127

This sets the force of attack when sound is input.

<Sustain> Sustain Rate — 0 to 127

This sets the time for boosting a low-level signal to a uniform volume.

<Post Gain> Post Gain — x1/x2/x4/x8

This sets the input level.

<LowGain> Low Gain — -15 dB to +15 dB

This sets the bass sound quality. A larger positive value results in greater emphasis of the lower band.

<Hi Gain> High Gain — -15 dB to +15 dB

This sets the treble sound quality. A larger positive value results in greater emphasis of the higher band.

\*<Pan> Output Pan — L64 to 0 to 63R

This sets the stereo position where the effect sound is output. L64 is leftmost, 0 is centered, and 63R is rightmost.

\*<Level> Output Level — 0 to 127

This sets the overall level for the effect sound.

## 10: LIMITER

Whereas the Compressor acts on both low-level and high-level signals, the Limiter compresses only high-level signals that exceed a set level. You can eliminate unwanted distortion by setting this to work only on peak input.

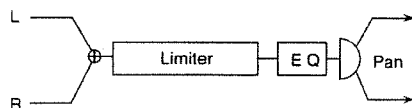

<Thresh> Threshold — 0 to 127

This sets the level at which the Limiter effect appears. Input signals above the set level are compressed.

<Ratio> Ratio — 1.5:1/2:1/4:1/100:1

This sets how much the signals are compressed when the Limiter is applied.

<Release> Release Time — 0 to 127

This sets the interval from the time when the signal drops below the threshold level until the time the effect ceases.

<Gain> Post Gain — x1/x2/x4/x8

This sets the input level.

<LowGain> Low Gain — -15 dB to +15 dB

This sets the bass sound quality. A larger positive value results in greater emphasis of the lower band.

<Hi Gain> High Gain — -15 dB to +15 dB

This sets the treble sound quality. A larger positive value results in greater emphasis of the higher band.

\*<Pan> Output Pan — L64 to 0 to 63R

This sets the stereo position where the effect sound is output. L64 is leftmost, 0 is centered, and 63R is rightmost.

\*<Level> Output Level — 0 to 127

This sets the overall level for the effect sound.

## 11: HEXA-CHORUS

Chorus is an effect that makes a sound thicker and broader. This applies a chorus to six sounds with different delay times (hexa-chorus).

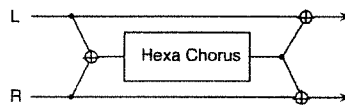

<Pre Dly> Predelay Time — 0 ms to 100 ms

This sets the interval from the time when the original sound is played until the time when the effect sound is played.

|                |                 |
|----------------|-----------------|
| 0 to 4.9 ms:   | In 0.1 ms steps |
| 5.0 to 9.5 ms: | In 0.5 ms steps |
| 10 to 49 ms:   | In 1 ms steps   |
| 50 to 100 ms:  | In 2 ms steps   |

\*<Rate> Chorus Rate — 0.05 Hz to 10.0 Hz

This sets the cycle for the chorus sound undulations.

|                  |                  |
|------------------|------------------|
| 0.05 to 4.95 Hz: | In 0.05 Hz steps |
| 5.0 to 6.9 Hz:   | In 0.1 Hz steps  |
| 7.0 to 10.0 Hz:  | In 0.5 Hz steps  |

<Depth> Chorus Depth — 0 to 127

This sets the depth of the undulations of the chorus sound.

<Dly Dev> Predelay Deviation — 0 to 20

Predelay is the time interval from when the direct sound is played until the chorus sound is played. This parameter staggers the predelay for each hexa-chorus sound by the value set. A larger value results in a greater shift between each hexa-chorus sound.

<Dpt Dev> Depth Deviation — -20 to +20

This sets the deviated depth for the respective hexa-chorus sounds.

Larger values produce wider deviated depth for the chorus sound.

<Pan Dev> Pan Deviation — 0 to 20

This sets the spread in stereo position for the respective hexa-chorus sounds. Larger values produce wider stereo positions for the chorus sound. When set to zero, all chorus sounds are centered. At 20, the sounds are spaced at 30-degree intervals, starting from the center.

**<Balance> Effect Balance — D100:0E to D0:100E**  
 This sets the balance for the levels of the original sound and the effect sound.

**<Level> Output Level — 0 to 127**  
 This sets the overall level for the effect sound.

## ■ 12: TREMOLO-CHORUS

This is a chorus with a tremolo effect, which adds cyclic undulations in volume.

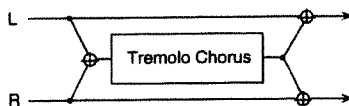

**<Pre Dly> Predelay Time — 0 ms to 100 ms**  
 This sets the interval from the time when the original sound is played until the time when the chorus sound is played.

|                |                 |
|----------------|-----------------|
| 0 to 4.9 ms:   | In 0.1 ms steps |
| 5.0 to 9.5 ms: | In 0.5 ms steps |
| 10 to 49 ms:   | In 1 ms steps   |
| 50 to 100 ms:  | In 2 ms steps   |

**<ChoRate> Chorus Rate — 0.05 Hz to 10.0 Hz**  
 This sets the cycle for the chorus sound undulations.

|                  |                  |
|------------------|------------------|
| 0.05 to 4.95 Hz: | In 0.05 Hz steps |
| 5.0 to 6.9 Hz:   | In 0.1 Hz steps  |
| 7.0 to 10.0 Hz:  | In 0.5 Hz steps  |

**<Cho Dpt> Chorus Depth — 0 to 127**  
 This sets the depth of the undulations of the chorus sound.

**<Phase> Chorus Phase — 0 to 180**  
 This sets how the chorus sound is spread.

**\*<TrmRate> Tremolo Rate — 0.05 Hz to 10.0 Hz**  
 This sets the cycle for the undulations of the Tremolo effect. Larger values make for a faster cycle.

|                  |                  |
|------------------|------------------|
| 0.05 to 4.95 Hz: | In 0.05 Hz steps |
| 5.0 to 6.9 Hz:   | In 0.1 Hz steps  |
| 7.0 to 10.0 Hz:  | In 0.5 Hz steps  |

**<Trm Sep> Tremolo Separation — 0 to 127**  
 This sets how the Tremolo effect expands.

**\*<Balance> Effect Balance — D100:0E to D0:100E**  
 This sets the balance for the levels of the original sound and the effect sound (chorus sound).

**<Level> Output Level — 0 to 127**  
 This sets the overall level for the effect sound.

## ■ 13: SPACE-D

This is a multiple chorus which applies two-phase modulation in stereo. One feature of this effect is that it produces a clear chorus effect with no feeling of discordance.

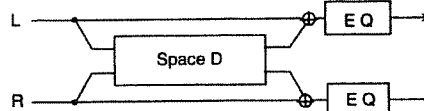

**<Pre Dly> Predelay Time — 0 ms to 100 ms**  
 This sets the interval from the time when the original sound is played until the time when the chorus sound is played.

|                |                 |
|----------------|-----------------|
| 0 to 4.9 ms:   | In 0.1 ms steps |
| 5.0 to 9.5 ms: | In 0.5 ms steps |
| 10 to 49 ms:   | In 1 ms steps   |
| 50 to 100 ms:  | In 2 ms steps   |

**\*<Rate> Chorus Rate — 0.05 Hz to 10.0 Hz**

|                  |                  |
|------------------|------------------|
| 0.05 to 4.95 Hz: | In 0.05 Hz steps |
| 5.0 to 6.9 Hz:   | In 0.1 Hz steps  |
| 7.0 to 10.0 Hz:  | In 0.5 Hz steps  |

**<Depth> Chorus Depth — 0 to 127**  
 This sets the depth of the undulations of the chorus sound.

**<Phase> Phase — 0 to 180**  
 This sets how the chorus sound is spread.

**<LowGain> Low Gain — -15 dB to +15 dB**  
 This sets the bass sound quality for the chorus sound. A larger positive value results in greater emphasis of the lower band.

**<Hi Gain> High Gain — -15 dB to +15 dB**  
 This sets the treble sound quality for the chorus sound. A larger positive value results in greater emphasis of the higher band.

**\*<Balance> Effect Balance — D100:0E to D0:100E**  
 This sets the balance for the levels of the original sound and the effect sound (chorus sound).

**<Level> Output Level — 0 to 127**  
 This sets the overall level for the effect sound.

## ■ 14: STEREO-CHORUS

This is a chorus with full stereo output. It makes the sound thicker and broader.

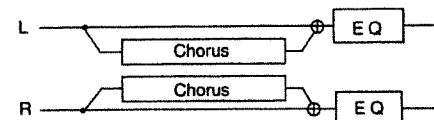

**<Pre Dly> Predelay Time — 0 ms to 100 ms**  
 This sets the interval from the time when the original sound is played until the time when the chorus sound is played.

|                |                 |
|----------------|-----------------|
| 0 to 4.9 ms:   | In 0.1 ms steps |
| 5.0 to 9.5 ms: | In 0.5 ms steps |
| 10 to 49 ms:   | In 1 ms steps   |
| 50 to 100 ms:  | In 2 ms steps   |

**\*<Rate> Chorus Rate — 0.05 Hz to 10.0 Hz**

This sets the cycle for the chorus sound undulations.



|                  |                  |
|------------------|------------------|
| 0.05 to 4.95 Hz: | In 0.05 Hz steps |
| 5.0 to 6.9 Hz:   | In 0.1 Hz steps  |
| 7.0 to 10.0 Hz:  | In 0.5 Hz steps  |

**<Depth> Chorus Depth — 0 to 127**

This sets the depth of the undulations of the chorus sound.

**<Phase> Phase — 0 to 180**

This sets how the chorus sound is spread.

**<Filter Type> Filter Type — OFF/LPF/HPF**

This selects the type of filter applied to the chorus sound.

**LPF (Low-pass Filter):**

The band higher than the value set for the cutoff frequency is eliminated.

**HPF (High-pass Filter):**

The band lower than the value set for the cutoff frequency is eliminated.

**<Cutoff> Cutoff Frequency — 200/250/315/400/500/630/800/1000/1250/1600/2000/2500/3150/4000/5000/6300/8000 (200 Hz to 8 kHz)**

This sets the frequency that serves as the reference when a specific frequency band is cut off by a filter.

**<LowGain> Low Gain — -15 dB to +15 dB**

This sets the bass sound quality for the chorus sound. A larger positive value results in greater emphasis of the lower band.

**<Hi Gain> High Gain — -15 dB to +15 dB**

This sets the treble sound quality for the chorus sound. A larger positive value results in greater emphasis of the higher band.

**\*<Balance> Effect Balance — D100:0E to D0:100E**

This sets the balance for the levels of the original sound and the effect sound (chorus sound).

**<Level> Output Level — 0 to 127**

This sets the overall level for the effect sound.

**<Depth> LFO Depth — 0 to 127**

This sets the depth of the flanger undulations.

**\*<Fbk> Feedback — -98% to +98%**

This sets the percentage of the flanger sound output signal that is returned to the input signal.

When the value is positive, an output that is in phase is returned to the input signal. Entering a negative value causes a signal of inverted phase to be returned to the input signal. There is no feedback when the value is zero.

You can set a value from -98% to +98%, in steps of 2%.

**<Phase> Phase — 0 to 180**

This sets how the flanger sound is spread.

**<Filter> Filter Type — OFF/LPF/HPF**

This selects the type of filter applied to the flanger sound.

**LPF (Low-pass Filter):**

The band higher than the value set for the cutoff frequency is eliminated.

**HPF (High-pass Filter):**

The band lower than the value set for the cutoff frequency is eliminated.

**<Cutoff> Cutoff Frequency — 200/250/315/400/500/630/800/1000/1250/1600/2000/2500/3150/4000/5000/6300/8000 (200 Hz to 8 kHz)**

This sets the frequency that serves as the reference when a specific frequency band is cut off by a filter.

**<LowGain> Low Gain — -15 dB to +15 dB**

This sets the bass sound quality. A larger positive value results in greater emphasis of the lower band.

**<Hi Gain> High Gain — -15 dB to +15 dB**

This sets the treble sound quality. A larger positive value results in greater emphasis of the higher band.

**<Balance> Effect Balance — D100:0E to D0:100E**

This sets the balance for the levels of the original sound and the effect sound (flanger sound).

**<Level> Output Level — 0 to 127**

This sets the overall level for the effect sound.

## 15: STEREO-FLANGER

This is a Flanger with full stereo output (the left and right LFOs are in phase). The depth of the effect can be increased to obtain a sound that moves up and down, like a jet taking off or landing.

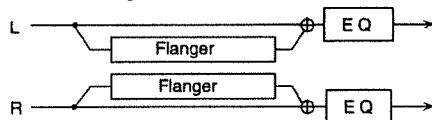

**<Pre Dly> Predelay Time — 0 ms to 100 ms**

This sets the interval from the time when the original sound is played until the time when the flanger sound is played.

|                |                 |
|----------------|-----------------|
| 0 to 4.9 ms:   | In 0.1 ms steps |
| 5.0 to 9.5 ms: | In 0.5 ms steps |
| 10 to 49 ms:   | In 1 ms steps   |
| 50 to 100 ms:  | In 2 ms steps   |

**\*<Rate> LFO Rate — 0.05 Hz to 10.0 Hz**

This sets the cycle for the flanger undulations.

|                  |                  |
|------------------|------------------|
| 0.05 to 4.95 Hz: | In 0.05 Hz steps |
| 5.0 to 6.9 Hz:   | In 0.1 Hz steps  |
| 7.0 to 10.0 Hz:  | In 0.5 Hz steps  |

## 16: STEP-FLANGER

This is flanger that makes step-wise changes in the pitch of the flanging. By setting the step rate to the length of a note, you can synchronize the changes in pitch to the MIDI clock of the JV-1080 or an external device.

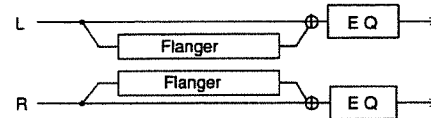

**<Pre Dly> Predelay Time — 0 ms to 100 ms**

This sets the interval from the time when the original sound is played until the time when the flanger sound is played.

|                |                 |
|----------------|-----------------|
| 0 to 4.9 ms:   | In 0.1 ms steps |
| 5.0 to 9.5 ms: | In 0.5 ms steps |
| 10 to 49 ms:   | In 1 ms steps   |
| 50 to 100 ms:  | In 2 ms steps   |

**<Rate> LFO Rate — 0.05 Hz to 10.0 Hz**

This sets the cycle for the flanger undulations.

0.05 to 4.95 Hz: In 0.05 Hz steps  
 5.0 to 6.9 Hz: In 0.1 Hz steps  
 7.0 to 10.0 Hz: In 0.5 Hz steps

**<Depth> LFO Depth — 0 to 127**

This sets the depth of the flanger undulations.

**\*<Fbk> Feedback — -98% to +98%**

This sets the percentage of the flanger sound output signal that is returned to the input signal.

When the value is positive, an output that is in phase is returned to the input signal. Entering a negative value causes a signal of inverted phase to be returned to the input signal. There is no feedback when the value is zero.

You can set a value from -98% to +98%, in steps of 2%.

**<Phase> Phase — 0 to 180**

This sets how the flanger sound is spread.

**\*<StepRate> Step Rate — 0.05 Hz to 10.0 Hz/♪/♪/♪/♪**

♪/♪/♪/♪/♪/♪/♪/♪

This sets the cycle for the changes in pitch.

0.05 to 4.95 Hz: In 0.05 Hz steps  
 5.0 to 6.9 Hz: In 0.1 Hz steps  
 7.0 to 10.0 Hz: In 0.5 Hz steps

\* When set with a note, the Step Rate is synchronized to the MIDI clock of the JV-1080 or an external device. Use Clock Source (☞ p. 66, p. 67), a system parameter, to select whether the MIDI clock of the JV-1080 or the external device is to be used for synchronization.

\* When a numerical setting is made, the MIDI clock is ignored. If the setting is made with a note but no external MIDI clock is received, the changes in pitch are synchronized with the JV-1080's built-in default tempo (☞ p. 42, p. 57).

**<LowGain> Low Gain — -15 dB to +15 dB**

This sets the bass sound quality for the flanger sound. A larger positive value results in greater emphasis of the lower band.

**<Hi Gain> High Gain — -15 dB to +15 dB**

This sets the treble sound quality for the flanger sound. A larger positive value results in greater emphasis of the higher band.

**<Balance> Effect Balance — D100:0E to D0:100E**

This sets the balance for the levels of the original sound and the effect sound (flanger sound).

**<Level> Output Level — 0 to 127**

This sets the overall level for the effect sound.

When Feedback Mode is NORMAL

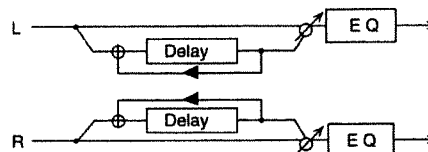

When Feedback Mode is CROSS

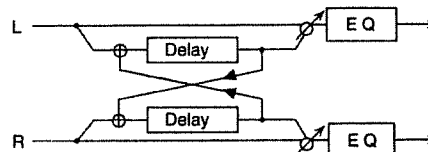

**<Delay L> Delay Time Left — 0 ms to 500 ms**

This sets the time until the left (L) delayed sound is played.

0 to 4.9 ms: In 0.1 ms steps  
 5.0 to 9.5 ms: In 0.5 ms steps  
 10 to 39 ms: In 1 ms steps  
 40 to 290 ms: In 10 ms steps  
 300 to 500 ms: In 20 ms steps

**<Delay R> Delay Time Right — 0 ms to 500 ms**

This sets the time until the right (R) delayed sound is played.

\* The setting values are the same as for Delay Time Left.

**\*<Fbk> Feedback — -98% to +98%**

This sets the percentage of the delayed sound output signal that is returned to the input signal.

Larger values result in more repetitions of the delayed sound. When the value is positive, an output that is in phase is returned to the input signal. Entering a negative value causes a signal of inverted phase to be returned to the input signal. There is no feedback when the value is zero.

You can set a value from -98% to +98%, in steps of 2%.

**<Mode> Feedback Mode — NORMAL/CROSS**

This sets the feedback mode.

When set to "CROSS," the delayed sound of each channel is fed back to the other channel, making the delayed sound jump back and forth from left to right.

**<Phase L> Phase Left — NORMAL/INVERT**

This sets the phase of the delayed sound on the left (L) side.

NORMAL: No change in phase  
 INVERT: Phase is inverted

**<Phase R> Phase Right — NORMAL/INVERT**

This sets the phase of the delayed sound on the right (R) side.

NORMAL: No change in phase  
 INVERT: Phase is inverted

**<HF Damp> High-Frequency Damp —**

200/250/315/400/500/630/800/1000/1250/1600/2000/2500/3150/4000/5000/6300/8000 (200 Hz to 8 kHz), BYPASS

This sets the frequency at which the high-frequency components of the reverb sound are cut off.

A reverb sound is composed of an infinite number of reflected sounds.

The degree to which the high-frequency components of a reverb sound are attenuated depends on the composition of surrounding materials (such as the walls and the ceiling). HF Damp (high-frequency damp) is a parameter which simulates this by attenuating the high-frequency components.

A lower cutoff frequency results in a sedate sound, while a higher frequency produces a brighter sound. When set to "BYPASS," no high-frequency components are cut off.

**17: STEREO-DELAY**

This is a delay with full stereo specifications. This lets you make a thicker sound or achieve special effects by adding a delayed sound to the original sound.

**<LowGain> Low Gain — -15 dB to +15 dB**

This sets the bass sound quality for the reverb sound. A larger positive value results in greater emphasis of the lower band.

**<Hi Gain> High Gain — -15 dB to +15 dB**

This sets the treble sound quality for the reverb sound. A larger positive value results in greater emphasis of the higher band.

**\*<Balance> Effect Balance — D100:0E to D0:100E**

This sets the balance for the levels of the original sound and the effect sound (reverb sound).

**<Level> Output Level — 0 to 127**

This sets the overall level for the effect sound.

0.05 to 4.95 Hz: In 0.05 Hz steps

5.0 to 6.9 Hz: In 0.1 Hz steps

7.0 to 10.0 Hz: In 0.5 Hz steps

**<Depth> Modulation Depth — 0 to 127**

This sets the depth of the modulation effect.

**<Phase> Phase — 0 to 180**

This sets how the modulation sound expands.

**<HF Damp> High-Frequency Damp —**

200/250/315/400/500/630/800/1000/1250/1600/2000/2500/3150/4000/5000/6300/8000 (200 Hz to 8 kHz), BYPASS

This sets the frequency at which the high-frequency components of the reverb sound are cut off.

The degree to which the high-frequency components of a reverb sound are attenuated depends on the composition of surrounding walls. HF Damp (high-frequency damp) is a parameter which simulates this by attenuating the high-frequency components.

A lower cutoff frequency results in a sedate sound, while a higher frequency produces a brighter sound. When set to "BYPASS," no high-frequency components are cut off.

**<LowGain> Low Gain — -15 dB to +15 dB**

This sets the bass sound quality. A larger positive value results in greater emphasis of the lower band.

**<Hi Gain> High Gain — -15 dB to +15 dB**

This sets the treble sound quality. A larger positive value results in greater emphasis of the higher band.

**\*<Balance> Effect Balance — D100:0E to D0:100E**

This sets the balance for the levels of the original sound and the effect sound.

**<Level> Output Level — 0 to 127**

This sets the overall level for the effect sound.

## 18: MODULATION-DELAY

This lets you add modulation to a delayed sound to create an effect that resembles a flanger.

When Feedback Mode is NORMAL

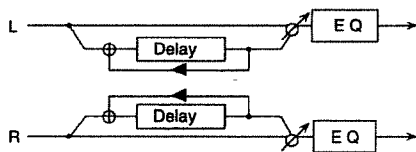

When Feedback Mode is CROSS

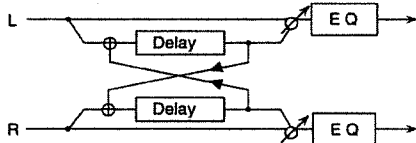

**<Delay L> Delay Time Left — 0 ms to 500 ms**

This sets the time until the left (L) delayed sound is played.

- 0 to 4.9 ms: In 0.1 ms steps
- 5.0 to 9.5 ms: In 0.5 ms steps
- 10 to 39 ms: In 1 ms steps
- 40 to 290 ms: In 10 ms steps
- 300 to 500 ms: In 20 ms steps

**<Delay R> Delay Time Right — 0 ms to 500 ms**

This sets the time until the right (R) delayed sound is played.

\* The setting values are the same as for Delay Time Left.

**<Fbk> Feedback — -98% to +98%**

This sets the percentage of the delayed sound output signal that is returned to the input signal.

Larger values result in more repetitions of the delayed sound. When the value is positive, an output that is in phase is returned to the input signal. Entering a negative value causes a signal of inverted phase to be returned to the input signal. There is no feedback when the value is zero. You can set a value from -98% to +98%, in steps of 2%.

**<Mode> Feedback Mode — NORMAL/CROSS**

This sets the feedback mode.

When set to "CROSS," the delayed sound of each channel is fed back to the other channel, making the delayed sound jump back and forth from left to right.

**\*<Rate> Modulation Rate — 0.05 Hz to 10.0 Hz**

This sets the speed with which the modulation effect is applied.

## 19: TRIPLE-TAP-DELAY

This delay lets you set different delay times for three directions — center (C), left (L), and right (R).

By setting the delay time to the length of a note, you can synchronize the delayed sound to the MIDI clock signal from an internal or external device.

This effect is used when you want to apply a delay that is synchronized to the performance tempo of a sequencer or some other instrument.

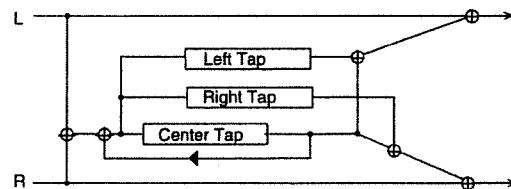

**<Delay C> Delay Time Center — 200 ms to 1000 ms**

This sets the delay time for the delayed sound that is output from the center (C).

200 to 545 ms: In 5 ms steps

550 to 1000 ms: In 10 ms steps

\* When set as a note value, the Delay Time can be synchronized with the module's internal clock or the MIDI clock arriving from an external device. You can use the Clock Source system parameter (see p. 66, p. 67) to select which source you want to use, either the internal clock or the MIDI clock.

\* When set as a numeric value, the MIDI clock will be ignored. Note also that even if a note value has been set, the module's default tempo (see p. 42, p. 57) will be used for synchronization whenever the MIDI clock has not arrived from an external device.

**<Delay L> Delay Time Left**

This sets the delay time for the delayed sound that is output from the left (L).

\* The setting values are the same as for Delay Time Center.

**<Delay R> Delay Time Right**

This sets the delay time for the delayed sound that is output from the right (R).

\* The setting values are the same as for Delay Time Center.

**\*<Fbk> Feedback — -98% to +98%**

This sets the amount of feedback for the delayed sound. "Feedback" refers to returning a portion of the output signal to the input signal.

This sets the percentage of the in-phase or inverted-phase output signal (positive or negative value) that is returned to the input. You can set a value from -98% to +98%, in steps of 2%. No feedback is applied when this is set to zero.

**<Level C> Center Level — 0 to 127**

This sets the volume for the center delayed sound.

**<Level L> Left Level — 0 to 127**

This sets the volume for the left delayed sound.

**<Level R> Right Level — 0 to 127**

This sets the volume for the right delayed sound.

**<HF Damp> High-Frequency Damp —**

200/250/315/400/500/630/800/1000/1250/1600/2000/2500/3150/4000/5000/6300/8000 (200 Hz to 8 kHz), **BYPASS**  
This sets the frequency at which the high-frequency components of the reverb sound are cut off.

The degree to which the high-frequency components of a reverb sound are attenuated depends on the composition of surrounding walls. HF Damp (high-frequency damp) is a parameter which simulates this by attenuating the high-frequency components.

A lower cutoff frequency results in a sedate sound, while a higher frequency produces a brighter sound. When set to "BYPASS," no high-frequency components are cut off.

**<LowGain> Low Gain — -15 dB to +15 dB**

This sets the bass sound quality. A larger positive value results in greater emphasis of the lower band.

**<Hi Gain> High Gain — -15 dB to +15 dB**

This sets the treble sound quality. A larger positive value results in greater emphasis of the higher band.

**\*<Balance> Effect Balance — D100:0E to D0:100E**

This sets the balance for the levels of the original sound and the effect sound.

**<Level> Output Level — 0 to 127**

This sets the overall level for the effect sound.

## ■ 20: QUADRUPLE-TAP-DELAY

This delay lets you set four independent delay times.

By setting the delay time to the length of a note, you can synchronize the delayed sound to the MIDI clock signal from an internal or external device.

This effect is used when you want to apply delays that are synchronized to the performance tempo of a sequencer or some other instrument.

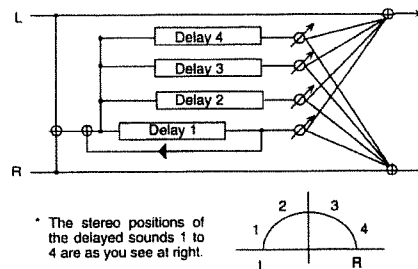

**<Delay1> Delay Time 1 — 200 ms to 1000 ms** *♩/♪/♫/♬*

This sets the interval from the time when the original sound is played until the delayed sound (1) is played.

200 to 545 ms: In 5 ms steps  
550 to 1000 ms: In 10 ms steps

\* When set as a note value, the Delay Time can be synchronized with the module's internal clock or the MIDI clock arriving from an external device. For details, refer to "Triple Tap Delay."

\* The setting values for Delay Time 2 to Delay time 4 are the same.

**<Delay2> Delay Time 2 — 200 ms to 1000 ms** *♩/♪/♫/♬*

This sets the interval from the time when the original sound is played until the delayed sound (2) is played.

**<Delay3> Delay Time 3 — 200 ms to 1000 ms** *♩/♪/♫/♬*

This sets the interval from the time when the original sound is played until the delayed sound (3) is played.

**<Delay4> Delay Time 4 — 200 ms to 1000 ms** *♩/♪/♫/♬*

This sets the interval from the time when the original sound is played until the delayed sound (4) is played.

**<Level 1> Level 1**

This sets the volume for the delayed sound (1).

**<Level 2> Level 2**

This sets the volume for the delayed sound (2).

**<Level 3> Level 3**

This sets the volume for the delayed sound (3).

**<Level 4> Level 4**

This sets the volume for the delayed sound (4).

**\*<Fbk> Feedback — -98% to +98%**

This sets the amount of feedback for the delayed sound. "Feedback" refers to returning a portion of the output signal to the input signal.

This sets the percentage of the in-phase or inverted-phase output signal (positive or negative value) that is returned to the input. You can set a value from -98% to +98%, in steps of 2%. No feedback is applied when this is set to zero.

**<HF Damp> High-Frequency Damp —**

200/250/315/400/500/630/800/1000/1250/1600/2000/2500/3150/4000/5000/6300/8000 (200 Hz to 8 kHz), **BYPASS**

This sets the frequency at which the high-frequency components of the reverb sound are cut off.

The degree to which the high-frequency components of a reverb sound are attenuated depends on the composition of surrounding walls. HF Damp (high-frequency damp) is a parameter which simulates this by attenuating the high-frequency components.

A lower cutoff frequency results in a sedate sound, while a higher frequency produces a brighter sound. When set to "BYPASS," no high-frequency components are cut off.

**\*<Balance> Effect Balance — D100:0E to D0:100E**

This sets the balance for the levels of the original sound and the effect sound (delayed sound).

**<Level> Output Level — 0 to 127**

This sets the overall level for the effect sound.

## 21: TIME-CONTROL-DELAY

This lets you control a delay time in real time.

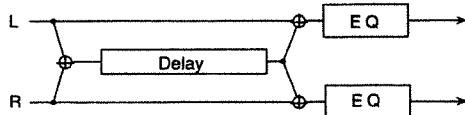

When the delay time has been made to change, the delay time and pitch of the delayed sound change at the speed set for Acceleration. Depending on the settings you use, you can achieve some really tricky effects with this.

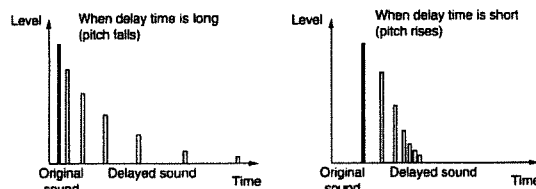

You can use a Controller assigned with EFX Control Source (see p. 46) to control the delay time. For example, if you set Source to "Expression," you can control the delay time with the expression pedal as an external controller.

**\*<Delay> Delay Time — 200 ms to 1000 ms**

This sets the interval from the time when the original sound is played until the delayed sound is played.

200 to 595 ms: In 5 ms steps

600 to 1000 ms: In 10 ms steps

**<Accel> Acceleration — 0 to 15**

This makes the delay interval for the delayed sound approach the setting value from zero.

**\*<Fbk> Feedback — -98% to +98%**

This sets the amount of feedback for the delayed sound. "Feedback" refers to returning a portion of the output signal to the input signal.

This sets the percentage of the in-phase or inverted-phase output signal (positive or negative value) that is returned to the input.

You can set a value from -98% to +98%, in steps of 2%. No feedback is applied when this is set to zero.

**<Pan> Output Pan — 63R to 0 to L64**

This sets the stereo position where the effect sound is output. L64 is leftmost, 0 is centered, and 63R is rightmost.

**<HF Damp> High-Frequency Damp —**

200/250/315/400/500/630/800/1000/1250/1600/2000/2500/3150/4000/5000/6300/8000 (200 Hz to 8 kHz), BYPASS

This sets the frequency at which the high-frequency components of the reverb sound are cut off.

The degree to which the high-frequency components of a reverb sound are attenuated depends on the composition of surrounding walls. HF Damp (high-frequency damp) is a parameter which simulates this by attenuating the high-frequency components.

A lower cutoff frequency results in a sedate sound, while a higher frequency produces a brighter sound. When set to "BYPASS," no high-frequency components are cut off.

**<LowGain> Low Gain — -15 dB to +15 dB**

This sets the bass sound quality. A larger positive value results in greater emphasis of the lower band.

**<Hi Gain> High Gain — -15 dB to +15 dB**

This sets the treble sound quality. A larger positive value results in greater emphasis of the higher band.

**<Balance> Effect Balance — D100:0E to D0:100E**

This sets the balance for the levels of the original sound and the effect sound.

**<Level> Output Level — 0 to 127**

This sets the overall level for the effect sound.

## 22: 2 VOICE-PITCH-SHIFTER

This changes the pitch of the original sound. You can make subtle changes in two different pitches.

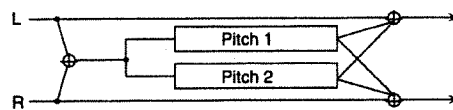

**\*<CoarseA> Coarse Pitch A — -24 to +12**

This sets the amount of change in pitch for pitch-shifted sound A, in half-tone increments.

You can make a setting up to one octave higher or two octaves lower.

**<FineA> Fine Pitch A — -100 to +100**

This sets the amount of change in pitch for pitch-shifted sound A, in increments of 2 cents (a cent is 1/100th of a half-tone).

**<Pan A> Output Pan A — L64 to 0 to 63R**

This sets the stereo position at which pitch-shifted sound A is output. L64 is leftmost, 0 is centered, and 63R is rightmost.

**<PreDlyA> Predelay Time A — 0 ms to 500 ms**

This sets the delay time for pitch-shifted sound A.

0 to 4.9 ms: In 0.1 ms steps

5.0 to 9.5 ms: In 0.5 ms steps

10 to 39 ms: In 1 ms steps

40 to 290 ms: In 10 ms steps

300 to 500 ms: In 20 ms steps

**\*<CoarseB> Coarse Pitch B — -24 to +12**

This sets the amount of change in pitch for pitch-shifted sound B, in half-tone increments.

You can make a setting up to one octave higher or two octaves lower.

**<FineB> Fine Pitch B — -100 to +100**

This sets the amount of change in pitch for pitch-shifted sound B, in increments of 2 cents (a cent is 1/100th of a half-tone).

**<Pan B> Output Pan B — L64 to 0 to 63R**

This sets the stereo position at which pitch-shifted sound B is output. L64 is leftmost, 0 is centered, and 63R is rightmost.

**<PreDlyB> Predelay Time B — 0 ms to 500 ms**

This sets the delay time for pitch-shifted sound B.

|                |                 |
|----------------|-----------------|
| 0 to 4.9 ms:   | In 0.1 ms steps |
| 5.0 to 9.5 ms: | In 0.5 ms steps |
| 10 to 39 ms:   | In 1 ms steps   |
| 40 to 290 ms:  | In 10 ms steps  |
| 300 to 500 ms: | In 20 ms steps  |

**<Mode> Pitch Shift Mode — 1 to 5**

This selects the pitch shift mode. Larger mode numbers result in longer response times but less undulations in the sound.

**<Lvl Bal> Level Balance — A100:0B to A0:100B**

This sets the volume balance for pitch-shifted sounds A and B.

**<Balance> Effect Balance — D100:0E to D0:100E**

This sets the balance for the levels of the original sound and the effect sound.

**<Level> Output Level — 0 to 127**

This sets the overall level for the effect sound.

**■ 23: FBK-PITCH-SHIFTER (Feedback-Pitch-Shifter)**

This is a pitch shifter with a feedback loop.

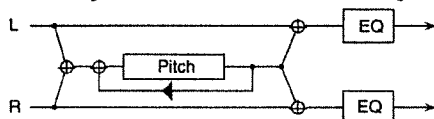

**\*<Coarse> Coarse Pitch — -24 to +12**

This sets the amount of change in pitch for the pitch-shifted sound, in half-tone increments. You can make a setting up to one octave higher or two octaves lower.

**<Fine> Fine Pitch — -100 to +100**

This sets the amount of change in pitch for the pitch-shifted sound, in increments of 2 cents (a cent is 1/100th of a half-tone).

**<Pan> Output Pan — L64 to 0 to 63R**

This sets the stereo position at which the pitch-shifted sound is output. L64 is leftmost, 0 is centered, and 63R is rightmost.

**<PreDly> Predelay Time — 0 ms to 500 ms**

This sets the delay time for the pitch-shifted sound.

|                |                 |
|----------------|-----------------|
| 0 to 4.9 ms:   | In 0.1 ms steps |
| 5.0 to 9.5 ms: | In 0.5 ms steps |
| 10 to 39 ms:   | In 1 ms steps   |
| 40 to 290 ms:  | In 10 ms steps  |
| 300 to 500 ms: | In 20 ms steps  |

**<Mode> Pitch Shift Mode — 1 to 5**

This selects the pitch shift mode. Larger mode numbers result in longer response times but less undulations in the sound.

**\*<Feedback> Feedback — -98% to +98%**

This sets the amount of feedback for the pitch-shifted sound. "Feedback" refers to returning a portion of the output signal to the input signal.

This sets the percentage of the in-phase or inverted-phase output signal (positive or negative value) that is returned to the input.

You can set a value from -98% to +98%, in steps of 2%. No feedback is applied when this is set to zero.

**<Low Gain> Low Gain — -15 dB to +15 dB**

This sets the bass sound quality. A larger positive value results in greater emphasis of the lower band.

**<Hi Gain> High Gain — -15 dB to +15 dB**

This sets the treble sound quality. A larger positive value results in greater emphasis of the higher band.

**<Balance> Effect Balance — D100:0E to D0:100E**

This sets the balance for the levels of the original sound and the effect sound.

**<Level> Output Level — 0 to 127**

This sets the overall level for the effect sound.

**■ 24: REVERB**

This adds lingering reverberations to the original sound to simulate sounds played in a spacious setting.

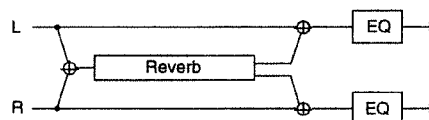

**<Type> Reverb Type — ROOM1/ROOM2/STAGE1/STAGE2/HALL1/HALL2**

This selects the type of reverb.

**ROOM1:**

Short, high-density reverb

**ROOM2:**

Short, low-density reverb

**STAGE1:**

Reverb with many later reverberations

**STAGE2:**

Reverb with strong initial reflection

**HALL1:**

Clear reverb

**HALL2:**

Rich reverb

**<Pre Dly> Predelay Time — 0 ms to 100 ms**

This sets the interval from the time when the original sound is played until the time when the REVERB sound is played.

|                |                 |
|----------------|-----------------|
| 0 to 4.9 ms:   | In 0.1 ms steps |
| 5.0 to 9.5 ms: | In 0.5 ms steps |
| 10 to 49 ms:   | In 1 ms steps   |
| 50 to 100 ms:  | In 2 ms steps   |

**\*<Time> Reverb Time — 0 to 127**

This sets the time from when the reverb sound starts until it fades away.

**<HF Damp> High-Frequency Damp — 200/250/315/400/500/630/800/1000/1250/1600/2000/2500/3150/4000/5000/6300/8000 (200 Hz to 8 kHz), BYPASS**

This sets the frequency at which the high-frequency components of the reverb sound are cut off.

The degree to which the high-frequency components of a reverb sound are attenuated depends on the composition of surrounding walls. HF Damp (high-frequency damp) is a parameter which simulates this by attenuating the high-frequency components.

A lower cutoff frequency results in a sedate sound, while a higher frequency produces a brighter sound. When set to "BYPASS," no high-frequency components are cut off.

**<LowGain> Low Gain — -15 dB to +15 dB**

This sets the bass sound quality. A larger positive value results in greater emphasis of the lower band.

**<Hi Gain> High Gain — -15 dB to +15 dB**

This sets the treble sound quality. A larger positive value results in greater emphasis of the higher band.

**\*<Balance> Effect Balance — D100:0E to D0:100E**

This sets the balance for the levels of the original sound and the effect (reverb) sound.

**<Level> Output Level — 0 to 127**

This sets the overall level for the effect sound.

## ■ 25: GATE-REVERB

This reverb mutes out the lingering reverberations while they are in progress.

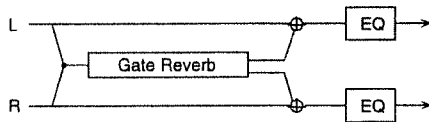

**<Type> Reverb Type — NORMAL/REVERSE/SWEEP1/SWEEP2**

This selects the type of reverb.

**NORMAL:**

This is a normal gate reverb.

**REVERSE:**

With this type, the reverb is rotated in reverse.

**SWEEP1:**

The reverb sound moves from right to left.

**SWEEP2:**

The reverb sound moves from left to right.

**<Pre Dly> Predelay Time — 0 ms to 100 ms**

This sets the interval from the time when the original sound is played until the time when the REVERB sound is played.

|                |                 |
|----------------|-----------------|
| 0 to 4.9 ms:   | In 0.1 ms steps |
| 5.0 to 9.5 ms: | In 0.5 ms steps |
| 10 to 49 ms:   | In 1 ms steps   |
| 50 to 100 ms:  | In 2 ms steps   |

**<GateTime> Gate Time — 5 to 500**

This sets the interval from the time the reverb sound starts until the time when it is muted.

**<LowGain> Low Gain — -15 dB to +15 dB**

This sets the bass sound quality. A larger positive value results in greater emphasis of the lower band.

**<Hi Gain> High Gain — -15 dB to +15 dB**

This sets the treble sound quality. A larger positive value results in greater emphasis of the higher band.

**\*<Balance> Effect Balance — D100:0E to D0:100E**

This sets the balance for the levels of the original sound and the effect (reverb) sound.

**\*<Level> Output Level — 0 to 127**

This sets the overall level for the effect sound.

## ■ 26: OVERDRIVE -> CHORUS

With this type, the Overdrive is connected in series with the Chorus.

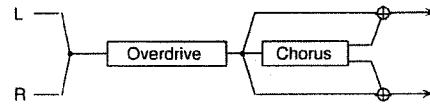

**<Drive> Drive — 0 to 127**

This sets the strength of the overdrive sound distortion.

**\*<Pan> Overdrive Pan — L64 to 0 to 63R**

This sets the stereo position where the overdrive sound is output. L64 is leftmost, 0 is centered, and 63R is rightmost.

**<Pre Dly> Chorus Predelay — 0 ms to 100 ms**

This sets the interval from the time when the original sound is played until the time when the chorus sound is played.

|                |                 |
|----------------|-----------------|
| 0 to 4.9 ms:   | In 0.1 ms steps |
| 5.0 to 9.5 ms: | In 0.5 ms steps |
| 10 to 49 ms:   | In 1 ms steps   |
| 50 to 100 ms:  | In 2 ms steps   |

**<Rate> Chorus Rate — 0.05 Hz to 10.0 Hz**

This sets the cycle for the chorus sound undulations.

|                  |                  |
|------------------|------------------|
| 0.05 to 4.95 Hz: | In 0.05 Hz steps |
| 5.0 to 6.9 Hz:   | In 0.1 Hz steps  |
| 7.0 to 10.0 Hz:  | In 0.5 Hz steps  |

**<Depth> Chorus Depth — 0 to 127**

This sets the depth of the undulations of the chorus sound.

**\*<Balance> Chorus Balance — D100:0E to D0:100E**

This sets the balance for the levels of the overdrive sound and the overdrive + chorus sound. A setting of "D100:0E" outputs only the overdrive sound, and a setting of "D0:100E" outputs overdrive + chorus sound.

**<Level> Output Level — 0 to 127**

This sets the overall level for the effect sound.

## ■ 27: OVERDRIVE -> FLANGER

With this type, the Overdrive is connected in series with the Flanger.

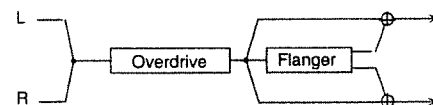

**<Drive> Drive — 0 to 127**

This sets the strength of the overdrive sound distortion.

**\*<Pan> Overdrive Pan — L64 to 0 to 63R**

This sets the stereo position where the overdrive sound is output. L64 is leftmost, 0 is centered, and 63R is rightmost.

**<Pre Dly> Flanger Pre delay — 0 ms to 100 ms**

This sets the interval from the time when the original sound is played until the time when the flanger sound is played.

|                |                 |
|----------------|-----------------|
| 0 to 4.9 ms:   | In 0.1 ms steps |
| 5.0 to 9.5 ms: | In 0.5 ms steps |
| 10 to 49 ms:   | In 1 ms steps   |
| 50 to 100 ms:  | In 2 ms steps   |

**<Rate> Flanger Rate — 0.05 Hz to 10.0 Hz**

This sets the cycle for the flanger undulations.

- 0.05 to 4.95 Hz: In 0.05 Hz steps
- 5.0 to 6.9 Hz: In 0.1 Hz steps
- 7.0 to 10.0 Hz: In 0.5 Hz steps

**<Depth> Flanger Depth — 0 to 127**

This sets the depth of the flanger undulations.

**<Fbk> Feedback — -98% to +98%**

This sets the amount of feedback for the flanger sound. "Feedback" refers to returning a portion of the output signal to the input signal. This sets the percentage of the in-phase or inverted-phase output signal (positive or negative value) that is returned to the input.

You can set a value from -98% to +98%, in steps of 2%. No feedback is applied when this is set to zero.

**\*<Balance> Flanger Balance — D100:0E to D0:100E**

This sets the balance for the levels of the overdrive sound and the overdrive + flanger sound. A setting of "D100:0E" outputs only the overdrive sound, and a setting of "D0:100E" outputs overdrive + flanger sound.

**<Level> Output Level — 0 to 127**

This sets the overall level for the effect sound.

---

## ■ 28: OVERDRIVE -> DELAY

---

With this type, the Overdrive is connected in series with the Delay.

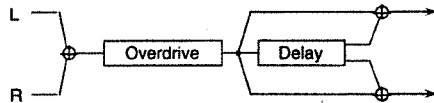

**<Drive> Drive — 0 to 127**

This sets the strength of the overdrive sound distortion.

**\*<Pan> Overdrive Pan — L64 to 0 to 63R**

This sets the stereo position where the overdrive sound is output. L64 is leftmost, 0 is centered, and 63R is rightmost.

**<Delay> Delay Time — 0 ms to 500 ms**

This sets the interval from the time when the original sound is played until the delayed sound is played.

- 0 to 4.9 ms: In 0.1 ms steps
- 5.0 to 9.5 ms: In 0.5 ms steps
- 10 to 39 ms: In 1 ms steps
- 40 to 290 ms: In 10 ms steps
- 300 to 500 ms: In 20 ms steps

**<Fbk> Delay Feedback — -98% to +98%**

This sets the amount of feedback for the delayed sound. "Feedback" refers to returning a portion of the output signal to the input signal. This sets the percentage of the in-phase or inverted-phase output signal (positive or negative value) that is returned to the input.

You can set a value from -98% to +98%, in steps of 2%. No feedback is applied when this is set to zero.

**<HF Damp> Delay HF Damp — 200/250/315/400/500/630/800/1000/1250/1600/2000/2500/3150/4000/5000/6300/8000 (200 Hz to 8 kHz), BYPASS**

This sets the frequency at which the high-frequency components of the reverb sound are cut off.

The degree to which the high-frequency components of a reverb sound are attenuated depends on the composition of

surrounding walls. HF Damp (high-frequency damp) is a parameter which simulates this by attenuating the high-frequency components.

A lower cutoff frequency results in a sedate sound, while a higher frequency produces a brighter sound. When set to "BYPASS," no high-frequency components are cut off.

**\*<Balance> Balance — D100:0E to D0:100E**

This sets the balance for the levels of the overdrive sound and the overdrive + delayed sound. A setting of "D100:0E" outputs only the overdrive sound, and a setting of "D0:100E" outputs overdrive + delayed sound.

**<Level> Output Level — 0 to 127**

This sets the overall level for the effect sound.

---

## ■ 29: DISTORTION -> CHORUS

---

With this type, Distortion is connected in series with the Chorus.

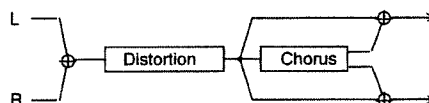

\* The parameters that you can set are the same as for "OVERDRIVE -> CHORUS."

---

## ■ 30: DISTORTION -> FLANGER

---

With this type, Distortion is connected in series with the Flanger.

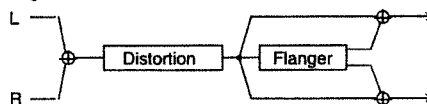

\* The parameters that you can set are the same as for "OVERDRIVE -> FLANGER."

---

## ■ 31: DISTORTION -> DELAY

---

With this type, Distortion is connected in series with the Delay.

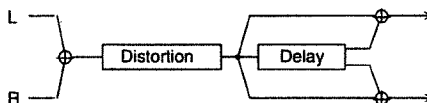

\* The parameters that you can set are the same as for "OVERDRIVE -> DELAY."

---

## ■ 32: ENHANCER -> CHORUS

---

With this type, the Enhancer is connected in series with the Chorus.



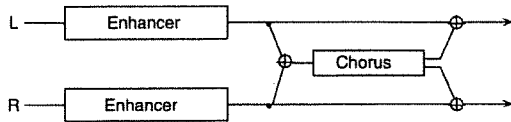

**\*<Sens> Sensitivity — 0 to 127**

This sets the depth to which the Enhancer is applied.

**<Mix> Mix Level — 0 to 127**

This sets the ratio for mixing the original sound with the generated harmonics.

**<Pre Dly> Chorus Pre delay — 0 ms to 100 ms**

This sets the interval from the time when the original sound is played until the time when the chorus sound is played.

|                |                 |
|----------------|-----------------|
| 0 to 4.9 ms:   | In 0.1 ms steps |
| 5.0 to 9.5 ms: | In 0.5 ms steps |
| 10 to 49 ms:   | In 1 ms steps   |
| 50 to 100 ms:  | In 2 ms steps   |

**<Rate> Chorus Rate — 0.05 Hz to 10.0 Hz**

This sets the cycle for the chorus sound undulations.

|                  |                  |
|------------------|------------------|
| 0.05 to 4.95 Hz: | In 0.05 Hz steps |
| 5.0 to 6.9 Hz:   | In 0.1 Hz steps  |
| 7.0 to 10.0 Hz:  | In 0.5 Hz steps  |

**<Depth> Chorus Depth — 0 to 127**

This sets the depth of the undulations of the chorus sound.

**\*<Balance> Chorus Balance — D100:0E to D0:100E**

This sets the balance for the levels of the enhancer sound and the enhancer + chorus sound. A setting of "D100:0E" outputs only the enhancer sound, and a setting of "D0:100E" outputs enhancer + chorus sound.

**<Level> Output Level — 0 to 127**

This sets the overall level for the effect sound.

## ■ 33: ENHANCER -> FLANGER

With this type, the Enhancer is connected in series with the Flanger.

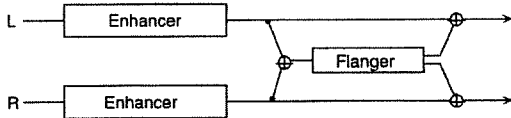

**\*<Sens> Sensitivity — 0 to 127**

This sets the depth to which the Enhancer is applied.

**<Mix> Mix Level — 0 to 127**

This sets the ratio for mixing the original sound with the generated harmonics.

**<Pre Dly> Flanger Pre delay — 0 ms to 100 ms**

This sets the interval from the time when the original sound is played until the time when the flanger sound is played.

|                |                 |
|----------------|-----------------|
| 0 to 4.9 ms:   | In 0.1 ms steps |
| 5.0 to 9.5 ms: | In 0.5 ms steps |
| 10 to 49 ms:   | In 1 ms steps   |
| 50 to 100 ms:  | In 2 ms steps   |

**<Rate> Flanger Rate — 0.05 Hz to 10.0 Hz**

This sets the cycle for the flanger undulations.

|                  |                  |
|------------------|------------------|
| 0.05 to 4.95 Hz: | In 0.05 Hz steps |
| 5.0 to 6.9 Hz:   | In 0.1 Hz steps  |
| 7.0 to 10.0 Hz:  | In 0.5 Hz steps  |

**<Depth> Flanger Depth — 0 to 127**

This sets the depth of the flanger undulations.

**<Fbk> Flanger Feedback — -98% to +98%**

This sets the amount of feedback for the flanged sound. "Feedback" refers to returning a portion of the output signal to the input signal. This sets the percentage of the in-phase or inverted-phase output signal (positive or negative value) that is returned to the input.

You can set a value from -98% to +98%, in steps of 2%. No feedback is applied when this is set to zero.

**\*<Balance> Flanger Balance — D100:0E to D0:100E**

This sets the balance for the levels of the enhancer sound and the enhancer + flanger sound. A setting of "D100:0E" outputs only the enhancer sound, and a setting of "D0:100E" outputs enhancer + flanger sound.

**<Level> Output Level — 0 to 127**

This sets the overall level for the effect sound.

## ■ 34: ENHANCER -> DELAY

With this type, the Enhancer is connected in series with the Delay.

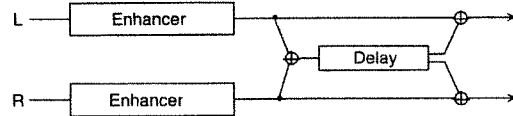

**\*<Sens> Sensitivity — 0 to 127**

This sets the depth to which the Enhancer is applied.

**<Mix> Mix Level — 0 to 127**

This sets the ratio for mixing the original sound with the generated harmonics.

**<Delay> Delay Time — 0 ms to 500 ms**

This sets the interval from the time when the original sound is played until the delayed sound is played.

|                |                 |
|----------------|-----------------|
| 0 to 4.9 ms:   | In 0.1 ms steps |
| 5.0 to 9.5 ms: | In 0.5 ms steps |
| 10 to 39 ms:   | In 1 ms steps   |
| 40 to 290 ms:  | In 10 ms steps  |
| 300 to 500 ms: | In 20 ms steps  |

**<Fbk> Delay Feedback — -98% to +98%**

This sets the amount of feedback for the delayed sound. "Feedback" refers to returning a portion of the output signal to the input signal. This sets the percentage of the in-phase or inverted-phase output signal (positive or negative value) that is returned to the input.

You can set a value from -98% to +98%, in steps of 2%. No feedback is applied when this is set to zero.

**<HF Damp> Delay HF Damp — 200/250/315/400/500/630/800/1000/1250/1600/2000/2500/3150/4000/5000/6300/8000 (200 Hz to 8 kHz), BYPASS**

This sets the frequency at which the high-frequency components of the reverb sound are cut off.

The degree to which the high-frequency components of a reverb sound are attenuated depends on the composition of surrounding walls. HF Damp (high-frequency damp) is a parameter which simulates this by attenuating the high-frequency components.

A lower cutoff frequency results in a sedate sound, while a

higher frequency produces a brighter sound. When set to "BYPASS," no high-frequency components are cut off.

**\*<Balance> Delay Balance — D100:0E to D0:100E**

This sets the balance for the levels of the enhancer sound and the enhancer + delayed sound. A setting of "D100:0E" outputs only the enhancer sound, and a setting of "D0:100E" outputs enhancer + delayed sound.

**<Level> Output Level — 0 to 127**

This sets the overall level for the effect sound.

## ■ 35: CHORUS -> DELAY

This type connects Chorus and Delay in series.

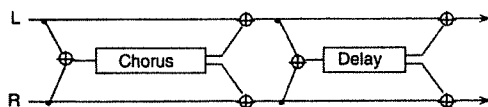

**<Cho Dly> Chorus Predelay — 0 ms to 100 ms**

This sets the interval from the time when the original sound is played until the time when the chorus sound is played.

|                |                 |
|----------------|-----------------|
| 0 to 4.9 ms:   | In 0.1 ms steps |
| 5.0 to 9.5 ms: | In 0.5 ms steps |
| 10 to 49 ms:   | In 1 ms steps   |
| 50 to 100 ms:  | In 2 ms steps   |

**<ChoRate> Chorus Rate — 0.05 Hz to 10.0 Hz**

This sets the cycle for the chorus sound undulations.

|                  |                  |
|------------------|------------------|
| 0.05 to 4.95 Hz: | In 0.05 Hz steps |
| 5.0 to 6.9 Hz:   | In 0.1 Hz steps  |
| 7.0 to 10.0 Hz:  | In 0.5 Hz steps  |

**<Cho Dpt> Chorus Depth — 0 to 127**

This sets the depth of the undulations of the chorus sound.

**\*<Cho Bal> Chorus Balance — D100:0E to D0:100E**

This sets the balance for the levels of the original sound and the chorus sound. A setting of "D100:0E" outputs only the original sound, and a setting of "D0:100E" outputs chorus sound only.

**<Delay> Delay Time — 0 ms to 500 ms**

This sets the interval from the time when the original sound is played until the delayed sound is played.

|                |                 |
|----------------|-----------------|
| 0 to 4.9 ms:   | In 0.1 ms steps |
| 5.0 to 9.5 ms: | In 0.5 ms steps |
| 10 to 39 ms:   | In 1 ms steps   |
| 40 to 290 ms:  | In 10 ms steps  |
| 300 to 500 ms: | In 20 ms steps  |

**<Dly Fbk> Delay Feedback — -98% to +98%**

This sets the amount of feedback for the delayed sound. "Feedback" refers to returning a portion of the output signal to the input signal. This sets the percentage of the in-phase or inverted-phase output signal (positive or negative value) that is returned to the input.

You can set a value from -98% to +98%, in steps of 2%. No feedback is applied when this is set to zero.

**<HF Damp> Delay HF Damp — 200/250/315/400/500/630/800/1000/1250/1600/2000/2500/3150/4000/5000/6300/8000 (200 Hz to 8 kHz), BYPASS**

This sets the frequency at which the high-frequency components of the reverb sound are cut off.

The degree to which the high-frequency components of a reverb sound are attenuated depends on the composition of surrounding walls. HF Damp (high-frequency damp) is a parameter which simulates this by attenuating the high-frequency components.

frequency components.

A lower cutoff frequency results in a sedate sound, while a higher frequency produces a brighter sound. When set to "BYPASS," no high-frequency components are cut off.

**\*<Delay Balance> Delay Balance — D100:0E to D0:100E**

This sets the balance for the levels of the chorus sound and the chorus + delayed sound. A setting of "D100:0E" outputs only the chorus sound, and a setting of "D0:100E" outputs chorus + delayed sound.

**<Level> Output Level — 0 to 127**

This sets the overall level for the effect sound.

## ■ 36: FLANGER -> DELAY

This type connects the Flanger and Delay in series.

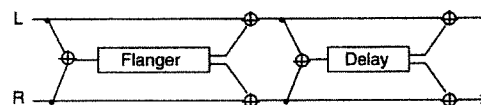

**<Flg Dly> Flanger Predelay — 0 ms to 100 ms**

This sets the interval from the time when the original sound is played until the time when the flanger sound is played.

|                |                 |
|----------------|-----------------|
| 0 to 4.9 ms:   | In 0.1 ms steps |
| 5.0 to 9.5 ms: | In 0.5 ms steps |
| 10 to 49 ms:   | In 1 ms steps   |
| 50 to 100 ms:  | In 2 ms steps   |

**<FlgRate> Flanger Rate — 0.05 Hz to 10.0 Hz**

This sets the cycle for the flanger undulations.

|                  |                  |
|------------------|------------------|
| 0.05 to 4.95 Hz: | In 0.05 Hz steps |
| 5.0 to 6.9 Hz:   | In 0.1 Hz steps  |
| 7.0 to 10.0 Hz:  | In 0.5 Hz steps  |

**<Flg Dpt> Flanger Depth — 0 to 127**

This sets the depth of the flanger undulations.

**<Flg Fbk> Flanger Feedback — -98% to +98%**

This sets the amount of feedback for the flanger sound. "Feedback" refers to returning a portion of the output signal to the input signal. This sets the percentage of the in-phase or inverted-phase output signal (positive or negative value) that is returned to the input.

You can set a value from -98% to +98%, in steps of 2%. No feedback is applied when this is set to zero.

**\*<Flg Bal> Flanger Balance — D100:0E to D0:100E**

This sets the balance for the levels of the original sound and the flanger sound. A setting of "D100:0E" outputs only the original sound, and a setting of "D0:100E" outputs flanger sound only.

**<Delay> Delay Time — 0 ms to 500 ms**

This sets the interval from the time when the original sound is played until the delayed sound is played.

|                |                 |
|----------------|-----------------|
| 0 to 4.9 ms:   | In 0.1 ms steps |
| 5.0 to 9.5 ms: | In 0.5 ms steps |
| 10 to 39 ms:   | In 1 ms steps   |
| 40 to 290 ms:  | In 10 ms steps  |
| 300 to 500 ms: | In 20 ms steps  |

**<Dly Fbk> Delay Feedback — -98% to +98%**

This sets the amount of feedback for the delayed sound. "Feedback" refers to returning a portion of the output signal to the input signal. This sets the percentage of the in-phase or inverted-phase output signal (positive or negative value) that is returned to the input.

You can set a value from -98% to +98%, in steps of 2%. No feedback is applied when this is set to zero.

**<HF Damp> Delay HF Damp — 200/250/315/400/500/630/800/1000/1250/1600/2000/2500/3150/4000/5000/6300/8000 (200 Hz to 8 kHz), BYPASS**

This sets the frequency at which the high-frequency components of the reverb sound are cut off.

The degree to which the high-frequency components of a reverb sound are attenuated depends on the composition of surrounding walls. HF Damp (high-frequency damp) is a parameter which simulates this by attenuating the high-frequency components.

A lower cutoff frequency results in a sedate sound, and a higher frequency produces a brighter sound. When set to "BYPASS," no high-frequency components are cut off.

**\*<Delay Balance> Delay Balance — D100:0E to D0:100E**

This sets the balance for the levels of the flanger sound and the flanger + delayed sound. A setting of "D100:0E" outputs only the flanger sound, and a setting of "D0:100E" outputs flanger + delayed sound.

**<Level> Output Level — 0 to 127**

This sets the overall level for the effect sound.

## ■ 37: CHORUS -> FLANGER

This type connects the Chorus and Flanger in series.

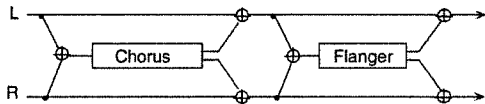

**<Cho Dly> Chorus Predelay — 0 ms to 100 ms**

This sets the interval from the time when the original sound is played until the time when the chorus sound is played.

|                |                 |
|----------------|-----------------|
| 0 to 4.9 ms:   | In 0.1 ms steps |
| 5.0 to 9.5 ms: | In 0.5 ms steps |
| 10 to 49 ms:   | In 1 ms steps   |
| 50 to 100 ms:  | In 2 ms steps   |

**<ChoRate> Chorus Rate — 0.05 Hz to 10.0 Hz**

This sets the cycle for the chorus sound undulations.

|                  |                  |
|------------------|------------------|
| 0.05 to 4.95 Hz: | In 0.05 Hz steps |
| 5.0 to 6.9 Hz:   | In 0.1 Hz steps  |
| 7.0 to 10.0 Hz:  | In 0.5 Hz steps  |

**<Cho Dpt> Chorus Depth — 0 to 127**

This sets the depth of the undulations of the chorus sound.

**\*<Cho Bal> Chorus Balance — D100:0E to D0:100E**

This sets the balance for the levels of the original sound and the chorus sound. A setting of "D100:0E" outputs only the original sound, and a setting of "D0:100E" outputs chorus sound only.

**<Flg Dly> Flanger Predelay — 0 ms to 100 ms**

This sets the interval from the time when the original sound is played until the time when the flanger sound is played.

|                |                 |
|----------------|-----------------|
| 0 to 4.9 ms:   | In 0.1 ms steps |
| 5.0 to 9.5 ms: | In 0.5 ms steps |
| 10 to 49 ms:   | In 1 ms steps   |
| 50 to 100 ms:  | In 2 ms steps   |

**<FlgRate> Flanger Rate — 0.05 Hz to 10.0 Hz**

This sets the cycle for the flanger undulations.

|                  |                  |
|------------------|------------------|
| 0.05 to 4.95 Hz: | In 0.05 Hz steps |
| 5.0 to 6.9 Hz:   | In 0.1 Hz steps  |
| 7.0 to 10.0 Hz:  | In 0.5 Hz steps  |

**<Flg Dpt> Flanger Depth — 0 to 127**

This sets the depth of the flanger undulations.

**<Flg Fbk> Flanger Feedback — -98% to +98%**

This sets the amount of feedback for the flanger sound. "Feedback" refers to returning a portion of the output signal to the input signal. This sets the percentage of the in-phase or inverted-phase output signal (positive or negative value) that is returned to the input.

You can set a value from -98% to +98%, in steps of 2%. No feedback is applied when this is set to zero.

**\*<Flanger Balance> Flanger Balance — D100:0E to D0:100E**

This sets the balance for the levels of the chorus sound and the chorus + flanger sound. A setting of "D100:0E" outputs only the chorus sound, and a setting of "D0:100E" outputs chorus + flanger sound.

**<Level> Output Level — 0 to 127**

This sets the overall level for the effect sound.

## ■ 38: CHORUS/DELAY

This type connects the Chorus and Delay in parallel.

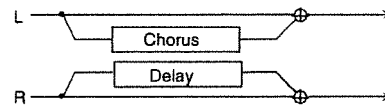

\* The parameters that you can set are the same as for "CHORUS -> DELAY." However, the Delay Balance setting determines the balance level for the original sound and the delayed sound.

## ■ 39: FLANGER/DELAY

This type connects the Flanger and Delay in parallel.

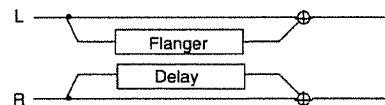

\* The parameters that you can set are the same as for "FLANGER -> DELAY." However, the Delay Balance setting determines the balance level for the original sound and the delayed sound.

## ■ 40: CHORUS/FLANGER

This type connects the Chorus and Flanger in parallel.

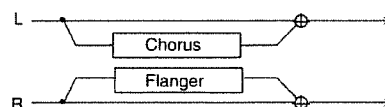

\* The parameters that you can set are the same as for "CHORUS -> FLANGER." However, the Flanger Balance setting determines the balance level for the original sound and the flanger sound.

# JV-1080 Effect Routing

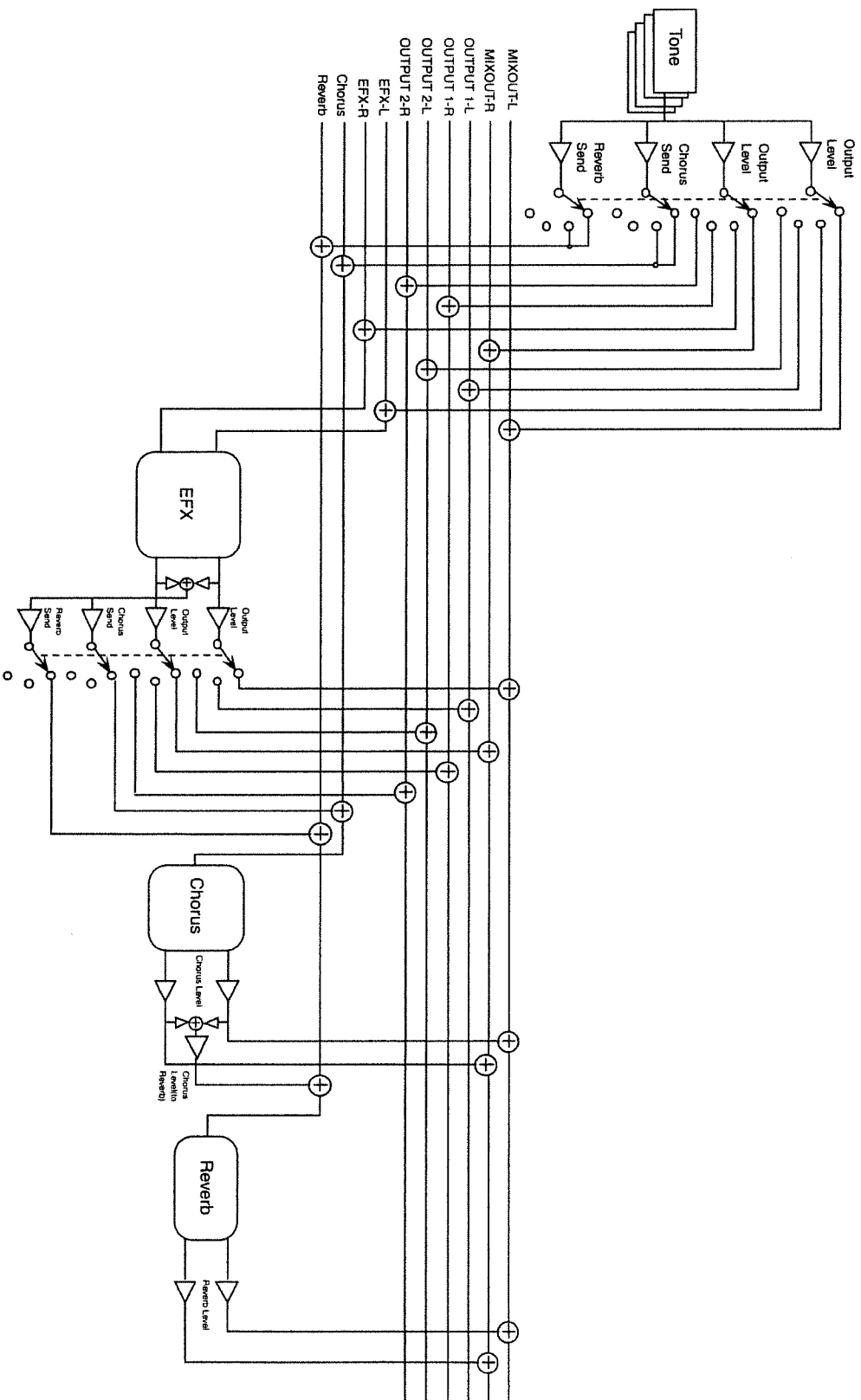



# Chapter 6

## Supplementary Materials

---

# Troubleshooting

## ■ Error Messages

If you make a mistake in operating the **JV-1080**, or if something doesn't execute correctly, an error message appears on the display for a few moments. Check the error message and take action appropriately to correct the problem.

### ● Message Appearing at Powerup

#### Internal Battery Low

**Cause:** The **JV-1080**'s backup battery is almost out of power.

**Action:** Contact your nearest Roland Service Center.

### ● Messages About the User Memory

#### User Memory Write Protect

**Cause:** Write Protect (☞ p. 72) is on.

**Action:** Turn off Write Protect.

#### User Memory Read Error

**Cause:** The data in the internal memory cannot be read correctly.

**Action:** Try executing it again.

### ● Messages About the DATA Card

#### DATA Card Not Ready

**Cause:** A DATA Card is not inserted into the DATA Card slot, or is inserted incorrectly.

**Action:** Make sure that a DATA Card is inserted correctly.

#### DATA Card Battery Low

**Cause:** The DATA Card's backup battery is almost out of power.

**Action:** Check the manual for the DATA Card and replace the battery.

#### DATA Card Not Properly Formatted

**Cause:** A DATA Card that has not been initialized or that is for a different model has been inserted into the DATA Card slot.

**Action:** Initialize the DATA Card (☞ p. 73), or use a DATA Card for the **JV-1080**.

#### DATA Card Read Error

**Cause:** The DATA Card may have come out of the DATA Card slot during data transmission.

**Action:** Reinsert the DATA Card and execute the operation again.

#### DATA Card Write Protect

**Cause:** The DATA Card protect function is on (☞ p. 70).

**Action:** Switch off the DATA Card protect function.

#### Cannot Read Performance

**Cause:** A DATA Card for a different model has been inserted in the DATA Card slot.

**Action:** Use a DATA Card for the **JV-1080**.

### ● Messages About the PCM Card

#### PCM Card Not Ready

**Cause:** A PCM Card is not inserted in the PCM Card slot, or is inserted incorrectly.

**Action:** Make sure that a PCM Card is inserted correctly.

#### PCM Card Not Properly Formatted

**Cause:** A PCM Card for a different model has been inserted in the PCM Card slot.

**Action:** Use a PCM Card for the **JV-1080**.

#### PCM Card Not Patch

**Cause:** A PCM Card which does not contain Patch data has been inserted.

**Action:** Insert a PCM Card that contains Patch data.

### ● Messages About the Expansion Board

#### Expansion Board Not Ready

**Cause:** An Expansion Board is not installed, or is installed incorrectly.

**Action:** Make sure that an Expansion Board is installed correctly.

#### Expansion Board Not Properly Formatted

**Cause:** An Expansion Board for a different model has been installed.

**Action:** Use an Expansion Board for the **JV-1080**.

#### Expansion Board Not Patch

**Cause:** An Expansion Board which does not contain Patch data has been installed.

**Action:** Install an Expansion Board that contains Patch data.

#### Expansion Board Not Rhythm

**Cause:** An Expansion Board which does not contain Rhythm data has been installed.

**Action:** Install an Expansion Board that contains Rhythm data.

### ● Messages About MIDI

#### Exclusive Address Error

**Cause:** The address of an Exclusive (SysEx) message that has been received is incorrect.

**Action:** Check the addresses of the data being sent and carry out the operation again.

#### Check Sum Error

**Cause:** A checksum error has occurred for an Exclusive (SysEx) message that has been received.

**Action:** Check the checksums for the data being sent and carry out the operation again.

#### MIDI Buffer Full

**Cause:** A large amount of data that the **JV-1080** cannot process has been received.

**Action:** Reduce the amount of MIDI data sent from the transmitting device.

#### MIDI Communication Error

**Cause:** A MIDI cable may have come loose or been severed.

**Action:** Make sure that the MIDI cables and connections are secure.

#### BULK DUMP: Improper Data Card

**Cause:** A DATA card not formatted for the **JV-1080** has been inserted, and the data received as a bulk dump cannot be written into it.

**Action:** In Utility mode, format the DATA card (✎ p.73), and try the operation again.

#### BULK DUMP: Receive Data Error

**Cause:** The range of the data received by bulk dump was incorrect.

**Action:** Modify the data values to an appropriate range.

#### BULK DUMP: Data Format Error

**Cause:** The check sum value or data length of a bulk dump was incorrect.

**Action:** Check the check sum value or the data length.

#### BULK DUMP: User Memory Write Protected

**Cause:** Since Exclusive Write Protect is on, data received by bulk dump cannot be written into user memory.

**Action:** Turn off Exclusive Write Protect (✎ p.72).

#### BULK DUMP: Data Card Not Ready

**Cause:** Since a DATA card is not inserted, data received by bulk dump cannot be written into the card.

**Action:** Correctly insert a DATA card into the DATA card slot.

#### BULK DUMP: Data Card Write Protected

**Cause:** Since the protect switch of the DATA card is on, data received by bulk dump cannot be written into the card.

**Action:** Turn off the protect switch of the DATA card (✎ p.70), and try the operation again.

#### BULK DUMP: Check Sum Error

**Cause:** The check sum of a bulk dump was incorrect.

**Action:** Correct the exclusive data.

#### BULK DUMP: MIDI Buffer Full

**Cause:** An excessively large amount of data was received as a bulk dump.

**Action:** Make settings to reduce the amount of exclusive data that is transmitted as a single message.

## ■ Troubleshooting

If you're not getting any sound out, or you think the **JV-1080** is acting funny, please check the following. If these don't fix the problem, then go ahead and contact the store you bought it from, or your nearest Roland Service Station.

### ● No Sound

#### Is the volume too low?

⇨ Check the settings for the VOLUME knob on the **JV-1080** and the volume controls for connected mixers and amps.

#### Are connections correct?

⇨ If you are using headphones, the cable may be broken, or there may be a problem with an amp or a mixer. Check the cables and the connected equipment.

#### Are the MIDI send and receive channels set correctly?

⇨ Make sure that the MIDI send channel for the connected equipment matches the MIDI receive channel set for the **JV-1080** (✎ p. 59 and p. 67).

#### Are the level settings for Tones, Patches, and Parts too low?

⇨ Check the level settings for the Tones (✎ p. 55), the Patch level setting (✎ p. 42), and the Performance Part level setting (✎ p. 60).

#### Are Tones or Parts being muted?

⇨ Make sure the Tone switches or Part switches are set to ON (✎ p. 32).

#### Are the Key Range settings correct?

⇨ Check the Key Range settings for Tones and Parts (✎ p. 43 and p. 57).

#### Is the Part level set too low in volume/exclusive (SysEx) messages arriving from an external device?

⇨ Check this with the Information screen (✎ p. 38).

#### Are the Effect settings correct?

⇨ Check the Effect settings ON or OFF (✎ p. 38), in the Effect Balance level (✎ p. 83).

#### Are the settings for the output destination correct?

⇨ Check the setting for Output Assign (Patches: ✎ p. 45, Performances: ✎ p. 57).

### ● The Pitch Isn't Right

#### Is the Master Tune setting correct?

⇨ Check this setting (✎ p. 68).

---

**Are the Pitch settings for Tones and Parts correct?**

⇨ Check these settings (Tones: [☞](#) p. 52, Parts: [☞](#) p. 60).

**Is the JV-1080 receiving Pitch Bend messages from some external device?**

⇨ Check this with the Information screen ([☞](#) p. 40).

**● I Can't Change Patches**

**If the Receive switch for Program Change set to OFF?**

⇨ If you're using an external device to change Patches, make sure the MIDI channel settings match and set the Receive switch for Program Change to ON.

**Are you still at the Edit screen or in the ROM Play mode?**

⇨ Press [EXIT] or a Mode button to return to the Play mode.

**● I Can't Apply an Effect**

**Are the Effect parameter settings correct?**

⇨ Make sure the Effects are switched on ([☞](#) p. 38), and check the level setting for each of the Effects.

**Is the Output Assign setting correct?**

⇨ Check the Output Assign settings for Tones and Parts (Patches: [☞](#) p. 45, Performances: [☞](#) p. 57).

**● Can't receive over MIDI**

**Are you sure the settings for the receive channels and reception switches are appropriate?**

⇨ Check your settings for the MIDI receive channels (Patches: [☞](#) p. 67; Performances: [☞](#) p. 59), and the various MIDI reception switches ([☞](#) p. 68).

**Could you have inappropriate settings made for exclusive reception?**

⇨ Make sure the Exclusive Protect switch ([☞](#) p. 72) is turned OFF.  
Also, check to make sure the Unit Number setting matches that of the transmitting device ([☞](#) p. 67).

**● Can't use cards**

**Is the DATA card (M-256E, M-512E) formatted?**

⇨ DATA cards need to be formatted before they can be used. Format the card correctly ([☞](#) p. 73).

**Could you be trying to use a card that the JV-1080 doesn't support?**

⇨ This unit cannot read card data that was produced on any device other than those in the JV series (JV-1080/1000/90/80/880). Also, you cannot write data onto a card unless it has been formatted on the JV-1080.

**● Song data doesn't play back properly**

**Are you trying to start playback from midway through the song?**

⇨ A "GM System ON" message is included at the top of GM score data. If you haven't played the song from the beginning, this message would not have been conveyed, so the data might not be played properly.

**Are you trying to play song data designed for the GS Format?**

⇨ Since this unit is designed to support the General MIDI System, it may in certain cases not provide faithful playback if you try playing GS Format song data.



# Parameter List

## Patch Parameters

### COMMON

| Page         | Parameter                 | Display        | Value                | Reference |
|--------------|---------------------------|----------------|----------------------|-----------|
| PATCH NAME   | Patch Name                | ---            | (12 Character ASCII) | 42        |
| PATCH COMMON | Patch Level               | Level          | 0 — 127              | 42        |
|              | Patch Pan                 | Pan            | L64 — 0 — 63R        | 42        |
|              | Analog Feel Depth         | Analog Feel    | 0 — 127              | 42        |
|              | Octave Shift              | Octave         | -3 — 0 — +3          | 42        |
|              | Stretch Tune Depth        | Stretch        | OFF/1/2/3            | 42        |
|              | Voice Priority            | Priority       | LAST/LOUDEST         | 42        |
|              | Velocity Range Switch     | Velocity Range | OFF/ON               | 42        |
|              | Default Tempo             | Default Tempo  | 20 — 250             | 42        |
| VELOCITY     | Velocity Range Lower      | Lower          | 1 — 127              | 42        |
|              | Velocity Range Upper      | Upper          | 1 — 127              | 43        |
|              | Velocity Cross Fade Depth | X-Fade         | 0 — 127              | 43        |
| KEY RANGE    | Key Range Lower           | Lower          | C-1 — G9             | 43        |
|              | Key Range Upper           | Upper          | C-1 — G9             | 43        |
| STRUCT       | Structure                 | Struct         | 1 — 10               | 43        |
|              | Booster Level             | Booster        | 0/+6/+12/+18         | 44        |

### EFFECTS

| Page           | Parameter             | Display       | Value  | Reference |
|----------------|-----------------------|---------------|--|-----------|
| OUTPUT         | Output Assign         | Output Assign | MIX/EFX/OUTPUT1,2                                | 45        |
|                | Output Level          |               | 0 — 127  | 45        |
|                | Chorus Send Level     | Chorus        | 0 — 127  | 45        |
|                | Reverb Send Level     | Reverb        | 0 — 127  | 45        |
| PATCH EFX TYPE | EFX Type              | Type          | *1   | 45        |
| PATCH EFX PRM  | EFX Parameter         | *1            |  | 45        |
| PATCH EFX OUT  | Output Assign         | Output Assign | MIX/OUTPUT1,2                                    | 45        |
|                | Output Level          |               | 0 — 127  | 45        |
|                | Chorus Send Level     | Chorus        | 0 — 127  | 46        |
|                | Reverb Send Level     | Reverb        | 0 — 127  | 46        |
| PATCH EFX CTRL | EFX Control Source1,2 | ---           | *2   | 46        |
|                | EFX Control Depth1,2  | ---           | -63 — +63  | 46        |
| PATCH CHORUS   | Chorus Rate           | Rat           | 0 — 127  | 46        |
|                | Chorus Depth          | Dpt           | 0 — 127  | 46        |
|                | Pre Delay             | Dly           | 0 — 127  | 46        |
|                | Chorus Feedback       | Fbk           | 0 — 127  | 46        |
|                | Chorus Level          | Level         | 0 — 127  | 46        |
|                | Chorus Output Assign  | Output        | MIX/REVERB/MIX+REV                               | 46        |
| PATCH REVERB   | Reverb Type           | Type          | ROOM1,2/STAGE1,2/<br>HALL1,2/DELAY/<br>PAN-DELAY | 46        |
|                | Reverb Time           | Time          | 0 — 127  | 47        |
|                | Reverb Level          | Lev           | 0 — 127  | 47        |
|                | Delay Feedback        | Fbk           | 0 — 127  | 47        |
|                | High Frequency Damp   | HF damp       | *3   | 47        |

\*1 : Refer to "EFX Parameters"

\*2 : OFF/SYS-CTRL1/SYS-CTRL2/MODULATION/BREATH/FOOT/VOLUME/PAN/EXPRESSION/BENDER/AFTERTOUC

\*3 : 200/250/315/400/500/630/800/1000/1250/1600/2000/2500/3150/4000/5000/6300/8000/BYPASS



## LFO

| Page         | Parameter              | Display | Value                               | Reference |
|--------------|------------------------|---------|-------------------------------------|-----------|
| LFO1         | LFO Waveform           | Form    | TRI/SIN/SAW/SQR/TRP/<br>S&H/RND/CHS | 51        |
|              | Key Triger             | KeyTrig | OFF/ON                              | 51        |
|              | LFO Rate               | Rate    | 0 — 127 / 0 — 880 (*1)              | 51        |
|              | LFO External Sync      | ExtSync | OFF/CLOCK/TAP                       | 51        |
|              | Fade Mode              | Mode    | ON-IN/ON-OUT/OFF-IN/<br>OFF-OUT     | 52        |
|              | Delay Time             | Delay   | 0 — 127                             | 52        |
|              | Fade Time              | Fade    | 0 — 127                             | 52        |
|              | Level Offset           | Offset  | -100/-50/0/+50/+100                 | 52        |
| LFO2         | *Refer to "LFO1"       |         |                                     |           |
| LFO DEPTH1,2 | Pitch LFO Depth1,2     | Pitch   | -63 — +63                           | 52        |
|              | Filter LFO Depth1,2    | TVF     | -63 — +63                           | 52        |
|              | Amplitude LFO Depth1,2 | TVA     | -63 — +63                           | 52        |
|              | Pan LFO Depth1,2       | PAN     | -63 — +63                           | 52        |

\*1 : 1/2/3/4/5/6/7/8/9/10/20/30/40/50/60/70/80/90/100/200/300/400/500/600/700/800/900/1000/1100/1200

## PITCH

| Page         | Parameter                           | Display        | Value          | Reference |
|--------------|-------------------------------------|----------------|----------------|-----------|
| PITCH        | Coarse Tune                         | Coarse         | -48 — +48      | 52        |
|              | Fine Tune                           | Fine           | -50 — +50      | 53        |
|              | Random Pitch Depth                  | Random         | 0 — 1200 *1    | 53        |
|              | Pitch Keyfollow                     | KeyFlw         | -100 — +200 *2 | 53        |
| PCH ENV DPT  | Pitch Envelope Depth                | Envelope Depth | -12 — +12      | 53        |
|              | Pitch Envelope Velocity Sensitivity | Velocity Sens  | -100 — +150    | 53        |
| PCH TIME ENV | Velocity Time1 Sensitivity          | V-T1           | -100 — +100 *3 | 53        |
|              | Velocity Time4 Sensitivity          | V-T4           | -100 — +100 *3 | 53        |
|              | Time Keyfollow                      | Time Keyfollow | -100 — +100 *3 | 53        |
| PCH ENVELOPE | Pitch Envelope Time1,2,3,4          | T1,T2,T3,T4    | 0 — 127        | 53        |
|              | Pitch Envelope Level1,2,3,4         | L1,L2,L3,L4    | -63 — +63      | 53        |

\*1 : 0/1/2/3/4/5/6/7/8/9/10/20/30/40/50/60/70/80/90/100/200/300/400/500/600/700/800/900/1000/1100/1200

\*2 : -100/-70/-50/-30/-10/0/+10/+20/+30/+40/+50/+70/+100/+120/+150/+200

\*3 : -100/-70/-50/-40/-30/-20/-10/0/+10/+20/+30/+40/+50/+70/+100

## TVF

| Page         | Parameter                         | Display        | Value               | Reference |
|--------------|-----------------------------------|----------------|---------------------|-----------|
| FILTER       | Filter Type                       | Typ            | OFF/LPF/BPF/HPF/PKG | 54        |
|              | Cutoff Frequency                  | Cut            | 0 — 127             | 54        |
|              | Resonance                         | Res            | 0 — 127             | 54        |
|              | Cutoff Keyfollow                  | KeyFlw         | -100 — +200 *1      | 54        |
|              | TVF Envelope Depth                | Env Dpt        | -63 — +63           | 54        |
| TVF VELOCITY | TVF Envelope Velocity Sensitivity | V-Sens         | -100 — +150         | 54        |
|              | TVF Envelope Velocity Curve       | V-Curve        | 1 — 7               | 55        |
|              | Resonance Velocity Sensitivity    | V-Resonance    | -100 — +150         | 55        |
| TVF TIME ENV | Velocity Time1 Sensitivity        | V-T1           | -100 — +100 *2      | 55        |
|              | Velocity Time4 Sensitivity        | V-T4           | -100 — +100 *2      | 55        |
|              | Time Keyfollow                    | Time Keyfollow | -100 — +100 *2      | 55        |
| TVF ENVELOPE | TVF Envelope Time1,2,3,4          | T1,T2,T3,T4    | 0 — 127             | 55        |
|              | TVF Envelope Level1,2,3,4         | L1,L2,L3,L4    | 0 — 127             | 55        |

\*1 : -100/-70/-50/-30/-10/0/+10/+20/+30/+40/+50/+70/+100/+120/+150/+200

\*2 : -100/-70/-50/-40/-30/-20/-10/0/+10/+20/+30/+40/+50/+70/+100

## TVA

| Page         | Parameter                         | Display        | Value                           | Reference |
|--------------|-----------------------------------|----------------|---------------------------------|-----------|
| TVA          | Tone Level                        | Level          | 0 — 127                         | 55        |
|              | Tone Pan                          | Pan            | L64 — 0 — 63R                   | 55        |
|              | TVA Envelope Velocity Sensitivity | V-Sens         | -100 — +150                     | 55        |
|              | TVA Envelope Velocity Curve       | V-Curve        | 1 — 7                           | 55        |
| BIAS         | Bias Level                        | Bias           | -100 — +100 *1                  | 55        |
|              | Bias Point                        | Point          | C-1 — G9                        | 55        |
|              | Bias Direction                    | Direction      | LOWER/UPPER/<br>LOWER&UPPER/ALL | 55        |
| PAN MODULATE | Pan Keyfollow                     | KeyFlw         | -100 — +100 *1                  | 56        |
|              | Random Pan Depth                  | Random         | 0 — 63                          | 56        |
|              | Alternate Pan Depth               | Alternate      | L63 — 0 — 63R                   | 56        |
| TVA TIME ENV | Velocity Time1 Sensitivity        | V-T1           | -100 — +100 *1                  | 56        |
|              | Velocity Time4 Sensitivity        | V-T4           | -100 — +100 *1                  | 56        |
|              | Time Keyfollow                    | Time Keyfollow | -100 — +100 *1                  | 56        |
| TVA ENVELOPE | TVA Envelope Time1,2,3,4          | T1,T2,T3,T4    | 0 — 127                         | 56        |
|              | TVA Envelope Level1,2,3           | L1,L2,L3       | 0 — 127                         | 56        |

\*1 : -100/-70/-50/-40/-30/-20/-10/0/+10/+20/+30/+40/+50/+70/+100

## Performance Parameters

### COMMON

| Page             | Parameter        | Display       | Value                 | Reference |
|------------------|------------------|---------------|-----------------------|-----------|
| PERFORM NAME     | Performance Name | ----          | (12 CHARACTER ASCII ) | 57        |
| PERFORM TEMPO    | Default Tempo    | Default Tempo | 20 — 250              | 57        |
| PERFORM KEY MODE | Key Range Switch | Key Range     | OFF/ON                | 57        |
| KEY RANG         | Key Range Lower  | Key Lower     | C-1 — G9              | 57        |
|                  | Key Range Upper  | Key Upper     | C-1 — G9              | 57        |
| RESERVE          | Voice Reserve    | Voice Reserve | 0 — 64                | 57        |

### EFFECTS

| Page             | Parameter             | Display       | Value  | Reference |
|------------------|-----------------------|---------------|--|-----------|
| OUTPUT           | Output Assign         | Output Assign | MIX/EFX/OUTPUT1,2/<br>PATCH                      | 57        |
|                  | Output Level          |               | 0 — 127  | 57        |
|                  | Chorus Send Level     | Chorus        | 0 — 127  | 58        |
|                  | Reverb Send Level     | Reverb        | 0 — 127  | 58        |
| PERFORM EFX TYPE | EFX Type              | Type          | *1   | 58        |
|                  | EFX Source            | Source        | PERFORM/1 — 9,11 — 16                            | 58        |
| PERFORM EFX PRM  | EFX Parameter         | *1            |  | 58        |
| PERFORM EFX OUT  | Output Assign         | Output Assign | MIX/OUTPUT1,2                                    | 58        |
|                  | Output Level          |               | 0 — 127  | 58        |
|                  | Chorus Send Level     | Chorus        | 0 — 127  | 58        |
|                  | Reverb Send Level     | Reverb        | 0 — 127  | 58        |
| PERFORM EFX CTRL | EFX Control Source1,2 | ----          | *1   | 58        |
|                  | EFX Control Depth1,2  | ----          | -63 — +63  | 58        |
| PERFORM CHORUS   | Chorus Rate           | Rat           | 0 — 127  | 59        |
|                  | Chorus Depth          | Dpt           | 0 — 127  | 59        |
|                  | Pre Delay             | Dly           | 0 — 127  | 59        |
|                  | Chorus Feedback       | Fbk           | 0 — 127  | 59        |
|                  | Chorus Level          | Level         | 0 — 127  | 59        |
|                  | Chorus Output Assign  | Output        | MIX/REVERB/MIX+REV                               | 59        |
| PERFORM REVERB   | Reverb Type           | Type          | ROOM1,2/STAGE1,2/<br>HALL1,2/DELAY/<br>PAN-DELAY | 59        |
|                  | Reverb Time           | Time          | 0 — 127  | 59        |
|                  | Reverb Level          | Lev           | 0 — 127  | 59        |
|                  | Delay Feedback        | Fbk           | 0 — 127  | 59        |
|                  | High Frequency Damp   | HF damp       | *3   | 59        |

\*1 : Refer to "EFX Parameters"

\*2 : OFF/SYS-CTRL1/SYS-CTRL2/MODULATION/BREATH/FOOT/VOLUME/PAN/EXPRESSION/BENDER/AFTERTOUCH

\*3 : 200/250/315/400/500/630/800/1000/1250/1600/2000/2500/3150/4000/5000/6300/8000/BYPASS

## MIDI

| Page    | Parameter              | Display        | Value  | Reference |
|---------|------------------------|----------------|--------|-----------|
| CONTROL | MIDI Channel           | Channel        | 1 — 16 | 59        |
|         | MIDI Receive Switch    | Rx             | OFF/ON | 59        |
| RX MIDI | Receive Volume         | Volume         | OFF/ON | 60        |
|         | Receive Hold-1         | Hold-1         | OFF/ON | 60        |
|         | Receive Program Change | Program Change | OFF/ON | 60        |

## PART

| Page  | Parameter    | Display | Value                                    | Reference |
|-------|--------------|---------|--|-----------|
| PATCH | Patch Group  | Group   | USER/CARD/PCM/<br>PR-A,B,C/GM/XP-A,B,C,D | 60        |
|       | Patch Number | Number  | 001 — 255                                | 60        |

## PITCH

| Page  | Parameter         | Display      | Value     | Reference |
|-------|-------------------|--------------|-----------|-----------|
| PITCH | Pitch Coarse Tune | Pitch Coarse | -48 — +48 | 60        |
|       | Pitch Fine Tune   | Pitch Fine   | -50 — +50 | 60        |

## PAN

| Page | Parameter | Display  | Value         | Reference |
|------|-----------|----------|---------------|-----------|
| PAN  | Part Pan  | Part Pan | L64 — 0 — 63R | 60        |

## LEVEL

| Page  | Parameter  | Display | Value   | Reference |
|-------|------------|---------|---------|-----------|
| LEVEL | Part Level | Level   | 0 — 127 | 60        |

## Rhythm Set Parameters

### COMMON

| Page        | Parameter       | Display | Value                | Reference |
|-------------|-----------------|---------|----------------------|-----------|
| RHYTHM NAME | Rhythm Set Name | ---     | (12 Character ASCII) | 61        |

### EFFECTS

| Page             | Parameter             | Display       | Value  | Reference |
|------------------|-----------------------|---------------|--|-----------|
| OUTPUT           | Output Assign         | Output Assign | MIX/EFX/OUTPUT1,2                                | 61        |
|                  | Output Level          |               | 0 — 127  | 61        |
|                  | Chorus Send Level     | Chorus        | 0 — 127  | 61        |
|                  | Reverb Send Level     | Reverb        | 0 — 127  | 61        |
| PERFORM EFX TYPE | EFX Type              | Type          | *1   | 61        |
|                  | EFX Source            | Source        | PERFORM/1 — 9,11 — 16                            | 61        |
| PERFORM EFX PRM  | EFX Parameter         |               | *1   | 61        |
| PERFORM EFX OUT  | Output Assign         | Output Assign | MIX/OUTPUT1,2                                    | 61        |
|                  | Output Level          |               | 0 — 127  | 61        |
|                  | Chorus Send Level     | Chorus        | 0 — 127  | 62        |
|                  | Reverb Send Level     | Reverb        | 0 — 127  | 62        |
| PERFORM EFX CTRL | EFX Control Source1,2 | ---           | *2   | 62        |
|                  | EFX Control Depth1,2  | ---           | -63 — +63  | 62        |
| PERFORM CHORUS   | Chorus Rate           | Rat           | 0 — 127  | 62        |
|                  | Chorus Depth          | Dpt           | 0 — 127  | 62        |
|                  | Pre Delay             | Dly           | 0 — 127  | 62        |
|                  | Chorus Feedback       | Fbk           | 0 — 127  | 62        |
|                  | Chorus Level          | Level         | 0 — 127  | 62        |
|                  | Chorus Output Assign  | Output        | MIX/REVERB/MIX+REV                               | 62        |
| PERFORM REVERB   | Reverb Type           | Type          | ROOM1,2/STAGE1,2/<br>HALL1,2/DELAY/<br>PAN-DELAY | 62        |
|                  | Reverb Time           | Time          | 0 — 127  | 62        |
|                  | Reverb Level          | Lev           | 0 — 127  | 63        |
|                  | Delay Feedback        | Fbk           | 0 — 127  | 63        |
|                  | High Frequency Damp   | HF damp       | *3   | 63        |

\*1 : Refer to "EFX Parameters"

\*2 : OFF/SYS-CTRL1/SYS-CTRL2/MODULATION/BREATH/FOOT/VOLUME/PAN/EXPRESSION/BENDER/AFTERTOUCH

\*3 : 200/250/315/400/500/630/800/1000/1250/1600/2000/2500/3150/4000/5000/6300/8000/BYPASS

## CONTROL

| Page     | Parameter             | Display    | Value           | Reference |
|----------|-----------------------|------------|-----------------|-----------|
| CONTROL  | Bender Range          | Bender     | 0 — 12          | 63        |
|          | Envelope Mode         | EnvMode    | NO-SUS/SUSTAIN  | 63        |
|          | Mute Group            | Mute Group | OFF/1 — 31      | 63        |
| RxSWITCH | Volume Control Switch | Volume     | OFF/ON          | 63        |
|          | Pan Control Switch    | Pan        | OFF/CONT/KEY-ON | 63        |
|          | Hold-1 Control Switch | Hold-1     | OFF/ON          | 63        |

## WAVE

| Page | Parameter   | Display | Value                        | Reference |
|------|-------------|---------|------------------------------|-----------|
| WAVE | Wave Group  | Group   | INT-A,B/CARD/<br>EXP-A,B,C,D | 63        |
|      | Wave Number | Number  | 1 — 255                      | 64        |
|      | Wave Gain   | Gain    | -6/0/+6/+12                  | 64        |
|      | Tone Switch | Switch  | OFF/ON                       | 64        |

## PITCH

| Page         | Parameter                           | Display       | Value          | Reference |
|--------------|-------------------------------------|---------------|----------------|-----------|
| PITCH        | Source Key                          | Coarse        | C-1 — G9       | 64        |
|              | Fine Tune                           | Fine          | -50 — +50      | 64        |
|              | Random Pitch Depth                  | Random        | 0 — 1200 *1    | 64        |
|              | Pitch Envelope Depth                | Env Dpt       | -12 — +12      | 64        |
| PCH VELOCITY | Pitch Envelope Velocity Sensitivity | Velocity Sens | -100 — +150    | 64        |
|              | Velocity Time Sensitivity           | Velocity Time | -100 — +100 *2 | 64        |
| PCH ENVELOPE | Pitch Envelope Time1,2,3,4          | T1,T2,T3,T4   | 0 — 127        | 64        |
|              | Pitch Envelope Level1,2,3,4         | L1,L2,L3,L4   | -63 — +63      | 64        |

\*1 : 0/1/2/3/4/5/6/7/8/9/10/20/30/40/50/60/70/80/90/100/200/300/400/500/600/700/800/900/1000/1100/1200

\*2 : -100/-70/-50/-40/-30/-20/-10/0/+10/+20/+30/+40/+50/+70/+100

## TVF

| Page         | Parameter                         | Display     | Value               | Reference |
|--------------|-----------------------------------|-------------|---------------------|-----------|
| FILTER       | Filter Type                       | Type        | OFF/LPF/BPF/HPF/PKG | 64        |
|              | Cutoff Frequency                  | Cutoff      | 0 — 127             | 64        |
|              | Resonance                         | Res         | 0 — 127             | 65        |
|              | TVF Envelope Depth                | Env Dpt     | -63 — +63           | 65        |
| TVF VELOCITY | TVF Envelope Velocity Sensitivity | V-Sens      | -100 — +150         | 65        |
|              | Velocity Time Sensitivity         | V-Time      | -100 — +100 *1      | 65        |
|              | Resonance Velocity Sensitivity    | V-Resonance | -100 — +150         | 65        |
| TVF ENVELOPE | TVF Envelope Time1,2,3,4          | T1,T2,T3,T4 | 0 — 127             | 65        |
|              | TVF Envelope Level1,2,3,4         | L1,L2,L3,L4 | 0 — 127             | 65        |

## TVA

| Page         | Parameter                         | Display       | Value          | Reference |
|--------------|-----------------------------------|---------------|----------------|-----------|
| TVA          | Tone Level                        | Level         | 0 — 127        | 65        |
|              | Tone Pan                          | Pan           | L64 — 0 — 63R  | 65        |
|              | Random Pan Depth                  | Random        | 0 — 63         | 65        |
|              | Alternate Pan Depth               | Alt           | L63 — 0 — 63R  | 65        |
| TVA VELOCITY | TVA Envelope Velocity Sensitivity | Velocity Sens | -100 — +150    | 65        |
|              | Velocity Time Sensitivity         | Velocity Time | -100 — +100 *1 | 65        |
| TVA ENVELOPE | TVA Envelope Time1,2,3,4          | T1,T2,T3,T4   | 0 — 127        | 65        |
|              | TVA Envelope Level1,2,3           | L1,L2,L3      | 0 — 127        | 65        |

\*1 : -100/-70/-50/-40/-30/-20/-10/0/+10/+20/+30/+40/+50/+70/+100

## General MIDI Mode Parameters

### EFFECTS

| Page        | Parameter            | Display       | Value  | Reference |
|-------------|----------------------|---------------|--|-----------|
| OUTPUT      | Output Assign        | Output Assign | MIX/EFX/OUTPUT1,2/<br>PATCH                      | 77        |
|             | Output Level         |               | 0 — 127  | 77        |
|             | Chorus Send Level    | Chorus        | 0 — 127  | 77        |
|             | Reverb Send Level    | Reverb        | 0 — 127  | 77        |
| GM EFX TYPE | EFX Type             | Type          | *1   | 77        |
| GM EFX PRM  | EFX Parameter        | *1            |  | 77        |
| GM EFX OUT  | Output Assign        | Output Assign | MIX/OUTPUT1,2                                    | 77        |
|             | Output Level         |               | 0 — 127  | 77        |
|             | Chorus Send Level    | Chorus        | 0 — 127  | 77        |
|             | Reverb Send Level    | Reverb        | 0 — 127  | 77        |
| GM CHORUS   | Chorus Rate          | Rat           | 0 — 127  | 77        |
|             | Chorus Depth         | Dpt           | 0 — 127  | 77        |
|             | Pre Delay            | Dly           | 0 — 127  | 77        |
|             | Chorus Feedback      | Fbk           | 0 — 127  | 77        |
|             | Chorus Level         | Level         | 0 — 127  | 77        |
|             | Chorus Output Assign | Output        | MIX/REVERB/MIX+REV                               | 77        |
| GM REVERB   | Reverb Type          | Type          | ROOM1,2/STAGE1,2/<br>HALL1,2/DELAY/<br>PAN-DELAY | 78        |
|             | Reverb Time          | Time          | 0 — 127  | 78        |
|             | Reverb Level         | Lev           | 0 — 127  | 78        |
|             | Delay Feedback       | Fbk           | 0 — 127  | 78        |
|             | High Frequency Damp  | HF damp       | *3   | 78        |

\*1: Refer to "EFX Parameters"

\*2: OFF/SYS-CTRL1/SYS-CTRL2/MODULATION/BREATH/FOOT/VOLUME/PAN/EXPRESSION/BENDER/AFTERTOUCH

\*3: 200/250/315/400/500/630/800/1000/1250/1600/2000/2500/3150/4000/5000/6300/8000/BYPASS

### PART

| Page  | Parameter    | Display | Value     | Reference |
|-------|--------------|---------|-----------|-----------|
| PATCH | Patch Number | Number  | 001 — 128 | 78        |

### PITCH

| Page  | Parameter         | Display      | Value     | Reference |
|-------|-------------------|--------------|-----------|-----------|
| PITCH | Pitch Coarse Tune | Pitch Coarse | -48 — +48 | 78        |
|       | Pitch Fine Tune   | Pitch Fine   | -50 — +50 | 78        |

### PAN

| Page | Parameter | Display  | Value         | Reference |
|------|-----------|----------|---------------|-----------|
| PAN  | Part Pan  | Part Pan | L64 — 0 — 63R | 78        |

### LEVEL

| Page  | Parameter  | Display | Value   | Reference |
|-------|------------|---------|---------|-----------|
| LEVEL | Part Level | Level   | 0 — 127 | 78        |

## System Parameters

### SETUP

| Page            | Parameter           | Display      | Value            | Reference |
|-----------------|---------------------|--------------|------------------|-----------|
| LCD             | LCD Contrast        | LCD          | 1 — 10           | 66        |
| DEFAULT SETUP   | Power Up Mode       | PowerUp      | DEFAULT/LAST     | 66        |
|                 | Patch Remain Switch | Patch Remain | OFF/ON           | 66        |
| RHYTHM EDIT KEY | Rhythm Edit Source  | Source       | PANEL/PANEL&MIDI | 66        |

## MIDI

| Page            | Parameter                | Display         | Value                             | Reference |
|-----------------|--------------------------|-----------------|-----------------------------------|-----------|
| PERFORM MIDI    | Control Channnel         | Control Channel | 1 — 16/OFF                        | 66        |
|                 | Clock Source             | Clock           | INT/MIDI                          | 66        |
|                 | Stack                    | Stack           | OFF/1 of 2 — 8 of 8               | 66        |
| PATCH MIDI      | Patch Receive Channnel   | Receive Channel | OFF/ON                            | 67        |
|                 | Clock Source             | Clock           | INT/MIDI                          | 67        |
|                 | Stack                    | Stack           | OFF/1 of 2 — 8 of 8               | 67        |
| GM MODE MIDI    | Clock Source             | Clock           | MIDI                              | 67        |
|                 | Stack                    | Stack           | OFF/1 of 2 — 8 of 8               | 67        |
| SYS-EXC MIDI    | Unit Number              | Unit#           | 17 — 32                           | 67        |
|                 | Receive System Exclusive | Rx.Exc          | OFF/ON                            | 67        |
|                 | Transmit Edit Data       | Tx.Edit         | OFF/ON                            | 67        |
|                 | Receive GM Message       | Rx.GM           | OFF/ON                            | 67        |
| CONTROL SOURCE  | Tap Control Source       | Tap             | OFF/HOLD-1/SOST/<br>SOFT/HOLD-2   | 67        |
|                 | Hold Control Source      | Hold            | *Same as above                    | 67        |
|                 | Peak Control Source      | Peak            | *Same as above                    | 67        |
| RECEIVE MIDI    | Receive Program Change   | P.C             | OFF/ON                            | 68        |
|                 | Receive Bank Select      | Brk             | OFF/ON                            | 68        |
|                 | Receive Control Change   | C.C             | OFF/ON                            | 68        |
|                 | Receive Volume           | Vol             | OFF/ON                            | 68        |
|                 | Receive Hold-1           | Hld             | OFF/ON                            | 68        |
|                 | Receive Bender           | Bnd             | OFF/ON                            | 68        |
|                 | Receive Modulation       | Mod             | OFF/ON                            | 68        |
|                 | Receive Aftertouch       | Aft             | OFF/ON                            | 68        |
| CONTROL ASSIGN1 | System Control Source 1  | Control 1       | CC00 — CC95/BENDER/<br>AFTERTOUCH | 68        |
|                 | System Control Source 2  | Control 2       | *Same as above                    | 68        |
| CONTROL ASSIGN2 | Volume Control Source    | Volume          | VOLUME/VOL&EXP                    | 68        |
|                 | Aftertouch Source        | Aftertouch      | CH-AFTER/POLY-AFTER<br>/CH&POLY   | 68        |

## TUNE

| Page        | Parameter         | Display     | Value         | Reference |
|-------------|-------------------|-------------|---------------|-----------|
| TUNE        | Master Tune       | Master Tune | 427.4 — 452.6 | 68        |
| SCALE TUNE  | Scale Tune Switch | Scale Tune  | OFF/ON        | 68        |
| PART SCALE  | Scale Tune C — B  | C — B       | -64 — +63     | 69        |
| PATCH SCALE | Scale Tune C — B  | C — B       | -64 — +63     | 69        |

## PREVIEW

| Page             | Parameter                 | Display   | Value        | Reference |
|------------------|---------------------------|-----------|--------------|-----------|
| PREVIEW MODE     | Preview Sound Mode        | Mode      | SINGLE/CHORD | 69        |
| PREVIEW KEY      | Preview Key Set 1—4       | Note1 — 4 | C-1 — G9     | 69        |
| PREVIEW VELOCITY | Preview Velocity Set1 — 4 | Note1 — 4 | 0 — 127      | 69        |

## Utility Parameters

### WRITE

| Page          | Parameter                | Display | Value                           | Reference |
|---------------|--------------------------|---------|---------------------------------|-----------|
| PERFORM WRITE | Performance Write Number | Number  | USR:01 — 32/CRD:01 — 32         | 70        |
| PATCH WRITE   | Patch Write Number       | Number  | USR:001 — 128/<br>CRD:001 — 128 | 70        |
| PATCH COMPARE | Patch Compare Number     | Number  | *Same as above                  | 70        |
| RHYTHM WRITE  | Rhythm Write Number      | Number  | USR:1 — 2/CRD:1 — 2             | 71        |



**COPY**

| Page                 | Parameter   | Display | Value   | Reference |
|----------------------|-------------|---------|---|-----------|
| PERFORM<br>PART COPY | Copy Source | Source  | TEMP/USR:01 — 32/<br>CRD:01 — 32/<br>PRA:01 — PRB:32                        | 71        |
|                      | Copy Part   | Part    | P1 — P16  | 71        |
| PERFORM<br>FX COPY   | Copy Source | Source  | PERFORM/PATCH   | 71        |
|                      | Copy Number | Number  | *1  | 71        |
| PATCH<br>TONE COPY   | Copy Source | Source  | TEMP/USR:001 — 128/<br>CRD:001 — 128/<br>PRA:001 — PRC:128/<br>GM:001 — 128 | 71        |
|                      | Copy tone   | Tone    | T1 — T4   | 71        |
| PATCH<br>FX COPY     | Copy Source | Source  | PERFORM/PATCH   | 71        |
|                      | Copy Number | Number  | *1  | 71        |
| RHYTHM<br>KEY COPY   | Copy Source | Source  | TEMP/USR:1 — 2/CRD:1 — 2<br>/PRA:1 — PRC:2/GM:1 — 2                         | 72        |
|                      | Copy Key    | Key     | B1 — D7   | 72        |

\*1: USR:01-32/CRD:01-32/PRA:01-PRB:32/USR:001-128/CRD:001-128/PRA:001-PRD:128

**INITIALIZE**

| Page            | Parameter       | Display | Value          | Reference |
|-----------------|-----------------|---------|----------------|-----------|
| PERFORM INIT    | Initialize Mode | Mode    | DEFAULT/PRESET | 72        |
| PATCH INIT      | Initialize Mode | Mode    | DEFAULT/PRESET | 72        |
| RHYTHM KEY INIT | Initialize Mode | Mode    | DEFAULT/PRESET | 72        |
|                 | Initialize Key  | Key     | B1 — D7        | 72        |
| RHYTHM SET INIT | Initialize Mode | Mode    | DEFAULT/PRESET | 72        |

**PROTECT**

| Page          | Parameter         | Display   | Value  | Reference |
|---------------|-------------------|-----------|--------|-----------|
| WRITE PROTECT | Internal Protect  | Internal  | OFF/ON | 72        |
|               | Exclusive Protect | Exclusive | OFF/ON | 72        |

**CARD**

| Page      | Parameter   | Display | Value                        | Reference |
|-----------|-------------|---------|------------------------------|-----------|
| FORMAT    | Card Name   | Name    | (12 Character ASC     )      | 73        |
| RENAME    | Card Name   | Name    | (12 Character ASC     )      | 73        |
| CARD COPY | Copy Source | Source  | ALL/PERFORM/PATCH/<br>RHYTHM | 73        |
|           | Copy Group  | Group   | *1                           | 73        |
|           | Copy Mode   | Mode    | ADAPT/DIRECT                 | 73        |
| CARD SWAP | Swap Source | Source  | ALL/PERFORM/PATCH/<br>RHYTHM | 73        |
|           | Swap Group  | Group   | *2                           | 73        |
|           | Swap Mode   | Mode    | ADAPT/DIRECT                 | 73        |

\*1: USR-HALF1->CARD/USR-HALF2->CARD/CARD->USR-HALF1/CARD->USR-HALF2

\*2: USR-HALF1<->CARD/USR-HALF2<->CARD

**BLOCK COPY**

| Page       | Parameter  | Display | Value                | Reference |
|------------|------------|---------|----------------------|-----------|
| BLOCK COPY | Copy Mode  | Mode    | PERFORM/PATCH/RHYTHM | 74        |
|            | Copy Block | Block   | *1                   | 74        |

\*1: (PERFORM) USR:01-01 — 32-32/CRD:01-01 — 32-32/PRA — B:01-01 — 32-32; CRD:01 — 32

(PATCH) USR:001-001 — 128-128/CRD:001-001 — 128-128/PRA — C:001-001 — 128-128/GM:001-001 — 128-128/XPA — D:001-001 — \*.\*; CRD:001 — 128  
(RHYTHM) USR:1-1 — 2-2/CRD:1-1 — 2-2,PRA — C:1-1 — 2-2/GM:1-1 — 2-2/XPA — D:1-1 — \*.\*; CRD:1 — 2

**BULK DUMP**

| Page      | Parameter        | Display | Value  | Reference |
|-----------|------------------|---------|--|-----------|
| BULK DUMP | Bulk Dump Source | Source  | TEMP/USER/CARD:<br>ALL/PERFORMANCE/<br>PATCH/RHYTHM/SYSTEM | 74        |

**FACTORY**

| Page           | Parameter      | Display | Value | Reference |
|----------------|----------------|---------|-------|-----------|
| FACTORY PRESET | Factory Preset | ----    | ----  | 74        |

## EFX Parameters

### 1: STEREO-EQ

| Page      | Parameter          | Display  | Value               | Reference |
|-----------|--------------------|----------|---------------------|-----------|
| EFX PARAM | Low Frequency      | Low Freq | 200/400 [Hz]        | 84        |
|           | Low Gain           | LowGain  | -15 — +15 [dB]      | 84        |
|           | High Frequency     | Hi Freq  | 4000/8000 [Hz]      | 84        |
|           | High Gain          | Hi Gain  | -15 — +15 [dB]      | 84        |
|           | Peaking1 Frequency | P1 Freq  | *1                  | 84        |
|           | Peaking1 Q         | P1 Q     | 0.5/1.0/2.0/4.0/9.0 | 84        |
|           | Peaking1 Gain      | P1 Gain  | -15 — +15 [dB]      | 84        |
|           | Peaking2 Frequency | P2 Freq  | *1                  | 84        |
|           | Peaking2 Q         | P2 Q     | 0.5/1.0/2.0/4.0/9.0 | 84        |
|           | Peaking2 Gain      | P2 Gain  | -15 — +15 [dB]      | 84        |
|           | Output Level       | Level    | 0 — 127             | 84        |

\*1: 200/250/315/400/500/630/800/1000/1250/1600/2000/2500/3150/4000/5000/6000/8000 [Hz]

### 2: OVERDRIVE

| Page      | Parameter    | Display | Value                            | Reference |
|-----------|--------------|---------|----------------------------------|-----------|
| EFX PARAM | Drive        | Drive   | 0 — 127                          | 84        |
|           | Output Level | Level   | 0 — 127                          | 84        |
|           | Low Gain     | LowGain | -15 — +15 [dB]                   | 84        |
|           | High Gain    | Hi Gain | -15 — +15 [dB]                   | 84        |
|           | Amp Type     | AmpType | SMALL/BUILT-IN/2STACK<br>/3STACK | 84        |
|           | Output Pan   | Pan     | L64 — 0 — 63R                    | 84        |

### 3: DISTORTION

| Page      | Parameter    | Display | Value                            | Reference |
|-----------|--------------|---------|----------------------------------|-----------|
| EFX PARAM | Drive        | Drive   | 0 — 127                          | 84        |
|           | Output Level | Level   | 0 — 127                          | 84        |
|           | Low Gain     | LowGain | -15 — +15 [dB]                   | 85        |
|           | High Gain    | Hi Gain | -15 — +15 [dB]                   | 85        |
|           | Amp Type     | AmpType | SMALL/BUILT-IN/2STACK<br>/3STACK | 85        |
|           | Output Pan   | Pan     | L64 — 0 — 63R                    | 85        |

### 4: PHASER

| Page      | Parameter    | Display | Value            | Reference |
|-----------|--------------|---------|------------------|-----------|
| EFX PARAM | Manual       | Manual  | 100 — 8000 [Hz]  | 85        |
|           | Phaser Rate  | Rate    | 0.05 — 10.0 [Hz] | 85        |
|           | Phaser Depth | Depth   | 0 — 127          | 85        |
|           | Resonance    | Res     | 0 — 127          | 85        |
|           | Mix Level    | Mix     | 0 — 127          | 85        |
|           | Output Pan   | Pan     | L64 — 0 — 63R    | 85        |
|           | Output Level | Level   | 0 — 127          | 85        |

### 5: SPECTRUM

| Page      | Parameter    | Display | Value          | Reference |
|-----------|--------------|---------|----------------|-----------|
| EFX PARAM | Band1 Level  | Band 1  | -15 — +15 [dB] | 85        |
|           | Band2 Level  | Band 2  | -15 — +15 [dB] | 85        |
|           | Band3 Level  | Band 3  | -15 — +15 [dB] | 85        |
|           | Band4 Level  | Band 4  | -15 — +15 [dB] | 85        |
|           | Band5 Level  | Band 5  | -15 — +15 [dB] | 85        |
|           | Band6 Level  | Band 6  | -15 — +15 [dB] | 85        |
|           | Band7 Level  | Band 7  | -15 — +15 [dB] | 85        |
|           | Band8 Level  | Band 8  | -15 — +15 [dB] | 85        |
|           | Band Width   | Width   | 1 — 5          | 85        |
|           | Output Pan   | Pan     | L64 — 0 — 63R  | 85        |
|           | Output Level | Level   | 0 — 127        | 85        |

## 6: ENHANCER

| Page      | Parameter    | Display  | Value          | Reference |
|-----------|--------------|----------|----------------|-----------|
| EFX PARAM | Sensitivity  | Sens     | 0 — 127        | 86        |
|           | Mix Level    | Mix      | 0 — 127        | 86        |
|           | Low Gain     | Low Gain | -15 — +15 [dB] | 86        |
|           | High Gain    | Hi Gain  | -15 — +15 [dB] | 86        |
|           | Output Level | Level    | 0 — 127        | 86        |

## 7: AUTO-WAH

| Page      | Parameter    | Display | Value            | Reference |
|-----------|--------------|---------|------------------|-----------|
| EFX PARAM | Filter Type  | Filter  | LPF/BPF          | 86        |
|           | Sensitivity  | Sens    | 0 — 127          | 86        |
|           | Manual       | Manual  | 0 — 127          | 86        |
|           | Peak         | Peak    | 0 — 127          | 86        |
|           | LFO Rate     | Rate    | 0.05 — 10.0 [Hz] | 86        |
|           | LFO Depth    | Depth   | 0 — 127          | 86        |
|           | Output Level | Level   | 0 — 127          | 86        |

## 8: ROTALY

| Page         | Parameter                   | Display    | Value            | Reference |
|--------------|-----------------------------|------------|------------------|-----------|
| EFX PARAM    | Low Frequency Slow Rate     | LowSlow    | 0.05 — 10.0 [Hz] | 86        |
|              | Low Frequency Fast Rate     | Low Fast   | 0.05 — 10.0 [Hz] | 86        |
|              | Low Frequency Acceleration  | LowAccl    | 0 — 15           | 86        |
|              | Low Frequency Level         | LowLvl     | 0 — 127          | 86        |
|              | High Frequency Slow Rate    | Hi Slow    | 0.05 — 10.0 [Hz] | 86        |
|              | High Frequency Fast Rate    | Hi Fast    | 0.05 — 10.0 [Hz] | 86        |
|              | High Frequency Acceleration | Hi Accl    | 0 — 15           | 86        |
|              | High Frequency Level        | Hi Lvl     | 0 — 127          | 86        |
|              | Separation                  | Separation | 0 — 127          | 86        |
|              | Speed                       | Speed      | SLOW/FAST        | 86        |
| Output Level | Level                       | 0 — 127    | 87               |           |

## 9: COMPRESSOR

| Page      | Parameter    | Display   | Value          | Reference |
|-----------|--------------|-----------|----------------|-----------|
| EFX PARAM | Attack Rate  | Attack    | 0 — 127        | 87        |
|           | Sustain Rate | Sustain   | 0 — 127        | 87        |
|           | Post Gain    | Post Gain | x1/x2/x4/x8    | 87        |
|           | Low Gain     | LowGain   | -15 — +15 [dB] | 87        |
|           | High Gain    | Hi Gain   | -15 — +15 [dB] | 87        |
|           | Output Pan   | Pan       | L64 — 0 — 63R  | 87        |
|           | Output Level | Level     | 0 — 127        | 87        |

## 10: LIMITER

| Page      | Parameter    | Display | Value               | Reference |
|-----------|--------------|---------|---------------------|-----------|
| EFX PARAM | Threshold    | Thresh  | 0 — 127             | 87        |
|           | Ratio        | Ratio   | 1.5:1/2:1/4:1/100:1 | 87        |
|           | Release Time | Release | 0 — 127             | 87        |
|           | Post Gain    | Gain    | x1/x2/x4/x8         | 87        |
|           | Low Gain     | LowGain | -15 — +15 [dB]      | 87        |
|           | High Gain    | Hi Gain | -15 — +15 [dB]      | 87        |
|           | Output Pan   | Pan     | L64 — 0 — 63R       | 87        |
|           | Output Level | Level   | 0 — 127             | 87        |

## 11: HEXA-CHORUS

| Page      | Parameter           | Display | Value             | Reference |
|-----------|---------------------|---------|-------------------|-----------|
| EFX PARAM | Pre Delay time      | Pre Dly | 0.0 — 100 [ms]    | 87        |
|           | Chorus Rate         | Rate    | 0.05 — 10.0 [Hz]  | 87        |
|           | Chorus Depth        | Depth   | 0 — 127           | 87        |
|           | Pre Delay Deviation | Dly Div | 0 — 20            | 87        |
|           | Depth Deviation     | Dpt Div | -20 — 20          | 87        |
|           | Pan Deviation       | Pan Div | 0 — 20            | 88        |
|           | Effect Balance      | Balance | D100:0E — D0:100E | 88        |
|           | Output Level        | Level   | 0 — 127           | 88        |

## 12: TREMOLO-CHORUS

| Page      | Parameter          | Display | Value             | Reference |
|-----------|--------------------|---------|-------------------|-----------|
| EFX PARAM | Pre Delay time     | Pre Dly | 0.0 — 100 [ms]    | 88        |
|           | Chorus Rate        | ChoRate | 0.05 — 10.0 [Hz]  | 88        |
|           | Chorus Depth       | Cho Dpt | 0 - 127           | 88        |
|           | Chorus Phase       | Phase   | 0 — 180           | 88        |
|           | Tremolo Rate       | TrmRate | 0.05 — 10.0 [Hz]  | 88        |
|           | Tremolo Separation | Trm Sep | 0 — 127           | 88        |
|           | Effect Balance     | Balance | D100:0E — D0:100E | 88        |
|           | Output Level       | Level   | 0 — 127           | 88        |

## 13: SPACE-D

| Page      | Parameter      | Display | Value             | Reference |
|-----------|----------------|---------|-------------------|-----------|
| EFX PARAM | Pre Delay time | Pre Dly | 0.0 — 100 [ms]    | 88        |
|           | Chorus Rate    | Rate    | 0.05 — 10.0 [Hz]  | 88        |
|           | Chorus Depth   | Depth   | 0 — 127           | 88        |
|           | Phase          | Phase   | 0 — 180           | 88        |
|           | Low Gain       | LowGain | -15 — +15 [dB]    | 88        |
|           | High Gain      | Hi Gain | -15 — +15 [dB]    | 88        |
|           | Effect Balance | Balance | D100:0E — D0:100E | 88        |
|           | Output Level   | Level   | 0 — 127           | 88        |

## 14: STEREO-CHORUS

| Page      | Parameter        | Display     | Value             | Reference |
|-----------|------------------|-------------|-------------------|-----------|
| EFX PARAM | Pre Delay time   | Pre Dly     | 0.0 — 100 [ms]    | 88        |
|           | Chorus Rate      | Rate        | 0.05 — 10.0 [Hz]  | 88        |
|           | Chorus Depth     | Depth       | 0 — 127           | 89        |
|           | Phase            | Phase       | 0 — 180           | 89        |
|           | Filter Type      | Filter Type | OFF/LPF/HPF       | 89        |
|           | Cutoff Frequency | Cutoff      | *1                | 89        |
|           | Low Gain         | LowGain     | -15 — +15 [dB]    | 89        |
|           | High Gain        | Hi Gain     | -15 — +15 [dB]    | 89        |
|           | Effect Balance   | Balance     | D100:0E — D0:100E | 89        |
|           | Output Level     | Level       | 0 — 127           | 89        |

\*1: 200/250/315/400/500/630/800/1000/1250/1600/2000/2500/3150/4000/5000/6300/8000 [Hz]

## 15: STEREO-FLANGER

| Page      | Parameter        | Display | Value             | Reference |
|-----------|------------------|---------|-------------------|-----------|
| EFX PARAM | Pre Delay time   | Pre Dly | 0.0 — 100 [ms]    | 89        |
|           | LFO Rate         | Rate    | 0.05 — 10.0 [Hz]  | 89        |
|           | LFO Depth        | Depth   | 0 — 127           | 89        |
|           | Feedback         | Fbk     | -98 — +98 [%]     | 89        |
|           | Phase            | Phase   | 0 — 180           | 89        |
|           | Filter Type      | Filter  | OFF/LPF/HPF       | 89        |
|           | Cutoff Frequency | Cutoff  | *1                | 89        |
|           | Low Gain         | LowGain | -15 — +15 [dB]    | 89        |
|           | High Gain        | Hi Gain | -15 — +15 [dB]    | 89        |
|           | Effect Balance   | Balance | D100:0E — D0:100E | 89        |
|           | Output Level     | Level   | 0 — 127           | 89        |

\*1: 200/250/315/400/500/630/800/1000/1250/1600/2000/2500/3150/4000/5000/6300/8000 [Hz]

### 16: STEP-FLANGER

| Page      | Parameter      | Display   | Value             | Reference |
|-----------|----------------|-----------|-------------------|-----------|
| EFX PARAM | Pre Delay time | Pre Delay | 0.0 — 100 [ms]    | 89        |
|           | LFO Rate       | Rate      | 0.05 — 10.0 [Hz]  | 89        |
|           | LFO Depth      | Depth     | 0 — 127           | 90        |
|           | Feedback       | Fbk       | -98 — +98 [%]     | 90        |
|           | Phase          | Phase     | 0 — 180           | 90        |
|           | Step Rate      | Step Rate | *1                | 90        |
|           | Low Gain       | LowGain   | -15 — +15 [dB]    | 90        |
|           | High Gain      | Hi Gain   | -15 — +15 [dB]    | 90        |
|           | Effect Balance | Balance   | D100:0E — D0:100E | 90        |
|           | Output Level   | Level     | 0 — 127           | 90        |

\*1: 0.05 — 10.0 [Hz] / ♪/♪/♫/♫/♫/♫/♫/♫/♫/♫/♫/♫/♫/♫/♫/♫

### 17: STEREO-DELAY

| Page      | Parameter           | Display | Value             | Reference |
|-----------|---------------------|---------|-------------------|-----------|
| EFX PARAM | Delay Time Left     | Delay L | 0.0 — 500 [ms]    | 90        |
|           | Delay Time Right    | Delay R | 0.0 — 500 [ms]    | 90        |
|           | Feedback            | Fbk     | -98 — +98 [%]     | 90        |
|           | Feedback Mode       | Mode    | NORMAL/CROSS      | 90        |
|           | Phase Left          | Phase L | NORMAL/INVERT     | 90        |
|           | Phase Right         | Phase R | NORMAL/INVERT     | 90        |
|           | High Frequency Damp | HF Damp | *1                | 90        |
|           | Low Gain            | LowGain | -15 — +15 [dB]    | 91        |
|           | High Gain           | Hi Gain | -15 — +15 [dB]    | 91        |
|           | Effect Balance      | Balance | D100:0E — D0:100E | 91        |
|           | Output Level        | Level   | 0 — 127           | 91        |

\*1 : 200/250/315/400/500/630/800/1000/1250/1600/2000/2500/3150/4000/5000/6300/8000/BYPASS [Hz]

### 18: MODULATION-DELAY

| Page      | Parameter           | Display | Value             | Reference |
|-----------|---------------------|---------|-------------------|-----------|
| EFX PARAM | Delay Time Left     | Delay L | 0.0 — 500 [ms]    | 91        |
|           | Delay Time Right    | Delay R | 0.0 — 500 [ms]    | 91        |
|           | Feedback            | Fbk     | -98 — +98 [%]     | 91        |
|           | Feedback Mode       | Mode    | NORMAL/CROSS      | 91        |
|           | Modulation Rate     | Rate    | 0.05 — 10.0 [Hz]  | 91        |
|           | Modulation Depth    | Depth   | 0 — 127           | 91        |
|           | Phase               | Phase   | 0 — 180           | 91        |
|           | High Frequency Damp | HF Damp | *1                | 91        |
|           | Low Gain            | LowGain | -15 — +15 [dB]    | 91        |
|           | High Gain           | Hi Gain | -15 — +15 [dB]    | 91        |
|           | Effect Balance      | Balance | D100:0E — D0:100E | 91        |
|           | Output Level        | Level   | 0 — 127           | 91        |

\*1 : 200/250/315/400/500/630/800/1000/1250/1600/2000/2500/3150/4000/5000/6300/8000/BYPASS [Hz]

### 19: TRIPLE-TAP-DELAY

| Page      | Parameter           | Display | Value             | Reference |
|-----------|---------------------|---------|-------------------|-----------|
| EFX PARAM | Delay Time Center   | Delay C | *1                | 91        |
|           | Delay Time Left     | Delay L | *1                | 92        |
|           | Delay Time Right    | Delay R | *1                | 92        |
|           | Feedback            | Fbk     | -98 — +98 [%]     | 92        |
|           | Center Level        | Level C | 0 — 127           | 92        |
|           | Left Level          | Level L | 0 — 127           | 92        |
|           | Right Level         | Level R | 0 — 127           | 92        |
|           | High Frequency Damp | HF Damp | *2                | 92        |
|           | Low Gain            | LowGain | -15 — +15 [dB]    | 92        |
|           | High Gain           | Hi Gain | -15 — +15 [dB]    | 92        |
|           | Effect Balance      | Balance | D100:0E — D0:100E | 92        |
|           | Output Level        | Level   | 0 — 127           | 92        |

\*1 : 200 — 1000 [ms] / ♪/♪/♫/♫/♫/♫/♫/♫/♫/♫/♫/♫/♫/♫/♫/♫

\*2 : 200/250/315/400/500/630/800/1000/1250/1600/2000/2500/3150/4000/5000/6300/8000/BYPASS [Hz]

## 20: QUADRUPLE-TAP-DELAY

| Page      | Parameter           | Display | Value             | Reference |
|-----------|---------------------|---------|-------------------|-----------|
| EFX PARAM | Delay Time 1        | Delay 1 | *1                | 92        |
|           | Delay Time 2        | Delay 2 | *1                | 92        |
|           | Delay Time 3        | Delay 3 | *1                | 92        |
|           | Delay Time 4        | Delay 4 | *1                | 92        |
|           | Level 1             | Level 1 | 0 — 127           | 92        |
|           | Level 2             | Level 2 | 0 — 127           | 92        |
|           | Level 3             | Level 3 | 0 — 127           | 92        |
|           | Level 4             | Level 4 | 0 — 127           | 92        |
|           | Feedback            | Fbk     | -98 — +98 [%]     | 92        |
|           | High Frequency Damp | HF Damp | *2                | 92        |
|           | Effect Balance      | Balance | D100:0E — D0:100E | 93        |
|           | Output Level        | Level   | 0 — 127           | 93        |

\*1 : 200 — 1000 [Hz]/♭/♮/♯/♯♯/♯♯♯/♯♯♯♯/♯♯♯♯♯

\*2 : 200/250/315/400/500/630/800/1000/1250/1600/2000/2500/3150/4000/5000/6300/8000/BYPASS [Hz]

## 21: TIME-CONTROL-DELAY

| Page      | Parameter           | Display | Value             | Reference |
|-----------|---------------------|---------|-------------------|-----------|
| EFX PARAM | Delay Time          | Delay   | 200 — 1000 [ms]   | 93        |
|           | Acceleration        | Accel   | 0 — 15            | 93        |
|           | Feedback            | Fbk     | -98 — +98 [%]     | 93        |
|           | Output Pan          | Pan     | L64 — 0 — 63R     | 93        |
|           | High Frequency Damp | HF Damp | *1                | 93        |
|           | Low Gain            | LowGain | -15 — +15 [dB]    | 93        |
|           | High Gain           | Hi Gain | -15 — +15 [dB]    | 93        |
|           | Effect Balance      | Balance | D100:0E — D0:100E | 93        |
|           | Output Level        | Level   | 0 — 127           | 93        |

\*1 : 200/250/315/400/500/630/800/1000/1250/1600/2000/2500/3150/4000/5000/6300/8000/BYPASS [Hz]

## 22: 2 VOICE-PITCH-SHIFTER

| Page      | Parameter        | Display | Value             | Reference |
|-----------|------------------|---------|-------------------|-----------|
| EFX PARAM | Coarse Pitch A   | CoarseA | -24 — 12          | 93        |
|           | Fine Pitch A     | Fine A  | -100 — 100        | 93        |
|           | Output Pan A     | Pan A   | L64 — 0 — 63R     | 93        |
|           | Pre Delay Time A | PreDlyA | 0.0 — 500 [ms]    | 93        |
|           | Coarse Pitch B   | CoarseB | -24 — 12          | 93        |
|           | Fine Pitch B     | Fine B  | -100 — 100        | 93        |
|           | Output Pan B     | Pan B   | L64 — 0 — 63R     | 93        |
|           | Pre Delay Time B | PreDlyB | 0.0 — 500 [ms]    | 94        |
|           | Pitch Shift Mode | Mode    | 1/2/3/4/5         | 94        |
|           | Level Balance    | Lvl Bal | A100:0B — A0:100B | 94        |
|           | Effect Balance   | Balance | D100:0E — D0:100E | 94        |
|           | Output Level     | Level   | 0 — 127           | 94        |

## 23: FBK-PITCH-SHIFTER

| Page      | Parameter        | Display  | Value             | Reference |
|-----------|------------------|----------|-------------------|-----------|
| EFX PARAM | Coarse Pitch     | Coarse   | -24 — 12          | 94        |
|           | Fine Pitch       | Fine     | -100 — 100        | 94        |
|           | Output Pan       | Pan      | L64 — 0 — 63R     | 94        |
|           | Pre Delay Time   | Pre Dly  | 0.0 — 500 [ms]    | 94        |
|           | Pitch Shift Mode | Mode     | 1/2/3/4/5         | 94        |
|           | Feedback         | Feedback | -98 — +98 [%]     | 94        |
|           | Low Gain         | LowGain  | -15 — +15 [dB]    | 94        |
|           | High Gain        | Hi Gain  | -15 — +15 [dB]    | 94        |
|           | Effect Balance   | Balance  | D100:0E — D0:100E | 94        |
|           | Output Level     | Level    | 0 — 127           | 94        |

**24: REVERB**

| Page      | Parameter           | Display | Value                        | Reference |
|-----------|---------------------|---------|------------------------------|-----------|
| EFX PARAM | Reverb Type         | Type    | ROOM1,2/STAGE1,2/<br>HALL1,2 | 94        |
|           | Pre Delay Time      | Pre Dly | 0.0 — 100 [ms]               | 94        |
|           | Reverb Time         | Time    | 0 — 127                      | 94        |
|           | High Frequency Damp | HF Damp | *1                           | 94        |
|           | Low Gain            | LowGain | -15 — +15 [dB]               | 94        |
|           | High Gain           | Hi Gain | -15 — +15 [dB]               | 95        |
|           | Effect Balance      | Balance | D100:0E — D0:100E            | 95        |
|           | Output Level        | Level   | 0 — 127                      | 95        |

\*1 : 200/250/315/400/500/630/800/1000/1250/1600/2000/2500/3150/4000/5000/6300/8000/BYPASS [Hz]

**25: GATE-REVERB**

| Page      | Parameter      | Display   | Value                       | Reference |
|-----------|----------------|-----------|-----------------------------|-----------|
| EFX PARAM | Reverb Type    | Type      | NORMAL/REVERSE/<br>SWEEP1,2 | 95        |
|           | Pre Delay Time | Pre Dly   | 0.0 — 100 [ms]              | 95        |
|           | Gate Time      | Gate Time | 5 — 500                     | 95        |
|           | Low Gain       | LowGain   | -15 — +15[dB]               | 95        |
|           | High Gain      | Hi Gain   | -15 — +15[dB]               | 95        |
|           | Effect Balance | Balance   | D100:0E — D0:100E           | 95        |
|           | Output Level   | Level     | 0 — 127                     | 95        |

**26: OVERDRIVE=CHORUS**

| Page      | Parameter        | Display | Value             | Reference |
|-----------|------------------|---------|-------------------|-----------|
| EFX PARAM | Drive            | Drive   | 0 — 127           | 95        |
|           | Overdrive Pan    | Pan     | L64 — 0 — 63R     | 95        |
|           | Chorus Pre Delay | Pre Dly | 0.0 — 100 [ms]    | 95        |
|           | Chorus Rate      | Rate    | 0.05 — 10.0 [Hz]  | 95        |
|           | Chorus Depth     | Depth   | 0 — 127           | 95        |
|           | Chorus Balance   | Balance | D100:0E — D0:100E | 95        |
|           | Output Level     | Level   | 0 — 127           | 95        |

**27: OVERDRIVE=FLANGER**

| Page      | Parameter         | Display | Value             | Reference |
|-----------|-------------------|---------|-------------------|-----------|
| EFX PARAM | Drive             | Drive   | 0 — 127           | 95        |
|           | Overdrive Pan     | Pan     | L64 — 0 — 63R     | 95        |
|           | Flanger Pre Delay | Pre Dly | 0.0 — 100 [ms]    | 95        |
|           | Flanger Rate      | Rate    | 0.05 — 10.0 [Hz]  | 96        |
|           | Flanger Depth     | Depth   | 0 — 127           | 96        |
|           | Flanger Feedback  | Fbk     | -98 — +98 [%]     | 96        |
|           | Flanger Balance   | Balance | D100:0E — D0:100E | 96        |
|           | Output Level      | Level   | 0 — 127           | 96        |

**28: OVERDRIVE=DELAY**

| Page      | Parameter      | Display | Value             | Reference |
|-----------|----------------|---------|-------------------|-----------|
| EFX PARAM | Drive          | Drive   | 0 — 127           | 96        |
|           | Overdrive Pan  | Pan     | L64 — 0 — 63R     | 96        |
|           | Delay Time     | Delay   | 0.0 — 500 [ms]    | 96        |
|           | Delay Feedback | Fbk     | -98 — +98 [%]     | 96        |
|           | Delay HF Damp  | HF Damp | *1                | 96        |
|           | Delay Balance  | Balance | D100:0E — D0:100E | 96        |
|           | Output Level   | Level   | 0 — 127           | 96        |

\*1 : 200/250/315/400/500/630/800/1000/1250/1600/2000/2500/3150/4000/5000/6300/8000/BYPASS [Hz]

### 29: DISTORTION→CHORUS

\*Refer to "OVERDRIVE→CHORUS"

### 30: DISTORTION→FLANGER

\*Refer to "OVERDRIVE→FLANGER"

### 31: DISTORTION→DELAY

\*Refer to "OVERDRIVE→DELAY"

### 32: ENHANSER→CHORUS

| Page      | Parameter        | Display | Value             | Reference |
|-----------|------------------|---------|-------------------|-----------|
| EFX PARAM | Sensitivity      | Sens    | 0 — 127           | 97        |
|           | Mix Level        | Mix     | 0 — 127           | 97        |
|           | Chorus Pre Delay | Pre Dly | 0.0 — 100 [ms]    | 97        |
|           | Chorus Rate      | Rate    | 0.05 — 10.0 [Hz]  | 97        |
|           | Chorus Depth     | Depth   | 0 — 127           | 97        |
|           | Chorus Balance   | Balance | D100:0E — D0:100E | 97        |
|           | Output Level     | Level   | 0 — 127           | 97        |

### 33: ENHANSER→FLANGER

| Page      | Parameter         | Display | Value             | Reference |
|-----------|-------------------|---------|-------------------|-----------|
| EFX PARAM | Sensitivity       | Sens    | 0 — 127           | 97        |
|           | Mix Level         | Mix     | 0 — 127           | 97        |
|           | Flanger Pre Delay | Pre Dly | 0.0 — 100 [ms]    | 97        |
|           | Flanger Rate      | Rate    | 0.05 — 10.0 [Hz]  | 97        |
|           | Flanger Depth     | Depth   | 0 — 127           | 97        |
|           | Flanger Feedback  | Fbk     | -98 — +98 [%]     | 97        |
|           | Flanger Balance   | Balance | D100:0E — D0:100E | 97        |
|           | Output Level      | Level   | 0 — 127           | 97        |

### 34: ENHANSER→DELAY

| Page      | Parameter      | Display | Value             | Reference |
|-----------|----------------|---------|-------------------|-----------|
| EFX PARAM | Sensitivity    | Sens    | 0 — 127           | 97        |
|           | Mix Level      | Mix     | 0 — 127           | 97        |
|           | Delay Time     | Delay   | 0.0 — 500 [ms]    | 97        |
|           | Delay Feedback | Fbk     | -98 — +98 [%]     | 97        |
|           | Delay HF Damp  | HF Damp | *1                | 97        |
|           | Delay Balance  | Balance | D100:0E — D0:100E | 98        |
|           | Output Level   | Level   | 0 — 127           | 98        |

\*1 : 200/250/315/400/500/630/800/1000/1250/1600/2000/2500/3150/4000/5000/6300/8000/BYPASS [Hz]

### 35: CHORUS→DELAY

| Page      | Parameter        | Display       | Value             | Reference |
|-----------|------------------|---------------|-------------------|-----------|
| EFX PARAM | Chorus Pre Delay | Cho Dly       | 0.0 — 100 [ms]    | 98        |
|           | Chorus Rate      | ChoRate       | 0.05 — 10.0 [Hz]  | 98        |
|           | Chorus Depth     | Cho Dpt       | 0 — 127           | 98        |
|           | Chorus Balance   | Cho Bal       | D100:0E — D0:100E | 98        |
|           | Delay Time       | Delay         | 0.0 — 500 [ms]    | 98        |
|           | Delay Feedback   | Dly Fbk       | -98 — +98 [%]     | 98        |
|           | Delay HF Damp    | HF Damp       | *1                | 98        |
|           | Delay Balance    | Delay Balance | D100:0E — D0:100E | 98        |
|           | Output Level     | Level         | 0 — 127           | 98        |

\*1 : 200/250/315/400/500/630/800/1000/1250/1600/2000/2500/3150/4000/5000/6300/8000/BYPASS [Hz]



**36: FLANGER⇒DELAY**

| Page      | Parameter         | Display       | Value             | Reference |
|-----------|-------------------|---------------|-------------------|-----------|
| EFX PARAM | Flanger Pre Delay | Flg Dly       | 0.0 — 100 [ms]    | 98        |
|           | Flanger Rate      | FlgRate       | 0.05 — 10.0 [Hz]  | 98        |
|           | Flanger Depth     | Flg Dpt       | 0 — 127           | 98        |
|           | Flanger Feedback  | Flg Fbk       | -98 — +98 [%]     | 98        |
|           | Flanger Balance   | Flg Bal       | D100:0E — D0:100E | 98        |
|           | Delay Time        | Delay         | 0.0 — 500 [ms]    | 98        |
|           | Delay Feedback    | Dly Fbk       | -98 — +98 [%]     | 98        |
|           | Delay HF Damp     | HF Damp       | *1                | 99        |
|           | Delay Balance     | Delay Balance | D100:0E — D0:100E | 99        |
|           | Output Level      | Level         | 0 — 127           | 99        |

\*1 : 200/250/315/400/500/630/800/1000/1250/1600/2000/2500/3150/4000/5000/6300/8000/BYPASS [Hz]

**37: CHORUS⇒FLANGER**

| Page      | Parameter         | Display         | Value             | Reference |
|-----------|-------------------|-----------------|-------------------|-----------|
| EFX PARAM | Chorus Pre Delay  | Cho Dly         | 0.0 — 100 [ms]    | 99        |
|           | Chorus Rate       | ChoRate         | 0.05 — 10.0 [Hz]  | 99        |
|           | Chorus Depth      | Cho Dpt         | 0 — 127           | 99        |
|           | Chorus Balance    | Cho Bal         | D100:0E — D0:100E | 99        |
|           | Flanger Pre Delay | Flg Dly         | 0.0 — 100 [ms]    | 99        |
|           | Flanger Rate      | FlgRate         | 0.05 — 10.0 [Hz]  | 99        |
|           | Flanger Depth     | Flg Dpt         | 0 — 127           | 99        |
|           | Flanger Feedback  | Flg Fbk         | -98 — +98 [%]     | 99        |
|           | Flanger Balance   | Flanger Balance | D100:0E — D0:100E | 99        |
|           | Output Level      | Level           | 0 — 127           | 99        |

**38: CHORUS/DELAY**

\*Refer to "CHORUS⇒DELAY"

**39: FLANGER/DELAY**

\*Refer to "FLANGER⇒DELAY"

**40: CHORUS/FLANGER**

\*Refer to "CHORUS⇒DELAY"

# Default Settings for the Sound Settings

## Waveform List

### Internal A

| No. | Wave Name    | Type | No. | Wave Name    | Type | No. | Wave Name    | Type | No. | Wave Name    | Type | No. | Wave Name    | Type |
|-----|--------------|------|-----|--------------|------|-----|--------------|------|-----|--------------|------|-----|--------------|------|
| 1   | Ac Piano1 A  | L    | 52  | Nylon Gtr A  | L    | 103 | Syn Gtr B    | L    | 154 | MC-202 Bs B  | L    | 205 | Cello A      | L    |
| 2   | Ac Piano1 B  | L    | 53  | Nylon Gtr B  | L    | 104 | Syn Gtr C    | L    | 155 | MC-202 Bs C  | L    | 206 | Cello B      | L    |
| 3   | Ac Piano1 C  | L    | 54  | Nylon Gtr C  | L    | 105 | Harp 1A      | L    | 156 | Flute 1A     | L    | 207 | Cello C      | L    |
| 4   | Ac Piano2 pA | L    | 55  | 6-Str Gtr A  | L    | 106 | Harp 1B      | L    | 157 | Flute 1B     | L    | 208 | ST.Strings-R | L    |
| 5   | Ac Piano2 pB | L    | 56  | 6-Str Gtr B  | L    | 107 | Harp 1C      | L    | 158 | Flute 1C     | L    | 209 | ST.Strings-L | L    |
| 6   | Ac Piano2 pC | L    | 57  | 6-Str Gtr C  | L    | 108 | Banjo A      | L    | 159 | Blow Pipe    | L    | 210 | MonoStringsA | L    |
| 7   | Ac Piano2 fA | O    | 58  | Gtr Harm A   | L    | 109 | Banjo B      | L    | 160 | Bottle       | L    | 211 | MonoStringsC | L    |
| 8   | Ac Piano2 fB | O    | 59  | Gtr Harm B   | L    | 110 | Banjo C      | L    | 161 | Shakuhachi   | L    | 212 | Pizz         | O    |
| 9   | Ac Piano2 fC | O    | 60  | Gtr Harm C   | L    | 111 | Sitar A      | L    | 162 | Clarinet A   | L    | 213 | JP Strings1A | L    |
| 10  | Piano Thump  | O    | 61  | Comp Gtr A   | L    | 112 | Sitar B      | L    | 163 | Clarinet B   | L    | 214 | JP Strings1B | L    |
| 11  | Piano Up TH  | O    | 62  | Comp Gtr B   | L    | 113 | Sitar C      | L    | 164 | Clarinet C   | L    | 215 | JP Strings1C | L    |
| 12  | MKS-20 P3 A  | L    | 63  | Comp Gtr C   | L    | 114 | Dulcimer A   | L    | 165 | Oboe mf A    | L    | 216 | JP Strings2A | L    |
| 13  | MKS-20 P3 B  | L    | 64  | Comp Gtr A+  | L    | 115 | Dulcimer B   | L    | 166 | Oboe mf B    | L    | 217 | JP Strings2B | L    |
| 14  | MKS-20 P3 C  | L    | 65  | Mute Gtr 1   | L    | 116 | Dulcimer C   | L    | 167 | Oboe mf C    | L    | 218 | JP Strings2C | L    |
| 15  | SA Rhodes 1A | L    | 66  | Mute Gtr 2A  | L    | 117 | Shamisen A   | L    | 168 | Sop.Sax mf A | L    | 219 | Soft Pad A   | L    |
| 16  | SA Rhodes 1B | L    | 67  | Mute Gtr 2B  | L    | 118 | Shamisen B   | L    | 169 | Sop.Sax mf B | L    | 220 | Soft Pad B   | L    |
| 17  | SA Rhodes 1C | L    | 68  | Mute Gtr 2C  | L    | 119 | Shamisen C   | L    | 170 | Sop.Sax mf C | L    | 221 | Soft Pad C   | L    |
| 18  | SA Rhodes 2A | L    | 69  | Pop Strat A  | L    | 120 | Koto A       | L    | 171 | Alto Sax 1A  | L    | 222 | Fantasynth A | L    |
| 19  | SA Rhodes 2B | L    | 70  | Pop Strat B  | L    | 121 | Koto B       | L    | 172 | Alto Sax 1B  | L    | 223 | Fantasynth B | L    |
| 20  | SA Rhodes 2C | L    | 71  | Pop Strat C  | L    | 122 | Koto C       | L    | 173 | Alto Sax 1C  | L    | 224 | Fantasynth C | L    |
| 21  | E.Piano 1A   | L    | 72  | Jazz Gtr A   | L    | 123 | Pick Bass A  | L    | 174 | Tenor Sax A  | L    | 225 | D-50 HeavenA | L    |
| 22  | E.Piano 1B   | L    | 73  | Jazz Gtr B   | L    | 124 | Pick Bass B  | L    | 175 | Tenor Sax B  | L    | 226 | D-50 HeavenB | L    |
| 23  | E.Piano 1C   | L    | 74  | Jazz Gtr C   | L    | 125 | Pick Bass C  | L    | 176 | Tenor Sax C  | L    | 227 | D-50 HeavenC | L    |
| 24  | E.Piano 2A   | L    | 75  | JC Strat A   | L    | 126 | Fingerd Bs A | L    | 177 | Bari.Sax f A | L    | 228 | Fine Wine    | L    |
| 25  | E.Piano 2B   | L    | 76  | JC Strat B   | L    | 127 | Fingerd Bs B | L    | 178 | Bari.Sax f B | L    | 229 | D-50 Brass A | L    |
| 26  | E.Piano 2C   | L    | 77  | JC Strat C   | L    | 128 | Fingerd Bs C | L    | 179 | Bari.Sax f C | L    | 230 | D-50 Brass B | L    |
| 27  | E.Piano 3A   | L    | 78  | JC Strat A+  | L    | 129 | E.Bass       | L    | 180 | Harmonica A  | L    | 231 | D-50 Brass C | L    |
| 28  | E.Piano 3B   | L    | 79  | JC Strat B+  | L    | 130 | Fretless A   | L    | 181 | Harmonica B  | L    | 232 | D-50 BrassA+ | L    |
| 29  | E.Piano 3C   | L    | 80  | JC Strat C+  | L    | 131 | Fretless B   | L    | 182 | Harmonica C  | L    | 233 | DualSquare A | L    |
| 30  | MK-80 EP A   | L    | 81  | Clean Gtr A  | L    | 132 | Fretless C   | L    | 183 | Chanter      | L    | 234 | DualSquare C | L    |
| 31  | MK-80 EP B   | L    | 82  | Clean Gtr B  | L    | 133 | UprightBs 1  | L    | 184 | Tpt Sect. A  | L    | 235 | DualSquareA+ | L    |
| 32  | MK-80 EP C   | L    | 83  | Clean Gtr C  | L    | 134 | UprightBs 2A | L    | 185 | Tpt Sect. B  | L    | 236 | Pop Voice    | L    |
| 33  | D-50 EP A    | L    | 84  | Stratus A    | L    | 135 | UprightBs 2B | L    | 186 | Tpt Sect. C  | L    | 237 | Syn Vox 1    | L    |
| 34  | D-50 EP B    | L    | 85  | Stratus B    | L    | 136 | UprightBs 2C | L    | 187 | Trumpet 1A   | L    | 238 | Syn Vox 2    | L    |
| 35  | D-50 EP C    | L    | 86  | Stratus C    | L    | 137 | Slap Bass 1  | L    | 188 | Trumpet 1B   | L    | 239 | Voice Aahs A | L    |
| 36  | Celesta      | L    | 87  | OD Gtr A     | L    | 138 | Slap & Pop   | L    | 189 | Trumpet 1C   | L    | 240 | Voice Aahs B | L    |
| 37  | Music Box    | L    | 88  | OD Gtr B     | L    | 139 | Slap Bass 2  | L    | 190 | Trumpet 2A   | L    | 241 | Voice Aahs C | L    |
| 38  | Clav 1A      | L    | 89  | OD Gtr C     | L    | 140 | Slap Bass 3  | L    | 191 | Trumpet 2B   | L    | 242 | Voice Oohs1A | L    |
| 39  | Clav 1B      | L    | 90  | OD Gtr A+    | L    | 141 | Jz.Bs Thumb  | L    | 192 | Trumpet 2C   | L    | 243 | Voice Oohs1B | L    |
| 40  | Clav 1C      | L    | 91  | Heavy Gtr A  | L    | 142 | Jz.Bs Slap 1 | L    | 193 | HarmonMute1A | L    | 244 | Voice Oohs1C | L    |
| 41  | Organ 1      | L    | 92  | Heavy Gtr B  | L    | 143 | Jz.Bs Slap 2 | L    | 194 | HarmonMute1B | L    | 245 | Voice Oohs2A | L    |
| 42  | Jazz Organ 1 | L    | 93  | Heavy Gtr C  | L    | 144 | Jz.Bs Slap 3 | L    | 195 | HarmonMute1C | L    | 246 | Voice Oohs2B | L    |
| 43  | Jazz Organ 2 | L    | 94  | Heavy Gtr A+ | L    | 145 | Jz.Bs Pop    | L    | 196 | Trombone 1   | L    | 247 | Voice Oohs2C | L    |
| 44  | Organ 2      | L    | 95  | Heavy Gtr B+ | L    | 146 | Syn Bass A   | L    | 197 | French 1A    | L    | 248 | Voice Breath | L    |
| 45  | Organ 3      | L    | 96  | Heavy Gtr C+ | L    | 147 | Syn Bass C   | L    | 198 | French 1C    | L    | 249 | Male Ooh A   | L    |
| 46  | Organ 4      | L    | 97  | PowerChord A | L    | 148 | Mini Bs 1A   | L    | 199 | F.Horns A    | L    | 250 | Male Ooh B   | L    |
| 47  | Rock Organ   | L    | 98  | PowerChord B | L    | 149 | Mini Bs 1B   | L    | 200 | F.Horns B    | L    | 251 | Male Ooh C   | L    |
| 48  | Dist. Organ  | L    | 99  | PowerChord C | L    | 150 | Mini Bs 1C   | L    | 201 | F.Horns C    | L    | 252 | Org Vox A    | L    |
| 49  | Rot.Org Slw  | L    | 100 | EG Harm      | L    | 151 | Mini Bs 2    | L    | 202 | Violin A     | L    | 253 | Org Vox B    | L    |
| 50  | Rot.Org Fst  | L    | 101 | Gt.FretNoise | O    | 152 | Mini Bs 2+   | L    | 203 | Violin B     | L    | 254 | Org Vox C    | L    |
| 51  | Pipe Organ   | L    | 102 | Syn Gtr A    | L    | 153 | MC-202 Bs A  | L    | 204 | Violin C     | L    | 255 | Vox Noise    | L    |

L: Loop Waveform  
O: One-shot Waveform

\* For important information about the difference between loop and one-shot sounds, and how they are edited, see Chapter 1, "5. Concerning Tone Editing." (p. 26)

**Internal B**

| No. | Wave Name    | Type | No. | Wave Name    | Type | No. | Wave Name    | Type | No. | Wave Name     | Type |
|-----|--------------|------|-----|--------------|------|-----|--------------|------|-----|---------------|------|
| 1   | Kalimba      | L    | 52  | Feedbackwave | L    | 103 | Cowbell 1    | O    | 154 | REV 606HH Op  | O    |
| 2   | Marimba Wave | L    | 53  | Spectrum     | L    | 104 | Wood Block   | O    | 155 | REV Ride      | O    |
| 3   | Log Drum     | L    | 54  | BreathNoise  | O    | 105 | Claves       | O    | 156 | REV Cup       | O    |
| 4   | Vibes        | L    | 55  | Rattles      | L    | 106 | Bongo Hi     | O    | 157 | REV Crash 1   | O    |
| 5   | Bottle Hit   | L    | 56  | Ice Rain     | L    | 107 | Bongo Lo     | O    | 158 | REV China     | O    |
| 6   | Glockenspiel | L    | 57  | Tin Wave     | L    | 108 | Cga Open Hi  | O    | 159 | REV DrySick   | O    |
| 7   | Tubular      | L    | 58  | Anklungs     | L    | 109 | Cga Open Lo  | O    | 160 | REV RealCLP   | O    |
| 8   | Steel Drums  | L    | 59  | Wind Chimes  | L    | 110 | Cga Mute Hi  | O    | 161 | REV FingSnap  | O    |
| 9   | Fanta Bell A | L    | 60  | Orch. Hit    | O    | 111 | Cga Mute Lo  | O    | 162 | REV Cowbell   | O    |
| 10  | Fanta Bell B | L    | 61  | Tekno Hit    | O    | 112 | Cga Slap     | O    | 163 | REV WoodBlick | O    |
| 11  | Fanta Bell C | L    | 62  | Back Hit     | O    | 113 | Timbale      | O    | 164 | REV Clve      | O    |
| 12  | FantaBell A+ | L    | 63  | Philly Hit   | O    | 114 | Cabasa Up    | O    | 165 | REV Conga     | O    |
| 13  | Org Bell     | L    | 64  | Scratch 1    | O    | 115 | Cabasa Down  | O    | 166 | REV Tamb      | O    |
| 14  | Agogo        | L    | 65  | Scratch 2    | L    | 116 | Cabasa Cut   | O    | 167 | REV Maracas   | O    |
| 15  | DIGI Bell 1  | L    | 66  | Scratch 3    | O    | 117 | Maracas      | O    | 168 | REV Guiro     | O    |
| 16  | DIGI Bell 1+ | L    | 67  | Natural SN1  | O    | 118 | Long Guiro   | O    | 169 | REV Cuica     | O    |
| 17  | DIGI Chime   | L    | 68  | Natural SN2  | O    | 119 | Tambourine   | O    | 170 | REV Metro     | O    |
| 18  | Wave Scan    | L    | 69  | Piccolo SN   | O    | 120 | Open Triangl | L    | 171 | Loop 1        | L    |
| 19  | Wire String  | L    | 70  | Ballad SN    | O    | 121 | Cuica        | O    | 172 | Loop 2        | L    |
| 20  | 2.2 Bellwave | L    | 71  | SN Roll      | O    | 122 | Vibraslap    | L    | 173 | Loop 3        | L    |
| 21  | 2.2 Vibwave  | L    | 72  | 808 SN       | O    | 123 | Timpani      | L    | 174 | Loop 4        | L    |
| 22  | Spark VOX    | L    | 73  | Brush Slap   | O    | 124 | Applause     | L    | 175 | Loop 5        | L    |
| 23  | MMM VOX      | L    | 74  | Brush Swish  | O    | 125 | REV Orch.Hit | O    | 176 | Loop 6        | L    |
| 24  | Lead Wave    | L    | 75  | Brush Roll   | L    | 126 | REV TeknoHit | O    | 177 | Loop 7        | L    |
| 25  | Synth Reed   | L    | 76  | Dry Stick    | O    | 127 | REV Back Hit | O    | 178 | R8 Click      | O    |
| 26  | Synth Saw 1  | L    | 77  | Side Stick   | O    | 128 | REV PhillHit | O    | 179 | Metronome 1   | L    |
| 27  | Synth Saw 2  | L    | 78  | Lite Kick    | O    | 129 | REV Steel DR | O    | 180 | Metronome 2   | O    |
| 28  | Syn Saw 2inv | L    | 79  | Hybrid Kick1 | O    | 130 | REV Tin Wave | O    | 181 | MC500 Beep 1  | O    |
| 29  | Synth Saw 3  | L    | 80  | Hybrid Kick2 | O    | 131 | REV NatriSN1 | O    | 182 | MC500 Beep 2  | O    |
| 30  | JP-8 Saw A   | L    | 81  | Old Kick     | O    | 132 | REV NatriSN2 | O    | 183 | Low Saw       | L    |
| 31  | JP-8 Saw B   | L    | 82  | Verb Kick    | O    | 133 | REV PiccioSN | O    | 184 | Low Saw inv   | L    |
| 32  | JP-8 Saw C   | L    | 83  | Round Kick   | O    | 134 | REV BalladSN | O    | 185 | Low P5 Saw    | L    |
| 33  | P5 Saw A     | L    | 84  | 808 Kick     | L    | 135 | REV Side Stk | O    | 186 | Low Pulse 1   | L    |
| 34  | P5 Saw B     | L    | 85  | Verb Tom Hi  | O    | 136 | REV SN Roll  | O    | 187 | Low Pulse 2   | L    |
| 35  | P5 Saw C     | L    | 86  | Verb Tom Lo  | O    | 137 | REV Brush 1  | O    | 188 | Low Square    | L    |
| 36  | D-50 Saw A   | L    | 87  | Dry Tom Hi   | L    | 138 | REV Brush 2  | O    | 189 | Low Sine      | L    |
| 37  | D-50 Saw B   | L    | 88  | Dry Tom Lo   | L    | 139 | REV Brush 3  | O    | 190 | Low Triangle  | L    |
| 38  | D-50 Saw C   | L    | 89  | Cl HiHat 1   | O    | 140 | REV LiteKick | O    | 191 | Low White NZ  | L    |
| 39  | Synth Square | L    | 90  | Cl HiHat 2   | O    | 141 | REV HybridK1 | O    | 192 | Low Pink NZ   | L    |
| 40  | JP-8 SquareA | L    | 91  | Op HiHat     | L    | 142 | REV HybridK2 | O    | 193 | DC            | L    |
| 41  | JP-8 SquareB | L    | 92  | Pedal HiHat  | O    | 143 | REV Old Kick | O    |     |               |      |
| 42  | JP-8 SquareC | L    | 93  | 606 HiHat Cl | O    | 144 | REV Timpani  | O    |     |               |      |
| 43  | Synth Pulse1 | L    | 94  | 606 HiHat Op | L    | 145 | REV VerbTomH | O    |     |               |      |
| 44  | Synth Pulse2 | L    | 95  | 808 Claps    | O    | 146 | REV VerbTomL | O    |     |               |      |
| 45  | Triangle     | L    | 96  | Hand Claps   | O    | 147 | REV DryTom H | O    |     |               |      |
| 46  | Sine         | L    | 97  | Finger Snaps | O    | 148 | REV DryTom M | O    |     |               |      |
| 47  | Org Click    | O    | 98  | Ride 1       | L    | 149 | REV ClHiHat1 | O    |     |               |      |
| 48  | White Noise  | L    | 99  | Ride 2       | L    | 150 | REV ClHiHat2 | O    |     |               |      |
| 49  | Pink Noise   | L    | 100 | Ride Bell 1  | L    | 151 | REV Op HiHat | O    |     |               |      |
| 50  | Metal Wind   | L    | 101 | Crash 1      | L    | 152 | REV Pedal HH | O    |     |               |      |
| 51  | Wind Agogo   | L    | 102 | China Cym    | L    | 153 | REV 606HH Cl | O    |     |               |      |

# Patch Lists

## USER

| No. | Name         | V | No. | Name         | V |
|-----|--------------|---|-----|--------------|---|
| 1   | Symphonique  | 4 | 65  | Bass Marimba | 4 |
| 2   | Alternative  | 2 | 66  | Syncrononix  | 3 |
| 3   | Velo Tekno 1 | 3 | 67  | MandolinTrem | 4 |
| 4   | West Coast   | 4 | 68  | Poly Saws    | 4 |
| 5   | Albion       | 2 | 69  | Pulse Pad    | 4 |
| 6   | Jz Gtr Hall  | 1 | 70  | Nylon Gtr    | 1 |
| 7   | Rocker Spin  | 3 | 71  | ORBit Pad    | 2 |
| 8   | 101 Bass     | 2 | 72  | Majestic Tpt | 1 |
| 9   | Claviduck    | 2 | 73  | Terminate    | 3 |
| 10  | Jet Pad 2    | 2 | 74  | SquareLead 1 | 3 |
| 11  | Raggatronic  | 4 | 75  | House Piano  | 2 |
| 12  | Crunch Split | 4 | 76  | Foiled Again | 1 |
| 13  | Running Pad  | 4 | 77  | Pick Bass    | 1 |
| 14  | Brass Sect   | 4 | 78  | Wide Tubular | 4 |
| 15  | Flying Waltz | 4 | 79  | Velo-Rez Clv | 1 |
| 16  | Pure Tibet   | 1 | 80  | Airplaane    | 4 |
| 17  | 4 Hits 4 You | 4 | 81  | Delicate EP  | 2 |
| 18  | Waterhodes   | 2 | 82  | Rezoid       | 4 |
| 19  | Blade Racer  | 4 | 83  | E-Motion Pad | 4 |
| 20  | JC Strat     | 1 | 84  | Phripphuzz   | 1 |
| 21  | Dawn 2 Dusk  | 3 | 85  | Archimede    | 3 |
| 22  | Saw Mass     | 4 | 86  | Intentions   | 3 |
| 23  | Steel Away   | 3 | 87  | Nylon Rhodes | 4 |
| 24  | 64voicePiano | 1 | 88  | Huff N Stuff | 3 |
| 25  | Wave Bells   | 4 | 89  | Finger Bass  | 1 |
| 26  | JP-8Haunting | 4 | 90  | Gospel Spin  | 3 |
| 27  | Vanishing    | 1 | 91  | Harmonicum   | 2 |
| 28  | Harmonica    | 2 | 92  | Impact       | 4 |
| 29  | Film Octaves | 4 | 93  | Rotary Gtr   | 2 |
| 30  | Edge Boost   | 2 | 94  | TP&Sax Sect  | 4 |
| 31  | AugerMentive | 3 | 95  | Tubular Vox  | 4 |
| 32  | Deep Strings | 2 | 96  | Sawteeth     | 3 |
| 33  | Chime Wash   | 4 | 97  | Ocean Floor  | 1 |
| 34  | SA Rhodes 1  | 4 | 98  | E.Grand      | 1 |
| 35  | 3D Flanged   | 1 | 99  | Clarinet mp  | 1 |
| 36  | Ac.Upright   | 1 | 100 | Bass In Face | 2 |
| 37  | Poly Brass   | 3 | 101 | BritelovBass | 4 |
| 38  | Dissimilate  | 4 | 102 | Mellow Bars  | 4 |
| 39  | Dulcimer     | 2 | 103 | LetterFrmPat | 4 |
| 40  | Fantasy Vox  | 4 | 104 | MG Solo      | 4 |
| 41  | Dist Gtr 1   | 3 | 105 | Air Lead     | 2 |
| 42  | Sax Section  | 4 | 106 | Raya Shaku   | 3 |
| 43  | Aurora       | 4 | 107 | Greek Power  | 4 |
| 44  | St Strings   | 2 | 108 | Biosphere    | 2 |
| 45  | AmbienceVibe | 4 | 109 | EP+Mod Pad   | 4 |
| 46  | Cascade      | 1 | 110 | Chambers     | 3 |
| 47  | AltoLead Sax | 3 | 111 | Nomad Perc   | 3 |
| 48  | PWM Strings  | 3 | 112 | Horn Swell   | 4 |
| 49  | Childlike    | 4 | 113 | Hillbilllys  | 4 |
| 50  | Velo Tekno 2 | 2 | 114 | Night Shade  | 4 |
| 51  | Taj Mahal    | 1 | 115 | Nice Piano   | 3 |
| 52  | D-50 Stack   | 4 | 116 | VOX Flute    | 4 |
| 53  | ChamberWoods | 3 | 117 | Music Bells  | 2 |
| 54  | Pulse Key    | 3 | 118 | IUNO Strings | 3 |
| 55  | Mondo Bass   | 3 | 119 | Bs/Pno+Brs   | 4 |
| 56  | Velo-Wah Gtr | 1 | 120 | Dark Vox     | 2 |
| 57  | Sitar        | 2 | 121 | Bass Pizz    | 4 |
| 58  | Purple Spin  | 4 | 122 | Seq Mallet   | 2 |
| 59  | RandomVowels | 4 | 123 | Variable Run | 4 |
| 60  | Big BPF      | 4 | 124 | Cyber Space  | 3 |
| 61  | Dunes        | 4 | 125 | 12str Gtr 1  | 2 |
| 62  | Heirborne    | 4 | 126 | PianoStrings | 4 |
| 63  | PsychoRhodes | 2 | 127 | Sands ofTime | 4 |
| 64  | Tortured     | 4 | 128 | Fantasia JV  | 4 |

## PRESET A

| No. | Name         | V | No. | Name         | V |
|-----|--------------|---|-----|--------------|---|
| 1   | 64voicePiano | 1 | 65  | Dual Profs   | 3 |
| 2   | Bright Piano | 1 | 66  | Saw Mass     | 4 |
| 3   | Classique    | 2 | 67  | Poly Split   | 4 |
| 4   | Nice Piano   | 3 | 68  | Poly Brass   | 3 |
| 5   | Piano Thang  | 3 | 69  | Stackoid     | 4 |
| 6   | Power Grand  | 3 | 70  | Poly Rock    | 4 |
| 7   | House Piano  | 2 | 71  | D-50 Stack   | 4 |
| 8   | E.Grand      | 1 | 72  | Fantasia JV  | 4 |
| 9   | MIDled Grand | 3 | 73  | Jimnee Dee   | 4 |
| 10  | Piano Blend  | 3 | 74  | Heavenlys    | 4 |
| 11  | West Coast   | 4 | 75  | Mallet Pad   | 4 |
| 12  | PianoStrings | 4 | 76  | Huff N Stuff | 3 |
| 13  | Bs/Pno+Brs   | 4 | 77  | Puff 1080    | 2 |
| 14  | Waterhodes   | 2 | 78  | BellVox 1080 | 4 |
| 15  | S.A.E.P.     | 3 | 79  | Fantasy Vox  | 4 |
| 16  | SA Rhodes 1  | 4 | 80  | Square Keys  | 2 |
| 17  | SA Rhodes 2  | 2 | 81  | Childlike    | 4 |
| 18  | Stiky Rhodes | 3 | 82  | Music Box    | 3 |
| 19  | Dig Rhodes   | 2 | 83  | Toy Box      | 2 |
| 20  | Nylon EPiano | 4 | 84  | Wave Bells   | 4 |
| 21  | Nylon Rhodes | 4 | 85  | Tria Bells   | 4 |
| 22  | Rhodes Mix   | 3 | 86  | Beauty Bells | 4 |
| 23  | PsychoRhodes | 2 | 87  | Music Bells  | 2 |
| 24  | Tremo Rhodes | 4 | 88  | Pretty Bells | 2 |
| 25  | MK-80 Rhodes | 1 | 89  | Pulse Key    | 3 |
| 26  | MK-80 Phaser | 1 | 90  | Wide Tubular | 4 |
| 27  | Delicate EP  | 2 | 91  | AmbienceVibe | 4 |
| 28  | Octa Rhodes1 | 4 | 92  | Warm Vibes   | 2 |
| 29  | Octa Rhodes2 | 4 | 93  | Dyna Marimba | 1 |
| 30  | JV Rhodes+   | 4 | 94  | Bass Marimba | 4 |
| 31  | EP+Mod Pad   | 4 | 95  | Nomad Perc   | 3 |
| 32  | Mr.Mellow    | 4 | 96  | Ethno Metals | 4 |
| 33  | Comp Clav    | 1 | 97  | Islands Mit  | 4 |
| 34  | Klavinet     | 4 | 98  | Steelin Keys | 3 |
| 35  | Winger Clav  | 4 | 99  | Steel Drums  | 1 |
| 36  | Phaze Clav 1 | 2 | 100 | Voicye Pizz  | 3 |
| 37  | Phaze Clav 2 | 1 | 101 | Sitar        | 2 |
| 38  | Phuzz Clav   | 2 | 102 | Drone Split  | 4 |
| 39  | Chorus Clav  | 1 | 103 | Ethnopluck   | 4 |
| 40  | Claviduck    | 2 | 104 | Jamisen      | 2 |
| 41  | Velo-Rez Clv | 1 | 105 | Dulcimer     | 2 |
| 42  | Clavicembalo | 4 | 106 | East Melody  | 2 |
| 43  | Analog Clav1 | 1 | 107 | MandolinTrem | 4 |
| 44  | Analog Clav2 | 1 | 108 | Nylon Gtr    | 1 |
| 45  | Metal Clav   | 3 | 109 | Gtr Strings  | 3 |
| 46  | Full Stops   | 2 | 110 | Steel Away   | 3 |
| 47  | Ballad B     | 3 | 111 | Heavenly Gtr | 4 |
| 48  | Mellow Bars  | 4 | 112 | 12str Gtr 1  | 2 |
| 49  | AugerMentive | 3 | 113 | 12str Gtr 2  | 3 |
| 50  | Perky B      | 2 | 114 | Jz Gtr Hall  | 1 |
| 51  | The Big Spin | 3 | 115 | LetterFrmPat | 4 |
| 52  | Gospel Spin  | 3 | 116 | Jazz Scat    | 3 |
| 53  | Roller Spin  | 3 | 117 | Lounge Gig   | 3 |
| 54  | Rocker Spin  | 3 | 118 | JC Strat     | 1 |
| 55  | Tone Wh.Solo | 3 | 119 | Twin Strats  | 3 |
| 56  | Purple Spin  | 4 | 120 | JV Strat     | 2 |
| 57  | 60's LeadORG | 2 | 121 | Syn Strat    | 2 |
| 58  | Assalt Organ | 3 | 122 | Rotary Gtr   | 2 |
| 59  | D-50 Organ   | 2 | 123 | Muted Gtr    | 1 |
| 60  | Cathedral    | 4 | 124 | SwitchOnMute | 2 |
| 61  | Church Pipes | 4 | 125 | Power Trip   | 2 |
| 62  | Poly Key     | 3 | 126 | Crunch Split | 4 |
| 63  | Poly Saws    | 4 | 127 | Rezodrive    | 2 |
| 64  | Poly Pulse   | 4 | 128 | RockYurSocks | 4 |

## PRESET B

| No. | Name         | V | No. | Name         | V |
|-----|--------------|---|-----|--------------|---|
| 1   | Dist Gtr 1   | 3 | 65  | Analog Seq   | 2 |
| 2   | Dist Gtr 2   | 3 | 66  | Impact Vox   | 4 |
| 3   | R&R Chunk    | 4 | 67  | TeknoSoloVox | 2 |
| 4   | Phripphuzz   | 1 | 68  | X-Mod Man    | 2 |
| 5   | Grungeroni   | 3 | 69  | Paz <=> Zap  | 1 |
| 6   | Black Widow  | 4 | 70  | 4 Hits 4 You | 4 |
| 7   | Velo-Wah Gtr | 1 | 71  | Impact       | 4 |
| 8   | Mod-Wah Gtr  | 2 | 72  | Phase Hit    | 3 |
| 9   | Pick Bass    | 1 | 73  | Tekno Hit 1  | 2 |
| 10  | Hip Bass     | 2 | 74  | Tekno Hit 2  | 2 |
| 11  | Perc.Bass    | 3 | 75  | Mallet Hit 3 | 4 |
| 12  | Homey Bass   | 2 | 76  | Reverse Hit  | 3 |
| 13  | Finger Bass  | 1 | 77  | SquareLead 1 | 3 |
| 14  | Nylon Bass   | 2 | 78  | SquareLead 2 | 2 |
| 15  | Ac.Upright   | 1 | 79  | You and Luck | 2 |
| 16  | Wet Fretls   | 1 | 80  | Belly Lead   | 4 |
| 17  | Fretls Dry   | 2 | 81  | WhistlinAtom | 2 |
| 18  | Slap Bass 1  | 2 | 82  | Edge Boost   | 2 |
| 19  | Slap Bass 2  | 1 | 83  | MG Solo      | 4 |
| 20  | Slap Bass 3  | 1 | 84  | FXM Saw Lead | 4 |
| 21  | Slap Bass 4  | 2 | 85  | Sawteeth     | 3 |
| 22  | 4 Pole Bass  | 1 | 86  | Smoothe      | 2 |
| 23  | Tick Bass    | 4 | 87  | MG Lead      | 2 |
| 24  | House Bass   | 3 | 88  | MG Interval  | 4 |
| 25  | Mondo Bass   | 3 | 89  | Pulse Lead 1 | 3 |
| 26  | Clk AnalogBs | 2 | 90  | Pulse Lead 2 | 4 |
| 27  | Bass In Face | 2 | 91  | Little Lead  | 4 |
| 28  | 101 Bass     | 2 | 92  | Loud SynLead | 4 |
| 29  | Noiz Bass    | 2 | 93  | Analog Lead  | 2 |
| 30  | Super Jup Bs | 2 | 94  | 5th Lead     | 2 |
| 31  | Occitan Bass | 3 | 95  | Flute        | 2 |
| 32  | Hugo Bass    | 4 | 96  | Piccolo      | 1 |
| 33  | Multi Bass   | 2 | 97  | VOX Flute    | 4 |
| 34  | Moist Bass   | 2 | 98  | Air Lead     | 2 |
| 35  | BritelovBass | 4 | 99  | Pan Pipes    | 2 |
| 36  | Untamed Bass | 3 | 100 | Airplaane    | 4 |
| 37  | Rubber Bass  | 3 | 101 | Taj Mahal    | 1 |
| 38  | Stereoww Bs  | 3 | 102 | Raya Shaku   | 3 |
| 39  | Wonder Bass  | 3 | 103 | Oboe mf      | 1 |
| 40  | Deep Bass    | 2 | 104 | Oboe Express | 2 |
| 41  | Super JX Bs  | 2 | 105 | Clarinet mp  | 1 |
| 42  | W<RED>-Bass  | 4 | 106 | ClariExpress | 2 |
| 43  | HI-Ring Bass | 3 | 107 | Mitza Split  | 4 |
| 44  | Euro Bass    | 2 | 108 | ChamberWinds | 4 |
| 45  | SinusoidRave | 1 | 109 | ChamberWoods | 3 |
| 46  | Alternative  | 2 | 110 | Film Orch    | 4 |
| 47  | Acid Line    | 1 | 111 | Sop.Sax mf   | 2 |
| 48  | Auto TB-303  | 3 | 112 | Alto Sax     | 3 |
| 49  | Hihat Tekno  | 2 | 113 | AltoLead Sax | 3 |
| 50  | Velo Tekno 1 | 3 | 114 | Tenor Sax    | 3 |
| 51  | Raggatronic  | 4 | 115 | Baritone Sax | 3 |
| 52  | Blade Racer  | 4 | 116 | Take A Tenor | 4 |
| 53  | S&H Pad      | 1 | 117 | Sax Section  | 4 |
| 54  | Syncrononix  | 3 | 118 | Bigband Sax  | 4 |
| 55  | Foiled Again | 1 | 119 | Harmonica    | 2 |
| 56  | Alive        | 3 | 120 | Harmo Blues  | 2 |
| 57  | Velo Tekno 2 | 2 | 121 | BluesHarp    | 1 |
| 58  | Rezoid       | 4 | 122 | Hillbilllys  | 4 |
| 59  | Raverborg    | 4 | 123 | French Bags  | 4 |
| 60  | Blow Hit     | 4 | 124 | Majestic Tpt | 1 |
| 61  | Hammer Bell  | 3 | 125 | Voluntare    | 2 |
| 62  | Seq Mallet   | 2 | 126 | 2Trumpets    | 2 |
| 63  | Intentions   | 3 | 127 | Tpt Sect     | 4 |
| 64  | Pick It      | 3 | 128 | Mute TP mod  | 4 |

V: Number of Voices

\* Most all of the patches are set up (at their factory settings) so their timbre can be modified as a result of modulation, aftertouch, and expression (Control Change No. 11). You will want to try this feature out. Also, if you find that certain kinds of music data (GM, etc.) you play does not seem to sound the way it should, try switching OFF the aftertouch reception switch.

\* When using a sequencer to play ensembles, we recommend that you use mainly the preset patches. The preset patches are set up so they support the preferred sounding ranges of GM instruments (some sounds such as bass and bells extend beyond the range of a 61-key keyboard). On the other hand, the user patches (a rearranged selection of preset patches) are all designed to be played from a 61-key keyboard, and have been tuned so they sound appropriately.

## PRESET C

| No. | Name         | V | No. | Name          | V |
|-----|--------------|---|-----|---------------|---|
| 1   | Harmon Mute  | 1 | 65  | Harmonicum    | 2 |
| 2   | Tp&Sax Sect  | 4 | 66  | D-50 Heaven   | 2 |
| 3   | Sax+Tp+Tb    | 3 | 67  | Afro Horns    | 3 |
| 4   | Brass Sect   | 4 | 68  | Pop Pad       | 4 |
| 5   | Trombone     | 1 | 69  | Dreamesque    | 4 |
| 6   | Hybrid Bones | 4 | 70  | Square Pad    | 4 |
| 7   | Noble Horns  | 4 | 71  | JP-8 Hollow   | 4 |
| 8   | Massed Horns | 3 | 72  | JP-8 Haunting | 4 |
| 9   | Horn Swell   | 4 | 73  | Heirborne     | 4 |
| 10  | Brass It!    | 4 | 74  | Hush Pad      | 4 |
| 11  | Brass Attack | 3 | 75  | Jet Pad 1     | 2 |
| 12  | Archimede    | 3 | 76  | Jet Pad 2     | 2 |
| 13  | Rugby Horn   | 3 | 77  | Phaze Pad     | 3 |
| 14  | MKS-80 Brass | 2 | 78  | Phaze Str     | 4 |
| 15  | True ANALOG  | 2 | 79  | Jet Str Ens   | 2 |
| 16  | Dark Vox     | 2 | 80  | Pivotal Pad   | 4 |
| 17  | RandomVowels | 4 | 81  | 3D Flanged    | 1 |
| 18  | Angels Sing  | 2 | 82  | Fantawine     | 4 |
| 19  | Pvox Oooze   | 3 | 83  | Glassy Pad    | 3 |
| 20  | Longing...   | 3 | 84  | Moving Glass  | 1 |
| 21  | Arasian Morn | 4 | 85  | Glasswaves    | 3 |
| 22  | Beauty Vox   | 3 | 86  | Shiny Pad     | 4 |
| 23  | Mary-AnneVox | 4 | 87  | ShiftedGlass  | 2 |
| 24  | Belltree Vox | 4 | 88  | Chime Pad     | 3 |
| 25  | Vox Panner   | 2 | 89  | Spin Pad      | 2 |
| 26  | Spaced Voxx  | 4 | 90  | Rotary Pad    | 4 |
| 27  | Glass Voices | 3 | 91  | Dawn 2 Dusk   | 3 |
| 28  | Tubular Vox  | 4 | 92  | Aurora        | 4 |
| 29  | Velo Voxx    | 2 | 93  | Strobe Mode   | 4 |
| 30  | Wavox        | 3 | 94  | Albion        | 2 |
| 31  | Doos         | 1 | 95  | Running Pad   | 4 |
| 32  | Synvox Comps | 4 | 96  | Stepped Pad   | 4 |
| 33  | Vocal Oohz   | 3 | 97  | Random Pad    | 4 |
| 34  | LFO Vox      | 1 | 98  | SoundtrkDANC  | 4 |
| 35  | St.Strings   | 2 | 99  | Flying Waltz  | 4 |
| 36  | Warm Strings | 4 | 100 | Vanishing     | 1 |
| 37  | Somber Str   | 4 | 101 | 5th Sweep     | 4 |
| 38  | Marcato      | 2 | 102 | Phazweep      | 4 |
| 39  | Bright Str   | 2 | 103 | Big BPF       | 4 |
| 40  | String Ens   | 4 | 104 | MG Sweep      | 4 |
| 41  | TremoloStrng | 2 | 105 | CeremonyTimp  | 3 |
| 42  | Chambers     | 3 | 106 | Dyno Toms     | 4 |
| 43  | ViolinCello  | 4 | 107 | Sands ofTime  | 4 |
| 44  | Symphonique  | 4 | 108 | Inertia       | 4 |
| 45  | Film Octaves | 4 | 109 | Vektogram     | 4 |
| 46  | Film Layers  | 4 | 110 | Crash Pad     | 4 |
| 47  | Bass Pizz    | 4 | 111 | Feedback VOX  | 4 |
| 48  | Real Pizz    | 3 | 112 | Cascade       | 1 |
| 49  | Harp On It   | 3 | 113 | Shattered     | 2 |
| 50  | Harp         | 2 | 114 | NextFrontier  | 2 |
| 51  | JP-8 Str 1   | 2 | 115 | Pure Tibet    | 1 |
| 52  | JP-8 Str 2   | 3 | 116 | Chime Wash    | 4 |
| 53  | E-Motion Pad | 4 | 117 | Night Shade   | 4 |
| 54  | JP-8 Str 3   | 4 | 118 | Tortured      | 4 |
| 55  | Vintage Orch | 4 | 119 | Dissimilate   | 4 |
| 56  | JUNO Strings | 3 | 120 | Dunes         | 4 |
| 57  | Gigantalog   | 4 | 121 | Ocean Floor   | 1 |
| 58  | PWM Strings  | 3 | 122 | Cyber Space   | 3 |
| 59  | Warmth       | 2 | 123 | Biosphere     | 2 |
| 60  | ORBit Pad    | 2 | 124 | Variable Run  | 4 |
| 61  | Deep Strings | 2 | 125 | Ice Hall      | 2 |
| 62  | Pulsify      | 4 | 126 | ComputerRoom  | 4 |
| 63  | Pulse Pad    | 4 | 127 | Inverted      | 4 |
| 64  | Greek Power  | 4 | 128 | Terminate     | 3 |

## PRESET D (General MIDI Patch)

| No. | Name         | V | No. | Name         | V |
|-----|--------------|---|-----|--------------|---|
| 1   | Piano 1      | 2 | 65  | Soprano Sax  | 1 |
| 2   | Piano 2      | 2 | 66  | Alto Sax     | 1 |
| 3   | Piano 3      | 2 | 67  | Tenor Sax    | 1 |
| 4   | Honky-tonk   | 2 | 68  | Baritone Sax | 2 |
| 5   | E.Piano 1    | 2 | 69  | Oboe         | 2 |
| 6   | E.Piano 2    | 4 | 70  | English Horn | 2 |
| 7   | Harpsichord  | 2 | 71  | Bassoon      | 2 |
| 8   | Clav.        | 2 | 72  | Clarinet     | 1 |
| 9   | Celesta      | 1 | 73  | Piccolo      | 1 |
| 10  | Glockenspiel | 2 | 74  | Flute        | 1 |
| 11  | Music Box    | 1 | 75  | Recorder     | 2 |
| 12  | Vibraphone   | 1 | 76  | Pan Flute    | 2 |
| 13  | Marimba      | 2 | 77  | Bottle Blow  | 2 |
| 14  | Xylophone    | 2 | 78  | Shakuhachi   | 1 |
| 15  | Tubular-bell | 2 | 79  | Whistle      | 1 |
| 16  | Santur       | 2 | 80  | Ocarina      | 2 |
| 17  | Organ 1      | 1 | 81  | Square Wave  | 2 |
| 18  | Organ 2      | 1 | 82  | Saw Wave     | 2 |
| 19  | Organ 3      | 2 | 83  | Syn.Calliope | 2 |
| 20  | Church Org.1 | 2 | 84  | Chiffer Lead | 2 |
| 21  | Reed Organ   | 1 | 85  | Charang      | 3 |
| 22  | Accordion Fr | 2 | 86  | Solo Vox     | 2 |
| 23  | Harmonica    | 1 | 87  | 5th Saw Wave | 3 |
| 24  | Bandneon     | 2 | 88  | Bass & Lead  | 2 |
| 25  | Nylon-str.Gt | 1 | 89  | Fantasia     | 3 |
| 26  | Steel-str.Gt | 1 | 90  | Warm Pad     | 2 |
| 27  | Jazz Gt.     | 1 | 91  | Polysynth    | 2 |
| 28  | Clean Gt.    | 1 | 92  | Space Voice  | 2 |
| 29  | Muted Gt.    | 1 | 93  | Bowed Glass  | 3 |
| 30  | Overdrive Gt | 1 | 94  | Metal Pad    | 2 |
| 31  | DistortionGt | 1 | 95  | Halo Pad     | 3 |
| 32  | Gt.Harmonics | 3 | 96  | Sweep Pad    | 2 |
| 33  | Acoustic Bs. | 3 | 97  | Ice Rain     | 2 |
| 34  | Fingered Bs. | 1 | 98  | Soundtrack   | 2 |
| 35  | Picked Bs.   | 1 | 99  | Crystal      | 2 |
| 36  | Fretless Bs. | 1 | 100 | Atmosphere   | 2 |
| 37  | Slap Bass 1  | 1 | 101 | Brightness   | 3 |
| 38  | Slap Bass 2  | 2 | 102 | Goblin       | 2 |
| 39  | Synth Bass 1 | 1 | 103 | Echo Drops   | 2 |
| 40  | Synth Bass 2 | 1 | 104 | Star Theme   | 2 |
| 41  | Violin       | 1 | 105 | Sitar        | 1 |
| 42  | Viola        | 1 | 106 | Banjo        | 1 |
| 43  | Cello        | 1 | 107 | Shamisen     | 2 |
| 44  | Contrabass   | 1 | 108 | Koto         | 1 |
| 45  | Tremolo Str  | 1 | 109 | Kalimba      | 1 |
| 46  | PizzicatoStr | 1 | 110 | Bag Pipe     | 3 |
| 47  | Harp         | 2 | 111 | Fiddle       | 1 |
| 48  | Timpani      | 1 | 112 | Shanai       | 1 |
| 49  | Strings      | 2 | 113 | Tinkle Bell  | 4 |
| 50  | Slow Strings | 1 | 114 | Agogo        | 1 |
| 51  | Syn.Strings1 | 2 | 115 | Steel Drums  | 1 |
| 52  | Syn.Strings2 | 2 | 116 | Woodblock    | 1 |
| 53  | Choir Aahs   | 3 | 117 | Taiko        | 4 |
| 54  | Voice Oohs   | 1 | 118 | Melo. Tom 1  | 2 |
| 55  | SynVox       | 1 | 119 | Synth Drum   | 2 |
| 56  | OrchestraHit | 2 | 120 | Reverse Cym. | 2 |
| 57  | Trumpet      | 2 | 121 | Gt.FretNoise | 1 |
| 58  | Trombone     | 1 | 122 | Breath Noise | 2 |
| 59  | Tuba         | 2 | 123 | Seashore     | 3 |
| 60  | MutedTrumpet | 1 | 124 | Bird         | 4 |
| 61  | French Horn  | 2 | 125 | Telephone 1  | 1 |
| 62  | Brass 1      | 2 | 126 | Helicopter   | 2 |
| 63  | Synth Brass1 | 1 | 127 | Applause     | 4 |
| 64  | Synth Brass2 | 2 | 128 | Gun Shot     | 2 |

# Rhythm Sets Lists

## USER

| Key (Note) | No.1            | No.2         |
|------------|-----------------|--------------|
|            | HouseDrumSet    | JazzDrumSet1 |
|            | Wave Name       | Wave Name    |
| 35         | Scratch 1       | Hybrid Kick2 |
| C2 36      | 808 SN          | Hybrid Kick1 |
|            | 37 Dry Stick    | Side Stick   |
| 38         | 808 SN          | Ballad SN    |
|            | 39 808 Claps    | Brush Slap   |
| 40         | 808 SN          | Brush Swish  |
| 41         | 808 Kick        | Verb Tom Lo  |
|            | 42 606 HiHat Cl | Cl HiHat 1   |
| 43         | 808 SN          | Verb Tom Lo  |
|            | 44 606 HiHat Cl | Pedal HiHat  |
| 45         | 808 Kick        | Verb Tom Hi  |
|            | 46 606 HiHat Op | Op HiHat     |
| 47         | 808 SN          | Verb Tom Hi  |
| C3 48      | 808 Kick        | Verb Tom Hi  |
|            | 49 Crash 1      | Crash 1      |
| 50         | 808 SN          | Verb Tom Hi  |
|            | 51 Ride 2       | Ride 2       |
| 52         | REV Crash 1     | China Cym    |
| 53         | Ride Bell 1     | Ride Bell 1  |
|            | 54 Tambourine   | Tambourine   |
| 55         | Crash 1         | Crash 1      |
|            | 56 Cowbell 1    | Cowbell 1    |
| 57         | Crash 1         | Crash 1      |
|            | 58 Vibraslap    | Vibraslap    |
| 59         | Ride 2          | Ride 2       |
| C4 60      | Bongo Hi        | Bongo Hi     |
|            | 61 Bongo Lo     | Bongo Lo     |
| 62         | Cga Mute Hi     | Cga Mute Hi  |
|            | 63 Cga Open Hi  | Cga Open Hi  |
| 64         | Cga Open Lo     | Cga Open Lo  |
| 65         | Timbale         | Timbale      |
|            | 66 Timbale      | Timbale      |
| 67         | Agogo           | Agogo        |
|            | 68 Agogo        | Agogo        |
| 69         | Cabasa Cut      | Cabasa Up    |
|            | 70 Maracas      | Maracas      |
| 71         | Soft Pad B      | Soft Pad B   |
| C5 72      | Soft Pad A      | Soft Pad A   |
|            | 73 Long Guiro   | Long Guiro   |
| 74         | Long Guiro      | Long Guiro   |
|            | 75 Claves       | Claves       |
| 76         | Wood Block      | Wood Block   |
| 77         | Wood Block      | Wood Block   |
|            | 78 Cuica        | Cuica        |
| 79         | Cuica           | Cuica        |
|            | 80 Open Triangl | Open Triangl |
| 81         | Open Triangl    | Open Triangl |
|            | 82 Cabasa Cut   | Cabasa Cut   |
| 83         | Tambourine      | Spectrum     |
| C6 84      | Old Kick        | Wind Chimes  |
|            | 85 Scratch 1    | Wood Block   |
| 86         | Piccolo SN      | Cga Slap     |
|            | 87 Scratch 3    | Dry Tom Lo   |
| 88         | White Noise     | Lite Kick    |
| 89         | Synth Saw 1     | Hybrid Kick2 |
|            | 90 Synth Pulse1 | Old Kick     |
| 91         | Back Hit        | 808 Kick     |
|            | 92 Tekno Hit    | Natural SN1  |
| 93         | Orch. Hit       | Natural SN2  |
|            | 94 Philly Hit   | SN Roll      |
| 95         | REV Back Hit    | Natural SN2  |
| C7 96      | MC500 Beep 1    | Metronome 2  |
|            | 97 R8 Click     | R8 Click     |
| 98         | MC500 Beep 2    | Metronome 1  |

## PRESET A

| No.1         | No.2         |
|--------------|--------------|
|              |              |
| Wave Name    | Wave Name    |
| Verb Kick    | Hybrid Kick1 |
| Hybrid Kick1 | Round Kick   |
| Side Stick   | Dry Stick    |
| Natural SN2  | Piccolo SN   |
| 808 Claps    | Hand Claps   |
| SN Roll      | Piccolo SN   |
| Verb Tom Lo  | Verb Tom Lo  |
| Cl HiHat 1   | Cl HiHat 1   |
| Verb Tom Lo  | Verb Tom Lo  |
| Cl HiHat 2   | Cl HiHat 2   |
| Verb Tom Hi  | Verb Tom Hi  |
| Op HiHat     | Op HiHat     |
| Verb Tom Hi  | Verb Tom Hi  |
| Verb Tom Hi  | Verb Tom Hi  |
| Crash 1      | Crash 1      |
| Verb Tom Hi  | Verb Tom Hi  |
| Ride 2       | Ride 1       |
| China Cym    | China Cym    |
| Ride Bell 1  | Ride Bell 1  |
| Tambourine   | Tambourine   |
| Crash 1      | Crash 1      |
| Cowbell 1    | Cowbell 1    |
| Crash 1      | Crash 1      |
| Cowbell 1    | Cowbell 1    |
| Ride Bell 1  | Ride Bell 1  |
| Cga Mute Hi  | Cga Mute Hi  |
| Cga Mute Lo  | Cga Mute Lo  |
| Cga Slap     | Cga Slap     |
| Cga Open Hi  | Cga Open Hi  |
| Cga Open Lo  | Cga Open Lo  |
| Timbale      | Timbale      |
| Timbale      | Timbale      |
| Agogo        | Agogo        |
| Agogo        | Agogo        |
| Cabasa Up    | Cabasa Up    |
| Maracas      | Maracas      |
| Soft Pad A   | Cabasa Down  |
| Soft Pad B   | Cabasa Cut   |
| Long Guiro   | 808 Kick     |
| Long Guiro   | 808 SN       |
| Claves       | DIGI Bell 1  |
| Wood Block   | 808 SN       |
| Wood Block   | 808 Kick     |
| Cuica        | Spectrum     |
| Cuica        | 808 Kick     |
| Open Triangl | Spectrum     |
| Open Triangl | 808 Kick     |
| Cabasa Cut   | Spectrum     |
| Spectrum     | 808 Kick     |
| Wind Chimes  | 808 Kick     |
| Wood Block   | Feedbackwave |
| Cga Slap     | 808 Kick     |
| Dry Tom Lo   | Feedbackwave |
| Lite Kick    | Pop Voice    |
| Hybrid Kick2 | Pop Voice    |
| Old Kick     | Wind Agogo   |
| Pop Voice    | Pop Voice    |
| Wind Agogo   | Wind Agogo   |
| Op HiHat     | Op HiHat     |
| Anklungs     | Anklungs     |
| Op HiHat     | Op HiHat     |
| Metronome 2  | Metronome 2  |
| R8 Click     | R8 Click     |
| Metronome 1  | Metronome 1  |

## PRESET B

| No.1         | No.2         |
|--------------|--------------|
|              |              |
| Wave Name    | Wave Name    |
| Verb Kick    | 808 Kick     |
| Round Kick   | Round Kick   |
| Dry Stick    | Side Stick   |
| Piccolo SN   | 808 SN       |
| 808 Claps    | 808 Claps    |
| Natural SN2  | 808 SN       |
| Verb Tom Lo  | 808 Kick     |
| Cl HiHat 1   | 606 HiHat Cl |
| Verb Tom Lo  | Tekno Hit    |
| Pedal HiHat  | 606 HiHat Cl |
| Verb Tom Lo  | 808 Kick     |
| Op HiHat     | 606 HiHat Op |
| Verb Tom Lo  | Tekno Hit    |
| Verb Tom Hi  | 808 Kick     |
| Crash 1      | Crash 1      |
| Verb Tom Hi  | Tekno Hit    |
| Ride 1       | Voice Breath |
| China Cym    | MC500 Beep 1 |
| Ride Bell 1  | MC500 Beep 2 |
| Tambourine   | R8 Click     |
| Crash 1      | Pizz         |
| Cowbell 1    | DIGI Bell 1  |
| Crash 1      | Rattles      |
| Vibraslap    | Ride Bell 1  |
| Ride 1       | REV Tamb     |
| Bongo Hi     | 2.2 Vibwave  |
| Bongo Lo     | Low Pink NZ  |
| Cga Mute Hi  | Kalimba      |
| Cga Open Hi  | Metal Wind   |
| Cga Open Lo  | Lead Wave    |
| Timbale      | Tin Wave     |
| Timbale      | Agogo        |
| Agogo        | Lite Kick    |
| Agogo        | Agogo        |
| Cabasa Up    | Lite Kick    |
| Maracas      | Agogo        |
| Soft Pad A   | Gtr Harm A   |
| Soft Pad B   | Gtr Harm A   |
| Long Guiro   | Piano Thump  |
| Long Guiro   | Natural SN1  |
| Claves       | Hand Claps   |
| Wood Block   | Natural SN1  |
| Wood Block   | 808 SN       |
| Cuica        | PowerChord B |
| Cuica        | Hybrid Kick2 |
| Open Triangl | PowerChord B |
| Open Triangl | Gt.FretNoise |
| Maracas      | Banjo B      |
| Ice Rain     | Slap Bass 1  |
| Wind Chimes  | Oboe mf A    |
| Claves       | Shakuhachi   |
| 808 SN       | Pizz         |
| Verb Tom Hi  | Syn Vox 1    |
| Piccolo SN   | Voice Aahs A |
| Scratch 3    | Voice Oohs2A |
| Tin Wave     | Pop Voice    |
| Spectrum     | Male Ooh A   |
| REV Steel DR | Voice Breath |
| REV Tin Wave | Org Vox C    |
| REV PiccloSN | Vox Noise    |
| REV Crash 1  | Vox Noise    |
| Metronome 2  | Applause     |
| R8 Click     | R8 Click     |
| Metronome 1  | Metronome 2  |

### PRESET C

| Key (Note) | No.1                      | No.2                     |
|------------|---------------------------|--------------------------|
|            | JazzDrumSet2<br>Wave Name | OrchDrumSet<br>Wave Name |
| 35         | Round Kick                | Old Kick                 |
| C2 36      | Old Kick                  | Round Kick               |
| 37         | Side Stick                | Side Stick               |
| 38         | Ballad SN                 | Ballad SN                |
| 39         | Hand Claps                | 808 Claps                |
| 40         | SN Roll                   | SN Roll                  |
| 41         | Verb Tom Lo               | Timpani                  |
| 42         | Cl HiHat 2                | Timpani                  |
| 43         | Dry Tom Lo                | Timpani                  |
| 44         | Pedal HiHat               | Timpani                  |
| 45         | Verb Tom Lo               | Timpani                  |
| 46         | Op HiHat                  | Timpani                  |
| 47         | Dry Tom Lo                | Timpani                  |
| C3 48      | Verb Tom Hi               | Timpani                  |
| 49         | Crash 1                   | Timpani                  |
| 50         | Dry Tom Hi                | Timpani                  |
| 51         | Ride 2                    | Timpani                  |
| 52         | China Cym                 | Timpani                  |
| 53         | Ride Bell 1               | Timpani                  |
| 54         | Tambourine                | Tambourine               |
| 55         | Crash 1                   | Crash 1                  |
| 56         | Cowbell 1                 | Cowbell 1                |
| 57         | Crash 1                   | Crash 1                  |
| 58         | Vibraslap                 | Ride 1                   |
| 59         | Ride 2                    | Ride 2                   |
| C4 60      | Bongo Hi                  | Bongo Hi                 |
| 61         | Bongo Lo                  | Bongo Lo                 |
| 62         | Cga Mute Hi               | Cga Mute Hi              |
| 63         | Cga Open Hi               | Cga Open Hi              |
| 64         | Cga Open Lo               | Cga Open Lo              |
| 65         | Timbale                   | Timbale                  |
| 66         | Timbale                   | Timbale                  |
| 67         | Agogo                     | Agogo                    |
| 68         | Agogo                     | Agogo                    |
| 69         | Cabasa Up                 | Cabasa Up                |
| 70         | Maracas                   | Maracas                  |
| 71         | Soft Pad A                | Soft Pad A               |
| C5 72      | Brush Swish               | Soft Pad B               |
| 73         | Long Guiro                | Long Guiro               |
| 74         | Long Guiro                | Long Guiro               |
| 75         | Claves                    | Claves                   |
| 76         | Wood Block                | Wood Block               |
| 77         | Metronome 2               | Wood Block               |
| 78         | Cuica                     | Cuica                    |
| 79         | Cuica                     | Cuica                    |
| 80         | Open Triangl              | Open Triangl             |
| 81         | Open Triangl              | Open Triangl             |
| 82         | Cabasa Cut                | Cabasa Cut               |
| 83         | Spectrum                  | Spectrum                 |
| C6 84      | Wind Chimes               | Wind Chimes              |
| 85         | Wood Block                | Wood Block               |
| 86         | Cga Slap                  | Cga Slap                 |
| 87         | Dry Tom Lo                | Dry Tom Lo               |
| 88         | Lite Kick                 | Applause                 |
| 89         | Hybrid Kick2              | Hybrid Kick2             |
| 90         | Old Kick                  | Cl HiHat 1               |
| 91         | Natural SN2               | Round Kick               |
| 92         | Natural SN1               | Pedal HiHat              |
| 93         | Brush Swish               | Natural SN2              |
| 94         | Brush Roll                | Op HiHat                 |
| 95         | Brush Slap                | Brush Slap               |
| C7 96      | Metronome 2               | Brush Swish              |
| 97         | R8 Click                  | Brush Roll               |
| 98         | Metronome 1               | SN Roll                  |

### PRESET D

| Key (Note)   | No.1                   | No.2                      |
|--------------|------------------------|---------------------------|
|              | GMDrumSet<br>Wave Name | BrushDrumSet<br>Wave Name |
| Verb Kick    | Hybrid Kick2           |                           |
| Hybrid Kick1 | Hybrid Kick1           |                           |
| Side Stick   | Side Stick             |                           |
| Ballad SN    | Brush Swish            |                           |
| 808 Claps    | Brush Slap             |                           |
| Piccolo SN   | Brush Roll             |                           |
| Verb Tom Lo  | Dry Tom Lo             |                           |
| Cl HiHat 1   | Cl HiHat 1             |                           |
| Verb Tom Lo  | Dry Tom Lo             |                           |
| Pedal HiHat  | Pedal HiHat            |                           |
| Verb Tom Hi  | Dry Tom Hi             |                           |
| Op HiHat     | Op HiHat               |                           |
| Verb Tom Hi  | Dry Tom Hi             |                           |
| Verb Tom Hi  | Dry Tom Hi             |                           |
| Crash 1      | Crash 1                |                           |
| Verb Tom Hi  | Dry Tom Hi             |                           |
| Ride 2       | Ride 2                 |                           |
| China Cym    | China Cym              |                           |
| Ride Bell 1  | Ride Bell 1            |                           |
| Tambourine   | Tambourine             |                           |
| Crash 1      | Crash 1                |                           |
| Cowbell 1    | Cowbell 1              |                           |
| Crash 1      | Crash 1                |                           |
| Vibraslap    | Vibraslap              |                           |
| Ride 2       | Ride 2                 |                           |
| Bongo Hi     | Cga Mute Hi            |                           |
| Bongo Lo     | Cga Mute Lo            |                           |
| Cga Mute Hi  | Cga Slap               |                           |
| Cga Open Hi  | Cga Open Hi            |                           |
| Cga Open Lo  | Cga Open Lo            |                           |
| Timbale      | Timbale                |                           |
| Timbale      | Timbale                |                           |
| Agogo        | Agogo                  |                           |
| Agogo        | Agogo                  |                           |
| Cabasa Up    | Cabasa Up              |                           |
| Maracas      | Maracas                |                           |
| Soft Pad A   | Soft Pad A             |                           |
| Soft Pad B   | Soft Pad B             |                           |
| Long Guiro   | Long Guiro             |                           |
| Long Guiro   | Long Guiro             |                           |
| Claves       | Claves                 |                           |
| Wood Block   | Wood Block             |                           |
| Wood Block   | Wood Block             |                           |
| Cuica        | Cuica                  |                           |
| Cuica        | Cuica                  |                           |
| Open Triangl | Open Triangl           |                           |
| Open Triangl | Open Triangl           |                           |
| Cabasa Cut   | Cabasa Cut             |                           |
| Spectrum     | Spectrum               |                           |
| Wind Chimes  | Wind Chimes            |                           |
| Wood Block   | Wood Block             |                           |
| Cga Slap     | Cga Slap               |                           |
| Dry Tom Lo   | Dry Tom Lo             |                           |
| Lite Kick    | Lite Kick              |                           |
| Hybrid Kick2 | Hybrid Kick2           |                           |
| Old Kick     | Old Kick               |                           |
| 808 Kick     | 808 Kick               |                           |
| Natural SN1  | Natural SN1            |                           |
| Natural SN2  | Natural SN2            |                           |
| 808 SN       | SN Roll                |                           |
| Brush Slap   | Brush Slap             |                           |
| Brush Swish  | Metronome 2            |                           |
| Brush Roll   | R8 Click               |                           |
| SN Roll      | Metronome 1            |                           |

## Performance Lists

### USER

| No. | Name         |
|-----|--------------|
| 1   | Tekno Loop 1 |
| 2   | Opening Orch |
| 3   | Feedback EP  |
| 4   | Cosmic Dawn  |
| 5   | Tekno Loop 2 |
| 6   | S&H / Pad    |
| 7   | Fr.Horn Sect |
| 8   | White Hole   |
| 9   | Nebular Vox  |
| 10  | Flying Jazz  |
| 11  | Terminator   |
| 12  | Orchestral   |
| 13  | Rave Split   |
| 14  | Multi Sax    |
| 15  | Bass / Lead  |
| 16  | AcPiano+Pad  |
| 17  | Kicks Attack |
| 18  | Humming Vox  |
| 19  | Step Brass   |
| 20  | Drone / Pipe |
| 21  | Sweeper      |
| 22  | Chime Dreams |
| 23  | Big Band     |
| 24  | Labyrinth    |
| 25  | SpaceCarrier |
| 26  | EasternSplit |
| 27  | Cyber Sweep  |
| 28  | Tekno Asia   |
| 29  | 1080 Fantasy |
| 30  | Pop Ballad   |
| 31  | Rhythmatic   |
| 32  | Power JV     |

### PRESET A

| No. | Name         |
|-----|--------------|
| 1   | House Set    |
| 2   | Analectro    |
| 3   | Anatronic    |
| 4   | Tekno Pop 1  |
| 5   | Tekno Pop 2  |
| 6   | Hard Core    |
| 7   | Hi Energy    |
| 8   | Pop Dance    |
| 9   | Acid Set     |
| 10  | Ambient Set  |
| 11  | Electro Pop  |
| 12  | Pop Set 1    |
| 13  | Pop Set 2    |
| 14  | Pop Set 3    |
| 15  | Pop Set 4    |
| 16  | L.A. Ballad  |
| 17  | Hip Hop Set  |
| 18  | Funk Rock    |
| 19  | Funk Fusion  |
| 20  | Heavy Metal  |
| 21  | Heavy Kids   |
| 22  | Latin Set    |
| 23  | BrazilianSet |
| 24  | New Age 1    |
| 25  | New Age 2    |
| 26  | Orchestra    |
| 27  | Concerto     |
| 28  | Film Score 1 |
| 29  | Film Score 2 |
| 30  | Symphonic    |
| 31  | Chamber Set  |
| 32  | Baroque Set  |

### PRESET B

| No. | Name         |
|-----|--------------|
| 1   | Africa       |
| 2   | World Ethnic |
| 3   | Asian Ethnic |
| 4   | Asian Band   |
| 5   | 60's Set     |
| 6   | Blues Band   |
| 7   | Country Band |
| 8   | Folk Set     |
| 9   | Reggae Band  |
| 10  | FunkWah Band |
| 11  | Funkin'Phaze |
| 12  | Zydeco Band  |
| 13  | New Orleans  |
| 14  | Dixieland    |
| 15  | Big Band Set |
| 16  | Cont.Jazz 1  |
| 17  | Cont.Jazz 2  |
| 18  | Ac.Jazz Set  |
| 19  | Gospel Set   |
| 20  | All Strings  |
| 21  | All Brass    |
| 22  | All Piano 1  |
| 23  | All Piano 2  |
| 24  | All Keyboard |
| 25  | All Organ    |
| 26  | All Winds    |
| 27  | All Bells    |
| 28  | Mlt & Perc   |
| 29  | All Seq      |
| 30  | All Bass     |
| 31  | All Pad      |
| 32  | All FX       |



# The Demo Song Names/Composer Profiles

Following Demo Songs and whose composer's profiles contained in the JV-1080:

## **RISE**

---

Music by David Goldblatt Copyright ©1994, David Goldblatt Music

David Goldblatt is a Los Angeles based composer/keybordist who has performed and recorded with a broad spectrum of artists such as Tribal Tech with Gary Willis and Scott Henderson, Stanley Clarke, Dizzy Gillespie, Wayne Shorter, Joe Sample, etc.. David's compositions were featured on two Tribal Tech CDs and Brandon Fields latest CD. He is heard on many TV shows and movies, such as Jodie Foster's "Little Man Tate," as a session artist. He has written and arranged for TV shows, jingles, and various productions in all sectors of the music industry, including musical director for various TV shows and a 1989 world tour with Diana Ross, as musical director, keyboardist, and arranger, which included a live CD and a concert video for HBO.

## **1080 Rave**

---

Music by Ryeland Allison Copyright © 1994, Ryeland Allison

Ryeland arranges simultaneous manifold particle vibrations to proclaim "Resonance." Resonance is to some extent qualified to contented apportion within disassociative continuance, preceding space. When converged in a synchronous locus, he at once regenerates toward fluidic empathy.

He is honored to introduce this to you.

## **StormWarning**

---

Music by Mitsuru Sakaue Copyright © 1994, Roland Corporation

Mitsuru Sakaue began composing and doing arrangements for commercials and videos while still in school. In particular, his studio work earned for him a solid reputation. Currently, he produces commercial musics and jingles for FM stations.

*\* These demo songs are intended for personal enjoyment/demonstration use only. Any other use (public performance, broadcast, sampling, duplication, transcription, etc.) is strictly prohibited and would constitute a violation of applicable copyright laws.*

# Roland Exclusive messages

## 1. Data Format for Exclusive Messages

Roland's MIDI implementation uses the following data format for all Exclusive messages (type IV):

| Byte   | Description              |
|--------|--------------------------|
| F0H    | Exclusive Status         |
| 41H    | Manufacturer ID (Roland) |
| DEV    | Device ID                |
| MDL    | Model ID                 |
| CMD    | Command ID               |
| [BODY] | Main data                |
| F7H    | End of exclusive         |

### •MIDI status: F0H, F7H

An Exclusive message must be flanked by a pair of status codes, starting with a Manufacturer ID immediately after F0H (MIDI version 1.0).

### •Manufacturer ID: 41H

The Manufacturer ID identifies the manufacturer of a MIDI instrument that sends an Exclusive message. Value 41H represents Roland's Manufacturer ID.

### •Device ID: DEV

The Device ID contains a unique value that identifies individual devices in the implementation of several MIDI instruments. It is usually set to 00H-0FH, a value smaller by one than that of a basic channel, but value 00H-1FH may be used for a device with several basic channels.

### •Model ID: MDL

The Model ID contains a value that identifies one model from another. Different models, however, may share an identical Model ID if they handle similar data.

The Model ID format may contain 00H in one or more places to provide an extended data field. The following are examples of valid Model IDs, each representing a unique model:

01H  
02H  
03H  
00H, 01H  
00H, 02H  
00H, 00H, 01H

### •Command ID: CMD

The Command ID indicates the function of an Exclusive message. The Command ID format may contain 00H in one or more places to provide an extended data field. The following are examples of valid Command IDs, each representing a unique function:

01H  
02H  
03H  
00H, 01H  
00H, 02H  
00H, 00H, 01H

### •Main data: BODY

This field contains a message to be exchanged across an interface. The exact data size and content will vary with the Model ID and Command ID.

## 2. Address-mapped Data Transfer

Address mapping is a technique for transferring messages conforming to the data format given in Section 1. It assigns a series of memory-resident records—waveform and tone data, switch status, and parameters, for example, to specific locations in a machine-dependent address space, thereby allowing access to data residing at the address a message specifies.

Address-mapped data transfer is therefore independent of models and data categories. This technique allows use of two different transfer procedures: one-way transfer and handshake transfer.

### •One-way transfer procedure (See Section 3 for details.)

This procedure is suited to the transfer of a small amount of data. It sends out an Exclusive message completely independent of the receiving device's status.

#### Connection Diagram

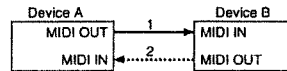

Connection at point 2 is essential for "Request data" procedures. (See Section 3.)

### •Handshake-transfer procedure (This device does not use this procedure)

This procedure initiates a predetermined transfer sequence (handshaking) across the interface before data transfer takes place. Handshaking ensures that reliability and transfer speed are high enough to handle a large amount of data.

#### Connection Diagram

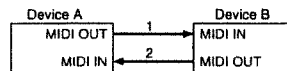

Connection at points 1 and 2 is essential.

## Notes on the above procedures

- There are separate Command IDs for different transfer procedures.
- Devices A and B cannot exchange data unless they use the same transfer procedure, share identical Device ID and Model ID, and are ready for communication.

## 3. One-way Transfer Procedure

This procedure sends out data until it has all been sent and is used when the messages are so short that answerbacks need not be checked.

For longer messages, however, the receiving device must acquire each message in time with the transfer sequence, which inserts 20 milliseconds intervals.

#### Types of Messages

| Message        | Command ID |
|----------------|------------|
| Request data 1 | RQ1 (11H)  |
| Data set 1     | DT1 (12H)  |

### •Request data #1: RQ1 (11H)

This message is sent out when there is a need to acquire data from a device at the other end of the interface. It contains data for the address and size that specify designation and length, respectively, of data required.

On receiving an RQ1 message, the remote device checks its memory for the data address and size that satisfy the request.

If it finds them and is ready for communication, the device will transmit a "Data set 1 (DT1)" message, which contains the requested data. Otherwise, the device won't send out anything.

| Byte | Description              |
|------|--------------------------|
| F0H  | Exclusive Status         |
| 41H  | Manufacturer ID (Roland) |
| DEV  | Device ID                |
| MDL  | Model ID                 |
| 11H  | Command ID               |
| aaH  | Address MSB              |
|      |                          |
|      |                          |
|      | LSB                      |
| ssH  | Size MSB                 |
|      |                          |
|      |                          |
|      | LSB                      |
| sum  | Check sum                |
| F7H  | End of exclusive         |

- The size of the requested data does not indicate the number of bytes that will make up a DT1 message, but represents the address fields where the requested data resides.
- Some models are subject to limitations in data format used for a single transaction. Requested data, for example, may have a limit in length or must be divided into predetermined address fields before it is exchanged across the interface.
- The same number of bytes comprises address and size data, which, however, vary with the Model ID.
- The error-checking process uses a checksum that provides a bit pattern where the last 7 bits are zero when values for an address, size, and that checksum are summed.

### • Data set 1: DT1 (12H)

This message corresponds to the actual data transfer process. Because every byte in the data is assigned a unique address, a DT1 message can convey the starting address of one or more bits of data as well as a series of data formatted in an address-dependent order.

The MIDI standards inhibit non real-time messages from interrupting an Exclusive one. This fact is inconvenient for devices that support a "soft-thru" function. To maintain compatibility with such devices, Roland has limited the DT1 to 256 bytes so that an excessively long message is sent out in separate 'segments'.

| Byte | Description              |
|------|--------------------------|
| F0H  | Exclusive Status         |
| 41H  | Manufacturer ID (Roland) |
| DEV  | Device ID                |
| MDL  | Model ID                 |
| 12H  | Command ID               |
| aaH  | Address MSB              |
|      |                          |
|      |                          |
|      | LSB                      |
| ddH  | Data MSB                 |
|      |                          |
|      |                          |
|      | LSB                      |
| sum  | Check sum                |
| F7H  | End of exclusive         |

- A DT1 message is capable of providing only the valid data among those specified by an RQ1 message.
- Some models are subject to limitations in data format used for a single transaction. Requested data, for example, may have a limit in length or must be divided into predetermined address fields before it is exchanged across the interface.
- The number of bytes comprising address data varies from one Model ID to another.
- The error-checking process uses a checksum that provides a bit pattern where the last 7 bits are zero when values for an address, size, and that checksum are summed.

### • Example of Message Transactions

#### • Device A sending data to Device B

Transfer of a DT1 message is all that takes place.

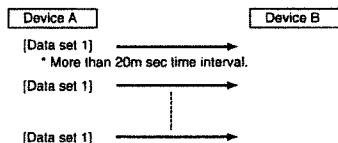

#### • Device B requesting data from Device A

Device B sends an RQ1 message to Device A. Checking the message, Device A sends a DT1 message back to Device B.

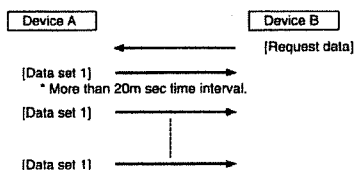

[ MULTI TIMBRAL SYNTHESIZER MODULE ]  
**Model JV-1080** **MIDI Implementation**

Date : JULY, 9, 1994  
 Version; 1.00

( How to read the tables )

This shows the results which you can get by setting each parameter.

| Parameters to be set          | Level of tone will be changed |                | Tone parameters can be controlled in real-time |             | Effect parameters can be controlled in real-time |              |
|-------------------------------|-------------------------------|----------------|--|-------------|--|--------------|
|                               | Setting1                      | Setting2       | Setting1                                       | Setting2    | Setting1   | Setting2     |
| <b>SYSTEM PARAMETER</b>       |                               |                |  |             |  |              |
| System Control Source 1/2     | ---                           | ---            | CC11:EXPRESSION                                | ---         | CC11:EXPRESSION                                  | ---          |
| Receive Control Change        | ON                            | ON             | ON   | ON          | ON   | ON           |
| Volume Control Source         | VOL&EXP                       | ---            | ---  | ---         | ---  | ---          |
| <b>PATCH COMMON PARAMETER</b> |                               |                |  |             |  |              |
| EFX Control Source 1/2        | ---                           | ---            | ---  | ---         | EXPRESSION                                       | SYS-CTRL1/2  |
| EFX Control Depth 1/2         | ---                           | ---            | ---  | ---         | Other than 0                                     | Other than 0 |
| Patch Control Source 1/2/3    | ---                           | ---            | EXPRESSION                                     | SYS-CTRL1/2 | ---  | ---          |
| <b>PATCH TONE PARAMETER</b>   |                               |                |  |             |  |              |
| Volume Control Switch         | ON                            | ---            | ---  | ---         | ---  | ---          |
| Ctrl 1/2/3 Dest.1/2/3/4       | ---                           | Other than OFF | Other than OFF                                 | ---         | ---  | ---          |
| Ctrl 1/2/3 Depth1/2/3/4       | ---                           | Other than 0   | Other than 0                                   | ---         | ---  | ---          |

Values of the parameters

---:Need not be set

This shows there are two different ways of setting to get the same result.

**1. RECEIVE DATA**

**■ Channel Voice Message**

● Note off

| Status | Second | Third |
|--------|--------|-------|
| 9nH    | kkH    | vvH   |
| 9nH    | kkH    | 00H   |

n = MIDI channel number: 0H - FH ( 0 - 15 ) 0 = ch.1 15 = ch.16  
 kk = Note number : 00H - 7FH ( 0 - 127 )  
 vv = Velocity : 00H - 7FH ( 0 - 127 )

\* In the performance mode, receives this message when the MIDI Receive Switch of each part parameter is ON.  
 \* Rhythm part (part 10) receives this message when the envelope mode of a rhythm tone parameter is SUSTAIN.

● Note on

| Status | Second | Third |
|--------|--------|-------|
| 9nH    | kkH    | vvH   |

n = MIDI channel number: 0H - FH ( 0 - 15 ) 0 = ch.1 15 = ch.16  
 kk = Note number : 00H - 7FH ( 0 - 127 )  
 vv = Velocity : 01H - 7FH ( 1 - 127 )

\* In the performance mode, receives this message when the MIDI Receive Switch of each part parameter is ON.

● Polyphonic key pressure

| Status | Second | Third |
|--------|--------|-------|
| AnH    | kkH    | vvH   |

n = MIDI channel number: 0H - FH ( 0 - 15 ) 0 = ch.1 15 = ch.16  
 kk = Note number : 00H - 7FH ( 0 - 127 )  
 vv = Pressure value : 00H - 7FH ( 0 - 127 )

**1. Patch Mode**

| Parameters to be set          | Tone parameters can be controlled in real-time |                       | Effect parameters can be controlled in real-time |                       |
|-------------------------------|--|-----------------------|--|-----------------------|
|                               | Setting1                                       | Setting2              | Setting1   | Setting2              |
| <b>SYSTEM PARAMETER</b>       |  |                       |  |                       |
| System Control Source 1/2     | ---  | AFTERTOUCH            | ---  | AFTERTOUCH            |
| Receive Aftertouch            | ON   | ON                    | ON   | ON                    |
| Aftertouch Source             | CH&POLY or POLY-AFTER                          | CH&POLY or POLY-AFTER | CH&POLY or POLY-AFTER                            | CH&POLY or POLY-AFTER |
| <b>PATCH COMMON PARAMETER</b> |  |                       |  |                       |
| EFX Control Source 1/2        | ---  | ---                   | AFTERTOUCH                                       | SYS-CTRL 1/2          |
| EFX Control Depth 1/2         | ---  | ---                   | Other than 0                                     | Other than 0          |
| Patch Control Source 1/2/3    | AFTERTOUCH                                     | SYS-CTRL1/2           | ---  | ---                   |
| <b>PATCH TONE PARAMETER</b>   |  |                       |  |                       |
| Ctrl 1/2/3 Dest.1/2/3/4       | Other than OFF                                 | Other than OFF        | ---  | ---                   |
| Ctrl 1/2/3 Depth1/2/3/4       | ---  | ---                   | ---  | ---                   |

---:Need not be set

## 2. Performance Mode

| Parameters to be set                | Tone parameters can be controlled |                       | Effect parameters can be controlled in real-time |                       |                       |                       |
|-------------------------------------|-----------------------------------|-----------------------|--|-----------------------|-----------------------|-----------------------|
|                                     | Setting1                          | Setting2              | Setting1   | Setting2              | Setting3              | Setting4              |
| <b>SYSTEM PARAMETER</b>             |                                   |                       |  |                       |                       |                       |
| System Control Source 1/2           | --                                | AFTERTOUC             | --   | --                    | AFTERTOUC             | AFTERTOUC             |
| Receive Aftertouch                  | ON                                | ON                    | ON   | ON                    | ON                    | ON                    |
| Aftertouch Source                   | CH&POLY or POLY-AFTER             | CH&POLY or POLY-AFTER | CH&POLY or POLY-AFTER                            | CH&POLY or POLY-AFTER | CH&POLY or POLY-AFTER | CH&POLY or POLY-AFTER |
| <b>PERFORMANCE COMMON PARAMETER</b> |                                   |                       |  |                       |                       |                       |
| EFX Source                          | --                                | --                    | 1 - 16   | PERFORM               | 1 - 16                | PERFORM               |
| EFX Control Source 1/2              | --                                | --                    | --   | AFTERTOUC             | --                    | SYS-CTRL1/2           |
| EFX Control Depth 1/2               | --                                | --                    | --   | Other than 0          | --                    | Other than 0          |
| <b>PERFORMANCE PART PARAMETER</b>   |                                   |                       |  |                       |                       |                       |
| MIDI Receive Switch                 | ON                                | ON                    | ON   | ON                    | ON                    | ON                    |
| <b>PATCH COMMON PARAMETER</b>       |                                   |                       |  |                       |                       |                       |
| EFX Control Source 1/2              | --                                | --                    | AFTERTOUC  | --                    | SYS-CTRL1/2           | --                    |
| EFX Control Depth 1/2               | --                                | --                    | Other than 0                                     | --                    | Other than 0          | --                    |
| Patch Control Source 1/2/3          | AFTERTOUC                         | SYS-CTRL1/2           | --   | --                    | --                    | --                    |
| <b>PATCH TONE PARAMETER</b>         |                                   |                       |  |                       |                       |                       |
| Ctrl 1/2/3 Dest.1/2/3/4             | Other than OFF                    | Other than OFF        | --   | --                    | --                    | --                    |
| Ctrl 1/2/3 Depth1/2/3/4             | Other than 0                      | Other than 0          | --   | --                    | --                    | --                    |

--:Need not be set

### ● Control Change

#### ○ Bank select (MSB/LSB)

| Status | Second | Third |
|--------|--------|-------|
| BnH    | 00H    | nnH   |
| BnH    | 20H    | 11H   |

n = MIDI channel number : 0H - FH ( 0 - 15 ) 0 = ch.1 15 = ch.16  
 nn = Upper bytes of bank number: 50H - 54H ( 80 - 84 )  
 11 = Lower bytes of bank number: 00H - 07H ( 0 - 7 )

#### 1. Patch Mode

| Parameters to be set          |    | Changes Banks upon receiving program change | Tone parameters can be controlled in real-time | Effect parameters can be controlled in real-time |
|-------------------------------|----|---|--|--|
|                               |    |   |  |  |
| <b>SYSTEM PARAMETER</b>       |    |   |  |  |
| System Control Source 1/2     | -- |   | CC0: BANK-SEL                                  | CC0: BANK-SEL                                    |
| Receive Bank Select           | ON | ON  | ON   | ON   |
| <b>PATCH COMMON PARAMETER</b> |    |   |  |  |
| EFX Control Source 1/2        | -- | --  | SYS-CTRL1/2                                    |  |
| EFX Control Depth 1/2         | -- | --  | Other than 0                                   |  |
| Patch Control Source 1/2/3    | -- | SYS-CTRL1/2                                 |  |  |
| <b>PATCH TONE PARAMETER</b>   |    |   |  |  |
| Ctrl 1/2/3 Dest.1/2/3/4       | -- | Other than OFF                              | --   |  |
| Ctrl 1/2/3 Depth1/2/3/4       | -- | Other than 0                                | --   |  |

--:Need not be set

\* Bank select and corresponding media are as follows:

| Bank Select | Program Change | Media                             | (Patch Number) |
|-------------|----------------|-----------------------------------|----------------|
| MSB   LSB   |                |                                   |                |
| 80   0      | 0 - 127        | User                              | (#1 - #128)    |
| 81   0      | 0 - 127        | Preset A                          | (#1 - #128)    |
| 81   1      | 0 - 127        | Preset B                          | (#1 - #128)    |
| 81   2      | 0 - 127        | Preset C                          | (#1 - #128)    |
| 81   3      | 0 - 127        | Preset D(General MIDI Instrument) | (#1 - #128)    |
| 82   0      | 0 - 127        | Data Card                         | (#1 - #128)    |
| 83   0      | 0 - 127        | PCM Card                          | (#1 - #128)    |
| 84   0      | 0 - 127        | Expansion A                       | (#1 - #128)    |
| 84   1      | 0 - 127        | Expansion A                       | (#129-#256)    |
| 84   2      | 0 - 127        | Expansion B                       | (#1 - #128)    |
| 84   3      | 0 - 127        | Expansion B                       | (#129-#256)    |
| 84   4      | 0 - 127        | Expansion C                       | (#1 - #128)    |
| 84   5      | 0 - 127        | Expansion C                       | (#129-#256)    |
| 84   6      | 0 - 127        | Expansion D                       | (#1 - #128)    |
| 84   7      | 0 - 127        | Expansion D                       | (#129-#256)    |

| Bank Select | Program Change | Media                             | (Rhythm Set Number) |
|-------------|----------------|-----------------------------------|---------------------|
| MSB   LSB   |                |                                   |                     |
| 80   0      | 0 - 1          | User                              | (#1 - #2)           |
| 81   0      | 0 - 1          | Preset A                          | (#1 - #2)           |
| 81   1      | 0 - 1          | Preset B                          | (#1 - #2)           |
| 81   2      | 0 - 1          | Preset C                          | (#1 - #2)           |
| 81   3      | 0 - 1          | Preset D(General MIDI Instrument) | (#1 - #2)           |
| 82   0      | 0 - 1          | Data Card                         | (#1 - #2)           |
| 83   0      | 0 - 127        | PCM Card                          | (#1 - #128)         |
| 84   0      | 0 - 127        | Expansion A                       | (#1 - #128)         |
| 84   1      | 0 - 127        | Expansion A                       | (#129-#256)         |
| 84   2      | 0 - 127        | Expansion B                       | (#1 - #128)         |
| 84   3      | 0 - 127        | Expansion B                       | (#129-#256)         |
| 84   4      | 0 - 127        | Expansion C                       | (#1 - #128)         |
| 84   5      | 0 - 127        | Expansion C                       | (#129-#256)         |
| 84   6      | 0 - 127        | Expansion D                       | (#1 - #128)         |
| 84   7      | 0 - 127        | Expansion D                       | (#129-#256)         |

## 2. Performance Mode

| Parameters to be set                | Changes Banks upon receiving the next program change | Tone parameters can be controlled in real-time | Effect parameters can be controlled in real-time |                 |
|-------------------------------------|--|--|--|-----------------|
|                                     |  |  | Setting1   | Setting2        |
| <b>SYSTEM PARAMETER</b>             |  |  |  |                 |
| System Control Source 1/2           | --   | CC0:BANK SELECT                                | CC0:BANK SELECT                                  | CC0:BANK SELECT |
| Receive Bank Select                 | ON   | ON   | ON   | ON              |
| <b>PERFORMANCE COMMON PARAMETER</b> |  |  |  |                 |
| EFX Source                          | --   | --   | 1 - 16   | PERFORM         |
| EFX Control Source 1/2              | --   | --   | --   | SYS-CTRL1/2     |
| EFX Control Depth 1/2               | --   | --   | --   | Other than 0    |
| <b>PERFORMANCE PART PARAMETER</b>   |  |  |  |                 |
| MIDI Receive Switch                 | ON   | ON   | ON   | ON              |
| <b>PATCH COMMON PARAMETER</b>       |  |  |  |                 |
| EFX Control Source 1/2              | --   | --   | SYS-CTRL1/2                                      | --              |
| EFX Control Depth 1/2               | --   | --   | Other than 0                                     | --              |
| Patch Control Source 1/2/3          | --   | SYS-CTRL1/2                                    | --   | --              |
| <b>PATCH TONE PARAMETER</b>         |  |  |  |                 |
| Ctrl 1/2/3 Dest.1/2/3/4             | --   | Other than OFF                                 | --   | --              |
| Ctrl 1/2/3 Depth1/2/3/4             | --   | Other than 0                                   | --   | --              |

--:Need not be set

\* Bank select and corresponding media are as shown below.

| Bank Select |     | Program Change | Media     | (Performance Number) |
|-------------|-----|----------------|-----------|----------------------|
| MSB         | LSB |                |           |                      |
| 80          | 0   | 0 - 31         | User      | (#1 - #32)           |
| 81          | 0   | 0 - 31         | Preset A  | (#1 - #32)           |
| 81          | 1   | 0 - 31         | Preset B  | (#1 - #32)           |
| 82          | 0   | 0 - 31         | Data Card | (#1 - #32)           |

## Modulation

| Status | Second | Third |
|--------|--------|-------|
| BnH    | 01H    | vvH   |

n = MIDI channel number: 0H - FH ( 0 - 15 ) 0 = ch.1 15 = ch.16  
 vv = Modulation depth : 00H - 7FH ( 0 - 127 )

### 1. Patch Mode

| Parameters to be set          | Setting1       | Setting2       | Effect parameters can be controlled in real-time |                |
|-------------------------------|----------------|----------------|--|----------------|
|                               |                |                | Setting1   | Setting2       |
| <b>SYSTEM PARAMETER</b>       |                |                |  |                |
| System Control Source 1/2     | --             | CC1:MODULATION | --   | CC1:MODULATION |
| Receive Modulation            | ON             | ON             | ON   | ON             |
| <b>PATCH COMMON PARAMETER</b> |                |                |  |                |
| EFX Control Source 1/2        | --             | --             | MODULATION                                       | SYS-CTRL1/2    |
| EFX Control Depth 1/2         | --             | --             | Other than 0                                     | Other than 0   |
| Patch Control Source 1/2/3    | MODULATION     | SYS-CTRL1/2    | --   | --             |
| <b>PATCH TONE PARAMETER</b>   |                |                |  |                |
| Ctrl 1/2/3 Dest.1/2/3/4       | Other than OFF | Other than OFF | --   | --             |
| Ctrl 1/2/3 Depth1/2/3/4       | Other than 0   | Other than 0   | --   | --             |

--:Need not be set

### 2. Performance Mode

| Parameters to be set                | Tone parameters can be controlled in real-time |                | Effect parameters can be controlled in real-time |              |                |                |
|-------------------------------------|--|----------------|--|--------------|----------------|----------------|
|                                     | Setting1                                       | Setting2       | Setting1   | Setting2     | Setting3       | Setting4       |
| <b>SYSTEM PARAMETER</b>             |  |                |  |              |                |                |
| System Control Source 1/2           | --   | CC1:MODULATION | --   | --           | CC1:MODULATION | CC1:MODULATION |
| Receive Modulation                  | ON   | ON             | ON   | ON           | ON             | ON             |
| <b>PERFORMANCE COMMON PARAMETER</b> |  |                |  |              |                |                |
| EFX Source                          | --   | --             | 1 - 16   | PERFORM      | 1 - 16         | PERFORM        |
| EFX Control Source 1/2              | --   | --             | --   | MODULATION   | --             | SYS-CTRL1/2    |
| EFX Control Depth 1/2               | --   | --             | --   | Other than 0 | --             | Other than 0   |
| <b>PERFORMANCE PART PARAMETER</b>   |  |                |  |              |                |                |
| MIDI Receive Switch                 | ON   | ON             | ON   | ON           | ON             | ON             |
| <b>PATCH COMMON PARAMETER</b>       |  |                |  |              |                |                |
| EFX Control Source 1/2              | --   | --             | MODULATION                                       | --           | SYS-CTRL1/2    | --             |
| EFX Control Depth 1/2               | --   | --             | Other than 0                                     | --           | Other than 0   | --             |
| Patch Control Source 1/2/3          | MODULATION                                     | SYS-CTRL1/2    | --   | --           | --             | --             |
| <b>PATCH TONE PARAMETER</b>         |  |                |  |              |                |                |
| Ctrl 1/2/3 Dest.1/2/3/4             | Other than OFF                                 | Other than OFF | --   | --           | --             | --             |
| Ctrl 1/2/3 Depth1/2/3/4             | Other than 0                                   | Other than 0   | --   | --           | --             | --             |

--:Need not be set

## Breath

### Breath

| Status | Second | Third |
|--------|--------|-------|
| BnH    | 02H    | vvH   |

n = MIDI channel number: 0H - FH ( 0 - 15 ) 0 = ch.1 15 = ch.16  
 vv = Breath : 00H - 7FH ( 0 - 127 )

### 1. Patch Mode

| Parameters to be set          | Tone parameters can be controlled in real-time |                | Effect parameters can be controlled in real-time |              |
|-------------------------------|--|----------------|--|--------------|
|                               | Setting1                                       | Setting2       | Setting1   | Setting2     |
| <b>SYSTEM PARAMETER</b>       |  |                |  |              |
| System Control Source 1/2     | --   | CC2:BREATH     | --   | CC2:BREATH   |
| Receive Control Change        | ON   | ON             | ON   | ON           |
| <b>PATCH COMMON PARAMETER</b> |  |                |  |              |
| EFX Control Source 1/2        | --   | --             | BREATH   | SYS-CTRL1/2  |
| EFX Control Depth 1/2         | --   | --             | Other than 0                                     | Other than 0 |
| Patch Control Source 1/2/3    | BREATH   | SYS-CTRL1/2    | --   | --           |
| <b>PATCH TONE PARAMETER</b>   |  |                |  |              |
| Ctrl 1/2/3 Dest.1/2/3/4       | Other than OFF                                 | Other than OFF | --   | --           |
| Ctrl 1/2/3 Depth1/2/3/4       | Other than 0                                   | Other than 0   | --   | --           |

--:Need not be set

### 2. Performance Mode

| Parameters to be set                | Tone parameters can be controlled in real-time |                | Effect parameters can be controlled in real-time |              |              |              |
|-------------------------------------|--|----------------|--|--------------|--------------|--------------|
|                                     | Setting1                                       | Setting2       | Setting1   | Setting2     | Setting3     | Setting4     |
| <b>SYSTEM PARAMETER</b>             |  |                |  |              |              |              |
| System Control Source 1/2           | --   | CC2:BREATH     | --   | --           | CC2:BREATH   | CC2:BREATH   |
| Receive Control Change              | ON   | ON             | ON   | ON           | ON           | ON           |
| <b>PERFORMANCE COMMON PARAMETER</b> |  |                |  |              |              |              |
| EFX Source                          | --   | --             | 1 - 16   | PERFORM      | 1 - 16       | PERFORM      |
| EFX Control Source 1/2              | --   | --             | --   | BREATH       | --           | SYS-CTRL1/2  |
| EFX Control Depth 1/2               | --   | --             | --   | Other than 0 | --           | Other than 0 |
| <b>PERFORMANCE PART PARAMETER</b>   |  |                |  |              |              |              |
| MIDI Receive Switch                 | ON   | ON             | ON   | ON           | ON           | ON           |
| <b>PATCH COMMON PARAMETER</b>       |  |                |  |              |              |              |
| EFX Control Source 1/2              | --   | --             | BREATH   | --           | SYS-CTRL1/2  | --           |
| EFX Control Depth 1/2               | --   | --             | Other than 0                                     | --           | Other than 0 | --           |
| Patch Control Source 1/2/3          | BREATH   | SYS-CTRL1/2    | --   | --           | --           | --           |
| <b>PATCH TONE PARAMETER</b>         |  |                |  |              |              |              |
| Ctrl 1/2/3 Dest.1/2/3/4             | Other than OFF                                 | Other than OFF | --   | --           | --           | --           |
| Ctrl 1/2/3 Depth1/2/3/4             | Other than 0                                   | Other than 0   | --   | --           | --           | --           |

--:Need not be set

### ○ Foot type

Status      Second      Third

BnH          04H          vvH

n = MIDI channel number: 0H - FH ( 0 - 15 ) 0 = ch.1 15 = ch.16  
 vv = Foot control          : 00H - 7FH ( 0 - 127 )

### 1. Patch Mode

| Parameters to be set          | Tone parameters can be controlled in real-time |                | Effect parameters can be controlled in real-time |               |
|-------------------------------|--|----------------|--|---------------|
|                               | Setting1                                       | Setting2       | Setting1   | Setting2      |
| <b>SYSTEM PARAMETER</b>       |  |                |  |               |
| System Control Source 1/2     | --   | CC4:FOOT-TYPE  | --   | CC4:FOOT-TYPE |
| Receive Control Change        | ON   | ON             | ON   | ON            |
| <b>PATCH COMMON PARAMETER</b> |  |                |  |               |
| EFX Control Source 1/2        | --   | --             | FOOT   | SYS-CTRL1/2   |
| EFX Control Depth 1/2         | --   | --             | Other than 0                                     | Other than 0  |
| Patch Control Source 1/2/3    | FOOT   | SYS-CTRL1/2    | --   | --            |
| <b>PATCH TONE PARAMETER</b>   |  |                |  |               |
| Ctrl 1/2/3 Dest.1/2/3/4       | Other than OFF                                 | Other than OFF | --   | --            |
| Ctrl 1/2/3 Depth1/2/3/4       | Other than 0                                   | Other than 0   | --   | --            |

--:Need not be set

### 2. Performance Mode

| Parameters to be set                | Tone parameters can be controlled in real-time |                | Effect parameters can be controlled in real-time |              |               |               |
|-------------------------------------|--|----------------|--|--------------|---------------|---------------|
|                                     | Setting1                                       | Setting2       | Setting1   | Setting2     | Setting3      | Setting4      |
| <b>SYSTEM PARAMETER</b>             |  |                |  |              |               |               |
| System Control Source 1/2           | --   | CC4:FOOT-TYPE  | --   | --           | CC4:FOOT-TYPE | CC4:FOOT-TYPE |
| Receive Control Change              | ON   | ON             | ON   | ON           | ON            | ON            |
| <b>PERFORMANCE COMMON PARAMETER</b> |  |                |  |              |               |               |
| EFX Source                          | --   | --             | 1 - 16   | PERFORM      | 1 - 16        | PERFORM       |
| EFX Control Source 1/2              | --   | --             | --   | FOOT         | --            | SYS-CTRL1/2   |
| EFX Control Depth 1/2               | --   | --             | --   | Other than 0 | --            | Other than 0  |
| <b>PERFORMANCE PART PARAMETER</b>   |  |                |  |              |               |               |
| MIDI Receive Switch                 | ON   | ON             | ON   | ON           | ON            | ON            |
| <b>PATCH COMMON PARAMETER</b>       |  |                |  |              |               |               |
| EFX Control Source 1/2              | --   | --             | FOOT   | --           | SYS-CTRL1/2   | --            |
| EFX Control Depth 1/2               | --   | --             | Other than 0                                     | --           | Other than 0  | --            |
| Patch Control Source 1/2/3          | FOOT   | SYS-CTRL1/2    | --   | --           | --            | --            |
| <b>PATCH TONE PARAMETER</b>         |  |                |  |              |               |               |
| Ctrl 1/2/3 Dest.1/2/3/4             | Other than OFF                                 | Other than OFF | --   | --           | --            | --            |
| Ctrl 1/2/3 Depth1/2/3/4             | Other than 0                                   | Other than 0   | --   | --           | --            | --            |

--:Need not be set

○ Portamento time

Status      Second      Third  
-----  
BnH          05H          vvH

n = MIDI channel number: 0H - FH ( 0 - 15 ) 0 = ch.1 15 = ch.16  
vv = Portamento time : 00H - 7FH ( 0 - 127 )

1. Patch Mode

| Parameters to be set       | Portamento time of patch common parameter will be changed | Tone parameters can be controlled in real-time | Effect parameters can be controlled in real-time |
|----------------------------|---|--|--|
| SYSTEM PARAMETER           |   |  |  |
| System Control Source 1/2  | --  | ICC5:PORT-TIME                                 | ICC5:PORT-TIME                                   |
| Receive Control Change     | ON  | ON   | ON   |
| PATCH COMMON PARAMETER     |   |  |  |
| EFX Control Source 1/2     | --  | --   | SYS-CTRL1/2                                      |
| EFX Control Depth 1/2      | --  | --   | Other than 0                                     |
| Patch Control Source 1/2/3 | --  | SYS-CTRL1/2                                    | --   |
| PATCH TONE PARAMETER       |   |  |  |
| Ctrl 1/2/3 Dest.1/2/3/4    | --  | Other than OFF                                 | --   |
| Ctrl 1/2/3 Depth1/2/3/4    | --  | Other than 0                                   | --   |

--:Need not be set

2. Performance Mode

| Parameters to be set         | Portamento time of patch common parameter of the part on the receiving channel will be changed | Tone parameters can be controlled in real-time | Effect parameters can be controlled in real-time | Setting1       | Setting2       |
|------------------------------|--|--|--|----------------|----------------|
| SYSTEM PARAMETER             |  |  |  |                |                |
| System Control Source 1/2    | --   | ICC5:PORT-TIME                                 | ICC5:PORT-TIME                                   | ICC5:PORT-TIME | ICC5:PORT-TIME |
| Receive Control Change       | ON   | ON   | ON   | ON             | ON             |
| PERFORMANCE COMMON PARAMETER |  |  |  |                |                |
| EFX Source                   | --   | --   | 1 - 16   | PERFORM        | PERFORM        |
| EFX Control Source 1/2       | --   | --   | --   | SYS-CTRL1/2    | SYS-CTRL1/2    |
| EFX Control Depth 1/2        | --   | --   | --   | Other than 0   | Other than 0   |
| PERFORMANCE PART PARAMETER   |  |  |  |                |                |
| MIDI Receive Switch          | ON   | ON   | ON   | ON             | ON             |
| PATCH COMMON PARAMETER       |  |  |  |                |                |
| EFX Control Source 1/2       | --   | --   | SYS-CTRL1/2                                      | --             | --             |
| EFX Control Depth 1/2        | --   | --   | Other than 0                                     | --             | --             |
| Patch Control Source 1/2/3   | --   | SYS-CTRL1/2                                    | --   | --             | --             |
| PATCH TONE PARAMETER         |  |  |  |                |                |
| Ctrl 1/2/3 Dest.1/2/3/4      | --   | Other than OFF                                 | --   | --             | --             |
| Ctrl 1/2/3 Depth1/2/3/4      | --   | Other than 0                                   | --   | --             | --             |

--:Need not be set

○ Volume

Status      Second      Third  
-----  
BnH          07H          vvH

n = MIDI channel number: 0H - 7FH ( 0 - 15 ) 0 = ch.1 15 = ch.16  
vv = Volume : 00H - 7FH ( 0 - 127 )

1. Patch Mode

| Parameters to be set       | Level of tone will be changed | Tone parameters can be controlled in real-time | Effect parameters can be controlled in real-time | Setting1     | Setting2     |
|----------------------------|-------------------------------|--|--|--------------|--------------|
| SYSTEM PARAMETER           |                               |  |  |              |              |
| System Control Source 1/2  | --                            | --   | ICC7:VOLUME                                      | --           | ICC7:VOLUME  |
| Receive Volume             | ON                            | ON   | ON   | ON           | ON           |
| PATCH COMMON PARAMETER     |                               |  |  |              |              |
| EFX Control Source 1/2     | --                            | --   | VOLUME   | SYS-CTRL1/2  | SYS-CTRL1/2  |
| EFX Control Depth 1/2      | --                            | --   | Other than 0                                     | Other than 0 | Other than 0 |
| Patch Control Source 1/2/3 | --                            | VOLUME   | SYS-CTRL1/2                                      | --           | --           |
| PATCH TONE PARAMETER       |                               |  |  |              |              |
| Volume Control Switch      | ON                            | --   | --   | --           | --           |
| Ctrl 1/2/3 Dest.1/2/3/4    | --                            | Other than OFF                                 | Other than OFF                                   | --           | --           |
| Ctrl 1/2/3 Depth1/2/3/4    | --                            | Other than 0                                   | Other than 0                                     | --           | --           |

--:Need not be set



**2. Performance Mode**

| Parameters to be set                | Tone level of part on the receiving channel will be changed | Tone parameters can be controlled in real-time | Setting1       | Setting2       | Effect parameters can be controlled in real-time | Setting1   | Setting2   | Setting3     | Setting4     |
|-------------------------------------|---|--|----------------|----------------|--|------------|------------|--------------|--------------|
| <b>SYSTEM PARAMETER</b>             |   |  |                |                |  |            |            |              |              |
| System Control Source 1/2           | --  | --   | CC7:VOLUME     | --             | --   | CC7:VOLUME | CC7:VOLUME | CC7:VOLUME   | CC7:VOLUME   |
| Receive Volume                      | ON  | ON   | ON             | ON             | ON   | ON         | ON         | ON           | ON           |
| <b>PERFORMANCE COMMON PARAMETER</b> |   |  |                |                |  |            |            |              |              |
| EFX Source                          | --  | --   | --             | --             | 11 - 16  | PERFORM    | 11 - 16    | PERFORM      | PERFORM      |
| EFX Control Source 1/2              | --  | --   | --             | --             | VOLUME   | --         | --         | SYS-CTRL1/2  | SYS-CTRL1/2  |
| EFX Control Depth 1/2               | --  | --   | --             | --             | Other than 0                                     | --         | --         | Other than 0 | Other than 0 |
| <b>PERFORMANCE PART PARAMETER</b>   |   |  |                |                |  |            |            |              |              |
| MIDI Receive Switch                 | ON  | ON   | ON             | ON             | ON   | ON         | ON         | ON           | ON           |
| Receive Volume                      | ON  | ON   | ON             | ON             | ON   | ON         | ON         | ON           | ON           |
| <b>PATCH COMMON PARAMETER</b>       |   |  |                |                |  |            |            |              |              |
| EFX Control Source 1/2              | --  | --   | --             | --             | VOLUME   | --         | --         | SYS-CTRL1/2  | --           |
| EFX Control Depth 1/2               | --  | --   | --             | --             | Other than 0                                     | --         | --         | Other than 0 | --           |
| Patch Control Source 1/2/3          | --  | --   | VOLUME         | SYS-CTRL1/2    | --   | --         | --         | --           | --           |
| <b>PATCH TONE PARAMETER</b>         |   |  |                |                |  |            |            |              |              |
| Volume Control Switch               | ON  | --   | --             | --             | --   | --         | --         | --           | --           |
| Ctrl 1/2/3 Dest.1/2/3/4             | --  | Other than OFF                                 | Other than OFF | Other than OFF | --   | --         | --         | --           | --           |
| Ctrl 1/2/3 Depth1/2/3/4             | --  | Other than 0                                   | Other than 0   | Other than 0   | --   | --         | --         | --           | --           |

--:Need not be set

**○ Pan**

| Status | Second | Third |
|--------|--------|-------|
| BnH    | 0AH    | vvH   |

n = MIDI channel number: 0H - FH ( 0 - 15 ) 0 = ch.1 15 = ch.16  
 vv = Pan : 00H - 7FH ( 0 - 127 )

**1. Patch Mode**

| Parameters to be set          | Directional localization of tone can be controlled in 128 steps with 10 the leftmost, 164 at the center, 127 the rightmost | Tone parameters can be controlled in real-time | Setting1       | Setting2       | EFX parameters can be controlled in real-time | Setting1     | Setting2     |
|-------------------------------|--|--|----------------|----------------|---|--------------|--------------|
| <b>SYSTEM PARAMETER</b>       |  |  |                |                |   |              |              |
| System Control Source 1/2     | --   | --   | CC10:PANPOT    | --             | CC10:PANPOT                                   | CC10:PANPOT  | CC10:PANPOT  |
| Receive Control Change        | ON   | ON   | ON             | ON             | ON  | ON           | ON           |
| <b>PATCH COMMON PARAMETER</b> |  |  |                |                |   |              |              |
| EFX Control Source 1/2        | --   | --   | --             | --             | PAN   | SYS-CTRL1/2  | SYS-CTRL1/2  |
| EFX Control Depth 1/2         | --   | --   | --             | --             | Other than 0                                  | Other than 0 | Other than 0 |
| Patch Control Source 1/2/3    | --   | --   | PAN            | SYS-CTRL1/2    | --  | --           | --           |
| <b>PATCH TONE PARAMETER</b>   |  |  |                |                |   |              |              |
| Pan Control Switch            | CONT, KEY-ON   | --   | --             | --             | --  | --           | --           |
| Ctrl 1/2/3 Dest.1/2/3/4       | --   | Other than OFF                                 | Other than OFF | Other than OFF | --  | --           | --           |
| Ctrl 1/2/3 Depth1/2/3/4       | --   | Other than 0                                   | Other than 0   | Other than 0   | --  | --           | --           |

--:Need not be set

**2. Performance Mode**

| Parameters to be set                | Directional localization of tone of the part on the receiving channel can be controlled in 128 steps with 10 the leftmost, 164 at the center, 127 the rightmost | Tone parameters can be controlled in real-time | Setting1       | Setting2       | Effect parameters can be controlled in real-time | Setting1    | Setting2    | Setting3     | Setting4     |
|-------------------------------------|---|--|----------------|----------------|--|-------------|-------------|--------------|--------------|
| <b>SYSTEM PARAMETER</b>             |   |  |                |                |  |             |             |              |              |
| System Control Source 1/2           | --  | --   | CC10:PANPOT    | --             | CC10:PANPOT                                      | CC10:PANPOT | CC10:PANPOT | CC10:PANPOT  | CC10:PANPOT  |
| Receive Control Change              | ON  | ON   | ON             | ON             | ON   | ON          | ON          | ON           | ON           |
| <b>PERFORMANCE COMMON PARAMETER</b> |   |  |                |                |  |             |             |              |              |
| EFX Source                          | --  | --   | --             | --             | 11 - 16  | PERFORM     | 11 - 16     | PERFORM      | PERFORM      |
| EFX Control Source 1/2              | --  | --   | --             | --             | PAN  | --          | --          | SYS-CTRL1/2  | SYS-CTRL1/2  |
| EFX Control Depth 1/2               | --  | --   | --             | --             | Other than 0                                     | --          | --          | Other than 0 | Other than 0 |
| <b>PERFORMANCE PART PARAMETER</b>   |   |  |                |                |  |             |             |              |              |
| MIDI Receive Switch                 | ON  | ON   | ON             | ON             | ON   | ON          | ON          | ON           | ON           |
| <b>PATCH COMMON PARAMETER</b>       |   |  |                |                |  |             |             |              |              |
| EFX Control Source 1/2              | --  | --   | --             | --             | PAN  | --          | --          | SYS-CTRL1/2  | --           |
| EFX Control Depth 1/2               | --  | --   | --             | --             | Other than 0                                     | --          | --          | Other than 0 | --           |
| Patch Control Source 1/2/3          | --  | --   | PAN            | SYS-CTRL1/2    | --   | --          | --          | --           | --           |
| <b>PATCH TONE PARAMETER</b>         |   |  |                |                |  |             |             |              |              |
| Pan Control Switch                  | KEY-ON, CONT  | --   | --             | --             | --   | --          | --          | --           | --           |
| Ctrl 1/2/3 Dest.1/2/3/4             | --  | Other than OFF                                 | Other than OFF | Other than OFF | --   | --          | --          | --           | --           |
| Ctrl 1/2/3 Depth1/2/3/4             | --  | Other than 0                                   | Other than 0   | Other than 0   | --   | --          | --          | --           | --           |

--:Need not be set

○ Expression

Status      Second      Third  
 -----  
 BnH      0BH      vvH

n = MIDI channel number: 0H - FH ( 0 - 15 ) 0 = ch.1 15 = ch.16  
 vv = Expression      : 00H - 7FH ( 1 - 127 )

1. Patch Mode

| Parameters to be set          | Level of tone will be changed | Tone parameters can be controlled in real-time |                 | Effect parameters can be controlled in real-time |                 |
|-------------------------------|-------------------------------|--|-----------------|--|-----------------|
|                               |                               | Setting1                                       | Setting2        | Setting1   | Setting2        |
| <b>SYSTEM PARAMETER</b>       |                               |  |                 |  |                 |
| System Control Source 1/2     | --                            | --   | CC11:EXPRESSION | --   | CC11:EXPRESSION |
| Receive Control Change        | ON                            | ON   | ON              | ON   | ON              |
| Volume Control Source         | VOL&EXP                       | --   | --              | --   | --              |
| <b>PATCH COMMON PARAMETER</b> |                               |  |                 |  |                 |
| EFX Control Source 1/2        | --                            | --   | --              | EXPRESSION                                       | SYS-CTRL1/2     |
| EFX Control Depth 1/2         | --                            | --   | --              | Other than 0                                     | Other than 0    |
| Patch Control Source 1/2/3    | --                            | EXPRESSION                                     | SYS-CTRL1/2     | --   | --              |
| <b>PATCH TONE PARAMETER</b>   |                               |  |                 |  |                 |
| Volume Control Switch         | ON                            | --   | --              | --   | --              |
| Ctrl 1/2/3 Dest.1/2/3/4       | --                            | Other than OFF                                 | Other than OFF  | --   | --              |
| Ctrl 1/2/3 Depth1/2/3/4       | --                            | Other than 0                                   | Other than 0    | --   | --              |

--:Need not be set

2. Performance Mode

| Parameters to be set                | Level of tone of the part on the receiving channel will be changed | Tone parameters can be controlled in real-time |                 | Effect parameters can be controlled in real-time |              |                 |                 |
|-------------------------------------|--|--|-----------------|--|--------------|-----------------|-----------------|
|                                     |  | Setting1                                       | Setting2        | Setting1   | Setting2     | Setting3        | Setting4        |
| <b>SYSTEM PARAMETER</b>             |  |  |                 |  |              |                 |                 |
| System Control Source 1/2           | --   | --   | CC11:EXPRESSION | --   | --           | CC11:EXPRESSION | CC11:EXPRESSION |
| Receive Control Change              | ON   | ON   | ON              | ON   | ON           | ON              | ON              |
| Volume Control Source               | VOL&EXP  | --   | --              | --   | --           | --              | --              |
| <b>PERFORMANCE COMMON PARAMETER</b> |  |  |                 |  |              |                 |                 |
| EFX Source                          | --   | --   | --              | 1 - 16   | PERFORM      | 1 - 16          | PERFORM         |
| EFX Control Source 1/2              | --   | --   | --              | --   | EXPRESSION   | --              | --              |
| EFX Control Depth 1/2               | --   | --   | --              | --   | Other than 0 | --              | Other than 0    |
| <b>PERFORMANCE PART PARAMETER</b>   |  |  |                 |  |              |                 |                 |
| MIDI Receive Switch                 | ON   | ON   | ON              | ON   | ON           | ON              | ON              |
| <b>PATCH COMMON PARAMETER</b>       |  |  |                 |  |              |                 |                 |
| EFX Control Source 1/2              | --   | --   | --              | EXPRESSION                                       | --           | SYS-CTRL1/2     | --              |
| EFX Control Depth 1/2               | --   | --   | --              | Other than 0                                     | --           | Other than 0    | --              |
| Patch Control Source 1/2/3          | --   | EXPRESSION                                     | SYS-CTRL1/2     | --   | --           | --              | --              |
| <b>PATCH TONE PARAMETER</b>         |  |  |                 |  |              |                 |                 |
| Volume Control Switch               | ON   | --   | --              | --   | --           | --              | --              |
| Ctrl 1/2/3 Dest.1/2/3/4             | --   | Other than OFF                                 | Other than OFF  | --   | --           | --              | --              |
| Ctrl 1/2/3 Depth1/2/3/4             | --   | Other than 0                                   | Other than 0    | --   | --           | --              | --              |

--:Need not be set

○ Hold 1

Status      Second      Third  
 -----  
 BnH      40H      vvH

n = MIDI channel number: 0H - FH ( 0 - 15 ) 0 = ch.1 15 = ch.16  
 vv = Control value      : 00H - 7FH ( 0 - 127 ) 0 - 63 = OFF 64 - 127 = ON

1. Patch Mode

| Parameters to be set                          | When HOLD-1 is ON, note is kept on | Tone parameters can be controlled in real-time | Effect parameters can be controlled in real-time | LFO Rate is changed to HOLD-1 ON interval | Tone delay time is changed to the HOLD-1 ON interval | When HOLD-1 is ON, Effect controller is held at its peak level | When HOLD-1 is ON, Tone controller is held at its peak level | When HOLD-1 is ON, Tone controller is held at its peak level |
|---|------------------------------------|--|--|---|--|--|--|--|
|   |                                    |  |  |   |  |  |  |  |
| <b>SYSTEM PARAMETER</b>                       |                                    |  |  |   |  |  |  |  |
| System Control Source 1/2                     | --                                 | CC64:HOLD-1                                    | CC64:HOLD-1                                      | --  | --   | --   | --   | --   |
| Receive Hold-1                                | ON                                 | ON   | ON   | ON  | ON   | ON   | ON   | ON   |
| TAP Control Source                            | --                                 | --   | --   | HOLD-1                                    | HOLD-1   | --   | --   | --   |
| Hold Control Source                           | --                                 | --   | --   | --  | HOLD-1   | HOLD-1   | HOLD-1   | HOLD-1   |
| Peak Control Source                           | --                                 | --   | --   | --  | --   | HOLD-1   | HOLD-1   | HOLD-1   |
| <b>PATCH COMMON PARAMETER</b>                 |                                    |  |  |   |  |  |  |  |
| EFX Control Source 1/2                        | --                                 | --   | SYS CTRL1/2                                      | --  | --   | --   | --   | --   |
| EFX Control Depth 1/2                         | --                                 | --   | Other than 0                                     | --  | --   | --   | --   | --   |
| Patch Control Source 1/2/3                    | --                                 | --   | SYS-CTRL1/2                                      | --  | --   | --   | --   | --   |
| EFX Control Hold/Peak Control 1/2/3 Hold/Peak | --                                 | --   | --   | --  | --   | HOLD   | PEAK   | HOLD   |
| <b>PATCH TONE PARAMETER</b>                   |                                    |  |  |   |  |  |  |  |
| Hold-1 Control Switch                         | ON                                 | --   | --   | --  | --   | --   | --   | --   |
| Ctrl 1/2/3 Dest.1/2/3/4                       | --                                 | Other than OFF                                 | --   | --  | --   | --   | --   | --   |
| Ctrl 1/2/3 Depth1/2/3/4                       | --                                 | Other than 0                                   | --   | --  | --   | --   | --   | --   |
| LFO1/2 External Sync                          | --                                 | --   | --   | TAP                                       | --   | --   | --   | --   |
| Tone Delay Mode                               | --                                 | --   | --   | --  | TAP-SYNC   | --   | --   | --   |

--:Need not be set

## 2. Performance Mode

| Parameters to be set                | When HOLD-1 is ON, note of the part on the receiving channel is held | Tone parameters can be controlled in real-time | Effect parameters can be controlled in real-time |              | LFO Rate is changed to the HOLD-1 ON interval | Tone Delay time is changed to the HOLD-1 ON interval | When HOLD-1 is ON, Effect controller is held | When HOLD-1 is ON, Effect controller is held at its peak level | When HOLD-1 is ON, Tone controller is held | When HOLD-1 is ON, Tone controller is held at its peak level |
|-------------------------------------|--|--|--|--------------|---|--|--|--|--|--|
|                                     |  |  | Setting1   | Setting2     |   |  |  |  |  |  |
| <b>SYSTEM PARAMETER</b>             |  |  |  |              |   |  |  |  |  |  |
| System Control Source 1/2           | --   | CC64:HOLD-1                                    | CC64:HOLD-1                                      | CC64:HOLD-1  | --  | --   | --   | --   | --   | --   |
| Receive Hold-1                      | ON   | ON   | ON   | ON           | ON  | ON   | ON   | ON   | ON   | ON   |
| TAP Control Source                  | --   | --   | --   | --           | HOLD-1  | HOLD-1   | --   | --   | --   | --   |
| Hold Control Source                 | --   | --   | --   | --           | --  | --   | HOLD-1                                       | --   | HOLD-1                                     | --   |
| Peak Control Source                 | --   | --   | --   | --           | --  | --   | HOLD-1                                       | --   | HOLD-1                                     | --   |
| <b>PERFORMANCE COMMON PARAMETER</b> |  |  |  |              |   |  |  |  |  |  |
| EFX Source                          | --   | --   | 11 - 16  | PERFORM      | --  | --   | --   | --   | --   | --   |
| EFX Control Source 1/2              | --   | --   | --   | SYS-CTRL1/2  | --  | --   | --   | --   | --   | --   |
| EFX Control Depth 1/2               | --   | --   | --   | Other than 0 | --  | --   | --   | --   | --   | --   |
| <b>PERFORMANCE PART PARAMETER</b>   |  |  |  |              |   |  |  |  |  |  |
| MIDI Receive Switch                 | ON   | ON   | ON   | ON           | ON  | ON   | ON   | ON   | ON   | ON   |
| <b>PATCH COMMON PARAMETER</b>       |  |  |  |              |   |  |  |  |  |  |
| EFX Control Source 1/2              | --   | --   | --   | SYS-CTRL1/2  | --  | --   | --   | --   | --   | --   |
| EFX Control Depth 1/2               | --   | --   | --   | Other than 0 | --  | --   | --   | --   | --   | --   |
| EFX Control Source 1/2/3            | --   | --   | --   | SYS-CTRL1/2  | --  | --   | --   | --   | --   | --   |
| EFX Control Hold/Peak Control 1/2/3 | --   | --   | --   | --           | --  | --   | HOLD   | PEAK   | HOLD                                       | PEAK   |
| <b>PATCH TONE PARAMETER</b>         |  |  |  |              |   |  |  |  |  |  |
| Hold-1 Control Switch               | ON   | --   | --   | --           | --  | --   | --   | --   | --   | --   |
| Ctrl 1/2/3 Dest.1/2/3/4             | --   | --   | Other than OFF                                   | --           | --  | --   | --   | --   | --   | --   |
| Ctrl 1/2/3 Depth1/2/3/4             | --   | --   | Other than 0                                     | --           | --  | --   | --   | --   | --   | --   |
| LFO1/2 External Sync                | --   | --   | --   | --           | TAP   | --   | --   | --   | --   | --   |
| Tone Delay Mode                     | --   | --   | --   | --           | TAP-SYNC                                      | --   | --   | --   | --   | --   |

--:Need not be set

## ○ Portamento

| Status | Second | Third |
|--------|--------|-------|
| BnH    | 41H    | vvH   |

n = MIDI channel number: 0H - FH ( 0 - 15 ) 0 = ch.1 15 = ch.16  
 vv = Control value : 00H - 7FH ( 0 - 127 ) 0 - 63 = OFF 64 - 127 = ON

### 1. Patch Mode

| Parameters to be set          | Portamento switch of Patch Common parameter is changed its setting | Tone parameters can be controlled in real-time | Effect parameters can be controlled in real-time |                 |
|-------------------------------|--|--|--|-----------------|
|                               |  |  | Setting1   | Setting2        |
| <b>SYSTEM PARAMETER</b>       |  |  |  |                 |
| System Control Source 1/2     | --   | CC65:PORTAMENTO                                | CC65:PORTAMENTO                                  | CC65:PORTAMENTO |
| Receive Control Change        | ON   | ON   | ON   | ON              |
| <b>PATCH COMMON PARAMETER</b> |  |  |  |                 |
| EFX Control Source 1/2        | --   | --   | SYS-CTRL1/2                                      | --              |
| EFX Control Depth 1/2         | --   | --   | Other than 0                                     | --              |
| Patch Control Source 1/2/3    | --   | --   | SYS-CTRL1/2                                      | --              |
| <b>PATCH TONE PARAMETER</b>   |  |  |  |                 |
| Ctrl 1/2/3 Dest.1/2/3/4       | --   | --   | Other than OFF                                   | --              |
| Ctrl 1/2/3 Depth1/2/3/4       | --   | --   | Other than 0                                     | --              |

--:Need not be set

### 2. Performance Mode

| Parameters to be set                | Portamento switch of Patch Common parameter of the part on the receiving channel is changed its setting | Tone parameters can be controlled in real-time | Effect parameters can be controlled in real-time |                 |
|-------------------------------------|---|--|--|-----------------|
|                                     |   |  | Setting1   | Setting2        |
| <b>SYSTEM PARAMETER</b>             |   |  |  |                 |
| System Control Source 1/2           | --  | CC65:PORTAMENTO                                | CC65:PORTAMENTO                                  | CC65:PORTAMENTO |
| Receive Control Change              | ON  | ON   | ON   | ON              |
| <b>PERFORMANCE COMMON PARAMETER</b> |   |  |  |                 |
| EFX Source                          | --  | --   | 11 - 16  | PERFORM         |
| EFX Control Source 1/2              | --  | --   | --   | SYS-CTRL1/2     |
| EFX Control Depth 1/2               | --  | --   | --   | Other than 0    |
| <b>PERFORMANCE PART PARAMETER</b>   |   |  |  |                 |
| MIDI Receive Switch                 | ON  | ON   | ON   | ON              |
| <b>PATCH COMMON PARAMETER</b>       |   |  |  |                 |
| EFX Control Source 1/2              | --  | --   | SYS-CTRL1/2                                      | --              |
| EFX Control Depth 1/2               | --  | --   | Other than 0                                     | --              |
| Patch Control Source 1/2/3          | --  | --   | SYS-CTRL1/2                                      | --              |
| <b>PATCH TONE PARAMETER</b>         |   |  |  |                 |
| Ctrl 1/2/3 Dest.1/2/3/4             | --  | --   | Other than OFF                                   | --              |
| Ctrl 1/2/3 Depth1/2/3/4             | --  | --   | Other than 0                                     | --              |

--:Need not be set

## ○ Sostenuto

| Status | Second | Third |
|--------|--------|-------|
| BnH    | 42H    | vvH   |

n = MIDI channel number: 0H - FH ( 0 - 15 ) 0 = ch.1 15 = ch.16  
 vv = Control value : 00H - 7FH ( 0 - 127 ) 0 - 63 = OFF 64 - 127 = ON

1. Patch Mode

|                            | When SOSTENUTO is ON, MIDI-on mode is held on | Tone parameters can be controlled in real-time | Effect parameters can be controlled in real-time | LFO Rate is changed to the SOSTENUTO ON interval | Tone Delay Time is changed to the SOSTENUTO ON interval | When SOSTENUTO is ON, Effect controller is held | When SOSTENUTO is ON, Effect controller is held at its peak level | When SOSTENUTO is ON, Tone controller is held | When SOSTENUTO is ON, Tone controller is held at its peak level |
|----------------------------|---|--|--|--|---|---|---|---|---|
| Parameters to be set       |   |  |  |  |   |   |   |   |   |
| SYSTEM PARAMETER           |   |  |  |  |   |   |   |   |   |
| System Control Source 1/2  | ---   | CC66:SOSTENUTO                                 | CC66:SOSTENUTO                                   | ---  | ---   | ---   | ---   | ---   | ---   |
| Receive Control Change     | IGN   | IGN  | IGN  | IGN  | IGN   | IGN   | IGN   | IGN   | IGN   |
| TAP Control Source         | ---   | ---  | ---  | SOSTENUTO  | SOSTENUTO   | ---   | ---   | ---   | ---   |
| Hold Control Source        | ---   | ---  | ---  | ---  | ---   | SOSTENUTO                                       | SOSTENUTO   | SOSTENUTO                                     | ---   |
| Peak Control Source        | ---   | ---  | ---  | ---  | ---   | ---   | SOSTENUTO   | ---   | SOSTENUTO   |
| PATCH COMMON PARAMETER     |   |  |  |  |   |   |   |   |   |
| EFX Control Source 1/2     | ---   | ---  | ISYS-CTRL1/2                                     | ---  | ---   | ---   | ---   | ---   | ---   |
| EFX Control Depth 1/2      | ---   | ---  | Other than 0                                     | ---  | ---   | ---   | ---   | ---   | ---   |
| Patch Control Source 1/2/3 | ---   | ---  | ISYS-CTRL1/2                                     | ---  | ---   | ---   | ---   | ---   | ---   |
| EFX Control Hold/Peak      | ---   | ---  | ---  | ---  | ---   | HOLD  | PEAK  | ---   | ---   |
| Control 1/2/3 Hold/Peak    | ---   | ---  | ---  | ---  | ---   | ---   | ---   | HOLD  | PEAK  |
| PATCH TONE PARAMETER       |   |  |  |  |   |   |   |   |   |
| Ctrl 1/2/3 Dest.1/2/3/4    | ---   | Other than OFF                                 | ---  | ---  | ---   | ---   | ---   | ---   | ---   |
| Ctrl 1/2/3 Depth1/2/3/4    | ---   | Other than 0                                   | ---  | ---  | ---   | ---   | ---   | ---   | ---   |
| LFO1/2 External Sync       | ---   | ---  | ---  | TAP  | ---   | ---   | ---   | ---   | ---   |
| Tone Delay Mode            | ---   | ---  | ---  | TAP-SYNC   | ---   | ---   | ---   | ---   | ---   |

---Need not be set

2. Performance Mode

|                              | When SOSTENUTO is ON, MIDI-on mode is held on receiving channel is held | Tone parameters can be controlled in real-time | Effect parameters can be controlled in real-time | LFO Rate is changed to the SOSTENUTO ON interval | Tone Delay Time is changed to the SOSTENUTO ON interval | When SOSTENUTO is ON, Effect controller is held | When SOSTENUTO is ON, Effect controller is held at its peak level | When SOSTENUTO is ON, Tone controller is held | When SOSTENUTO is ON, Tone controller is held at its peak level |
|------------------------------|---|--|--|--|---|---|---|---|---|
| Parameters to be set         | IGN   |  | Setting1   | Setting2   |   |   |   |   |   |
| SYSTEM PARAMETER             |   |  |  |  |   |   |   |   |   |
| System Control Source 1/2    | ---   | CC66:SOSTENUTO                                 | CC66:SOSTENUTO                                   | CC66:SOSTENUTO                                   | ---   | ---   | ---   | ---   | ---   |
| Receive Control Change       | IGN   | IGN  | IGN  | IGN  | IGN   | IGN   | IGN   | IGN   | IGN   |
| TAP Control Source           | ---   | ---  | ---  | SOSTENUTO  | SOSTENUTO   | ---   | ---   | ---   | ---   |
| Hold Control Source          | ---   | ---  | ---  | ---  | ---   | SOSTENUTO                                       | SOSTENUTO   | SOSTENUTO                                     | ---   |
| Peak Control Source          | ---   | ---  | ---  | ---  | ---   | ---   | SOSTENUTO   | ---   | SOSTENUTO   |
| PERFORMANCE COMMON PARAMETER |   |  |  |  |   |   |   |   |   |
| EFX Source                   | ---   | ---  | 11 - 16  | PERFORM  | ---   | ---   | ---   | ---   | ---   |
| EFX Control Source 1/2       | ---   | ---  | ---  | ISYS-CTRL1/2                                     | ---   | ---   | ---   | ---   | ---   |
| EFX Control Depth 1/2        | ---   | ---  | ---  | Other than 0                                     | ---   | ---   | ---   | ---   | ---   |
| PATCH COMMON PARAMETER       |   |  |  |  |   |   |   |   |   |
| EFX Control Source 1/2       | ---   | ---  | ISYS-CTRL1/2                                     | ---  | ---   | ---   | ---   | ---   | ---   |
| EFX Control Depth 1/2        | ---   | ---  | Other than 0                                     | ---  | ---   | ---   | ---   | ---   | ---   |
| Patch Control Source 1/2/3   | ---   | ---  | ISYS-CTRL1/2                                     | ---  | ---   | ---   | ---   | ---   | ---   |
| EFX Control Hold/Peak        | ---   | ---  | ---  | ---  | ---   | HOLD  | PEAK  | ---   | ---   |
| Control 1/2/3 Hold/Peak      | ---   | ---  | ---  | ---  | ---   | ---   | ---   | HOLD  | PEAK  |
| PATCH TONE PARAMETER         |   |  |  |  |   |   |   |   |   |
| Ctrl 1/2/3 Dest.1/2/3/4      | ---   | Other than OFF                                 | ---  | ---  | ---   | ---   | ---   | ---   | ---   |
| Ctrl 1/2/3 Depth1/2/3/4      | ---   | Other than 0                                   | ---  | ---  | ---   | ---   | ---   | ---   | ---   |
| LFO1/2 External Sync         | ---   | ---  | ---  | TAP  | ---   | ---   | ---   | ---   | ---   |
| Tone Delay Mode              | ---   | ---  | ---  | TAP-SYNC   | ---   | ---   | ---   | ---   | ---   |

---Need not be set

○ Soft Pedal

| Status | Second | Third |
|--------|--------|-------|
| BaH    | 43H    | vvh   |

n = MIDI channel number: 0H - 7FH ( 0 - 15 ) 0 = ch.1 15 = ch.16  
 vv = Control Value : 00H - 7FH ( 0 - 127 ) 0 - 63 = OFF 64 - 127 = ON

1. Patch Mode

|                            | When SOFT PEDAL is ON, Effect controller is held | Tone parameters can be controlled in real-time | Effect parameters can be controlled in real-time | LFO Rate is changed to the SOFT PEDAL ON interval | Tone Delay Time is changed to the SOFT PEDAL ON interval | When SOFT PEDAL is ON, Effect controller is held | When SOFT PEDAL is ON, Effect controller is held at its peak level | When SOFT PEDAL is ON, Tone controller is held | When SOFT PEDAL is ON, Tone controller is held at its peak level |
|----------------------------|--|--|--|---|--|--|--|--|--|
| Parameters to be set       |  |  |  |   |  |  |  |  |  |
| SYSTEM PARAMETER           |  |  |  |   |  |  |  |  |  |
| System Control Source 1/2  | ---  | CC67:SOFT                                      | CC67:SOFT  | ---   | ---  | ---  | ---  | ---  | ---  |
| Receive Control Change     | IGN  | IGN  | IGN  | IGN   | IGN  | IGN  | IGN  | IGN  | IGN  |
| TAP Control Source         | ---  | ---  | ---  | SOFT  | SOFT   | ---  | ---  | ---  | ---  |
| Hold Control Source        | ---  | ---  | ---  | ---   | ---  | SOFT   | SOFT   | SOFT   | ---  |
| Peak Control Source        | ---  | ---  | ---  | ---   | ---  | ---  | SOFT   | ---  | SOFT   |
| PATCH COMMON PARAMETER     |  |  |  |   |  |  |  |  |  |
| EFX Control Source 1/2     | ---  | ---  | ISYS-CTRL1/2                                     | ---   | ---  | ---  | ---  | ---  | ---  |
| EFX Control Depth 1/2      | ---  | ---  | Other than 0                                     | ---   | ---  | ---  | ---  | ---  | ---  |
| Patch Control Source 1/2/3 | ---  | ---  | ISYS-CTRL1/2                                     | ---   | ---  | ---  | ---  | ---  | ---  |
| EFX Control Hold/Peak      | ---  | ---  | ---  | ---   | ---  | HOLD   | PEAK   | ---  | ---  |
| Control 1/2/3 Hold/Peak    | ---  | ---  | ---  | ---   | ---  | ---  | ---  | HOLD   | PEAK   |
| PATCH TONE PARAMETER       |  |  |  |   |  |  |  |  |  |
| Ctrl 1/2/3 Dest.1/2/3/4    | ---  | Other than OFF                                 | ---  | ---   | ---  | ---  | ---  | ---  | ---  |
| Ctrl 1/2/3 Depth1/2/3/4    | ---  | Other than 0                                   | ---  | ---   | ---  | ---  | ---  | ---  | ---  |
| LFO1/2 External Sync       | ---  | ---  | ---  | TAP   | ---  | ---  | ---  | ---  | ---  |
| Tone Delay Mode            | ---  | ---  | ---  | TAP-SYNC  | ---  | ---  | ---  | ---  | ---  |

---Need not be set

2. Performance Mode

| Parameters to be set                | Tone parameters can be controlled in real-time | Effect parameters can be controlled in real-time | LFPO Rate is changed to the SOFT PEDAL ON interval | Tone Delay time is changed to the SOFT PEDAL ON interval | When SOFT PEDAL is ON, Effect controller is held | When SOFT PEDAL is ON, Effect controller is held at its peak level | When SOFT PEDAL is ON, Tone controller is held | When SOFT PEDAL is ON, Tone controller is held at its peak level |
|-------------------------------------|--|--|--|--|--|--|--|--|
|                                     |  | Setting1   | Setting2   |  |  |  |  |  |
| <b>SYSTEM PARAMETER</b>             |  |  |  |  |  |  |  |  |
| System Control Source 1/2           | CC67:SOFT ON                                   | CC67:SOFT ON                                     | CC67:SOFT ON                                       | --   | --   | --   | --   | --   |
| Receive Control Change              | ON   | ON   | ON   | ON   | ON   | ON   | ON   | ON   |
| TAP Control Source                  | --   | --   | --   | SOFT   | SOFT   | --   | --   | --   |
| Hold Control Source                 | --   | --   | --   | --   | SOFT   | --   | SOFT   | --   |
| Peak Control Source                 | --   | --   | --   | --   | --   | SOFT   | --   | SOFT   |
| <b>PERFORMANCE COMMON PARAMETER</b> |  |  |  |  |  |  |  |  |
| EFX Source                          | --   | 11 - 16  | PERFORM  | --   | --   | --   | --   | --   |
| EFX Control Source 1/2              | --   | --   | ISYS-CTRL1/2                                       | --   | --   | --   | --   | --   |
| EFX Control Depth 1/2               | --   | --   | Other than 0                                       | --   | --   | --   | --   | --   |
| <b>PERFORMANCE PART PARAMETER</b>   |  |  |  |  |  |  |  |  |
| MIDI Receive Switch                 | ON   | ON   | ON   | ON   | ON   | ON   | ON   | ON   |
| <b>PATCH COMMON PARAMETER</b>       |  |  |  |  |  |  |  |  |
| EFX Control Source 1/2              | --   | ISYS-CTRL1/2                                     | --   | --   | --   | --   | --   | --   |
| EFX Control Depth 1/2               | --   | Other than 0                                     | --   | --   | --   | --   | --   | --   |
| Patch Control Source 1/2/3          | --   | ISYS-CTRL1/2                                     | --   | --   | --   | --   | --   | --   |
| EFX Control Hold/Peak               | --   | --   | --   | --   | HOLD   | PEAK   | --   | --   |
| Control 1/2/3 Hold/Peak             | --   | --   | --   | --   | --   | --   | HOLD   | PEAK   |
| <b>PATCH TONE PARAMETER</b>         |  |  |  |  |  |  |  |  |
| Ctrl 1/2/3 Dest.1/2/3/4             | Other than OFF                                 | --   | --   | --   | --   | --   | --   | --   |
| Ctrl 1/2/3 Depth1/2/3/4             | Other than 0                                   | --   | --   | --   | --   | --   | --   | --   |
| LFPO1/2 External Sync               | --   | --   | --   | TAP  | --   | --   | --   | --   |
| Tone Delay Mode                     | --   | --   | --   | --   | TAP-SYNC   | --   | --   | --   |

--:Need not be set

0 Hold 2

Status Second Third

BnH 45H vvH

n = MIDI channel number : 0H - FH ( 0 - 15 ) 0 = ch.1 15 = ch.16  
 vv = Control Value : 00H - 7FH ( 0 - 127 ) 0 - 63 = OFF 64 - 127 = ON

1. Patch Mode

| Parameters to be set          | Tone parameters can be controlled in real-time | Effect parameters can be controlled in real-time | LFPO Rate is changed to the HOLD-2 ON interval | Tone delay time is changed to the HOLD-2 ON interval | When HOLD-2 is ON, Effect controller is held | When HOLD-2 is ON, Effect controller is held at its peak level | When HOLD-2 is ON, Tone controller is held | When HOLD-2 is ON, Tone controller is held at its peak level |
|-------------------------------|--|--|--|--|--|--|--|--|
| <b>SYSTEM PARAMETER</b>       |  |  |  |  |  |  |  |  |
| System Control Source 1/2     | CC69:HOLD-2 ON                                 | CC69:HOLD-2 ON                                   | CC69:HOLD-2 ON                                 | --   | --   | --   | --   | --   |
| Receive Control Change        | ON   | ON   | ON   | ON   | ON   | ON   | ON   | ON   |
| TAP Control Source            | --   | --   | HOLD-2   | HOLD-2   | --   | --   | --   | --   |
| Hold Control Source           | --   | --   | --   | --   | HOLD-2                                       | --   | HOLD-2                                     | --   |
| Peak Control Source           | --   | --   | --   | --   | --   | HOLD-2   | --   | HOLD-2   |
| <b>PATCH COMMON PARAMETER</b> |  |  |  |  |  |  |  |  |
| EFX Source                    | --   | ISYS-CTRL1/2                                     | --   | --   | --   | --   | --   | --   |
| EFX Control Depth 1/2         | --   | Other than 0                                     | --   | --   | --   | --   | --   | --   |
| Patch Control Source 1/2/3    | --   | ISYS-CTRL1/2                                     | --   | --   | --   | --   | --   | --   |
| EFX Control Hold/Peak         | --   | --   | --   | --   | HOLD   | PEAK   | --   | --   |
| Control 1/2/3 Hold/Peak       | --   | --   | --   | --   | --   | --   | HOLD                                       | PEAK   |
| <b>PATCH TONE PARAMETER</b>   |  |  |  |  |  |  |  |  |
| Ctrl 1/2/3 Dest.1/2/3/4       | Other than OFF                                 | --   | --   | --   | --   | --   | --   | --   |
| Ctrl 1/2/3 Depth1/2/3/4       | Other than 0                                   | --   | --   | --   | --   | --   | --   | --   |
| LFPO1/2 External Sync         | --   | --   | --   | TAP  | --   | --   | --   | --   |
| Tone Delay Mode               | --   | --   | --   | --   | TAP-SYNC                                     | --   | --   | --   |

--:Need not be set

2. Performance Mode

| Parameters to be set                | Tone parameters can be controlled in real-time | Effect parameters can be controlled in real-time | LFPO Rate is changed to the HOLD-2 ON interval | Tone Delay time is changed to the HOLD-2 ON interval | When HOLD-2 is ON, Effect controller is held | When HOLD-2 is ON, Effect controller is held at its peak level | When HOLD-2 is ON, Tone controller is held | When HOLD-2 is ON, Tone controller is held at its peak level |
|-------------------------------------|--|--|--|--|--|--|--|--|
|                                     |  | Setting1   | Setting2                                       |  |  |  |  |  |
| <b>SYSTEM PARAMETER</b>             |  |  |  |  |  |  |  |  |
| System Control Source 1/2           | CC69:HOLD-2 ON                                 | CC69:HOLD-2 ON                                   | CC69:HOLD-2 ON                                 | --   | --   | --   | --   | --   |
| Receive Control Change              | ON   | ON   | ON   | ON   | ON   | ON   | ON   | ON   |
| TAP Control Source                  | --   | --   | --   | HOLD-2   | HOLD-2                                       | --   | --   | --   |
| Hold Control Source                 | --   | --   | --   | --   | HOLD-2                                       | --   | HOLD-2                                     | --   |
| Peak Control Source                 | --   | --   | --   | --   | --   | HOLD-2   | --   | HOLD-2   |
| <b>PERFORMANCE COMMON PARAMETER</b> |  |  |  |  |  |  |  |  |
| EFX Source                          | --   | 11 - 16  | PERFORM  | --   | --   | --   | --   | --   |
| EFX Control Source 1/2              | --   | --   | ISYS-CTRL1/2                                   | --   | --   | --   | --   | --   |
| EFX Control Depth 1/2               | --   | --   | Other than 0                                   | --   | --   | --   | --   | --   |
| <b>PERFORMANCE PART PARAMETER</b>   |  |  |  |  |  |  |  |  |
| MIDI Receive Switch                 | ON   | ON   | ON   | ON   | ON   | ON   | ON   | ON   |
| <b>PATCH COMMON PARAMETER</b>       |  |  |  |  |  |  |  |  |
| EFX Control Source 1/2              | --   | ISYS-CTRL1/2                                     | --   | --   | --   | --   | --   | --   |
| EFX Control Depth 1/2               | --   | Other than 0                                     | --   | --   | --   | --   | --   | --   |
| Patch Control Source 1/2/3          | --   | ISYS-CTRL1/2                                     | --   | --   | --   | --   | --   | --   |
| EFX Control Hold/Peak               | --   | --   | --   | --   | HOLD   | PEAK   | --   | --   |
| Control 1/2/3 Hold/Peak             | --   | --   | --   | --   | --   | --   | HOLD                                       | PEAK   |
| <b>PATCH TONE PARAMETER</b>         |  |  |  |  |  |  |  |  |
| Ctrl 1/2/3 Dest.1/2/3/4             | Other than OFF                                 | --   | --   | --   | --   | --   | --   | --   |
| Ctrl 1/2/3 Depth1/2/3/4             | Other than 0                                   | --   | --   | --   | --   | --   | --   | --   |
| LFPO1/2 External Sync               | --   | --   | --   | TAP  | --   | --   | --   | --   |
| Tone Delay Mode                     | --   | --   | --   | --   | TAP-SYNC                                     | --   | --   | --   |

--:Need not be set

○ Portamento Control

| Status | Second | Third |
|--------|--------|-------|
| BnH    | 54H    | kkH   |

n = MIDI channel number: 0H - FH ( 0 - 15 ) 0 = ch.1 15 = ch.16  
 kk = Note Number : 00H - 7FH ( 0 - 127 )

1. Patch Mode

| Parameters to be set       | The on-note glides to the pitch of the note turned on next | Tone parameters can be controlled in real-time | Effect parameters can be controlled in real-time |
|----------------------------|--|--|--|
| SYSTEM PARAMETER           |  |  |  |
| System Control Source 1/2  | --   | CC84:  | CC84:  |
| Receive Control Change     | ON   | ON   | ON   |
| PATCH COMMON PARAMETER     |  |  |  |
| EFX Control Source 1/2     | --   | --   | SYS-CTRL1/2                                      |
| EFX Control Depth 1/2      | --   | --   | Other than 0                                     |
| Patch Control Source 1/2/3 | --   | SYS-CTRL1/2                                    | --   |
| PATCH TONE PARAMETER       |  |  |  |
| Ctrl 1/2/3 Dest.1/2/3/4    | --   | Other than OFF                                 | --   |
| Ctrl 1/2/3 Depth1/2/3/4    | --   | Other than 0                                   | --   |

--:Need not be set

2. Performance Mode

| Parameters to be set         | This applies to the receiving ch. The on-note glides to the pitch of the note turned on next | Tone parameters can be controlled in real-time | Setting1     | Setting2     | Effect parameters can be controlled in real-time |
|------------------------------|--|--|--------------|--------------|--|
| SYSTEM PARAMETER             |  |  |              |              |  |
| System Control Source 1/2    | --   | CC84:  | CC84:        | CC84:        | CC84:  |
| Receive Control Change       | ON   | ON   | ON           | ON           | ON   |
| PERFORMANCE COMMON PARAMETER |  |  |              |              |  |
| EFX Source                   | --   | --   | 1 - 16       | PERFORM      |  |
| EFX Control Source 1/2       | --   | --   | --           | SYS-CTRL1/2  |  |
| EFX Control Depth 1/2        | --   | --   | --           | Other than 0 |  |
| Patch Control Source 1/2/3   | --   | SYS-CTRL1/2                                    | --           | --           |  |
| PATCH COMMON PARAMETER       |  |  |              |              |  |
| EFX Control Source 1/2       | --   | --   | SYS-CTRL1/2  | --           |  |
| EFX Control Depth 1/2        | --   | --   | Other than 0 | --           |  |
| Patch Control Source 1/2/3   | --   | SYS-CTRL1/2                                    | --           | --           |  |
| PATCH TONE PARAMETER         |  |  |              |              |  |
| Ctrl 1/2/3 Dest.1/2/3/4      | --   | Other than OFF                                 | --           | --           |  |
| Ctrl 1/2/3 Depth1/2/3/4      | --   | Other than 0                                   | --           | --           |  |

--:Need not be set

○ General Purpose Effect 1 (Reverb)

| Status | Second | Third |
|--------|--------|-------|
| BnH    | 5BH    | vvH   |

n = MIDI channel number: 0H - FH ( 0 - 15 ) 0 = ch.1 15 = ch.16  
 vv = Control value : 00H - 7FH ( 0 - 127 )

1. Patch Mode

\* This message, when received in patch mode, will not affect the reverb send level.

| Parameters to be set       | Tone parameters can be controlled in real-time | Effect parameters can be controlled in real-time |
|----------------------------|--|--|
| SYSTEM PARAMETER           |  |  |
| System Control Source 1/2  | CC91:REVERB                                    | CC91:REVERB                                      |
| Receive Control Change     | ON   | ON   |
| PATCH COMMON PARAMETER     |  |  |
| EFX Control Source 1/2     | --   | SYS-CTRL1/2                                      |
| EFX Control Depth 1/2      | --   | Other than 0                                     |
| Patch Control Source 1/2/3 | SYS-CTRL1/2                                    | --   |
| PATCH TONE PARAMETER       |  |  |
| Ctrl 1/2/3 Dest.1/2/3/4    | Other than OFF                                 | --   |
| Ctrl 1/2/3 Depth1/2/3/4    | Other than 0                                   | --   |

--:Need not be set

## 2. Performance Mode

| Parameters to be set                | Reverb send level of the part on the receiving ch. will be changed | Tone parameters can be controlled in real-time | Effect parameters can be controlled in real-time |              |
|-------------------------------------|--|--|--|--------------|
|                                     |  |  | Setting1   | Setting2     |
| <b>SYSTEM PARAMETER</b>             |  |  |  |              |
| System Control Source 1/2           | --   | CC91:REVERB                                    | CC91:REVERB                                      | CC91:REVERB  |
| Receive Control Change              | ON   | ON   | ON   | ON           |
| <b>PERFORMANCE COMMON PARAMETER</b> |  |  |  |              |
| EFX Source                          | --   | --   | 1 - 16   | PERFORM      |
| EFX Control Source 1/2              | --   | --   | --   | SYS-CTRL1/2  |
| EFX Control Depth 1/2               | --   | --   | --   | Other than 0 |
| <b>PERFORMANCE PART PARAMETER</b>   |  |  |  |              |
| MIDI Receive Switch                 | ON   | ON   | ON   | ON           |
| <b>PATCH COMMON PARAMETER</b>       |  |  |  |              |
| EFX Control Source 1/2              | --   | --   | SYS-CTRL1/2                                      | --           |
| EFX Control Depth 1/2               | --   | --   | Other than 0                                     | --           |
| Patch Control Source 1/2/3          | --   | SYS-CTRL1/2                                    | --   | --           |
| <b>PATCH TONE PARAMETER</b>         |  |  |  |              |
| Ctrl 1/2/3 Dest.1/2/3/4             | --   | Other than OFF                                 | --   | --           |
| Ctrl 1/2/3 Depth1/2/3/4             | --   | Other than 0                                   | --   | --           |

--:Need not be set

## ○ General Purpose Effect 3 (Chorus)

| Status | Second | Third |
|--------|--------|-------|
| BnH    | 5DH    | vvH   |

n = MIDI channel number: 0H - FH ( 0 - 15 ) 0 = ch.1 15 = ch.16  
 vv = Control value : 00H - 7FH ( 0 - 127 )

### 1. Patch Mode

\* This message, when received in Patch mode, will not affect the chorus send level.

| Parameters to be set          | Chorus send level of the part on the receiving ch. will be changed | Tone parameters can be controlled in real-time | Effect parameters can be controlled in real-time |             |
|-------------------------------|--|--|--|-------------|
|                               |  |  | Setting1   | Setting2    |
| <b>SYSTEM PARAMETER</b>       |  |  |  |             |
| System Control Source 1/2     | --   | CC93:CHORUS                                    | CC93:CHORUS                                      | CC93:CHORUS |
| Receive Control Change        | ON   | ON   | ON   | ON          |
| <b>PATCH COMMON PARAMETER</b> |  |  |  |             |
| EFX Control Source 1/2        | --   | --   | SYS-CTRL1/2                                      | --          |
| EFX Control Depth 1/2         | --   | --   | Other than 0                                     | --          |
| Patch Control Source 1/2/3    | --   | SYS-CTRL1/2                                    | --   | --          |
| <b>PATCH TONE PARAMETER</b>   |  |  |  |             |
| Ctrl 1/2/3 Dest.1/2/3/4       | --   | Other than OFF                                 | --   | --          |
| Ctrl 1/2/3 Depth1/2/3/4       | --   | Other than 0                                   | --   | --          |

--:Need not be set

## 2. Performance Mode

| Parameters to be set                | Chorus send level of the part on the receiving ch. will be changed | Tone parameters can be controlled in real-time | Effect parameters can be controlled in real-time |              |
|-------------------------------------|--|--|--|--------------|
|                                     |  |  | Setting1   | Setting2     |
| <b>SYSTEM PARAMETER</b>             |  |  |  |              |
| System Control Source 1/2           | --   | CC93:CHORUS                                    | CC93:CHORUS                                      | CC93:CHORUS  |
| Receive Control Change              | ON   | ON   | ON   | ON           |
| <b>PERFORMANCE COMMON PARAMETER</b> |  |  |  |              |
| EFX Source                          | --   | --   | 1 - 16   | PERFORM      |
| EFX Control Source 1/2              | --   | --   | --   | SYS-CTRL1/2  |
| EFX Control Depth 1/2               | --   | --   | --   | Other than 0 |
| <b>PERFORMANCE PART PARAMETER</b>   |  |  |  |              |
| MIDI Receive Switch                 | ON   | ON   | ON   | ON           |
| <b>PATCH COMMON PARAMETER</b>       |  |  |  |              |
| EFX Control Source 1/2              | --   | --   | SYS-CTRL1/2                                      | --           |
| EFX Control Depth 1/2               | --   | --   | Other than 0                                     | --           |
| Patch Control Source 1/2/3          | --   | SYS-CTRL1/2                                    | --   | --           |
| <b>PATCH TONE PARAMETER</b>         |  |  |  |              |
| Ctrl 1/2/3 Dest.1/2/3/4             | --   | Other than OFF                                 | --   | --           |
| Ctrl 1/2/3 Depth1/2/3/4             | --   | Other than 0                                   | --   | --           |

--:Need not be set

## ○ RPN LSB

| Status | Second | Third |
|--------|--------|-------|
| BnH    | 64H    | 11H   |

n = MIDI channel number: 0H - FH ( 0 - 15 ) 0 = ch.1 15 = ch.16  
 11 = Lower byte of the parameter number specified by RPN.

○ RPN MSB

| Status | Second | Third |
|--------|--------|-------|
| BnH    | 65H    | mmH   |

n = MIDI channel number: 0H - FH ( 0 - 15 ) 0 = ch.1 15 = ch.16  
 mm = Upper byte of the parameter number specified by RPN.

The following is commonly applied to both RPN MSB and LSB.

1. Patch Mode

|                        |  |
|------------------------|--|
|                        | The parameter No. specified by RPN will be changed |
| SYSTEM PARAMETER       |  |
| Receive Control Change | ON   |

2. Performance Mode

|                            |   |
|----------------------------|---|
|                            | Parameter No., specified by RPN, of the part on the receiving channel will be changed |
| SYSTEM PARAMETER           |   |
| Receive Control Change     | ON  |
| PERFORMANCE PART PARAMETER |   |
| MIDI Receive Switch        | ON  |

○ Data Entry LSB

| Status | Second | Third |
|--------|--------|-------|
| BnH    | 26H    | 11H   |

n = MIDI channel number: 0H - FH ( 0 - 15 ) 0 = ch.1 15 = ch.16  
 ll = Value for the parameter specified by RPN

1. Patch Mode

|                            |  |  |  |
|----------------------------|--|--|--|
|                            | LSB of the data for the parameter specified by RPN LSB/MSB will be changed | Tone parameters can be controlled in real-time | Effect parameters can be controlled in real-time |
| SYSTEM PARAMETER           |  |  |  |
| System Control Source 1/2  | --   | CC38:  | CC38:  |
| Receive Control Change     | ON   | ON   | ON   |
| PATCH COMMON PARAMETER     |  |  |  |
| EFX Control Source 1/2     | --   | --   | SYS-CTRL1/2                                      |
| EFX Control Depth 1/2      | --   | --   | Other than 0                                     |
| Patch Control Source 1/2/3 | --   | SYS-CTRL1/2                                    | --   |
| PATCH TONE PARAMETER       |  |  |  |
| Ctrl 1/2/3 Dest.1/2/3/4    | --   | Other than OFF                                 | --   |
| Ctrl 1/2/3 Depth1/2/3/4    | --   | Other than 0                                   | --   |

--:Need not be set

2. Performance Mode

|                              |   |  |  |              |  |
|------------------------------|---|--|--|--------------|--|
|                              | LSB of the data for parameter, specified by RPN LSB/MSB, of the part on the receiving channel will be changed | Tone parameters can be controlled in real-time | Effect parameters can be controlled in real-time |              |  |
| SYSTEM PARAMETER             |   |  |  |              |  |
| System Control Source 1/2    | --  | CC38:  | CC38:  | CC38:        |  |
| Receive Control Change       | ON  | ON   | ON   | ON           |  |
| PERFORMANCE COMMON PARAMETER |   |  |  |              |  |
| EFX Source                   | --  | --   | 1 - 16   | PERFORM      |  |
| EFX Control Source 1/2       | --  | --   | --   | SYS-CTRL1/2  |  |
| EFX Control Depth 1/2        | --  | --   | --   | Other than 0 |  |
| PERFORMANCE PART PARAMETER   |   |  |  |              |  |
| MIDI Receive Switch          | ON  | ON   | ON   | ON           |  |
| PATCH COMMON PARAMETER       |   |  |  |              |  |
| EFX Control Source 1/2       | --  | --   | SYS-CTRL1/2                                      | --           |  |
| EFX Control Depth 1/2        | --  | --   | Other than 0                                     | --           |  |
| Patch Control Source 1/2/3   | --  | SYS-CTRL1/2                                    | --   | --           |  |
| PATCH TONE PARAMETER         |   |  |  |              |  |
| Ctrl 1/2/3 Dest.1/2/3/4      | --  | Other than OFF                                 | --   | --           |  |
| Ctrl 1/2/3 Depth1/2/3/4      | --  | Other than 0                                   | --   | --           |  |

--:Need not be set



○ Data Entry MSB

| Status | Second | Third |
|--------|--------|-------|
| BnH    | 06H    | mm H  |

n = MIDI channel number: 0H - FH ( 0 - 15 ) 0 = ch.1 15 = ch.16  
 mm = Value for the parameter specified by RPN

1. Patch Mode

| Parameters to be set       | MSB of the data for the parameter specified by RPN LSB/MSB will be changed | Tone parameters can be controlled in real time | Effect parameters can be controlled in real time |
|----------------------------|--|--|--|
| SYSTEM PARAMETER           |  |  |  |
| System Control Source 1/2  | --   | CC6:DATA-ENTRY                                 | CC6:DATA-ENTRY                                   |
| Receive Control Change     | ON   | ON   | ON   |
| PATCH COMMON PARAMETER     |  |  |  |
| EFX Control Source 1/2     | --   | --   | SYS-CTRL1/2                                      |
| EFX Control Depth 1/2      | --   | --   | Other than 0                                     |
| Patch Control Source 1/2/3 | --   | SYS-CTRL1/2                                    | --   |
| PATCH TONE PARAMETER       |  |  |  |
| Ctrl 1/2/3 Dest.1/2/3/4    | --   | Other than OFF                                 | --   |
| Ctrl 1/2/3 Depth1/2/3/4    | --   | Other than 0                                   | --   |

--:Need not be set

2. Performance Mode

| Parameters to be set         | MSB of the data for parameter, specified by RPN LSB/MSB, of the part on the receiving channel will be changed | Tone parameters can be controlled in real-time | Effect parameters can be controlled in real-time | Setting1       | Setting2       |
|------------------------------|---|--|--|----------------|----------------|
| SYSTEM PARAMETER             |   |  |  |                |                |
| System Control Source 1/2    | --  | CC6:DATA-ENTRY                                 | CC6:DATA-ENTRY                                   | CC6:DATA-ENTRY | CC6:DATA-ENTRY |
| Receive Control Change       | ON  | ON   | ON   | ON             | ON             |
| PERFORMANCE COMMON PARAMETER |   |  |  |                |                |
| EFX Source                   | --  | --   | 11 - 16  | PERFORM        | PERFORM        |
| EFX Control Source 1/2       | --  | --   | --   | SYS-CTRL1/2    | SYS-CTRL1/2    |
| EFX Control Depth 1/2        | --  | --   | --   | Other than 0   | Other than 0   |
| PERFORMANCE PART PARAMETER   |   |  |  |                |                |
| MIDI Receive Switch          | ON  | ON   | ON   | ON             | ON             |
| PATCH COMMON PARAMETER       |   |  |  |                |                |
| EFX Control Source 1/2       | --  | --   | SYS-CTRL1/2                                      | --             | --             |
| EFX Control Depth 1/2        | --  | --   | Other than 0                                     | --             | --             |
| Patch Control Source 1/2/3   | --  | SYS-CTRL1/2                                    | --   | --             | --             |
| PATCH TONE PARAMETER         |   |  |  |                |                |
| Ctrl 1/2/3 Dest.1/2/3/4      | --  | Other than OFF                                 | --   | --             | --             |
| Ctrl 1/2/3 Depth1/2/3/4      | --  | Other than 0                                   | --   | --             | --             |

--:Need not be set

\*\* Description of RPN \*\*

RPNs (Registered Parameter Numbers) are functions defined by MIDI standard. Each PRN may be used to change parameters of equipment to vary characteristics of tone, performance, etc. The JV-1080 can recognize the four RPNs: Pitch Bend Sensitivity (RPN#0), Fine Tuning (RPN#1), Coarse Tuning (RPN#2) and RPN Reset (RPN#16383). To effect RPN, first designate the parameter to be controlled using RPN MSB and RPN LSB, and then specify the value of designated parameter in the data entry.

BnH 65H mmH      BnH 64H 11H      BnH 06H xxH      BnH 26H yyH  
 ( RPN MSB )      ( RPN LSB )      ( Data Entry MSB )      ( Data Entry LSB )

n = MIDI channel number: 0H - FH ( 0 - 15 ) 0 = ch.1 15 = ch.16

| RPN              | Data Entry       | Function  |
|------------------|------------------|---|
| MSB LSB<br>mm 11 | MSB LSB<br>xx yy |   |
| 00H 00H          | mmH ---          | Pitch bend sensitivity<br>mm : 00H - 0CH (0 - 12 in unit of semitones)<br>11 : Ignored<br>Up to 1 octave in unit of semitones.<br>* Common to BENDER-RANGE UP and BENDER-RANGE DOWN<br>* Rhythm part (part 10) ignores this function.                                   |
| 00H 01H          | mmH 11H          | Fine Tuning<br>mm, 11 : 20H, 00H - 40H, 00H - 60H, 00H<br>( -8192 * 50 / 8192 - 0 - +8192 * 50 / 8192 cent )<br>* In patch mode, sets master tune.<br>* In performance mode, sets fine tune of a part.<br>* When received on the control channel, sets the master tune. |
| 00H 02H          | mmH ---          | Coarse Tuning<br>mm : 10H - 40H - 70H / -48 - 0 - +48 in unit of semitones)<br>11 : Ignored<br>* Ignored in patch mode<br>* In performance mode, sets coarse tune of a part.  |
| 7FH 7FH          | --- ---          | RPN Reset<br>Cancels the settings made by PRN(s).<br>Internal settings remain unchanged.<br>mm, 11 : Ignored  |

\* RPN is received either MSB first or LSB first.  
 \* Data entry data must be sent MSB first to correctly received.  
 (LSB is cleared to 0 when MSB is received.)

● Program Change

Status        Second  
-----  
CnH            ppH

n = MIDI channel number: 0H - FH ( 0 - 15 ) 0 = ch.1 15 = ch.16  
pp = Program number : 00H - 7FH ( 0 - 127 )

1. Patch Mode

|                        |   |
|------------------------|---|
|                        | Changes patches (patch number is the program number plus 1) |
| SYSTEM PARAMETER       |   |
| Receive Program Change | ION   |
|                        | --:Need not be set  |

2. Performance Mode

\* Changes performance when received on the control channel.

|                            |   |
|----------------------------|---|
|                            | Patch of the part on the receiving channel will be changed. (The patch number is the program number plus 1) |
| SYSTEM PARAMETER           |   |
| Receive Program Change     | ION   |
| PERFORMANCE PART PARAMETER |   |
| MIDI Receive Switch        | ION   |
| Receive Program Change     | ION   |
|                            | --:Need not be set  |

● Channel Pressure

Status        Second  
-----  
DnH            vvH

n = MIDI channel number: 0H - FH ( 0 - 15 ) 0 = ch.1 15 = ch.16  
vv = Pressure value : 00H - 7FH ( 0 - 127 )

1. Patch Mode

|                            |  |                       |  |                       |
|----------------------------|--|-----------------------|--|-----------------------|
|                            | Tone parameters can be controlled in real-time |                       | Effect parameters can be controlled in real-time |                       |
| Parameters to be set       | Setting1                                       | Setting2              | Setting1   | Setting2              |
| SYSTEM PARAMETER           |  |                       |  |                       |
| System Control Source 1/2  | --   | AFTERTOUCH            | --   | AFTERTOUCH            |
| Receive Aftertouch         | ION  | ION                   | ION  | ION                   |
| Aftertouch Source          | ICH-AFTER or ICH&POLY                          | ICH-AFTER or ICH&POLY | ICH-AFTER or ICH&POLY                            | ICH-AFTER or ICH&POLY |
| PATCH COMMON PARAMETER     |  |                       |  |                       |
| EFX Control Source 1/2     | --   | --                    | AFTERTOUCH                                       | SYS-CTRL1/2           |
| EFX Control Depth 1/2      | --   | --                    | Other than 0                                     | Other than 0          |
| Patch Control Source 1/2/3 | AFTERTOUCH                                     | SYS-CTRL1/2           | --   | --                    |
| PATCH TONE PARAMETER       |  |                       |  |                       |
| Ctrl 1/2/3 Dest.1/2/3/4    | Other than OFF                                 | Other than OFF        | --   | --                    |
| Ctrl 1/2/3 Depth1/2/3/4    | Other than 0                                   | Other than 0          | --   | --                    |
|                            | --:Need not be set                             |                       |  |                       |

2. Performance Mode

|                              |  |                       |  |                       |                       |                       |
|------------------------------|--|-----------------------|--|-----------------------|-----------------------|-----------------------|
|                              | Tone parameters can be controlled in real-time |                       | Effect parameters can be controlled in real-time |                       |                       |                       |
| Parameters to be set         | Setting1                                       | Setting2              | Setting1   | Setting2              | Setting3              | Setting4              |
| SYSTEM PARAMETER             |  |                       |  |                       |                       |                       |
| System Control Source 1/2    | --   | AFTERTOUCH            | --   | --                    | AFTERTOUCH            | AFTERTOUCH            |
| Receive Aftertouch           | ION  | ION                   | ION  | ION                   | ION                   | ION                   |
| Aftertouch Source            | ICH-AFTER or ICH&POLY                          | ICH-AFTER or ICH&POLY | ICH-AFTER or ICH&POLY                            | ICH-AFTER or ICH&POLY | ICH-AFTER or ICH&POLY | ICH-AFTER or ICH&POLY |
| PERFORMANCE COMMON PARAMETER |  |                       |  |                       |                       |                       |
| EFX Source                   | --   | --                    | 1 - 16   | PERFORM               | 1 - 16                | PERFORM               |
| EFX Control Source 1/2       | --   | --                    | --   | AFTERTOUCH            | --                    | SYS-CTRL1/2           |
| EFX Control Depth 1/2        | --   | --                    | --   | Other than 0          | --                    | Other than 0          |
| PERFORMANCE PART PARAMETER   |  |                       |  |                       |                       |                       |
| MIDI Receive Switch          | ION  | ION                   | ION  | ION                   | ION                   | ION                   |
| PATCH COMMON PARAMETER       |  |                       |  |                       |                       |                       |
| EFX Control Source 1/2       | --   | --                    | AFTERTOUCH                                       | --                    | SYS-CTRL1/2           | --                    |
| EFX Control Depth 1/2        | --   | --                    | Other than 0                                     | --                    | Other than 0          | --                    |
| Patch Control Source 1/2/3   | AFTERTOUCH                                     | SYS-CTRL1/2           | --   | --                    | --                    | --                    |
| PATCH TONE PARAMETER         |  |                       |  |                       |                       |                       |
| Ctrl 1/2/3 Dest.1/2/3/4      | Other than OFF                                 | Other than OFF        | --   | --                    | --                    | --                    |
| Ctrl 1/2/3 Depth1/2/3/4      | Other than 0                                   | Other than 0          | --   | --                    | --                    | --                    |
|                              | --:Need not be set                             |                       |  |                       |                       |                       |

● Pitch Bend Change

Status      Second      Third  
-----  
BnH        11H            mmH

n = MIDI channel number : 0H - FH ( 0 - 15 ) 0 = ch.1 15 = ch.16  
mm, 11 = Pitch bend change: 00H, 00H - 40H, 00H - 7FH, 7FH  
( -8192 - 0 - +8192 )

1. Patch Mode

| Parameters to be set       | Changes pitch of note | Tone parameters can be controlled in real-time |                | Effect parameters can be controlled in real-time |              |
|----------------------------|-----------------------|--|----------------|--|--------------|
|                            |                       | Setting1                                       | Setting2       | Setting1   | Setting2     |
| SYSTEM PARAMETER           |                       |  |                |  |              |
| System Control Source 1/2  | --                    | --   | BENDER         | --   | BENDER       |
| Receive Bender             | ON                    | ON   | ON             | ON   | ON           |
| PATCH COMMON PARAMETER     |                       |  |                |  |              |
| EFX Control Source 1/2     | --                    | --   | --             | BENDER   | SYS-CTRL1/2  |
| EFX Control Depth 1/2      | --                    | --   | --             | Other than 0                                     | Other than 0 |
| Patch Control Source 1/2/3 | --                    | BENDER   | SYS-CTRL1/2    | --   | --           |
| PATCH TONE PARAMETER       |                       |  |                |  |              |
| Bender Control Switch      | ON                    | --   | --             | --   | --           |
| Bend Range Upper/Lower     | Other than 0          | --   | --             | --   | --           |
| Pan Control Switch         | --                    | --   | --             | --   | --           |
| Ctrl 1/2/3 Dest.1/2/3/4    | --                    | Other than OFF                                 | Other than OFF | --   | --           |
| Ctrl 1/2/3 Depth1/2/3/4    | --                    | Other than 0                                   | Other than 0   | --   | --           |

--:Need not be set

2. Performance Mode

| Parameters to be set         | Changes note pitch of the part on the receiving channel | Tone parameters can be controlled in real-time |                | Effect parameters can be controlled in real-time |              |              |             |
|------------------------------|---|--|----------------|--|--------------|--------------|-------------|
|                              |   | Setting1                                       | Setting2       | Setting1   | Setting2     | Setting3     | Setting4    |
| SYSTEM PARAMETER             |   |  |                |  |              |              |             |
| System Control Source 1/2    | --  | --   | BENDER         | --   | --           | BENDER       | BENDER      |
| Receive Bender               | ON  | ON   | ON             | ON   | ON           | ON           | ON          |
| PERFORMANCE COMMON PARAMETER |   |  |                |  |              |              |             |
| EFX Source                   | --  | --   | --             | 1 - 16   | PERFORM      | 11 - 16      | PERFORM     |
| EFX Control Source 1/2       | --  | --   | --             | --   | BENDER       | --           | SYS-CTRL1/2 |
| EFX Control Depth 1/2        | --  | --   | --             | --   | Other than 0 | --           | Other than  |
| PERFORMANCE PART PARAMETER   |   |  |                |  |              |              |             |
| MIDI Receive Switch          | ON  | ON   | ON             | ON   | ON           | ON           | ON          |
| PATCH COMMON PARAMETER       |   |  |                |  |              |              |             |
| EFX Control Source 1/2       | --  | --   | --             | BENDER   | --           | SYS-CTRL1/2  | --          |
| EFX Control Depth 1/2        | --  | --   | --             | Other than 0                                     | --           | Other than 0 | --          |
| Patch Control Source 1/2/3   | --  | BENDER   | SYS-CTRL1/2    | --   | --           | --           | --          |
| PATCH TONE PARAMETER         |   |  |                |  |              |              |             |
| Bender Control Switch        | ON  | --   | --             | --   | --           | --           | --          |
| Bend Range Upper/Lower       | Other than 0  | --   | --             | --   | --           | --           | --          |
| Ctrl 1/2/3 Dest.1/2/3/4      | --  | Other than OFF                                 | Other than OFF | --   | --           | --           | --          |
| Ctrl 1/2/3 Depth1/2/3/4      | --  | Other than 0                                   | Other than 0   | --   | --           | --           | --          |

--:Need not be set

■ Channel Mode Message

● All Sounds Off

Status      Second      Third  
-----  
BnH        78H            00H

n = MIDI channel number: 0H - FH ( 0 - 15 ) 0 = ch.1 15 = ch.16

\* Turns off all MIDI-on notes on the MIDI channel.  
However, the state of channel messages does not change.

● Reset All Controllers

Status      Second      Third  
-----  
BnH        79H            00H

n = MIDI channel number: 0H - FH ( 0 - 15 ) 0 = ch.1 15 = ch.16

\* Upon receiving this message, the JV-1080 changes settings of the controller as follows:

| Controller                          | Settings                                     |
|-------------------------------------|--|
| Modulation                          | 0 (min)                                      |
| Breath                              | 0 (min)                                      |
| Foot                                | 0 (min)                                      |
| Volume                              | 127 (max)                                    |
| Pan                                 | 64 (center)                                  |
| Expression                          | 0 (min) (volume is set at max.)              |
| Hold 1                              | 0 (off)                                      |
| Sostenuto                           | 0 (off)                                      |
| Soft Pedal                          | 0 (off)                                      |
| Hold 2                              | 0 (off)                                      |
| Channel Pressure                    | 0 (min)                                      |
| Polyphonic Pressure                 | 0 (min)                                      |
| Pitch Bend Change                   | ±0 (center)                                  |
| RPN                                 | Undefined: does not affect the internal data |
| General purpose system controller 1 | 0 (min)                                      |
| General purpose system controller 2 | 0 (min)                                      |

● All Notes Off

```
Status      Second      Third
-----
BnH         7BH         00H
```

n = MIDI channel number: 0H - FH ( 0 - 15 ) 0 = ch.1 15 = ch.16

\* Turns off all MIDI-on notes on the MIDI channel.  
 However, sound continues when Hold 1 and/or SOSTENUTO is ON.

● OMNI OFF

```
Status      Second      Third
-----
BnH         7CH         00H
```

n = MIDI channel number: 0H - FH ( 0 - 15 ) 0 = ch.1 15 = ch.16

\* Serves as All Notes Off.

● OMNI ON

```
Status      Second      Third
-----
BnH         7DH         00H
```

n = MIDI channel number: 0H - FH ( 0 - 15 ) 0 = ch.1 15 = ch.16

\* Serves as All Notes Off and not OMNI ON.

● MONO

```
Status      Second      Third
-----
BnH         7EH         mmH
```

n = MIDI channel number: 0H - FH ( 0 - 15 ) 0 = ch.1 15 = ch.16  
 mm = Number of MONOs : 00H - 0FH ( 0 - 15 )

\* The key assign mode of the patch common parameter is changed to SOLO.  
 \* Serves as All Notes Off and Part to Mode 4 (m=1).

● POLY

```
Status      Second      Third
-----
BnH         7FH         00H
```

n = MIDI channel number: 0H - FH ( 0 - 15 ) 0 = ch.1 15 = ch.16

\* The key assign mode of the patch common parameter is changed to POLY.  
 \* Serves as All Notes Off and Part to Mode 3.

■ System Real Time Messages

● Active Sensing

```
Status
-----
FEH
```

\* When JV-1080 receives Active Sensing, it measures time intervals between incoming messages. If the subsequent message will not come within 400 ms after the previous one, JV-1080 turns off all MIDI-on notes, operates as if it receives Reset All Controller message, and stops measuring message intervals.

● Timing Clock

```
Status
-----
FBH
```

1. Patch Mode

| Parameters to be set   | Changes LFO Rate | Changes tone delay time | Changes delay time of effect                    | Changes the step rate of effect (Flanger) |
|------------------------|------------------|-------------------------|---|---|
| SYSTEM PARAMETER       |                  |                         |   |   |
| Clock Source           | MIDI             | MIDI                    | MIDI  | MIDI                                      |
| PATCH COMMON PARAMETER |                  |                         |   |   |
| EFX Type               | --               | --                      | 19. TRIPLE-TAP-DELAY or 20. QUADRUPLE-TAP-DELAY | 16. STEP-FLANGER                          |
| PATCH TONE PARAMETER   |                  |                         |   |   |
| LFO1/2 External Sync   | CLOCK            | --                      | --  | --  |
| Tone Delay Mode        | --               | CLOCK-SYNC              | --  | --  |

--:Need not be set

## 2. Performance Mode

| Parameters to be set                         | Changes LFO Rate | Changes Tone delay time | Changes delay time of effect                     |  | Changes step rate of effect (Flanger) |                 |
|--|------------------|-------------------------|--|--|---------------------------------------|-----------------|
|  |                  |                         | Setting1   | Setting2   | Setting1                              | Setting2        |
| SYSTEM PARAMETER<br>Clock Source             | MIDI             | MIDI                    | MIDI   | MIDI   | MIDI                                  | MIDI            |
| PERFORMANCE COMMON PARAMETER<br>EFX Type     | --               | --                      | --   | 19.TRIPLE-TAP-DELAY or<br>20.QUADRUPLE-TAP-DELAY | --                                    | 16.STEP-FLANGER |
| EFX Source                                   | --               | --                      | 1 - 16   | PERFORM  | 1 - 16                                | PERFORM         |
| PATCH COMMON PARAMETER<br>EFX Type           | --               | --                      | 19.TRIPLE-TAP-DELAY or<br>20.QUADRUPLE-TAP-DELAY | --   | 16.STEP-FLANGER                       | --              |
| PATCH TONE PARAMETER<br>LFO1/2 External Sync | CLOCK            | --                      | --   | --   | --                                    | --              |
| Tone Delay Mode                              | --               | CLOCK-SYNC              | --   | --   | --                                    | --              |

--:Need not be set

### ■ System Exclusive Message

```
Status      Data Byte
-----
FOH         iiH ddH .....eeH
F7H

FOH         : System Exclusive
ii = Manufacturer ID: 41H ( 65 )
dd...ee = Data      : 00H - 7FH ( 0 - 127 )
F7H         : EOX (End Of Exclusive)
```

\* The JV-1080 recognized this message when the receive switch in system parameter is set to ON.  
For detail, please refer to section 3: Roland exclusive message.

## 2. TRANSMIT DATA

### ■ System Exclusive Message

```
Status      Data Byte
-----
FOH         iiH ddH .....eeH
F7H

FOH         : System Exclusive
ii = Manufacturer ID: 41H ( 65 )
dd...ee = Data      : 00H - 7FH ( 0 - 127 )
F7H         : EOX (End Of Exclusive)
```

For detail, please refer to section 3: Roland exclusive message.

## 3. EXclusive communications

The JV-1080 can send and receive patch parameter, etc using the system exclusive message.  
The model ID code of the JV-1080 is 6AH. The device ID code is to be determined by unit number setting of MIDI function.  
The JV-1080 ignores GS exclusive messages other than scale tune parameter. The model ID of the GS is 42H.

### ■ One way communication

#### ● Request data 1 RQ1 (11H)

```
Byte      Description
-----
FOH       Exclusive status
41H       Manufacture ID (Roland)
Dev       Device ID (Dev=UNIT#-1)
6AH       Model ID (JV-1080)
11H       Command ID (RQ1)
aaH       Address MSB
bbH       Address
ccH       Address LSB
ddH       Address LSB
ssH       Size MSB
ttH       Size
uuH       Size
vvH       Size LSB
sum       Check sum
F7H       EOX (End of exclusive)
```

\*Receive only: the JV-1080 does not send this message.

● Data set 1 DT1 (12H)

1.JV-1080 (MODEL ID = 6AH)

| Byte | Description              |
|------|--------------------------|
| F0H  | Exclusive status         |
| 41H  | Manufacturer ID (Roland) |
| Dev  | Device ID (Dev=UNIT#-1)  |
| 6AH  | Model ID (JV-1080)       |
| 12H  | Command ID (DT1)         |
| aaH  | Address MSB              |
| bbH  | Address                  |
| ccH  | Address                  |
| ddH  | Address LSB              |
| eeH  | Data                     |
| :    | :                        |
| ffH  | Data                     |
| sum  | Check sum                |
| F7H  | EOX (End of exclusive)   |

2.GS (MODEL ID = 42H)

| Byte | Description              |
|------|--------------------------|
| F0H  | Exclusive status         |
| 41H  | Manufacturer ID (Roland) |
| Dev  | Device ID (Dev=UNIT#-1)  |
| 6AH  | Model ID (GS)            |
| 12H  | Command ID (DT1)         |
| aaH  | Address MSB              |
| bbH  | Address                  |
| ccH  | Address LSB              |
| eeH  | Data                     |
| :    | :                        |
| ffH  | Data                     |
| sum  | Check sum                |
| F7H  | EOX (End of exclusive)   |

\*When the device ID is 7FH, JV-1080 can receive the GS exclusive message even if the unit number is anything.

4.Parameter address map (MODEL ID = 6AH)

Address and size are configured in 7 bits, and expressed in hexadecimal.

| Address   | MSB       | LSB                           |
|-----------|-----------|-------------------------------|
| Binary    | 0aaa aaaa | 0bbb bbbb 0ccc cccc 0ddd dddd |
| 7-bit hex | AA        | BB CC DD                      |
| Size      | MSB       | LSB                           |
| Binary    | 0sss ssss | 0ttt tttt 0uuu uuuu 0vvv vvvv |
| 7-bit hex | SS        | TT UU VV                      |

■ Parameter base address

All data sent in exclusive message are given particular addresses to identify parameters. These address are the sum of the base address and offset address. Some parameters are defined using multiple offsets. The address included in the message of a data set or a data request must be within the value shown in the table below.

Notes: A pair of two address preceded by the symbol # represents a divided-by-two data. e.g. the data ABH (hex) is divided into 0AH and 0BH and sent in that order.

/ Example of exclusive data /

To set the reverb type of the temporary performance common to "DELAY", send the following data to the JV-1080.

| F0H | 41H | 10H | 6AH | 12H | 01H | 00H | 00H | 28H | 06H | 51H | F7H |
|-----|-----|-----|-----|-----|-----|-----|-----|-----|-----|-----|-----|
| 1   | 2   | 3   | 4   | 5   | 6   | 7   | 8   | 9   |     |     |     |

Comments:

- Exclusive status.
- Manufacturer ID: Roland=41H
- Device ID: the unit number of the system common parameter minus 1. In this example, the unit number is 17; 17 - 1 = 16 which is expressed as 10H in hexadecimal notation.
- Model ID of the JV-1080 is 6AH.
- Command ID: data set 1=12H.
- Addresses: by referring to Table 1, the start address of the temporary performance=01H 00H 00H 00H; from Table 1-2, offset address of performance common=00H 00H; from Table 1-2-1, offset address of reverb type=00H 28H. These address are added together:  

$$01H\ 00H\ 00H\ 00H$$

$$+)\ 00H\ 00H$$

$$+)\ 00H\ 28H$$

---

$$01H\ 00H\ 00H\ 28H = \text{target address}$$
- The number of "DELAY" is 6: 06H in hexadecimal.
- Check sum  
 The error checking process uses a checksum and provides a pattern where the last significant 7 bits are zero when values for an address, data (or size) and the checksum are summed. If the address is "aa bb ccH" and the data (or the size) is "dd ee ffH"  

$$aa+bb+cc+dd+ee+ff=\text{sum}$$

$$\text{sum}+128-\text{quotient} \times 47 = \text{remainder}$$

$$128-\text{remainder} = \text{checksum}$$

In case of this example,

F0H 41H 10H 6AH 12H 01H 00H 00H 28H 06H 51H F7H

Using the above address data checksum  
 address data checksum  
 Using the above formula, checksum is below.

$$01H+00H+00H+28H+06H=1+0+0+40+6=47(\text{sum})$$

$$47(\text{sum})+128=0(\text{quotient})+47(\text{remainder})$$

$$\text{checksum}=128-47(\text{remainder})=81=51H$$

IF you calculate using only hexadecimal,

$$aa+bb+cc+dd+ee+ff=\text{sum}(\text{XXH})$$

$$\text{sum}(\text{XXH})+80H=\text{quotient} \times 47 + \text{remainder}$$

$$80H-\text{remainder}=\text{checksum}$$

Checksum is below,

$$01H+00H+00H+28H+06H=2FH(\text{sum})$$

$$2FH+80H=00H(\text{quotient})+2FH(\text{remainder})$$

$$\text{checksum}=80H-2FH(\text{remainder})=51H$$

9.F7H is the mark of the end of exclusive.

1 JV-1080

< MODEL ID = 6AH >

| Start       | address | Description                               |      |
|-------------|---------|---|------|
| 00 00 00 00 |         | System                                    | *1-1 |
| 01 00 00 00 |         | Temporary performance                     | *1-2 |
| 02 00 00 00 |         | Performance mode temporary patch(part 1)  | *1-3 |
| 02 01 00 00 |         | Performance mode temporary patch(part 2)  |      |
| :           |         | :   |      |
| 02 08 00 00 |         | Performance mode temporary patch(part 9)  |      |
| 02 09 00 00 |         | Temporary rhythm setup                    | *1-4 |
| 02 0A 00 00 |         | Performance mode temporary patch(part 11) | *1-3 |
| :           |         | :   |      |
| 02 0F 00 00 |         | Performance mode temporary patch(part 16) |      |
| 03 00 00 00 |         | Patch mode temporary patch                | *1-3 |
| :           |         | :   |      |
| 10 00 00 00 |         | User performance USER:01                  | *1-2 |
| 10 01 00 00 |         | User performance USER:02                  |      |
| :           |         | :   |      |
| 10 1F 00 00 |         | User performance USER:32                  |      |
| 10 40 00 00 |         | User rhythm setup USER:1                  | *1-4 |
| 10 41 00 00 |         | User rhythm setup USER:2                  |      |
| 11 00 00 00 |         | User patch USER:001                       | *1-3 |
| 11 01 00 00 |         | User patch USER:002                       |      |
| :           |         | :   |      |
| 11 7F 00 00 |         | User patch USER:128                       |      |
| :           |         | :   |      |
| 20 00 00 00 |         | Data card performance CARD:01             | *1-2 |
| 20 01 00 00 |         | Data card performance CARD:02             |      |
| :           |         | :   |      |
| 20 1F 00 00 |         | Data card performance CARD:32             |      |
| 20 40 00 00 |         | Data card rhythm set CARD:1               | *1-4 |
| 20 41 00 00 |         | Data card rhythm set CARD:2               |      |
| 21 00 00 00 |         | Data card patch CARD:001                  | *1-3 |
| 21 01 00 00 |         | Data card patch CARD:002                  |      |
| :           |         | :   |      |
| 21 7F 00 00 |         | Data card patch CARD:128                  |      |

| *1-1   | System  |                       |        |
|--------|---------|-----------------------|--------|
| Offset | address | Description           |        |
| 00 00  |         | System common         | *1-1-1 |
| 10 00  |         | Part 1 scale tune     | *1-1-2 |
| 11 00  |         | Part 2 scale tune     |        |
| :      |         | :                     |        |
| 1F 00  |         | Part 16 scale tune    |        |
| 20 00  |         | Patch mode scale tune | *1-1-2 |

| *1-1-1 | System common |   |                                       |
|--------|---------------|---|---------------------------------------|
| Offset | address       | Description   |                                       |
| 00 00  | 0000 00aa     | Panel mode  | 0 - 2                                 |
| 00 01  | 0aaa aaaa     | Performance number  | 0 - 127<br>(PERFORMANCE, PATCH, GM)   |
|        |               | (USER:01 - USER:32, CARD:01 - CARD:32,<br>PR-A:01 - PR-A:32, PR-B:01 - PR-B:32) |                                       |
| 00 02  | 0000 00aa     | Patch mode patch group  | 0 - 2                                 |
|        |               | (USER, PCM, EXP)  |                                       |
| 00 03  | 0aaa aaaa     | Patch mode patch group ID   | 0 - 127                               |
| 00 04  | 0000 aaaa     | Patch mode patch number   | 0 - 254<br>(001 - 255)                |
| 00 06  | 0aaa aaaa     | Master tune   | 0 - 126<br>(427.4 - 452.6)            |
| 00 07  | 0000 000a     | Scale tune switch   | 0 - 1                                 |
| 00 08  | 0000 000a     | EFX switch  | 0 - 1                                 |
| 00 09  | 0000 000a     | Chorus switch   | 0 - 1                                 |
| 00 0A  | 0000 000a     | Reverb switch   | 0 - 1                                 |
| 00 0B  | 0000 000a     | Patch remain  | 0 - 1                                 |
| 00 0C  | 0000 000a     | Clock source  | 0 - 1<br>(OFF, ON)                    |
| 00 0D  | 0000 0aaa     | Tap control source  | 0 - 4<br>(INT, MIDI)                  |
|        |               |   | (OFF, HOLD-1, SUSTENTD, SOFT, HOLD-2) |

|                          |           |                         |   |
|--------------------------|-----------|-------------------------|---|
| 00 0E                    | 0000 0aaa | Hold control source     | 0 - 4<br>(OFF, HOLD-1, SOSTENUTO, SOFT, HOLD-2) |
| 00 0F                    | 0000 0aaa | Peak control source     | 0 - 4<br>(OFF, HOLD-1, SOSTENUTO, SOFT, HOLD-2) |
| 00 10                    | 0000 000a | Volume control source   | 0 - 1<br>(VOLUME, VOLAEXP)                      |
| 00 11                    | 0000 00aa | Aftertouch source       | 0 - 2<br>(CH-AFTER, FOLY-AFTER, CH&POLY)        |
| 00 12                    | 0aaa aaaa | System control source 1 | 0 - 97<br>(CC00 - CC95, BENDER, AFTERTOUCH)     |
| 00 13                    | 0aaa aaaa | System control source 2 | 0 - 97<br>(CC00 - CC95, BENDER, AFTERTOUCH)     |
| 00 14                    | 0000 000a | Receive program change  | 0 - 1<br>(OFF, ON)                              |
| 00 15                    | 0000 000a | Receive bank select     | 0 - 1<br>(OFF, ON)                              |
| 00 16                    | 0000 000a | Receive control change  | 0 - 1<br>(OFF, ON)                              |
| 00 17                    | 0000 000a | Receive modulation      | 0 - 1<br>(OFF, ON)                              |
| 00 18                    | 0000 000a | Receive volume          | 0 - 1<br>(OFF, ON)                              |
| 00 19                    | 0000 000a | Receive hold-1          | 0 - 1<br>(OFF, ON)                              |
| 00 1A                    | 0000 000a | Receive bender          | 0 - 1<br>(OFF, ON)                              |
| 00 1B                    | 0000 000a | Receive aftertouch      | 0 - 1<br>(OFF, ON)                              |
| 00 1C                    | 000a aaaa | Control channel         | 0 - 16<br>(1 - 16, OFF)                         |
| 00 1D                    | 0000 aaaa | Patch receive channel   | 0 - 15<br>(1 - 16)                              |
| 00 1E                    | 0000 000a | Rhythm edit Source      | 0 - 1<br>(PANEL, PANEL&MIDI)                    |
| 00 1F                    | 0000 000a | Preview sound mode      | 0 - 1<br>(SINGLE, CHORD)                        |
| 00 20                    | 0aaa aaaa | Preview key set         | 0 - 127<br>(C-1 - G9)                           |
| 00 21                    | 0aaa aaaa | Preview velocity set 1  | 0 - 127<br>(OFF, 1 - 127)                       |
| 00 22                    | 0aaa aaaa | Preview key set 2       | 0 - 127<br>(C-1 - G9)                           |
| 00 23                    | 0aaa aaaa | Preview velocity set 2  | 0 - 127<br>(OFF, 1 - 127)                       |
| 00 24                    | 0aaa aaaa | Preview key set 3       | 0 - 127<br>(C-1 - G9)                           |
| 00 25                    | 0aaa aaaa | Preview velocity set 3  | 0 - 127<br>(OFF, 1 - 127)                       |
| 00 26                    | 0aaa aaaa | Preview key set 4       | 0 - 127<br>(C-1 - G9)                           |
| 00 27                    | 0aaa aaaa | Preview velocity set 4  | 0 - 127<br>(OFF, 1 - 127)                       |
| Total size   00 00 00 28 |           |                         |   |

\*1-1-2 Scale tune

| Offset address           | Description  |
|--------------------------|--|
| 00 00                    | 0aaa aaaa   Scale tune for C 0 - 127<br>(-64 - +63)  |
| 00 01                    | 0aaa aaaa   Scale tune for C# 0 - 127<br>(-64 - +63) |
| 00 02                    | 0aaa aaaa   Scale tune for D 0 - 127<br>(-64 - +63)  |
| 00 03                    | 0aaa aaaa   Scale tune for D# 0 - 127<br>(-64 - +63) |
| 00 04                    | 0aaa aaaa   Scale tune for E 0 - 127<br>(-64 - +63)  |
| 00 05                    | 0aaa aaaa   Scale tune for F 0 - 127<br>(-64 - +63)  |
| 00 06                    | 0aaa aaaa   Scale tune for F# 0 - 127<br>(-64 - +63) |
| 00 07                    | 0aaa aaaa   Scale tune for G 0 - 127<br>(-64 - +63)  |
| 00 08                    | 0aaa aaaa   Scale tune for G# 0 - 127<br>(-64 - +63) |
| 00 09                    | 0aaa aaaa   Scale tune for A 0 - 127<br>(-64 - +63)  |
| 00 0A                    | 0aaa aaaa   Scale tune for A# 0 - 127<br>(-64 - +63) |
| 00 0B                    | 0aaa aaaa   Scale tune for B 0 - 127<br>(-64 - +63)  |
| Total size   00 00 00 0C |  |

/ Example using RQ1 /  
To get the all data of the system common, send the following message to the JV-1080.  
FOH 41H 10H 6AH 11H 00H 00H 00H 00H 00H 00H 28H 58H F7H

/ Example using DT1 /  
To set the Control Channel of the system common to 1, send the following message to the JV-1080.  
FOH 41H 10H 6AH 12H 00H 00H 00H 00H 00H 00H 64H F7H

\*1-2 Performance

| Offset address | Description               |
|----------------|---------------------------|
| 00 00          | Performance common *1-2-1 |
| 10 00          | Performance part 1        |
| 11 00          | Performance part 2 *1-2-2 |
| 1F 00          | Performance part 16       |

\*1-2-1 Performance common

| Offset address           | Description   |
|--------------------------|---|
| 00 00                    | 0aaa aaaa   Performance name 1 32 - 127   |
| 00 01                    | 0aaa aaaa   Performance name 2 32 - 127   |
| 00 02                    | 0aaa aaaa   Performance name 3 32 - 127   |
| 00 03                    | 0aaa aaaa   Performance name 4 32 - 127   |
| 00 04                    | 0aaa aaaa   Performance name 5 32 - 127   |
| 00 05                    | 0aaa aaaa   Performance name 6 32 - 127   |
| 00 06                    | 0aaa aaaa   Performance name 7 32 - 127   |
| 00 07                    | 0aaa aaaa   Performance name 8 32 - 127   |
| 00 08                    | 0aaa aaaa   Performance name 9 32 - 127   |
| 00 09                    | 0aaa aaaa   Performance name 10 32 - 127  |
| 00 0A                    | 0aaa aaaa   Performance name 11 32 - 127  |
| 00 0B                    | 0aaa aaaa   Performance name 12 32 - 127  |
| 00 0C                    | 00aa aaaa   EFX:Source 0 - 15<br>(PERFORM, 1 - 9, 11 - 16)  |
| 00 0D                    | 00aa aaaa   EFX:Type 0 - 39   |
| 00 0E                    | 0aaa aaaa   EFX:Parameter 1 32 - 127  |
| 00 0F                    | 0aaa aaaa   EFX:Parameter 2 0 - 127   |
| 00 10                    | 0aaa aaaa   EFX:Parameter 3 0 - 127   |
| 00 11                    | 0aaa aaaa   EFX:Parameter 4 0 - 127   |
| 00 12                    | 0aaa aaaa   EFX:Parameter 5 0 - 127   |
| 00 13                    | 0aaa aaaa   EFX:Parameter 6 0 - 127   |
| 00 14                    | 0aaa aaaa   EFX:Parameter 7 0 - 127   |
| 00 15                    | 0aaa aaaa   EFX:Parameter 8 0 - 127   |
| 00 16                    | 0aaa aaaa   EFX:Parameter 9 0 - 127   |
| 00 17                    | 0aaa aaaa   EFX:Parameter 10 0 - 127  |
| 00 18                    | 0aaa aaaa   EFX:Parameter 11 0 - 127  |
| 00 19                    | 0aaa aaaa   EFX:Parameter 12 0 - 127  |
| 00 1A                    | 0000 00aa   EFX:Output assign 0 - 2<br>(MIX, OUTPUT1, OUTPUT2)  |
| 00 1B                    | 0aaa aaaa   EFX:Output level 0 - 127  |
| 00 1C                    | 0aaa aaaa   EFX:Chorus send level 0 - 127   |
| 00 1D                    | 0aaa aaaa   EFX:Reverb send level 0 - 127   |
| 00 1E                    | 0000 aaaa   EFX:Control source 1 0 - 10<br>(OFF, SYS-CTRL1, SYS-CTRL2, MODULATION, BREATH, FOOT, VOLUME, PAN, EXPRESSION, BENDER, AFTERTOUCH) |
| 00 1F                    | 0aaa aaaa   EFX:Control depth 1 0 - 126<br>(-63 - +63)  |
| 00 20                    | 0000 aaaa   EFX:Control source 2 0 - 10<br>(OFF, SYS-CTRL1, SYS-CTRL2, MODULATION, BREATH, FOOT, VOLUME, PAN, EXPRESSION, BENDER, AFTERTOUCH) |
| 00 21                    | 0aaa aaaa   EFX:Control depth 2 0 - 126<br>(-63 - +63)  |
| 00 22                    | 0aaa aaaa   Chorus:Level 0 - 127  |
| 00 23                    | 0aaa aaaa   Chorus:Rate 0 - 127   |
| 00 24                    | 0aaa aaaa   Chorus:Depth 0 - 127  |
| 00 25                    | 0aaa aaaa   Chorus:Pre delay 0 - 127  |
| 00 26                    | 0aaa aaaa   Chorus:Feedback 0 - 127   |
| 00 27                    | 0000 00aa   Chorus:Output assign 0 - 2<br>(MIX, REVERB, MIX+REV)  |
| 00 28                    | 0000 0aaa   Reverb:type 0 - 7<br>(ROOM1, ROOM2, STAGE1, STAGE2, HALL1, HALL2, DELAY, PAN-DLY)   |
| 00 29                    | 0aaa aaaa   Reverb:Level 0 - 127  |
| 00 2A                    | 0aaa aaaa   Reverb:Time 0 - 127   |
| 00 2B                    | 000a aaaa   Reverb:HF damp 0 - 17<br>(200, 250, 315, 400, 500, 630, 800, 1000, 1250, 1600, 2000, 2500, 3150, 4000, 5000, 6300, 8000, BYPASS)  |
| 00 2C                    | 0aaa aaaa   Reverb:Feedback 0 - 127   |
| 00 2D                    | 0000 aaaa   Default tempo 20 - 250<br>0000 bbbb   |
| 00 2F                    | 0000 000a   Key range switch 0 - 1<br>(OFF, ON)   |
| 00 30                    | 0aaa aaaa   Part 1 voice reserve 0 - 64   |
| 00 31                    | 0aaa aaaa   Part 2 voice reserve 0 - 64   |
| 00 32                    | 0aaa aaaa   Part 3 voice reserve 0 - 64   |
| 00 33                    | 0aaa aaaa   Part 4 voice reserve 0 - 64   |
| 00 34                    | 0aaa aaaa   Part 5 voice reserve 0 - 64   |
| 00 35                    | 0aaa aaaa   Part 6 voice reserve 0 - 64   |
| 00 36                    | 0aaa aaaa   Part 7 voice reserve 0 - 64   |
| 00 37                    | 0aaa aaaa   Part 8 voice reserve 0 - 64   |
| 00 38                    | 0aaa aaaa   Part 9 voice reserve 0 - 64   |
| 00 39                    | 0aaa aaaa   Part 10 voice reserve 0 - 64  |
| 00 3A                    | 0aaa aaaa   Part 11 voice reserve 0 - 64  |
| 00 3B                    | 0aaa aaaa   Part 12 voice reserve 0 - 64  |
| 00 3C                    | 0aaa aaaa   Part 13 voice reserve 0 - 64  |
| 00 3D                    | 0aaa aaaa   Part 14 voice reserve 0 - 64  |
| 00 3E                    | 0aaa aaaa   Part 15 voice reserve 0 - 64  |
| 00 3F                    | 0aaa aaaa   Part 16 voice reserve 0 - 64  |
| Total size   00 00 00 40 |   |

Note: The performance name data returned in response to this request are expressed in ASCII characters of hexadecimal.

Note: The sum of voice receives must be less than or equal 64.

/ Example using RQ1 /  
To get the performance name data of performance USER:01, send the following message to the JV-1080.  
FOH 41H 10H 6AH 11H 10H 00H 00H 00H 00H 00H 0CH 64H F7H

/ Example using DT1 /  
To set the reverb type of performance USER:08 to "HALL2", send the following message to the JV-1080.  
FOH 41H 10H 6AH 12H 10H 07H 00H 28H 05H 3CH F7H

\*1-2-2 Performance part

| Offset address | Description |  |
|----------------|-------------|--|
| 00 00          | 0000 000a   | MIDI receive switch 0 - 1<br>(OFF,ON)                  |
| 00 01          | 0000 aaaa   | MIDI channel 0 - 15<br>(1 - 16)                        |
| 00 02          | 0000 00aa   | Patch group 0 - 2<br>(USER,PCM,EXP)                    |
| 00 03          | 0aaa aaaa   | Patch group ID 0 - 127                                 |
| 00 04          | 0000 aaaa   | Patch number 0 - 254<br>(001 - 255)                    |
| 00 06          | 0aaa aaaa   | Part level 0 - 127                                     |
| 00 07          | 0aaa aaaa   | Part pan 0 - 127<br>(L64 - 63R)                        |
| 00 08          | 0aaa aaaa   | Pitch coarse tune 0 - 96<br>(-48 - +48)                |
| 00 09          | 0aaa aaaa   | Pitch fine tune 0 - 100<br>(-50 - +50)                 |
| 00 0A          | 0000 0aaa   | Output assign 0 - 4<br>(MIX,EFX,OUTPUT1,OUTPUT2,PATCH) |
| 00 0B          | 0aaa aaaa   | Output level 0 - 127                                   |
| 00 0C          | 0aaa aaaa   | Chorus send level 0 - 127                              |
| 00 0D          | 0aaa aaaa   | Reverb send level 0 - 127                              |
| 00 0E          | 0000 000a   | Receive program change 0 - 1<br>(OFF,ON)               |
| 00 0F          | 0000 000a   | Receive volume 0 - 1<br>(OFF,ON)                       |
| 00 10          | 0000 000a   | Receive hold-1 0 - 1<br>(OFF,ON)                       |
| 00 11          | 0aaa aaaa   | Key range lower 0 - 127<br>(C-1 - G9)                  |
| 00 12          | 0aaa aaaa   | Key range upper 0 - 127<br>(C-1 - G9)                  |
| Total size     |             | 00 00 00 13  |

/ Example using RQ1 /  
To get the all data of the performance USER:03 parameters of part 3, send the following message to the JV-1080.  
FOH 41H 10H 6AH 11H 10H 02H 12H 00H 00H 00H 00H 13H 49H F7H

/ Example using DT1 /  
To mute (MIDI receive switch = off) the part 1 of the temporary performance, send the following message to the JV-1080.  
FOH 41H 10H 6AH 12H 01H 00H 10H 00H 00H 00H 6FH F7H

\*1-3 Patch

| Offset address | Description  |        |
|----------------|--------------|--------|
| 00 00          | Patch common | *1-3-1 |
| 10 00          | Patch tone 1 | *1-3-2 |
| 12 00          | Patch tone 2 |        |
| 14 00          | Patch tone 3 |        |
| 16 00          | Patch tone 4 |        |

\*1-3-1 Patch common

| Offset address | Description |   |
|----------------|-------------|---|
| 00 00          | 0aaa aaaa   | Patch name 1 32 - 127   |
| 00 01          | 0aaa aaaa   | Patch name 2 32 - 127   |
| 00 02          | 0aaa aaaa   | Patch name 3 32 - 127   |
| 00 03          | 0aaa aaaa   | Patch name 4 32 - 127   |
| 00 04          | 0aaa aaaa   | Patch name 5 32 - 127   |
| 00 05          | 0aaa aaaa   | Patch name 6 32 - 127   |
| 00 06          | 0aaa aaaa   | Patch name 7 32 - 127   |
| 00 07          | 0aaa aaaa   | Patch name 8 32 - 127   |
| 00 08          | 0aaa aaaa   | Patch name 9 32 - 127   |
| 00 09          | 0aaa aaaa   | Patch name 10 32 - 127  |
| 00 0A          | 0aaa aaaa   | Patch name 11 32 - 127  |
| 00 0B          | 0aaa aaaa   | Patch name 12 32 - 127  |
| 00 0C          | 00aa aaaa   | EFX:Type 0 - 39   |
| 00 0D          | 0aaa aaaa   | EFX:Parameter 1 0 - 127   |
| 00 0E          | 0aaa aaaa   | EFX:Parameter 2 0 - 127   |
| 00 0F          | 0aaa aaaa   | EFX:Parameter 3 0 - 127   |
| 00 10          | 0aaa aaaa   | EFX:Parameter 4 0 - 127   |
| 00 11          | 0aaa aaaa   | EFX:Parameter 5 0 - 127   |
| 00 12          | 0aaa aaaa   | EFX:Parameter 6 0 - 127   |
| 00 13          | 0aaa aaaa   | EFX:Parameter 7 0 - 127   |
| 00 14          | 0aaa aaaa   | EFX:Parameter 8 0 - 127   |
| 00 15          | 0aaa aaaa   | EFX:Parameter 9 0 - 127   |
| 00 16          | 0aaa aaaa   | EFX:Parameter 10 0 - 127  |
| 00 17          | 0aaa aaaa   | EFX:Parameter 11 0 - 127  |
| 00 18          | 0aaa aaaa   | EFX:Parameter 12 0 - 127  |
| 00 19          | 0000 00aa   | EFX:Output assign 0 - 2<br>(MIX,OUTPUT1,OUTPUT2)  |
| 00 1A          | 0aaa aaaa   | EFX:Output level 0 - 127  |
| 00 1B          | 0aaa aaaa   | EFX:Chorus send level 0 - 127   |
| 00 1C          | 0aaa aaaa   | EFX:Reverb send level 0 - 127   |
| 00 1D          | 0000 000a   | EFX:Control source 1 0 - 10<br>(OFF,SYS-CTRL1,SYS-CTRL2,MODULATION,BREATH,FOOT,VOLUME,PAN,EXPRESSION,BENDER,AFTERTOUCH) |
| 00 1E          | 0aaa aaaa   | EFX:Control depth 1 0 - 126<br>(-63 - +63)  |
| 00 1F          | 0000 000a   | EFX:Control source 2 0 - 10<br>(OFF,SYS-CTRL1,SYS-CTRL2,MODULATION,BREATH,FOOT,VOLUME,PAN,EXPRESSION,BENDER,AFTERTOUCH) |
| 00 20          | 0aaa aaaa   | EFX:Control depth 2 0 - 126<br>(-63 - +63)  |
| 00 21          | 0aaa aaaa   | Chorus:Level 0 - 127  |
| 00 22          | 0aaa aaaa   | Chorus:Rate 9 0 - 127   |
| 00 23          | 0aaa aaaa   | Chorus:Depth 0 - 127  |
| 00 24          | 0aaa aaaa   | Chorus:Pre delay 0 - 127  |
| 00 25          | 0aaa aaaa   | Chorus:Feedback 0 - 127   |
| 00 26          | 0000 00aa   | Chorus:Output assign 0 - 2  |

|            |           |   |
|------------|-----------|---|
| 00 27      | 0000 0aaa | Reverb:type 0 - 7<br>(ROOM1,ROOM2,STAGE1,STAGE2,HALL1,HALL2,DELAY,PAN-DRY)  |
| 00 28      | 0aaa aaaa | Reverb:Level 0 - 127  |
| 00 29      | 0aaa aaaa | Reverb:Time 0 - 127   |
| 00 2A      | 000a aaaa | Reverb:HF damp 0 - 17<br>(200,250,315,400,500,630,800,1000,1250,1600,2000,2500,3150,4000,5000,6300,8000,BYPASS)   |
| 00 2B      | 0aaa aaaa | Reverb:Feedback 0 - 127   |
| 00 2C      | 0000 aaaa | Default tempo 20 - 250  |
| 00 2E      | 0000 bbbb | Patch level 0 - 127   |
| 00 2F      | 0aaa aaaa | Patch pan 0 - 127<br>(L64 - 63R)  |
| 00 30      | 0aaa aaaa | Analog feel depth 0 - 127   |
| 00 31      | 0000 aaaa | Bender range up 0 - 12  |
| 00 32      | 00aa aaaa | Bender range down 0 - 48<br>(0 - -48)   |
| 00 33      | 0000 000a | Key assign mode 0 - 1<br>(POLY,SOLO)  |
| 00 34      | 0000 000a | Solo legato 0 - 1<br>(OFF,ON)   |
| 00 35      | 0000 000a | Portamento switch 0 - 1<br>(OFF,ON)   |
| 00 36      | 0000 000a | Portamento mode 0 - 1<br>(NORMAL,LEGATO)  |
| 00 37      | 0000 000a | Portamento type 0 - 1<br>(RATE,TIME)  |
| 00 38      | 0000 000a | Portamento start 0 - 1<br>(PITCH,NOTE)  |
| 00 39      | 0aaa aaaa | Portamento time 0 - 127   |
| 00 3A      | 0000 aaaa | Patch control source 2 0 - 15<br>(OFF,SYS-CTRL1,SYS-CTRL2,MODULATION,BREATH,FOOT,VOLUME,PAN,EXPRESSION,BENDER,AFTERTOUCH,LF01,LF02,VELOCITY,KEYFOLLOW,PLAYMATE) |
| 00 3B      | 0000 aaaa | Patch control source 3 0 - 15<br>(OFF,SYS-CTRL1,SYS-CTRL2,MODULATION,BREATH,FOOT,VOLUME,PAN,EXPRESSION,BENDER,AFTERTOUCH,LF01,LF02,VELOCITY,KEYFOLLOW,PLAYMATE) |
| 00 3C      | 0000 00aa | EFX control hold/peak 0 - 2<br>(OFF,HOLD,PEAK)  |
| 00 3D      | 0000 00aa | Control 1 hold/peak 0 - 2<br>(OFF,HOLD,PEAK)  |
| 00 3E      | 0000 00aa | Control 2 hold/peak 0 - 2<br>(OFF,HOLD,PEAK)  |
| 00 3F      | 0000 00aa | Control 3 hold/peak 0 - 2<br>(OFF,HOLD,PEAK)  |
| 00 40      | 0000 000a | Velocity range switch 0 - 1<br>(OFF,ON)   |
| 00 41      | 0000 0aaa | Octave shift 0 - 6<br>(-3 - +3)   |
| 00 42      | 0000 00aa | Stretch tune depth 0 - 3<br>(OFF,1 - 3)   |
| 00 43      | 0000 000a | Voice priority 0 - 1<br>(LAST,LOUDEST)  |
| 00 44      | 0000 aaaa | Structure type 1&2 0 - 9<br>(1 - 10)  |
| 00 45      | 0000 00aa | Booster level 1&2 0 - 3<br>(0,+6,+12,+18)   |
| 00 46      | 0000 aaaa | Structure type 3&4 0 - 9<br>(1 - 10)  |
| 00 47      | 0000 00aa | Booster level 3&4 0 - 3<br>(0,+6,+12,+18)   |
| Total size |           | 00 00 00 48   |

/ Example using RQ1 /  
To get the value of the portamento time of the patch temporary, send the following message to the JV-1080.  
FOH 41H 10H 6AH 11H 03H 00H 00H 39H 00H 00H 00H 01H 43H F7H

/ Example using DT1 /  
To set the structure 1&2 of the patch USER:48 to "TYPE 3", send the following message to the JV-1080.  
FOH 41H 10H 6AH 12H 11H 2FH 00H 44H 02H 7AH F7H

\*1-3-2 Patch tone

| Offset address | Description |  |
|----------------|-------------|--|
| 00 00          | 0000 000a   | Tone switch 0 - 1<br>(OFF,ON)  |
| 00 01          | 0000 00aa   | Wave group 0 - 2<br>(INT,PCM,EXP)  |
| 00 02          | 0aaa aaaa   | Wave group ID 0 - 127  |
| 00 03          | 0000 aaaa   | Wave number 0 - 254<br>(1 - 255)   |
| 00 05          | 0000 00aa   | Wave gain 0 - 3<br>(-6,0,+6,+12)   |
| 00 06          | 0000 000a   | FXM switch 0 - 1<br>(OFF,ON)   |
| 00 07          | 0000 00aa   | FXM color 0 - 3<br>(1 - 4)   |
| 00 08          | 0000 aaaa   | FXM depth 0 - 15<br>(1 - 16)   |
| 00 09          | 0000 0aaa   | Tone delay mode 0 - 6<br>(NORMAL,HOLD,KEY-INTERVAL,CLOCK-SYNC,TAP-SYNC,KEY-OFF-NORMAL,KEY-OFF-DECAY) |
| 00 0A          | 0aaa aaaa   | Tone delay time 0 - 127  |
| 00 0B          | 0aaa aaaa   | Velocity cross fade depth 0 - 127  |
| 00 0C          | 0aaa aaaa   | Velocity range lower 1 - 127   |
| 00 0D          | 0aaa aaaa   | Velocity range upper 1 - 127   |
| 00 0E          | 0aaa aaaa   | Key range lower 0 - 127<br>(C-1 - G9)  |
| 00 0F          | 0aaa aaaa   | Key range upper 0 - 127<br>(C-1 - G9)  |
| 00 10          | 0000 000a   | Redamper control switch 0 - 1<br>(OFF,ON)  |
| 00 11          | 0000 000a   | Volume control switch 0 - 1  |



|       |           |                                   |   |  |           |                                   |  |
|-------|-----------|-----------------------------------|---|--|-----------|-----------------------------------|--|
| 00 12 | 0000 000a | Hold-1 control switch             | (OFF,ON)<br>0 - 1   | 00 45  | 0000 aaaa | P-ENV time keyfollow              | 0 - 14<br>(-100,-70,-50,-40,-30,-20,-10,0,<br>+10,+20,+30,+40,+50,+70,+100)        |
| 00 13 | 0000 000a | Bender control switch             | (OFF,ON)<br>0 - 1   | 00 46  | 0aaa aaaa | P-ENV time 1                      | 0 - 127  |
| 00 14 | 0000 00aa | Pan control switch                | (OFF,ON)<br>0 - 2   | 00 47  | 0aaa aaaa | P-ENV time 2                      | 0 - 127  |
| 00 15 | 000a aaaa | Controller 1 destination 1        | (OFF,CONTINUOUS,KEY-ON)<br>0 - 18<br>(OFF, FCH, CUT, RES, LEV, PAN, MIX, CHO, REV,<br>PL1, PL2, FL1, FL2, AL1, AL2, pL1, pL2, L1R, L2R)           | 00 48  | 0aaa aaaa | P-ENV time 3                      | 0 - 127  |
| 00 16 | 0aaa aaaa | Controller 1 depth 1              | 0 - 126<br>(-63 - +63)  | 00 4A  | 0aaa aaaa | P-ENV level 1                     | 0 - 126<br>(-63 - +63)   |
| 00 17 | 000a aaaa | Controller 1 destination 2        | 0 - 18<br>(OFF, FCH, CUT, RES, LEV, PAN, MIX, CHO, REV,<br>PL1, PL2, FL1, FL2, AL1, AL2, pL1, pL2, L1R, L2R)                                      | 00 4B  | 0aaa aaaa | P-ENV level 2                     | 0 - 126<br>(-63 - +63)   |
| 00 18 | 0aaa aaaa | Controller 1 depth 2              | 0 - 126<br>(-63 - +63)  | 00 4C  | 0aaa aaaa | P-ENV level 3                     | 0 - 126<br>(-63 - +63)   |
| 00 19 | 000a aaaa | Controller 1 destination 3        | 0 - 18<br>(OFF, FCH, CUT, RES, LEV, PAN, MIX, CHO, REV,<br>PL1, PL2, FL1, FL2, AL1, AL2, pL1, pL2, L1R, L2R)                                      | 00 4D  | 0aaa aaaa | P-ENV level 4                     | 0 - 126<br>(-63 - +63)   |
| 00 1A | 0aaa aaaa | Controller 1 depth 3              | 0 - 126<br>(-63 - +63)  | 00 4E  | 0aaa aaaa | Pitch LFO 1 depth                 | 0 - 126<br>(-63 - +63)   |
| 00 1B | 000a aaaa | Controller 1 destination 4        | 0 - 18<br>(OFF, FCH, CUT, RES, LEV, PAN, MIX, CHO, REV,<br>PL1, PL2, FL1, FL2, AL1, AL2, pL1, pL2, L1R, L2R)                                      | 00 4F  | 0aaa aaaa | Pitch LFO 2 depth                 | 0 - 126<br>(-63 - +63)   |
| 00 1C | 0aaa aaaa | Controller 1 depth 4              | 0 - 126<br>(-63 - +63)  | 00 50  | 0000 0aaa | Filter type                       | 0 - 4<br>(OFF, LPF, BPF, HPF, PKG)   |
| 00 1D | 000a aaaa | Controller 2 destination 1        | 0 - 18<br>(OFF, FCH, CUT, RES, LEV, PAN, MIX, CHO, REV,<br>PL1, PL2, FL1, FL2, AL1, AL2, pL1, pL2, L1R, L2R)                                      | 00 51  | 0aaa aaaa | Cutoff frequency                  | 0 - 127  |
| 00 1E | 0aaa aaaa | Controller 2 depth 1              | 0 - 126<br>(-63 - +63)  | 00 52  | 0000 aaaa | Cutoff keyfollow                  | 0 - 15<br>(-100,-70,-50,-30,-10,0,+10,+20,+30,<br>+40,+50,+70,+100,+120,+150,+200) |
| 00 1F | 000a aaaa | Controller 2 destination 2        | 0 - 18<br>(OFF, FCH, CUT, RES, LEV, PAN, MIX, CHO, REV,<br>PL1, PL2, FL1, FL2, AL1, AL2, pL1, pL2, L1R, L2R)                                      | 00 53  | 0aaa aaaa | Resonance                         | 0 - 127  |
| 00 20 | 0aaa aaaa | Controller 2 depth 2              | 0 - 126<br>(-63 - +63)  | 00 54  | 0aaa aaaa | Resonance velocity sensitivity    | 0 - 125<br>(-50 - +200)  |
| 00 21 | 000a aaaa | Controller 2 destination 3        | 0 - 18<br>(OFF, FCH, CUT, RES, LEV, PAN, MIX, CHO, REV,<br>PL1, PL2, FL1, FL2, AL1, AL2, pL1, pL2, L1R, L2R)                                      | 00 55  | 0aaa aaaa | F-ENV depth                       | 0 - 126<br>(-63 - +63)   |
| 00 22 | 0aaa aaaa | Controller 2 depth 3              | 0 - 126<br>(-63 - +63)  | 00 56  | 0000 0aaa | F-ENV velocity curve              | 0 - 6<br>(1 - 7)   |
| 00 23 | 000a aaaa | Controller 2 destination 4        | 0 - 18<br>(OFF, FCH, CUT, RES, LEV, PAN, MIX, CHO, REV,<br>PL1, PL2, FL1, FL2, AL1, AL2, pL1, pL2, L1R, L2R)                                      | 00 57  | 0aaa aaaa | F-ENV velocity sensitivity        | 0 - 125<br>(-50 - +200)  |
| 00 24 | 0aaa aaaa | Controller 2 depth 4              | 0 - 126<br>(-63 - +63)  | 00 58  | 0000 aaaa | F-ENV velocity time 1 sensitivity | 0 - 14<br>(-100,-70,-50,-40,-30,-20,-10,0,<br>+10,+20,+30,+40,+50,+70,+100)        |
| 00 25 | 000a aaaa | Controller 3 destination 1        | 0 - 18<br>(OFF, FCH, CUT, RES, LEV, PAN, MIX, CHO, REV,<br>PL1, PL2, FL1, FL2, AL1, AL2, pL1, pL2, L1R, L2R)                                      | 00 59  | 0000 aaaa | F-ENV velocity time 4 sensitivity | 0 - 14<br>(-100,-70,-50,-40,-30,-20,-10,0,<br>+10,+20,+30,+40,+50,+70,+100)        |
| 00 26 | 0aaa aaaa | Controller 3 depth 1              | 0 - 126<br>(-63 - +63)  | 00 5A  | 0000 aaaa | F-ENV time keyfollow              | 0 - 14<br>(-100,-70,-50,-40,-30,-20,-10,0,<br>+10,+20,+30,+40,+50,+70,+100)        |
| 00 27 | 000a aaaa | Controller 3 destination 2        | 0 - 18<br>(OFF, FCH, CUT, RES, LEV, PAN, MIX, CHO, REV,<br>PL1, PL2, FL1, FL2, AL1, AL2, pL1, pL2, L1R, L2R)                                      | 00 5B  | 0aaa aaaa | F-ENV time 1                      | 0 - 127  |
| 00 28 | 0aaa aaaa | Controller 3 depth 2              | 0 - 126<br>(-63 - +63)  | 00 5C  | 0aaa aaaa | F-ENV time 2                      | 0 - 127  |
| 00 29 | 000a aaaa | Controller 3 destination 3        | 0 - 18<br>(OFF, FCH, CUT, RES, LEV, PAN, MIX, CHO, REV,<br>PL1, PL2, FL1, FL2, AL1, AL2, pL1, pL2, L1R, L2R)                                      | 00 5D  | 0aaa aaaa | F-ENV time 3                      | 0 - 127  |
| 00 2A | 0aaa aaaa | Controller 3 depth 3              | 0 - 126<br>(-63 - +63)  | 00 5E  | 0aaa aaaa | F-ENV time 4                      | 0 - 127  |
| 00 2B | 000a aaaa | Controller 3 destination 4        | 0 - 18<br>(OFF, FCH, CUT, RES, LEV, PAN, MIX, CHO, REV,<br>PL1, PL2, FL1, FL2, AL1, AL2, pL1, pL2, L1R, L2R)                                      | 00 5F  | 0aaa aaaa | F-ENV level 1                     | 0 - 127  |
| 00 2C | 0aaa aaaa | Controller 3 depth 4              | 0 - 126<br>(-63 - +63)  | 00 60  | 0aaa aaaa | F-ENV level 2                     | 0 - 127  |
| 00 2D | 0000 0aaa | LFO 1 waveform                    | 0 - 7<br>(TRI, SIN, SAW, SQW, TRP, SGH, RND, CHS)   | 00 61  | 0aaa aaaa | F-ENV level 3                     | 0 - 127  |
| 00 2E | 0000 000a | LFO 1 key trigger                 | 0 - 1<br>(OFF,ON)   | 00 62  | 0aaa aaaa | F-ENV level 4                     | 0 - 127  |
| 00 2F | 0aaa aaaa | LFO 1 rate                        | 0 - 127   | 00 63  | 0aaa aaaa | Filter LFO 1 depth                | 0 - 126<br>(-63 - +63)   |
| 00 30 | 0000 0aaa | LFO 1 level offset                | 0 - 4<br>(-100,-50,0,+50,+100)  | 00 64  | 0aaa aaaa | Filter LFO 2 depth                | 0 - 126<br>(-63 - +63)   |
| 00 31 | 0aaa aaaa | LFO 1 delay time                  | 0 - 127   | 00 65  | 0aaa aaaa | Tune level                        | 0 - 127  |
| 00 32 | 0000 00aa | LFO 1 fade mode                   | 0 - 3<br>(ON-IN, ON-OUT, OFF-IN, OFF-OUT)   | 00 66  | 0000 00aa | Bias direction                    | 0 - 3<br>(LOWER, UPPER, LAU, ALL)  |
| 00 33 | 0aaa aaaa | LFO 1 fade time                   | 0 - 127   | 00 67  | 0aaa aaaa | Bias point                        | 0 - 127<br>(C-1 - G9)  |
| 00 34 | 0000 00aa | LFO 1 external sync               | 0 - 2<br>(OFF, CLOCK, TAP)  | 00 68  | 0000 aaaa | Bias level                        | 0 - 14<br>(-100,-70,-50,-40,-30,-20,-10,0,<br>+10,+20,+30,+40,+50,+70,+100)        |
| 00 35 | 0000 0aaa | LFO 2 waveform                    | 0 - 7<br>(TRI, SIN, SAW, SQW, TRP, SGH, RND, CHS)   | 00 69  | 0000 0aaa | A-ENV velocity curve              | 0 - 6<br>(1 - 7)   |
| 00 36 | 0000 000a | LFO 2 key trigger                 | 0 - 1<br>(OFF,ON)   | 00 6A  | 0aaa aaaa | A-ENV velocity sensitivity        | 0 - 125<br>(-50 - +200)  |
| 00 37 | 0aaa aaaa | LFO 2 rate                        | 0 - 127   | 00 6B  | 0000 aaaa | A-ENV velocity time 1 sensitivity | 0 - 14<br>(-100,-70,-50,-40,-30,-20,-10,0,<br>+10,+20,+30,+40,+50,+70,+100)        |
| 00 38 | 0000 0aaa | LFO 2 level offset                | 0 - 4<br>(-100,-50,0,+50,+100)  | 00 6C  | 0000 aaaa | A-ENV velocity time 4 sensitivity | 0 - 14<br>(-100,-70,-50,-40,-30,-20,-10,0,<br>+10,+20,+30,+40,+50,+70,+100)        |
| 00 39 | 0aaa aaaa | LFO 2 delay time                  | 0 - 127   | 00 6D  | 0000 aaaa | A-ENV time keyfollow              | 0 - 14<br>(-100,-70,-50,-40,-30,-20,-10,0,<br>+10,+20,+30,+40,+50,+70,+100)        |
| 00 3A | 0000 00aa | LFO 2 fade mode                   | 0 - 3<br>(ON-IN, ON-OUT, OFF-IN, OFF-OUT)   | 00 6E  | 0aaa aaaa | A-ENV time 1                      | 0 - 127  |
| 00 3B | 0aaa aaaa | LFO 2 fade time                   | 0 - 127   | 00 6F  | 0aaa aaaa | A-ENV time 2                      | 0 - 127  |
| 00 3C | 0000 00aa | LFO 2 external sync               | 0 - 2<br>(OFF, CLOCK, TAP)  | 00 70  | 0aaa aaaa | A-ENV time 3                      | 0 - 127  |
| 00 3D | 0aaa aaaa | Coarse tune                       | 0 - 96<br>(-48 - +48)   | 00 71  | 0aaa aaaa | A-ENV time 4                      | 0 - 127  |
| 00 3E | 0aaa aaaa | Fine tune                         | 0 - 100<br>(-50 - +50)  | 00 72  | 0aaa aaaa | A-ENV level 1                     | 0 - 127  |
| 00 3F | 000a aaaa | Random pitch depth                | 0 - 30<br>(0, 1, 2, 3, 4, 5, 6, 7, 8, 9, 10, 20, 30, 40, 50,<br>60, 70, 80, 90, 100, 200, 300, 400, 500,<br>600, 700, 800, 900, 1000, 1100, 1200) | 00 73  | 0aaa aaaa | A-ENV level 2                     | 0 - 127  |
| 00 40 | 0000 aaaa | Pitch keyfollow                   | 0 - 15<br>(-100,-70,-50,-30,-10,0,+10,+20,+30,<br>+40,+50,+70,+100,+120,+150,+200)  | 00 74  | 0aaa aaaa | A-ENV level 3                     | 0 - 127  |
| 00 41 | 000a aaaa | P-ENV depth                       | 0 - 24<br>(-12 - +12)   | 00 75  | 0aaa aaaa | Amplitude LFO 1 depth             | 0 - 126<br>(-63 - +63)   |
| 00 42 | 0aaa aaaa | P-ENV velocity sensitivity        | 0 - 125<br>(-50 - +200)   | 00 76  | 0aaa aaaa | Amplitude LFO 2 depth             | 0 - 126<br>(-63 - +63)   |
| 00 43 | 0000 aaaa | P-ENV velocity time 1 sensitivity | 0 - 14<br>(-100,-70,-50,-40,-30,-20,-10,0,<br>+10,+20,+30,+40,+50,+70,+100)   | 00 77  | 0aaa aaaa | Tone pan                          | 0 - 127<br>(164 - 63R)   |
| 00 44 | 0000 aaaa | P-ENV velocity time 4 sensitivity | 0 - 14<br>(-100,-70,-50,-40,-30,-20,-10,0,<br>+10,+20,+30,+40,+50,+70,+100)   | 00 78  | 0000 aaaa | Pan keyfollow                     | 0 - 14<br>(-100,-70,-50,-40,-30,-20,-10,0,<br>+10,+20,+30,+40,+50,+70,+100)        |
| 00 45 | 0000 aaaa | P-ENV time keyfollow              | 0 - 14<br>(-100,-70,-50,-40,-30,-20,-10,0,<br>+10,+20,+30,+40,+50,+70,+100)   | 00 79  | 00aa aaaa | Random pan depth                  | 0 - 63   |
| 00 46 | 0aaa aaaa | P-ENV time 1                      | 0 - 127   | 00 7A  | 0aaa aaaa | Alternate pan depth               | 1 - 127<br>(163 - 63R)   |
| 00 47 | 0aaa aaaa | P-ENV time 2                      | 0 - 127   | 00 7B  | 0aaa aaaa | Pan LFO 1 depth                   | 0 - 126<br>(163 - 63R)   |
| 00 48 | 0aaa aaaa | P-ENV time 3                      | 0 - 127   | 00 7C  | 0aaa aaaa | Pan LFO 2 depth                   | 0 - 126<br>(163 - 63R)   |
| 00 4A | 0aaa aaaa | P-ENV level 1                     | 0 - 126<br>(-63 - +63)  | 00 7D  | 0000 00aa | Output assign                     | 0 - 3<br>(MIX, EFF, OUTPUT1, OUTPUT2)  |
| 00 4B | 0aaa aaaa | P-ENV level 2                     | 0 - 126<br>(-63 - +63)  | 00 7E  | 0aaa aaaa | Output level                      | 0 - 127  |
| 00 4C | 0aaa aaaa | P-ENV level 3                     | 0 - 126<br>(-63 - +63)  | 00 7F  | 0aaa aaaa | Chorus send level                 | 0 - 127  |
| 00 4D | 0aaa aaaa | P-ENV level 4                     | 0 - 126<br>(-63 - +63)  | 01 00  | 0aaa aaaa | Reverb send level                 | 0 - 127  |
| 00 4E | 0aaa aaaa | Pitch LFO 1 depth                 | 0 - 126<br>(-63 - +63)  | Total size 00 00 01 01   |           |                                   |  |
| 00 4F | 0aaa aaaa | Pitch LFO 2 depth                 | 0 - 126<br>(-63 - +63)  | Note: If the value of the wave number surpasses the number of waves contained in the corresponding wave group, this message will be ignored. |           |                                   |  |
| 00 50 | 0000 0aaa | Filter type                       | 0 - 4<br>(OFF, LPF, BPF, HPF, PKG)  | Note: If the value of the velocity range lower is greater than that of the velocity range upper, this message will be ignored.               |           |                                   |  |
| 00 51 | 0aaa aaaa | Cutoff frequency                  | 0 - 127   |  |           |                                   |  |
| 00 52 | 0000 aaaa | Cutoff keyfollow                  | 0 - 15<br>(-100,-70,-50,-30,-10,0,+10,+20,+30,<br>+40,+50,+70,+100,+120,+150,+200)  |  |           |                                   |  |
| 00 53 | 0aaa aaaa | Resonance                         | 0 - 127   |  |           |                                   |  |
| 00 54 | 0aaa aaaa | Resonance velocity sensitivity    | 0 - 125<br>(-50 - +200)   |  |           |                                   |  |
| 00 55 | 0aaa aaaa | F-ENV depth                       | 0 - 126<br>(-63 - +63)  |  |           |                                   |  |
| 00 56 | 0000 0aaa | F-ENV velocity curve              | 0 - 6<br>(1 - 7)  |  |           |                                   |  |
| 00 57 | 0aaa aaaa | F-ENV velocity sensitivity        | 0 - 125<br>(-50 - +200)   |  |           |                                   |  |
| 00 58 | 0000 aaaa | F-ENV velocity time 1 sensitivity | 0 - 14<br>(-100,-70,-50,-40,-30,-20,-10,0,<br>+10,+20,+30,+40,+50,+70,+100)   |  |           |                                   |  |
| 00 59 | 0000 aaaa | F-ENV velocity time 4 sensitivity | 0 - 14<br>(-100,-70,-50,-40,-30,-20,-10,0,<br>+10,+20,+30,+40,+50,+70,+100)   |  |           |                                   |  |
| 00 5A | 0000 aaaa | F-ENV time keyfollow              | 0 - 14<br>(-100,-70,-50,-40,-30,-20,-10,0,<br>+10,+20,+30,+40,+50,+70,+100)   |  |           |                                   |  |
| 00 5B | 0aaa aaaa | F-ENV time 1                      | 0 - 127   |  |           |                                   |  |
| 00 5C | 0aaa aaaa | F-ENV time 2                      | 0 - 127   |  |           |                                   |  |
| 00 5D | 0aaa aaaa | F-ENV time 3                      | 0 - 127   |  |           |                                   |  |
| 00 5E | 0aaa aaaa | F-ENV time 4                      | 0 - 127   |  |           |                                   |  |
| 00 5F | 0aaa aaaa | F-ENV level 1                     | 0 - 127   |  |           |                                   |  |
| 00 60 | 0aaa aaaa | F-ENV level 2                     | 0 - 127   |  |           |                                   |  |
| 00 61 | 0aaa aaaa | F-ENV level 3                     | 0 - 127   |  |           |                                   |  |
| 00 62 | 0aaa aaaa | F-ENV level 4                     | 0 - 127   |  |           |                                   |  |
| 00 63 | 0aaa aaaa | Filter LFO 1 depth                | 0 - 126<br>(-63 - +63)  |  |           |                                   |  |
| 00 64 | 0aaa aaaa | Filter LFO 2 depth                | 0 - 126<br>(-63 - +63)  |  |           |                                   |  |
| 00 65 | 0aaa aaaa | Tune level                        | 0 - 127   |  |           |                                   |  |
| 00 66 | 0000 00aa | Bias direction                    | 0 - 3<br>(LOWER, UPPER, LAU, ALL)   |  |           |                                   |  |
| 00 67 | 0aaa aaaa | Bias point                        | 0 - 127<br>(C-1 - G9)   |  |           |                                   |  |
| 00 68 | 0000 aaaa | Bias level                        | 0 - 14<br>(-100,-70,-50,-40,-30,-20,-10,0,<br>+10,+20,+30,+40,+50,+70,+100)   |  |           |                                   |  |
| 00 69 | 0000 0aaa | A-ENV velocity curve              | 0 - 6<br>(1 - 7)  |  |           |                                   |  |
| 00 6A | 0aaa aaaa | A-ENV velocity sensitivity        | 0 - 125<br>(-50 - +200)   |  |           |                                   |  |
| 00 6B | 0000 aaaa | A-ENV velocity time 1 sensitivity | 0 - 14<br>(-100,-70,-50,-40,-30,-20,-10,0,<br>+10,+20,+30,+40,+50,+70,+100)   |  |           |                                   |  |
| 00 6C | 0000 aaaa | A-ENV velocity time 4 sensitivity | 0 - 14<br>(-100,-70,-50,-40,-30,-20,-10,0,<br>+10,+20,+30,+40,+50,+70,+100)   |  |           |                                   |  |
| 00 6D | 0000 aaaa | A-ENV time keyfollow              | 0 - 14<br>(-100,-70,-50,-40,-30,-20,-10,0,<br>+10,+20,+30,+40,+50,+70,+100)   |  |           |                                   |  |
| 00 6E | 0aaa aaaa | A-ENV time 1                      | 0 - 127   |  |           |                                   |  |
| 00 6F | 0aaa aaaa | A-ENV time 2                      | 0 - 127   |  |           |                                   |  |
| 00 70 | 0aaa aaaa | A-ENV time 3                      | 0 - 127   |  |           |                                   |  |
| 00 71 | 0aaa aaaa | A-ENV time 4                      | 0 - 127   |  |           |                                   |  |
| 00 72 | 0aaa aaaa | A-ENV level 1                     | 0 - 127   |  |           |                                   |  |
| 00 73 | 0aaa aaaa | A-ENV level 2                     | 0 - 127   |  |           |                                   |  |
| 00 74 | 0aaa aaaa | A-ENV level 3                     | 0 - 127   |  |           |                                   |  |
| 00 75 | 0aaa aaaa | Amplitude LFO 1 depth             | 0 - 126<br>(-63 - +63)  |  |           |                                   |  |
| 00 76 | 0aaa aaaa | Amplitude LFO 2 depth             | 0 - 126<br>(-63 - +63)  |  |           |                                   |  |
| 00 77 | 0aaa aaaa | Tone pan                          | 0 - 127<br>(164 - 63R)  |  |           |                                   |  |
| 00 78 | 0000 aaaa | Pan keyfollow                     | 0 - 14<br>(-100,-70,-50,-40,-30,-20,-10,0,<br>+10,+20,+30,+40,+50,+70,+100)   |  |           |                                   |  |
| 00 79 | 00aa aaaa | Random pan depth                  | 0 - 63  |  |           |                                   |  |
| 00 7A | 0aaa aaaa | Alternate pan depth               | 1 - 127<br>(163 - 63R)  |  |           |                                   |  |
| 00 7B | 0aaa aaaa | Pan LFO 1 depth                   | 0 - 126<br>(163 - 63R)  |  |           |                                   |  |
| 00 7C | 0aaa aaaa | Pan LFO 2 depth                   | 0 - 126<br>(163 - 63R)  |  |           |                                   |  |
| 00 7D | 0000 00aa | Output assign                     | 0 - 3<br>(MIX, EFF, OUTPUT1, OUTPUT2)   |  |           |                                   |  |
| 00 7E | 0aaa aaaa | Output level                      | 0 - 127   |  |           |                                   |  |
| 00 7F | 0aaa aaaa | Chorus send level                 | 0 - 127   |  |           |                                   |  |
| 01 00 | 0aaa aaaa | Reverb send level                 | 0 - 127   |  |           |                                   |  |

/ Example of RQ1 /  
 To get the tone 2 data of the patch USER:02, send the following mes-  
 sage to the JV-1080.  
 FOH 41H 10H 6AH 11H 11H 01H 12H 00H 00H 00H 01H 01H 5AH F7H

/ Example of DT1 /  
 To set the cutoff frequency of the temporary patch tone 3 to 100,  
 send the following message to the JV-1080.  
 FOH 41H 10H 6AH 12H 03H 00H 14H 51H 64H 34H F7H

\*1-4 Rhythm setup

| Offset address | Description                  |        |
|----------------|------------------------------|--------|
| 00 00          | Rhythm common                | *1-4-1 |
| 23 00          | Rhythm note for key# 35 (B1) | *1-4-2 |
| 24 00          | Rhythm note for key# 36 (C2) |        |
| 62 00          | Rhythm note for key# 98 (E7) |        |

\*1-4-1 Rhythm common

| Offset address | Description    |          |
|----------------|----------------|----------|
| 00 00          | Rhythm name 1  | 32 - 127 |
| 00 01          | Rhythm name 2  | 32 - 127 |
| 00 02          | Rhythm name 3  | 32 - 127 |
| 00 03          | Rhythm name 4  | 32 - 127 |
| 00 04          | Rhythm name 5  | 32 - 127 |
| 00 05          | Rhythm name 6  | 32 - 127 |
| 00 06          | Rhythm name 7  | 32 - 127 |
| 00 07          | Rhythm name 8  | 32 - 127 |
| 00 08          | Rhythm name 9  | 32 - 127 |
| 00 09          | Rhythm name 10 | 32 - 127 |
| 00 0A          | Rhythm name 11 | 32 - 127 |
| 00 0B          | Rhythm name 12 | 32 - 127 |

Total size | 00 00 00 0C

\*1-4-2 Rhythm note

| Offset address | Description                     |  |
|----------------|---------------------------------|--|
| 00 00          | Tone switch                     | 0 - 1 (OFF,ON)   |
| 00 01          | Wave group                      | 0 - 2 (INP,PCM,EXP)  |
| 00 02          | Wave group ID                   | 0 - 127  |
| 00 03          | Wave number                     | 0 - 254 (1 - 255)  |
| 00 05          | Wave gain                       | 0 - 3 (-6,0,+6,+12)  |
| 00 06          | Bender range                    | 0 - 12   |
| 00 07          | Mute group                      | 0 - 31 (OFF,1 - 31)  |
| 00 08          | Envelope mode                   | 0 - 1 (NO-SUSTAIN,SUSTAIN)   |
| 00 09          | Volume control switch           | 0 - 1 (OFF,ON)   |
| 00 0A          | Hold-1 control switch           | 0 - 1 (OFF,ON)   |
| 00 0B          | Pan control switch              | 0 - 2 (OFF,CONTINUOUS,KEY-ON)  |
| 00 0C          | Source key                      | 0 - 127 (C-1 - G9)   |
| 00 0D          | Fine tune                       | 0 - 100 (-50 - +50)  |
| 00 0E          | Random pitch depth              | 0 - 30 (0,1,2,3,4,5,6,7,8,9,10,20,30,40,50,60,70,80,90,100,200,300,400,500,600,700,800,900,1000,1100,1200) |
| 00 0F          | P-ENV depth                     | 0 - 24 (-12 - +12)   |
| 00 10          | P-ENV velocity sensitivity      | 0 - 125 (-50 - +200)   |
| 00 11          | P-ENV velocity time sensitivity | 0 - 14 (-100,-70,-50,-40,-30,-20,-10,0,+10,+20,+30,+40,+50,+70,+100)                                       |
| 00 12          | P-ENV time 1                    | 0 - 127  |
| 00 13          | P-ENV time 2                    | 0 - 127  |
| 00 14          | P-ENV time 3                    | 0 - 127  |
| 00 15          | P-ENV time 4                    | 0 - 127  |
| 00 16          | P-ENV level 1                   | 0 - 126 (-63 - +63)  |
| 00 17          | P-ENV level 2                   | 0 - 126 (-63 - +63)  |
| 00 18          | P-ENV level 3                   | 0 - 126 (-63 - +63)  |
| 00 19          | P-ENV level 4                   | 0 - 126 (-63 - +63)  |
| 00 1A          | Filter type                     | 0 - 4 (OFF,LPF,BPF,HFP,PKG)  |
| 00 1B          | Cutoff frequency                | 0 - 127  |
| 00 1C          | Resonance                       | 0 - 127  |
| 00 1D          | Resonance velocity sensitivity  | 0 - 125 (-50 - +200)   |
| 00 1E          | F-ENV depth                     | 0 - 126 (-63 - +63)  |
| 00 1F          | F-ENV velocity sensitivity      | 0 - 125 (-50 - +200)   |
| 00 20          | F-ENV velocity time sensitivity | 0 - 14 (-100,-70,-50,-40,-30,-20,-10,0,+10,+20,+30,+40,+50,+70,+100)                                       |
| 00 21          | F-ENV time 1                    | 0 - 127  |
| 00 22          | F-ENV time 2                    | 0 - 127  |
| 00 23          | F-ENV time 3                    | 0 - 127  |
| 00 24          | F-ENV time 4                    | 0 - 127  |
| 00 25          | F-ENV level 1                   | 0 - 127  |

|       |           |                                 |  |
|-------|-----------|---------------------------------|--|
| 00 26 | 0aaa aaaa | F-ENV level 2                   | 0 - 127  |
| 00 27 | 0aaa aaaa | F-ENV level 3                   | 0 - 127  |
| 00 28 | 0aaa aaaa | F-ENV level 4                   | 0 - 127  |
| 00 29 | 0aaa aaaa | Tone level                      | 0 - 127  |
| 00 2A | 0aaa aaaa | A-ENV velocity sensitivity      | 0 - 125 (-50 - +200)   |
| 00 2B | 0000 aaaa | A-ENV velocity time sensitivity | 0 - 14 (-100,-70,-50,-40,-30,-20,-10,0,+10,+20,+30,+40,+50,+70,+100) |
| 00 2C | 0aaa aaaa | A-ENV time 1                    | 0 - 127  |
| 00 2D | 0aaa aaaa | A-ENV time 2                    | 0 - 127  |
| 00 2E | 0aaa aaaa | A-ENV time 3                    | 0 - 127  |
| 00 2F | 0aaa aaaa | A-ENV time 4                    | 0 - 127  |
| 00 30 | 0aaa aaaa | A-ENV level 1                   | 0 - 127  |
| 00 31 | 0aaa aaaa | A-ENV level 2                   | 0 - 127  |
| 00 32 | 0aaa aaaa | A-ENV level 3                   | 0 - 127  |
| 00 33 | 0aaa aaaa | Tone pan                        | 0 - 127 (L64 - 63R)  |
| 00 34 | 00aa aaaa | Random pan depth                | 0 - 63   |
| 00 35 | 0aaa aaaa | Alternate pan depth             | 1 - 127 (L63 - 63R)  |
| 00 36 | 0000 00aa | Output assign                   | 0 - 3 (MIX,EFX,OUTPUT1,OUTPUT2)                                      |
| 00 37 | 0aaa aaaa | Output level                    | 0 - 127  |
| 00 38 | 0aaa aaaa | Chorus send level               | 0 - 127  |
| 00 39 | 0aaa aaaa | Reverb send level               | 0 - 127  |

Total size --| 00 00 00 3A

Note: If the value of the wave number surpasses the number of waves contained in the corresponding wave group, this message will be ignored.

/ Example using RQ1 /  
 To get the C2 note data of the temporary rhythm setup, send the following message to the JV-1080.  
 FOH 41H 10H 6AH 11H 02H 09H 24H 00H 00H 00H 00H 3AH 17H F7H

/ Example using DT1 /  
 To turn off (Tone switch = off) the key note D2 of the rhythm setup (part 10) of the temporary selected performance, send the following message to the JV-1080.  
 FOH 41H 10H 6AH 12H 02H 09H 26H 00H 00H 4FH F7H

| Address     | Block                            | Sub block | Reference |
|-------------|----------------------------------|-----------|-----------|
| 00 00 00 00 | System common                    |           | 1-1-1     |
|             | Scale tune                       | Part 1    | 1-1-2     |
| 01 00 00 00 | Temporary performance            | Common    | 1-2-1     |
|             |                                  | Part 1    | 1-2-2     |
| 02 00 00 00 | Performance mode temporary patch | Part 1    | 1-3-1     |
|             |                                  | Common    | 1-3-1     |
|             |                                  | Part 9    | 1-3-2     |
|             |                                  | Tone 1    | 1-3-2     |
|             |                                  | Tone 4    | 1-3-2     |
| 02 09 00 00 | Temporary rhythm setup           | Common    | 1-4-1     |
|             |                                  | Note# 35  | 1-4-2     |
|             |                                  | Note# 98  | 1-4-2     |
| 02 0A 00 00 | Performance mode temporary patch | Part 11   | 1-3-1     |
|             |                                  | Common    | 1-3-1     |
|             |                                  | Part 16   | 1-3-2     |
|             |                                  | Tone 1    | 1-3-2     |
|             |                                  | Tone 4    | 1-3-2     |
| 03 00 00 00 | Patch mode temporary patch       | Common    | 1-3-1     |
|             |                                  | Tone 1    | 1-3-2     |
|             |                                  | Tone 4    | 1-3-2     |

|             |                        |          |          |       |
|-------------|------------------------|----------|----------|-------|
| 10 00 00 00 | User performance       | USER:01  | Common   | 1-2-1 |
|             |                        | :        |          |       |
|             |                        | USER:32  |          |       |
|             |                        | :        |          |       |
|             |                        |          | Part 1   | 1-2-2 |
|             |                        | :        |          |       |
|             |                        |          |          |       |
|             |                        |          | Part 16  |       |
| 10 40 00 00 | User rhythm setup      | USER:1   | Common   | 1-4-1 |
|             |                        | :        |          |       |
|             |                        | USER:2   | Note# 35 | 1-4-2 |
|             |                        | :        |          |       |
|             |                        |          |          |       |
|             |                        |          | Note# 98 |       |
| 11 00 00 00 | User patch             | USER:001 | Common   | 1-3-1 |
|             |                        | :        |          |       |
|             |                        |          | Tone 1   | 1-3-2 |
|             |                        | :        |          |       |
|             |                        | USER:128 |          |       |
|             |                        | :        |          |       |
|             |                        |          |          |       |
|             |                        |          | Tone 4   |       |
| 20 00 00 00 | Data card performance  | CARD:01  | Common   | 1-2-1 |
|             |                        | :        |          |       |
|             |                        | CARD:32  | Part 1   | 1-2-2 |
|             |                        | :        |          |       |
|             |                        |          |          |       |
|             |                        |          | Part 16  |       |
| 20 40 00 00 | Data card rhythm setup | CARD:1   | Common   | 1-4-1 |
|             |                        | :        |          |       |
|             |                        | CARD:2   | Note# 35 | 1-4-2 |
|             |                        | :        |          |       |
|             |                        |          |          |       |
|             |                        |          | Note# 98 |       |
| 21 00 00 00 | Data card patch        | CARD:001 | Common   | 1-3-1 |
|             |                        | :        |          |       |
|             |                        |          | Tone 1   | 1-3-2 |
|             |                        | :        |          |       |
|             |                        | CARD:128 |          |       |
|             |                        | :        |          |       |
|             |                        |          |          |       |
|             |                        |          | Tone 4   |       |

●Table A-1::Decimal to Hexadecimal

The MIDI messages are expressed in hexadecimal configured in 7 bits. This table is useful when you read or write MIDI messages.

(D)=decimal  
(H)=hexadecimal

|     |     |     |     |     |     |     |     |
|-----|-----|-----|-----|-----|-----|-----|-----|
| (D) | (H) | (D) | (H) | (D) | (H) | (D) | (H) |
| 0   | 00H | 32  | 20H | 64  | 40H | 96  | 60H |
| 1   | 01H | 33  | 21H | 65  | 41H | 97  | 61H |
| 2   | 02H | 34  | 22H | 66  | 42H | 98  | 62H |
| 3   | 03H | 35  | 23H | 67  | 43H | 99  | 63H |
| 4   | 04H | 36  | 24H | 68  | 44H | 100 | 64H |
| 5   | 05H | 37  | 25H | 69  | 45H | 101 | 65H |
| 6   | 06H | 38  | 26H | 70  | 46H | 102 | 66H |
| 7   | 07H | 39  | 27H | 71  | 47H | 103 | 67H |
| 8   | 08H | 40  | 28H | 72  | 48H | 104 | 68H |
| 9   | 09H | 41  | 29H | 73  | 49H | 105 | 69H |
| 10  | 0AH | 42  | 2AH | 74  | 4AH | 106 | 6AH |
| 11  | 0BH | 43  | 2BH | 75  | 4BH | 107 | 6BH |
| 12  | 0CH | 44  | 2CH | 76  | 4CH | 108 | 6CH |
| 13  | 0DH | 45  | 2DH | 77  | 4DH | 109 | 6DH |
| 14  | 0EH | 46  | 2EH | 78  | 4EH | 110 | 6EH |
| 15  | 0FH | 47  | 2FH | 79  | 4FH | 111 | 6FH |
| 16  | 10H | 48  | 30H | 80  | 50H | 112 | 70H |
| 17  | 11H | 49  | 31H | 81  | 51H | 113 | 71H |
| 18  | 12H | 50  | 32H | 82  | 52H | 114 | 72H |
| 19  | 13H | 51  | 33H | 83  | 53H | 115 | 73H |
| 20  | 14H | 52  | 34H | 84  | 54H | 116 | 74H |
| 21  | 15H | 53  | 35H | 85  | 55H | 117 | 75H |
| 22  | 16H | 54  | 36H | 86  | 56H | 118 | 76H |
| 23  | 17H | 55  | 37H | 87  | 57H | 119 | 77H |
| 24  | 18H | 56  | 38H | 88  | 58H | 120 | 78H |
| 25  | 19H | 57  | 39H | 89  | 59H | 121 | 79H |
| 26  | 1AH | 58  | 3AH | 90  | 5AH | 122 | 7AH |
| 27  | 1BH | 59  | 3BH | 91  | 5BH | 123 | 7BH |
| 28  | 1CH | 60  | 3CH | 92  | 5CH | 124 | 7CH |
| 29  | 1DH | 61  | 3DH | 93  | 5DH | 125 | 7DH |
| 30  | 1EH | 62  | 3EH | 94  | 5EH | 126 | 7EH |
| 31  | 1FH | 63  | 3FH | 95  | 5FH | 127 | 7FH |

\*The decimal value of MIDI channel, bank select, program change, etc is the decimal number in the table plus 1.  
\*In the hexadecimal notation in configured 7 bits, the maximum data of 1 byte is 128. If the data is more than 128, used plural bytes.  
\*The signed value is 00H = -64, 40H ±0, 7FH = +63. In decimal notation, the value is decimal number in the table minus 64. The signed value of dual bytes is 00 00H = -8192, 40 00H = ±0, 7F 7FH = +8191. For example, converted aaH bbH (hex) to decimal to the following: aa bbH = 40 00 H = aa x 128 + bb = 64 x 128.

●TABLE A-2: ASCII code

Patch Name and Performance Name of MIDI data are described the ASCII code in the table below.

(C)=Character  
(H)=hexadecimal

|     |     |     |     |     |     |
|-----|-----|-----|-----|-----|-----|
| (C) | (H) | (C) | (H) | (C) | (H) |
| SP  | 20H |     |     |     |     |
| A   | 41H | a   | 61H | 1   | 31H |
| B   | 42H | b   | 62H | 2   | 32H |
| C   | 43H | c   | 63H | 3   | 33H |
| D   | 44H | d   | 64H | 4   | 34H |
| E   | 45H | e   | 65H | 5   | 35H |
| F   | 46H | f   | 66H | 6   | 36H |
| G   | 47H | g   | 67H | 7   | 37H |
| H   | 48H | h   | 68H | 8   | 38H |
| I   | 49H | i   | 69H | 9   | 39H |
| J   | 4AH | j   | 6AH | 0   | 30H |
| K   | 4BH | k   | 6BH | -   | 2BH |
| L   | 4CH | l   | 6CH | -   | 2DH |
| M   | 4DH | m   | 6DH | *   | 2AH |
| N   | 4EH | n   | 6EH | /   | 2FH |
| O   | 4FH | o   | 6FH | #   | 23H |
| P   | 50H | p   | 70H | !   | 21H |
| Q   | 51H | q   | 71H | !   | 2CH |
| R   | 52H | r   | 72H | !   | 2EH |
| S   | 53H | s   | 73H |     |     |
| T   | 54H | t   | 74H |     |     |
| U   | 55H | u   | 75H |     |     |
| V   | 56H | v   | 76H |     |     |
| W   | 57H | w   | 77H |     |     |
| X   | 58H | x   | 78H |     |     |
| Y   | 59H | y   | 79H |     |     |
| Z   | 5AH | z   | 7AH |     |     |

Note: "SP" is space.

2 GS

< MODEL ID = 42H >

| Start address | Description           |
|---------------|-----------------------|
| 40 10 00      | Scale Tune Part10 2-1 |
| 40 11 00      | : Part1               |
| 40 12 00      | : Part2               |
| 40 13 00      | : Part3               |
| 40 14 00      | : Part4               |
| 40 15 00      | : Part5               |
| 40 16 00      | : Part6               |
| 40 17 00      | : Part7               |
| 40 18 00      | : Part8               |
| 40 19 00      | : Part9               |
| 40 1A 00      | : Part11              |
| 40 1B 00      | : Part12              |
| 40 1C 00      | : Part13              |
| 40 1D 00      | : Part14              |
| 40 1E 00      | : Part15              |
| 40 1F 00      | : Part16              |

| Offset address | Description                                 |
|----------------|---|
| 40             | 0aaa aaaa Scale Tune C 00 - 127 (-64 - +63) |
| 41             | : : : C#                                    |
| 42             | : : : D                                     |
| 43             | : : : D#                                    |
| 44             | : : : E                                     |
| 45             | : : : F                                     |
| 46             | : : : F#                                    |
| 47             | : : : G                                     |
| 48             | : : : G#                                    |
| 49             | : : : A                                     |
| 4A             | : : : A#                                    |
| 4B             | : : : B                                     |

Total Size 00 00 00 0C

/ Example using DT1 /  
To set the scale tune (C-B) of the performance part 1 Arabia, send the data as follows:  
F0H 41H 10H 42H 12H 40H 11H 40H 3AH 6DH 3EH 34H 0DH 38H 6BH 3CH 6FH 40H 16H 0FH 76H F7H

# MIDI Implementation Chart

| Function...      |  | Transmitted                | Recognized                             | Remarks   |
|------------------|--|----------------------------|--|---|
| Basic Channel    | Default Changed  | X<br>X                     | 1 - 16, OFF<br>1 - 16, OFF             | Memorized   |
| Mode             | Default Messages Altered   | X<br>X<br>*****            | Mode 3<br>Mode 3, 4 (M=1)              |   |
| Note Number :    | True Voice   | X<br>*****                 | 0 - 127<br>0 - 127                     |   |
| Velocity         | Note ON<br>Note OFF  | X<br>X                     | O<br>O                                 |   |
| After Touch      | Key's<br>Ch's  | X<br>X                     | O * 1<br>O * 1                         |   |
| Pitch Bend       |  | X                          | O * 1                                  | Resolution : 9 bits   |
| Control Change   | 0 - 95   | X                          | O * 2                                  | Bank select<br>Modulation<br>Breath<br>Foot type<br>Portamento time<br>Data entry<br>Volume<br>Balance<br>Panpot<br>Expression<br>Hold 1<br>Portamento<br>Sostenuto<br>Soft pedal<br>Hold 2<br>Portamento control<br>General purpose effects 1 (Reverb)<br>General purpose effects 3 (Chorus)<br>RPN LSB, MSB |
|                  | 0, 32  | X                          | O * 1                                  |   |
|                  | 1  | X                          | O * 1                                  |   |
|                  | 2  | X                          | O * 1                                  |   |
|                  | 4  | X                          | O * 1                                  |   |
|                  | 5  | X                          | O * 1                                  |   |
|                  | 6, 38  | X                          | O * 1                                  |   |
|                  | 7  | X                          | O * 1                                  |   |
|                  | 8  | X                          | O * 1                                  |   |
|                  | 10   | X                          | O * 1                                  |   |
|                  | 11   | X                          | O * 1                                  |   |
|                  | 64   | X                          | O * 1                                  |   |
|                  | 65   | X                          | O * 1                                  |   |
|                  | 66   | X                          | O * 1                                  |   |
|                  | 67   | X                          | O * 1                                  |   |
| 69               | X  | O * 1                      |  |   |
| 84               | X  | O * 1                      |  |   |
| 91               | X  | O * 1                      |  |   |
| 93               | X  | O * 1                      |  |   |
| 100, 101         | X  | O * 1                      |  |   |
| Prog Change      | : True #   | X<br>*****                 | O * 1<br>0 - 127                       | Program Number 1 - 128  |
| System Exclusive |  | O                          | O * 1                                  |   |
| System Common    | : Song Pos<br>: Song Sel<br>: Tune   | X<br>X<br>X                | X<br>X<br>X                            |   |
| System Real Time | : Clock<br>: Commands  | X<br>X                     | O * 1<br>X                             |   |
| Aux Message      | : All Sound OFF<br>: Reset All Controllers<br>: Local ON/OFF<br>: All Notes OFF<br>: Active Sense<br>: Reset | X<br>X<br>X<br>X<br>X<br>X | O<br>O<br>X<br>O (123 - 127)<br>O<br>X |   |
| Notes            | * 1 Can be set to O or X manually and memorized.<br>* 2 Can be changed manually and memorized.               |                            |  |   |

Mode 1 : OMNI ON, POLY

Mode 2 : OMNI ON, MONO

O : Yes

Mode 3 : OMNI OFF, POLY

Mode 4 : OMNI OFF, MONO

X : No

# Index

## How-to Index

- I Want to Change the Volume
  - Changing the volume for a Part.....P.60 (Performance)  
.....P.78 (GM)
  - Changing the volume for a Patch .....P.42
  - Changing the volume for a Tone.....P.55 (Patch)  
.....P.65 (Rhythm Set)
  - Changing the TVA envelope.....P.56 (Patch)  
.....P.65 (Rhythm Set)
  - Amplifying a wave .....P.50 (Patch)  
.....P.64 (Rhythm Set)
  - Changing the volume according to the keyboard position .....P.55
  - Changing the volume with key velocity .....P.55 (Patch)  
.....P.65 (Rhythm Set)
- I Want to Change the Pitch
  - Changing the overall pitch .....P.68
  - Changing the basic pitch for a Part .....P.60(Performance)  
.....P.78 (GM)
  - Changing the basic pitch for a Tone .....P.52
  - Changing the pitch envelope .....P.53 (Patch)  
.....P. 64 (Rhythm Set)
- I Want to Change the Pan settings
  - Changing the pan settings for Patches.....P.42
  - Changing the pan settings for Tones .....P.55 (Patch)  
.....P.65 (Rhythm Set)
  - Making Pan Change according to the keyboard position.....P.55 (Patch)
  - Changing the sound image randomly with each key stroke.....P.56 (Patch)  
.....P. 65 (Rhythm Set)
- I Want to Make Sounds Thicker and Fatter
  - Selecting waves with a fat sound .....P.50 (Patch)  
.....P.63 (Rhythm Set)
  - Making copies of the same Tone overlap with the pitch shifted .....P.52 (Patch)
  - Making a number of different Tones overlap .....P.32
  - Changing the stereo position for each of the Tones .....P.55 (Patch)  
.....P.65 (Rhythm Set)
  - Setting different Patches to the same receive channel and making Patches overlap.....P.59
  - Using Chorus.....P.46 (Patch)  
.....P.59 (Performance)  
.....P.62 (Rhythm Set)  
.....P.87—89 (EFX)
  - Using Reverb .....P.46 (Patch)  
.....P.59 (Performance)  
.....P.62 (Rhythm Set)  
.....P.94—95 (EFX)
- I Want to Make a Sound Harder or Softer
  - Selecting waves with a hard or soft sound ....P.50 (Patch)  
.....P.63 (Rhythm Set)
  - Using HPF or LPF as the filter .....P.54 (Patch)  
.....P.64 (Rhythm Set)
  - Adjusting the cutoff frequency .....P.54(Patch)  
.....P.64 (Rhythm Set)
  - Changing the cutoff frequency according to the keyboard position .....P.54
  - Changing the cutoff frequency with key velocity .....P.54 (Patch)  
.....P.65(Rhythm Set)
  - Changing the TVF envelope.....P.55 (Patch)  
.....P.65 (Rhythm Set)
  - Using the equalizer .....P.84
- I Want to Add Undulations to a Sound
  - Using Analog Feel .....P.42
  - Using the LFO.....P.51
  - Applying modulation effects.....P87—90
- I Want to Make a Sound Stand Out
  - Using the Booster .....P.44
  - Using FXM .....P.50
  - Applying distortion effects.....P.84, P.85
- I Want to Play a Single Sound
  - Setting the Solo switch to ON.....P.47
  - Using Portamento .....P.47
- I Want to Make the Sound Change According to the Keyboard Position
  - Setting Key Range.....P.43 (Patch)  
.....P.57 (Performance)
- I Want to Control Parameters with an External MIDI Device
  - Setting the MIDI channels .....P.67 (Patch)  
.....P.59, P.66 (Performance)
  - Setting the MIDI Receive switch to ON .....P.68  
.....P.59 (Performance)
  - Choosing a Controller to use.....P.46 (Patch)  
.....P.59 (Performance)  
.....P.62 (Rhythm Set)
  - Choosing the parameters to control .....P.49
- I Want to Change the Output Jack for the Sound
  - Changing the output destinations for Tones ....P.45 (Patch)  
.....P.61 (Rhythm Set)
  - Changing the output destinations for Parts.....P.57 (Performance)  
.....P.61 (GM)
  - Changing the output destination for an Effect ..P.45 (Patch)  
.....P.58 (Performance)  
.....P.61 (Rhythm Set)  
.....P.77 (GM)
- I Want to Send and Receive Exclusive (SysEx) Data
  - Setting the Unit Numbers .....P.67

- Switching off Protect.....P.72
- I want to change sounds
  - Selecting sounds using the module's panel.....P.29
  - Using an external device to select sounds .....P.79
- I want to apply effect
  - Turning on/off effects switches.....P.38
  - Outputting the original sound with the effect .....P.47 (Patch)
    - .....P.57 (Performance)
    - .....P.61 (Rhythm Set)
    - .....P.77 (GM)
  - Setting the parameters for effects .....P.45—47 (Patch)
    - .....P.57—59 (Performance)
    - .....P.61—63 (Rhythm Set)
    - .....P.77—78 (GM)
    - .....P.84—99 (EFX)
- I want to use cards or expansion boards
  - Inserting the card into the slot.....P.31
  - Initializing DATA cards .....P.73
  - Saving onto a DATA card .....P.70—74
  - Reading from a DATA card.....P.71—74
  - Swapping the module's internal contents with that of a DATA card.....P.73
- I want to play back GM music data
  - Switching to the GM mode .....P.77

## Index

### [A]

- AC Inlet....P.7
- Acceleration....P.93
- Aftertouch Source....P.17,P.35
- Aftertouch....P.40,P.46,P.49,P.58,P.62,P.68
- Alternate Pan Depth....P.56,P.65
- Amp Type....P.84-85
- Amplitude LFO Depth 1,2....P.52
- Analog Feel Depth....P.42
- AUTO-WAH....P.86

### [B]

- Balance....P.39
- Band 1-8 Level....P.85
- Band Width....P.85
- Bank Select....P.68,P.80
- Bender....P.68
- Bender Control Switch....P.48
- Bender Range Down....P.47
- Bender Range Up....P.47
- Bender Range....P.63
- Bias....P.55
- Bias Direction....P.55
- Bias Level....P.55
- Bias Point....P.55

- Block Copy....P.73
- Booster....P.44
- Booster Level....P.44
- BPF (Band Pass Filter)....P.54,P.64
- Breath....P.39,P.46,P.49,P.58,P.62
- Bulk Dump....P.74

### [C]

- Card....P.23,P.31,P.72
- Card Copy....P.73
- Card Swap....P.73
- Center Level....P.92
- Chorus....P.25,P.46,P.59,P.62,P.77
- CHORUS/FLANGER....P.99
- Chorus Balance....P.95,P.97-98
- Chorus Depth....P.46,P.59,P.62,P.77,P.87-89,P.98-99
- Chorus Feedback....P.46,P.59,P.62,P.77
- Chorus Level....P.46,P.59,P.62,P.77
- Chorus Output Assign....P.46,P.59,P.62,P.77
- Chorus Pre Delay....P.95,P.97-98
- Chorus Rate....P.46,P.59,P.62,P.77,P.87-88,P.95,P.98-99
- Chorus Send Level....P.45,P.58,P.61-62,P.77
- CHORUS->DELAY....P.98
- CHORUS->FLANGER....P.99
- CHORUS/DELAY....P.99
- Clock Source....P.66-67
- Coarse Pitch....P.93-94
- Coarse Tune....P.52
- Compare....P.18,P.70
- Compressor....P.87
- Control 1-3 Hold/Peak....P.49
- Control Change....P.68
- Control Channel....P.66
- Control Depth 1-4....P.48,P.80
- Control Destination 1-4....P.49,P.80
- Copy....P.71
- Cursor Button....P.6,P.35
- Cutoff Frequency....P.54,P.64,P.89
- Cutoff Keyfollow....P.54

### [D]

- DATA Card....P.23,P.29,P.39,P.72
- DATA Card Slot....P.31
- Default Tempo....P.42,P.57
- Delay Balance....P.96,P.98-99
- Delay Feedback....P.47,P.59,P.63,P.78,P.96-98
- Delay HF Damp....P.96-98
- Delay Time....P.90-93,P.97-98
- Depth Deviation....P.87
- DISTORTION....P.84
- DISTORTION->CHORUS....P.96
- DISTORTION->DELAY....P.96
- DISTORTION->FLANGER....P.96
- Drive....P.84

### [E]

- Effect Balance....P.88-95

- 
- Effect ON/OFF....P.38
  - EFX....P.25,P.81,P.83
  - EFX Control Depth 1,2....P.46,P.58,P.62,P.80
  - EFX Control Hold/Peak....P.48
  - EFX Control Source 1,2....P.46,P.58,P.62,P.80
  - EFX Parameter....P.45,P.58,P.61,P.77,P.83
  - EFX Source....P.58,P.61
  - EFX Type....P.45,P.58,P.61,P.77
  - ENHANCER....P.86
  - ENHANCER->CHORUS....P.97
  - ENHANCER->DELAY...P.97
  - ENHANCER->FLANGER....P.97
  - Enter Button....P.7
  - Envelope Mode....P.63
  - Error Message.... P.102
  - Exclusive Protect....P.72
  - Exit Button....P.7
  - Expansion Board....P.23,P.31,P.39
  - Expression....P.40,P.46,P.49,P.58,P.62
- [F]**
- Factory Preset....P.74
  - Fade Mode....P.52
  - Fade Time....P.52
  - Feedback....P.89-94
  - Feedback Mode....P.90-91
  - FBK-PITCH-SHIFTER....P.94
  - Filter LFO Depth 1,2....P.52
  - Filter Type....P.54,P.64,P.86,P.89
  - Fine Pitch....P.93-94
  - Fine Tune....P.53,P.64
  - Flanger Balance....P.96-99
  - Flanger Depth....P.96-99
  - Flanger Feedback....P.96-99
  - Flanger Pre Delay....P.95,P.97-99
  - Flanger Rate....P.99
  - FLANGER->DELAY....P.98
  - FLANGER/DELAY....P.99
  - Foot....P.39,P.46,P.49,P.58,P.62
  - Format....P.73
  - Function Select Button....P.6
  - FXM Color....P.50
  - FXM Depth....P.50
  - FXM Switch....P.50
- [G]**
- Gate Time....P.95
  - GATE-REVERB....P.95
  - GM Mode....P.24,P.77
  - GM Score....P.77
  - GM System On Message....P.77
- [H]**
- HEXA-CHORUS....P.87
  - High Frequency Damp....P.47,P.59,P.62,P.78,P.90-94
  - High Frequency Acceleration....P.86
  - High Frequency Fast Rate....P.86
  - High Frequency Level....P.86
  - High Frequency Slow Rate....P.86
  - High Frequency....P.84
  - High Gain....P.84-95
  - Hold Control Source....P.67
  - Hold-1....P.40,P.68
  - Hold-1 Control Switch....P.48,P.63
  - HPF (High Pass Filter)....P.54,P.64
- [I]**
- INC/DEC Button....P.6,P.35
  - Information Function....P.38
  - Initialize....P.72
  - Internal Protect....P.72
- [K]**
- Key Assign Mode....P.47
  - Key Range....P.43,P.57
  - Key Range Lower....P.43,P.57
  - Key Range Switch....P.57
  - Key Range Upper....P.43,P.57
  - Key Trigger....P.51
- [L]**
- LCD Contrast....P.66
  - Left Level....P.92
  - Level 1,2,3,4....P.92
  - Level Balance....P.94
  - Level Offset....P.52
  - LFO 1/2....P.49,P.51-52
  - LFO Depth....P.51
  - LFO External Sync....P.51
  - LFO Rate....P.51
  - LFO Waveform....P.51
  - LIMITTER....P.87
  - Low Frequency Acceleration....P.86
  - Low Frequency Fast Rate....P.86
  - Low Frequency Level....P.86
  - Low Frequency Slow Rate....P.86
  - Low Frequency....P.84
  - Low Gain....P.84-95
  - LPF (Low Pass Filter)....P.54,P.64,P.86,P.89
  - LSB....P.79
- [M]**
- Manual....P.85-86
  - Master Tune....P.68
  - MIDI....P.59,P.66
  - MIDI Channel....P.59
  - MIDI Clock....P.66-67
  - MIDI Connector....P.7
  - MIDI Implementation Chart....P.157
  - MIDI Message Indicator....P.7
  - MIDI Receive Switch....P.59
  - Mix Level....P.85-86,P.97
  - MIX OUT Jack....P.6
  - Mode Button....P.28
  - Modulation....P.39,P.46,P.49,P.58,P.62,P.68

Modulation Depth....P.91  
Modulation Rate....P.91  
MODULATION-DELAY....P.91  
MSB....P.79  
Multi-Timbral....P.21-22  
Mute Group....P.63

[N] Note Number....P.30

[O] Octave Shift....P.32,42  
Output Assign....P.45,P.57-58,P.61,P.77  
OUTPUT Jack....P.7  
Output Level....P.45,P.57-58,P.61,P.77  
Output Pan....P.84,P.85,P.87,P.93-94  
OVERDRIVE....P.84  
Overdrive Pan....P.95-96  
OVERDRIVE->CHORUS....P.95  
OVERDRIVE->DELAY....P.96  
OVERDRIVE->FLANGER....P.95

[P] Page....P.36  
PALETTE Button....P.6,P.36  
Palette Edit Screen....P.36  
Pan....P.40,P.46,P.49,P.58,P.62  
Pan Control Switch....P.48,P.63  
Pan Diviation....P.88  
Pan Keyfollow....P.56  
Pan LFO Depth 1,2....P.52  
PARAMETER Button....P.6  
Part....P.22  
Part Edit....P.37  
Part Level....P.60  
Part Pan....P.60  
Part Select....P.34  
Part Switch....P.32  
Patch....P.15,P.20  
Patch Button....P.6,P.28  
Patch Control Source 2,3....P.49,P.80  
Patch Edit Mode....P.24,P.42  
Patch Group....P.30,P.60  
Patch Level....P.42  
Patch Mode....P.24  
Patch Name....P.30,P.42  
Patch Number....P.30,P.60,P.78  
Patch Pan....P.42  
Patch Play Mode....P.24,P.30  
Patch Receive Channel....P.67  
Patch Remain Switch....P.66  
PCM Card Slot....P.31  
PCM Card....P.23,P.29,P.39  
Peak....P.86  
Peak Control Source....P.67  
Peaking 1,2 Frequency....P.84  
Peaking 1,2 Gain....P.84

Peaking 1,2 Q....P.84  
Performance....P.21  
Performance Button (GM Button)....P.6,P.28  
Performance Edit Mode....P.24,P.57  
Performance Mode....P.24  
Performance Name....P.30,P.57  
Performance Play Mode....P.24,P.30  
Phase....P.88-91  
PHASER....P.85  
Phaser Depth....P.85  
Phaser Rate....P.85  
Pitch....P.52,P.60,P.64  
Pitch Bender....P.40,P.46,P.49,P.58,P.62  
Pitch Coarse Tune....P.60  
Pitch Envelope....P.53,P.64  
Pitch Envelope Depth....P.53,P.64  
Pitch Envelope Level 1,2,3,4....P.53,P.64  
Pitch Envelope Time 1,2,3,4....P.53,P.64  
Pitch Envelope Velocity Sensitivity....P.53,P.64  
Pitch Fine Tune....P.60  
Pitch Keyfollow....P.53  
Pitch LFO Depth 1,2....P.52  
Pitch Shifter Mode....P.94  
PKG (Peaking Filter)....P.54,P.64  
Polyphony....P.47,P.57,P.79  
Portamento Mode....P.47  
Portamento Start....P.48  
Portamento Switch....P.47  
Portamento Time....P.47  
Portamento Type....P.47  
Post Gain....P.87  
Power Up Mode....P.66  
Pre Delay Diviation....P.87  
Pre Delay Time....P.87-89,P.93-95  
Preset....P.23,P.29  
Preview....P.69  
Preview Key Set....P.69  
Preview Sound Mode....P.69  
Preview Velocity Set....P.69  
Program Change....P.68

[Q] QUADRUPLE-TAP-DELAY....P.92

[R] Random Pan Depth....P.56,P.65  
Random Pitch Depth....P.53,P.64  
Ratio....P.87  
Receive GM Message....P.67  
Receive Hold-1....P.60  
Receive Program Change....P.60  
Receive System Exclusive....P.67  
Receive Volume....P.60  
Redamper Control Source....P.48  
Redo Function....P.17,P.35  
Release Time....P.87  
Rename....P.73



- 
- Resonance....P.54,P.65
  - Resonance Velocity Sensitivity....P.55,P.65
  - Reverb....P.25,P.46,P.59,P.62,P.77,P.94
  - Reverb Level....P.47,P.59,P.63,P.78
  - Reverb Send Level....P.45,P.58,P.61-62,P.77
  - Reverb Type....P.46,P.59,P.62,P.78,P.94-95
  - Rhythm Edit Mode....P.24,P.61
  - Rhythm Edit Source....P.66
  - Rhythm Play Mode....P.24,P.30
  - Rhythm Set....P.21
  - Rhythm Set Mode....P.24
  - Rhythm Set Name....P.30,P.61
  - Right Level....P.92
  - Ring Modulator....P.44
  - ROM Play....P.12
  - ROTARY....P.86
- [S]
- Scale Tune C-B....P.69
  - Scale Tune Switch....P.68
  - Sensitivity....P.86,P.97
  - Separation....P.86
  - Shift Button....P.7
  - Solo Legato....P.47
  - Sound Group Button....P.7,P.29
  - Source Key....P.64
  - SPACE-D....P.88
  - SPECTRUM....P.85
  - Speed....P.86
  - Stack....P.66-67
  - Step Rate....P.90
  - STEP-FLANGER....P.89
  - STEREO-CHORUS....P.88
  - STEREO-DELAY....P.90
  - STEREO-EQ....P.84
  - STEREO-FLANGER....P.89
  - Stretch Tune Depth....P.42
  - Structure....P.43
  - Sustain Level....P.87
  - System Button....P.6,P.28
  - System Control Source 1,2....P.68
  - System Mode....P.24,P.28,P.66
- [T]
- Tap Control Source....P.67
  - Temporary Area....P.23
  - Threshold....P.87
  - TIME-CONTROL-DELAY....P.93
  - Tone....P.15,P.20
  - Tone Delay Mode....P.50
  - Tone Delay Time....P.51
  - Tone Level....P.55,P.65
  - Tone Pan....P.55,P.65
  - Tone Select....P.15,P.32
  - Tone Switch....P.15,P.33,P.34
  - Transmit Edit Data....P.67
  - Tremolo Phase....P.88
  - Tremolo Rate....P.88
  - Tremolo Separation....P.88
  - TREMOLO-CHORUS....P.88
  - TRIPLE-TAP-DELAY....P.91
  - Troubleshooting...P.103
  - TVA....P.20,P.55,P.64
  - TVA Envelope Level 1,2,3....P.56,P.65
  - TVA Envelope Time 1,2,3,4....P.56,P.65
  - TVA Envelope Velocity Curve....P.55
  - TVA Envelope Velocity Sensitivity....P.55,P.65
  - TVA Envelope....P.56,P.65
  - TVF....P.20,P.53,P.64
  - TVF Envelope Depth....P.54,P.65
  - TVF Envelope Level 1,2,3,4....P.55,P.65
  - TVF Envelope Time 1,2,3,4....P.55,P.65
  - TVF Envelope Velocity Curve....P.55
  - TVF Envelope Velocity Sensitivity...P.54,P.55
  - TVF Envelope....P.55,P.65
- [U]
- Undo Function....P.17,P.35
  - Unit Number....P.67
  - User Memory....P.23,P.29
  - Utility Mode....P.24,P.70
- [V]
- VALUE Knob....P.6,P.35
  - Velocity Cross Fade Depth....P.43
  - Velocity Range Lower....P.43
  - Velocity Range Switch....P.42
  - Velocity Range Upper....P.43
  - Velocity Range....P.42
  - Velocity Time 1 Sensitivity....P.53,P.55-56
  - Velocity Time 4 Sensitivity....P.53,P.55-56
  - Velocity Time Sensitivity....P.64-65
  - Voice Reserve....P.57
  - Volume....P.39,P.46,P.49,P.58,P.62,P.68
  - Volume Control Source....P.68
  - Volume Control Switch....P.48,P.63
  - VOLUME Knob....P.6,P.11
- [W]
- Wave....P.20,P.26,P.50,P.63
  - Wave Gain....P.50,P.64
  - Wave Group....P.50,P.63
  - Wave Name....P.30,P.50,P.63
  - Wave Number....P.50,P.63
  - WG....P.20,P.43
  - Write Protect....P.72
  - Write....P.18,P.70
- [Others]
- 1-8/9-16 Button....P.6
  - 2Voice-Pitch-Shifter....P.93

## Information

When you need repair service, call your local Roland Service Station or the authorized Roland distributor in your country as shown below.

### U. S. A.

**Roland Corporation US**  
7200 Dominion Circle  
Los Angeles, CA. 90040-3696, U. S. A.  
TEL: (213) 685 5141

### CANADA

**Roland Canada Music Ltd.**  
**(Head Office)**  
5480 Parkwood Way  
Richmond B. C., V6V 2M4  
CANADA  
TEL: (604) 270 6626

**Roland Canada Music Ltd.**

**(Montreal Office)**  
9425 Transcanadienne  
Service Rd. N., St Laurent,  
Quebec H4S 1V3, CANADA  
TEL: (514) 335 2009

**Roland Canada Music Ltd.**

**(Toronto Office)**  
346 Watline Avenue,  
Mississauga, Ontario L4Z 1X2, CANADA  
TEL: (416) 890 6488

### AUSTRALIA

**Roland Corporation Australia Pty. Ltd.**  
38 Campbell Avenue  
Dee Why West. NSW 2099  
AUSTRALIA  
TEL: (02) 982 8266

### NEW ZEALAND

**Roland Corporation (NZ) Ltd.**  
97 Mt. Eden Road, Mt. Eden,  
Auckland 3, NEW ZEALAND  
TEL: (09) 3098 715

### UNITED KINGDOM

**Roland (U.K.) Ltd.**  
Rye Close Ancells Business  
Park Fleet, Hampshire GU13 8UY, UNITED KINGDOM  
TEL: (0252) 816181

**Roland (U.K.) Ltd., Swansea Office**

Atlantic Close, Swansea  
Enterprise Park, Swansea,  
West Glamorgan SA79FJ,  
UNITED KINGDOM  
TEL: (0792) 700 139

### IRELAND

**The Dublin Service Centre Audio Maintenance Limited**  
11 Brunswick Place Dublin 2  
Republic of Ireland  
TEL: (01) 677322

### ITALY

**Roland Italy S. p. A.**  
Viale delle Industrie 8 20020  
ARESE MILANO ITALY  
TEL: (02) 93581311

### SPAIN

**Roland Electronics de España, S. A.**  
Calle Bolivia 239 08020  
Barcelona, SPAIN  
TEL: (93) 308 1000

### GERMANY

**Roland Elektronische Musikinstrumente Handelsgesellschaft mbH.**  
Oststrasse 96, 22844  
Norderstedt, GERMANY  
TEL: (040) 52 60090

### FRANCE

**Guillard Musiques Roland**  
ZAC de Rosarge Les Echets  
01700  
MIRIBEL FRANCE  
TEL: (72) 26 5060

**Guillard Musiques Roland (Paris Office)**

1923 rue Léon Geoffroy  
94400 VITRY-SUR-SEINE  
FRANCE  
TEL: (1) 4680 86 62

### BELGIUM/HOLLAND/LUXEMBOURG

**Roland Benelux N. V.**  
Houtstraat 1 B-2260 Oevel-  
Westerlo BELGIUM  
TEL: (014) 575811

### DENMARK

**Roland Scandinavia A/S**  
Langebrogade 6 Box 1937  
DK-1023 Copenhagen K.  
DENMARK  
TEL: 31 95 31 11

### SWEDEN

**Roland Scandinavia A/S**  
Danvik Center 28 A, 2 tr.  
S-131 30 Nacka SWEDEN  
TEL: (08) 702 0020

### NORWAY

**Roland Scandinavia Avd. Kontor Norge**  
Lilleakerveien 2 Postboks 95  
Lilleaker N-0216 Oslo 2  
NORWAY  
TEL: (02) 73 0074

### FINLAND

**Fazer Musik Inc.**  
Länstiulentie POB 169,  
SF-02101 Espoo FINLAND  
TEL: (00) 43 5011

### SWITZERLAND

**Roland (Switzerland) AG Musitronic AG**  
Gerberstrasse 5, CH-4410  
Liestal, SWITZERLAND  
TEL: (061) 921 1615

### AUSTRIA

**E. Dematte & Co.**  
Neu-Rum Siemens-Strasse 4  
A-6040 Innsbruck P.O.Box  
83  
AUSTRIA  
TEL: (0512) 26 44 260

### GREECE

**V. Dimitriadis & Co. Ltd.**  
20, Alexandras Avn., GR  
10682 Athens, GREECE  
TEL: (01) 8232415

### PORTUGAL

**Casa Caius Instrumentos Musicais Lda.**  
Rua de Santa Catarina 131  
4000 Porto, PORTUGAL  
TEL: (02) 38 4456

### HUNGARY

**Intermusica Ltd.**  
Warehouse Area 'DEPO'  
Torokbalint, Budapest  
HUNGARY  
TEL: (1) 1868905

### ISRAEL

**D.J.A. International Ltd.**  
Twin Towers, 33 Jabntinsy St.  
Room 211, Ramat Gan 52511  
ISRAEL  
TEL: (03) 751 8585

### CYPRUS

**Radex Sound Equipment Ltd.**  
17 Diagorou St., P.O.Box  
2046, Nicosia CYPRUS  
TEL: (2) 453 426  
(2) 466 423

### U.A.E

**Zak Electronics & Musical Instruments Co.**  
P.O. Box 8050  
DUBAI, U.A.E  
TEL: 360715

### KUWAIT

**Easa Husain Al-Yousifi**  
P.O. Box 126 Safat 13002  
KUWAIT  
TEL: 5719499

### LEBANON

**A. Chahine & Fils**  
P.O. Box 16-5857  
Beirut, LEBANON  
TEL: (01) 335799

### TURKEY

**Barkat Sanayi ve Ticaret**  
Siraselviler Cad. 86/6 Taksim  
Istanbul, TURKEY  
TEL: (0212) 2499324

### EGYPT

**Al Fanny Trading Office**  
9, Ebn Hagar Ai Askalany  
Street, Ard El Golf,  
Heliopolis, Cairo, 11341  
EGYPT  
TEL: (02) 917 803  
(04) 171 828

### QATAR

**Badie Studio & Stores**  
P.O.Box 62,  
DOHA Qatar  
TEL: 423554

### BAHRAIN

**Moon Stores**  
Bad Al Bahrain Road,  
P.O.Box 20077  
State of Bahrain  
TEL: 211 005

### BRAZIL

**Roland Brasil Ltda.**  
R. Coronel Octaviano da  
Silveira 203 05522-010  
Sao Paulo BRAZIL  
TEL: (11) 843 9377

### MEXICO

**Casa Veerkamp, s.a. de c.v.**  
Mesones No. 21 Col. Centro  
MEXICO D.F. 06080  
TEL: (905) 709 3716

**La Casa Wagner de**

**Guadalajara s.a. de c.v.**  
Av. Corona No. 202 S.J.  
C.P.44100 Guadalajara,  
Jalisco MEXICO  
TEL: (36) 13 1414

### VENEZUELA

**Musicland Digital C.A.**  
Av. Francisco De Miranda,  
Centro Parque de Cristal,  
Nivel C2 Local 20 Caracas  
VENEZUELA  
TEL: (2) 285 9218

### PANAMA

**Productos Superiores, S.A.**  
Apartado 655 - Panama 1  
REP. DE PANAMA  
TEL: 26 3322

### ARGENTINA

**Instrumentos Musicales S.A.**  
Florida 638  
(1005) Buenos Aires  
ARGENTINA  
TEL: (1) 394 4029

### HONG KONG

**Tom Lee Music Co., Ltd. Service Division**  
22-32 Pun Shan Street, Tsuen  
Wan, New Territories,  
HONG KONG  
TEL: 415 0911

### KOREA

**Cosmos Corporation Service Station**  
261 2nd Floor Nak-Won  
Arcade Jong-Ro ku, Seoul,  
KOREA  
TEL: (02) 742 8844

### SINGAPORE

**Swee Lee Company**  
BLOCK 231,  
Bain Street #03-23  
Bras Basah Complex,  
Singapore 0718  
TEL: 3367886

### PHILIPPINES

**G.A. Yupangco & Co. Inc.**  
339 Gil J. Puyat Avenue  
Makati, Metro Manila 1200,  
PHILIPPINES  
TEL: (02) 817 0013

### THAILAND

**Theera Music Co., Ltd.**  
330 Vengr Nakorn Kasem,  
Soi 2, Bangkok 10100,  
THAILAND  
TEL: (02) 2248821

### MALAYSIA

**Bentley Music SDN BHD**  
No.142, Jalan Bukit Bintang  
55100 Kuala Lumpur,  
MALAYSIA  
TEL: (03) 2443333

### INDONESIA

#### PT CITRARAMA

#### BELANTIKA

Kompleks Perkantoran Duta  
Merlin Blok E No.6—7  
Jl. Gajah Mada No.3—5,  
Jakarta 10130,  
INDONESIA  
TEL: (021) 3850073

### TAIWAN

#### Siruba Enterprise

#### (Taiwan) Co., LTD.

Room. 5, 9fl. No. 112 Chung  
Shan N.Road Sec.2 Taipei,  
TAIWAN, R.O.C.  
TEL: (02) 571 5860

### SOUTH AFRICA

#### That Other Music Shop (PTY) Ltd.

11 Melle Street (Cnr Melle  
and Juta Street)  
Braamfontein 2001  
Republic of South Africa  
TEL: (011) 403 4105

#### Paul Bothner (PTY) Ltd.

17 Werdmuller Centre  
Claremont 7700  
Republic of South Africa  
TEL: (021) 64 4030

For Nordic Countries

## Apparatus containing Lithium batteries

### ADVARSEL!

Lithiumbatteri - Eksplosionsfare ved fejlagtig håndtering.  
Udskiftning må kun ske med batteri af samme fabrikat og type.  
Levér det brugte batteri tilbage til leverandøren.

### VARNING!

Explosionsfara vid felaktigt batteribyte.  
Använd samma batterityp eller en ekvivalent typ som rekommenderas av apparatillverkaren.  
Kassera använt batteri enligt fabrikantens instruktion.

### ADVARSEL!

Lithiumbatteri - Eksplosjonsfare.  
Ved utskifting benyttes kun batteri som anbefalt av apparatfabrikanten.  
Brukt batteri returneres apparatleverandøren.

### VAROITUS!

Paristo voi räjähtää, jos se on virheellisesti asennettu.  
Vaihda paristo ainoastaan laitevalmistajan suosittelemaan tyyppiin. Hävitä käytetty paristo valmistajan ohjeiden mukaisesti.

For Germany

## Bescheinigung des Herstellers/Importeurs

Hiermit wird bescheinigt, daß der/die/das  
SYNTHESIZER MODULE JV-1080

(Gerät, Typ, Bezeichnung)

in Übereinstimmung mit den Bestimmungen der BMPT-AmtsblVfg 243/1991 funk-entstört ist. Der vorschriftsmäßige Betrieb mancher Geräte (z. B. Meßsender) kann allerdings gewissen Einschränkungen unterliegen. Beachten Sie deshalb die Hinweise in der Bedienungsanleitung.

Dem Zentralamt für Zulassungen im Fernmeldewesen wurde das Inverkehrbringen dieses Gerätes angezeigt und die Berechtigung zur Überprüfung der Serie auf die Einhaltung der Bestimmungen eingeräumt.

Roland Corporation  
4-16 Dojimahama 1-Chome Kita-ku Osaka 530 Japan

(Name und Anschrift des Herstellers/Importeurs)

For the USA

## FEDERAL COMMUNICATIONS COMMISSION RADIO FREQUENCY INTERFERENCE STATEMENT

This equipment has been tested and found to comply with the limits for a Class B digital device, pursuant to Part 15 of the FCC Rules. These limits are designed to provide reasonable protection against harmful interference in a residential installation. This equipment generates, uses, and can radiate radio frequency energy and, if not installed and used in accordance with the instructions, may cause harmful interference to radio communications. However, there is no guarantee that interference will not occur in a particular installation. If this equipment does cause harmful interference to radio or television reception, which can be determined by turning the equipment off and on, the user is encouraged to try to correct the interference by one or more of the following measures:

- Reorient or relocate the receiving antenna.
- Increase the separation between the equipment and receiver.
- Connect the equipment into an outlet on a circuit different from that to which the receiver is connected.
- Consult the dealer or an experienced radio/TV technician for help.

Unauthorized changes or modification to this system can void the users authority to operate this equipment.  
This equipment requires shielded interface cables in order to meet FCC class B Limit.

For Canada

### CLASS B

### NOTICE

This digital apparatus does not exceed the Class B limits for radio noise emissions set out in the Radio Interference Regulations of the Canadian Department of Communications.

### CLASS B

### AVIS

Cet appareil numérique ne dépasse pas les limites de la classe B au niveau des émissions de bruits radioélectriques fixés dans le Règlement des signaux parasites par le ministère canadien des Communications.

# SPECIFICATIONS

JV-1080 : Multi-timbral Synthesizer module  
(Conforms to General MIDI System)

## •Parts

Part 1to 16

## •Maximum Polyphony

64 Voices

## •Effects

EFX: 40 types (refer to the "Remarks" in the right side column)  
Chorus: 1 type  
Reverb: 1 type

## •Memory

|   |     |
|---|-----|
| Internal                                |     |
| System:                                 | 1   |
| Patch                                   |     |
| User:                                   | 128 |
| Preset A:                               | 128 |
| Preset B:                               | 128 |
| Preset C:                               | 128 |
| Preset D (General MIDI Sound Set):      | 128 |
| Performance                             |     |
| User:                                   | 32  |
| Preset A:                               | 32  |
| Preset B:                               | 32  |
| Rhythm Set                              |     |
| User:                                   | 2   |
| Preset A:                               | 2   |
| Preset B:                               | 2   |
| Preset C:                               | 2   |
| Preset D (General MIDI Percussion Map): | 2   |

## •Display

40 characters, 2 lines (backlit LCD)

## •Connectors

MIX OUT Jack (L, R)  
OUTPUT 1 Jack (L, R)  
OUTPUT 2 Jack (L, R)  
Headphone Jack (Stereo)  
MIDI Connectors (IN, OUT, THRU)  
Wave Expansion Board Slot (4 in total)  
Card Slot (PCM, DATA)

## •Power Supply

AC 120V, AC 220 V or AC 240 V

## •Power Consumption

16 W (AC120V), 17W (AC220V, AC240V)

## •Dimensions

482(W) x 281(D) x 88(H) mm  
18-15/16" (W) x 11-1/16" (D) x 3-1/2" (H) inches  
(EIA -2U rack mount type)

## •Weight

5.0 kg / 11 lbs 1 oz

## •Accessories

Owner's Manual  
AC Cord

## •Options

DATA Card (PN-JV80 series, M-256E / 512E)  
PCM Card (SO-PCM 1 series)  
Expansion Board (SR-JV-80 series)

<Remarks>

## •EFX types:

- 1: Stereo Equalizer
- 2: Overdrive
- 3: Distortion
- 4: Phaser
- 5: Spectrum
- 6: Enhancer
- 7: Auto-Wah
- 8: Rotary
- 9: Compressor
- 10: Limiter
- 11: HEXA Chorus
- 12: Tremolo Chorus
- 13: Space D
- 14: Stereo Chorus
- 15: Stereo Flanger
- 16: Step Flanger
- 17: Stereo Delay
- 18: Modulation Delay
- 19: Triple Tap Delay
- 20: Quadruple Tap Delay
- 21: Time Control Delay
- 22: 2 Voice Pitch Shifter
- 23: Feedback Pitch Shifter
- 24: Reverb
- 25: Gate Reverb
- 26: Overdrive -> Chorus
- 27: Overdrive -> Flanger
- 28: Overdrive -> Delay
- 29: Distortion -> Chorus
- 30: Distortion -> Flanger
- 31: Distortion -> Delay
- 32: Enhancer -> Chorus
- 33: Enhancer -> Flanger
- 34: Enhancer -> Delay
- 35: Chorus -> Delay
- 36: Flanger -> Delay
- 37: Chorus -> Flanger
- 38: Chorus / Delay
- 39: Flanger / Chorus
- 40: Chorus / Flanger

-> : serial connection / : parallel connection

\* In the interest of product development, the specifications for this product are subject to change without prior notice.



 Roland®

---

**71451145**

UPC

71451145



10981

**Roland**