

 **Roland**<sup>®</sup>

**JP-4**

Owner's Manual



# **JUPITER - 4**

## **COMPU-PHONIC**

- THE JUPITER-4 is a 4-voice polyphonic synthesizer equipped with four independent synthesizer modules. Ideal for live performances, this amazing creation is with a manual control, with an authentic COMPU-MEMORY that stores eight different timbres as well as the ten pre-set sounds. The two channel output with its stereo effect and the external control mechanism make possible the fascinating pursuit of keyboard dreams.

- In order to make this instrument display the best of its characteristic traits, it is desired that you have full knowledge on the functions of its sliders, tablets and knobs. For the purpose of helping you master how to play this instrument as early as possible, the setting examples are provided, but it is you who creates the sound just as in the case of the synthesizer. It is hoped, therefore, that you will draw out full performance of this instrument by finding new setting and playing methods.

# CONTENTS

• SYNTHESIZER BASICS	4	12. Protection Switch	10
• HOOK UP	6	13. Volume	14
• CONNECTION TERMINAL	6	14. VCO	14
• INSTRUCTIONS FOR HOOKUP	7	15. Noise	16
• NAMES OF THE COMPONENTS	8	16. VCF	16
• FUNCTIONS OF THE COMPONENTS	9	17. VCA	18
		18. LFO	18
		19. Trigger	19
		20. Delay / Bend	20
		21. Bend / Modulation	21
		22. Portamento	22
		23. Transpose	21
11. Power Supply Switch	9		
12. Keyboard	9		
13. Tuning	10		
14. Ensemble Switch	10		
15. Arpeggio Selector	10	• SAMPLE SOUNDS	21
16. Key Assignment Mode Switch	10	• SAMPLE NOTES	31
17. Hold Switch	10	• BLOCK DIAGRAM	38
18. Memory Write Switch	10	• SPECIFICATIONS	39
19. Manual Switch	10		
20. Compu-Memory Selection Switch	10		
21. Pre-Set Selection Switch	10		

## «Before Starting .....

- Power supply indicated on the name plate must be used. In case that the power supply in your district is different from it, it must be adjusted, using the voltage regulator.
- Because it is operated by AC power this instrument may sometimes generate a little heat.

## «Notes»

- Keep away from interferences that induce high levels of noise, such as fluorescent lamps, neon lights and transformers as much as possible.
- Avoid the use of this instrument in places that are dusty, of high temperature or high humidity.
- Clean the control panel with neutral detergent. Use a soft, dry cloth for the wooden parts. Do not use solvents such as paint thinner.

# • SYNTHESIZER

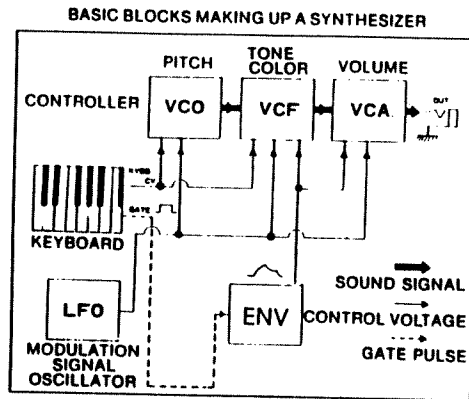

## • THE THREE QUALITIES OF SOUND

The three qualities of sound are: pitch, tone color, and loudness.

The pitch produced depends on the vibration rate. Fig. 1 shows that the higher the vibration rate, or the higher the frequency of the vibrations, the higher the pitch is. In synthesizers, pitch is controlled by the VCO. An oscillator is an electronic circuit which generates a waveform, or in this case, sound. "Voltage controlled" means that a

**FIG. 1 — SOUND PITCH = FREQUENCY**

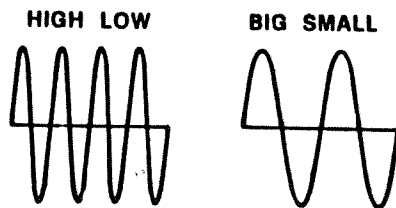

voltage is used to control the frequency (pitch, in this case) of the oscillator; the higher the voltage, the higher the frequency. This, then, is the first quality of sound: pitch. Fig. 1 shows what are known as sine waves, the simplest mode of vibration. The sound of a sine wave is very clean and pure. Most sound sources vibrate at many frequencies at the same time, however. The lowest of the vibrations, and usually the strongest, is the one which we hear as the musical pitch of the sound source. The presence of these other frequencies is what gives a sound source its second quality: tone color.

The frequencies produced by the complex vibrations of a sound source are called harmonics. Harmonics are usually multiples of the pitch frequency. For example, consider a sound source which vibrates so as to produce a pitch with a frequency of 200Hz. The first harmonic would be 200Hz ( $1 \times 200 = 200$ ). The first harmonic is also called the fundamental because this is the frequency which gives the sound its musical pitch. The second harmonic would be  $2 \times 200$ , or 400Hz. The third harmonic would be  $3 \times 200$ , or 600Hz; the fourth harmonic  $4 \times 200$ , or 800Hz, etc.

Fig. 2 shows a square wave. Square waves produce a tone color much like that of a

**FIG. 2 — TONE COLOR = HARMONIC CONTENT**  
**SQUARE WAVE** with three of its harmonics shown **SINE WAVE**

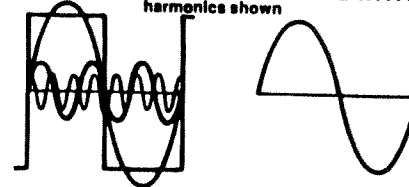

clarinet. Square waves contain only the odd numbered harmonics, or in other words, those frequencies which are one, three, five, seven, etc. times the frequency of the fundamental, or pitch frequency. The even numbered harmonics are missing. Tone color, then, is determined by the harmonic content of the sound; the more harmonics there are, the brighter the tone color. In the synthesizer, tone color is controlled by the VCF. The VCO produces a basic sound wave rich in harmonics. The VCF is used to remove (or filter out) some of these harmonics thus controlling the harmonic content of the finished sound. The amount of the harmonics removed is controllable by a control voltage.



The third quality of sound, loudness, is determined in a synthesizer by the level or amplitude of the waveform, as shown in Fig. 3, and is controlled by the VCA (Voltage Controlled Amplifier).

The loudness of a sound changes during its production. Strike a piano key and the sound jumps to maximum loudness. Hold the key down and the sound slowly dies away. This pattern of loudness in a sound is called its envelope. The output of the envelope generator is a control voltage. This control voltage is used to control the VCA, thus shaping the loudness pattern of the output sound of the synthesizer.

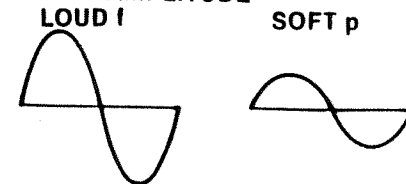
**FIG. 3 — VOLUME = AMPLITUDE**



• BASIC SYNTHESIZER THEORY

CONTROLLED CONTROLLER	VCO PITCH = FREQUENCY	VCF TONE COLOR = HARMONIC CONTENT	VCA LOUDNESS = AMPLITUDE
<p>KEYBOARD</p> 	<p>The most common use of the keyboard control voltage is for the control of the pitch of a VCO; the pitch produced will correspond to the key pressed.</p>	<p>The tone color of most instruments will vary with pitch; higher pitches often produce brighter tone colors, lower pitches darker tone colors. For this purpose, the VCF can be controlled by the keyboard.</p>	<p>The control of loudness by means of the keyboard is of little practical use; the JP-4 has no provision for this type of control.</p>
<p>ENVELOPE</p> 	<p>With some sounds, it is desirable to incorporate pitch changes during the production of each note.</p>	<p>The tone color of many instruments, particularly the wind instruments, changes during the production of each note. This effect can be produced with envelope generator control of the VCF. Raising the VCF resonance control will produce sounds possible only on the synthesizer.</p>	<p>The loudness pattern (or articulation) of a sound is produced by using the output of the envelope generator to control the VCA.</p>
<p>LFO</p> 	<p>The LFO (Low Frequency Oscillator) produces low frequency waveforms. Using the LFO sine wave output to control the pitch of the VCO will produce vibrato effects. The LFO square wave output will produce trills, and the sawtooth wave output will produce pitches which sweep downwards.</p>	<p>With some sounds, the tone color will vary at the same rate as vibrato. This can be done with LFO control of the VCF. Raising the VCF RESONANCE control will produce "growl" effects.</p>	<p>The LFO output can be used to vary the loudness of the sound output. The most common form is to use the sine wave output to produce tremolo effects.</p>

# • HOOKUP

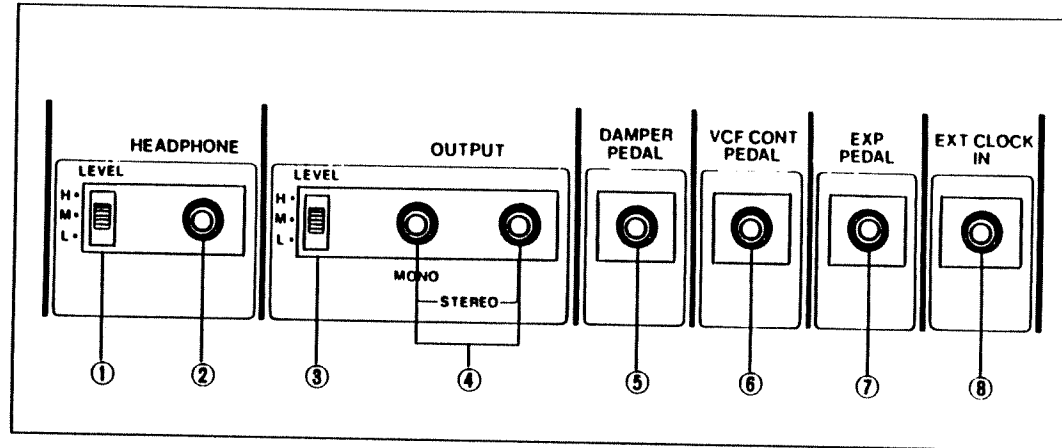

## • CONNECTION JACKS

### ① HEADPHONE LEVEL

This is the switch to adjust the output of the headphones.

### ② HEADPHONES

This is the jack to connect the headphones.

### ③ OUTPUT LEVEL

Select the level L, M or H according to the input sensitivity of the amplifier used.

AUDIO AMP	H
GUITAR AMP	L, M
P.A.MIXER	H, M, L

### ④ OUTPUT

This jack is for the output of JUPITER-4.

### ⑤ DAMPER PEDAL

Connect this pedal switch (DP-1, 2) to this jack. This turns on or off the HOLD-effect.

### ⑥ VCF CONT PEDAL

By connecting the foot pedal (FV-20) to this jack, you can control the cut-off frequency and by raising the resonance you can use it like a "wah wah" pedal.

### ⑦ EXP PEDAL

By connecting the foot volume (FV-20) to this jack, you can freely produce variations in volume.

### ⑧ EXT CLOCK IN

By connecting the external clock signal to this jack (CR-68, Sequencer, synthesizer's gate-output), you can control the arpeggios or the VCF modulation according to the cycle.

# • INSTRUCTIONS FOR HOOKUP

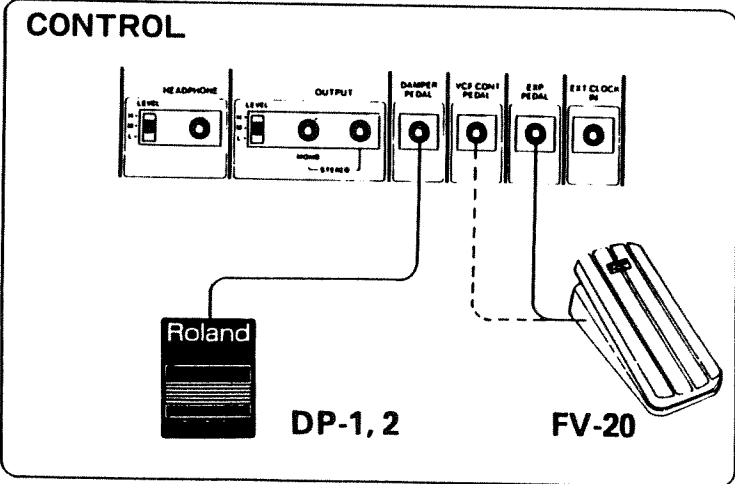
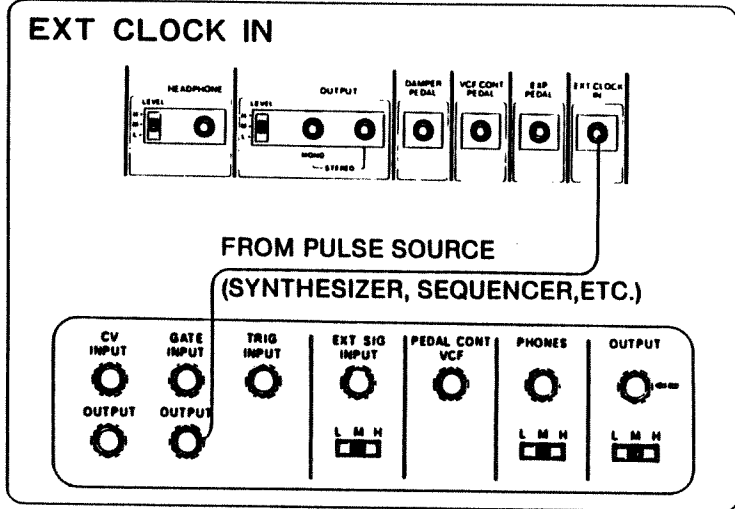
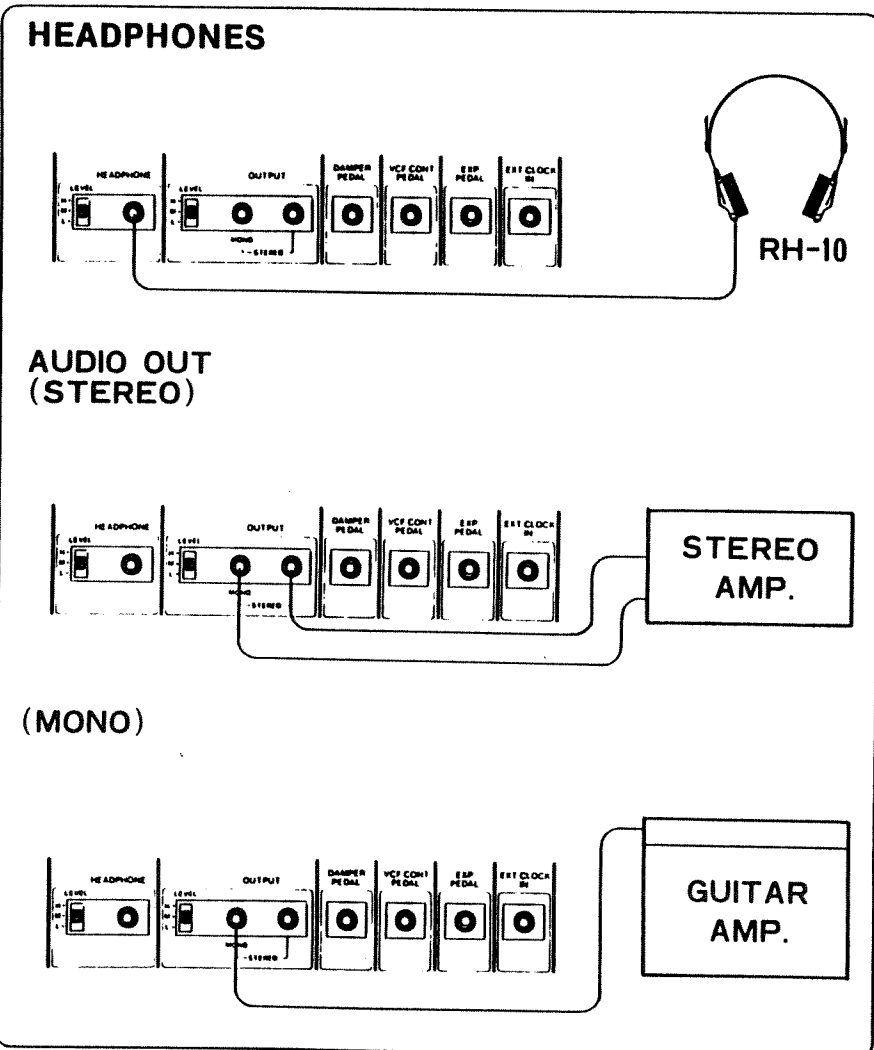



# • NAMES OF THE COMPONENTS

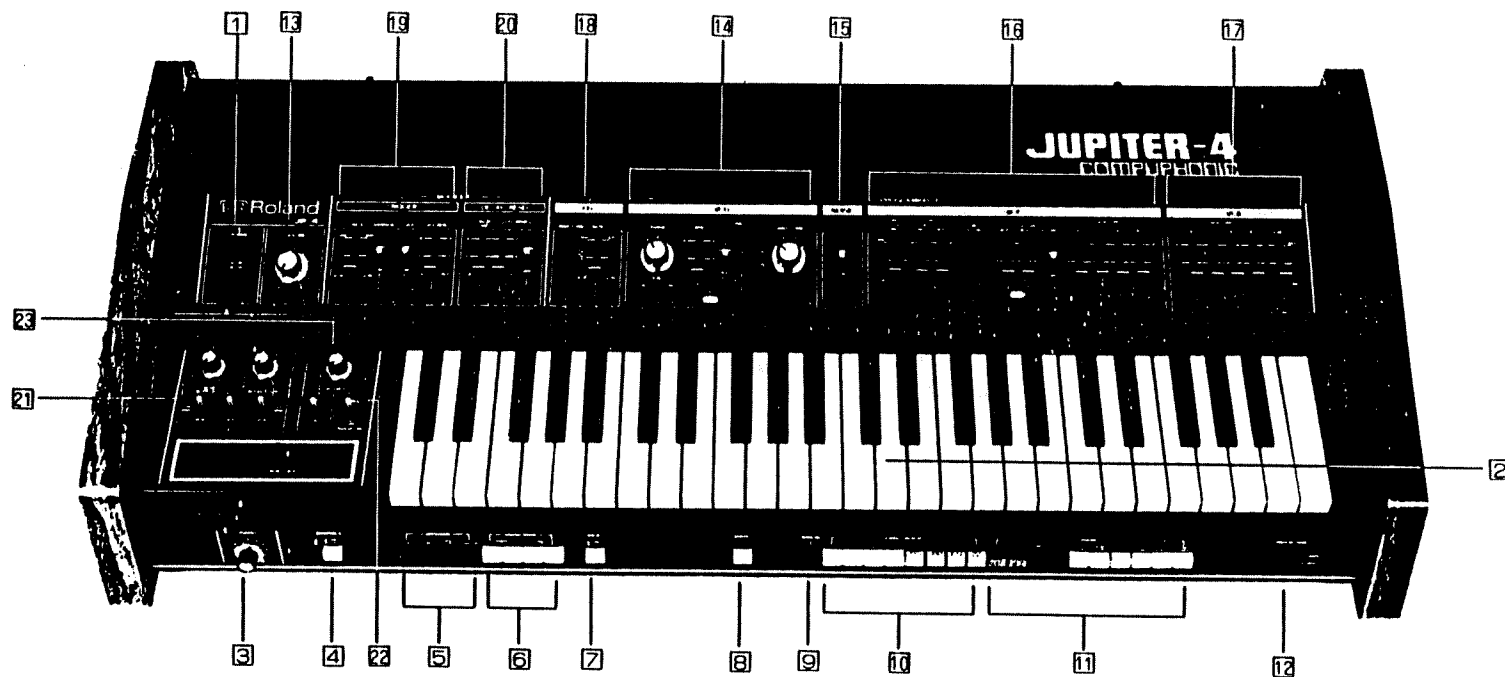

- 1 Power Supply Switch and Pilot Lamp
- 2 Keyboard
- 3 Tuning
- 4 Ensemble Switch
- 5 Arpeggio Selector
- 6 Key Assignment Mode Selector

- 7 Hold Switch
- 8 Memory Write Switch and Indicator
- 9 Manual Switch
- 10 Compu-Memory Selection Switch
- 11 Pre-Set Selection Switch
- 12 Protection Switch

- 13 Volume
- PROGRAMMABLE SECTION
- 14 VCO
- 15 Noise
- 16 VCF
- 17 VCA
- 18 LFO

## • MODIFIER SECTION

- 19 Trigger
- 20 Delay/Bend
- 21 Bend / Modulation
- 22 Portamento
- 23 Transpose

# • FUNCTIONS OF THE COMPONENTS

## 1 POWER SUPPLY SWITCH

By switching on the synthesizer, the pilot lamp will light up and JUPITER-4 is ready for operation.

## 2 KEYBOARD

The keyboard component of JUPITER-4 is in itself a 49-note 4-octave system. But by means of a VCO range switch and the TRANSPOSE switch, it is possible to extend the range to 7 octaves, as shown in the diagram below.

8 feet is the basic range and when the TRANSPOSE switch is off, the second from the left C "do" (C) of the keyboards becomes the middle C of the piano.

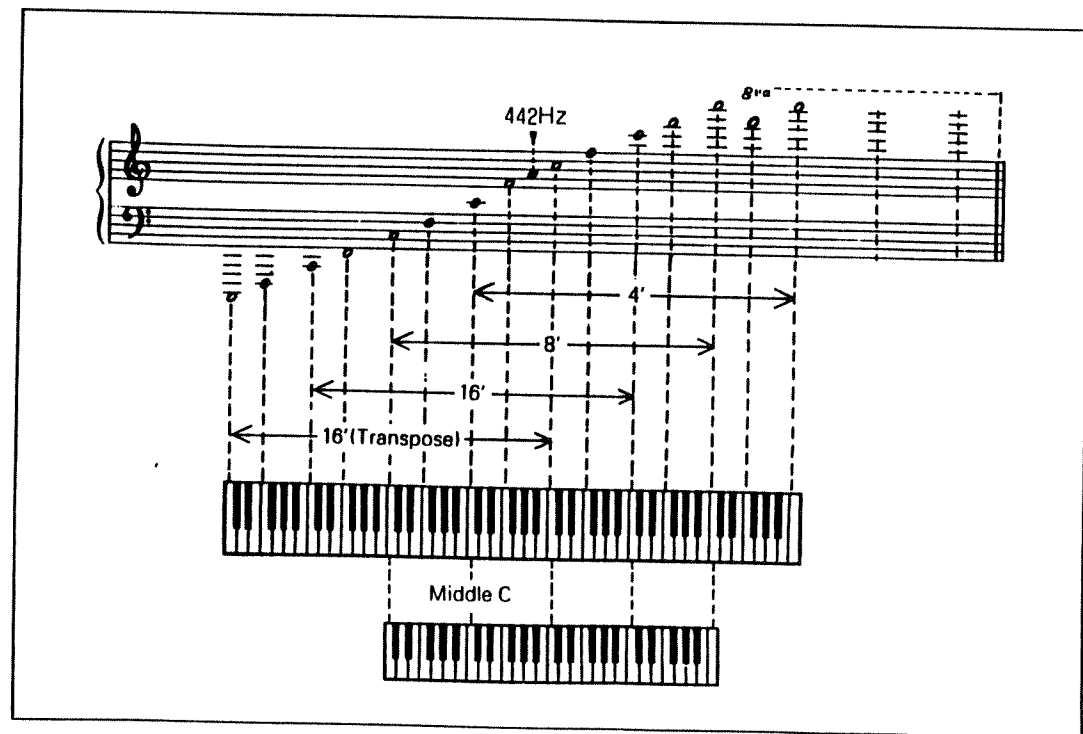

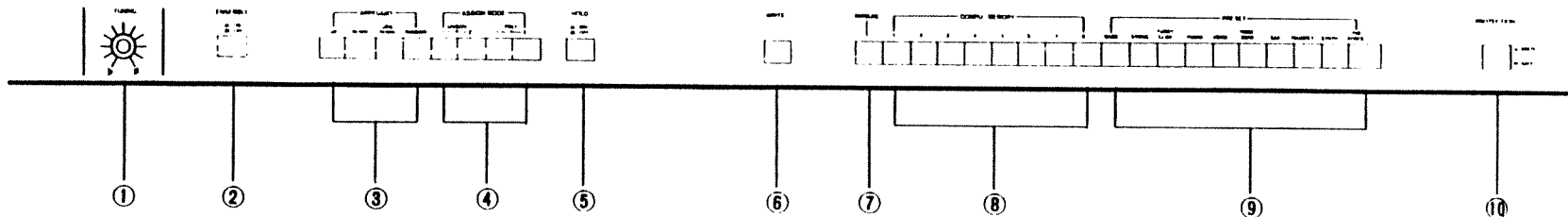

**3 TUNING ①**

This knob is for tuning the pitch. The tuning range is approximately 50 cent. The knob is positioned at the center and "A" is tuned at 442 Hz. When the interval differs from another instrument, use this knob for tuning.

**4 ENSEMBLE SWITCH ②**

This knob turns on or off the ensemble effect.

**5 ARPEGGIO MODE SELECTOR ③**

With JUPITER-4, basing the range on the first note played, it is possible to play the auto-arpeggio with a maximum range of four octaves.

The pattern of the arpeggios will depend on the order of the notes played but the movement of the pattern itself is selected from the three choices of UP, DOWN and UP + DOWN. RANDOM is affected by the initial note but the order of the notes played or the choices of UP, DOWN have no effect.

The speed of the arpeggios is controlled by RATE (⑩) of TRIGGER.

**6 KEY ASSIGNMENT MODE SWITCH ④**

From the signals produced by pressing the key there are four patterns which indicate how to work the modules. This switch selects the pattern.

**7 HOLD SWITCH ⑤**

This switch turns on or off the condition where a note is preserved by a volume established by the VCA's sustain level.

**8 MEMORY WRITE SWITCH ⑥**

This switch is for memorizing the tone set with PROGRAMMABLE.

**9 MANUAL SWITCH ⑦**

Switch on the manual switch when you want to manipulate PROGRAMMABLE (☐). If you press the pre-set switch it will automatically go off (☐).

**10 COMPUTER MEMORY SELECTION SWITCH ⑧**

This switch reproduces the sound memorized by PROGRAMMABLE.

**11 PRE-SET SELECTION SWITCH ⑨**

This switch reproduces the pre-set tone.

**12 PROTECTION SWITCH ⑩**

This switch prevents accidental destruction of programmed sounds. Use the MEMORY WRITE SWITCH ⑥ when setting COMPUTER MEMORY.

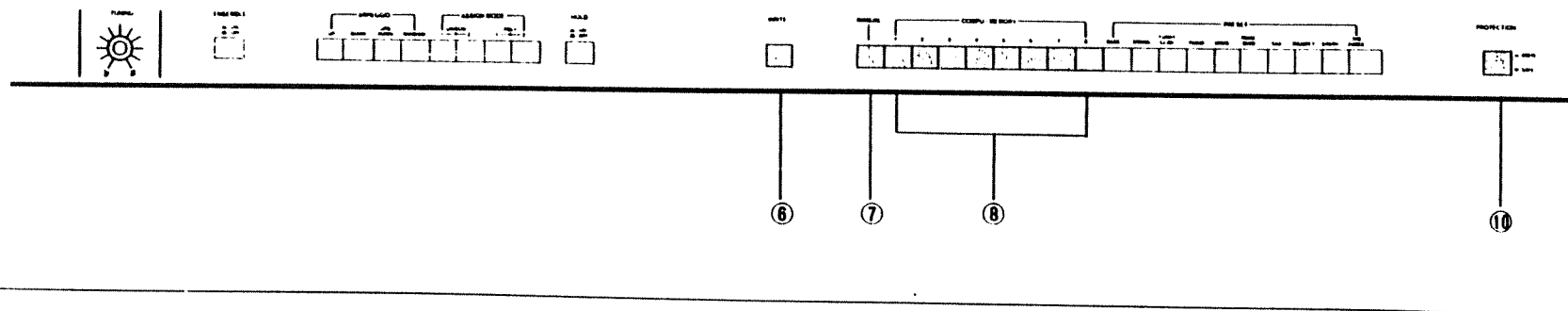

### OPERATION OF COMPU-MEMORY

One of the necessary conveniences in live performances is the ability to swiftly interchange patches according to the progression of the music piece.

By programming COMPU-MEMORY to memorize the sounds you want, you can change the timbre with one switch.

Eight different sounds may be memorized and along with the 10 pre-sets, a total of 18 sounds are available for you.

#### • SETTING THE COMPU-MEMORY

1. Push MANUAL ⑦
2. At the PROGRAMMABLE section, create the sound you want
3. Push the button of COMPU-MEMORY ⑧ between 1 through 8 where you want your sound memorized.
4. While pushing PROTECTION ⑩ push WRITE ⑥ along with it. If the INDICATOR lights up, MEMORY is completed.

#### • THE REPRODUCTION OF THE PROGRAMMED SOUND

Press the button between 1 through 8 of COMPU-MEMORY ⑧ where you had programmed the data. This will reproduce the sound.

### CAUTION

New data will erase the data previously programmed.

There should not be any trouble in programming data but until you become accustomed to the process, switch between COMPU-MEMORY and MANUAL to check the sound before rearranging the set-up on PROGRAMMABLE.

\* JUPITER-4 has a battery back-up which prevents loss of memory when the power switch is turned off. The battery is chargeable and as long as the synthesizer is used regularly, there will be no change in the memory. However when it is not used for a long period of time the data will become extinct. Recharge the battery once every 6 months by turning the power switch on for the prevention of a loss of memory.

When using the synthesizer after the back-up battery is exhausted and memory is erased, there might be some noise produced depending on the set up of COMPU MEMORY. This is not an indication of damage. Please re-set the COMPU-MEMORY section.

• **ARPEGGIO**

- The pattern of the arpeggios is determined by the order of the keys pressed.
- The C, one octave above the highest C, is the limit. Therefore, depending on where you start, the arpeggios might consist of under four octaves.

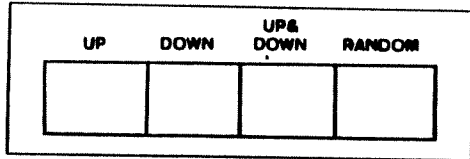

• **UP**

Following the order of the keys selected for the pattern the arpeggio is performed on every scale within the 4-octave range.

(unison)

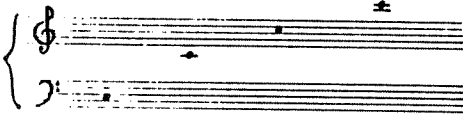
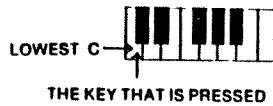

(chord)

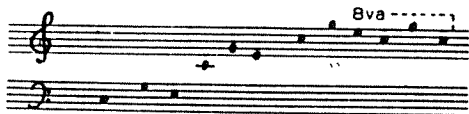
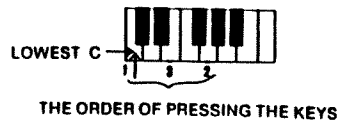

• **DOWN**

In principle, DOWN functions in the complete opposite way of UP. If you play the keys C-E-G, the order of the performance with DOWN is G-E-C.

(unison)

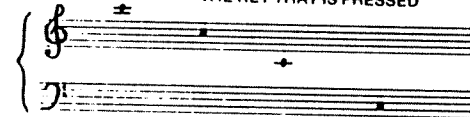

(chord)

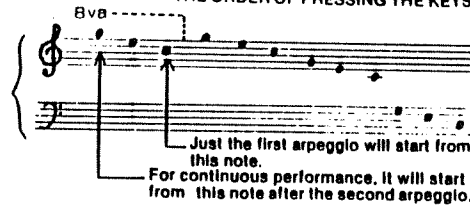

• **UP + DOWN**

After the UP-movement ceases, the DOWN-movement takes over. Please keep in mind that in principle, the last note of UP is the first note of DOWN.

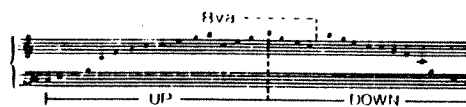

When starting the arpeggios from the middle C or a higher C, as an exception the range of the arpeggios becomes 3 octaves or less. But since the highest C is added, in times of holding chords the arpeggios become more natural-sounding.

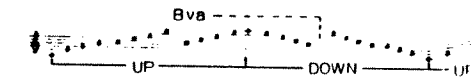
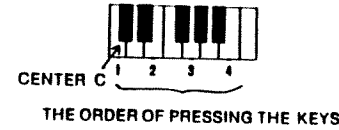

IN EFFECT, IT IS ONE OCTAVE HIGHER.

• **RANDOM**

The sound of the selected key along with the corresponding higher four octaves are produced in irregular patterns.

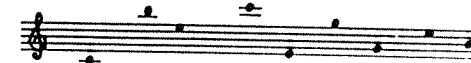
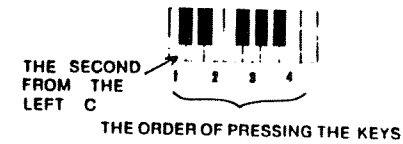

## • KEY ASSIGNMENT MODE

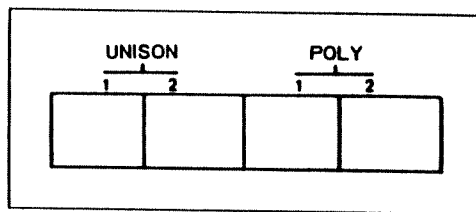

### UNISON-1

The four VCO's become monophonic. In this case, if you press more than two keys, only the lowest note functions.

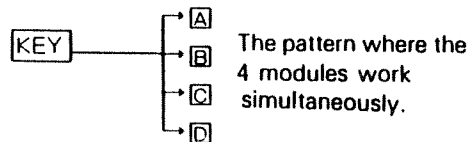

#### EXAMPLE



#### KEY KEY FUNCTIONING MODULE

C	.....	A	B	C	D	
G	.....	A	B	C	D	
E	.....	A	B	C	D	
G	.....	A	B	C	D	

4VCO •  
1NOTE

### UNISON-2

If you press one key, the sound of the four VCO's two keys, the sound of the VCO's paired off in two and three or four keys, the sound of the VCO's functioning individually will be produced.

### SINGLE SOUND

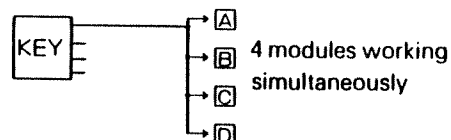

### TWO SOUNDS

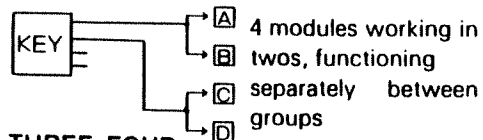

### THREE, FOUR SOUNDS

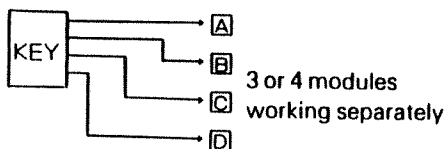

#### EXAMPLE



MODULE A	→ C1 C1 C1 C1 C1 E C1	
• B	→ C1 C1 E E E E C1	4VCO • 1NOTE
• C	→ C1 E G G G E C2	4VCO • 2NOTES
• D	→ C1 E X C2 X E C2	3VCO • 3NOTES
		4VCO • 4NOTES

### • POLY-1

POLY 1 functions with one key to one VCO. At RELEASE or HOLD, when you play from a chord to a single note several times, the sound or the chord will fade out due to the single note that was played after the chord.

POLY 1 is suitable for the arpeggios.

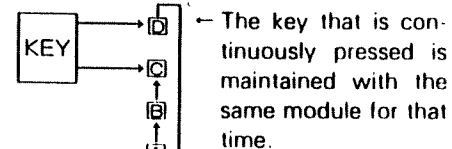
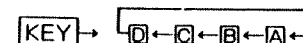

#### EXAMPLE

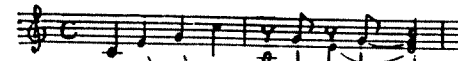

MODULE A	→ C1 X X X C1 C1 C1 C1 C1
• B	→ X E X X X G X X C1
• C	→ X X G X X X E E E
• D	→ X X X C2 X X X G G

### POLY-2

POLY 2 functions with one key to one VCO. At RELEASE or HOLD, even when you play from a chord to a single note, the sound of the single note will be held with the exception of one note.

POLY 2 is suitable for PORTAMENTO.

\*When playing with single notes and you want to work it with one key to one VCO, set to this position.

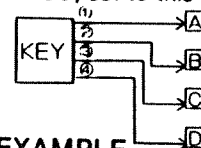

In playing chords, the order of the keys always determines the order of the modules.

#### EXAMPLE



MODULE A	→ C1 E G C2 C1 C1 C1 C1 C1
• B	→ X X X X X G E E E
• C	→ X X X X X X X G G
• D	→ X X X X X X X X C2

With POLY 1 and POLY 2, the effect of PORTAMENTO will vary depending on whichever way you choose to play. During the state of HOLD, the difference will be enhanced.

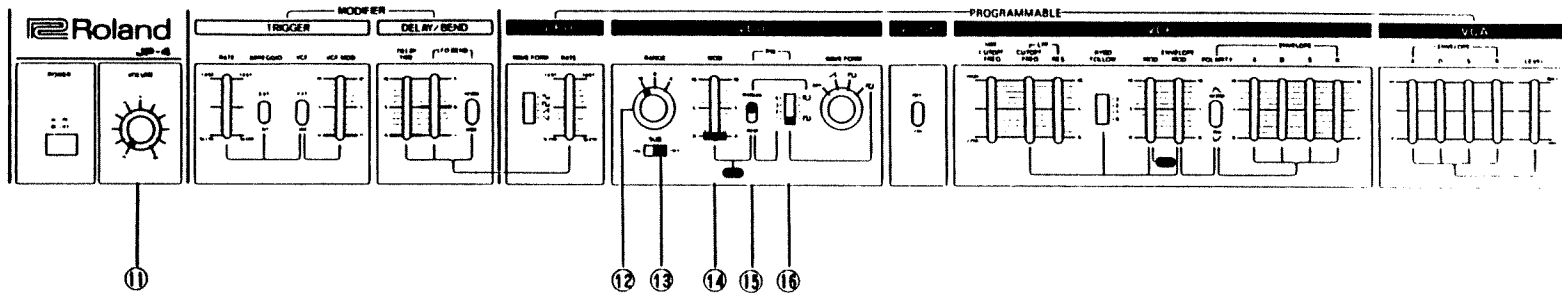

### 13 VOLUME ⑪

This knob determines the total volume.

## PROGRAMMABLE SECTION

### 14 VCO (VOLTAGE CONTROLLED OSCILLATOR)

A voltage controlled oscillator changes the frequency (pitch).

The fundamental waveform of the synthesizer is created here. And its frequency is controlled by voltage and this determines the pitch.

#### • RANGE CHANGE ⑫

This selector changes the sound range of the VCO. 8 feet is the fundamental sound range. In switching to 4 feet or 16 feet, you can transfer the range from 1 octave up or 1 octave down.

With 8 feet, the middle C corresponds to the middle C in a piano. However leave **TRANPOSE** to **NORMAL**.

#### • SUB (SUB OSCILLATOR) ⑬

Switch it on and the VCO will produce a square wave one octave down. Combining use can produce a rich sound.

#### • MOD ⑭

Slide it up and the output signal of the LFO will modulate the VCO. This slider controls the degree of modulation. The further you slide it upward, the more intensified the degree becomes. Usually the sine wave output waveform of the LFO is used to continuously change the interval to produce a vibrato effect.

#### • PW (PULSE WIDTH)

When the PW switch ⑮ is on **MANUAL** the slider (⑯) will change the width to four forms. The LFO will modulate the width when switched to **MOD** and the depth of the pulse width modulation can be chosen among the four forms with the slider (⑰).

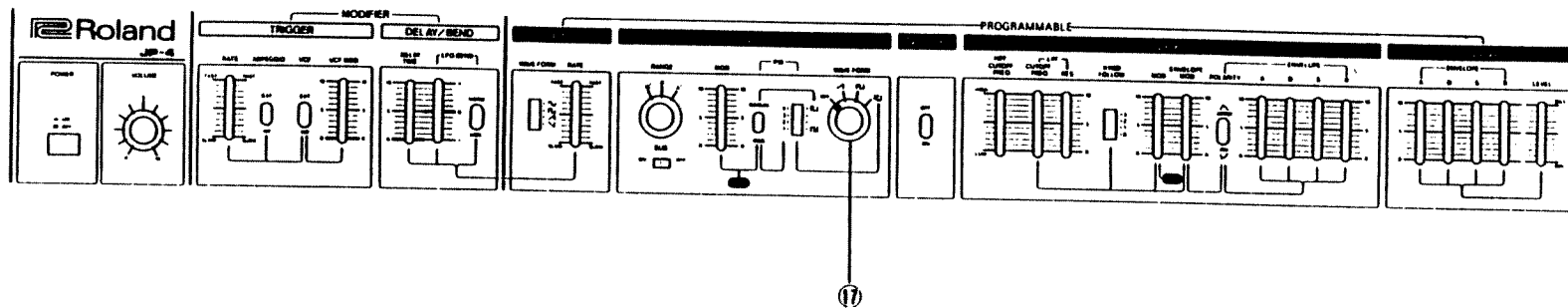

• **WAVEFORM 17**

This switch changes the output waveform of the VCO.

**1) OFF**

Turn off WAVE FORM when you're not using the output from the VCO.

**2) SAWTOOTH WAVE**

It contains all the overtones. You can manufacture tones of numerous musical instruments. If you form an envelope with the VCF, you can create the brass sound. If you form an envelope with the VCA, you can reproduce the strings. You can also use this form as the fundamental wave form to produce sounds which are distinctively characteristic of the synthesizer.

**3) SQUARE WAVE**

The square wave contains many odd number overtones and it produces a timbre similar to the clarinet. By forming an envelope with the VCF or the VCA, you can reproduce sounds of a clarinet, xylophone or the characteristic timber of a synthesizer.

**4) PULSE WAVE**

The width of the wave is not symmetrical. Due to the pulse width, there are changes in overtone construction and in tone as well. The pulse width can be used as it is pre-set or can be modulated with the LFO signal. This is called pulse width modulation (PWM).



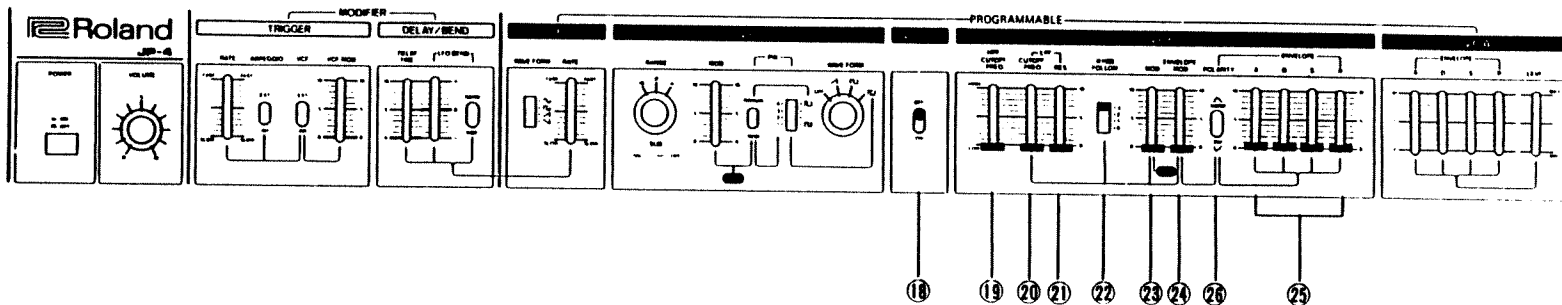

### 15 NOISE 15

The noise generator is the fundamental sound source for effects and reproduces sounds of the wind or the waves.

### 16 VCF (VOLTAGE CONTROLLED FILTER)

This filter controls the tone of a sound.

#### • HPF (HIGH PASS FILTER) 19

The High Pass Filter eliminates the low sounds and allows only the high sounds to pass. This becomes possible by raising the cutoff frequency. The husky timbre of the clarinet, the sparkle of the oboe, the brilliance of the harpsichord and the human voice are all created by the establishment of the high pass cut-off frequency. And by adjusting the cut-off frequency to a minimum, the high pass filter does not function.

#### • LPF (LOW PASS FILTER) 20

This slider determines the frequency you want to cut off. At the most upward position, the basic wave form from the basic note is left the same but as it slides down, the high overtone components are eliminated and the tone becomes mellow, mellower. And when the LPF is further used, the sound becomes similar to that of a square wave.

#### • RES (RESONANCE) 21

With CUTOFF FREQ, the cutoff frequency point is emphasized. As the slider is moved upward, certain overtones are emphasized. Distinctive sounds are created this way. Since the manipulation of RESONANCE brings changes in volume, use VOLUME to make adjustments.

#### • KYBD FOLLOW 22

This switch controls the VCF with the KYBD-CV (keyboard voltage). Among certain instruments, the pitch can determine changes in the tone. Therefore there is a need to control the VCF with voltage.

#### MOD. 23

By controlling the VCF with the LFO signal, you can produce an effect (growl effect) similar to what is produced by periodically moving the wah -pedal.

The intensity of the effect is adjusted by this slider.

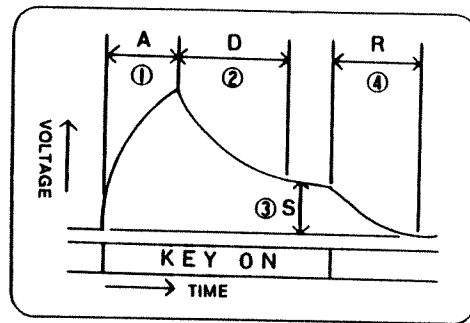

The ENVELOPE GENERATOR produces voltage that change through time lapse, as pictured in the above diagram.

#### ① A (ATTACK TIME)

Adjust the attack control to 0. The sound starts instantly. Adjust the attack control to 10. In this case it takes time for the sound to reach full volume. This slider determines the time it takes for the sound to reach the peak of voltage from when the key is first pressed.

#### ② D (DECAY TIME)

DECAY determines the time it takes for a sound to fade away. As in the diagram, it is the time when voltage hits the peak and decreases to S (SUSTAIN LEVEL). Therefore D and S are closely related. When S is raised, there are no changes in the form of the envelope even with changing D. Also when S is lowered, if you shorten D a waveform only appears for an instant.

#### ③ S (SUSTAIN LEVEL)

This slider determines the maintenance level after the envelope has reached its peak. The note is held at the level you assign. It should be noted that the other ADR are of time value whereas S is of a level value.

#### ④ R (RELEASE TIME)

This slider determines when the sound will end or fade out after you release a key.

#### ENV. MOD. ㉔

This slider adjusts the amount of change of CUTOFF FREQ by the envelope signal coming from ADSR.

By sliding it upward variations in the characteristics of the VCF are produced by the pattern previously set, when a note is played.

#### • ADSR (ENVELOPE GENERATOR) ㉕

The envelope generator controls the VCF or the VCA and produces changes that occur in tone or volume through time lapse.

#### • POLARITY ㉖

This switch changes the polarity of the envelope. The envelope of inverted polarity (∩) is used for special effects. Usually it is used at (∪).

#### ADSR SETTING VS ENVELOPE WAVEFORM

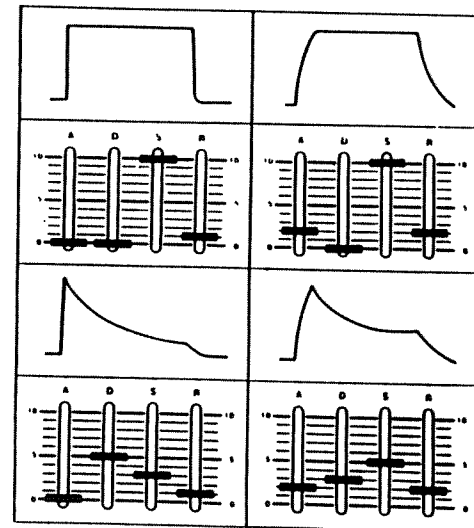

It must be noted that if all the ADSR sliders are at 0, the waveform becomes an extremely short pulse, producing clip noise.

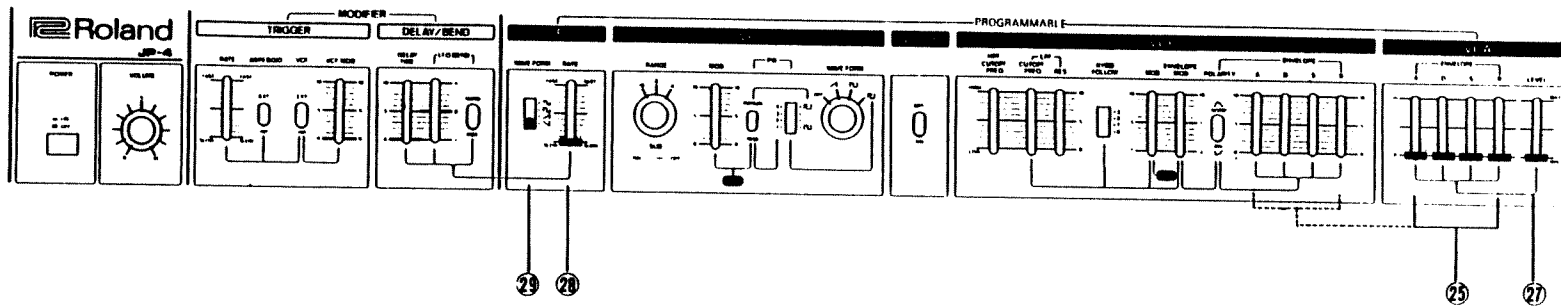

### 27 VCA (VOLTAGE CONTROLLED AMPLIFIER)

Through the distribution of the controlled voltage, the VCA controls volume. With the signals for the envelope generator, volume is controlled as to show changes in sound caused from a lapse of time.

- **LEVEL 27**

This slider controls the volume of the PROGRAMMABLE section. Sound is distorted when the level is too high. In this case the OVERLOAD LAMP will light up.

### 28 LFO (LOW FREQUENCY OSCILLATOR)

This output signal controls the VCO, the VCF and the VCA.

It produces the vibrato effect (changes the interval periodically), the growl effect (changes the tone periodically), and the tremolo effect (changes the volume periodically).

- **RATE 26**

This slider produces variations in the LFO speed (frequency). Slide it upward and the speed increases. Slide it downward and the speed decreases.

- **WAVE FORM 28**

This switch changes the output waveform of the LFO.

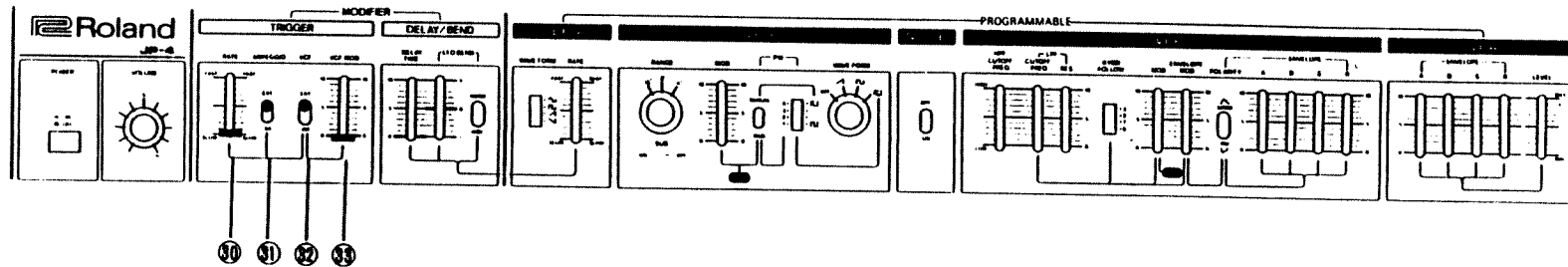

## • MODIFIER SECTION

### 19 TRIGGER

- **RATE 30**

This slider controls the arpeggios and the speed of VCF modulation.

- **ARPEGGIO 31**

INT: Switch on to INT when you want to control the arpeggio speed with the internal trigger generator. Adjust the speed with RATE 30.

EXT: Switch on to EXT when you want to control the arpeggios with the external signal.

- **VCF 32**

The VCF is equipped with SAMPLE AND HOLD with NOISE as the sample source. This creates variations in the cutoff frequency.

INT: Switch on to INT when you want to use the internal trigger generator for sampling. Adjust the speed with RATE 30 and for depth, use the VCF MOD. 33.

EXT: Switch on to EXT when you want to use the external signal for sampling.

- **VCF MOD. 33**

This slider adjusts the modulation sensitivity.

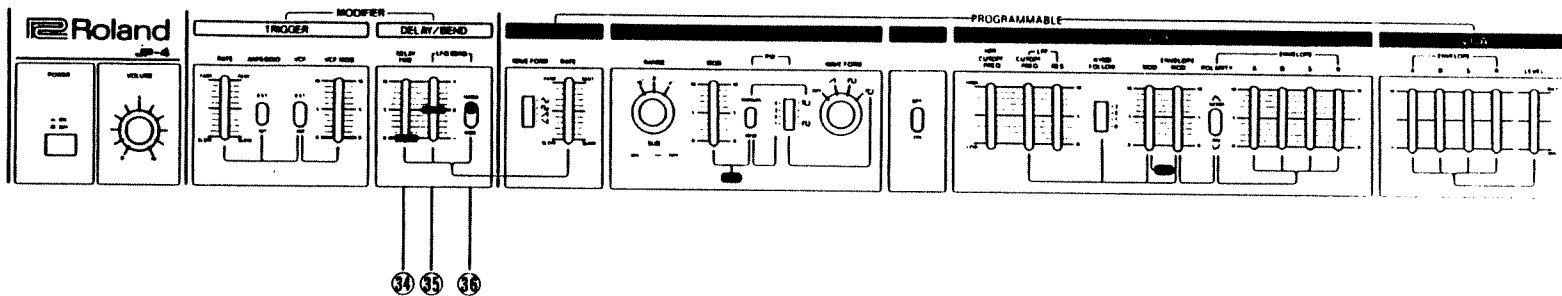

## 20 DELAY/BEND

### • DELAY TIME 34

With this switch it is possible to delay the time from playing a key to the start of modulation due to the LFO.

The more you slide it upward the longer the delay time.

It should be noted that DELAY does not re-occur unless the key is played over again. Therefore in legato performance, DELAY only occurs in the first note.

### • LFO 35

JUPITER-4 has the capacity to memorize RATE and WAVE FORM of the LFO with COMPU-MEMORY. This is the slider that adjusts the programmed speed of the LFO.

At the middle position 0, the rate is the same as the LFO rate memorized by COMPU-MEMORY.

(With MANUAL it is the PROGRAMMABLE LFO RATE)

Sliding it upward (towards +) increases the speed whereas sliding it downward (towards -) decreases the speed.

### • NORMAL/WIDE 36

This switch determines the range of control of the LFO (35) slider. Choose between NORMAL and WIDE.

### CAUTION

Even while making patches in the PROGRAMMABLE SECTION with the MANUAL SWITCH 7 on, the sliders and switches of the MODIFIER SECTION are used. (Take special notice of the use of the LFO BEND (35) slider).

When not using the MODIFIER SECTION, please make it a habit to set it back to the normal position as seen in the diagram above.

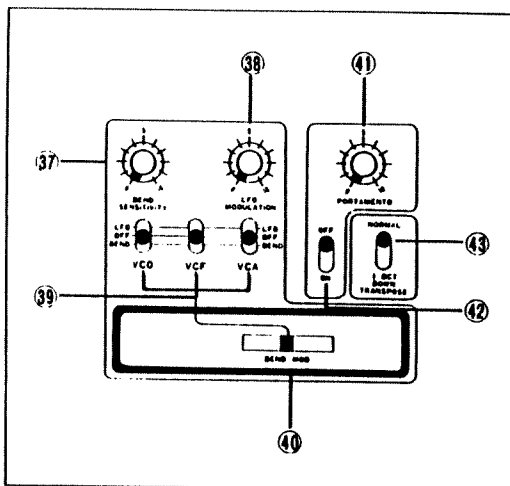

## 21 BEND / MODULATION

### • BEND SENS 37

The knob establishes the possible variations in range of the bender lever.

The knob functions establishing the variation ranges of the interval for the VCO, of the tone for the VCF and of the volume for the VCA.

### • LFO MOD 38

This knob controls the LFO modulation depth regulated by the bender.

### • BEND / LFO SELECTION SWITCH 39

This switch determines the function of the lever, regarding the VCO, the VCF and the VCA.

You can choose the LFO, OFF and BEND with this switch. In case of the LFO, you can regulate the depth with the lever. The BEND regulates each block's control output. Each motion range is controlled by the LFO MOD 39 and the BEND SENS 37

### • BEND / MOD LEVER 40

This is to produce variations in the interval, tone and volume by the manipulation of the lever. By manipulating the MOD switch and controlling the LFO output, you can control the depth of the vibrato, the growl or the tremolo. And by BEND manipulation of the interval, it is possible to produce the choking-effect of an electric guitar.

## 22 PORTAMENTO

"Portamento" is to smooth the change in the scale. It is a distinctive phenomenon with synthesizers, not possible with the other keyboard instruments.

### • PORTAMENTO 41

This knob controls the smoothness in the change of the scale. The more you turn it to the right, the longer the time for the change.

### • PORTAMENTO SWITCH 42

This switch turns the PORTAMENTO ON or OFF.

### 23 TRANSPOSE 43

Centering on NORMAL, 1 OCT DOWN lowers the interval by one octave.

# • SAMPLE SOUND I

## PRE-SET SOUNDS

IN ITS SYSTEM. Just as you can display your talent in live performances with them, you can use them to base or compare with the original sounds you create with PRO-

GRAMMABLE. When basing your original sound creation with the pre-set sounds, please refer to the patches below.

The tone quality of BRASS (yellow button) is made flat. When you want to make changes, adjust the LFO BEND to WIDE of the MODIFIER.

### • BASS

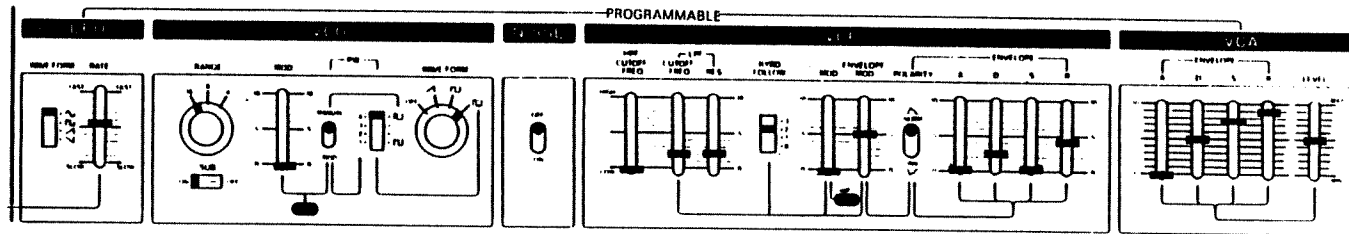

### • STRING

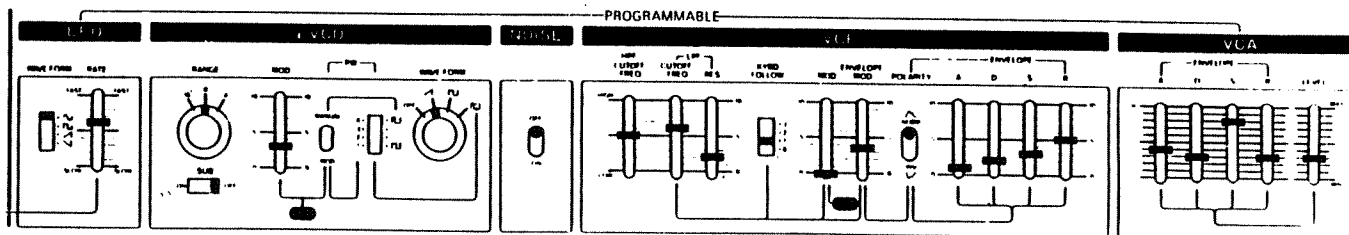

• FUNKY CLAVICHORD

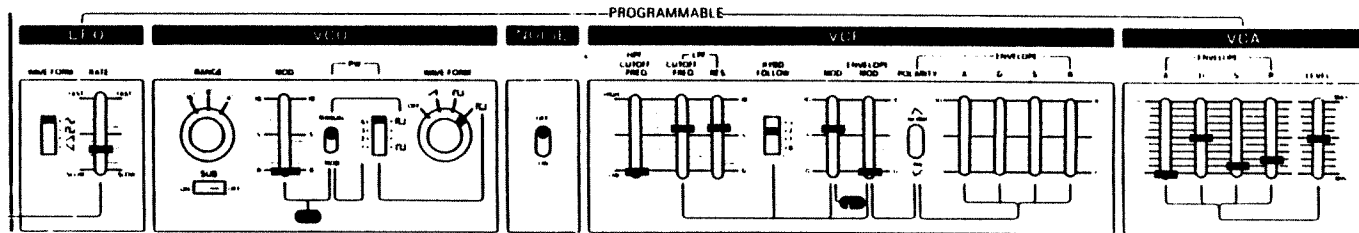

• PIANO

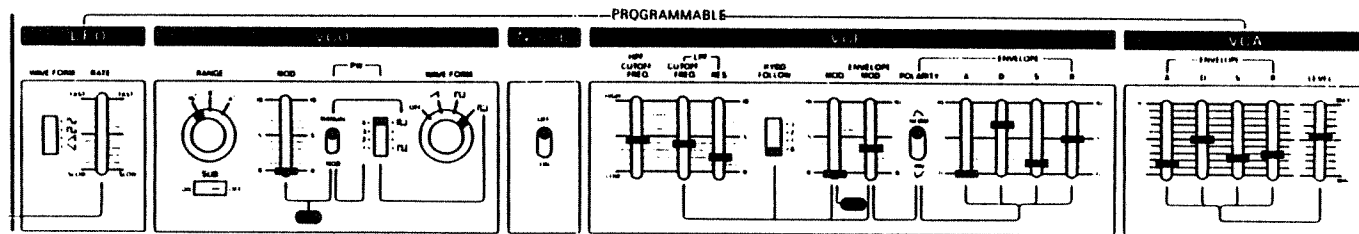

• VOICE

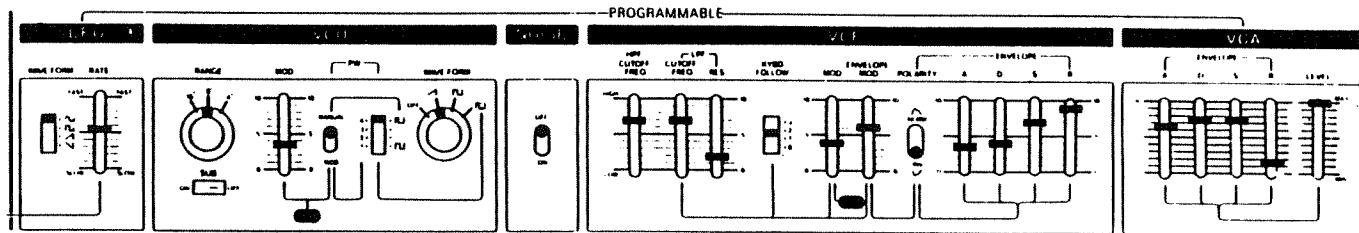



• TROMBONE

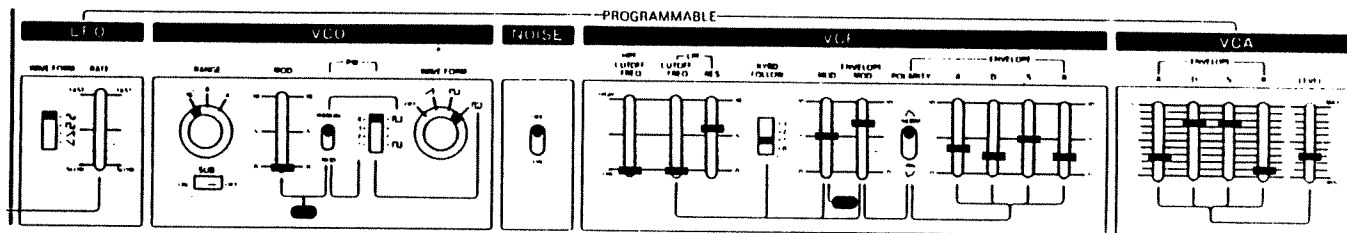

• SAX

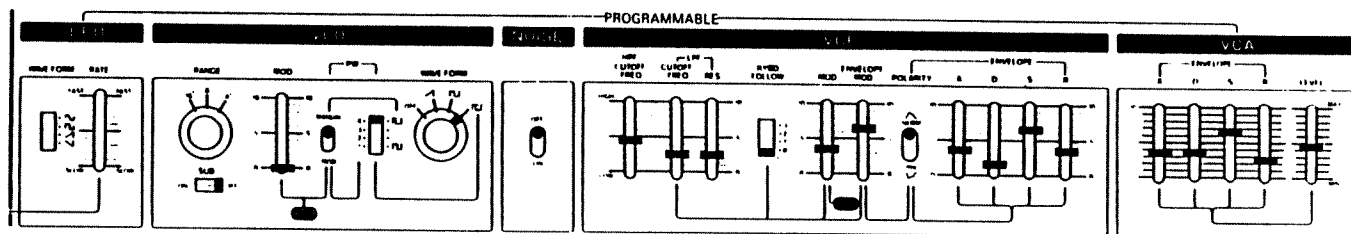

• TRUMPET

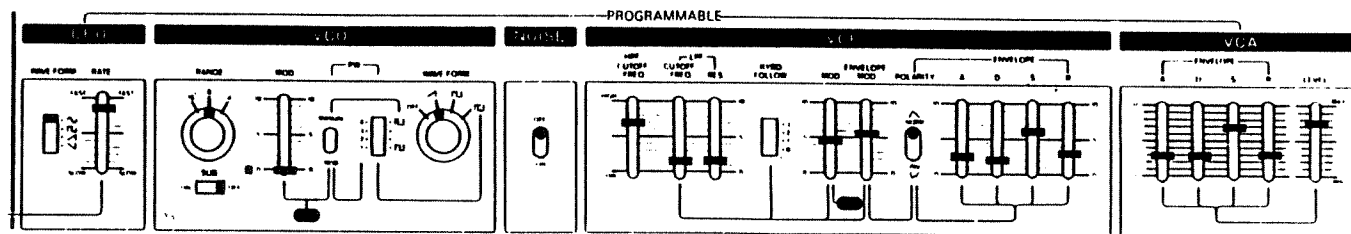

• BASIC SYNTHESIZER SOUND

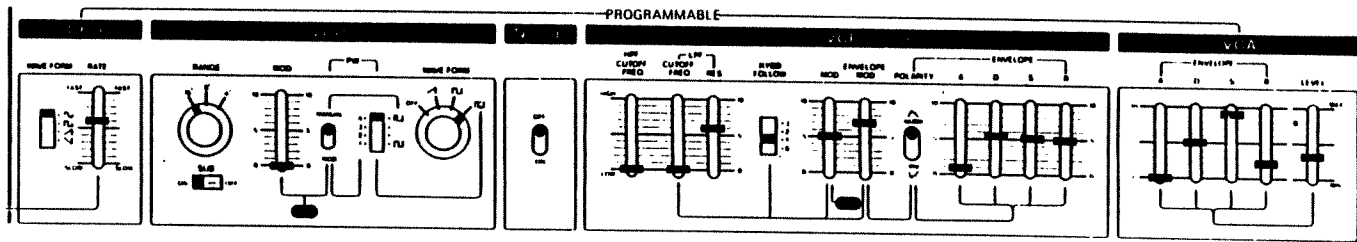

• THE FORCE

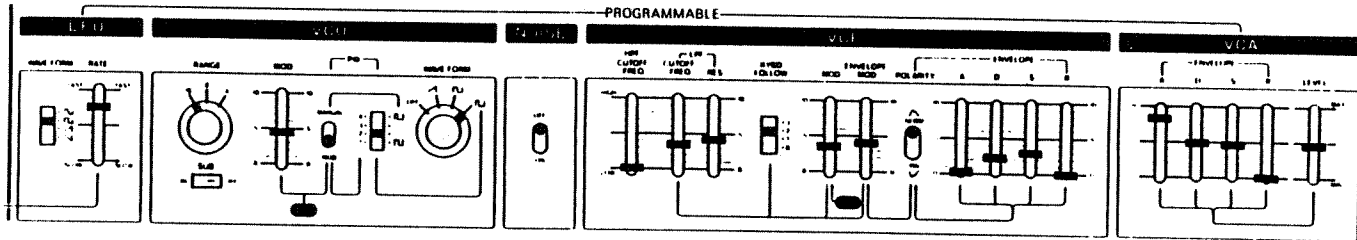

# ● SAMPLE SOUND II

## Setting Examples

Each slider is at a standard position. However the sound will vary depending on the amplifier and speaker used. Therefore make adjustments for final retouching during per-

formance.  
Turn off the sliders when there are no markers in the diagrams.

### ■ CAT CHORUS

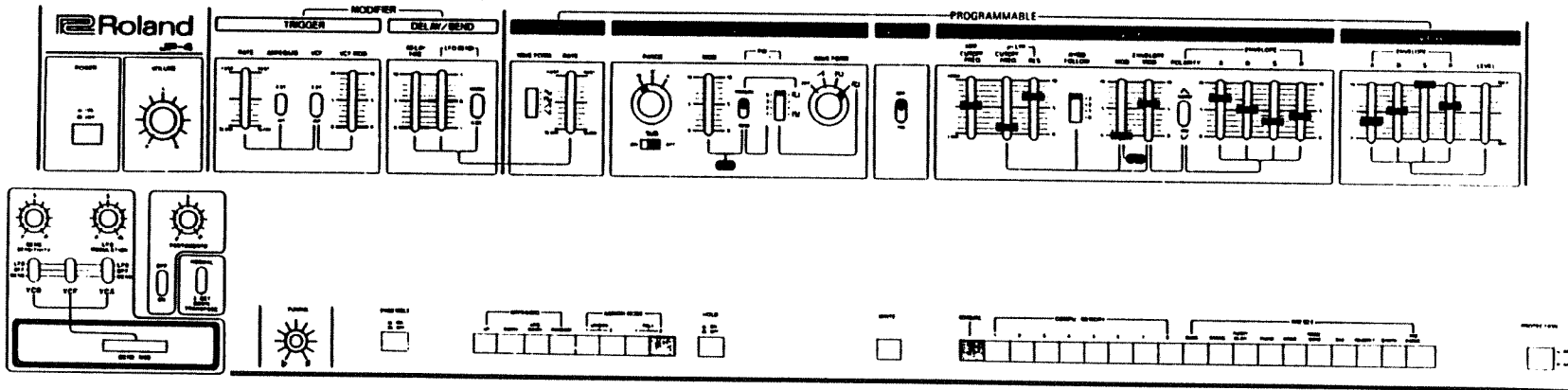

■ SCIENCE FICTION.

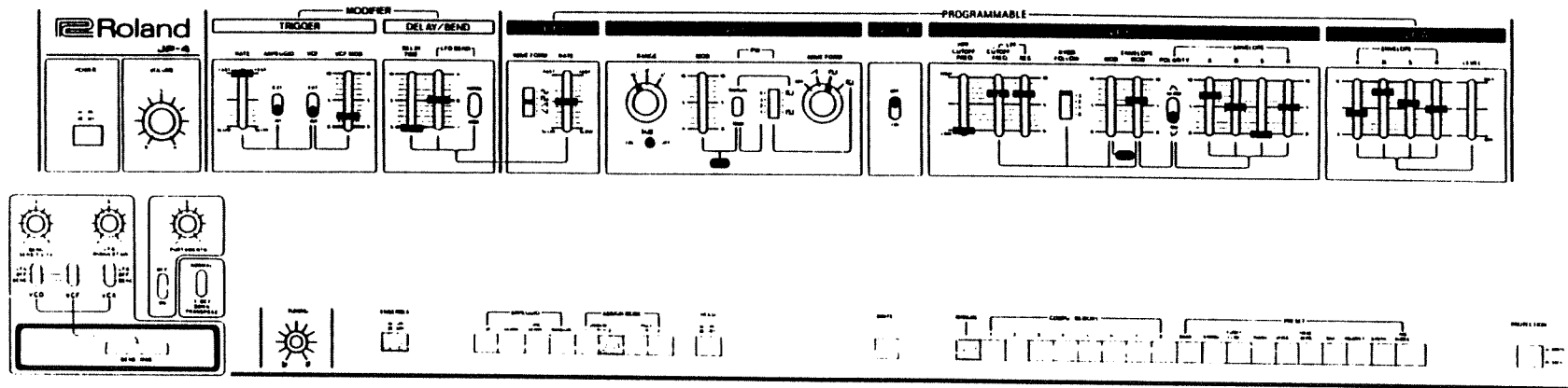

■ "RICK WAKEMAN" SYNTHESIZER SOUND

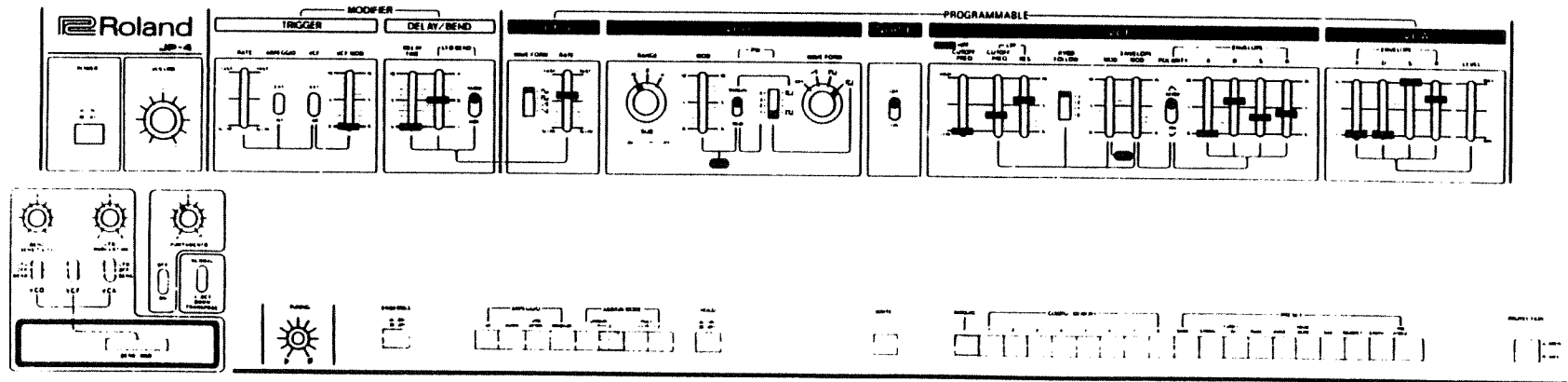



■ COSMIC WIND

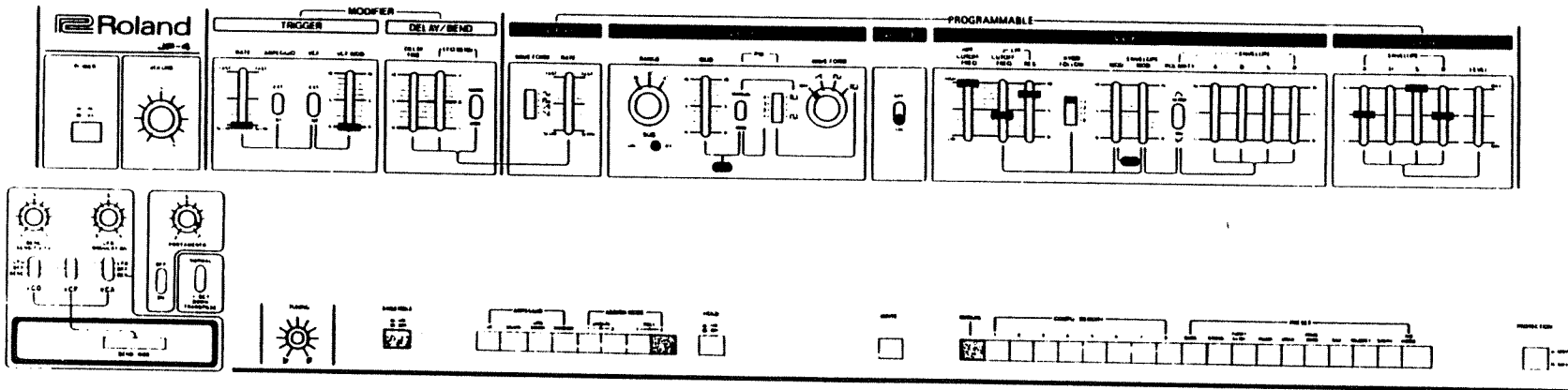

■ "TANGERINE DREAM"

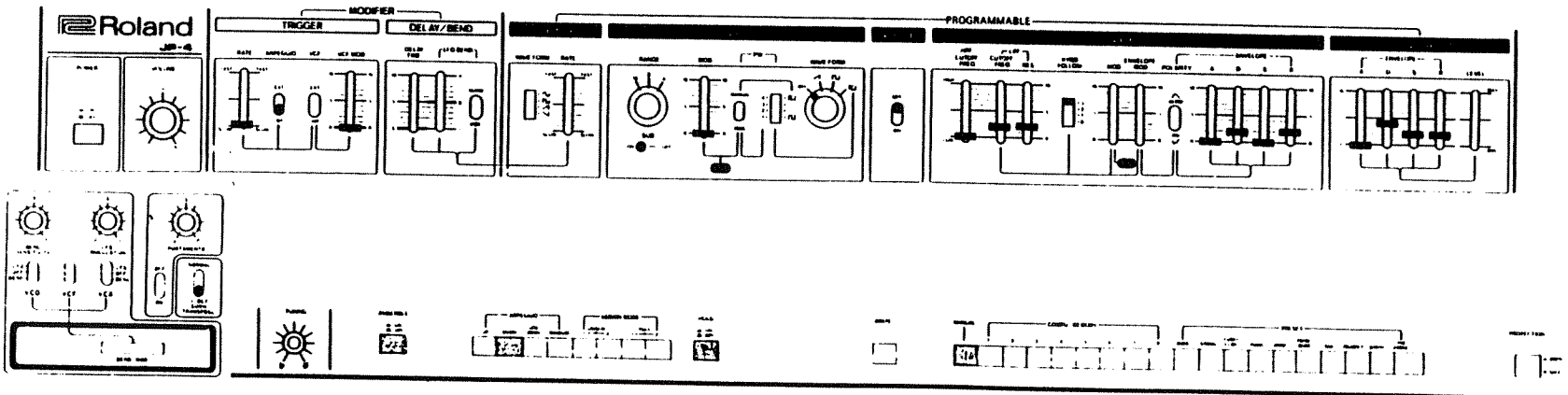

■ SPACE MONSTER

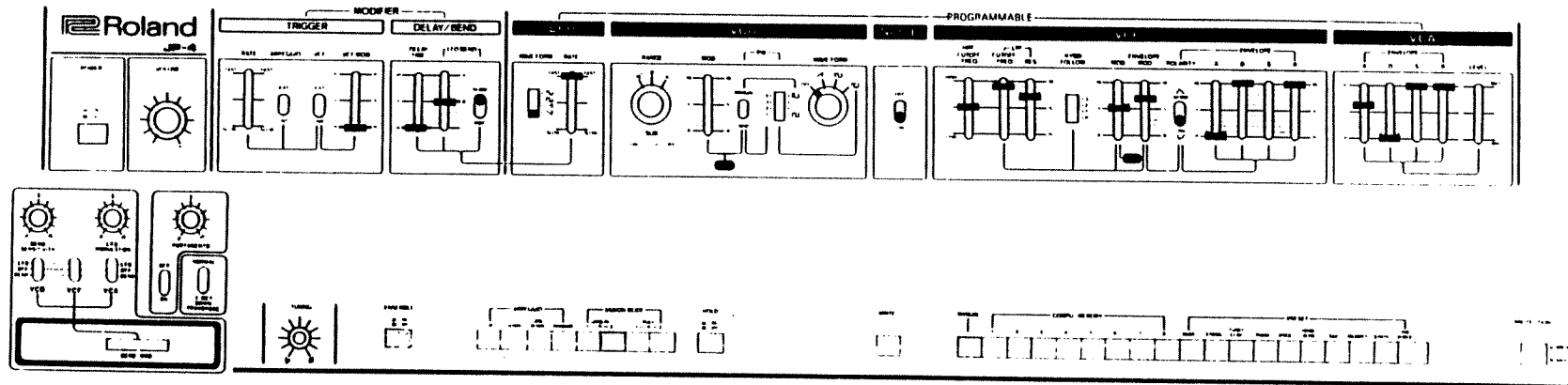

■ ORGAN (WITH CLICK ATTACK)

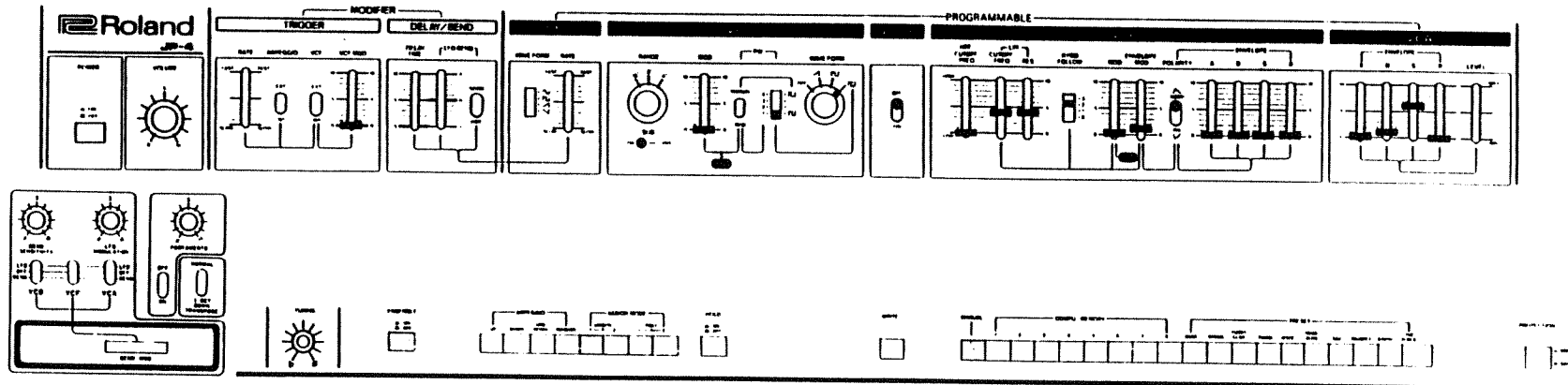

■SPACE SHIP

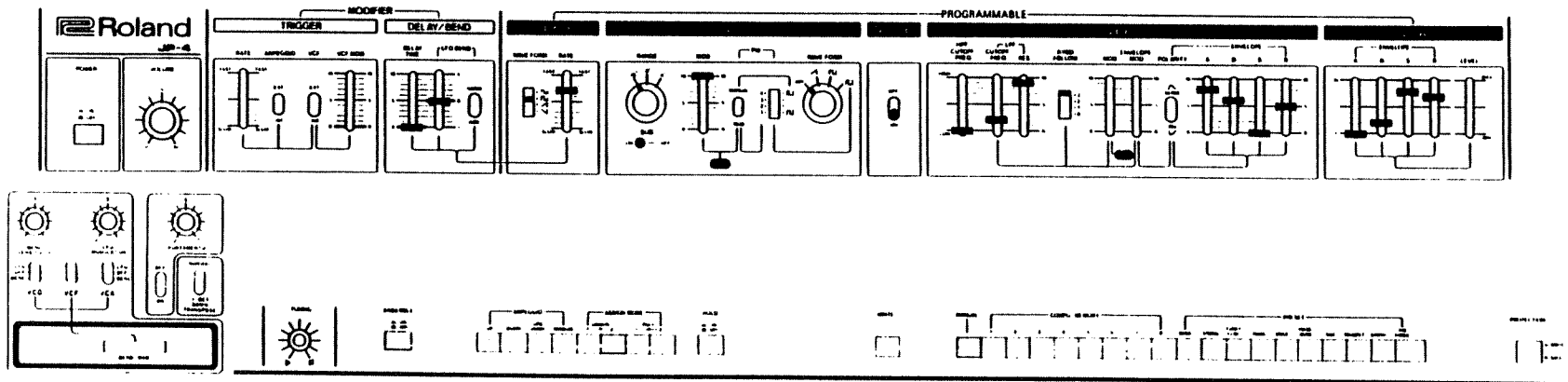

■FANTASY PIANO

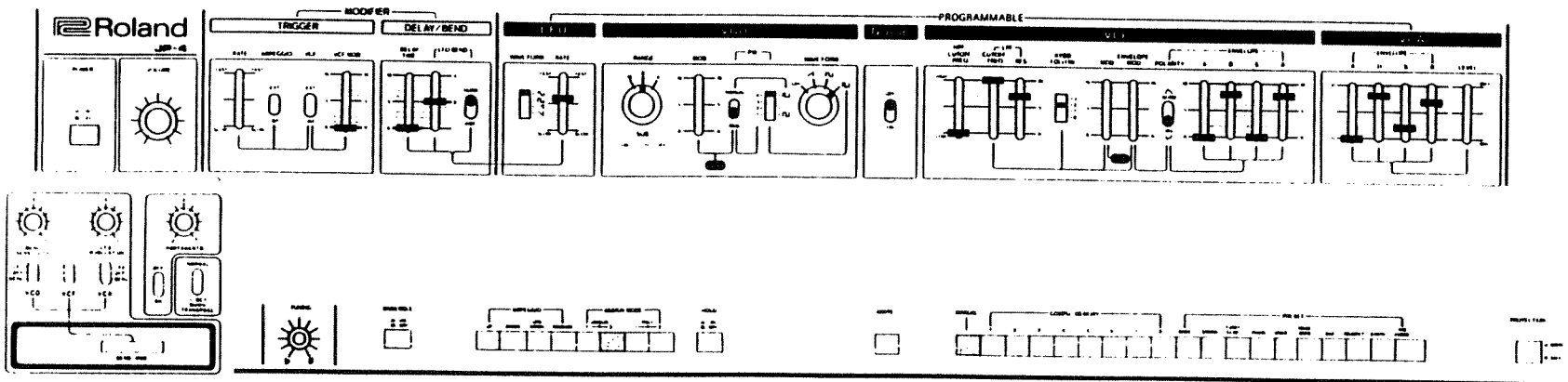



# • SAMPLE NOTES

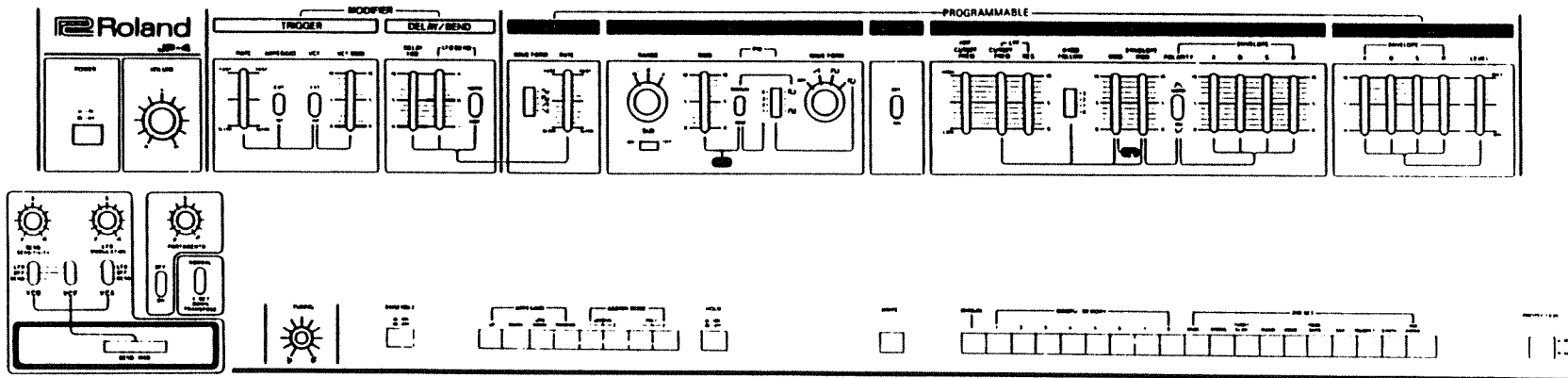
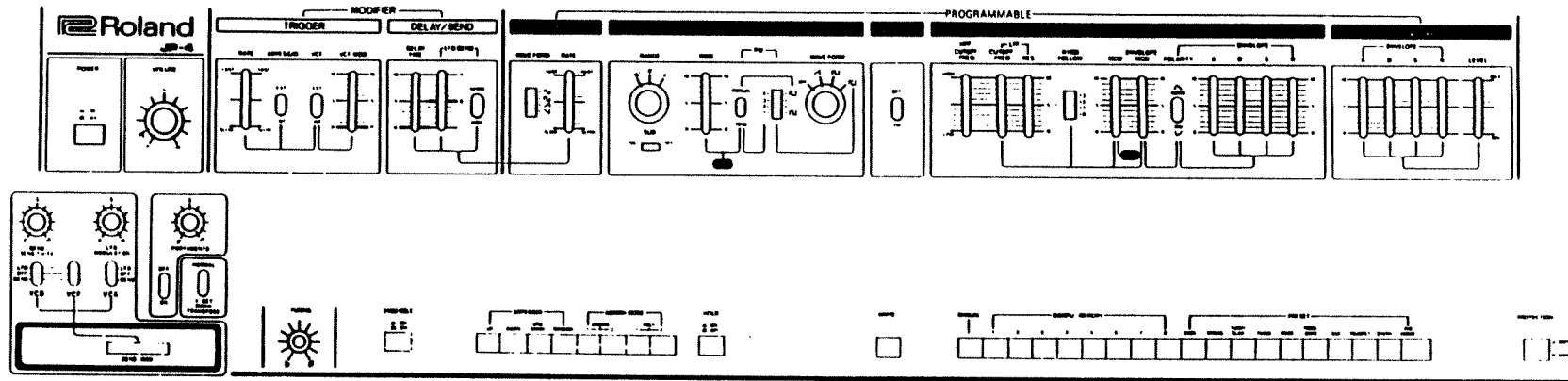



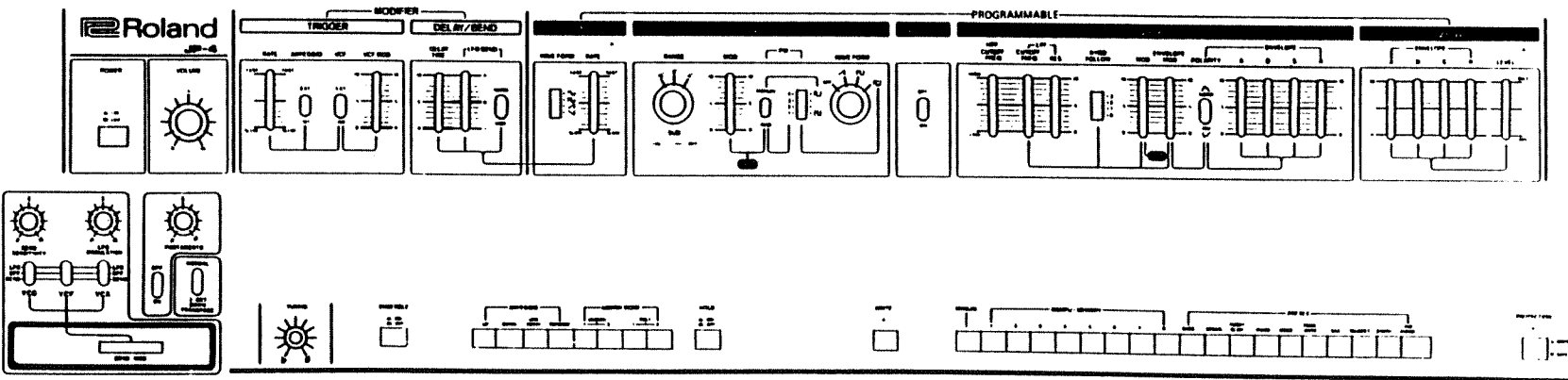
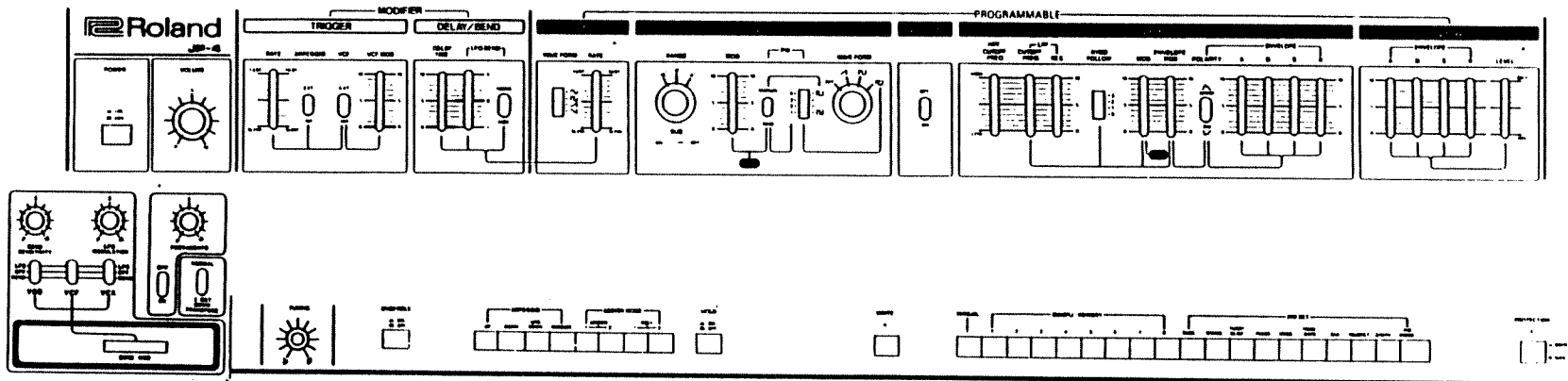

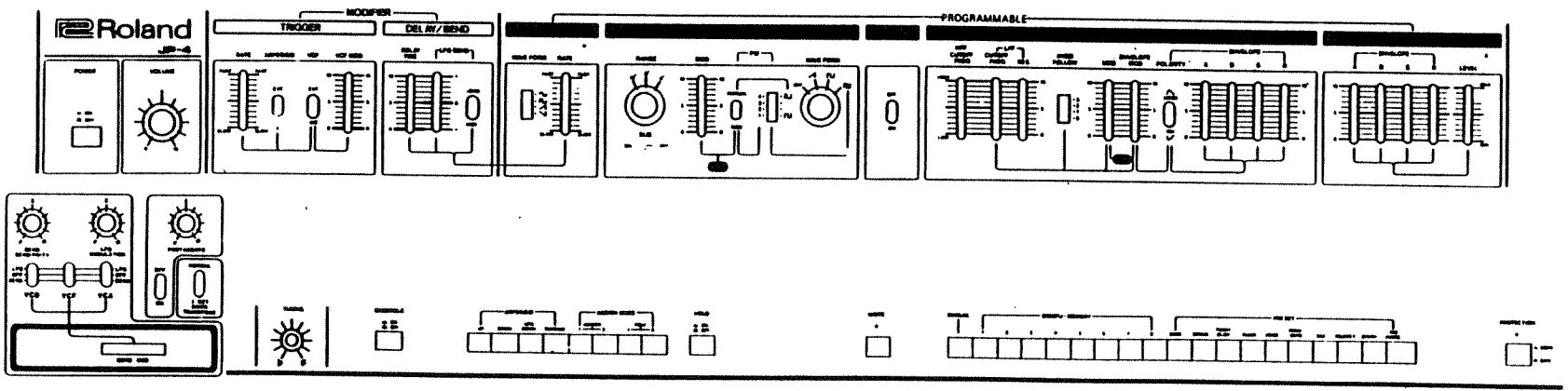
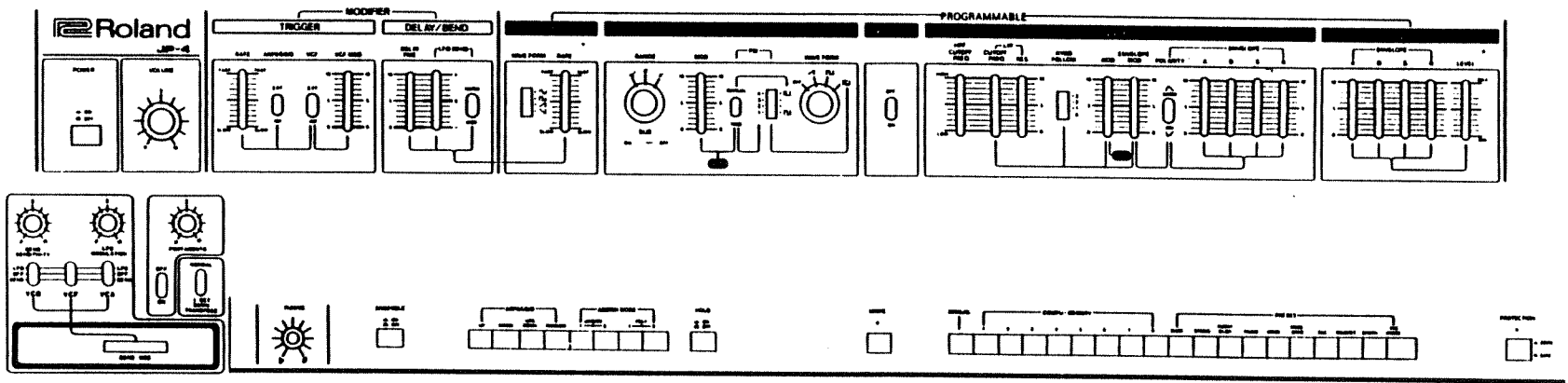

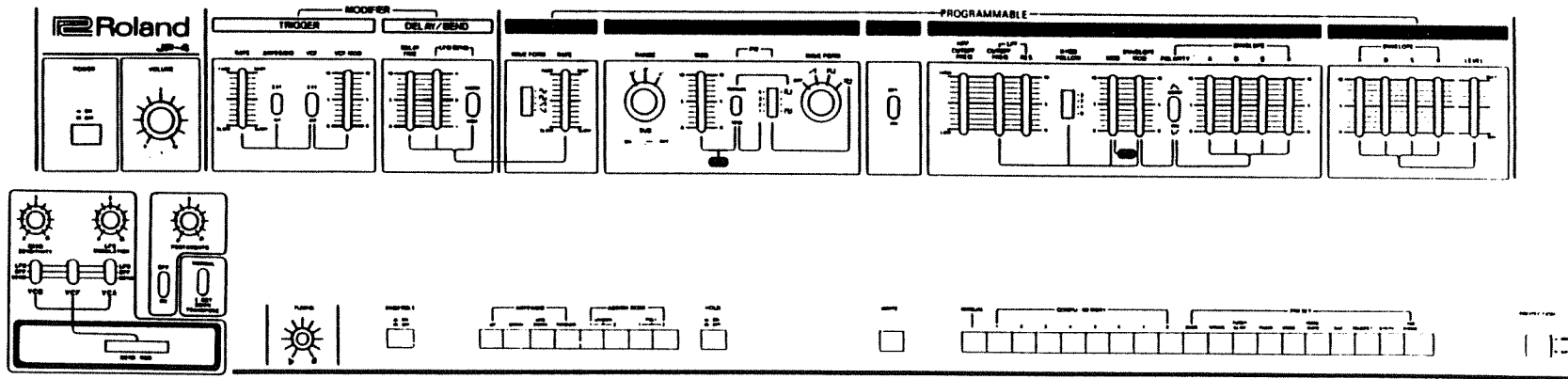
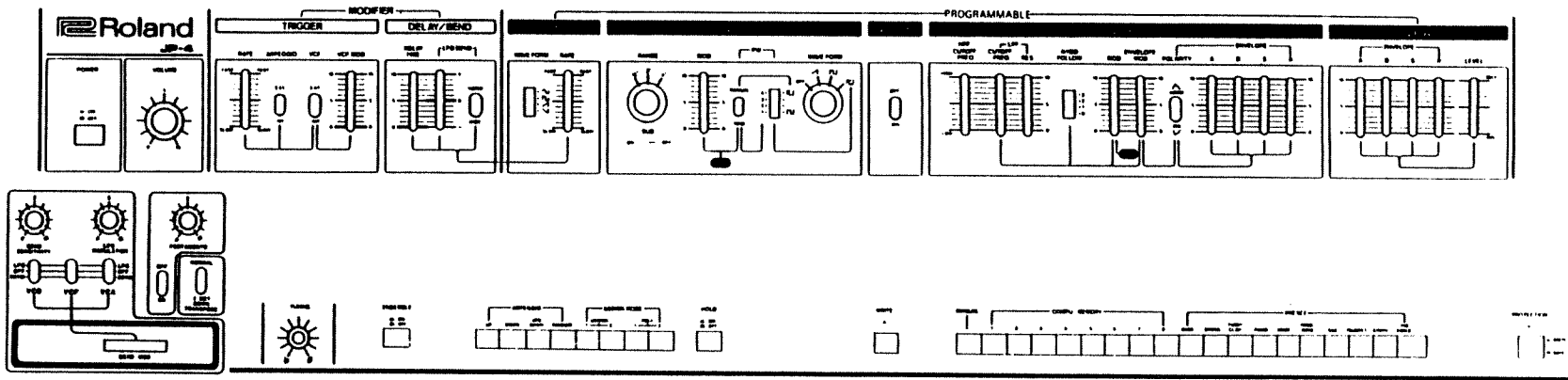

- **Block Diagram**

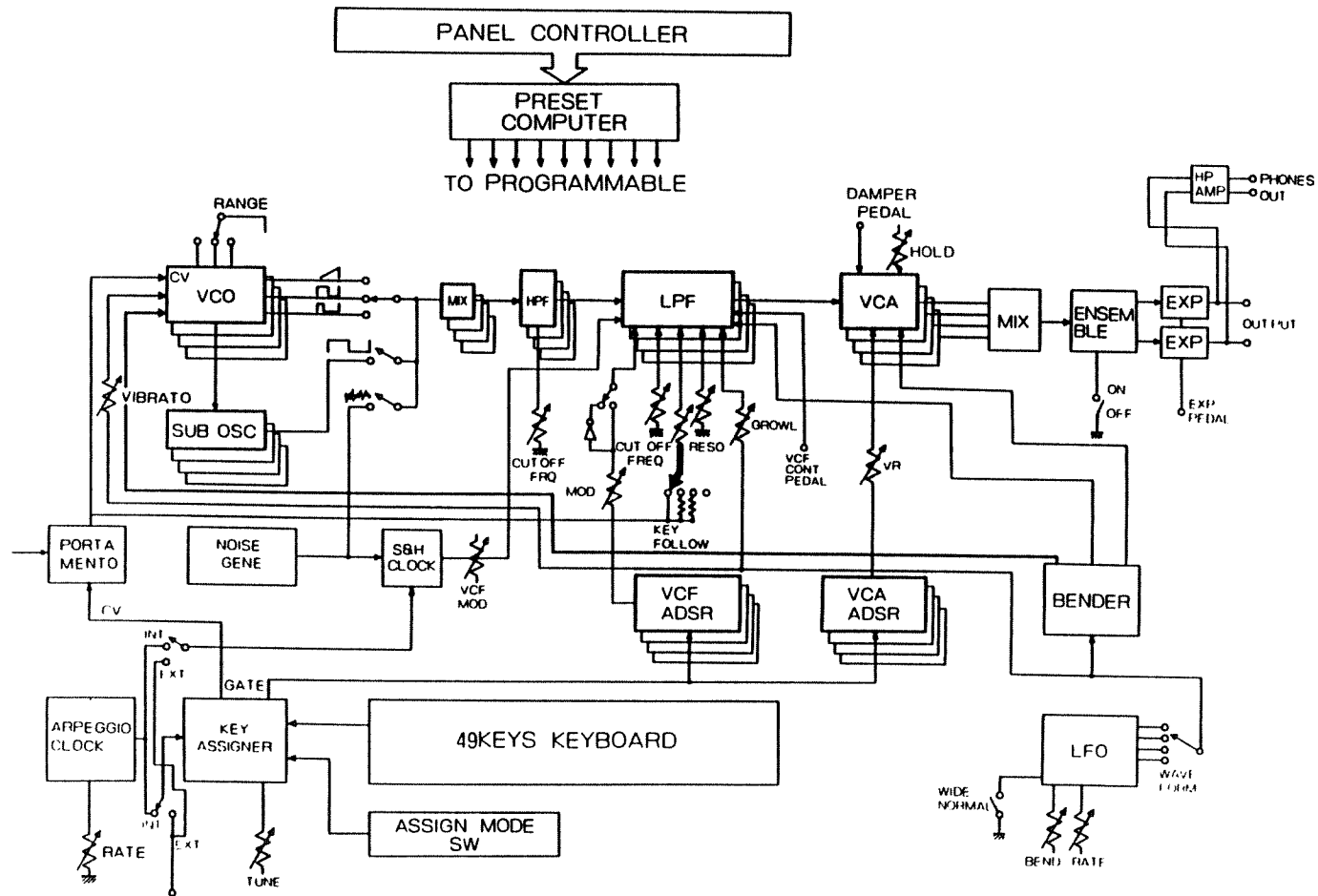

# SPECIFICATIONS

• <b>KEYBOARD</b> (49-keys, 4 octaves, C scale)	
• <b>SYNTHESIZER MODULES</b> .....	4
• <b>VCO (VOLTAGE CONTROLLED OSCILLATOR)</b>	
VCO RANGE (16', 8', 4') .....	1
WAVE FORM (∧. □. ▭) .....	1
PULSE WIDTH (50%, 40%, 20%, 10%) and PULSE WIDTH - LFO DEPTH ...	1
PWM MODE SWITCH (MANUAL/LFO) .....	1
LFO MODULATION .....	1
SUB OSCILLATOR (1 oct down) ....	1
• <b>NOISE GENERATOR</b> (ON/OFF SWITCH) .....	1
• <b>VOF (VOLTAGE CONTROLLED FILTER)</b>	
HPF CUT OFF (40Hz - 5KHz) .....	1
LPF RESONANCE (O-Self Oscillation) .....	1
KYBD FOLLOW (10%, 40%, 70%, 100%) .....	1
LFO MODULATION .....	1
ENV MODULATION .....	1
ENV POLARITY (∧/∨) .....	1
• <b>VCA (VOLTAGE CONTROLLED AMPLIFIER)</b>	
VCA OUT LEVEL .....	1
OVERLOAD INDICATOR .....	1
• <b>LFO (LOW FREQUENCY OSCILLATOR)</b>	
WAVEFORM (∧. □. ▭. ∨) .....	1
LFO RATE (OVER 0.1Hz-80Hz) .....	1
LFO RATE INDICATOR .....	1
• <b>ENVELOPE GENERATOR</b> (ENVELOPE GENERATOR) for the VCF, VCA .....	2
ATTACK TIME (0.6 ms - 3 Sec)	
DECAY TIME (14 ms - 10 Sec)	
SUSTAIN LEVEL (0 - 100%)	
RELEASE TIME (14 ms - 10 Sec)	
• <b>MODIFIER</b>	
TRIGGER GENERATOR	
• <b>TRIGGER</b>	
TRIGGER RATE (1Hz - 25 Hz) .....	1
ARPEGGIO SELECTION SWITCH (INT, EXT) .....	1
VCF MOD SELECTION SWITCH (INT, EXT) .....	1
VCF MODULATION	
• <b>DELAY/BEND</b>	
BEND LFO RATE .....	1
BEND LFO RATE WIDTH (NORM, WIDE) .....	1
DELAY TIME (0 - 10 Sec) .....	1
• <b>MODE SELECTOR</b>	
• <b>PRE-SET SELECTION SWITCH</b> ....	10
(BASS, STRING, CLAVICHORD, PIANO, VOICE, TROMBONE, SAX, TRUMPET, SYNTH, THE FORCE)	
• <b>COMPU-MEMORY</b>	
SELECTION SWITCH .....	8
MANUAL SWITCH .....	1
PROTECTION SWITCH .....	1
MEMORY WRITE SWITCH .....	1
WRITE INDICATOR .....	2
(EQUIPPED WITH A BUILT-IN BATTERY BACK-UP)	
• <b>ARPEGGIO AND KEY ASSIGNMENT</b>	
ARPEGGIO SELECTOR (UP, DOWN, UP + DOWN, RANDOM. 4 KEY ASSIGNMENT MODE SELECTOR (UNISON I, II, POLY I, II) .....	4
• <b>CONTROLLER</b>	
PORTAMENTO (1 sec/1 oct) .....	1
PORTAMENTO SWITCH (ON - OFF) ..	1
TRANPOSE (NORMAL - 1 oct. DOWN) .....	1
LFO MODULATION .....	1
BEND SENSITIVITY .....	1
VOC : over ±1 oct. VCF over ±2 oct (RESONANCE PITCH) VCA: over ±12 dB SELECTION SWITCH (LFO/OFF/BEND) .....	1
MANUAL LEVER	
• <b>TUNING (±50 cent. ±1%)</b> .....	1
• <b>ENSEMBLE (ON-OFF)</b> .....	1
• <b>HOLD (ON-OFF)</b> .....	1
• <b>CONNECTION JACKS</b>	
OUTPUT JACK (MONO, STEREO) .....	2
OUTPUT LEVEL SELECTION SWITCH (AVERAGE 0 dB at position H) .....	1
HEADPHONE JACK (stereo) .....	1
HEADPHONE LEVEL SELECTION SWITCH .....	1
EXTERNAL CONTROL JACK .....	4
DAMPER (DP-1, DP-2), VCF (FV-20) EXP, (FV-20, 0 ~ -30 dB) EXTERNAL CLOCK (OFF: ov/on: min. + 1 V pulse)	
• <b>POWER CONSUMPTION</b> .....	30W
<b>OVERALL</b>	
• <b>SIZE</b> .....	946(W)×410(D)×179(H)mm
• <b>NET WEIGHT</b> .....	19 kg
• <b>ACCESSORIES.</b> .....	2.5m hookup cords:2

SPECIFICATIONS ARE SUBJECT TO  
CHANGE WITHOUT NOTICE.

## • Options

### • Pedal Switch



DP-2

### • Foot Volume



FV-20





