

 Roland

MIDI PROGRAMMABLE POLYPHONIC SYNTHESIZER

 **JUNO-2**

Owner's Manual



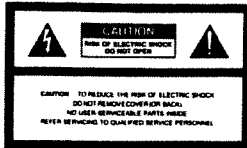

The lightning flash with arrowhead symbol, within an equilateral triangle, is intended to alert the user to the presence of un-insulated "dangerous voltage" within the product's enclosure that may be of sufficient magnitude to constitute a risk of electric shock to persons.



The exclamation point within an equilateral triangle is intended to alert the user to the presence of important operating and maintenance (servicing) instructions in the literature accompanying the product.

INSTRUCTIONS PERTAINING TO A RISK OF FIRE, ELECTRIC SHOCK OR INJURY TO PERSONS.

IMPORTANT SAFETY INSTRUCTIONS

WARNING When using electric products, basic precautions should always be followed, including the following:

1. Read all the instructions before using the product.
2. To reduce the risk of injury, close supervision is necessary when a product is used near children.
3. Do not use this product near water- for example, near a bathtub, washbowl, kitchen sink, in a wet basement, or near a swimming pool, or the like.
4. This product should be used only with a cart or stand that is recommended by the manufacturer.
5. This product, either alone or in combination with an amplifier and headphones or speakers, may be capable of producing sound levels that could cause permanent hearing loss. Do not operate for a long period of time at a high volume level or at level that is uncomfortable. If you experience any hearing loss or ringing in the ears, you should consult an audiologist.
6. The product should be located so that its location or position does not interfere with its proper ventilation.
7. The product should be located away from heat sources such as radiators, heat registers or other products that produce heat.
8. The product should avoid using in where it may be effected by dust.
9. The product should be connected to a power supply only of the type described in the operating instructions or as marked on the product.

10. The power-supply cord of the product should be unplugged from the outlet when left unused for a long period of time.
11. Do not tread on the power-supply cord.
12. Do not pull the cord but hold the plug when unplugging.
13. When setting up with any other instruments, the procedure should be followed in accordance with instruction manual.
14. Care should be taken so that objects do not fall and liquids are not spilled into the enclosure through openings.
15. The product should be serviced by qualified service personnel when:
 - A: The power-supply cord or the plug has been damaged; or
 - B: Objects have fallen, or liquid has been spilled into the product; or
 - C: The product has been exposed to rain; or
 - D: The product does not appear to operate normally or exhibits a marked change in performance; or
 - E: The product has been dropped, or the enclosure damaged.
16. Do not attempt to service the product beyond that described in the user-maintenance instructions. All other servicing should be referred to qualified service personnel.

SAVE THESE INSTRUCTIONS

WARNING

THIS APPARATUS MUST BE EARTH GROUNDED.

The three conductors of the mains lead attached to this apparatus are identified with color as shown in the table below, together with the matching terminal on the UK type power plug. When connecting the mains lead to a plug, be sure to connect each conductor to the correct terminal, as indicated. "This instruction applies to the product for United Kingdom."

| MAINS LEADS | | PLUG |
|-------------|--------------|---|
| Conductor | Color | Mark on the matching terminal |
| Live | Brown | Red or letter L |
| Neutral | Blue | Black or letter N |
| Grounding | Green-Yellow | Green, Green-Yellow, letter E or symbol |

Bescheinigung des Herstellers /Importeurs

Hiermit wird bescheinigt, daß der/die/das
ROLAND POLYPHONIC SYNTHESIZER JU-2
(Gerät, Typ. Bezeichnung)

in Übereinstimmung mit den Bestimmungen der
Amtsbl. Vfg 1046 / 1984
(Anmeldeverfahren)

funk-entstört ist.
Der Deutschen Bundespost wurde das Inverkehrbringen dieses Gerätes angezeigt und die Berechtigung zur Überprüfung der Serie auf Einhaltung der Bestimmungen eingeräumt.

Roland Corporation Osaka / Japan

Name des Herstellers/Importeurs

RADIO AND TELEVISION INTERFERENCE

*Warning - This equipment has been verified to comply with the limits for a Class B computing device, pursuant to Subpart J, of Part 15, of FCC rules. Operation with non-certified or non-verified equipment is likely to result in interference to radio and TV reception.

The equipment described in this manual generates and uses radio-frequency energy. If it is not installed and used properly, that is, in strict accordance with our instructions, it may cause interference with radio and television reception.

This equipment has been tested and found to comply with the limits for a Class B computing device in accordance with the specifications in Subpart J, of Part 15, of FCC Rules. These rules are designed to provide reasonable protection against such a interference in a residential installation. However, there is no guarantee that the interference will not occur in a particular installation. If this equipment does cause interference to radio or television reception, which can be determined by turning the equipment on and off, the user is encouraged to try to correct the interference by the following measures:

- Disconnect other devices and their input-output cables one at a time. If the interference stops, it is caused by either the other device or its I/O cable.
- These devices usually require Roland designed shielded I/O cables. For Roland devices, you can obtain the proper shielded cable from your dealer. For non-Roland devices, contact the manufacturer or dealer for assistance.
- If your equipment causes interference to radio or television reception, you can try to correct the interference by using one or more of the following measures:
 - Turn the TV or radio antenna until the interference stops.
 - Move the equipment to one side or the other of the TV or radio.
 - Plug the equipment into an outlet that is on a different circuit than the TV or radio. (That is, make certain the equipment and the radio or television set are on circuits controlled by different circuit breakers or fuses.)
 - Consider installing a rooftop television antenna with coaxial cable lead-in between the antenna and TV.
- If necessary, you should consult your dealer or an experienced radio-television technician for additional suggestions. You may find helpful the following booklet prepared by the Federal Communications Commission: "How to Identify and Resolve Radio-TV Interference Problems". This booklet is available from the U.S. Government Printing Office, Washington, D.C. 20462. Stock No. GSA-506-023-6.

Please read the separate volume "MIDI", before reading this owner's manual.

Copyright © 1985 by ROLAND CORPORATION

All rights reserved. No part of this publication may be reproduced in any form without the written permission of ROLAND CORPORATION.

1 PANEL DESCRIPTION

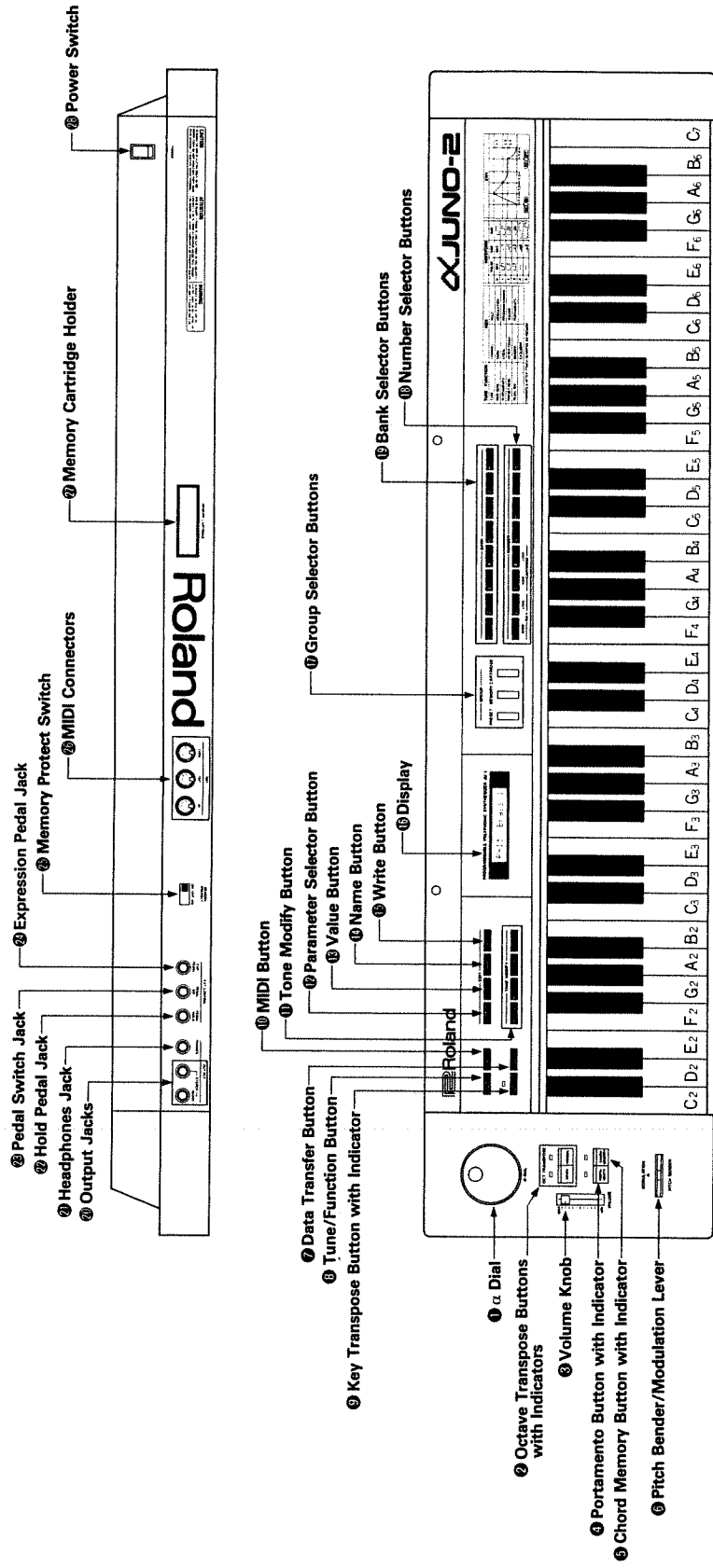

IMPORTANT NOTES

POWER

- The appropriate power supply for this unit is shown on its name plate. Please make sure that the line voltage in your country meets that.
- When setting up the α JUNO with an external amplifier, turn both of them off, plug the α JUNO in first, then the amplifier.
- This unit might not work properly when turned on immediately after turned off. If this happens, simply turn it off, and turn it on again after a few seconds.
- This unit might get hot while operating, but there is no need to worry about it.

LOCATION

- Operating the α JUNO near a neon or fluorescent lamp may cause noise interference. If so, change the angle or position of the α JUNO.
- Avoid using the α JUNO in excessive heat or humidity or where it may be affected by direct sunlight or dust.

CLEANING

- Clean the unit with only soft cloth and mild detergent.
- Do not use solvents such as THINNER.

OTHER NOTES

- The α JUNO is a 6 voice synthesizer, therefore if 6 keys are simultaneously pressed, no more key will sound.

- The α JUNO's memory back-up system is fully supported by a battery. Normally, the battery replacement is required every five years, but the first replacement may be needed even before that depending how many months had passed before you bought it. Please ask for your local Roland dealer for replacement, when the Display responds with as shown below.

Check Batteries!!

- The α JUNO-2 is 61 key, 6 voice polyphonic, fully programmable synthesizer with Dynamics and Aftertouch functions.

- The Liquid Crystal Display and the α Dial serve to make the editing operation quicker and more accurate.
- The Tone Modify Function of the α JUNO allows you to edit the tone color easily to your taste.

- Provided with MIDI Connectors, the α JUNO can be set up with other MIDI devices.

- The optional Memory Cartridge (M-64C) can expand the α JUNO-2's memory capacity by 64 tone colors.

CONTENTS

| | | | | | |
|----------|---|----|----------|--|----|
| 1 | PANEL DESCRIPTION | 3 | 7. | Tone color parameters | 18 |
| 2 | CONNECTION | 5 | a. | Synthesizer Structure | 18 |
| 3 | OPERATION | 6 | b. | Parameters | 19 |
| 1. | Power Up | 6 | c. | Writing a Tone Color | 29 |
| 2. | Tone Color Selection | 6 | d. | Naming the Tone Colors | 30 |
| 3. | Performance Control Functions | 8 | e. | Program Change Messages | 35 |
| a. | Pitch Bender/Modulation | 8 | f. | Data Transfer | 36 |
| b. | Portamento | 8 | a. | Saving into the Cartridge | 36 |
| c. | Octave Transpose | 9 | b. | Loading from the Cartridge to the Memory Group | 37 |
| d. | Chord Memory | 9 | c. | Data Transfer with MIDI | 38 |
| e. | Key Transpose | 11 | 4 | APPENDIX | 40 |
| f. | Hold Pedal Jack | 12 | 1. | Parameter Table | 40 |
| g. | Pedal Switch Jack | 12 | 2. | Error Message Table | 43 |
| h. | Expression Pedal Jack | 12 | 3. | Memo | 44 |
| 4. | Tone Modify | 13 | 5 | SPECIFICATIONS | 47 |
| 5. | Editing Performance Control Function | 14 | | | |
| a. | How to edit the Performance Control Functions | 14 | | | |
| b. | Writing the Performance Control Functions | 16 | | | |
| 6. | Edit | 17 | | | |

Music Rest

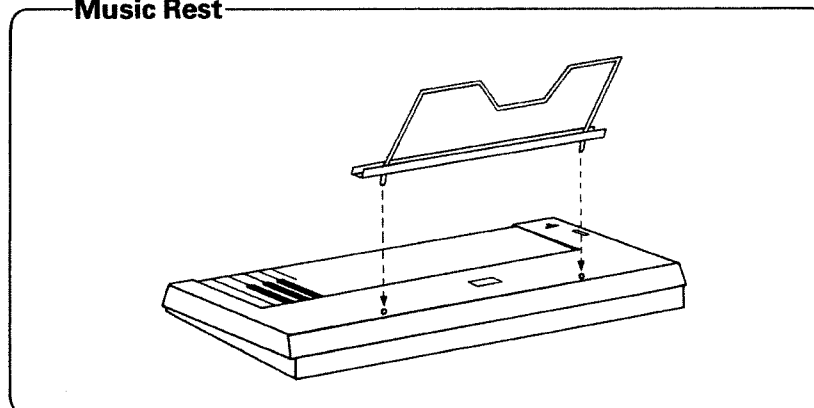

2 Connection

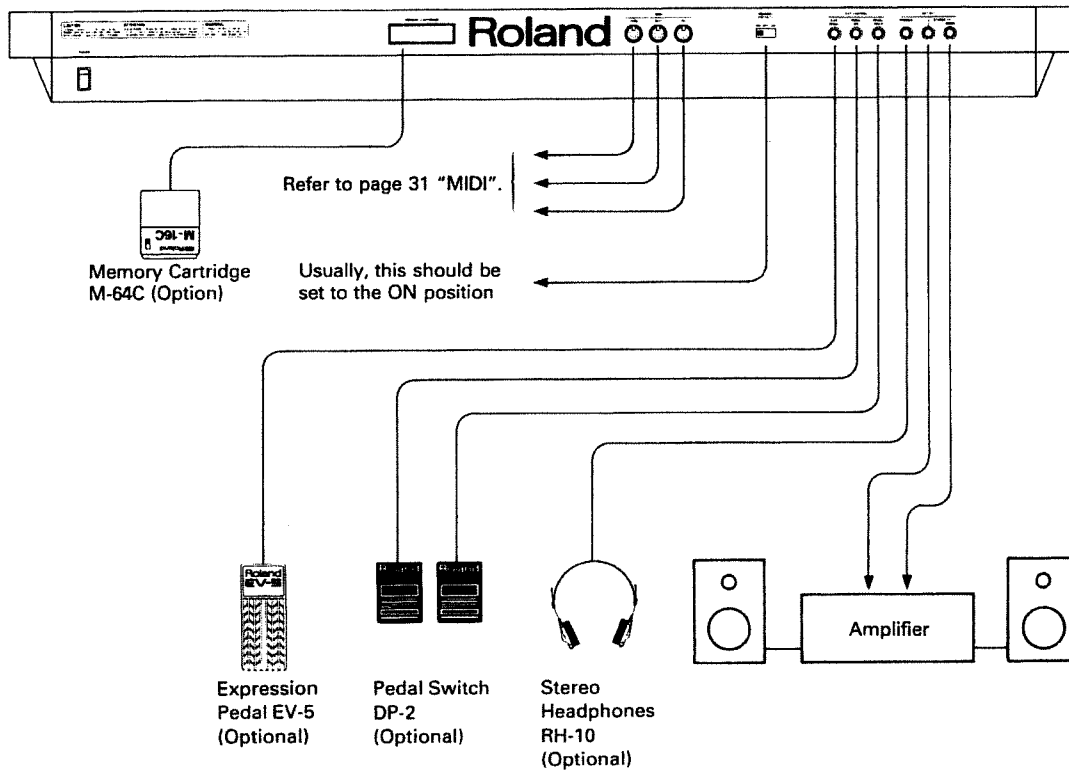

3 OPERATION

1. Power Up

- ① Make sure that the Memory Protect Switch ② on the rear panel is set to the ON position.
- ② Turn the Power Switch ③ on.

The Display Window ④ will respond with:

This is shown for a few seconds

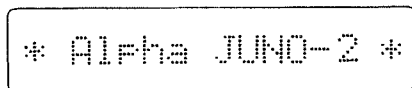

Then the Display changes

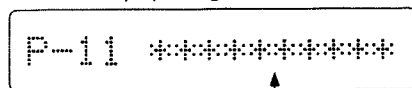

Tone Name

2. Tone Color Selection

Any of the 128 different tone colors (192 tone colors when the optional Memory Cartridge is used) can be called by using the Group Selector Button ⑦, the Bank Selector Button ⑧ and the Number Selector Button ⑨.

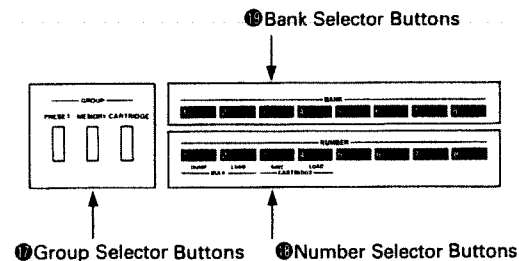

The Display ④ shows the tone color currently selected:

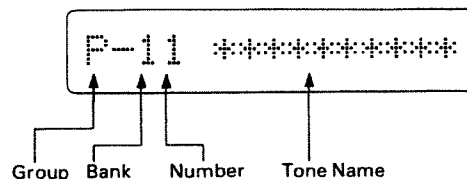

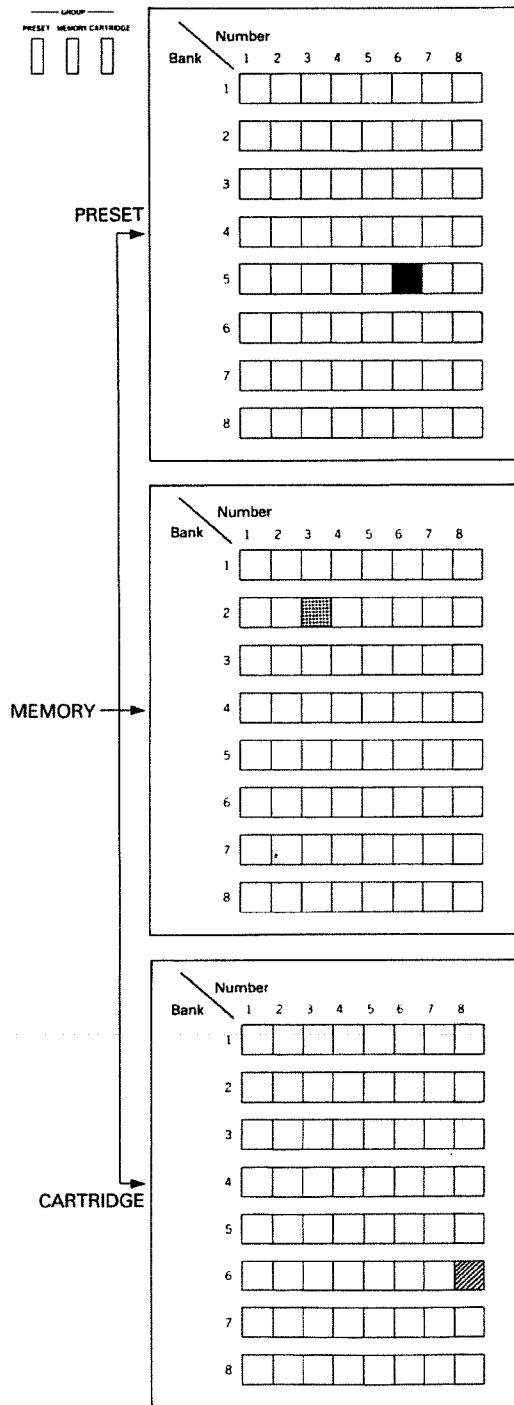

<OPERATION>

① By pressing the appropriate Group Selector Button ①, select Preset, Memory or Cartridge group.

P..... Preset Group

The tone colors in this group can be modified, but the modified patch cannot be written into memory.

M..... Memory Group

The tone colors in this group can be modified and even rewritten.

C..... Cartridge Group

Select this group for using the optional Memory Cartridge M-64C. The tone colors saved in the cartridge can be modified and rewritten. The cartridge can be removed from the α JUNO-2 and used later at any time.

② Select the Bank (1 to 8) by pressing the relevant Bank Selector Button ②.

③ Select the Number (1 to 8) by pressing the relevant Number Selector Button ③.

Now, by using the Volume Knob ④, adjust the volume of the sound.

* The above procedures ① to ③ can be done in any order you like.

3. Performance Control Functions

a. Pitch Bender/Modulation

By bending the Pitch Bender/Modulation Lever ⑥, guitar's bending like effect can be obtained. At its center position, this has no effect on the sound, while the left and right extremes of movement achieve the same amount of the pitch bend effect. Also, by pushing the same lever forward, vibrato effect is obtained.

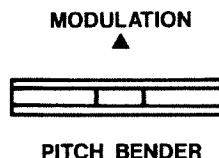

* The range of each tone color's Pitch Bender effect can be changed. If the tone color is in the Preset Group, see page 14 "Editing the Performance Control Functions", and if it is the one in the Memory Group, see page 17 "6. Edit".

* The depth of the Modulation can be changed as shown on page 14 "Editing the Performance Control Functions".

b. Portamento

Portamento effect is a slide from one pitch to another. This may be effectively used for the performance with the Chord Memory function.

<OPERATION>

To turn Portamento on:



Push the Portamento Button ④

The indicator lights up.

To turn Portamento off:

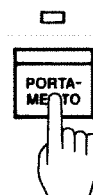

Push the Portamento Button ④ again.

The indicator goes out.

* The time needed for a sound to move from a pitch to another (Portamento time) can be changed as shown on page 14 "Editing the Performance Control Functions".

c. Octave Transpose

The entire keyboard can be transposed one octave down.

<OPERATION>

To set Octave Down Transposition

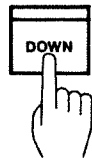

Push the Down Button of the Octave Transpose Buttons ②.

The indicator lights up.

To return to Normal

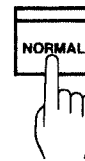

Push the Normal Button of the Octave Transpose Buttons ②.

The indicator lights up.

d. Chord Memory

Chord data can be recorded and later played with one finger.

Example

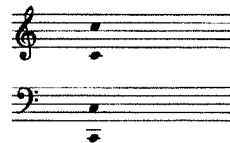

Octave Transpose: Normal
Key Transpose: 0

- When C₄ key is played, the actual chord you hear is exactly in the same pitch as the recorded one.

<OPERATION>

To set to the Chord Memory mode

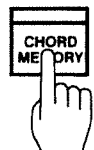

Push the Chord Memory Button ⑤.

The indicator lights up.

To return to the Normal mode



Push the Chord Memory Button ⑤ again.

The indicator goes out.

● How to record Chord Data used for Chord Memory Function

When a chord data is recorded into the α JUNO with the Memory Protect Switch set to the ON position, it is erased by power off. If you wish to retain the recorded chord data even after power off, you should record it with the Memory Protect Switch ⑫ set to the OFF position.

<OPERATION>

- ① Set the Memory Protect Switch as shown below.

ON OFF ON



Memory Protect Switch ⑫: ON →
Erased when the power is off.

ON OFF ON



Memory Protect Switch ⑫: OFF →
Retained even after the power is off.

- ② Press the Write Button ⑬ while holding the Chord Memory Button ⑪ down.

The Display ⑭ will respond with:

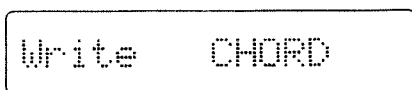

- ③ Play the chord you wish to record.

When all the keys are released, the chord data is recorded, and the Display ⑭ will respond with:

When the Memory Protect Switch is set to ON.

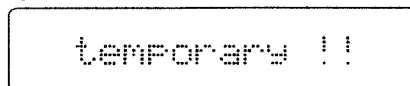

When the Memory Protect Switch is set to OFF.

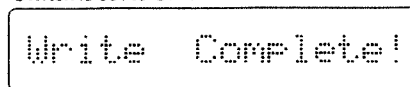

- ④ If necessary, return the Memory Protect Switch to the ON position.

* While a chord data is being recorded, the Octave Transpose or Key Transpose function does not work, therefore, the middle C key always works as C4 key.

* When the recorded chord is being played, the Octave Transpose and Key Transpose functions work. When Octave Transpose is normal and the Key Transpose is 0, playing the C4 key will faithfully recall the recorded chord.

* By recording the C4 key, the α JUNO can be played as a monophonic keyboard.

* If the keyboard is being played extremely fast or too many NOTE ON messages are continuously sent into the MIDI IN, the chords may not properly sound.

e. Key Transpose

The keyboard can be transposed to any key you like within \pm an octave (-12 to $+12$ value). Therefore, you can play music in various keys without using different keys.

*** This Key Transpose operation cannot be done unless the Display 16 is showing a tone name and no key is played on the keyboard.**

How to Transpose

1. Using the α Dial 1

- 1 Push the Key Transpose Button 9.



The value (0) shown in the Display represents how many semi-tones (keys) are currently transposed.

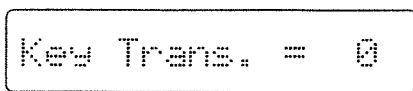

- 2 While holding the Key Transpose Button 9 down, rotate the α Dial to set the desired value. (Refer to the picture shown below.)

The Display 16 shows the corresponding value, and if it is other than 0, the indicator lights up.

2. Using an appropriate key

- 1 Push the Key Transpose Button 9.



The value (0) shown in the Display represents how many semi-tones (keys) are currently transposed.

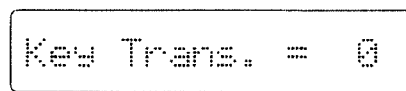

- 2 While holding the key Transpose Button 9 down, push the key to which you wish to transpose.

The Display 16 shows the corresponding value, and if it is other than 0, the indicator lights up.

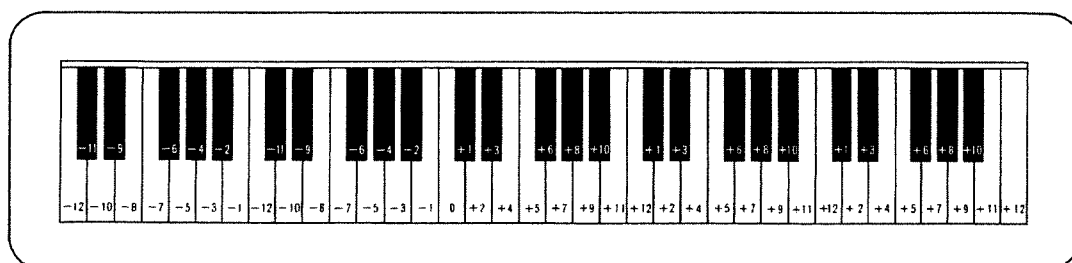

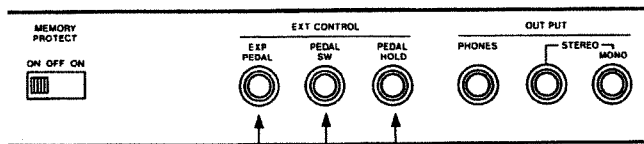

f. Hold Pedal Jack

The α JUNO features the Hold effect that can retain the sound even after the key is released. Using the optional Pedal Switch DP-2, the Hold effect can be turned on or off.

g. Pedal Switch Jack

Using the optional Pedal Switch DP-2, the function selected at "Editing Performance Control Functions" on page 14 can be controlled.

*** Program Shift function is set at the factory. Programs Shift is the function of calling tone colors 1 to 8 sequentially.**

When "M-13" is initially set, the Tone Number will change as shown below.

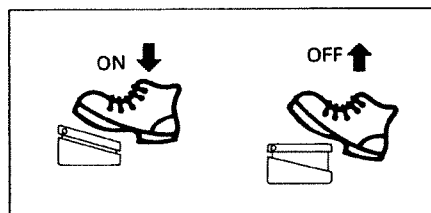
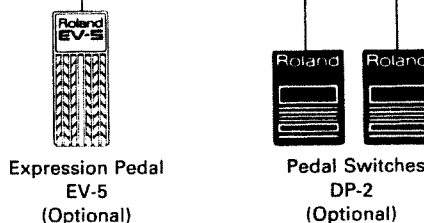
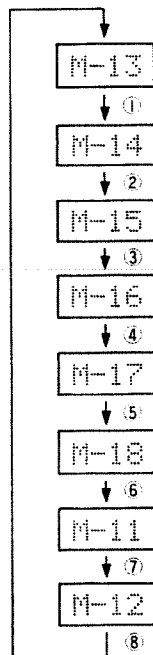

h. Expression Pedal Jack

By using the optional Expression Pedal EV-5 to this jack, the volume can be controlled.

4. Tone Modify



Several parameters of a tone color can be simultaneously changed with a simple operation. There are four modes for the Tone Modify.

| Mode | Tone Modify Mode Button ① | Function |
|------------------|---------------------------|---|
| Modulation Rate | MOD RATE | This mode changes the rate of the vibrato, growl or chorus effect. |
| Modulation Depth | MOD DEPTH | This mode changes the depth of the vibrato or growl effect. |
| Brilliance | BRILLIANCE | This mode changes the brilliance of the sound. |
| Envelope Time | ENV TIME | This mode changes the time needed for a tone color to change from the moment the key is played. |

<OPERATION>

- ① Call the tone color you wish to edit.
- ② Select one of the four modes by pushing the corresponding Tone Modify Mode Button ①.

The Display will respond as shown right:

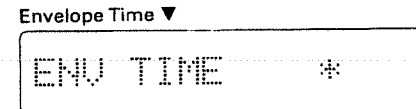
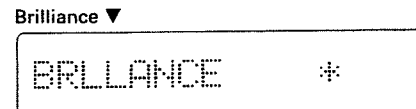
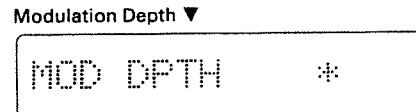
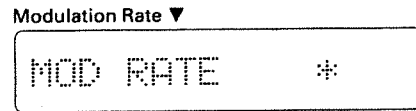

- ③ Using the α Dial ①, modify the tone color to your taste.

Rotating the α Dial will change the Display ② as shown below.

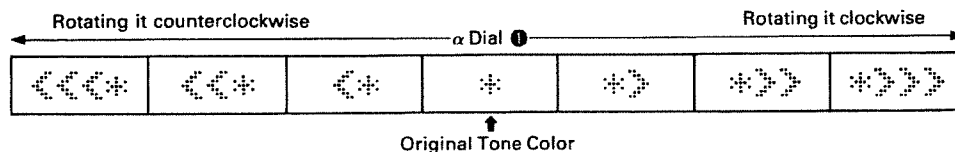

* The edited tone color will be erased by selecting a different tone color. To retain the edited patch, take an appropriated writing procedure. (See page 29.)

* This Tone Modify operation may have no effect on some tone colors. For instance, the tone color without vibrato or growl effect will not change at all even by changing the depth or rate of the Modulation effect.

5. Editing Performance Control Functions

Using the Tune/Function Button **8**, you can change the settings (data) of the Tuning and other functions for performance control. The changed data is erased when the unit is powered off. If you wish to retain the data even after powered off, take an appropriate writing operation.

| Parameter |
|---|
| 1. Tuning |
| 2. Modulation Sensitivity |
| 3. Portamento Time |
| 4. Preset Tone Colors' DCO Bender Range |
| 5. Pedal Switch |

a. How to edit the Performance Control Functions

<OPERATION>

- ① Press the Tune/Function Button **8** until the Display **16** shows the function you wish to edit.

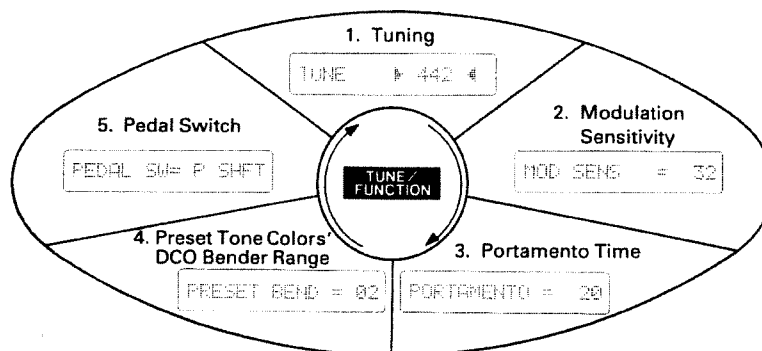

As shown in the picture, each time you push the Tune/Function Button **8**, the function shown in the Display changes.

- ② Using the α Dial, change the value of the function to your taste.

1. Tuning

Example ▼

TUNE ▶ 442 ◀

This function is used to tune with other instrument. The pitch of A4 key can be set to 430 to 454Hz.

The Display ⑩ shows the pitch currently set, and if "▶" mark is shown on the left of the Display, the actual pitch of the α JUNO is slightly lower than the set pitch shown in the Display. If "◀" mark is shown on the right side of the Display, the pitch is higher. When both "▶" and "◀" marks are shown at the both ends of the Display, tuning is done.

2. Modulation Sensitivity

Example ▼

MOD SENS = 32

When the Pitch Bender/Modulation Lever ⑥ controls the Modulation effect, this function determines the depth of the Modulation effect from 0 to 127.

3. Portamento Time

Example ▼

PORTAMENTO = 20

When the Portamento effect is on, this function sets the time needed for the slide of the pitch from one note to another.

* At 0, no portamento effect is obtained, and 127 is the longest time.

4. Preset Tone Colors' DCO Pitch Bender Range

Example ▼

PRESET BEND = 02

When the Pitch Bender/Modulation lever controls the Pitch Bender effect of the whole preset tone colors (P-11 to 88), this sets the depth of the effect from 0 to 12 (1 represents semi-tone).

5. Pedal Switch

Example ▼

PEDAL SW= P SHFT

This function selects which of the Program Shift, Portamento, or Chord Memory function works by the pedal switch connected to the Pedal Switch Jack ⑳.

| Mode | Display ⑩ | Function |
|---------------|-----------|--|
| Program Shift | P SHFT | Pressing the pedal switch sequentially calls the tone colors 1 to 8. After 8, 1 will return. |
| Portamento | PORTA | This turns on or off the Portamento effect. |
| Chord Memory | CRD M | This turns on or off the Chord Memory effect. |

* When the Portamento or Chord Memory function is selected, the effect is on while the DP-2 is being depressed. If you wish to turn the effect on and off alternately by depressing the pedal, use the optional Foot Switch FS-1.

b. Writing the Performance Control Functions

If you wish to retain the data of Tune/Function even after the α JUNO is switched off, you should write it in the back-up memory.

OPERATION

- ① Set the Memory Protect Switch ⑫ to the OFF position.
- ② Push the Tune/Function Button ⑧.

- ③ While holding the Write Button ⑬ down, press the Tune/Function Button ⑧.

The Display ⑩ will respond with:

While holding the Write Button ⑬ down

Write TUNE/FUNC.



When the Tune/Function Button ⑧ is pushed.

Write Complete!

- ④ Return the Memory protect Switch ⑫ to the ON position.

6. Edit

Here, call each parameter of a tone color and change it. Regarding the details of the parameters, see page 18 "7. Tone Color Parameters".

<OPERATION>

- ① Call the tone color you wish to edit.
- ② Push the Parameter Selector Button **Ⓜ**.

The Display will respond with:

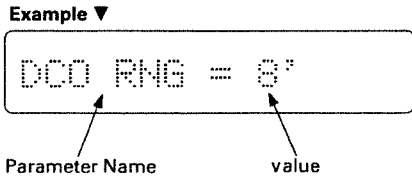

- ③ Using the α Dial **Ⓜ**, call the parameter you wish to change.

- ④ Push the Value Button **Ⓜ**.

As shown in the picture, on the right of the Display **Ⓜ**, the current value and the prospective value are shown.

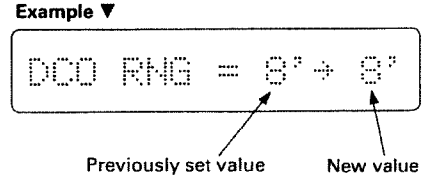

- ⑤ Using the α Dial **Ⓜ**, change to the value you like.
- ⑥ Repeat the steps ② to ⑤ as many times as necessary.

7. Tone Color Parameters

A tone color consists of various parameters, therefore, to edit a tone color, change the values of those parameters.

a. Synthesizer Structure

The α JUNO's synthesizer section consists of several blocks as shown in the picture. Each block of the synthesizer section is controlled by relevant tone-color parameters.

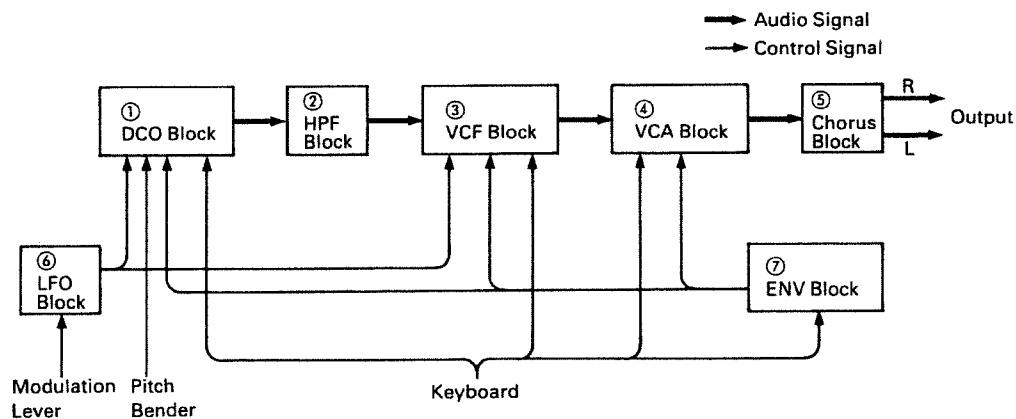

① DCO (Digitally Controlled Oscillator)

DCO is the digitally controlled oscillator that controls the pitch and generates the waveforms that are the sound source of the synthesizer.

② HPF (High Pass Filter)

The HPF (High-Pass Filter) is a filter that passes high frequency harmonics and cuts off the lower ones. This changes the waveform and controls the tone color.

③ VCF (Voltage Controlled Filter)

Each VCF lets lower frequency harmonics of the input signal pass and cuts off the higher ones. In other words, it is a usual low pass filter. By controlling the cutoff point and resonance, the waveform changes, thereby the tone color alters.

④ VCA (Voltage Controlled Amplifier)

After filtered in the VCF, the signal is fed to the VCA where the volume (amplitude) of the sound is controlled.

⑤ CHORUS

⑥ LFO (Low Frequency Oscillator)

This oscillator generates extremely low frequency, so produces a vibrato or growl effect by controlling the DCO or VCF.

⑦ ENV (Envelope Generator)

This generates the control voltage (Envelope) which controls the DCO, VCF and VCA, therefore, alters the pitch, tone color and volume in each note.

b. Parameters

DCO (Digitally Controlled Oscillator)

□ DCO Range

Example ▼

DCO RNG = 8'

This is to change the pitch range of the DCO in exact one octave steps from 4' to 32' (4', 8', 16', 32'). 8' is standard.

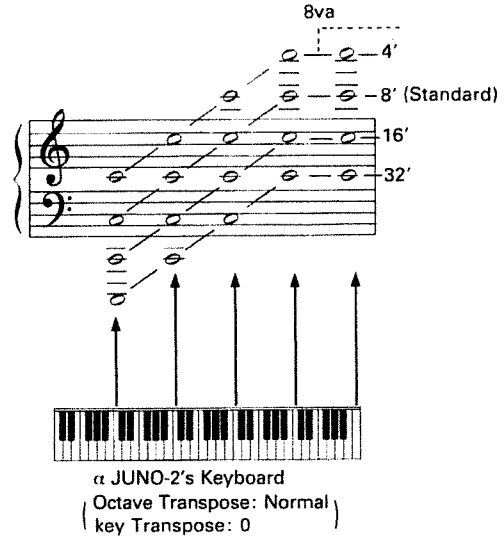

□ DCO LFO Depth

Example ▼

DCO LFO = 20

When the LFO is controlling the pitch of the DCO, this adjusts the depth of the vibrato effect in the range of 0 to 127.

□ DCO ENV Depth

Example ▼

DCO ENV = 60

When the ENV is controlling the pitch of the DCO, this parameter sets the depth of the modulation in the range of the 0 to 127.

□ DCO ENV Mode

Example ▼

DCO ENV =

This selects the polarity of the Envelope curve that controls the DCO. Usually may be used. In mode, ADSR pattern will be inverted.

| Mode | Display | Function |
|----------------------|---------|---|
| Normal | | ENV serves to increase the DCO's pitch. |
| Invert | | ENV serves to decrease the DCO's pitch. |
| Normal with Dynamics | | The ENV with Dynamics serves to increase the DCO's pitch. |
| Invert with Dynamics | | The ENV with Dynamics serves to decrease the DCO's pitch. |

DCO Aftertouch Sensitivity

Example ▼

DCO AFTR= 15

This parameter determines the depth of the vibrato effect when it is controlled by aftertouch. 0 to 15 are valid for this parameter.

DCO Bender Range

Example ▼

DCO BEND= 12

This sets the maximum effect of the Pitch Bender caused by moving the Pitch Bender/Modulation lever. 0 to 12 are valid for this parameter, and 1 is semi-tone, therefore, 12 is an octave.

DCO Pulse Waveform

Example ▼

PULSE = 01

Pulse wave is selected.

| Display | Waveform | Spectrum |
|---------|----------|--------------------------------|
| 00 | OFF | |
| 01 | | |
| 02 | | |
| 03 | | See page 21 "DCO PW/PWM Depth" |

* The pulse width of 03 can be set at DCO PW/PWM Depth.

DCO Sawtooth Waveform

Example ▼

SAWTOOTH= 01

Sawtooth waveform is selected.

| Display | Waveform | Spectrum |
|---------|----------|--------------------------------|
| 00 | OFF | |
| 01 | | |
| 02 | | |
| 03 | | See page 21 "DCO PW/PWM Depth" |
| 04 | | |
| 05 | | |

* The pulse width of 03 can be set at DCO PW/PWM Depth.

DCO Sub Oscillator Waveform

Example ▼

SUB = 00

This selects the waveform of the Sub Oscillator that generates the pitch 1 or 2 octaves lower than the pulse wave or sawtooth wave.

| Display | Waveform | Pitch | Spectrum |
|---------|----------|--------------|----------|
| 00 | | 1 oct. lower | |
| 01 | | 1 oct. lower | |
| 02 | | 1 oct. lower | |
| 03 | | 1 oct. lower | |
| 04 | | 2 oct. lower | |
| 05 | | 2 oct. lower | |

DCO Sub Oscillator Level

Example ▼

SUB LEVEL= 03

This sets the volume of the Sub Oscillator from 0 to 3. At 0, there is no oscillation.

DCO Noise Level

Example ▼

NOIS LVL= 03

This sets the volume of the Noise which is often used for wind or surf. 0 to 3 are valid, and at 0, there is no Noise generated.



DCO PW/PWM Depth

Example ▼

PW / PWM= 80

This parameter works only on the Pulse Wave 03 and Sawtooth Wave 03. The pulse width of a wave can be determined by the value from 0 to 127.

| PW/PWM Depth | PULSE 03 | | SAWTOOTH 03 | |
|--------------|----------|----------|-------------|----------|
| | Waveform | Spectrum | Waveform | Spectrum |
| 00 | | | | |
| 42 | | | | |
| 64 | | | | |
| 102 | | | | |
| 127 | | | | |

□ DCO PWM Rate

Example ▼

PWM RATE= 60

This parameter works only on the Pulse Wave 03 and Sawtooth Wave 03. The rate of the LFO modulation that changes the pulse width of the waveform can be set. 0 to 127 are the values valid for this parameter. At 0, however, the pulse width is not modulated by the LFO but set at the PW/PWM Depth. When this parameter is set to the value other than 0, the pulse width set with the DCO PW/PWM Depth is the widest pulse made by the LFO modulation.

HPF (High Pass Filter)

□ HPF Cutoff Frequency

Example ▼

HPF FREQ= 02

This parameter changes the cutoff point of the HPF.

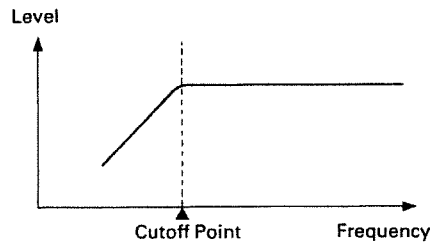

| Display ⑩ | Function | |
|-----------|--|--|
| 00 | The lower frequencies are emphasized, (This is useful for fat bass sound.) | |
| 01 | HPF is off. | |
| 02 | Cutoff point is set at lower frequency. | |
| 03 | Cutoff point is set at higher than 02. The produced sound is harder and thinner than that of 02. | |

VCF (Voltage Controlled Filter)

□ VCF Cutoff Frequency

Example ▼

VCF FREQ= 80

This is for changing the cutoff point of the VCF. As you decrease the value, the cutoff frequency will come down, and the waveform gradually becomes approximation of a sine wave, then the sound will fade out.

0 to 127 are valid for this parameter.

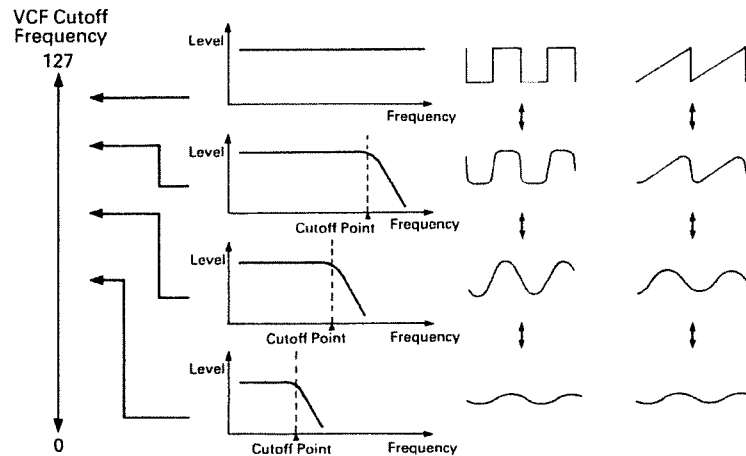

□ VCF Resonance

Example ▼

VCF RESO= 20

This parameter emphasizes the cutoff point set at the VCF Cutoff Frequency. As you increase the value, the created sound will become more unusual, more electronic in nature.

0 to 127 are valid for this parameter.

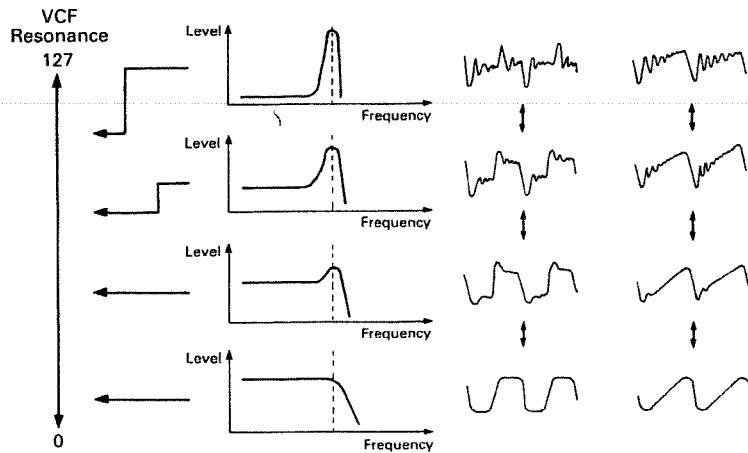

□ VCF ENV Depth

Example ▼

UCF ENV = 60

This parameter controls the cutoff point of the VCF in each note with the ENV curve set in the ENV section. As you increase the value, tone color within one note changes more drastically. 0 to 127 are valid for this parameter.

□ VCF ENV Mode

Example ▼

UCF ENV = ^

This is to select the polarity of the Envelope curve that controls the cutoff point of the VCF. Usually, “^” may be used, in “v” mode, ADSR pattern will be inverted.

| Mode | Display  | Function |
|----------------------|---|--|
| Normal | ^ | ENV serves to increase the VCF's cutoff point. |
| Invert | v | ENV serves to decrease the VCF's cutoff point. |
| Normal with Dynamics | D^ | The ENV with Dynamics serves to increase the VCF's cutoff point. |
| Dynamics | den | This mode is rather special; the ENV has nothing to do with the VCF's cutoff point and the Dynamics directly works to increase the VCF's cutoff point. |

□ VCF LFO Depth

Example ▼

UCF LFO = 60

This parameter sets the depth of the LFO modulation that changes the cutoff point of the VCF (=growl effect). 0 to 127 are valid for this parameter.

□ VCF Keyboard Follower

Example ▼

UCF KYED= 15

This parameter can shift the cutoff point depending on the key played (=pitch). 0 to 15 are valid, and decreasing the value will make the higher pitch softer.

□ VCF Aftertouch Sensitivity

Example ▼

UCF AFTR= 15

When the Aftertouch is controlling the cutoff frequency of the VCF, this parameter sets the sensitivity of the effect. 0 to 15 are valid for this parameter.

VCA (Voltage Controlled Amplifier)

VCA Level

Example ▼

VCA LEVEL= 64

This is for changing the volume, and can be effectively used when writing a tone color. When the value is set too high, sound may be distorted.

VCA ENV Mode

Example ▼

VCA ENV = ENV

This is to select whether to control the VCA by the signal from the ENV or by the Gate signal (Key On/Off signal).

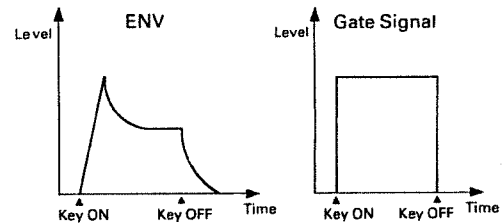

| Mode | Display ⑩ | Function |
|--------------------|-----------|---|
| ENV | ENV | ENV changes the volume. |
| Gate | GT | Gate signal changes the volume. |
| ENV with Dynamics | ENV | ENV with dynamics changes the volume. |
| Gate with Dynamics | DGT | Gate signal with dynamics changes the volume. |

VCA Aftertouch Sensitivity

Example ▼

VCA AFTR= 15

When the Aftertouch is controlling the volume, this parameter determines the sensitivity of the effect.
0 to 15 are valid for this parameter.

CHORUS

Chorus On/Off

Example ▼

```
CHORUS = ON
```

This turns on or off the Chorus effect.

Chorus Rate

Example ▼

```
CRS RATE= 70
```

This parameter determines the rate of the chorus effect from 0 to 127.

LFO (Low Frequency Oscillator)

LFO Rate

Example ▼

```
LFO RATE= 70
```

This parameter changes the rate of the LFO modulation.
0 to 127 are valid for this parameter.

LFO Delay Time

Example ▼

```
LFO DELY= 20
```

This parameter sets the time needed for the LFO modulation to work from the moment the key is played.
0 to 127 are valid for this parameter.

ENV (Envelope Generator)

<Fig. 1>

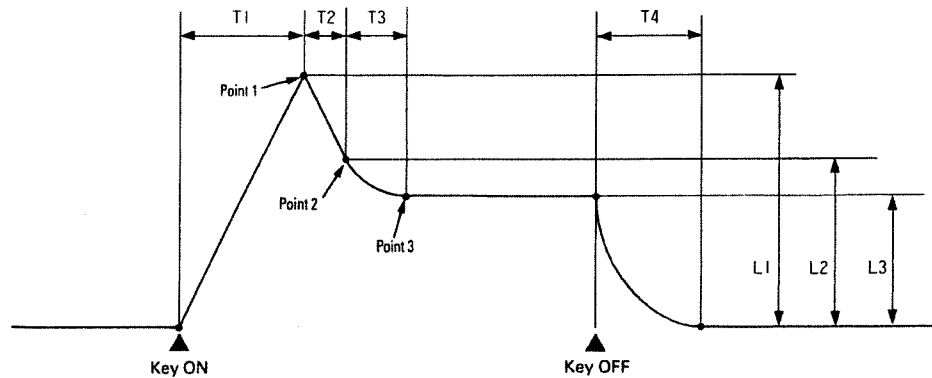

ENV Time 1

ENV T1 = 80

This parameter can set the time needed for a note to reach the point 1 from the moment the key is played.

0 to 127 are valid for this parameter.

In Fig 1, the length of T1 represents it.

ENV Level 1

ENV L1 = 127

This parameter sets the point 1's level. 0 to 127 are valid for this parameter.

In Fig 1, the height of L1 represents it.

ENV Time 2

ENV T2 = 20

This parameter can set the time spent for a note to change from the point 1 to 2.

0 to 127 are valid for this parameter.

In Fig 1, the length of T2 represents it.

ENV Level 2

ENV L2 = 80

This parameter sets the point 2's level. 0 to 127 are valid for this parameter.

In Fig 1, the height of L2 represents it.

ENV Time 3

ENV T3 = 20

This parameter can set the time spent for a note to change from the point 2 to 3.

0 to 127 are valid for this parameter.

In Fig 1, the length of T3 represents it.

ENV Level 3

ENV L3 = 60

This parameter sets the point 3's level. 0 to 127 are valid for this parameter.

In Fig 1, the height of L3 represents it.

ENV Time 4

Example ▼

ENV T4 = 50

This parameter sets the time needed for a note to fall to 0 from the level 3 from the moment the key is released.

0 to 127 are valid for this parameter.

In Fig 1, the length of T4 represents it.

□ ENV Keyboard Follower

Example ▼

ENV KYBD= 15

The time required for the envelope to complete its curve can be changed depending on which key is pressed.

0 to 15 are valid for this parameter.

There is no change of the time at all when it is set to 0, but as the value is increased, envelope time becomes shorter with higher key pressed.

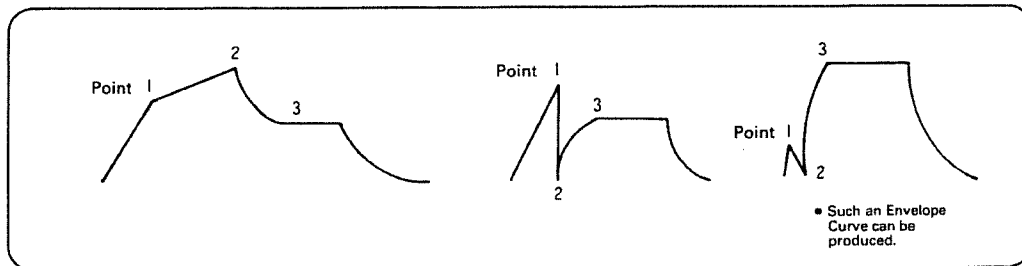
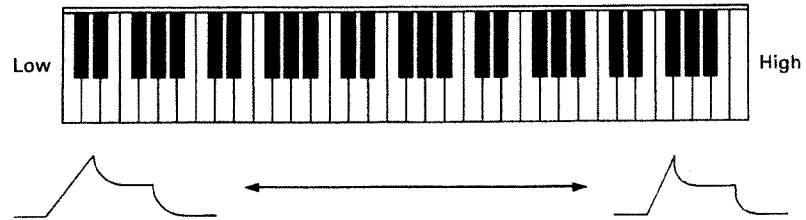

8. Writing a Tone Color

To retain the edited tone color data into the back-up memory, take the following writing operation.

<OPERATION>

- ① To write the tone color into the Memory group, set the Memory Protect Switch ② on the α JUNO-2 to OFF, and to write it into the Cartridge group, set the Protect Switch on the cartridge to OFF.
- ② While holding the Write Button ⑬ down, select the new location for the tone color by pushing appropriate Group Selector Button ⑰ (Memory, Cartridge), Bank Selector Button ⑱ (1 to 8) and the Number Selector Button ⑲ (1 to 8).

The Display ⑩ will change to as shown below.

Example ▼ Editing the PRESET 11 and writing it in the CARTRIDGE 11.

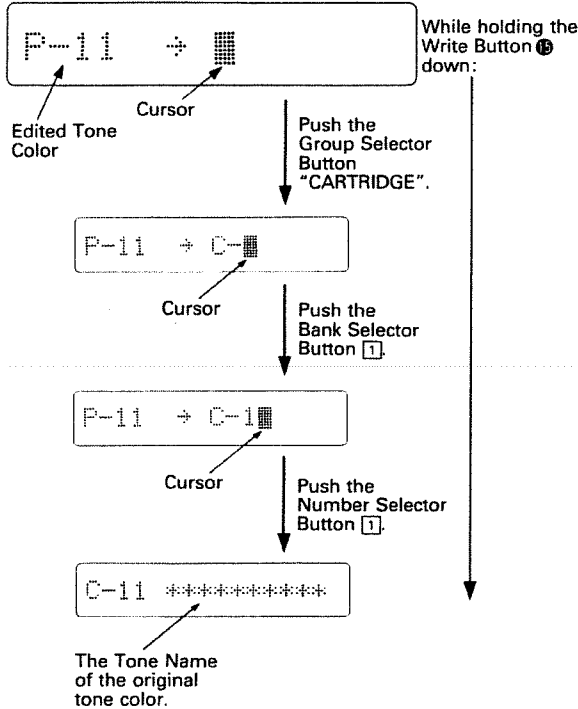

- ③ Return the Memory Protect Switch ② on the α JUNO-2 or the Protect Switch on the cartridge to the ON position.

* If you try to select the Cartridge group without the Cartridge connected to the α JUNO-2, the Display ⑩ will respond with:

Insert Cartridge

When this is seen, securely connect the cartridge, then try again.

* When writing a tone color into the memory cartridge, be sure to set the Protect Switch on the cartridge to the OFF position, then when the writing is completed, return it to the ON position. The position of the Protect Switch ② on the α JUNO-2 has nothing to do with this.

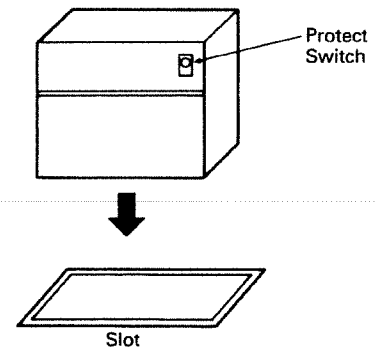

ON: At this position, no data can be written into memory. Therefore, the data is retained even if you take writing procedure by mistake.

OFF: Select this position for writing new data into memory.

9. Naming the Tone Colors

You can write a name (within 10 letters) to each tone color, or rename it.

<OPERATION>

- ① Call the tone color which you wish to rename.
- ② Push the Name Button 14.

The Display 16 will respond with:

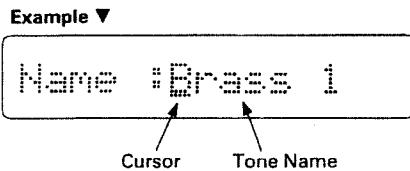

- ③ Keep pressing the Name Button 14 until the cursor comes under the letter to be changed.

The cursor moves one letter rightward each time the Name Button is pressed. When the cursor reaches the right end, it goes back to the beginning.

- ④ Change the name by using the α Dial 1.

The available letters for naming are as follows.

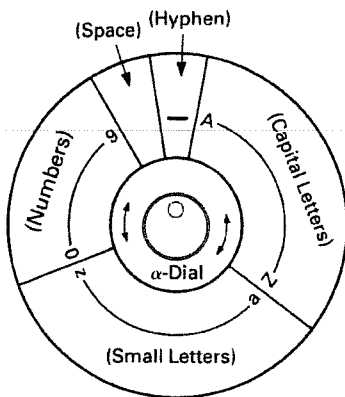

- ⑤ Repeat the steps ③ ④ as many times as necessary.

- ⑥ If the tone color to be written is in the Memory group, set the Memory Protect Switch to the OFF position, and if it is in the Cartridge group, set the Protect Switch on the cartridge to the OFF position.
- ⑦ While holding the Write Button 15 down, select the tone color to be written by pushing the relevant Group Selector Button 17, the Bank Selector Button 19 and the Number Selector Button 18.

The Display 16 will change to:

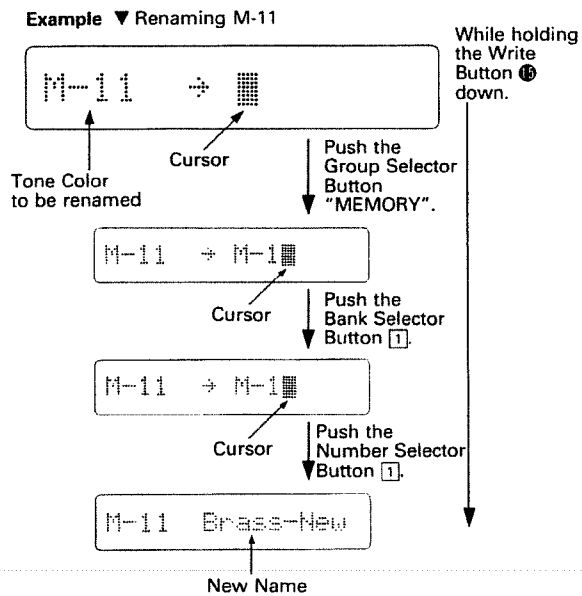

- ⑧ Return the Memory Protect Switch 25 or the Protect Switch on the cartridge to the ON position.

* Taking the operation ⑦ will automatically write the tone color selected in the step ①. So if you do not change the tone color but only the tone name, assign the same tone color you called in the step ①.

* When renaming the tone color in the Cartridge, the position of the Memory Protect Switch 25 has no effect.

10. MIDI

There are three MIDI Connectors ②b on the α JUNO as follows.

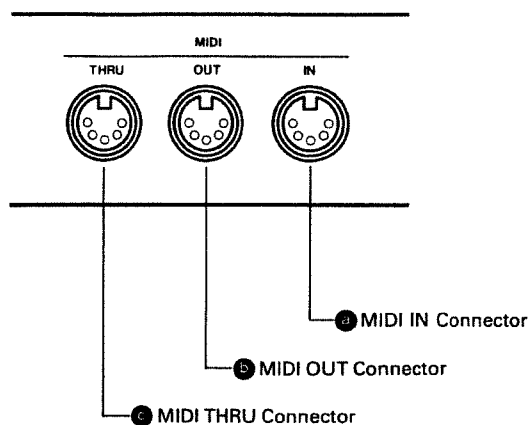

②a MIDI IN Connector

Use this connector for feeding signal from an external MIDI device to control the α JUNO.

②b MIDI OUT Connector

Use this connector for sending signal from the α JUNO to control the external MIDI device.

* The signal fed into the MIDI IN is not sent out through the MIDI OUT.

②c MIDI THRU Connector

The exact copy of the signal fed into the MIDI IN is sent out through this connector.

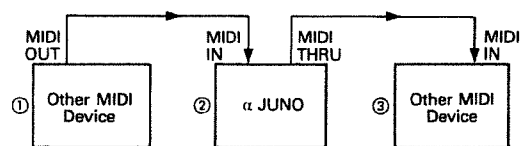

NOTE

Please do not connect more than three MIDI devices through the MIDI THRU Connectors. Use the optional MIDI THRU Box MM-4.

a. Changing MIDI Function Data

The setting of each MIDI function can be changed and written as follows.

| MIDI Function | Factory Preset | Value Display | Description |
|------------------------|----------------|---------------|---|
| 1. MIDI Channel | 1 | 1 ~ 16 | This sets the channel on which the MIDI messages are communicated. |
| 2. MIDI OMNI | OFF | ON/OFF | OMNI ON receives all messages regardless the channel setting. |
| 3. MIDI Local Control | ON | ON/OFF | OFF separates the synthesizer section from the keyboard section in the α JUNO. |
| 4. MIDI Aftertouch | ON | ON/OFF | Aftertouch Message |
| 5. MIDI Bender | ON | ON/OFF | Pitch Bender Message |
| 6. MIDI Exclusive | OFF | ON/OFF | Exclusive Message |
| 7. MIDI Hold | ON | ON/OFF | Hold Message |
| 8. MIDI Modulation | ON | ON/OFF | Modulation Message |
| 9. MIDI Program Change | ON | ON/OFF | Tone Color Selection Message |
| 10. MIDI Volume | ON | ON/OFF | Volume Message |
| 11. MIDI Portamento | ON | ON/OFF | Portamento Message |

<OPERATION>

- Keep pressing the MIDI Button **10** until the MIDI function you wish to change is shown in the Display **10**.

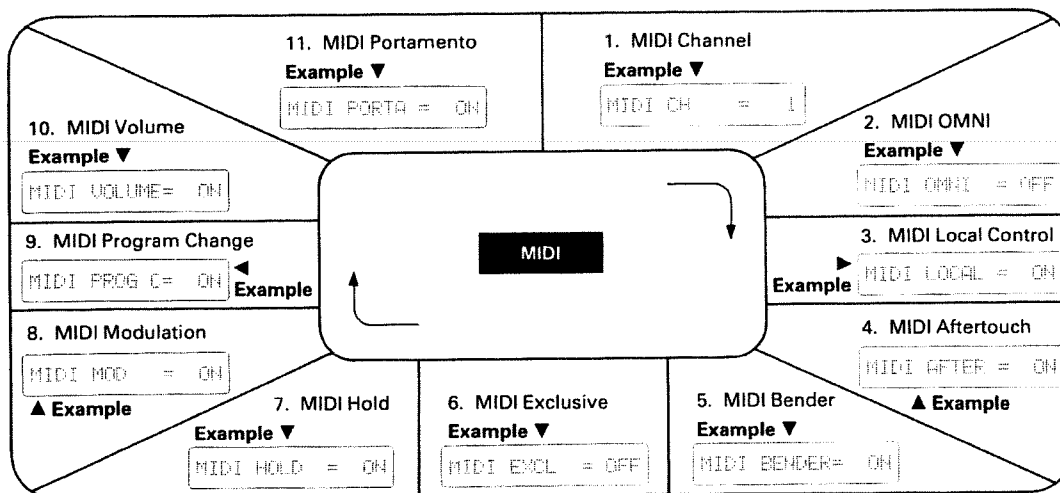

The MIDI parameter shown in the Display changes each time the MIDI Button is pushed.

- Using the α Dial **1**, change the MIDI function to what you like.

b. Writing MIDI Function Data

By writing the data of the MIDI Function setting into the back-up memory, it can be retained even when the unit is turned off.

<OPERATION>

- ① Set the Memory Protect Switch ⑭ to the OFF position.
- ② Push the MIDI Button ⑩.

- ③ While holding the Write Button ⑬ down, push the MIDI Button ⑩.

The Display will change to:

While holding the
Write Button ⑬ down.

Write MIDI FUNC.



When the MIDI Button ⑩ is pushed.

Write Complete!

- ④ Return the Memory Protect Switch to the ON position.

c. α JUNO's Sound Range receivable and transmissible with MIDI

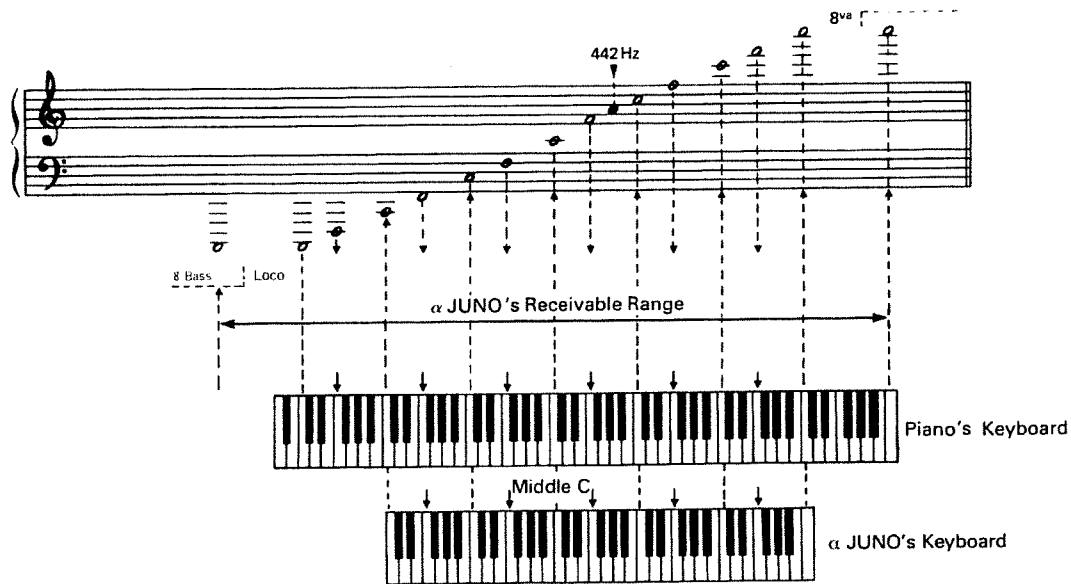

(1) Transmissible Sound Range

The α JUNO-2 features the Key Transpose (1 octave upper and lower) and the Octave Transpose (1 octave lower) functions, therefore can transmit data from 2 octaves lower to 1 octave higher than the actual keyboard.

(2) Receivable Sound Range

The α JUNO-2's receivable sound range with MIDI is 8 octaves as shown above. If the transmitted data exceeds this range, it will be automatically transposed up or down until it fits in the range. The Key Transpose and the Octave Transpose functions do not work on the data received at MIDI IN.

d. Pedal Switch

Depending on the function currently in use, the MIDI messages sent by the pedal switch differ.

● Pedal Switch

| Function | Messages transmitted with MIDI |
|---------------|--|
| Program Shift | *1 Program Change, *1 System Exclusive |
| Portamento | *1 Portamento |
| Chord Memory | No message |

*1 These messages are turned on or off with MIDI.

e. Program Change Messages

The tone colors of the α JUNO correspond to the Program Change numbers of the MIDI Format 1 to 128 as shown in the table below.

| GROUP | NUMBER BANK | 1 | 2 | 3 | 4 | 5 | 6 | 7 | 8 |
|--------|----------------|--------------------------|-----|-----|-----|-----|-----|-----|-----|
| | | MEMORY & CARTRIDGE | 1 | 1 | 2 | 3 | 4 | 5 | 6 |
| 2 | 9 | | 10 | 11 | 12 | 13 | 14 | 15 | 16 |
| 3 | 17 | | 18 | 19 | 20 | 21 | 22 | 23 | 24 |
| 4 | 25 | | 26 | 27 | 28 | 29 | 30 | 31 | 32 |
| 5 | 33 | | 34 | 35 | 36 | 37 | 38 | 39 | 40 |
| 6 | 41 | | 42 | 43 | 44 | 45 | 46 | 47 | 48 |
| 7 | 49 | | 50 | 51 | 52 | 53 | 54 | 55 | 56 |
| 8 | 57 | | 58 | 59 | 60 | 61 | 62 | 63 | 64 |
| PRESET | 1 | 65 | 66 | 67 | 68 | 69 | 70 | 71 | 72 |
| | 2 | 73 | 74 | 75 | 76 | 77 | 78 | 79 | 80 |
| | 3 | 81 | 82 | 83 | 84 | 85 | 86 | 87 | 88 |
| | 4 | 89 | 90 | 91 | 92 | 93 | 94 | 95 | 96 |
| | 5 | 97 | 98 | 99 | 100 | 101 | 102 | 103 | 104 |
| | 6 | 105 | 106 | 107 | 108 | 109 | 110 | 111 | 112 |
| | 7 | 113 | 114 | 115 | 116 | 117 | 118 | 119 | 120 |
| | 8 | 121 | 122 | 123 | 124 | 125 | 126 | 127 | 128 |

* Number 0 to 127 are used as Program Change Messages in the actual MIDI Format.

* When external MIDI devices such as keyboard recorders are connected to the α JUNO, the α JUNO may not sound properly because of the MIDI loop junction.

In such a case, turn the MIDI Thru Switch on the keyboard recorder off or turn the MIDI Local message off.

Example

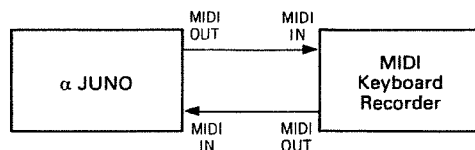

11. Data Transfer

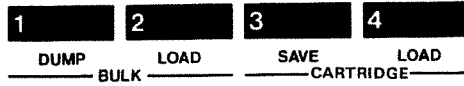

The α JUNO-2 features the Data Transfer function that can save the entire data in the Memory Group (M-11 to M-88) into the optional Cartridge, then later load it back. Also, it is possible to transfer the entire data in an α JUNO-2 to another α JUNO-2 or the α JUNO-1.

Before taking any data transferring operation, be sure to turn the α JUNO-2 to the Play mode, in other words, the Display 16 should be showing a tone number and the tone name.

a. Saving into the Cartridge

<OPERATION>

- ① While holding the Data Transfer Button 4 down, push the 3 (Cartridge Save) button in the Number Selector Button 18.

The Display 16 will change to:

While holding the Data Transfer Button 4 down:

Select Type.....



When the Number Selector Button 3 is pushed:

Push Cart. Button

- ② Set the Protect Switch on the cartridge to the OFF position.

- ③ Push the Cartridge button in the Group Selector Button 17.

The Display 16 will change to:

When the saving starts:

Save Cartridge



When the saving is correctly done:

Save Cart. END

- ④ Return the Protect Switch on the cartridge to the ON position.

b. Loading from the Cartridge to the Memory Group

<OPERATION>

- ① While holding the Data Transfer Button ⑨ down, push the [4] (Cartridge Load) button in the Number Selector Buttons ⑩.

The Display ⑪ will change to:

While holding the Data Transfer Button ⑨ down:

```
Select Type.....
```



When the Number Selector Button [4] is pushed:

```
Push Cart. Button
```

- ② Set the Memory Protect Switch ⑫ to the OFF position.

- ③ Push the Cartridge button in the Group Buttons ⑬.

The Display ⑭ will change to:

When the loading starts:

```
Load Cartridge
```



When the loading is correctly done:

```
Load Cart..END
```

- ④ Return the Memory Protect Switch ⑫ to the ON position.

c. Data Transfer with MIDI

This function is available even when the MIDI Exclusive in the MIDI Functions is turned off.

<OPERATION>

- ① Turn the Memory Protect Switch ④ on the receive α JUNO to the OFF position.
- ② On the receive α JUNO, push the Number Selector Button ② (*1 Bulk Load) while holding the Data Transfer Button ⑨ down.

The Display ⑬ will react as shown below, and the unit is ready to receive data.

CONNECTION

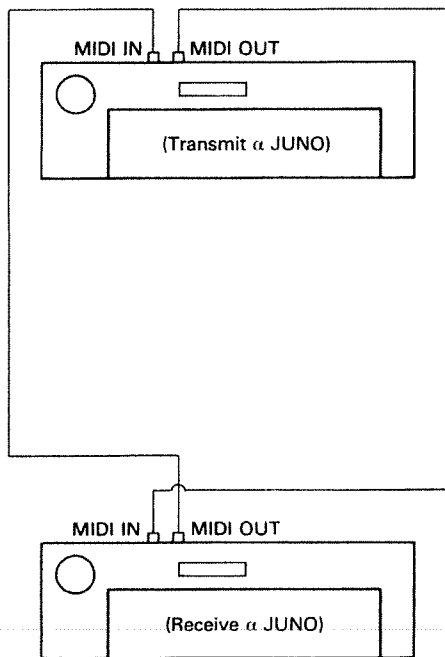

While holding the Data Transfer Button ⑨ down.

Select Type.....



When the Number Selector Button ② is pushed.

Bulk Load MIDI..

- ③ On the transmit α JUNO, push the Number Selector Button ① (*2 Bulk Dump) while holding the Data Transfer Button ⑨ down.

The Display ⑬ will react as shown below, and the unit will begin to transmit data.

While holding the Data Transfer Button ⑨ down.

Select Type.....



When the Number Selector Button ① is pushed.

Bulk Dump MIDI..

- ④ When the data transfer is completed, the Displays ⑩ of the receive and transmit α JUNO's will respond with:

Transmit α JUNO

Bulk Dump ..END.

Receive α JUNO

Bulk Load ..END.

When error indication is shown in the Display as below, check if the connections are made correctly and securely.

Bulk Load ERR !













- ⑤ Return the Memory Protect Switch ⑪ on the receive α JUNO to the ON position.











***1 Bulk Load means loading the entire data in the Memory group (=64 tone colors) from other α JUNO by means of MIDI Exclusive.**

***2 Bulk Dump means transferring the entire data in the Memory group (=64 tone colors) to other α JUNO by means of MIDI Exclusive.**

4 APPENDIX

1. Parameter Table

| Parameter | | Value | |
|-----------|----------------------------|--|--|
| Display ⑩ | | Display ⑩ | |
| DCO RNG | DCO Range | 32° ~ 4° | |
| DCO LFO | DCO LFO Depth | 00 ~ 127 | |
| DCO ENV | DCO ENV Depth | 00 ~ 127 | |
| DCO ENV | DCO ENV Mode |     | Normal Invert Normal with Dynamics Invert with Dynamics |
| DCO AFTR | DCO Aftertouch Sensitivity | 00 ~ 15 | |
| DCO BEND | DCO Bender Range | 00 ~ 12 | |
| PULSE | DCO Pulse Waveform | 00 01 02 03 | OFF    |
| SAWTOOTH | DCO Sawtooth Waveform | 00 01 02 03 04 05 | OFF      |

| Parameter | | Value | |
|-----------|--------------------------------|--|---|
| Display ⑩ | | Display ⑩ | |
| SUB | DCO Sub Oscillator Waveform | 00 |  |
| | | 01 |  |
| | | 02 |  |
| | | 03 |  |
| | | 04 |  |
| | | 05 |  |
| SUB LEVL | DCO Sub Oscillator Level | 00 ~ 03 | |
| NOIS LVL | DCO Noise Level | 00 ~ 03 | |
| PW/PWM | DCO PW/PWM Depth | 00 ~ 127 | |
| PWM RATE | DCO PWM Rate | 00 ~ 127 | |
| HPF FREQ | HPF Cutoff Frequency | 00 ~ 03 | |
| VCF FREQ | VCF Cutoff Frequency | 00 ~ 127 | |
| VCF RESO | VCF Resonance | 00 ~ 127 | |
| VCF ENV | VCF ENV Depth | 00 ~ 127 | |
| VCF ENV | VCF ENV Mode |     | Normal Invert Normal with Dynamics Dynamics |
| VCF LFO | VCF LFO Depth | 00 ~ 127 | |
| VCF KYBD | VCF Keyboard Follower | 00 ~ 15 | |

| Parameter | | Value | |
|-----------|----------------------------|-----------------------|--|
| Display ⑩ | | Display ⑩ | |
| VCF AFTR | Aftertouch Sensitivity | 00 ~ 15 | |
| VCA LEVEL | VCA Level | 00 ~ 127 | |
| VCA ENV | VCA ENV Mode | ↘ GT DT↘ DGT | ENV Gate ENV with Dynamics Gate with Dynamics |
| VCA AFTR | VCA Aftertouch Sensitivity | 00 ~ 15 | |
| CHORUS | Chorus | ON/OFF | |
| CRS RATE | Chorus Rate | 00 ~ 127 | |
| LFO RATE | LFO Rate | 00 ~ 127 | |
| LFO DELY | LFO Delay Time | 00 ~ 127 | |
| ENV T1 | ENV Time 1 | 00 ~ 127 | |
| ENV L1 | ENV Level 1 | 00 ~ 127 | |
| ENV T2 | ENV Time 2 | 00 ~ 127 | |
| ENV L2 | ENV Level 2 | 00 ~ 127 | |
| ENV T3 | ENV Time 3 | 00 ~ 127 | |
| ENV L3 | ENV Level 3 | 00 ~ 127 | |
| ENV T4 | ENV Time 4 | 00 ~ 127 | |
| ENV KYBD | ENV Keyboard Follower | 00 ~ 15 | |

2. Error Message Table

| Display ⑩ | Description |
|------------------|--|
| Memory Protected | You have tried to write into the back-up memory with the Memory Protect Switch ⑦ set to the ON position. |
| Insert Cartridge | You have tried to use the Cartridge Group without connecting the Cartridge. |
| Cart ①Protected | You have tried to write into the cartridge with the protect switch on the cartridge set to the ON position. |
| Bulk Load ERR! | The bulk dump data has not been completely received. |
| Bulk Dump ERR! | The bulk dump data has not been completely transferred. |
| Check Battery!! | The battery for back-up memory is flat. * When this indication is shown, the data in the back-up memory is lost. Consult with your local Roland dealer. |

α JUNO-2 TONE NAME

DATE : _____

TITLE : _____ PROGRAMMER : _____

| Number Bank | 1 | 2 | 3 | 4 | 5 | 6 | 7 | 8 |
|----------------|---|---|---|---|---|---|---|---|
| 1 | | | | | | | | |
| 2 | | | | | | | | |
| 3 | | | | | | | | |
| 4 | | | | | | | | |
| 5 | | | | | | | | |
| 6 | | | | | | | | |
| 7 | | | | | | | | |
| 8 | | | | | | | | |

| No. Bank | 1 | 2 | 3 | 4 | 5 | 6 | 7 | 8 |
|-------------|---|---|---|---|---|---|---|---|
| 1 | | | | | | | | |
| 2 | | | | | | | | |
| 3 | | | | | | | | |
| 4 | | | | | | | | |
| 5 | | | | | | | | |
| 6 | | | | | | | | |
| 7 | | | | | | | | |
| 8 | | | | | | | | |

| No. Bank | 1 | 2 | 3 | 4 | 5 | 6 | 7 | 8 |
|-------------|---|---|---|---|---|---|---|---|
| 1 | | | | | | | | |
| 2 | | | | | | | | |
| 3 | | | | | | | | |
| 4 | | | | | | | | |
| 5 | | | | | | | | |
| 6 | | | | | | | | |
| 7 | | | | | | | | |
| 8 | | | | | | | | |

5 SPECIFICATIONS

α JUNO-2 (JU-2): 6 voice polyphonic and programmable synthesizer

Keyboard : 61 keys, 5 octaves, C scale with Dynamics and Aftertouch

Memory Capacity 64 RAM tone colors
64 ROM tone colors
(64 RAM tone colors when using optional Memory Cartridge)

Panel Switch Section

Group Selector Buttons
Bank Selector Buttons (1 to 8)
Number Selector Buttons (1 to 8)
Tune/Function Button
MIDI Button
Key Transpose Button
Data Transfer Button
Parameter Selector Button
Value Button
Write Button
Tone Modify Mode Buttons (Modulation Rate,
Depth, Brilliance, Envelope Time)

Control Section

α Dial
Volume Knob
Octave Transpose Buttons (Normal, Down)
Portamento Button
Chord Memory Button
Pitch Bender/Modulation Lever

Display Window

16 figures, LCD (with light)

Indicators

Key Transpose Indicator
Octave Transpose Indicators (Normal, Down)
Portamento Indicator
Chord Memory Indicator

Rear Panel

Output Jacks (Mono, Stereo)
Headphones Jack (8 to 150Ω at Stereo)
Hold Pedal Jack
Pedal Switch Jack
Expression Pedal Jack
Memory Protect Switch
MIDI Connectors (IN, OUT, THRU)
Memory Cartridge Holder
Power Switch

Dimensions 972(W) × 246(D) × 85(H) mm
38-1/4"(W) × 9-5/8"(D) × 3-3/8"(H)

Weight 7.5kg/16 lb 9oz

Consumption 12W

Accessories Music Rest
Connection Cable LP-25 (X1)

OPTIONS

Stereo Headphones RH-10
Expression Pedal EV-5
Pedal Switch DP-2, FS-1
Stand KS-6
Carrying Case AB-4
Memory Cartridge M-64C
MIDI/SYNC Cable MSC-07, 15, 25, 50, 100

6-voice polyphonic synthesizer

MODEL JU-2 MIDI Implementation

Date: Jan. 27 1986

Version: 1.1

1. TRANSMITTED DATA

| Status | Second | Third | Description | |
|-----------|-----------|-----------|---|--------|
| 1001 nnnn | 0kkk kkkk | 0vzv vvvv | Note ON kkkkkkk = 12 - 108 vvvvvvv = 10 - 127 | *1 |
| 1001 nnnn | 0kkk kkkk | 0000 0000 | Note OFF kkkkkkk = 12 - 108 | |
| 1011 nnnn | 0000 0001 | 0vzv vvvv | Modulation vvvvvvv = 0 - 127 | *2 |
| 1011 nnnn | 0000 0111 | 0vzv vvvv | Main volume vvvvvvv = 0 - 127 | *2, *5 |
| 1011 nnnn | 0100 0000 | 0111 1111 | Hold ON | *2 |
| 1011 nnnn | 0100 0000 | 0000 0000 | Hold OFF | *2 |
| 1011 nnnn | 0100 0001 | 0111 1111 | Portamento ON | *2 |
| 1011 nnnn | 0100 0001 | 0000 0000 | Portamento OFF | *2 |
| 1100 nnnn | 0ppp pppp | | Program Change ppppppp = 0 - 127 | *2, *3 |
| 1110 nnnn | 0bbb bbbb | 0bbb bbbb | Pitch Bender Change | *2 |
| 1011 nnnn | 0111 1011 | 0000 0000 | ALL NOTES OFF | *4 |
| 1011 nnnn | 0111 1100 | 0000 0000 | OMNI OFF | *4 |
| 1011 nnnn | 0111 1111 | 0000 0000 | POLY ON | *4 |

- Notes:
- *1 While 'CHORD MEMORY' is on, modified notes with CHORD MEMORY are transmitted.
 - *2 Transmitted if the corresponding function switch is ON.
 - *3 0 - 63 : MEMORY GROUP or CARTRIDGE GROUP
64 - 127 : PRESET GROUP
 - *4 When power up or MIDI channel number is set.
 - *5 The value of the Main volume message is controlled only by EXP PEDAL IN.

2. RECOGNIZED RECEIVE DATA

| Status | Second | Third | Description | |
|-----------|-----------|-----------|--|--------|
| 1000 nnnn | 0kkk kkkk | 0vzv vvvv | Note OFF, velocity ignored | |
| 1001 nnnn | 0kkk kkkk | 0000 0000 | Note OFF kkkkkkk = 0 - 127 (12 - 108) | *1 |
| 1001 nnnn | 0kkk kkkk | 0vzv vvvv | Note ON kkkkkkk = 0 - 127 (12 - 108) vvvvvvv = 1 - 127 | *1 |
| 1011 nnnn | 0000 0001 | 0vzv vvvv | Modulation vvvvvvv = 0 - 127 | *2 |
| 1011 nnnn | 0000 0101 | 0vzv vvvv | Portamento Time vvvvvvv = 0 - 127 | *2 |
| 1011 nnnn | 0000 0111 | 0vzv vvvv | Main volume vvvvvvv = 0 - 127 | *2, *6 |
| 1011 nnnn | 0100 0000 | 01xx xxxx | Hold ON | *2 |
| 1011 nnnn | 0100 0000 | 00xx xxxx | Hold OFF | *2 |
| 1011 nnnn | 0100 0001 | 01xx xxxx | Portamento ON | *2 |
| 1011 nnnn | 0100 0001 | 00xx xxxx | Portamento OFF | *2 |
| 1100 nnnn | 0ppp pppp | | Program Change ppppppp = 0 - 127 | *2, *3 |
| 1101 nnnn | 0vzv vvvv | | Channel After Touch vvvvvvv = 0 - 127 | *2 |
| 1110 nnnn | 0bbb xxxx | 0bbb bbbb | Pitch Bender Change | *2 |
| 1011 nnnn | 0111 1010 | 0000 0000 | Local OFF | *4 |
| 1011 nnnn | 0111 1010 | 0111 1111 | Local ON | *4 |
| 1011 nnnn | 0111 1011 | 0000 0000 | ALL NOTES OFF | *5 |
| 1011 nnnn | 0111 1100 | 0000 0000 | OMNI OFF | *5 |
| 1011 nnnn | 0111 1101 | 0000 0000 | OMNI ON | *5 |
| 1011 nnnn | 0111 1110 | 0000 0000 | MONO ON | *5 |
| 1011 nnnn | 0111 1111 | 0000 0000 | POLY ON | *5 |
| 1111 1110 | | | Active Sensing | |

- Notes:
- *1 Note numbers outside the range 12 - 108 are transposed to the nearest octave inside this range.
 - While 'CHORD MEMORY' is on, modified notes with CHORD MEMORY are sounded.
 - *2 Recognized if the corresponding function switch is ON.
 - *3 0 - 63 : MEMORY GROUP or CARTRIDGE GROUP
64 - 127 : PRESET GROUP
 - *4 Ignored during any key on.
 - *5 Mode Messages (123 - 127) are also recognized as ALL NOTES OFF.
- Mode Messages are recognized as follows:
- | | | | |
|----------------|-----------------|-----------------|-----------------|
| | : POLY ON (127) | : MONO ON (126) | : MONO ON (126) |
| | : mmm = 1 | : mmm < 1 | |
| OMNI OFF (124) | : OMNI = OFF | : OMNI = OFF | : OMNI = OFF |
| | : POLY | : MONO ** | : POLY |
| OMNI ON (125) | : OMNI = ON | : OMNI = ON | : OMNI = ON |
| | : POLY | : MONO ** | : POLY |

** 'CHORD MEMORY' on

- *6 The volume of the sound can be controlled by main volume message within level which adjusted by the panel volume knob.

3. TRANSMITTED EXCLUSIVE MESSAGES

*Transmitted if EXCL in the MIDI function is on.

- 3.1 All Tone Parameters with Tone names (APR)
When the Group, Bank or Number is changed.

| Byte | Description |
|-------------|--|
| a 1111 0000 | Exclusive status |
| b 0100 0001 | Roland ID # |
| c 0011 0101 | Operation code = APR (all parameters) |
| d 0000 nnnn | Unit # = MIDI basic channel, nnnn = 0 - 15 where nnnn + 1 = channel # |
| e 0010 0011 | Format type (JU-1, JU-2) |
| f 0010 0000 | Level # = 1 |
| g 0000 0001 | Group # |
| h 0vzv vvvv | Value (0 - 127) |
| : | In sequence (36 bytes total) |
| i 00LL tttt | Tone name (0 - 63) |
| : | In sequence (10 bytes total) |
| j 1111 0111 | End of System Exclusive |

- 3.2 Individual Tone Parameter (IPR)

When the Parameters are changed.

| Byte | Description |
|-------------|--|
| a 1111 0000 | Exclusive status |
| b 0100 0001 | Roland ID # |
| c 0011 0110 | Operation code = IPR (individual parameter) |
| d 0000 nnnn | Unit # = MIDI basic channel, nnnn = 0 - 15 where nnnn + 1 = channel # |
| e 0010 0011 | Format type (JU-1, JU-2) |
| f 0010 0000 | Level # = 1 |
| g 0000 0001 | Group # |
| h 0ppp pppp | Parameter # (0 - 35, 48) |
| i 0vzv vvvv | Value (0 - 127) |
| : | h and i (repetitively) |
| j 1111 0111 | End of System Exclusive |

Notes:

| Parameter # | Function | Value |
|-------------|-----------------------|--|
| 0 | DCO ENV MODE | 0 = ENV normal 1 = ENV inverted 2 = ENV normal with dynamics 3 = ENV inverted with dynamics |
| 1 | VCF ENV MODE | 0 = ENV normal 1 = ENV inverted 2 = ENV normal with dynamics 3 = dynamics |
| 2 | VCA ENV MODE | 0 = ENV 1 = GATE 2 = ENV with dynamics 3 = GATE with dynamics |
| 3 | DCO WAVEFORM PULSE | 0 - 3 |
| 4 | DCO WAVEFORM SAWTOOTH | 0 - 5 |
| 5 | DCO WAVEFORM SUB | 0 - 5 |
| 6 | DCO RANGE | 0 = 4' 1 = 8' 2 = 16' 3 = 32' |
| 7 | DCO SUB LEVEL | 0 - 3 |
| 8 | DCO NOISE LEVEL | 0 - 3 |
| 9 | HPF CUTOFF FREQ | 0 - 3 |
| 10 | CHORUS | 0 = OFF 1 = ON |
| 11 | DCO LFO MOD DEPTH | 0 - 127 |
| 12 | DCO ENV MOD DEPTH | 0 - 127 |
| 13 | DCO AFTER DEPTH | 0 - 127 |
| 14 | DCO PW/PWM DEPTH | 0 - 127 |
| 15 | DCO PWM RATE | 0 = PW manual 1 - 127 = PWM LFO RATE |
| 16 | VCF CUTOFF FREQ | 0 - 127 |
| 17 | VCF RESONANCE | 0 - 127 |
| 18 | VCF LFO MOD DEPTH | 0 - 127 |
| 19 | VCF ENV MOD DEPTH | 0 - 127 |
| 20 | VCF KEY FOLLOW | 0 - 127 |
| 21 | VCF AFTER DEPTH | 0 - 127 |
| 22 | VCA LEVEL | 0 - 127 |
| 23 | VCA AFTER DEPTH | 0 - 127 |
| 24 | LFO RATE | 0 - 127 |
| 25 | LFO DELAY TIME | 0 - 127 |
| 26 | ENV T1 | 0 - 127 (ATTACK TIME) |
| 27 | ENV L1 | 0 - 127 (ATTACK LEVEL) |
| 28 | ENV T2 | 0 - 127 (BREAK TIME) |
| 29 | ENV L2 | 0 - 127 (BREAK LEVEL) |
| 30 | ENV T3 | 0 - 127 (DECAY TIME) |
| 31 | ENV L3 | 0 - 127 (SUSTAIN LEVEL) |
| 32 | ENV T4 | 0 - 127 (RELEASE TIME) |
| 33 | ENV KEY FOLLOW | 0 - 127 |
| 34 | CHORUS RATE | 0 - 127 |
| 35 | RENDER RANGE | 0 - 12 |

6-voice polyphonic synthesizer

MODEL **JU-2** MIDI Implementation Chart

Date : Jan.27 1986
Version : 1.1

| Function..... | | Transmitted | Recognized | Remarks |
|------------------|------------------|---|--|-------------------------------|
| Basic Channel | Default | 1 - 16 | 1 - 16 | memorized |
| | Changed | 1 - 16 | 1 - 16 | |
| Mode | Default | Mode 3 | Mode 1, 3 | memorized |
| | Messages Altered | POLY, OMNI OFF ***** | MONO, POLY, OMNI ON/OFF MONO(m ≠ 1)→Mode 1, 3 | |
| Note Number | True voice | 12 - 108 | 0 - 127 | |
| | | ***** | 12 - 108 | |
| Velocity | Note ON | ○ | ○ v = 1-127 | |
| | Note OFF | × 9n v = 0 | × | |
| After Touch | Key's | × | × | |
| | Ch's | * | * | |
| Pitch Bender | | * | * 0 - 12 semi | 9 bit resolution |
| Control Change | 1 | * Mod. lever | * Mod. depth | Modulation Portamento Time |
| | 4 | × | * | |
| | 5 | * EXP PEDAL in | ** Volume | Hold-1 Portamento Switch |
| | 7 | * Pedal sw. | * Hold | |
| | 64 | * | * | |
| | 65 | * | * | |
| Prog Change | True # | * 0-127 | * 0 - 127 | |
| | | ***** | 0 - 127 | |
| System Exclusive | | * | * | |
| System Common | Song Pos | × | × | |
| | Song Sel | × | × | |
| | Tune | × | × | |
| System Real Time | Clock | × | × | |
| | Commands | × | × | |
| Aux Messages | Local ON/OFF | × | ○ | memorized |
| | All Notes OFF | ○ (123) | ○ (123 - 127) | |
| | Active Sense | × | ○ | |
| | Reset | × | × | |
| Notes | | * Can be set to ○ or × manually, and memorized. ** Volume can adjust the volume of the sound within adjusted level by the panel volume knob. | | |

Mode 1 : OMNI ON POLY
Mode 3 : OMNI OFF POLY

Mode 2 : OMNI ON MONO
Mode 4 : OMNI OFF MONO

○ : Yes
× : No

5. HANDSHAKING COMMUNICATION

5.1 Message type

5.1.1 Want to send a file (WSF)

| Byte | Description |
|-------------|--|
| a 1111 0000 | Exclusive status |
| b 0100 0001 | Roland ID # |
| c 0100 0000 | Operation code = WSF |
| d 0000 nnnn | Unit # = MIDI basic channel, nnnn = 0 - 15 where nnnn + 1 = channel # |
| e 0010 0011 | Format type (JU-1, JU-2) |
| f 1111 0111 | End of System Exclusive |

5.1.2 Request a file (RQF)

| Byte | Description |
|-------------|--|
| a 1111 0000 | Exclusive status |
| b 0100 0001 | Roland ID # |
| c 0100 0001 | Operation code = RQF |
| d 0000 nnnn | Unit # = MIDI basic channel, nnnn = 0 - 15 where nnnn + 1 = channel # |
| e 0010 0011 | Format type (JU-1, JU-2) |
| f 1111 0111 | End of System Exclusive |

5.1.3 Data (DAT)

| Byte | Description |
|-------------|--|
| a 1111 0000 | Exclusive status |
| b 0100 0001 | Roland ID # |
| c 0100 0010 | Operation code = DAT |
| d 0000 nnnn | Unit # = MIDI basic channel, nnnn = 0 - 15 where nnnn + 1 = channel # |
| e 0010 0011 | Format type (JU-1, JU-2) |
| f 0000 tttt | 4 sets of TONE data (256 bytes) |
| g 00ss ssss | Check sum |
| h 1111 0111 | End of System Exclusive |

Notes :

TONE data is sent in four-bit nibbles, right justified, least significant nibble sent first.
See 3.3 Bulk Dump, to understand the TONE data format.
Summed value of the all bytes in data and the check sum must be 0 (7bits).

5.1.4 Acknowledge (ACK)

| Byte | Description |
|-------------|--|
| a 1111 0000 | Exclusive status |
| b 0100 0001 | Roland ID # |
| c 0100 0011 | Operation code = ACK |
| d 0000 nnnn | Unit # = MIDI basic channel, nnnn = 0 - 15 where nnnn + 1 = channel # |
| e 0010 0011 | Format type (JU-1, JU-2) |
| f 1111 0111 | End of System Exclusive |

5.1.5 End of file (EOF)

| Byte | Description |
|-------------|--|
| a 1111 0000 | Exclusive status |
| b 0100 0001 | Roland ID # |
| c 0100 0101 | Operation code = EOF |
| d 0000 nnnn | Unit # = MIDI basic channel, nnnn = 0 - 15 where nnnn + 1 = channel # |
| e 0010 0011 | Format type (JU-1, JU-2) |
| f 1111 0111 | End of System Exclusive |

5.1.6 Communication error (ERR)

| Byte | Description |
|-------------|--|
| a 1111 0000 | Exclusive status |
| b 0100 0001 | Roland ID # |
| c 0100 1110 | Operation code = ERR |
| d 0000 nnnn | Unit # = MIDI basic channel, nnnn = 0 - 15 where nnnn + 1 = channel # |
| e 0010 0011 | Format type (JU-1, JU-2) |
| f 1111 0111 | End of System Exclusive |

5.1.7 Rejection (RJC)

| Byte | Description |
|-------------|--|
| a 1111 0000 | Exclusive status |
| b 0100 0001 | Roland ID # |
| c 0100 1111 | Operation code = RJC |
| d 0000 nnnn | Unit # = MIDI basic channel, nnnn = 0 - 15 where nnnn + 1 = channel # |
| e 0010 0011 | Format type (JU-1, JU-2) |
| f 1111 0111 | End of System Exclusive |

5.2 Sequence of communication

5.2.1 In the 'Dump' mode.

| this unit | message | objective unit |
|-----------|------------------------|----------------|
| ----- | ----- | ----- |
| | WSF -----> | |
| | <----- ACK or (RQF)- | |
| | DAT -----> | |
| | <----- ACK | |
| | : | |
| | : | |
| | DAT -----> | |
| | <----- ACK | |
| | EOF -----> | |
| | <----- ACK | |

5.2.2 In the 'Load' mode.

| this unit | message | objective unit |
|-----------|--------------|----------------|
| ----- | ----- | ----- |
| | RQF-----> | |
| | (<----- WSF | |
| | ACK ----->) | |
| | <----- DAT | |
| | ACK -----> | |
| | : | |
| | : | |
| | <----- DAT | |
| | ACK -----> | |
| | : | |
| | : | |
| | <----- EOF | |
| | ACK -----> | |

Notes :

- * This unit sends RJC and the sequence is discontinued when it receives ERR or detects some error.
- * This unit sends RJC when the sequence is discontinued manually.
- * This unit stops the sequence if the unit receives RJC.

36 - 45
TONE NAME

| | | | |
|------|------|------|----------|
| 0=A | 16=Q | 32=g | 48=w |
| 1=B | 17=R | 33=h | 49=x |
| 2=C | 18=S | 34=i | 50=y |
| 3=D | 19=T | 35=j | 51=z |
| 4=E | 20=U | 36=k | 52=0 |
| 5=F | 21=V | 37=l | 53=1 |
| 6=G | 22=W | 38=m | 54=2 |
| 7=H | 23=X | 39=n | 55=3 |
| 8=I | 24=Y | 40=o | 56=4 |
| 9=J | 25=Z | 41=p | 57=5 |
| 10=K | 26=a | 42=q | 58=6 |
| 11=L | 27=b | 43=r | 59=7 |
| 12=M | 28=c | 44=s | 60=8 |
| 13=N | 29=d | 45=t | 61=9 |
| 14=O | 30=e | 46=u | 62=space |
| 15=P | 31=f | 47=v | 63=- |

46,47 reserved
48 TONE MODIFY (ignored if received)

| |
|-----------------------------|
| 0 = ENV TIME (increment) |
| 1 = BRILLIANCE (increment) |
| 2 = MOD DEPTH (increment) |
| 3 = MOD RATE (increment) |
| 16 = ENV TIME (decrement) |
| 17 = BRILLIANCE (decrement) |
| 18 = MOD DEPTH (decrement) |
| 19 = MOD RATE (decrement) |

Switch bit

| | | |
|-------------------------|--------------|----------------------------|
| b00 | CHORUS | 0 = OFF 1 = ON |
| b01 b02 | DCO ENV MODE | ENV normal |
| 0 0 | | ENV inverted |
| 1 0 | | ENV normal with dynamics |
| 1 1 | | ENV inverted with dynamics |
| b03 b04 | VCF ENV MODE | ENV normal |
| 0 0 | | ENV inverted |
| 1 0 | | ENV normal with dynamics |
| 1 1 | | dynamics |
| b05 b06 | VCA ENV MODE | ENV |
| 0 0 | | GATE |
| 0 1 | | ENV with dynamics |
| 1 0 | | GATE with dynamics |
| 1 1 | | |
| b07 b08 b09 | DCO WAVEFORM | 0 |
| 0 0 0 | SUB | 1 |
| 0 0 1 | | 2 |
| 0 1 0 | | 3 |
| 0 1 1 | | 4 |
| 1 0 0 | | 5 |
| 1 0 1 | | |
| b10 b11 b12 | DCO WAVEFORM | 0 |
| 0 0 0 | SAWTOOTH | 1 |
| 0 1 0 | | 2 |
| 0 1 1 | | 3 |
| 1 0 0 | | 4 |
| 1 0 1 | | 5 |
| b13 b14 | DCO WAVEFORM | 0 |
| 0 0 | PULSE | 1 |
| 1 0 | | 2 |
| 1 1 | | 3 |
| b15 b16 | HPF CUTOFF | 0 |
| 0 0 | FREQ | 1 |
| 0 1 | | 2 |
| 1 0 | | 3 |
| 1 1 | | |
| b17 b18 | DCO RANGE | 4' |
| 0 0 | | 8' |
| 0 1 | | 16' |
| 1 0 | | 32' |
| 1 1 | | |
| b19 b20 | DCO SUB | 0 |
| 0 0 | LEVEL | 1 |
| 0 1 | | 2 |
| 1 0 | | 3 |
| 1 1 | | |
| b21 b22 | DCO NOISE | 0 |
| 0 0 | LEVEL | 1 |
| 0 1 | | 2 |
| 1 0 | | 3 |
| 1 1 | | |
| c7 c6 c5 c4 c3 c2 c1 c0 | CHORUS RATE | vvvvvvv = 0 - 127 |

3.3 Bulk Dump (BLD)

Bulk Dump has no relation with the EXCL in the MIDI function. When the 'DATA TRANSFER Button', 'WRITE Button' and 'BULK DUMP Button' are pressed.

| Byte | Description |
|-------------|---|
| a 1111 0000 | Exclusive status |
| b 0100 0001 | Roland ID # |
| c 0011 0111 | Operation code = BLD (bulk dump) |
| d 0000 nnnn | Unit # = MIDI basic channel, nnnn = 0 - 15 where nnnn + 1 = channel # |
| e 0010 0011 | Format type (JU-1, JU-2) |
| f 0010 0000 | Level # = 1 |
| g 0000 0001 | Group # |
| h 0000 0000 | Extension of program # |
| i 00pp pppp | Program # (pppppp = n#4 : n = 0 - 15) |
| j 0000 tttt | 4 sets of TONE data (256 bytes) |
| k 1111 0111 | End of System Exclusive |

Notes:
The Program # (i) represents the first TONE number of the TONE data sets (j).
The 4 sets of TONE data are sequentially transmitted. TONE data is sent in four-bit nibbles, right justified, least significant nibble sent first.
Each TONE data consists of 32 bytes.
The Bulk Dump message repeats 16 times.

*TONE data format

| byte | msb | 7 | 6 | 5 | 4 | 3 | 2 | 1 | lmb |
|------|-----------------|---|---|---|---|---|---|---|-----|
| 0 | DCO AFTER DEPTH | : | : | : | : | : | : | : | : |
| 1 | VCF AFTER DEPTH | : | : | : | : | : | : | : | : |
| 2 | ENV KEY FOLLOW | : | : | : | : | : | : | : | : |
| 3 | *** | : | : | : | : | : | : | : | : |
| 4 | b00 | : | : | : | : | : | : | : | : |
| 5 | b01 | : | : | : | : | : | : | : | : |
| 6 | b02 | : | : | : | : | : | : | : | : |
| 7 | b03 | : | : | : | : | : | : | : | : |
| 8 | b04 | : | : | : | : | : | : | : | : |
| 9 | b05 | : | : | : | : | : | : | : | : |
| 10 | b06 | : | : | : | : | : | : | : | : |
| 11 | b07 | : | : | : | : | : | : | : | : |
| 12 | b08 | : | : | : | : | : | : | : | : |
| 13 | b09 | : | : | : | : | : | : | : | : |
| 14 | b10 | : | : | : | : | : | : | : | : |
| 15 | b11 | : | : | : | : | : | : | : | : |
| 16 | b12 | : | : | : | : | : | : | : | : |
| 17 | b13 | : | : | : | : | : | : | : | : |
| 18 | b14 | : | : | : | : | : | : | : | : |
| 19 | b15 | : | : | : | : | : | : | : | : |
| 20 | b16 | : | : | : | : | : | : | : | : |
| 21 | b17 | : | : | : | : | : | : | : | : |
| 22 | b18 | : | : | : | : | : | : | : | : |
| 23 | b19 | : | : | : | : | : | : | : | : |
| 24 | b20 | : | : | : | : | : | : | : | : |
| 25 | b21 | : | : | : | : | : | : | : | : |
| 26 | b22 | : | : | : | : | : | : | : | : |
| 27 | c 1 | : | : | : | : | : | : | : | : |
| 28 | c 3 | : | : | : | : | : | : | : | : |
| 29 | c 5 | : | : | : | : | : | : | : | : |
| 30 | c 7 | : | : | : | : | : | : | : | : |
| 31 | : | : | : | : | : | : | : | : | : |

*** : 0, ignored if received

4. RECOGNIZED EXCLUSIVE MESSAGES

*Received if EXCL in the MIDI function is on.

4.1 All Tone Parameters without Tone names (APR)

| Byte | Description |
|-------------|---|
| a 1111 0000 | Exclusive status |
| b 0100 0001 | Roland ID # |
| c 0011 0101 | Operation code = APR (all parameters) |
| d 0000 nnnn | Unit # = MIDI basic channel, nnnn = 0 - 15 where nnnn + 1 = channel # |
| e 0010 0011 | Format type (JU-1, JU-2) |
| f 0010 0000 | Level # = 1 |
| g 0000 0001 | Group # |
| h 0vvv vvvv | Value (0 - 127) |
| i 1111 0111 | In sequence (36 bytes total) |
| k 1111 0111 | End of System Exclusive |

4.2 Bulk Dump (BLD)

Bulk Dump has no relation with the EXCL in the MIDI function. When the 'DATA TRANSFER Button', 'WRITE Button' and 'BULK LOAD Button' are pressed.

| Byte | Description |
|-------------|---|
| a 1111 0000 | Exclusive status |
| b 0100 0001 | Roland ID # |
| c 0011 0111 | Operation code = BLD (bulk dump) |
| d 0000 nnnn | Unit # = MIDI basic channel, nnnn = 0 - 15 where nnnn + 1 = channel # |
| e 0010 0011 | Format type (JU-1, JU-2) |
| f 0010 0000 | Level # = 1 |
| g 0000 0001 | Group # |
| h 0000 0000 | Extension of program # |
| i 00pp pppp | Program # |
| j 0000 tttt | Some sets of TONE data |
| k 1111 0111 | End of System Exclusive |

Notes:

The Program # is recognized as the first TONE number of the TONE data sets.
32 bytes are recognized as a set of TONE data. TONE data is received in four-bit nibbles, right justified, least significant nibble received first.
See 3.3 Bulk Dump, to understand the TONE data format.

4.3 Other Exclusive messages are described in section 3.



SOUND CHART

Memory Group

| No. Bank | 1 | 2 | 3 | 4 | 5 | 6 | 7 | 8 |
|-------------|---------------|------------------|-------------------|--------------|--------------|---------------|-----------------|--------------|
| 1 | Brass 3 | Brass 4 | Fat Brass 2 | Trumpets | Horns | Brass Section | Synth Brass 2 | Reso Sweep |
| 2 | JUNO String 3 | JUNO String 4 | Synth Orchestra 2 | Tekno String | Fiddle | Double Basses | Pad | Surprise |
| 3 | Piano 4 | Electric Piano 2 | Electric Piano 3 | Piano-FX | Clavichord | Harpichord 2 | Acoustic Guitar | Bass Piano |
| 4 | Organ 3 | Organ 4 | Overdriven Organ | Click Organ | Pipe Organ 3 | Voice Pad | Voices 2 | Harmonica |
| 5 | Synth Koto | Vibe | Bells 2 | Bells 3 | Mallet | Poly Pulse | Echo Harp | Fairy Steps |
| 6 | Lead 4 | Lead 5 | Inv-Solo | Clarinet | Bassoon | Synth Bass 2 | Synth Bass 3 | Upright Bass |
| 7 | Machines | Pole Position | Vidiots | Jet Chord | ooops | Take-Off | U F O | Oct Jump |
| 8 | Jet | Helicopter | Dogs Bark | WET | ooohSCARY | What the | Synth Toms | Kick |



SOUND CHART

Preset Group



| No. Bank | 1 | 2 | 3 | 4 | 5 | 6 | 7 | 8 |
|-------------|---------------|---------------|-----------------|----------------|------------------|--------------|-----------------|---------------|
| 1 | Brass 1 | Brass 2 | PWM Brass | Spit Valve | Synth Brass | Brass Swell | Brass Horns | Fat Brass 1 |
| 2 | JUNO String 1 | JUNO String 2 | Synth Orchestra | Fast String | Orchestra | Cello | Solo Violin | Pizzicato |
| 3 | Piano 1 | Piano 2 | Piano 3 | Loud-Piano | Electric Piano 1 | Clavi | Harpichord | Chorus Guitar |
| 4 | Organ 1 | Organ 2 | Cheesy Organ | Chowa Organ | Pipe Organ 1 | Pipe Organ 2 | Accordion | Vocoder |
| 5 | Poly Synth 1 | Fat Synth | Synth Sweep | String Sweep | Cosmo Sweep | Velo-Reso | Voices | Sinusoidal |
| 6 | Lead 1 | Lead 2 | Lead 3 | Flute | Oboe | Sax | Electric Bass 1 | Synth Bass 1 |
| 7 | Chorus Pluck | Bells 1 | Bell-Chime | Xylophone | Marimba | Koto | Steel Drum Band | Harp |
| 8 | Ominous | Noise Shots | Twilite Zone | Echo Explosion | Whistle | Arpeggiator | Electro Drums | Timps |

Roland®

10498

UPC

10498



10981

Roland