

ROLAND

Piano Plus 300
Piano Plus 400

Owner's Manual



PianoPlus 300

PianoPlus 400

- Dynamic, yet realistic expressions are available owing to its velocity sensitivity function.
 - Depending how you attack the keyboard, both tone color (harmonic contents) and volume change, therefore realistic sounds can be obtained.
 - The sounds obtained in this keyboard are articulate, and even the lower tones sound deep and lingering.
- The HP-300 and HP-400 are electronic pianos which offer you excellent performance abilities.
 - The waveforms are generated by its built-in computer for each tone color and pitch separately, so each tone color sounds extremely realistic.
 - The HP-300 and HP-400 both are provided with the MIDI IN and OUT jacks to which you can connect the external device that also includes the MIDI.
 - This compact and light weighted electronic piano can be comfortably moved where you like.

Important Notes

Location

- Operating the HP-300/400 near a neon or fluorescent lamp may cause noise interference. If so, change the angle of the HP-300/400.
- Avoid using the HP-300/400 in excessive heat or humidity or where it may be affected by direct sunlight or dust.

Power Supply

- The appropriate power supply for this instrument is shown on its name plate. Please be sure that the voltage system in your country meets this.
- This instrument might generate heat while operating, but there is no need to worry about it.

Cleaning

- Use a soft cloth and neutral detergent for cleaning.
- Do not use solvents such as paint thinner.

*This owner's manual can be referred to for both the HP-300 and HP-400. The HP-400's front panel is shown here, but all the names and functions apply to the HP-300 as well.

Names and Functions

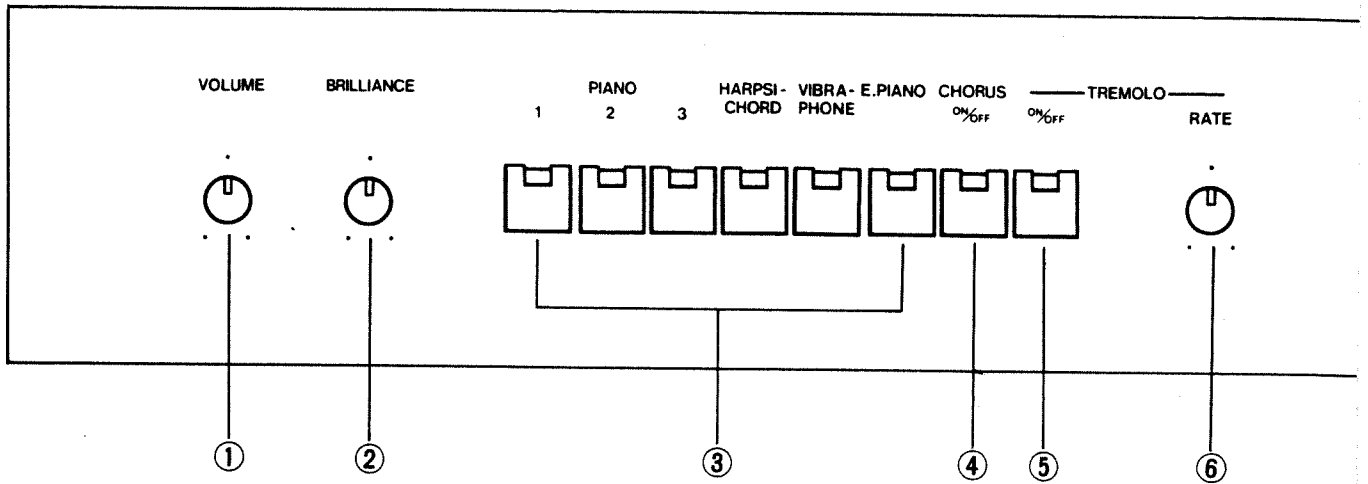

Front Panel

① VOLUME

② BRILLIANCE

As you rotate this knob clockwise (↻), the tone color will be brighter, and counter-clockwise (↺) mellower. Normally this is set to the center.

③ Tone Selectors

By pressing one of these buttons, you can select a tone color you like. Just select one tone color at a time.

PIANO 1 ~ 3
HARPSICHORD
VIBRAPHONE
ELECTRIC PIANO

④ CHORUS

Turn this button on (the indicator lights up), then expansive chorus sounds will be obtained.

⑤ TREMOLO (HP-400 only)

Press this button (the indicator lights up), and a tremolo effect is obtained.

⑥ TREMOLO RATE (HP-400 only)

This knob is to adjust the rate of the tremolo effect. Rotating this clockwise (↻) quicken the rate.

⑦ POWER switch

⑧ Phones jack

Standard stereo headphones can be connected. The sound from the built-in speaker stops automatically on connecting the headphones. Please adjust the volume with the VOLUME knob.

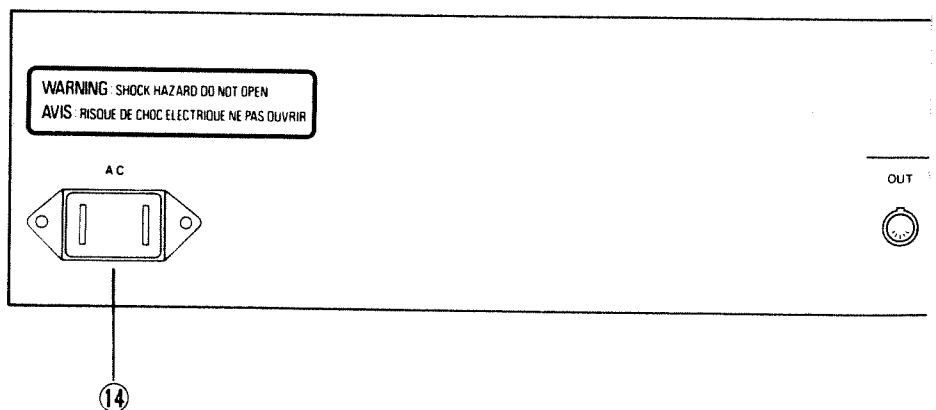
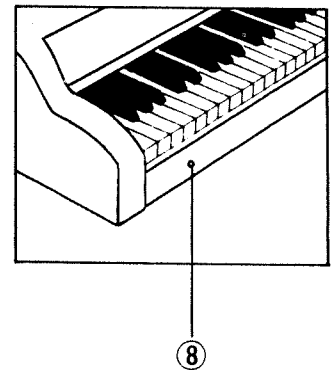

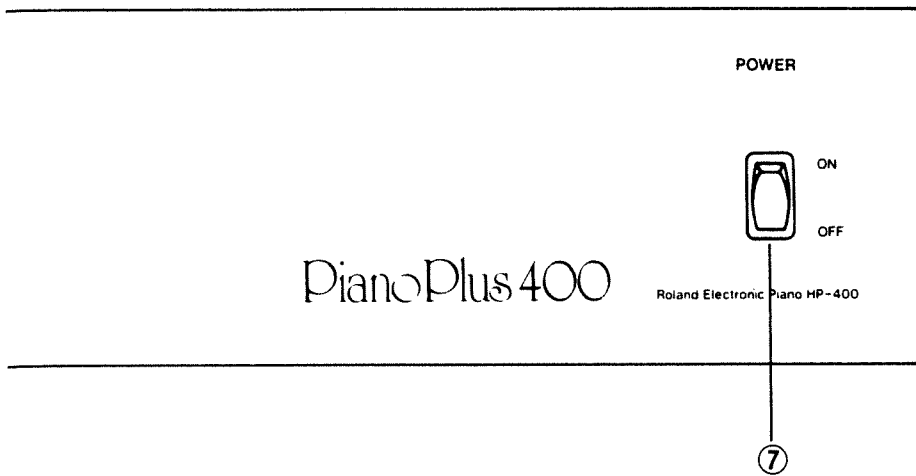

Rear Panel

⑨ MIDI (Musical Instrument Digital Interface)

MIDI is an international standard of the electronic musical instruments. By connecting the devices featuring MIDI Buses, their information can be communicated by means of digital signal.

● The information that can be communicated through the HP-300/400's MIDI Bus are as follows.

- 1) Keyboard
- 2) Dynamics (Velocity Sensitivity)
- 3) Damper(Hold) Pedal
- 4) Soft Pedal

* The MIDI Channel Number of the HP-300/400 is 1.

* If the MIDI device connected to the HP-300/400 does not include above function(s), the relevant information cannot be communicated.

* When a MIDI device is connected to the HP-300/400, you will hear no sound from the HP-300/400, unless both units are turned on.

** Regarding Setup, Operation, etc., refer to the owner's manual of each individual unit.

⑩ TUNE

This is used to tune the HP-300/400 to other musical instrument. At its center position, A=442Hz.

* The HP-300/400 itself never gets out of tune, therefore tuning is not necessary.

⑪ EXT. INPUT jack

To this jack, you can connect a Rhythm Machine such as the CR-8000, CR-5000, Bass Line TB-303, etc. and enjoy playing to the rhythm.

* Select H, M or L position depending on the input level. (Set this switch to L if the input level is low and H if high.)

⑫ PEDAL jack (DAMPER, SOFT)

This jack is used to connect the optional Pedal switch DP-6, DP-2 or the one that belongs to the KS-300/400. These will function just like a damper pedal or a soft pedal of a usual piano.

⑬ OUTPUT jack (MONO, STEREO)

⑭ AC Socket

* Make sure that the HP-300/400 is turned off, then connect the power cable to this AC socket.

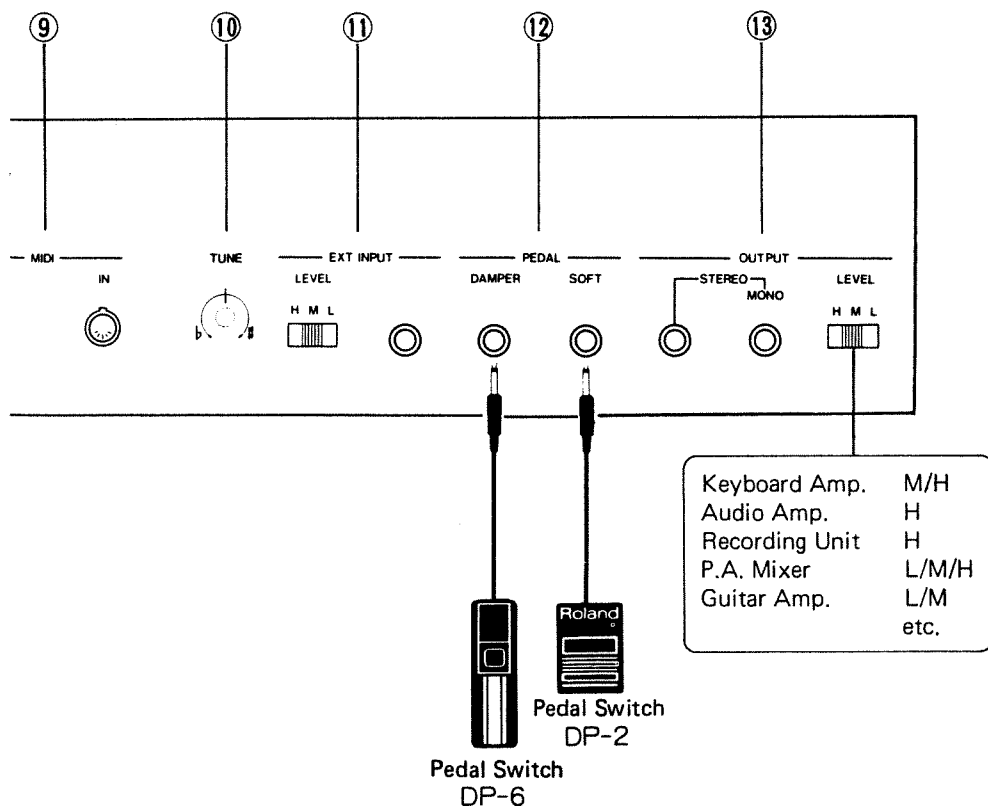

■ Sound Range Diagram

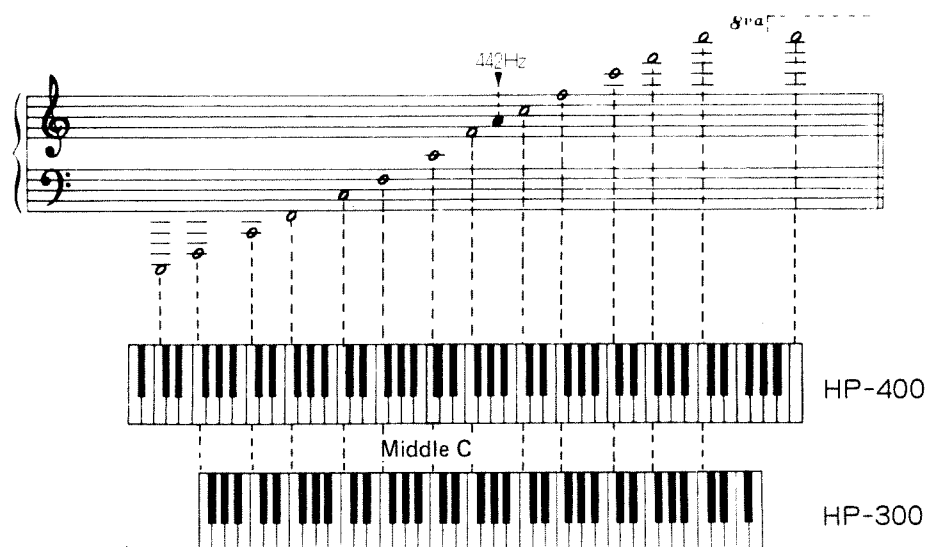

■ Specifications

	HP-300	HP-400
Keyboard	75 keys, 8 voice polyphonic	88 keys, 12 voice polyphonic
Tone Selector buttons	PIANO 1, PIANO 2, PIANO 3, HARPSICHORD, ELECTRIC PIANO	PIANO 1, PIANO 2, PIANO 3, HARPSICHORD, ELECTRIC PIANO
Effect	CHORUS ON/OFF	CHORUS ON/OFF, TREMOLO ON/OFF, TREMOLO RATE
Performance Control	VOLUME, BRILLIANCE, TUNE (± 35 cent)	VOLUME, BRILLIANCE, TUNE (± 35 cent)
Jacks	OUTPUT (MONO, STEREO), EXT. INPUT, Phones jack, DAMPER PEDAL, SOFT PEDAL, MIDI IN (DIN socket), MIDI OUT (DIN socket)	OUTPUT (MONO, STEREO), EXT. INPUT, Phones jack, DAMPER PEDAL, SOFT PEDAL, MIDI IN (DIN socket), MIDI OUT (DIN socket)
Selector switches	Output Level Selector switch, Input Level Selector switch	Output Level Selector switch, Input Level Selector switch
Speakers	18 cm x 10 cm 2	18 cm x 10 cm 2
Output Power	5W x 2	5W x 2
Consumption	40W (100V, 117V) 50W (220V, 240V)	45W (100V, 117V) 55W (220V, 240V)
Dimensions	1106(W) x 440(D) x 189(H) mm 43-9/16(W) x 7-5/16(D) x 7-7/16(H) in.	1293(W) x 440(D) x 189(H) mm 50-15/16(W) x 17-5/16(D) x 7-7/16 (H) in.
Weight	21.5 kg (47 lb. 6 oz.)	23.5 kg (51 lb. 13 oz.)
Accessories	Score Stand, Power Cord	Score Stand, Power Cord

* Specifications are subject to change without notice.

■ Options

- Headphones RH-10



- Pedal switch DP-6

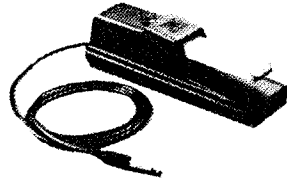

- Stand (inc. Damper Pedal, Soft Pedal)
KS-300
KS-400

- Cover

Roland®

10161

UPC

10161



10001

Roland®