

Owner's Manual



Roland®

Options

PM-01

Personal Drum Monitor



The perfect home amplifier for the HD-1 V-Drums Lite.

DAP-1

V-Drums Accessory Package



Essential Accessories for V-Drummers

- Drum Throne
- Drum Sticks
- Inner Earphones
- Stereo Mini-Cable

TDM-1

V-Drums Mat



Secure-Performance Mat for HD-1

**Drumming is for everybody and the Roland HD-1 V-Drums Lite
is the best way to add rhythm and music to your life!**

The Roland HD-1 V-Drums Lite is for anyone who wants to enjoy playing drums.
It is portable, durable and loaded with professional sounds.

It is perfect for home, office, project studio or live performance,
everywhere you want to play.

Whether you are just starting out or have experience playing the drums,
the HD-1 is a great way to have fun playing and get involved in music.

Contents

Before using this unit, carefully read the sections entitled: "USING THE UNIT SAFELY" and "IMPORTANT NOTES" (Set-up Guide). These sections provide important information concerning the proper operation of the unit. Additionally, in order to feel assured that you have gained a good grasp of every feature provided by your new unit, Owner's manual should be read in its entirety. The manual should be saved and kept on hand as a convenient reference.

Options..... 2

Introduction 3

Features..... 5

- Drum Set Elements 6
- Panel and Parts Descriptions 8

Getting Ready to Perform 10

- Getting Connected 10
- Turning On the Power 11
- Adjusting the Head Tension on the Snare 12

Playing the Kit 13

- Holding the Sticks 13
- Selecting a Kit 14
- Listening to Patterns 14
- Pad Sensitivity 15
- Metronome Operations 16

Replacing a Pad 17

- Replacing the Snare Head 17
- Detaching/Mounting a Tom Pad 18
 - Detaching a Tom Pad 18
 - Mounting a Tom Pad 18

Troubleshooting 19

Drum Kit Sound List..... 20

About MIDI 21

Conversion for Left-Handed use 22

Specifications 23

Notation 24

Copyright © 2007 ROLAND CORPORATION

All rights reserved. No part of this publication may be reproduced in any form without the written permission of ROLAND CORPORATION.

Features

Sounds

70 high quality Drum, Percussion and special effects sounds are ready to play with the 10 different drum kits.

It's Quiet!

Specially developed kick and hi-hat pedals are mounted on the support pipes, minimizing direct vibration to the floor.

Lightweight and Compact

The HD-1 requires very little space, and by simply folding in the pad support pipes, it can be transported easily.

Simple to Use

Easy operation with just 2 knobs and 7 buttons.

Built-in Metronome

The built-in metronome is a valuable practice tool.

Play with External Audio Sources

The Mix in jack allows one to connect external audio sources, ideal for playing along with CDs, MP3 players, etc.

Outputs

2 pairs of headphones can be used by plugging them into the headphone and output jacks at the same time.



For details on drum kits, refer to “About the Drum Kits” (p. 15).

Drum Set Elements

Here are some basic terms related to drum sets.

Acoustic Drum



Kick (Bass Drum)

Played with a kick pedal, it's the largest drum in the kit.

Snare Drum

The snare drum is the main "voice" of a drum kit.

Hi-Hat

An acoustic hi-hat uses 2 cymbals mounted on a hi-hat stand.

* *The HD-1 uses a single pad.*

Hi-Hat Pedal

Pressing the hi-hat pedal opens and closes it.

Tom Toms

These are usually mounted on the bass drum, or separate stands.

Floor Tom (Tom 3)

Sometimes called a bass tom, it either stands on its own legs or is mounted on a stand.

Ride Cymbal

Usually mounted on the right side of the kit, the ride cymbal is principle elements in keeping time.

Crash Cymbal

Smaller than the ride, the crash cymbal is mainly used for accents.

* *The indications in parentheses () show the names used on the HD-1.*

HD-1

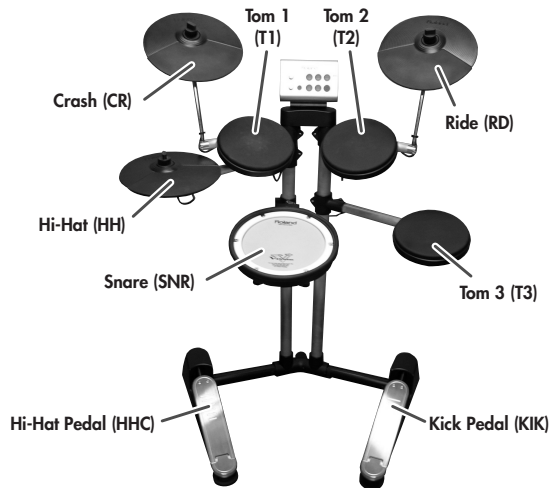

Letters and numbers in parentheses () relate to the cable labeling.

Panel and Parts Descriptions

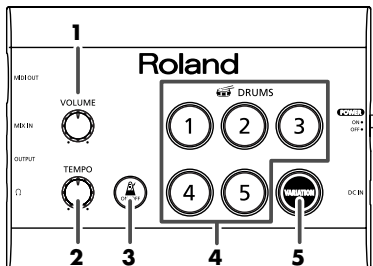

1. [VOLUME] Knob

Adjusts the sound level (p. 11).

2. [TEMPO] Knob

For setting the speed of the metronome or patterns (p. 15, p. 16).

3. [MIDI IN] Button

For starting and stopping the metronome (p. 16).

4. [1] [5] Buttons

For selecting drum kits (p. 14).

5. [MIDI OUT] Button

For selecting a kit variation (p. 14).

Left Side

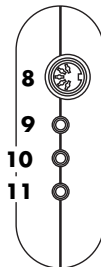

Right Side

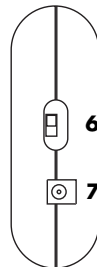

6. POWER Switch

Turns the power on or off (p. 11).

7. AC Adaptor Jack

For connecting the power supply (p. 10).

8. MIDI OUT Connector

Use when playing sounds on an external sound module or for recording to a sequencer.

9. MIX IN Jack

For connecting an external audio source (CD or MP3 player). Sound input here will also be heard through the main and headphone outputs. The balance between those sounds and the HD-1 is determined by the level of the external audio player.

10. OUTPUT Jack

For connecting an optional amplifier (PM-01) or headphones.

11. Headphone Jack

For connecting headphones (when headphones are connected, the OUTPUT jack will still be active).

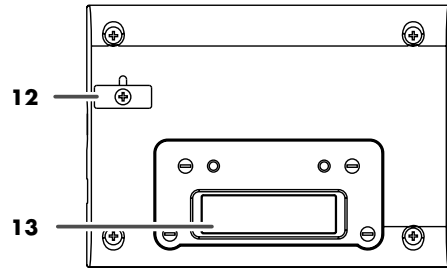

12. Cord Hook

For securing the power adaptor cord. This helps prevent accidental power outage and relieves undue stress to the AC adaptor jack.

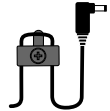

13. Trigger Cable Connector

This connects the pads to the sound module.

Getting Ready to Perform

For details on assembling the stand, refer to the separate leaflet "Set-Up Guide."

Getting Connected

NOTE

As a security measure to prevent damage to speakers or other devices, be sure the power is off on the HD-1 before making any connections.

Personal audio player etc.
(when you want to play the HD-1 along with music)

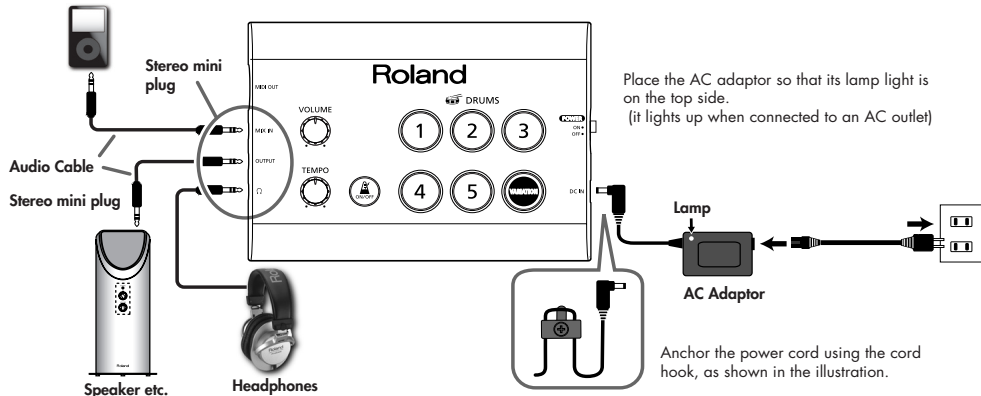

MEMO

2 headphones can be used by using the OUTPUT jack and the headphone jack at the same time. Perfect for drum lessons!

Turning On the Power

NOTE

Once connections have been made (p. 10), turn on the power to all connected devices in the order as specified below. Doing otherwise raises the risk of damage or malfunction to the connected devices.

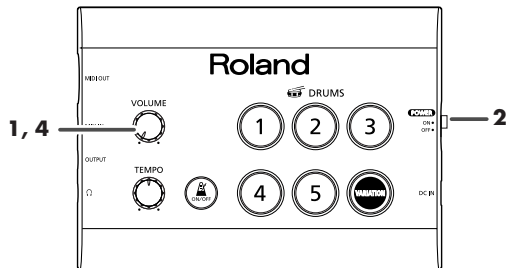

1. Make sure that the HD-1s [VOLUME] knob, and that of any connected amp, is set to the minimum level.
2. Turn on the HD-1.
3. Turn on the power of the connected amp/speaker.
4. Then raise the volume of both to get the sound level required.

* As there is a built-in protection circuit, it takes a few seconds before the HD-1 is ready to play.

If You Don't Hear Sound

Please check the following points.

If using an amp/audio system

- Power is on?
- Volume setting is correct?
- All input/output connections are correct?
- Faulty cable?

If using headphones

- Correctly connected to the headphones or OUTPUT jack?

Adjusting the Head Tension on the Snare

Before playing the snare pad, you must tighten the head. If it is too loose, problems such as faulty triggering may occur.

- 1. Use the included drum key, and tighten each tuning bolt slightly, in the order shown in the diagram. This guarantees even tension and a correct head response.**

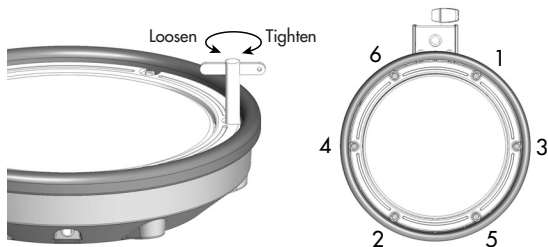

- 2. While hitting the pad, make final adjustments to have the best feel and response from the head.**

MEMO

- Adjusting the tension of the snare head will not change the sound as it would on an acoustic drum.
- Head tuning should be checked on a regular basis, as constant playing may slacken the tension.
- Synthetic rubber is used on the pads and cymbals. Should the smell of rubber bother you, make sure there is good air circulation in the room. NEVER place the HD-1 near a heater or source of high temperature.

The drum key can be conveniently mounted on the hook of the arm pipe.



Playing the Kit

Holding the Sticks

The most common way to hold the sticks is called the “matched grip” as shown in the photos below.

(Left hand)



(Right hand)



Playing the Cymbal Pads

Play **ONLY** on the rubber surface. Playing on the plastic part will produce sound, but you can damage the pad.

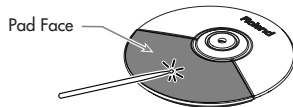

Selecting a Kit

A drum kit consists of sounds assigned to each pad. In some cases, the sound will change depending upon your playing dynamics.

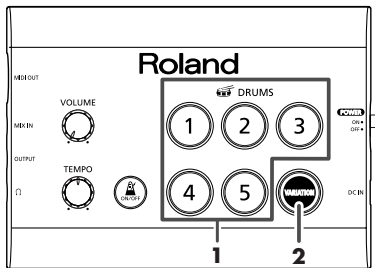

1. Buttons from [1] through [5]

Pressing these buttons will call up different kits.

2. Variation []

When you press this button, you can access the variation kits.

Example:

Play the kit [1] (Accoustic).

Press [] and you play the variation kit (Jazz).

Listening to Patterns

NOTE

Before playing back a pattern, lower the volume of the HD-1. The volume of these patterns may be louder than when you play the kit normally, and you do not want to risk damage to your ears or connected equipment.

Also, when patterns are playing, hitting the pads will not produce sound.

1. Press and hold one of the [1]-[5] buttons for a few seconds.

A pattern using this current kit will play.

If you press the [] button, the pattern for that variation kit will play.

You can change the tempo of the pattern by adjusting the [TEMPO] knob.

MEMO

Each pattern will play at it's default tempo (set at the factory).

To change the tempo of the pattern, adjust the TEMPO knob AFTER playback has started.

2. Playback will stop if you press any one of the kit buttons during playback.

About the Drum Kits

Here is an explanation about the sounds used in each kit.

Button	Normal Kit	Variation Kit
1	Acoustic This is a basic acoustic type of drum set.	Jazz Jazz kit featuring a sizzle ride cymbal.
2	Power A rock kit featuring a deep reverb sound, similar to a large concert hall.	Double Bass A rock kit where the hi-hat pedal becomes a 2nd bass drum.
3	Drums & Percussion Features a combination of drum and percussion sounds.	World Features world percussion sounds.
4	Electronic Features sounds from a Roland TR-808.	Dance Perfect for club, house and dance music.
5	Voices Features voices, human beat box and chorus sounds.	Droid This is a kit featuring special effects sounds.





More details about the individual sounds in each kit can be found in the “**Drum Kit Sound List**” (p. 20).

Pad Sensitivity

The HD-1 can be adjusted to accommodate any dynamic level of playing, allowing even children with a very light touch, to get a good response from the drum kit.

To adjust the pad/pedals sensitivity do the following:

Note: This is a “global” function, meaning the sensitivity of all pads with change together.

1. Hold down [] for a few seconds until the button starts to blink.
2. Keep pressing the [] button, and then press a button from [] to [] to change the sensitivity.
(the factory setting is 3)

Button	Sensitivity
5	Loud volume can produced playing very lightly
4	Loud volume can produced playing lightly
3	Normal (factory setting)
2	Loud volume requires fairly strong playing
1	Loud volume requires VERY strong playing

3. When you've finished making the setting, release [].

Metronome Operations

The HD-1's built-in metronome is a valuable practice aid.

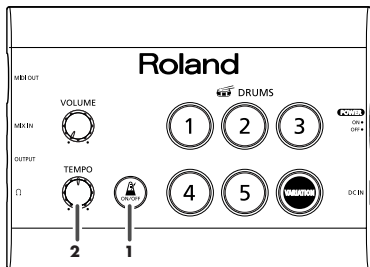

1. Press [].

[] lights up and the metronome starts.

2. Turn the [TEMPO] knob to adjust the tempo.
(Range: 40–220 BPM)

Adjusting the Metronome Volume

1. While the metronome is playing, press and continue to hold down the [] button.
2. While pressing [], touch a button from [1] through [3] to adjust the volume. Three levels are provided, “soft -medium-loud.”
3. When satisfied, release [].

Changing the Metronome Sound

1. While the metronome is playing, press and continue to hold down the [] button.
2. While pressing [], touch [4], [5] or the [] button to choose the desired sound.

The choices are:

- 4: Click
- 5: Cowbell
- 6: Maraca

3. When satisfied, release [].

MEMO

The above settings are memorised by the HD-1, even if the power is turned off.

Replacing a Pad

Replacing the Snare Head

If it's necessary to replace the head on the snare, follow these instructions:

Optional replacement head: MH-8 Mesh Head

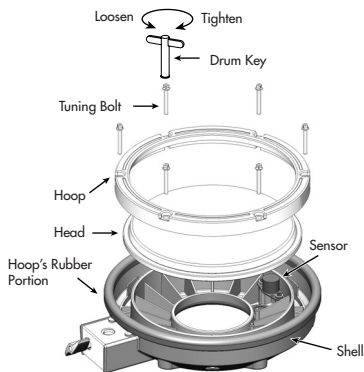

NOTE

The sensor and cushion under the head are very sensitive. Put no pressure on these parts as it may disrupt the proper functioning of the pad.

1. Remove all the tuning bolts.
2. Remove the hoop.
3. Take off the old head.
4. Place the new head on the shell.
5. Mount the hoop.
6. Re-attach the tuning bolts and adjust the tension (p. 12).

NOTE

- Do not firmly tighten a single tuning bolt by itself. Doing so will make it impossible to tension the head evenly, and will cause malfunctions.
- Due to the nature of the materials used in the sensor, changes in room temperature may affect the sensitivity of the sensor.
- The rubber portion of the striking surface is treated with a preservative to maintain its performance. With the passage of time, this preservative may appear on the surface as a white stain, or reveal how the pads were struck during product testing. This does not affect the performance or functionality of the product, and you may continue using it with confidence.

Detaching/Mounting a Tom Pad

Please remember that the pads designed for the HD-1 will not fit on any other brand of stand.

Detaching a Tom Pad

1. Unplug the tom and cymbal cables.
2. Use a drum key to remove bolt securing the cymbal rod from the pipe.



3. Remove the plastic end-cap from the pipe.

* Do not insert your finger into the pipe while the cap is removed.



4. Use a drum key to loosen the bolt securing the pad to the pipe.



5. Remove the tom pad from the pipe.



Mounting a Tom Pad

This is basically a reverse operation of the detaching process. But when re-fitting the pads to the pipes, be careful to align the grooves in the pipe with the triangular protrusions of the pad. The pads can be fitted to three pitch(angle) positions.

Tom 1, Tom 2



Tom 3



Troubleshooting

If you suspect a malfunction, please read this page first.

Power does not turn on

AC adaptor is connected properly? (p. 10)

No sound

- Check the volume knob.
- Are all pad cables connected correctly?

If using an amp/audio system

- Volume settings and input/output connections are correct?
- If using headphones, are they correctly connected to the headphones or OUTPUT jack?

Sound is too soft/loud when playing

Check the sensitivity adjustments.

Double triggering occurs

- Check the bolts that secure the tom pads to the pipe.
- Be sure no cables are touching the pads.
- Use cable ties to secure any excess slack.
- Verify that the cymbal pad movement does not pull on the cable.

No Sound from external audio source connected to the MIX IN jack

- If you are using a connection cable that contains a resistor, this will reduce the volume. Use a cable with no resistor.
- Faulty cable? If so, replace it.
- Volume setting is correct on the connected audio source?
- Amp or audio system settings and connections are correct?

Sound is distorted in headphones

- Adjust the volume.
- Headphones are working correctly?

To check them, connect them to another audio source to verify.

Output sound is distorted

Lower the volume on the HD-1.

Or, if the connected amp has an input level adjustment, adjust accordingly.

Drum Kit Sound List

No.	Kit Name	Kick	Snare	Tom 1	Tom 2	Tom 3	Hi-Hat	Ride	Crash	
①	Normal	Acoustic	Wood Kick	Bright Snare	Wood Tom Hi	Wood Tom Mid	Wood Tom Low	Heavy Hi-Hat	Pop Ride	Fast Crash
	Variation	Jazz	Jazz Kick	Jazz Snare	Jazz Tom Hi	Cross Stick	Jazz Tom Low	Jazz Hi-Hat	Sizzle Ride	Fast "Tip" Crash
②	Normal	Power	Heavy Kick	Rock Snare	Power Tom Hi	Power Tom Mid	Power Tom Low	Dark Hi-Hat	Medium Ride	Thin Crash
	Variation	Double Bass	Heavy Kick	Rock Snare	Power Tom Hi	Rock Cowbell	Power Tom Low	Heavy Kick/ Open Hi-Hat	China/Ride	Thin Crash
③	Normal	Drums & Percussion	Jazz Kick	Jazz Snare	Timbales	Conga	Djembe	Heavy Hi-Hat	Pop Ride	Splash
	Variation	World	Cajon Stomp	Cajon Snare	Qujada/ Caxixi	Berimbau	Pot Drum	Pandeiro Crasher	Agogo	Crotale
④	Normal	Electronic	TR-808 Kick	TR-808 Snare	Hex Tom1	Hex Tom2	Hex Tom3	House Hi-Hat	TR-808 Cowbell	DR-110 Crash
	Variation	Dance	House Kick	House Snare	House Clap	Scratch	Super Low	House Hi-Hat	Reverse Ride	Space Crash
⑤	Normal	Voices	Voice Kick	Voice Snare	Voice-Bang	Voice-Dooit	Voice-Boom	Voice Hi-Hat	Voice-Tun	Voice-Harmony
	Variation	Droid	Boing Kick	Industrial Snare	Ratchet Tom	Droid Voice	Jet Tom	Droid Hi-Hat	Ba-Da-Bit	Chemical Crash

About MIDI

By connecting an external sound module to the HD-1's MIDI OUT connector you can play sounds on that external module.

If you connect the MIDI OUT to a sequencer, you can record your performance.

MIDI transmit channel	10
------------------------------	----

Hi-Hat Pedal	Position data is transmitted using control change number 4 (foot controller).
---------------------	---

	Pad	Note Number	Pad	Note Number
Note number produced when you strike a pad	Kick Pedal	36	Crash	49
	Snare	38	Ride	51
	Tom1	48	Hi-Hat (Open)	46
	Tom2	45	Hi-Hat (Closed)	42
	Tom3	43	Foot Close	44

Program Change	The following program change numbers are transmitted when you switch drum kits.					
		Drum Kit	PC		Drum Kit	PC
	1	Normal	1	4	Normal	4
		Variation	6		Variation	9
	2	Normal	2	5	Normal	5
		Variation	7		Variation	10
	3	Normal	3			
		Variation	8			

MIDI Implementation Chart

ELECTRONIC DRUM Model HD-1 Date : Mar. 1, 2007 Version : 1.00

Function...		Transmitted	Recognized	Remarks
Basic Channel	Default	10	x	Cannot be changed
	Changed	x	x	
Mode	Default	Mode 3	x	
	Messages Altered	x *****	x	
Note Number :	True Voice	36, 38, 42-46, 48 49, 51 *****	x	Cannot be changed
Velocity	Note ON	O 99H, V=1-127	x	
	Note OFF	x 89H, V=64	x	
After Touch	Key's Ch's	x x	x x	
Pitch Bend		x	x	
Control Change	4	O	x	Foot Control*1
Prog Change	: True Number	O (0...9) *****	x	Cannot be changed Prog. 1-10
System Exclusive		x	x	
System Common	: Song Pos	x	x	
	: Song Sel	x	x	
	: Tune	x	x	
System Real Time	: Clock	x	x	
	: Commands	x	x	
Aux Message	: All sound off	x	x	
	: Reset all controllers	x	x	
	: Local Control	x	x	
	: All Notes OFF	x	x	
	: Active Sense	O	x	
	: Reset	x	x	
Notes		*1 Transmits the position of the hi-hat pedal.		

Mode 1 : OMNI ON, POLY
Mode 3 : OMNI OFF, POLY

Mode 2 : OMNI ON, MONO
Mode 4 : OMNI OFF, MONO

O : Yes
X : No

Conversion for Left-Handed Use

If you are left handed, it is possible to configure the HD-1 for you.
Follow these instructions:

* You will need two 50 cm extension cables.

1. Remove both the crash and ride cables from the cymbal rod, then connect an extension cable to each of them. Next, switch the connections for these two cables.

2. Switch the cable connections to the Tom1 and Tom2 pads.

3. Remove and switch the positions and connections of the Tom3 and Hi-Hat pads.

** Pay attention to the angle when attaching tom 3 (p. 18).*

4. Switch the cable connections to the KICK and Hi-Hat CONTROL pedals.

(refer to the set-up instruction sheet if necessary)

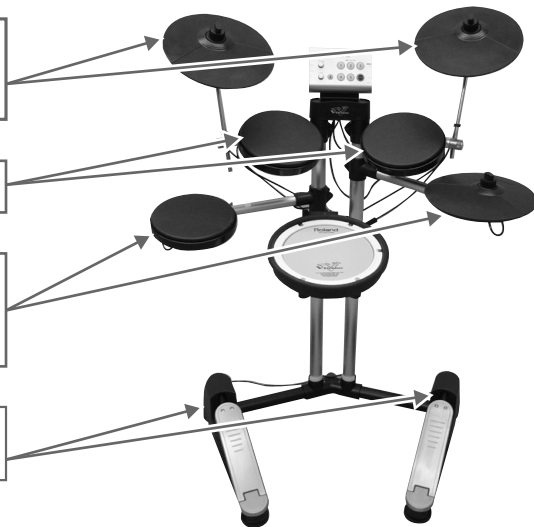

Specifications

HD-1 V-Drums Lite

● Kit Configuration

Kick Pedal, Snare, Hi-Hat, Hi-Hat Pedal, Tom x 3, Crash, Ride

● Drum Kits:

10

● Patterns:

10

● Controls:

Drum Kit button x 5

Variation button

Metronome button

Volume knob

Tempo knob

● Metronome:

Tempo (40-220)

Sounds (3 types)

Volume (3 levels)

● Connectors:

Output jack (Stereo miniature phone type) (*1)

Headphone jack (Stereo miniature phone type)

Mix In jack (Stereo miniature phone type)

MIDI Out connector (5-pin DIN type)

Trigger Cable connector (DB-25 type)

Output Jack can be connected with headphones.

(*1): Output Jack can be connected with headphones.

● Output Impedance:

Output jack: 100 Ω

Headphone jack: 100 Ω

● Power Supply:

DC 9 V (AC Adaptor)

● Current Draw:

300 mA

● Dimensions:

850 (W) x 560 (D) x 1170 (H) mm

33-1/2 (W) x 22-1/16 (D) x 46-1/16 (H) inches

● Weight:

15 kg / 33 lbs 2 oz (Excluding AC Adaptor)

● Accessories:

Owner's Manual

Set-up Guide

Video Manual (DVD)

AC Adaptor (PSB-1U)

Trigger Cable (Prepositioned in Drum Stand)

Drum Key

Screwdriver

Screws for Sound Module x 4

Screws for Foot Pipe x 4

Roland Sticker

● Options

Personal Drum Monitor: PM-01

V-Drums Accessory Package: DAP-1

V-Drums Mat: TDM-1

* *In the interest of product improvement, the specifications and/or appearance of this unit are subject to change without prior notice.*

Notation

This is the music notation for the basic 8-beat practice provided on the DVD.

1 2 3 4

R L R L

Crash

Hi-Hat

Snare

Kick Pedal

R : Right hand
L : Left hand

Performers Profile

DVD- performance/ explanations by Johnny Rabb

Johnny's Profile:

Resides in Nashville, TN/USA, is an author, producer, and touring/recording drummer, performing with top artists worldwide. He has been contributing for Roland since 2004 as an international V-Drums clinician and product demonstrator.

Composition performed on the DVD:

In the House (copyright © 2007 Johnny Rabb)

For the U.K.

IMPORTANT: THE WIRES IN THIS MAINS LEAD ARE COLOURED IN ACCORDANCE WITH THE FOLLOWING CODE.

BLUE: NEUTRAL
BROWN: LIVE

As the colours of the wires in the mains lead of this apparatus may not correspond with the coloured markings identifying the terminals in your plug, proceed as follows:

The wire which is coloured BLUE must be connected to the terminal which is marked with the letter N or coloured BLACK.

The wire which is coloured BROWN must be connected to the terminal which is marked with the letter L or coloured RED.

Under no circumstances must either of the above wires be connected to the earth terminal of a three pin plug.



- UK** This symbol indicates that in EU countries, this product must be collected separately from household waste, as defined in each region. Products bearing this symbol must not be discarded together with household waste.
- DE** Dieses Symbol bedeutet, dass dieses Produkt in EU-Ländern getrennt vom Hausmüll gesammelt werden muss gemäß den regionalen Bestimmungen. Mit diesem Symbol gekennzeichnete Produkte dürfen nicht zusammen mit den Hausmüll entsorgt werden.
- FR** Ce symbole indique que dans les pays de l'Union européenne, ce produit doit être collecté séparément des ordures ménagères selon les directives en vigueur dans chacun de ces pays. Les produits portant ce symbole ne doivent pas être mis au rebut avec les ordures ménagères.
- IT** Questo simbolo indica che nei paesi della Comunità europea questo prodotto deve essere smaltito separatamente dai normali rifiuti domestici, secondo la legislazione in vigore in ciascun paese. I prodotti che riportano questo simbolo non devono essere smaltiti insieme ai rifiuti domestici. Ai sensi dell'art. 13 del D.Lgs. 25 luglio 2005 n. 151.
- ES** Este símbolo indica que en los países de la Unión Europea este producto debe recogerse aparte de los residuos domésticos, tal como esté regulado en cada zona. Los productos con este símbolo no se deben depositar con los residuos domésticos.
- PT** Este símbolo indica que nos países da UE, a recolha deste produto deverá ser feita separadamente do lixo doméstico, de acordo com os regulamentos de cada região. Os produtos que apresentem este símbolo não deverão ser eliminados juntamente com o lixo doméstico.
- NL** Dit symbool geeft aan dat in landen van de EU dit product gescheiden van huishoudelijk afval moet worden aangeboden, zoals bepaald per gemeente of regio. Producten die van dit symbool zijn voorzien, mogen niet samen met huishoudelijk afval worden verwijderd.
- DK** Dette symbol angiver, at i EU-lande skal dette produkt opsamles adskilt fra husholdningsaffald, som defineret i hver enkelt region. Produkter med dette symbol må ikke smides ud sammen med husholdningsaffald.
- NO** Dette symbolet indikerer at produktet må behandles som spesialavfall i EU-land, iht. til retningslinjer for den enkelte regionen, og ikke kastes sammen med vanlig husholdningsavfall. Produkter som er merket med dette symbolet, må ikke kastes sammen med vanlig husholdningsavfall.

- SE** Symbolen anger att i EU-länder måste den här produkten kasseras separat från hushållsavfall, i enlighet med varje regions bestämmelser. Produkter med den här symbolen får inte kasseras tillsammans med hushållsavfall.
- FI** Tämä merkintä ilmaisee, että tuote on EU-maissa kerättävä erillään kotitalousjätteistä kunkin alueen voimassa olevien määräysten mukaisesti. Tällä merkinnällä varustettuja tuotteita ei saa hävittää kotitalousjätteiden mukana.
- HU** Ez a szimbólum azt jelenti, hogy az Európai Unióban ezt a terméket a háztartási hulladéktól elkülönítve, az adott régióban érvényes szabályozás szerint kell gyűjteni. Az ezzel a szimbólummal ellátott termékeket nem szabad a háztartási hulladék közé dobni.
- PL** Symbol oznacza, że zgodnie z regulacjami w odpowiednim regionie, w krajach UE produktu nie należy wyrzucać z odpadami domowymi. Produktów opatrzonych tym symbolem nie można utylizować razem z odpadami domowymi.
- CZ** Tento symbol udává, že v zemích EU musí být tento výrobek sbíráán odděleně od domácího odpadu, jak je určeno pro každý region. Výrobky nesoucí tento symbol se nesmí vyhazovat spolu s domácím odpadem.
- SK** Tento symbol vyjadruje, že v krajinách EÚ sa musí zber tohto produktu vykonávať oddelene od domového odpadu, podľa nariadení platných v konkrétnej krajine. Produkty s týmto symbolom sa nesmú vyhazovať spolu s domovým odpadom.
- EE** See sümbol näitab, et EL-i maades tuleb see toode olemprügist eraldi koguda, nii nagu on iga piirkonnas määratletud. Selle sümboliga märgitud tooteid ei tohi ära visata koos olemprügiga.
- LT** Šis simbolis rodo, kad ES šalyse šis produktas turi būti surenkamas atskirai nuo buitinių atliekų, kaip nustatyta kiekviename regione. Šio simbolio paženklinti produktai neturi būti išmetami kartu su buitinėmis atliekomis.
- LV** Šis simbols norāda, ka ES valstīs šo produktu jāievāc atsevišķi no mājsaimniecības atkritumiem, kā noteikts katrā reģionā. Produktus ar šo simbolu nedrīkst izmest kopā ar mājsaimniecības atkritumiem.
- SI** Ta simbol označuje, da je treba proizvod v državih EU zbirati ločeno od gospodinskih odpadkov, tako kot je določeno v vsaki regiji. Proizvoda s tem znakom ni dovoljeno odlagati skupaj z gospodinskimi odpadki.
- GR** Бхдф фп умэвлл дзлоней ьфл уфйт цосет фэт ЕЕ, фп рстьын бхф рсЭрей нб ухллЭгефбй очесшйфь брь фб пйкйбкь брссЯммбфб, умэщнб ме фз нпмьеуЯб фэт кьне рсшпчЮг. Фб рстьыфб рпх цЭспх бхф фп умэвлл ден рсЭрей нб брссЯрфпфбй мбжЯ ме фб пйкйбкь брссЯммбфб.



This product complies with the requirements of European Directive 89/336/EEC.

For EU Countries

FEDERAL COMMUNICATIONS COMMISSION RADIO FREQUENCY INTERFERENCE STATEMENT

For the USA

This equipment has been tested and found to comply with the limits for a Class B digital device, pursuant to Part 15 of the FCC Rules. These limits are designed to provide reasonable protection against harmful interference in a residential installation. This equipment generates, uses, and can radiate radio frequency energy and, if not installed and used in accordance with the instructions, may cause harmful interference to radio communications. However, there is no guarantee that interference will not occur in a particular installation. If this equipment does cause harmful interference to radio or television reception, which can be determined by turning the equipment off and on, the user is encouraged to try to correct the interference by one or more of the following measures:

- Reorient or relocate the receiving antenna.
- Increase the separation between the equipment and receiver.
- Connect the equipment into an outlet on a circuit different from that to which the receiver is connected.
- Consult the dealer or an experienced radio/TV technician for help.

This device complies with Part 15 of the FCC Rules. Operation is subject to the following two conditions:

- (1) This device may not cause harmful interference, and
- (2) This device must accept any interference received, including interference that may cause undesired operation.

Unauthorized changes or modification to this system can void the users authority to operate this equipment.
This equipment requires shielded interface cables in order to meet FCC class B Limit.

For Canada

NOTICE

This Class B digital apparatus meets all requirements of the Canadian Interference-Causing Equipment Regulations.

AVIS

Cet appareil numérique de la classe B respecte toutes les exigences du Règlement sur le matériel brouilleur du Canada.



* C 5 1 0 0 0 6 2 - 0 1 *

C5100062

07-04-1SS