



Owner's Manual

Roland Piano 1000s

	CAUTION RISK OF ELECTRIC SHOCK DO NOT OPEN	
ATTENTION : RISQUE DE CHOC ELECTRIQUE NE PAS OUVRIR		
<p>CAUTION: TO REDUCE THE RISK OF ELECTRIC SHOCK, DO NOT REMOVE COVER (OR BACK). NO USER-SERVICEABLE PARTS INSIDE. REFER SERVICING TO QUALIFIED SERVICE PERSONNEL.</p>		



The lightning flash with arrowhead symbol, within an equilateral triangle, is intended to alert the user to the presence of un-insulated "dangerous voltage" within the product's enclosure that may be of sufficient magnitude to constitute a risk of electric shock to persons.



The exclamation point within an equilateral triangle is intended to alert the user to the presence of important operating and maintenance (servicing) instructions in the literature accompanying the product.

INSTRUCTIONS PERTAINING TO A RISK OF FIRE, ELECTRIC SHOCK, OR INJURY TO PERSONS.

IMPORTANT SAFETY INSTRUCTIONS

WARNING — When using electric products, basic precautions should always be followed, including the following:

1. Read all the instructions before using the product.
2. Do not use this product near water — for example, near a bathtub, washbowl, kitchen sink, in a wet basement, or near a swimming pool, or the like.
3. This product should be used only with a cart or stand that is recommended by the manufacturer.
4. This product, either alone or in combination with an amplifier and headphones or speakers, may be capable of producing sound levels that could cause permanent hearing loss. Do not operate for a long period of time at a high volume level or at a level that is uncomfortable. If you experience any hearing loss or ringing in the ears, you should consult an audiologist.
5. The product should be located so that its location or position does not interfere with its proper ventilation.
6. The product should be located away from heat sources such as radiators, heat registers, or other products that produce heat.
7. Avoid using the product where it may be effected by dust.
8. The product should be connected to a power supply only of the type described in the operating instructions or as marked on the product.
9. The power-supply cord of the product should be unplugged from the outlet when left unused for a long period of time.
10. Do not tread on the power-supply cord.
11. Do not pull the cord but hold the plug when unplugging.
12. When setting up with any other instruments, the procedure should be followed in accordance with instruction manual.
13. Care should be taken so that objects do not fall and liquids are not spilled into the enclosure through openings.
14. The product should be serviced by qualified service personnel when:
 - A. The power-supply cord or the plug has been damaged; or
 - B. Objects have fallen, or liquid has been spilled into the product; or
 - C. The product has been exposed to rain; or
 - D. The product does not appear to operate normally or exhibits a marked change in performance; or
 - E. The product has been dropped, or the enclosure damaged.
15. Do not attempt to service the product beyond that described in the user-maintenance instructions. All other servicing should be referred to qualified service personnel.

SAVE THESE INSTRUCTIONS

WARNING: THIS APPARATUS MUST BE EARTHED

For the U.K.

IMPORTANT: THE WIRES IN THIS MAINS LEAD ARE COLOURED IN ACCORDANCE WITH THE FOLLOWING CODE.
GREEN-AND-YELLOW: EARTH, BLUE: NEUTRAL, BROWN: LIVE

As the colours of the wires in the mains lead of this apparatus may not correspond with the coloured markings identifying the terminals in your plug proceed as follows:

The wire which is coloured GREEN-AND-YELLOW must be connected to the terminal in the plug which is marked by the letter E or by the safety earth symbol  or coloured GREEN or GREEN-AND-YELLOW.

The wire which is coloured BLUE must be connected to the terminal which is marked with the letter N or coloured BLACK.

The wire which is coloured BROWN must be connected to the terminal which is marked with the letter L or coloured RED.

The product which is equipped with a THREE WIRE GROUNDING TYPE AC PLUG must be grounded.

FEATURES

The Roland Piano utilizes a unique digital signal processing system to reproduce the timbres, dynamics, and characteristics of many of the world's most famous acoustic and electric keyboard instruments. These instrument voices include two acoustic grand pianos, harpsichord, vibraphone and electric pianos.

The Roland Piano includes two built-in Chorus.

Each of the keyboard timbres of the Roland Piano can be controlled via the keyboard of its own or through MIDI with full control over velocity (dynamics).

CONTENTS

■ STAND ASSEMBLY	4
■ HOW TO ATTACH THE KEYBOARD COVER KL-2500	5
■ IMPORTANT NOTES	5
PANEL DESCRIPTION	6
Let's Play the Piano	8
1. Basic Operation	8
2. Tone Selection	8
3. Brilliance	8
4. Tuning	8
5. Chorus	9
6. Damper/Soft/Sostenuto Pedal	9
7. Key Transpose	10
SETUP WITH AUXILIARY AUDIO EQUIPMENT	11
MIDI	12
1. MIDI Sockets	12
2. Setting MIDI Channels	12
3. Program Change	13
a. Transmitting Program Change	13
b. Receive	14
4. Chorus	14
5. MIDI Functions	14
6. Multi Timbral Mode	15
7. Local ON/OFF	16
■ Sound Range Diagram	17
■ SPECIFICATIONS	17

Copyright © 1989 by ROLAND CORPORATION

All rights reserved. No part of this publication may be reproduced in any form without the written permission of ROLAND CORPORATION.

HOW TO ASSEMBLE THE KS-2500(Optional)

1 Attach side panels B to both ends of pedal unit A, with the holders on B facing inside, then tighten the screws (Fig.1-①). Be careful not to pinch or cut the connection cord.

2 Connect the connection cord as shown in Fig.1-②. Put C between the B panels and fix it with the screws.

3 Again being careful not to pinch or cut the connection cord, set the keyboard on the stand, sliding it toward you, and secure it with the supplied connecting pins, (Fig.1-③). (To tighten the connecting pins, use a large size screwdriver or a coin.)

4 Connect the stand's connector to the connector on the bottom of the keyboard, with both connectors facing to the same direction as shown in Fig.2-①.

5 Loosen the screw on cord clamp with the supplied screwdriver, pass the power cord through cord clamp, and retighten the screw (Fig.2).

6 After installing the assembled stand in place turn the adjusting bolt to assure firm contact with the floor. (Fig.3).

CAUTION:

Whenever it is necessary to move the Piano, make sure to remove the body from the stand by reversing the assembly procedure and move them separately.

Fig.1

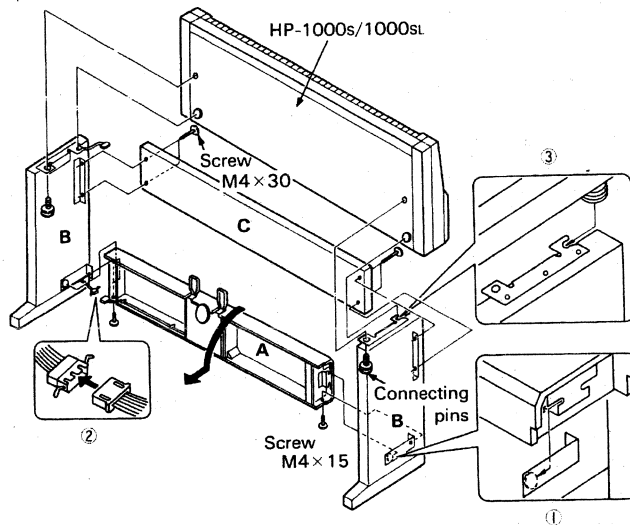

Fig.2

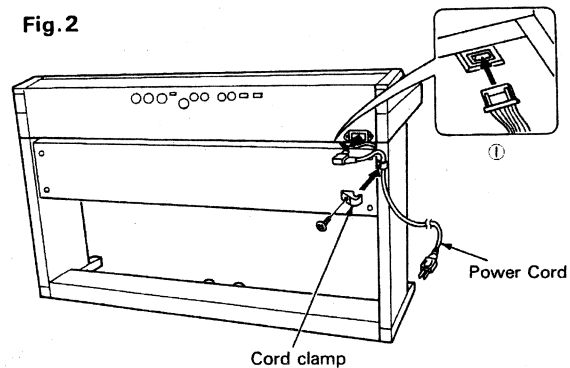
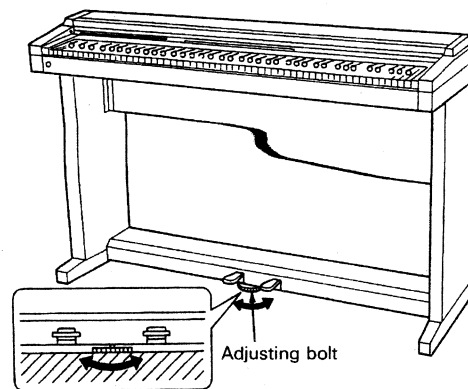
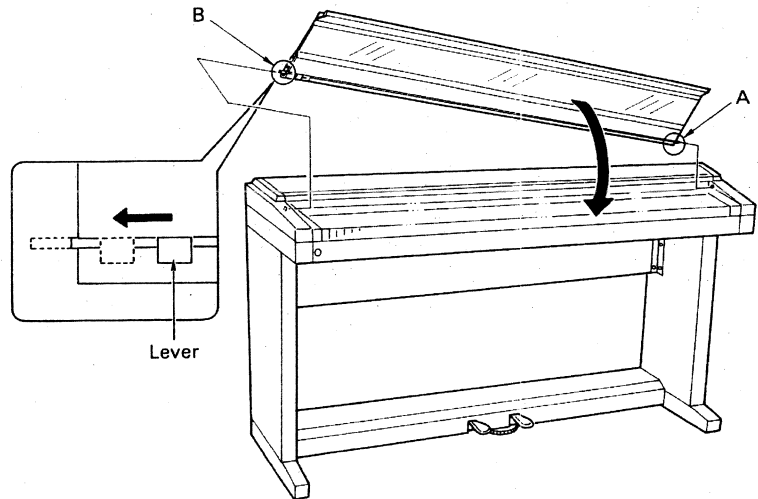

Fig.3



■ HOW TO ATTACH THE KEYBOARD COVER KL-2500

- ① Insert **A** into the hole on the side panel of the keyboard.
- ② Place **B** at the hole on the side panel of the keyboard, slide the lever, and insert the cover support hinge into the hole as shown in the picture.



■ IMPORTANT NOTES

In addition to the items listed under Safety Precautions, on page 2, we request that you please read and adhere to the following.

Concerning the power supply

- Whenever you make any connections with other devices, always turn off the power to all equipment first. This will help in preventing malfunction, and damage to speakers.
- Do not force the unit to share the same power outlet as one used for distortion producing devices (such as motors, variable lighting devices). Be sure to use a separate power outlet.
- This unit might not work properly if the power cable is plugged in with the unit turned on. If this happens, simply turn the unit off, and turn it on again in a few seconds.
- Before using the unit in a foreign country, check first with your local Roland Service Station.

Maintenance

- For everyday cleaning, wipe the unit with a soft dry cloth, or one that is dampened slightly. To remove dirt that is more stubborn, wipe using a mild, neutral detergent. Afterwards, make sure to wipe thoroughly with a soft cloth.
- Never apply benzene, thinners, alcohol or any like agents, to avoid the risk of discoloration and deformation.

PANEL DESCRIPTION

《Front Panel》

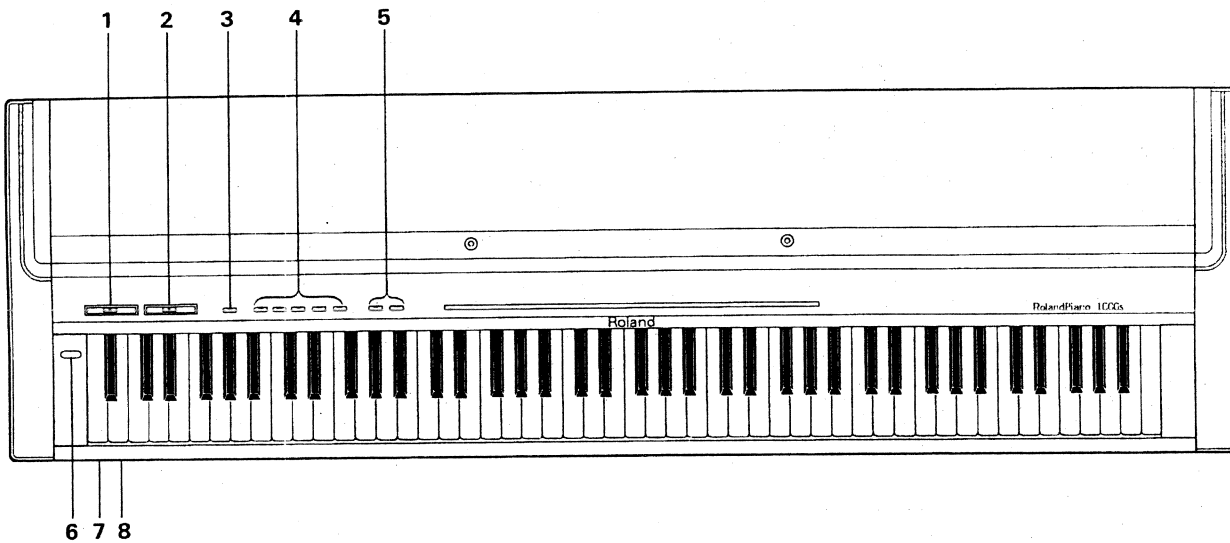

3: Key Transpose/MIDI Button

2: Brilliance Control Slider

4: Tone Selectors

1: Volume Slider

5: Chorus Buttons

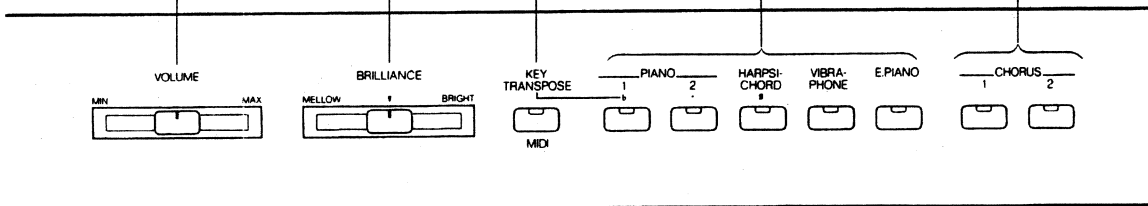

6: Power Switch

7: Power Indicator

8: Headphone Jack

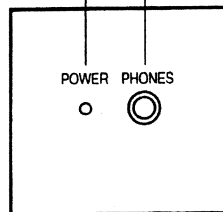
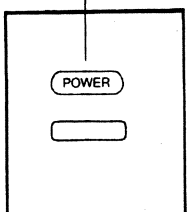

《Rear Panel》

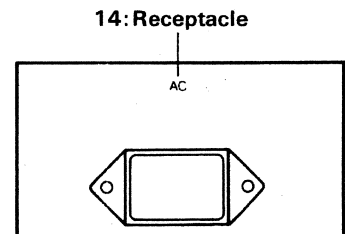
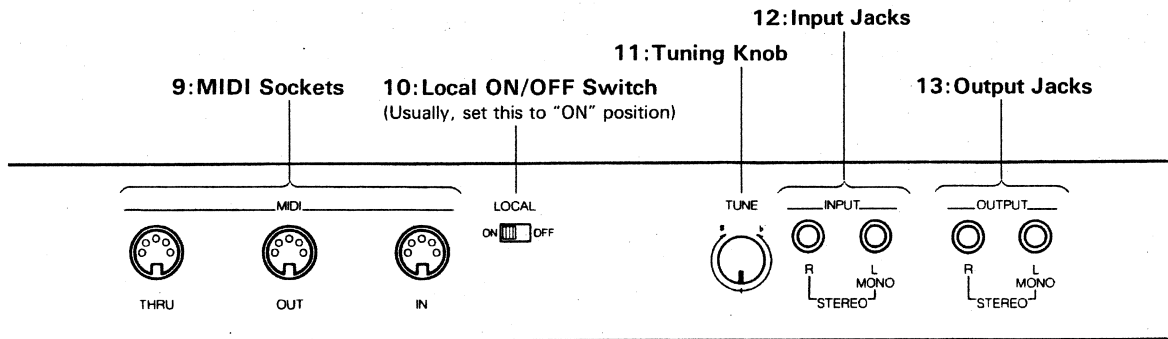
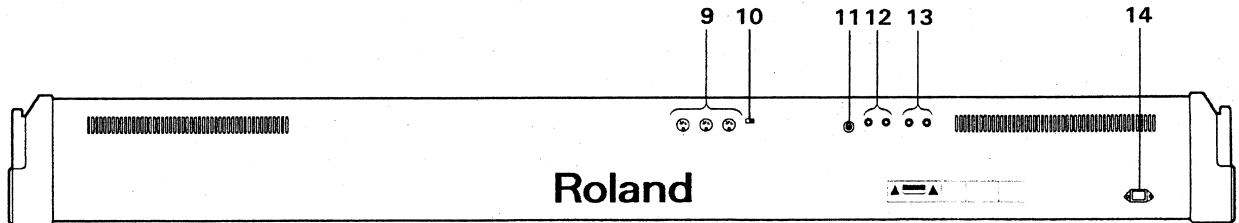

Headphones

Standard stereo headphones can be used with the Roland Piano for private listening and practice. Connecting the headphone plug to the headphone jack will disconnect the internal speakers. The Volume control on the front panel will adjust the headphone volume.

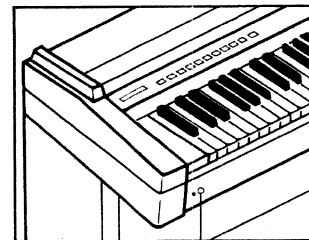

Headphone Jack

Let's Play the Piano

1. Basic Operation

- ① Connect the plug of the power cable to the wall socket.
- ② Turn the piano on.

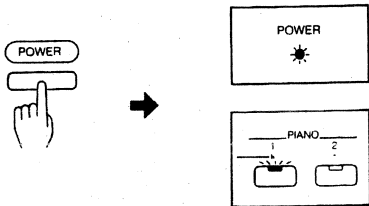

* For about 2 seconds after turned on, the piano cannot be played because of the muting circuit.

- ③ Adjust the volume with the Volume Control slider.

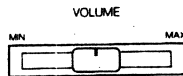

2. Tone Selection

The Roland Piano features 5 keyboard sounds; two acoustic grand pianos, harpsichord, vibraphone and electric pianos.

- ▶ To select a voice, press one of the Tone Selector buttons. One keyboard sound can be selected at a time.

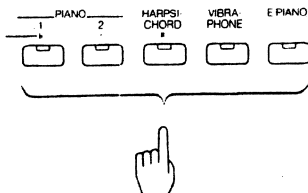

VOICE PRESERVE FUNCTION

The Roland Piano features the Voice Preserve Function, that is, while you are playing the keyboard using a certain voice, you can request the next voice to be used, without the voice actually changing until you release all the keys.

When the piano is being played with the Note or Damper/Sostenuto ON (See next page), the voice does not change (the indicator of the corresponding sound flashes.) To change the voices, lift all Notes and the Damper/Sostenuto OFF. (Now, the indicator of the new voice is constantly lit.)

3. Brilliance

As you slide the Brilliance Control to the right, the tone will become brighter, and mellower when moved to the left.

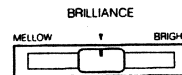

4. Tuning

The Tune Knob is provided for controlling the overall tuning center of the Roland Piano. This is especially useful for tuning to other acoustic instruments, synthesizers, and synthesizer sound modules. Since the Roland Piano incorporate S/A Synthesis, the tuning of individual notes will never be necessary. At its center position, Middle A = 442Hz.



5. Chorus

The HP-Piano includes two built-in Chorus effects.

- **Chorus 1**

A lush stereo chorus effect can be obtained.

- **Chorus 2**

Even a deeper chorus effect can be obtained.

How to turn Chorus on:

- ▶ **Select Chorus 1 or 2 by pushing the relevant Chorus button. (The indicator lights up.)**

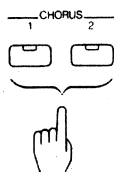

* Both Choruses 1 and 2 cannot be turned on simultaneously.

Chorus On or Off can be set individually for each voice, and it is retained until the piano is switched off.

When the piano is switched on, Chorus of each voice is set as follows:

Piano 1	OFF
Piano 2	OFF
Harpsichord	OFF
Vibraphone	ON (Chorus 2)
E. Piano	ON (Chorus 1)

6. Damper/Soft/Sostenuto Pedal

The supplied stand (optional) features two pedals:

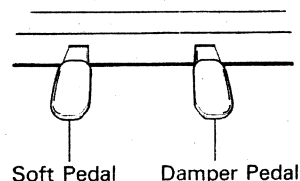

- **Damper (Sustain) Pedal (right)**

The Damper Pedal makes the sound decay slowly.

- **Soft Pedal (left)**

The Soft Pedal serves to make the performance softer.

- **Sostenuto Pedal**

How to turn the Soft Pedal to Sostenuto Pedal.

- ▶ **Switch the piano on while holding the pedal down.**

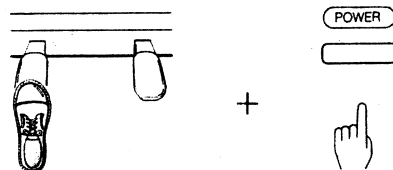

While holding down

Pressing the Sostenuto Pedal will turn on the Damper of the note currently played, while the following notes will not take on any effect.

* When the pedal is turned to a Sostenuto function, the Soft function will temporarily cease.

To return the pedal to the Soft Pedal function, switch the piano off once, then after a few seconds, switch it on again.

7. Key Transpose

The keyboard of your HP-1000s/1000SL can be transposed within a range of a perfect 4th up and a diminished 5th down.

- ▶ While holding the Transpose button down, press either of the following buttons as many times as necessary.

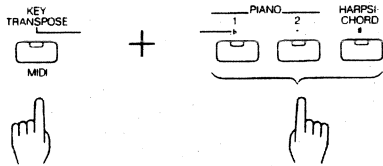

While holding down Press as many times as necessary for the amount of transposition.

Button (= Harpsichord Button)

Pressing this button will increase the pitch in semi-tone steps. (This button can be used up to 5 times.)

b Button (= Piano 1 Button)

Pressing this button will decrease the pitch in semi-tone steps. (This button can be used up to 6 times.)

• Button (= Piano 2 Button)

This button returns the key to the normal condition.

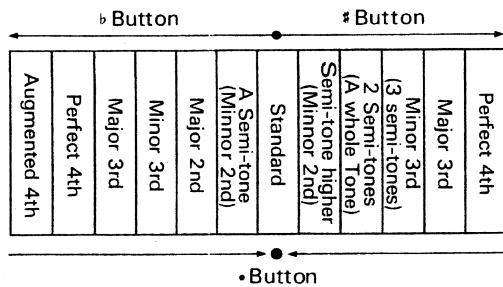

When the transposition is done, the Key Transpose button glows steadily.

Once the key is transposed, the Transpose On or Off can be selected by pressing the Key Transpose button.

* While you are taking the transposing procedure, the Piano cannot be played.

[e.g. 1] Transposing to E

While holding the Key Transpose button down, press the # button four times.

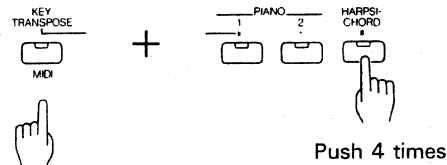

While holding down

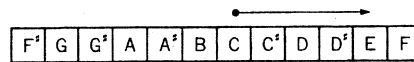

[e.g. 2] Transposing E to G

While holding the Key Transpose button down, press the b button once to return to the normal pitch, then press the b button five times (without releasing the Key Transpose button).

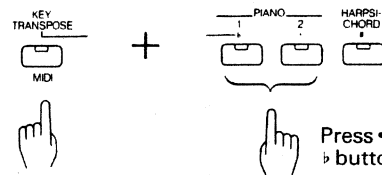

While holding down

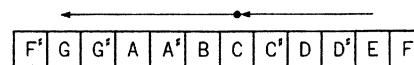

SETUP WITH AUXILIARY AUDIO EQUIPMENT

Auxiliary audio equipment can be set up with the Roland Piano through the Input or Output jacks as shown in the picture.

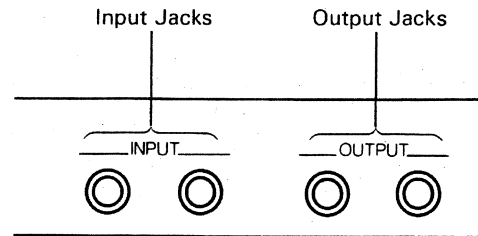

• Input Jacks

The external input jacks are provided for connecting the outputs of other electronic instruments (sound module MT-100, etc.) to the internal speakers and amplifier of the Roland Piano.

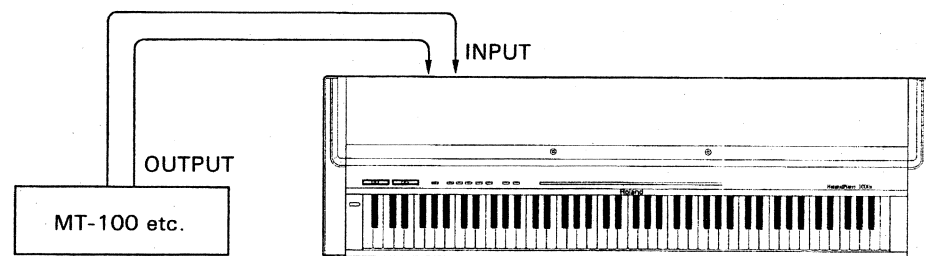

• Output Jacks

These output jacks are provided for connecting the Roland Piano to larger sound systems such as a home stereo system, multi-track recorders, mixers, and/or auxiliary instrument amplifiers.

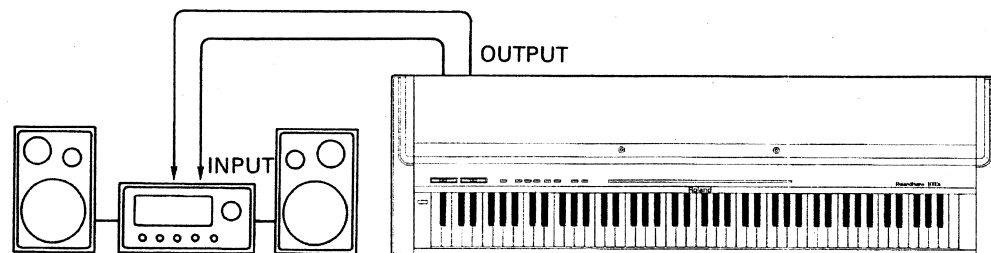

<Setup>

- ① Turn down the volume of the external amplifier connected to the piano.
- ② Connect the Output Jacks of the piano to the Line In's (e.g. AUX) of the amplifier.
- ③ Adjust the volume of the amplifier.

* Connecting the headphone plug to the headphone jack will disconnect the internal speakers.

Part of the power of your Roland Piano is in the use of the MIDI (Musical Instrument Digital Interface). To learn more about MIDI and the various music systems that can be added to your HP-Piano, refer to the enclosed booklet "MIDI" and the MIDI implementation chart in the back of this owner's manual.

1. MIDI Sockets

The Roland Piano has MIDI IN, MIDI OUT and MIDI THRU Sockets on the rear panel.

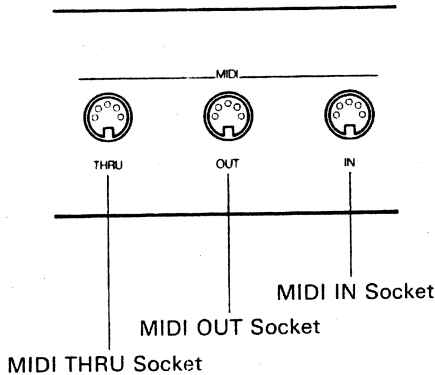

• MIDI IN Socket

When using the piano as a MIDI sound module controlled by the external MIDI device, connect the MIDI IN socket to the MIDI OUT or MIDI THRU on the external device.

• MIDI OUT Socket

When using the piano as a keyboard controller that drives the external device, connect the MIDI OUT socket to the MIDI IN on the external device.

• MIDI THRU Socket

Through this, the exact copy of the signal fed into the MIDI IN is sent out.

2. Setting MIDI Channels

For MIDI setup, it is necessary to set the MIDI channel of a transmitter device to the same number as the receiver device.

- ▶ While holding the MIDI button down, push the key that corresponds to the MIDI Channel number you want. (See next page.)

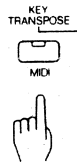

+

Press the key that corresponds to the MIDI channel you want

While holding down

- * While holding the MIDI button down, press the highest key to set the transmit channel to 1 and the receive channel to 1 (and OMNI ON). (Refer to the MIDI Implementation in the back of this owner's manual.)

The receive and transmit MIDI channels can be set separately.

• Setting only the Transmit MIDI Channel

- ① While holding the MIDI button down, press the Damper Pedal.
- ② While still holding both down, press the key that corresponds to the channel you wish. (See next page.)

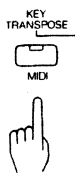

+

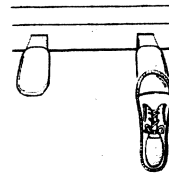

+

Press the key that corresponds to the MIDI channel you want

While holding down Press the Damper Pedal

● **Setting only the Receive MIDI Channel**

- ① While holding the MIDI button down, press the Soft Pedal.
- ② While still holding both down, press the key that corresponds to the channel you wish.

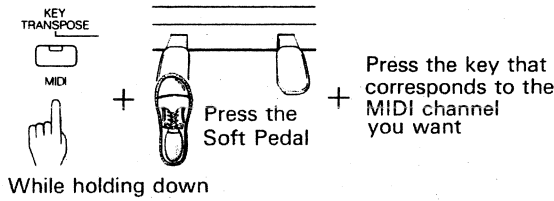

* To set the receive channel to 1 (and OMNI ON), press the highest key while holding the MIDI button down.

* At power up. The transmit channel is set to 1 and the receive channel is set to 1 (and OMNI OFF).

3. Program Change

Program Change messages are MIDI messages for sound (e.g. Patch, Voice) selection. Program Change numbers are assigned to the sound (e.g. Patch, Voice) numbers on each instrument individually.

a. Transmitting Program Change

The Piano can transmit Program Change numbers (Group, Bank and Number) to an external MIDI device using the keys within the set range.

The Group/Bank/Numbers on the correspond to the Program Change numbers as shown below.

Program Change Number Table

GROUP	BANK	NO.							
		1	2	3	4	5	6	7	8
A	1	1	2	3	4	5	6	7	8
	2	9	10	11	12	13	14	15	16
	3	17	18	19	20	21	22	23	24
	4	25	26	27	28	29	30	31	32
	5	33	34	35	36	37	38	39	40
	6	41	42	43	44	45	46	47	48
	7	49	50	51	52	53	54	55	56
	8	57	58	59	60	61	62	63	64
B	1	65	66	67	68	69	70	71	72
	2	73	74	75	76	77	78	79	80
	3	81	82	83	84	85	86	87	88
	4	89	90	91	92	93	94	95	96
	5	97	98	99	100	101	102	103	104
	6	105	106	107	108	109	110	111	112
	7	113	114	115	116	117	118	119	120
	8	121	122	123	124	125	126	127	128

- ▶ While holding the MIDI button down, press the keys that correspond to the Group, Bank and Number.

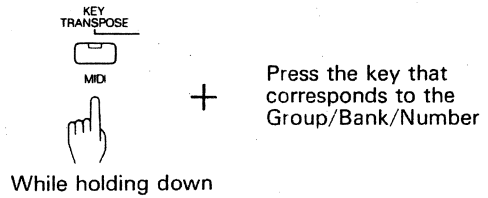

MIDI Channel and Program Change correspond to the keyboard as shown below.

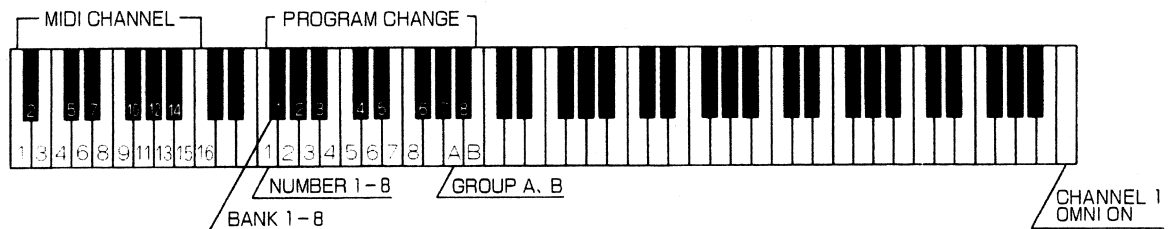

4. Chorus

b. Receive

When the piano receive Program Change messages 1 to 8, the corresponding voice is automatically selected.

Received Program Change No.	Selected Voice
1	Piano 2
2	Piano 1
3	Piano 1
4	Harpsichord
5	Piano 1
6	Vibraphone
7	E. Piano
8	E. Piano

* The Roland Piano receives 1 to 8 Program Change messages, but ignores 9 to 128.

When the MIDI device connected to the piano features a built-in chorus, the chorus can be turned on or off as follows.

► **While holding the MIDI Button down, push the Chorus 1 or 2 Button.**

* If the external MIDI device has only one chorus, you can use either of the Chorus Buttons.

* The above procedure does not affect the chorus effect on the piano.

5. MIDI Functions

The HP-Piano can select any of the following four modes that decide how the messages are received and transmitted.

- (I) Note On/Off, Pedal and Program Change messages are transmitted and received.
- (II) Note On/Off, Pedal and Program Change messages are transmitted. Program Change messages are not received.
- (III) Note On/Off, Pedal and Program Change messages are transmitted and received.
The moment a new voice is selected on the piano, the corresponding Program Change number is transmitted. The Chorus On/Off is also transmitted. Even without taking the Chorus ON/OFF procedure. Chorus On/Off messages are transmitted by turning on or off Chorus effect. This mode may be used when recording data into a MIDI sequencer.
- (IV) Performance information (messages) sent from an external MIDI device (e.g. sequencer) can play more than one voice of the piano.

* Refer to "Multi Timbral Mode" on the following page.

<How to select one of the four modes>

- (I) Turning the piano on will automatically select this mode.
- (II) Turn the piano on while holding down the PIANO-1 button.
- (III) Turn the piano on while holding down the MIDI button.
- (IV) Turn the piano on while holding down the PIANO-2 button.

* It is also possible to select Mode IV by using MIDI Exclusive messages. Refer to "MIDI Implementation".

6. Multi Timbral Mode

Five voices can be played at the same time by using the performance information (messages) sent from an external MIDI device. This is called Multi Timbral Mode.

Using this mode, you can play one voice by messages sent from a sequencer while playing a different voice by the piano's keyboard.

- To activate the Multi Timbral mode, switch the piano on while holding the piano 2 button.

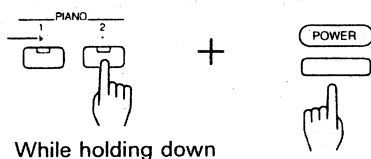

While holding down

a. Receive

In the Multi Timbral mode, messages sent from an external MIDI device are received on channel 1, 11, 12, 13 or 14.

* MIDI messages sent on any other channel will be ignored.

b. Voice Selection

When a Program Change number is received on channel 1, 11, 12, 13 or 14, the corresponding voice on the piano is selected.

Upon power up, the voices assigned to the channels are as follows:

Channel	Voice
1	Piano 1
11	Piano 2
12	Harpsichord
13	Vibraphone
14	E. Piano

Voice	Program Change Number
Piano 1	2, 3 or 5
Piano 2	1
Harpsichord	4
Vibraphone	6
E. Piano	7 or 8

c. Playing the piano using its own keyboard

To play the piano by its own keyboard, set the transmit channel of the piano to 1, 3 or 4 which the piano currently uses. (See page 13.) Voices on the piano changes according to the Program Change number sent on the set channel.

* When the transmit channel is set to other than 1, 11, 12, 13 or 14, your performance messages (Note On messages on the keyboard) are not received by the piano, and therefore cannot play the piano.

d. Pedal Messages

The piano's pedal functions only on the sound created from its own keyboard, and the Pedal messages sent from an external MIDI device works only on the sound created by the MIDI performance messages sent from the external MIDI device.

e. Chorus On/Off Messages

When Chorus On messages are received, the Chorus effect is turned on, while Chorus Off messages turn off the effect. The Chorus On or Off messages are received on channel 1, 11, 12, 13 or 14. the messages received last has priority. Turning the Chorus On or Off on the piano will affect all the voices at the same time.

7. Local ON/OFF

Using the switch on the rear panel, the HP-1000s/1000sL can easily be set to either Local On or Local Off.

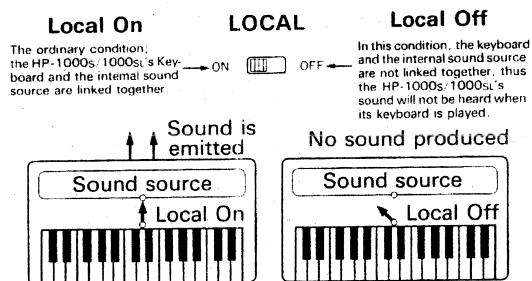

Local Off is effective to use when you wish only a connected module to be sounded, or when you have a MIDI sequencer connected.

When the HP-1000s/1000sL and a sequencer are connected up as shown below, what is played on the HP-1000s/1000sL can be recorded into the sequencer. Later the sequencer can be played, thus playing the HP-1000s/1000sL.

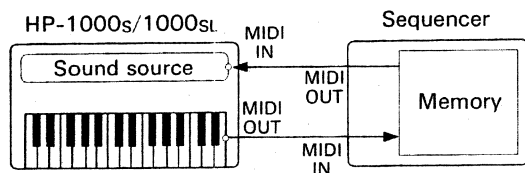

However, if you have the sequencer set to Soft Thru On (condition whereby any information received at its MIDI IN is transmitted from MIDI OUT), the HP-1000s/1000sL needs to be set to Local Off.

This is because if it is left at Local On, and the keyboard is played, one stream of signals from the keyboard directly sounds the internal source, along with another identical stream arriving via the sequencer. This type of redundancy can cause a tone to sound differently than it normally should, or cause certain notes to be left out.

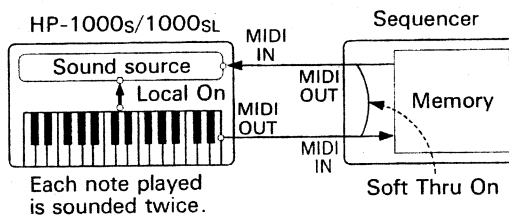

You should check how your sequencer is handling Soft Thru by referring to its manual, and then alter settings if necessary.

* Since the HP-1000s/1000sL receives and responds to any Local On/Off messages that may be received from an external MIDI device, you should take caution, since the position shown by the switch may not always reflect the actual status the unit has assumed.

* When the MIDI IN socket is not connected to a MIDI cable, this unit is always set to LOCAL ON no matter where the switch on the rear of the unit is set.

■ Sound Range Diagram

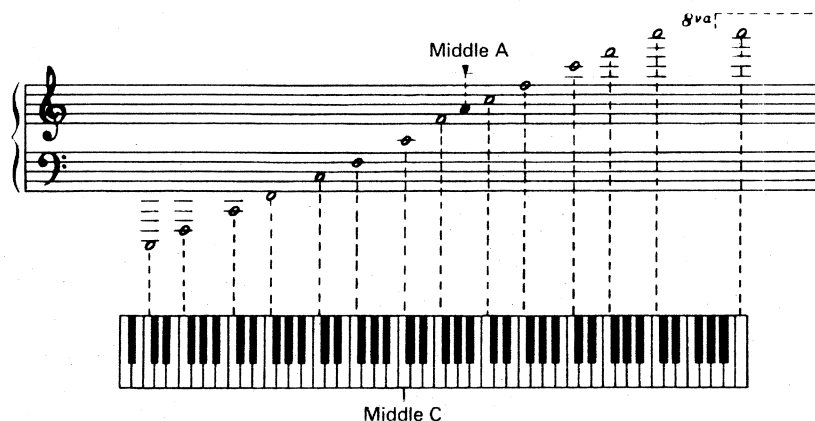

■ SPECIFICATIONS

	HP-1000s	HP-1000sL (A Keyboard Cover is Supplied.)
Keyboard	88 Keys	
Maximum number of voices	32 voice polyphonic	
Preset Voices	Pianos 1,2, Harpsichord, Vibraphone, Electric Piano	
Effects	Chorus 1 ON/OFF, Chorus 2 ON/OFF	
Connectors	Output Jacks (Mono, Stereo) Input Jacks (Mono, Stereo) MIDI IN Socket MIDI OUT Socket MIDI THRU Socket	
Switches	Power Switch, Local ON/OFF Switch	
Speakers	16cm×2	
Output	20W×2	
Finish	Roland Original Oak	
Dimensions W×D×H	1417(W)×475.5(D)×153.8(H)mm 55-13/16"×18-11/16"×6-1/16"	
Weight	38kg/83lb 14oz	40kg/88lb 5oz
Consumption	117V:60W 220/240V:100W	
Accessories	Power Cord Music Rest	Power Cord Keyboard Cover (KL-2500)
Options	Stand (KS-2500) Keyboard Cover (KL-2500)	Stand (KS-2500)

Roland Exclusive Messages

1 Data Format for Exclusive Messages

Roland's MIDI implementation uses the following data format for all exclusive messages (type IV):

Byte	Description
F0H	Exclusive status
41H	Manufacturer ID (Roland)
DEV	Device ID
MDL	Model ID
CMD	Command ID
[BODY]	Main data
F7H	End of exclusive

MIDI status : F0H, F7H

An exclusive message must be flanked by a pair of status codes, starting with a Manufacturer-ID immediately after F0H (MIDI version 1.0).

Manufacturer-ID : 41H

The Manufacturer-ID identifies the manufacturer of a MIDI instrument that triggers an exclusive message. Value 41H represents Roland's Manufacturer-ID.

Device-ID : DEV

The Device-ID contains a unique value that identifies the individual device in the multiple implementation of MIDI instruments. It is usually set to 00H - 0FH, a value smaller by one than that of a basic channel, but value 00H - 1FH may be used for a device with multiple basic channels.

Model-ID : MDL

The Model-ID contains a value that uniquely identifies one model from another. Different models, however, may share an identical Model-ID if they handle similar data.

The Model-ID format may contain 00H in one or more places to provide an extended data field. The following are examples of valid Model-IDs, each representing a unique model :

01H
02H
03H
00H, 01H
00H, 02H
00H, 00H, 01H

Command-ID : CMD

The Command-ID indicates the function of an exclusive message. The Command-ID format may contain 00H in one or more places to provide an extended data field. The following are examples of valid Command-IDs, each representing a unique function :

01H
02H
03H
00H, 01H
00H, 02H
00H, 00H, 01H

Main data : BODY

This field contains a message to be exchanged across an interface. The exact data size and contents will vary with the Model-ID and Command-ID.

2 Address mapped Data Transfer

Address mapping is a technique for transferring messages conforming to the data format given in Section 1. It assigns a series of memory-resident records—waveform and tone data, switch status, and parameters, for example—to specific locations in a machine-dependent address space, thereby allowing access to data residing at the address a message specifies.

Address-mapped data transfer is therefore independent of models and data categories. This technique allows use of two different transfer procedures: one-way transfer and handshake transfer.

One-way transfer procedure (See Section 3 for details.)

This procedure is suited for the transfer of a small amount of data. It sends out an exclusive message completely independent of a receiving device status.

Connection Diagram

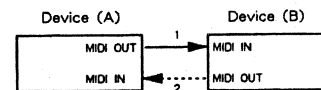

Connection at point 2 is essential for "Request data" procedures. (See Section 3.)

Handshake transfer procedure (See Section 4 for details.)

This procedure initiates a predetermined transfer sequence (handshaking) across the interface before data transfer takes place. Handshaking ensures that reliability and transfer speed are high enough to handle a large amount of data.

Connection Diagram

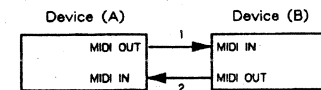

Connection at points 1 and 2 is essential.

Notes on the above two procedures

- * There are separate Command-IDs for different transfer procedures.
- * Devices A and B cannot exchange data unless they use the same transfer procedure, share identical Device-ID and Model ID, and are ready for communication.

3 One-way Transfer Procedure

This procedure sends out data all the way until it stops and is used when the messages are so short that answerbacks need not be checked.

For long messages, however, the receiving device must acquire each message in time with the transfer sequence, which inserts intervals of at least 20 milliseconds in between.

Types of Messages

Message	Command ID
Request data 1	RQ1 (11H)
Data set 1	DT1 (12H)

Request data # 1 : RQ1 (11H)

This message is sent out when there is a need to acquire data from a device at the other end of the interface. It contains data for the address and size that specify designation and length, respectively, of data required.

On receiving an RQ1 message, the remote device checks its memory for the data address and size that satisfy the request.

If it finds them and is ready for communication, the device will transmit a "Data set 1 (DT1)" message, which contains the requested data. Otherwise, the device will send out nothing.

Byte	Description
F0H	Exclusive status
41H	Manufacturer ID (Roland)
DEV	Device ID
MDL	Model ID
11H	Command ID
aaH	Address MSB
⋮	⋮
	LSB
ssH	Size MSB
⋮	⋮
	LSB
sum	Check sum
F7H	End of exclusive

- *The size of the requested data does not indicate the number of bytes that will make up a DT1 message, but represents the address fields where the requested data resides.
- *Some models are subject to limitations in data format used for a single transaction. Requested data, for example, may have a limit in length or must be divided into predetermined address fields before it is exchanged across the interface.
- *The same number of bytes comprises address and size data, which, however, vary with the Model-ID.
- *The error checking process uses a checksum that provides a bit pattern where the least significant 7 bits are zero when values for an address, size, and that checksum are summed.

Data set 1 : DT1 (12H)

This message corresponds to the actual data transfer process. Because every byte in the data is assigned a unique address, a DT1 message can convey the starting address of one or more data as well as a series of data formatted in an address-dependent order.

The MIDI standards inhibit non-real time messages from interrupting an exclusive one. This fact is inconvenient for the devices that support a "soft-through" mechanism. To maintain compatibility with such devices, Roland has limited the DT1 to 256 bytes so that an excessively long message is sent out in separate segments.

Byte	Description
F0H	Exclusive
41H	Manufacturer ID (Roland)
DEV	Device ID
MDL	Model ID
12H	Command ID
aaH	Address MSB
⋮	⋮
ddH	Data
⋮	⋮
sum	Check sum
F7H	End of exclusive

- *A DT1 message is capable of providing only the valid data among those specified by an RQ1 message.
- *Some models are subject to limitations in data format used for a single transaction. Requested data, for example, may have a limit in length or must be divided into predetermined address fields before it is exchanged across the interface.
- *The number of bytes comprising address data varies from one Model-ID to another.
- *The error checking process uses a checksum that provides a bit pattern where the least significant 7 bits are zero when values for an address, size, and that checksum are summed.

Example of Message Transactions

- Device A sending data to Device B
Transfer of a DT1 message is all that takes place.

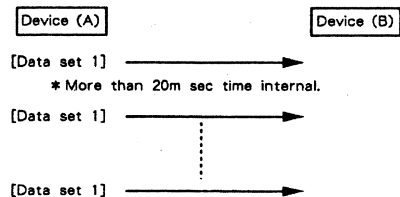

- Device B requesting data from Device A
Device B sends an RQ1 message to Device A. Checking the message, Device A sends a DT1 message back to Device B.

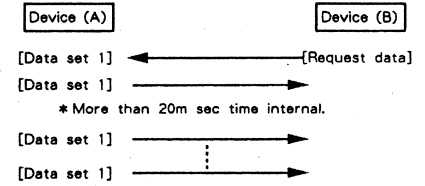

4. Handshake Transfer Procedure

Handshaking is an interactive process where two devices exchange error checking signals before a message transaction takes place, thereby increasing data reliability. Unlike one-way transfer that inserts a pause between message transactions, handshake transfer allows much speedier transactions because data transfer starts once the receiving device returns a ready signal.

When it comes to handling large amounts of data-sampler waveforms and synthesizer tones over the entire range, for example-across a MIDI interface, handshaking transfer is more efficient than one-way transfer.

Types of Messages

Message	Command ID
Want to send data	WSD (40H)
Request data	RQD (41H)
Data set	DAT (42H)
Acknowledge	ACK (43H)
End of data	EOD (45H)
Communication error	ERR (4EH)
Rejection	RJC (4FH)

Want to send data : WSD (40H)

This message is sent out when data must be sent to a device at the other end of the interface. It contains data for the address and size that specify designation and length, respectively, of the data to be sent.

On receiving a WSD message, the remote device checks its memory for the specified data address and size which will satisfy the request. If it finds them and is ready for communication, the device will return an "Acknowledge (ACK)" message.

Byte	Description
F0H	Exclusive status
41H	Manufacturer ID (Roland)
DEV	Device ID
MDL	Model ID
40H	Command ID
aaH	Address MSB
⋮	⋮
ssH	Size MSB
⋮	⋮
sum	Check sum
F7H	End of exclusive

Otherwise, it will return a "Rejection (RJC)" message.

- *The size of the data to be sent does not indicate the number of bytes that make up a "Data set (DAT)" message, but represents the address fields where the data should reside.
- *Some models are subject to limitations in data format used for a single transaction. Requested data, for example, may have a limit in length or must be divided into predetermined address fields before it is exchanged across the interface.
- *The same number of bytes comprises address and size data, which, however, vary with the Model-ID.
- *The error checking process uses a checksum that provides a bit pattern where the least significant 7 bits are zero when values for an address, size, and that checksum are summed.

Request data : RQD (41H)

This message is sent out when there is a need to acquire data from a device at the other end of the interface. It contains data for the address and size that specify designation and length, respectively, of data required.

On receiving an RQD message, the remote device checks its memory for the data address and size which satisfy the request. If it finds them and is ready for communication, the device will transmit a "Data set (DAT)" message, which contains the requested data. Otherwise, it will return a "Rejection (RJC)" message.

Byte	Description
F0H	Exclusive status
41H	Manufacturer ID (Roland)
DEV	Device ID
MDL	Model ID
41H	Command ID
aaH	Address MSB
⋮	⋮
	LSB
ssH	Size MSB
⋮	⋮
	LSB
sum	Check sum
F7H	End of exclusive

*The size of the requested data does not indicate the number of bytes that make up a "Data set (DAT)" message, but represents the address fields where the requested data resides.

*Some models are subject to limitations in data format used for a single transaction. Requested data, for example, may have a limit in length or must be divided into predetermined address fields before it is exchanged across the interface.

*The same number of bytes comprises address and size data, which, however, vary with the Model-ID.

*The error checking process uses a checksum that provides a bit pattern where the least significant 7 bits are zero when values for an address, size, and that checksum are summed.

Data set : DAT (42H)

This message corresponds to the actual data transfer process. Because every byte in the data is assigned a unique address, the message can convey the starting address of one or more data as well as a series of data formatted in an address-dependent order.

Although the MIDI standards inhibit non-real time messages from interrupting an exclusive one, some devices support a "soft-through" mechanism for such interrupts. To maintain compatibility with such devices, Roland has limited the DAT to 256 bytes so that an excessively long message is sent out in separate segments.

Byte	Description
F0H	Exclusive status
41H	Manufacturer ID (Roland)
DEV	Device ID
MDL	Model ID
42H	Command ID
aaH	Address MSB
⋮	⋮
	LSB
ddH	Data
⋮	⋮
sum	Check sum
F7H	End of exclusive

*A DAT message is capable of providing only the valid data among those specified by an RQD or WSD message.

*Some models are subject to limitations in data format used for a single transaction. Requested data, for example, may have a limit in length or must be divided into predetermined address fields before it is exchanged across the interface.

*The number of bytes comprising address data varies from one model ID to another.

*The error checking process uses a checksum that provides a bit pattern where the least significant 7 bits are zero when values for an address, size, and that checksum are summed.

Acknowledge : ACK (43H)

This message is sent out when no error was detected on reception of a WSD, DAT, "End of data (EOD)", or some other message and a requested setup or action is complete. Unless it receives an ACK message, the device at the other end will not proceed to the next operation.

Byte	Description
F0H	Exclusive status
41H	Manufacturer ID (Roland)
DEV	Device ID
MDL	Model ID
43H	Command ID
F7H	End of exclusive

End of data : EOD (45H)

This message is sent out to inform a remote device of the end of a message. Communication, however, will not come to an end unless the remote device returns an ACK message even though an EOD message was transmitted.

Byte	Description
F0H	Exclusive status
41H	Manufacturer ID (Roland)
DEV	Device ID
MDL	Model ID
45H	Command ID
F7H	End of exclusive

Communications error : ERR (4EH)

This message warns the remote device of a communications fault encountered during message transmission due, for example, to a checksum error. An ERR message may be replaced with a "Rejection (RJC)" one, which terminates the current message transaction in midstream.

When it receives an ERR message, the sending device may either attempt to send out the last message a second time or terminate communication by sending out an RJC message.

Byte	Description
F0H	Exclusive status
41H	Manufacturer ID (Roland)
DEV	Device ID
MDL	Model ID
4EH	Command ID
F7H	End of exclusive

Rejection : RJC (4FH)

This message is sent out when there is a need to terminate communication by overriding the current message. An RJC message will be triggered when:

- a WSD or RQD message has specified an illegal data address or size.
- the device is not ready for communication.
- an illegal number of addresses or data has been detected.
- data transfer has been terminated by an operator.
- a communications error has occurred.

An ERR message may be sent out by a device on either side of the interface. Communication must be terminated immediately when either side triggers an ERR message.

Byte	Description
F0H	Exclusive status
41H	Manufacturer ID (Roland)
DEV	Device ID
MDL	Model ID
4FH	Command ID
F7H	End of exclusive

Example of Message Transactions

- Data transfer from device (A) to device (B).

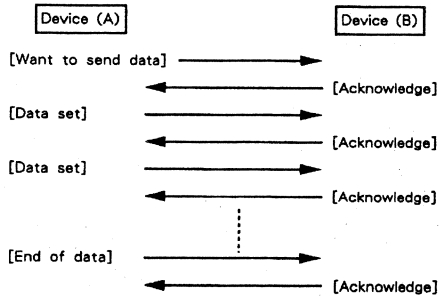

- Device (A) requests and receives data from device (B).

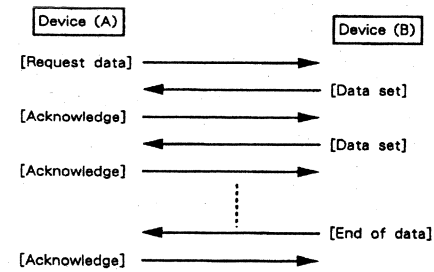

- Error occurs while device (A) is receiving data from device (B).

- 1) Data transfer from device (A) to device (B).

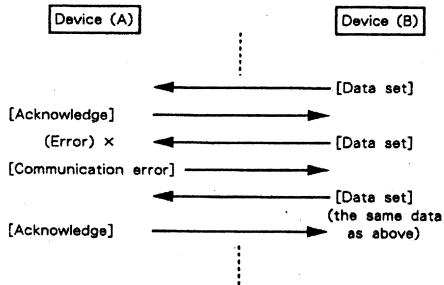

- 2) Device (B) rejects the data re-transmitted, and quits data transfer.

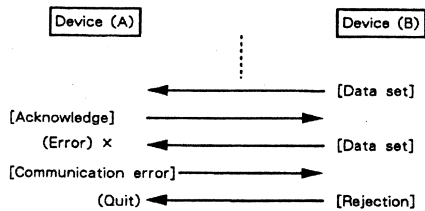

- 3) Device (A) immediately quits data transfer.

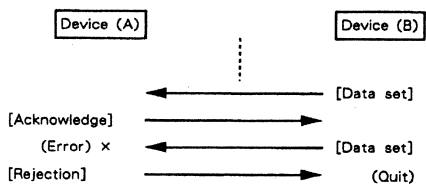

1. Performance mode

HP - 1000S have 2 performance mode of normal mode and multi timbre mode.

■ Normal mode

Normal mode is ordinary performance mode.

■ Multi timbre mode

In Multi timbre mode, there are 5 independent parts, corresponding to receive channel 1,11,12,13 and 14. These parts can have specific tones assigned to them. If transmit channel not set 1,11,12,13 or 14, the HP - 1000S can not to be connected to the part.

When the power is first applied, the tone is set in each part as follows.

Part (Channel)	Tone
1 (1)	Piano 1
2 (11)	Piano 2
3 (12)	Harpsichord
4 (13)	Vibraphone
5 (14)	E.Piano

● Partial reserve

Number of partial which is reserved for each part at least is set.

When the HP - 1000S turned to multi timbre mode, partial reserve count set as follows.

Part	Partial reserve count
1	8
2	8
3	4
4	4
5	8

Using partial number is various in each tone.

The following chart shows the relation between the tone and using partial number.

Tone	Partial number
Piano 1	2
Piano 2	2
Harpsichord	1
Vibraphone	1
E.Piano	2

2. RECOGNIZED RECEIVE DATA (Normal mode)

■ Channel voice message

● Note off

Status	Second	Third
8nH	kkH	vvH
9nH	kkH	00H

n = MIDI Channel : 0H - FH (0 - 15) 0 = ch.1 15 = ch.16
 kk = Note number : 00H - 7FH (0 - 127)
 vv = Velocity : 00H - 7FH (0 - 127)

* Velocity value is ignored.

● Note on

Status	Second	Third
9nH	kkH	vvH

n = MIDI Channel : 0H - FH (0 - 15) 0 = ch.1 15 = ch.16
 kk = Note number : 00H - 7FH (0 - 127)
 vv = Velocity : 01H - 7FH (1 - 127)

* Note numbers outside of the range 15 - 113 are transposed to the nearest octave inside this range.

* The transpose function does not affect the recognized note numbers.

● Control change

○ Hold - 1

Status	Second	Third
BnH	40H	vvH

n = MIDI Channel : 0H - FH (0 - 15) 0 = ch.1 15 = ch.16
 vv = Control Value : 00H - 7FH (0 - 127) 0 - 63 = OFF 64 - 127 = ON

○ Sostenuto

Status	Second	Third
BnH	42H	vvH

n = MIDI Channel : 0H - FH (0 - 15) 0 = ch.1 15 = ch.16
 vv = Control Value : 00H - 7FH (0 - 127) 0 - 63 = OFF 64 - 127 = ON

○ Soft

Status	Second	Third
BnH	43H	vvH

n = MIDI Channel : 0H - FH (0 - 15) 0 = ch.1 15 = ch.16
 vv = Control Value : 00H - 7FH (0 - 127) 0 - 63 = OFF 64 - 127 = ON

○ Chorus

Status	Second	Third
BnH	5DH	vvH

n = MIDI Channel : 0H - FH (0 - 15) 0 = ch.1 15 = ch.16
 vv = Control Value : 00H - 7FH (0 - 127) 0 - 40 = OFF 41 - 83 = Chorus1 84 - 127 = Chorus2

* If the power has been applied while PIANO 1 switch is being held down, Chorus message is ignored.

● Program change

Status	Second
CnH	ppH

n = MIDI Channel : 0H - FH (0 - 15) 0 = ch.1 15 = ch.16
 pp = Program change number : 00H - 7H (0 - 7)

Program change number	Tone
0	Piano 2
1	Piano 1
2	Piano 1
3	Harpsichord
4	Piano 1
5	Vibraphone
6	E.Piano
7	E.Piano

* If the power has been applied while PIANO 1 switch is being held down, this message is ignored.

■ Channel mode message

● Local control

Status	Second	Third
BnH	7AH	vvH

n = MIDI Channel : 0H - FH (0 - 15) 0 = ch.1 15 = ch.16
 vv = Control Value : 0H - 7FH (0 - 127) 0 - 63 = OFF 64 - 127 = ON

* When the local off is recognized, all the internal notes which have been turned on only by internal keyboard are turned off.

● All notes off

Status	Second	Third
BnH	7BH	00H

n = MIDI Channel : 0H - FH (0 - 15) 0 = ch.1 15 = ch.16

* When the all notes off is recognized, all the notes which have been turned on only by note on messages are turned off. However, if the hold - 1 on message has been recognized, these notes will not be turned off until the hold - 1 off message is received.

● OMNI OFF

Status Second Third
BnH 7CH 00H

n = MIDI Channel : 0H - FH (0 - 15) 0 = ch.1 15 = ch.16

* The omni off message is also recognized as all notes off.* 1

● OMNI ON

Status Second Third
BnH 7DH 00H

n = MIDI Channel : 0H - FH (0 - 15) 0 = ch.1 15 = ch.16

* The omni on message is also recognized as all notes off.* 1

● MONO

Status Second Third
BnH 7EH mmH

n = MIDI Channel : 0H - FH (0 - 15) 0 = ch.1 15 = ch.16

* The mono message is also recognized as all notes off.* 1

● POLY

Status Second Third
BnH 7FH 00H

n = MIDI Channel : 0H - FH (0 - 15) 0 = ch.1 15 = ch.16

* The poly message is also recognized as all notes off.* 1

Note :

* 1 OMNI ON/OFF, POLY and MONO are recognized as follows.

	POLY ON	MONO ON	MONO ON
		nn=1	nn<1
OMNI OFF	OMNI-OFF	OMNI-OFF	OMNI-ON
	POLY	POLY	POLY
OMNI ON	OMNI=ON	OMNI=ON	OMNI=ON
	POLY	POLY	POLY

■ System realtime message

● Active sensing

Status
FEH

■ System exclusive message

Status Data byte
FOH iiH,ddH,.....eeH
F7H

FOH : System exclusive
ii = ID Number : 41H (65)
dd,.....ee = Data : 00H - 7FH (0 - 127)
F7H : EOX (End of Exclusive/System common)

In normal mode, multi timbre mode on message can be recognized.

Refer to "Roland Exclusive Message" and section 6.

3. RECOGNIZED RECEIVE DATA (Multi timbre mode)

■ Channel voice message

● Note off

Status Second Third
8nH kkH vvH
9nH kkH 00H

n = MIDI Channel : 0H,AH,BH,CH,DH (0,10,11,12,13) 0 = ch.1 13 = ch.14
kk = Note number : 00H - 7FH (0 - 127)
vv = Velocity : 00H - 7FH (0 - 127)

* Velocity value is ignored.

● Note on

Status Second Third
9nH kkH vvH

n = MIDI Channel : 0H,AH,BH,CH,DH (0,10,11,12,13) 0 = ch.1 13 = ch.14
kk = Note number : 00H - 7FH (0 - 127)
vv = Velocity : 01H - 7FH (1 - 127)

* Note numbers outside of the range 15 - 113 are transposed to the nearest octave inside this range.

* The transpose function does not affect the recognized note numbers

● Control change

○ Hold - 1

Status Second Third
BnH 40H vvH

n = MIDI Channel : 0H,AH,BH,CH,DH (0,10,11,12,13) 0 = ch.1 13 = ch.14
vv = Control Value : 00H - 7FH (0 - 127) 0 - 63 = OFF 64 - 127 = ON

○ Sostenuato

Status Second Third
BnH 42H vvH

n = MIDI Channel : 0H,AH,BH,CH,DH (0,10,11,12,13) 0 = ch.1 13 = ch.14
vv = Control Value : 00H - 7FH (0 - 127) 0 - 63 = OFF 64 - 127 = ON

○ Soft

Status Second Third
BnH 43H vvH

n = MIDI Channel : 0H,AH,BH,CH,DH (0,10,11,12,13) 0 = ch.1 13 = ch.14
vv = Control Value : 00H - 7FH (0 - 127) 0 - 63 = OFF 64 - 127 = ON

○ Chorus

Status Second Third
BnH 5DH vvH

n = MIDI Channel : 0H,AH,BH,CH,DH (0,10,11,12,13) 0 = ch.1 13 = ch.14
vv = Control Value : 00H - 7FH (0 - 127) 0 - 40 = OFF 41 - 83 = Chorus1 84 - 127 = Chorus2

* Recognized chorus message affects all the parts.

● Program change

Status Second
CnH ppH

n = MIDI Channel : 0H, AH, BH, CH, DH (0, 10, 11, 12, 13) 0 = ch.1 13 = ch.14
pp = Program change number : 00H - 7H (0 - 7)

Program change number	Tone
0	Piano 2
1	Piano 1
2	Piano 1
3	Harpsichord
4	Piano 1
5	Vibraphone
6	E.Piano
7	E.Piano

■ Channel mode message

● Local control

Status Second Third
BnH 7AH vvH

n = MIDI Channel : 0H, AH, BH, CH, DH (0, 10, 11, 12, 13) 0 = ch.1 13 = ch.14
vv = Control Value : 0H - 7FH (0 - 127) 0 = OFF 64 - 127 = ON

* When the local off is recognized, all the internal notes which have been turned on only by internal keyboard are turned off.

● All notes off

Status Second Third
BnH 7BH 00H

n = MIDI Channel : 0H, AH, BH, CH, DH (0, 10, 11, 12, 13) 0 = ch.1 13 = ch.14

* When the all notes off is recognized, all the notes which have been turned on only by note on messages are turned off.
However, if the hold - 1 on message has been recognized, these notes will not be turned off until the hold - 1 off message is received.

■ System realtime message

● Active sensing

Status
FEH

■ System exclusive message

Status Data byte
F0H iiH, ddH,eeH
F7H

F0H : System exclusive
ii = ID Number : 41H (65)
dd,ee = Data : 00H - 7FH (0 - 127)
F7H : EOX (End of Exclusive/System common)

In multi timbre mode, multi timbre mode off and partial reserve count messages can be recognized.

Refer to "Roland Exclusive Message" and section 6.

4. TRANSMITTED DATA (Normal mode/Multi timbre mode)

■ Channel voice message

● Note off

Status Second Third
9nH kkH 00H

n = MIDI Channel : 0H - FH (0 - 15) 0 = ch.1 15 = ch.16
kk = Note number : 0FH - 71H (15 - 113)

● Note on

Status Second Third
9nH kkH vvH

n = MIDI Channel : 0H - FH (0 - 15) 0 = ch.1 15 = ch.16
kk = Note number : 0FH - 71H (15 - 113)
vv = Velocity : 01H - 7FH (1 - 127)

* The range may be changed by transposition.

* The transpose value can be set with in the range of - 6 to + 5.

To transpose the keyboard, while holding down the TRANSPOSE/MIDI switch press the [b] switch to key down or [#] to key up, once for each semitone. Pressing the [b] switch than 6 times ([#] switch 5 times) does not introduce further effect.

To return the keyboard back to the original key, press the [·].

When the power is first applied, the default transposition is set at 0.

The following chart shows the relation between the transmitted note range and transposed value.

Transpose Value	Transmitted note range
- 6	15 - 102
- 5	16 - 103
- 4	17 - 104
- 3	18 - 105
- 2	19 - 106
- 1	20 - 107
0	21 - 108
+ 1	22 - 109
+ 2	23 - 110
+ 3	24 - 111
+ 4	25 - 112
+ 5	26 - 113

● Control change

○ Hold - 1

Status Second Third
BnH 40H vvH

n = MIDI Channel : 0H - FH (0 - 15) 0 = ch.1 15 = ch.16
vv = Control Value : 00H, 7FH (0, 127) 0 = OFF 127 = ON

○ Sostenuto

Status Second Third
BnH 42H vvH

n = MIDI Channel : 0H - FH (0 - 15) 0 = ch.1 15 = ch.16
vv = Control Value : 00H, 7FH (0, 127) 0 = OFF 127 = ON

○ Soft

Status Second Third
BnH 43H vvH

n = MIDI Channel : 0H - FH (0 - 15) 0 = ch.1 15 = ch.16
vv = Control Value : 00H, 7FH (0, 127) 0 = OFF 127 = ON

○ Chorus

Status	Second	Third
BnH	5DH	vvH

n = MIDI Channel : 0H - FH (0 - 15) 0 = ch.1 15 = ch.16
 vv = Control Value : 00H, 40H, 7FH (0, 64, 127) 0 = OFF 64 = Chorus1
 127 = Chorus2

- * When the CHORUS 1/2 switch is pressed while TRANSPOSE/MIDI switch is being held down, the chorus off/1/2 message sent.
- * Also, if the power has been applied while the TRANSPOSE/MIDI switch is being held down, the chorus message can be sent by only pressing the CHORUS 1/2 switch.

● Program change

Status	Second
CnH	ppH

n = MIDI Channel : 0H - FH (0 - 15) 0 = ch.1 15 = ch.16
 pp = Program change number : 00H - 7FH (0 - 127)

- * The following chart shows the GROUP, BANK and NUMBER values related to key position which is set while the TRANSPOSE/MIDI switch being held down. When one of these keys is pressed while TRANSPOSE/MIDI switch is being held down, a program change message will be transmitted.

Key	GROUP, BANK, NUMBER
A3	GROUP A
B3	GROUP B
F # 2	BANK 1
G # 2	BANK 2
A # 2	BANK 3
C # 3	BANK 4
D # 3	BANK 5
F # 3	BANK 6
G # 3	BANK 7
A # 3	BANK 8
F2	NUMBER 1
G2	NUMBER 2
A2	NUMBER 3
B2	NUMBER 4
C3	NUMBER 5
D3	NUMBER 6
E3	NUMBER 7
F3	NUMBER 8

- * The transmitted program change number are related with the GROUP, BANK, NUMBER values as follows.

GROUP A	NUMBER	BANK							
		1	2	3	4	5	6	7	8
1	0	1	2	3	4	5	6	7	
2	8	9	10	11	12	13	14	15	
3	16	17	18	19	20	21	22	23	
4	24	25	26	27	28	29	30	31	
5	32	33	34	35	36	37	38	39	
6	40	41	42	43	44	45	46	47	
7	48	49	50	51	52	53	54	55	
8	56	57	58	59	60	61	62	63	

GROUP B	NUMBER	BANK							
		1	2	3	4	5	6	7	8
1	64	65	66	67	68	69	70	71	
2	72	73	74	75	76	77	78	79	
3	80	81	82	83	84	85	86	87	
4	88	89	90	91	92	93	94	95	
5	96	97	98	99	100	101	102	103	
6	104	105	106	107	108	109	110	111	
7	112	113	114	115	116	117	118	119	
8	120	121	122	123	124	125	126	127	

- * If the power has been applied while the TRANSPOSE/MIDI switch is being held down, the program change message can be sent by only pressing following switches.

Tone	Program change number
Piano 1	1
Piano 2	0
Harpichord	3
Vibraphone	5
E.Piano	6

■ Channel mode message

● All notes off

Status	Second	Third
BnH	7BH	00H

n = MIDI Channel : 0H - FH (0 - 15) 0 = ch.1 15 = ch.16

- * If the power has been applied while the HARPSICHORD switch is being held down, when all keys on the keyboard are released, the all note off is sent in the basic channel.

● OMNI OFF

Status	Second	Third
BnH	7CH	00H

n = MIDI Channel : 0H - FH (0 - 15) 0 = ch.1 15 = ch.16

- * When the power is first applied, omni off is sent in the basic channel.

● POLY

Status	Second	Third
BnH	7FH	00H

n = MIDI Channel : 0H - FH (0 - 15) 0 = ch.1 15 = ch.16

- * When the power is first applied, poly is sent in the basic channel.

■ System oommon message

● Active sensing

Status
FEH

- * Active sensing transmits with in the interval of 300 msec.

5. Basic channel setting

To change transmit channel, press the TRANSPOSE/MIDI switch and hold down DAMPER pedal then select the key on the keyboard as follows corresponding to the required MIDI channel.

To change receive channel, press the TRANSPOSE/MIDI switch and hold down SOFT pedal then select the key on the keyboard as follows corresponding to the required MIDI channel.

To change transmit and receive channel at the same time, press the TRANSPOSE/MIDI switch only then select the key on the keyboard as follows corresponding to the required MIDI channel.

When changing the transmit or receive channel, the receiver is set to MODE 3 (OMNI ON,POLY).

When the highest key (C8) on the keyboard is pressed while the TRANSPOSE/MIDI switch has been held down, the transmit and the receive channel are set to 1, and the receiver is set to Mode 1 (OMNI ON, POLY).

If the DAMPER pedal is held down and the SOFT pedal not (change only transmit channel), the HP - 1000S can not be change to MODE 1 (OMNI ON, POLY).

When the power is first applied, the transmit and the receive channel is normally set to 1, and the receiver is set to MODE 3 (OMNI OFF, POLY).

In multi timbre mode, receive channel can not change and OMNI ON can not set.

Key	Basic channel	OMNI
Power - on	1	OFF
A1	1	OFF
A # 1	2	OFF
B1	3	OFF
C2	4	OFF
C # 2	5	OFF
D2	6	OFF
D # 2	7	OFF
E2	8	OFF
F2	9	OFF
F # 2	10	OFF
G2	11	OFF
G # 2	12	OFF
A2	13	OFF
A # 2	14	OFF
B2	15	OFF
C3	16	OFF
C8	1	ON

6. Exclusive Communication

The HP - 1000S can receive multi timbre mode on/off and partial reserve count by Exclusive communication.

In multi timbre mode, partial reserve count can be recognized.

The HP - 1000S's Model ID is 1AH.

The HP - 1000S's Device ID is 00H.

■ One - way transfer procedure

● Data set 1 DT1 (12H)

Byte	Description
FOH	Exclusive status
41H	Manufacturer ID (Roland)
00H	Device ID
1AH	Model ID (HP - 1000S)
12H	Command ID (DT1)
aaH	Address MSB
bbH	Address LSB
ccH	Data
:	:
ddH	Data
sum	Check Sum
F7H	EOX (End of exclusive)

6. Parameter Address Map (Model ID = 1AH)

The address is expressed by 7bit hexadecimal number.

Address	MSB	LSB
Binary	0aaa aaaa	0bbb bbbb
Hexadecimal	AA	BB

■ Parameter base address

Start address	Description
00 00	Multi Timbre Mode 0 : OFF, 01H - 7FH : ON
00 10	Partial Reserve Count Part 1 *1
00 1A	Partial Reserve Count Part 2 *1
00 1B	Partial Reserve Count Part 3 *1
00 1C	Partial Reserve Count Part 4 *1
00 1D	Partial Reserve Count Part 5 *1
	2H - 18H

Note :

*1 When the sum of the partial reserve count exceed 32, this message is ignored.

MIDI Implementation Chart

Function ...		Transmitted	Recognized	Remarks
Basic Channel	Default Changed	1 1 - 16	1 1, 11, 12, 13, 14	
Mode	Default Messages Altered	Mode 3 OMNI OFF, POLY *****	Mode 3 ×	* 2
Note Number	True Voice	15 - 113 *****	0 - 127 15 - 113	
Velocity	Note ON Note OFF	○ × 9n v = 0	○ ×	
After Touch	Key's Ch's	× ×	× ×	
Pitch Bender		×	×	
Control Change	64	○	○	Hold - 1 Sostenute Soft Chorus
	66	○	○	
	67	○	○	
	93	* 1	○	
Prog Change	True #	* 1 *****	○ 0 - 7	
System Exclusive		×	○	
System Common	Song Pos Song Sel Tune	× × ×	× × ×	
System Real Time	Clock Commands	× ×	× ×	
Aux Message	Local ON/OFF All Notes OFF Active Sense Reset	× * 1 (123) ○ ×	○ ○ (123) ○ ×	
Notes		* 1 Able to chose between ○ and ×. * 2 When power on, CH - 1 OMNI OFF and POLY are sent.		

Mode 1 : OMNI ON, POLY
Mode 3 : OMNI OFF, POLY

Mode 2 : OMNI ON, MONO
Mode 4 : OMNI OFF, MONO

○ : Yes
× : No

MIDI Implementation Chart

Function ...		Transmitted	Recognized	Remarks
Basic Channel	Default Changed	1 1 - 16	1 1 - 16	* 2
Mode	Default Messages Altered	Mode 3 OMNI OFF, POLY *****	Mode 3 ○	* 3
Note Number	True Voice	15 - 113 *****	0 - 127 15 - 113	
Velocity	Note ON Note OFF	○ × 9n v = 0	○ ×	
After Touch	Key's Ch's	× ×	× ×	
Pitch Bender		×	×	
Control Change	64 66 67 93	○ ○ ○ * 1	○ ○ ○ * 1	Hold - 1 Sostenute Soft Chorus
Prog Change	True #	* 1 *****	* 1 0 - 7	
System Exclusive		×	○	
System Common	Song Pos Song Sel Tune	× × ×	× × ×	
System Real Time	Clock Commands	× ×	× ×	
Aux Message	Local ON/OFF All Notes OFF Active Sense Reset	× * 1 (123) ○ ×	○ ○ (123 - 127) ○ ×	
Notes		* 1 Able to chose between ○ and ×. * 2 Able to change indivisually transmit and receive channel. * 3 When power on, CH - 1 OMNI OFF and POLY are sent.		

Mode 1 : OMNI ON, POLY
Mode 3 : OMNI OFF, POLY

Mode 2 : OMNI ON, MONO
Mode 4 : OMNI OFF, MONO

○ : Yes
× : No

For West Germany

Bescheinigung des Herstellers/Importeurs

Hiermit wird bescheinigt, daß der/die/das

ROLAND DIGITAL PIANO HP-1000s/1000SL

(Gerät. Typ. Bezeichnung)

in Übereinstimmung mit den Bestimmungen der

Amtsbl. Vfg 1046/1984

(Amtsblattverfügung)

funk-entstört ist.

Der Deutschen Bundespost wurde das Inverkehrbringen dieses Gerätes angezeigt und die Berechtigung zur Überprüfung der Serie auf Einhaltung der Bestimmungen eingeräumt.

Roland Corporation Osaka/Japan

Name des Herstellers/Importeurs

For the USA

RADIO AND TELEVISION INTERFERENCE

WARNING — This equipment has been verified to comply with the limits for a Class B computing device, pursuant to Subpart J, of Part 15, of FCC rules. Operation with non-certified or non-verified equipment is likely to result in interference to radio and TV reception.

The equipment described in this manual generates and uses radio frequency energy. If it is not installed and used properly, that is, in strict accordance with our instructions, it may cause interference with radio and television reception. This equipment has been tested and found to comply with the limits for a Class B computing device in accordance with the specifications in Subpart J, of Part 15, of FCC Rules. These rules are designed to provide reasonable protection against such a interference in a residential installation. However, there is no guarantee that the interference will not occur in a particular installation. If this equipment does cause interference to radio or television reception, which can be determined by turning the equipment on and off, the user is encouraged to try to correct the interference by the following measure:

- Disconnect other devices and their input/output cables one at a time. If the interference stops, it is caused by either the other device or its I/O cable. These devices usually require Roland designated shielded I/O cables. For Roland devices, you can obtain the proper shielded cable from your dealer. For non Roland devices, contact the manufacturer or dealer for assistance.
- If your equipment does cause interference to radio or television reception, you can try to correct the interference by using one or more of the following measures:
 - Turn the TV or radio antenna until the interference stops.
 - Move the equipment to one side or the other of the TV or radio.
 - Move the equipment farther away from the TV or radio.
 - Plug the equipment into an outlet that is on a different circuit than the TV or radio. (That is, make certain the equipment and the radio or television set are on circuits controlled by different circuit breakers or fuses.)
 - Consider installing a rooftop television antenna with coaxial cable lead-in between the antenna and TV. If necessary, you should consult your dealer or an experienced radio/television technician for additional suggestions. You may find helpful the following booklet prepared by the Federal Communications Commission: "How to Identify and Resolve Radio — TV Interference Problems"

This booklet is available from the U.S. Government Printing Office, Washington, D.C., 20402, Stock No. 004-000-00345-4.

For Canada

CLASS B

NOTICE

This digital apparatus does not exceed the Class B limits for radio noise emissions set out in the Radio Interference Regulations of the Canadian Department of Communications.

CLASSE B

AVIS

Cet appareil numérique ne dépasse pas les limites de la classe B au niveau des émissions de bruits radioélectriques fixés dans le Règlement des signaux parasites par le ministère canadien des Communications.

 Roland®

26035231

UPC

26035231



J8991

Roland