

 Roland

MIDI GUITAR SYNTHESIZER

GR-700

Owner's Manual



OUTLINE OF GR-700

The Roland GR Guitar Synthesizer series all consist of synthesizer sections and special guitars called Guitar Controllers. The GR-700 is the Synthesizer

section that is compatible with any G-series guitar controller, 202, 303, 505 or 808, but GR-700 is the best choice for the most satisfactory result.

The following are the main features of the GR-700.

- * The GR-700 is a fully programmable, six voice synthesizer with the memory capacity that retains up to 64 different tone colors. And any patch program in memory can be recalled just by pressing the pedal switches.
- * Using the Memory Cartridge (M-16C) will expand the memory capacity by another 64 patches.
- * Tone color editing can be more easily done by using the optional programmer PG-200.
- * The GR-700 allows you to select which of the strings to take on each synthesizer effect.
- * The GR-700 can express even subtle playing technique according to the intensity of picking.
- * Many other attractive functions are featured, such as Chromatic Scale mode, Chorus effect, etc.
- * A large LED is helpful for synthesizing.
- * The MIDI OUT Connector allows the GR-700 to control other MIDI modules or instruments.

CONTENTS

1 Panel Descriptions	3	a. Editing without PG-200	14
2 Connections	6	b. Editing with PG-200	17
3 Problem caused by your improper playing manner	8	c. Parameter Table	18
4 Operation	9	5 Write Mode	24
1. Guitar Controller	9	a. Writing Operation	24
a. Controlling the Synthesizer Section	9	b. Copy Function	26
b. Adjustment of Output Level	10	6 Memory Cartridge	27
2 Play, Edit and Write Modes	11	a. Attaching the Memory Cartridge	27
3 Play Mode	11	b. Memory Cartridge and Internal Memory	27
a. Tuning	11	c. Patch transfer between Internal Memory and the Cartridge Memory	28
b. Tone Color Selection	12	d. Saving and Loading	29
c. Other Functions	13	7 MIDI	30
4 Edit Mode	14	5 Specifications	31

Before reading this manual, please read the separate volume "MIDI".

1 Panel Descriptions

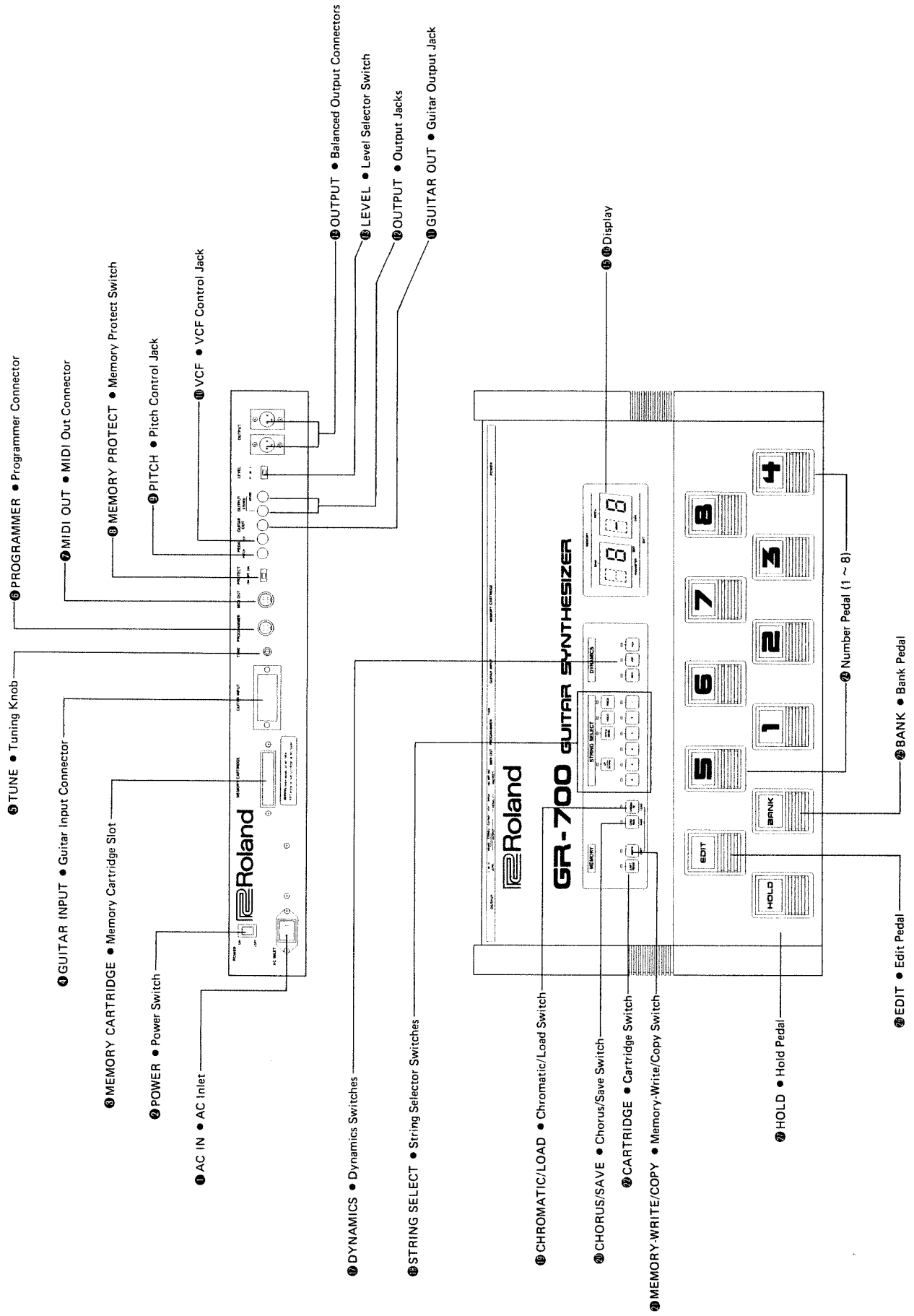

Radio and television interference

“Warning — This equipment has been verified to comply with the limits for a Class B computing device, pursuant to Subpart J, of Part 15, of FCC rules. Operation with non-certified or non-verified equipment is likely to result in interference to radio and TV reception.”

The equipment described in this manual generates and uses radio-frequency energy. If it is not installed and used properly, that is, in strict accordance with our instructions, it may cause interference with radio and television reception.

This equipment has been tested and found to comply with the limits for a Class B computing device in accordance with the specifications in Subpart J, of Part 15, of FCC Rules. These rules are designed to provide reasonable protection against such an interference in a residential installation.

However, there is no guarantee that the interference will not occur in a particular installation. If this equipment does cause interference to radio or television reception, which can be determined by turning the equipment on and off, the user is encouraged to try to correct the interference by the following measure:

- Disconnect other devices and their input/output cables one at a time. If the interference stops, it is caused by either the other device or its I/O cable.

These devices usually require Roland designated shielded I/O cables. For Roland devices, you can obtain the proper shielded cable from your dealer. For non Roland devices, contact the manufacturer or dealer for assistance.

If your equipment does cause interference to radio or television reception, you can try to correct the interference by using one or more of the following measures:

- Turn the TV or radio antenna until the interference stops.
- Move the equipment to one side or the other of the TV or radio.
- Move the equipment farther away from the TV or radio.
- Plug the equipment into an outlet that is on a different circuit than the TV or radio. (That is, make certain the equipment and the radio or television set are on circuits controlled by different circuit breakers or fuses.)
- Consider installing a rooftop television antenna with coaxial cable lead-in between the antenna and TV.

If necessary, you should consult your dealer or an experienced radio/television technician for additional suggestions. You may find helpful the following booklet prepared by the Federal Communications Commission:

“How to Identify and Resolve Radio-TV Interference Problems”

This booklet is available from the U.S. Government Printing Office, Washington, D.C., 20402, Stock No. 004-000-00345-4.

IMPORTANT NOTES

Power Supply

- The appropriate power supply for this unit is shown on its name plate. Please make sure that the line voltage in your country meets that.
- Please do not use the same socket used for any noise generating device (such as motor, variable lighting system).
- This unit might not work properly if turned on immediately after turned off. If this happens, simply turn it off and turn it on again a few seconds later.
- Before setting up the GR-700 with an external amplifier or the Guitar Controller, turn both of them off.
- This unit might get hot while operating, but there is no need to worry about it.

Cleaning

- Use a soft cloth and clean only with a mild detergent.
- Do not use solvents such as paint thinner.

Location

- Operating the GR-700 near a neon or fluorescent lamp may cause noise interference. If so, change the angle or the position of the GR-700.
- Avoid using the GR-700 in excessive heat or humidity or where it may be affected by direct sunlight or dust.

Repairing

- Save the necessary data on a cartridge before having the GR-700 repaired, in case it happens to be accidentally erased.

2 CONNECTIONS

* Before making or breaking connection, be sure to turn all the units off.

Setting up the Guitar Controller

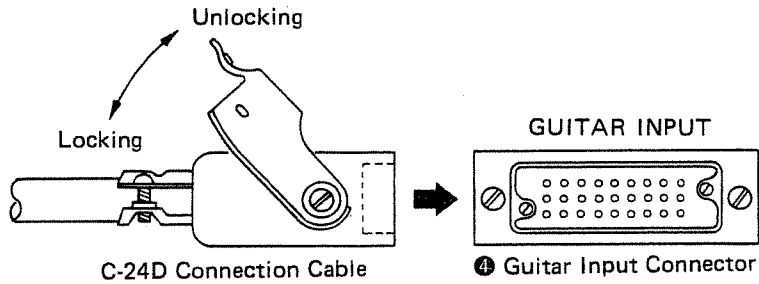

1. Guitar Input Connector ④

Connect the Guitar Controller here by using the supplied cable C-24D.

2. Output Jack ⑫

These jacks are used to connect an amplifier. When these are the only output jacks used, mixed sound of direct and synthesizer will be obtained. To fully benefit the advantages of the GR-700, use keyboard amplifiers and speakers, PA, or audio equipment. If two amplifiers are used (stereo), chorus effect will sound more effective. (See page 13.)

3. Level Selector Switch ⑬

With this switch, select an appropriate output level depending on the type of the amplifier you use. The knack is to select the position that allows undistorted sound of desirable level with the amplifier's volume set to 5 to 7.

4. Guitar Output Jack ⑪

This jack is provided to connect a guitar amplifier. Through this jack, only direct guitar sound is sent out. Also, a preamplifier is built in here, therefore, good result can be expected when an effect device or foot volume is used. If both this jack and the Output Jack ⑫ are used at the same time, only the synthesizer sound is output through the Output Jack ⑫.

Setting up the Amplifiers

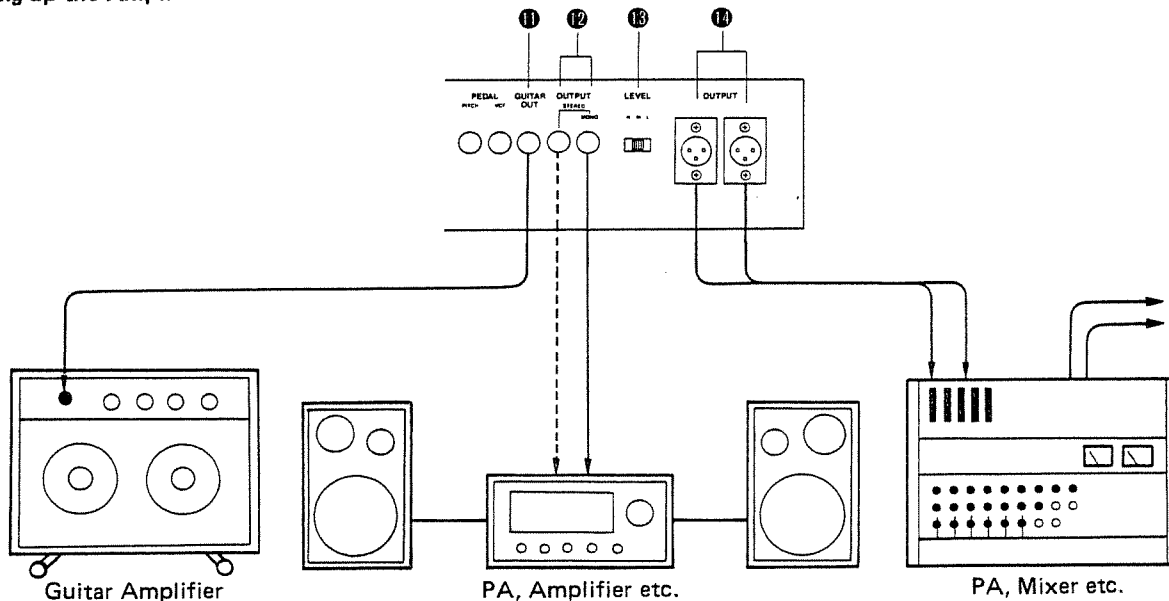

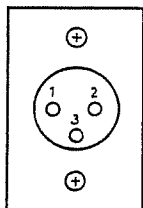

14 Balanced Output Connector

5. Balanced Output Connectors 14

These are used for setting up the GR-700 with the balanced type mixer or effect device. The signal sent out through these connectors are the same as the output jacks 12, but the maximum output level is 0dB regardless of the position of the Level Selector Switch 13. If setting up in monaural, be sure to mix the signals of both channels.

Also, the output from this connector is transformless, so to convert it into unbalanced output, keep the 2nd pin open.

6. Programmer Connector 6

Connect the programmer PG-200 here by using the supplied 6P DIN Cord.

7. MIDI OUT Connector 7

This is to connect a MIDI sound module. Use the optional MIDI Sync Cable MSC-25 or 50.

8. Pitch Control Jack 9 and VCF Control Jack 10

By connecting the Foot Volume FV-200 (BOSS), you can control the pitch and VCF Cutoff by depressing the pedal.

Connecting a Volume Pedal

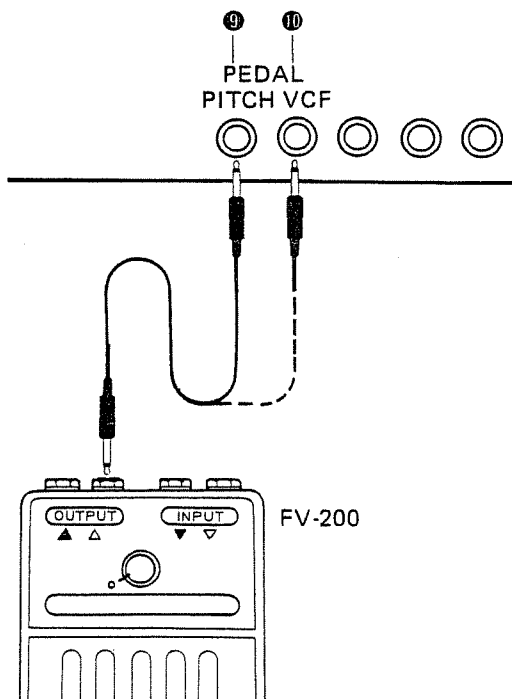

- * Connect to the output jack of the FV-200.
- * Set the Minimum Volume of the FV-200 to zero.
- * Remove the spring from the spring holder of the FV-200. (Refer to the operation manual of the FV-200 to see how to remove it).
- * While not using the FV-200, set the pedal to its highest position.

3 PROBLEMS CAUSED BY YOUR IMPROPER PLAYING MANNER

The GR-700 digitally processes the vibration of the strings producing digital signal that controls each section of the synthesizer. This is in other words, even the string vibration inaudible in usual guitar performance is bound to be processed.

a. Sound Delay

The GR-700 reads the waveform of the string vibration then detects the pitch by its computer. The lower tone (slower vibration) needs more time for pitch detection, resulting in sound delay. The open 6th string (E) requires at least 25 ms (0.025 seconds.) The sound delay is also caused by a certain playing manner, because the GR-700 is designed not to output sound until the string vibration has become stable, to obtain accurate pitch.

b. Unstable Pitch

If you have played a long tone with high fret, the created string vibration will be extremely feeble. Therefore, pitch detection is impossible, resulting in unstable pitch. The solution is playing the guitar in the low position.

c. Sound cannot be muted

If you have played tremolo, or repeated an open chord or muteless stroke with the 5th or 6th string, the created sound may not be muted.

Therefore, you may be annoyed by unexpected reaction of the guitar controller when playing it. The following are possible symptoms and how to resolve them.

d. Irrelevant sound is heard

The GR-700 processes even the string vibration irrelevant for deciding pitch. Therefore, you need a special care for picking.

e. No sound is heard

When the vibrating time of the string is short or the pitch is ambiguous, or you have not picked or touched the string hard enough, pitch detection is difficult. Watch that your picking is hard enough.

*** Harmonics playing**

Avoid playing in harmonics manner, if possible. The problems are often caused by feeble string vibration in harmonics manner.

4 OPERATION

1. Guitar Controller

a. Controlling the Synthesizer Section

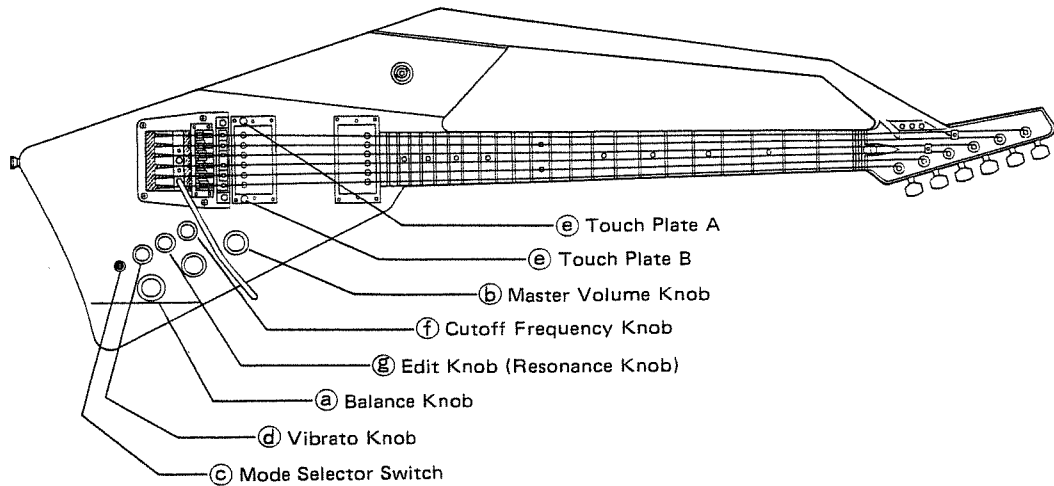

1) Balance Volume Knob (a)

With this knob turned fully counterclockwise, only direct guitar sound is obtained. As you rotate it clockwise, synthesizer sound will be increased and at its fully clockwise position, only synthesizer sound will be heard.

2) Master Volume (b)

This knob sets the overall volume.

3) Mode Switch (c)

At I position (GR-707) DIST (other G series)	Only direct guitar sound is obtained, and the Balance Knob (a) does not work.
At II position (GR-707) VCO + DIST (other G series)	Both direct and synthesizer sounds are available. Suitable for long tone.
At III position (GR-707) VCO (other G series)	Both direct and synthesizer sounds are available. Suitable for quick phrase, but wrong picking and touching affects the performance more than other positions.

* When the GR-700 is used, distortion sound is not available.

4) Vibrato Knob (d) and Touch Plate (e)

By using these knobs, you can add vibrato effect. Slightly raise the Vibrato Knob (d) and touch the Touch Plate A while holding the strings down. To stop vibrato, touch the Touch Plate B and immediately release it.

* If the Vibrato Knob (d) is set to zero, no vibrato is obtained at all. That is, you are not annoyed by unexpected Vibrato effect caused by touching the Touch Plate accidentally.

* The rate, delay time and depth of the vibrato effect work at its set level in writing. (Refer to page 20.)

5) Cutoff Frequency Knob (f)

6) Edit Knob (Resonance Knob in other G series) (g)
These knobs work exclusively in Edit mode.

* The Cutoff Frequency Knob (f) is provided specifically for controlling the VCF Cutoff Frequency.

* The Edit (Resonance) Knob (g) is used to control parameters except for the cutoff frequency.

* Refer to the owner's manual of each guitar controller for the other control knobs.

b. Adjustment of Output Level

The GR-700 is designed to be used with any G-series guitar controller. If, however, using the controller other than the G-707, or have changed the gauge of the strings, you may have to readjust the output level of the guitar controller.

If the output level of the guitar controller is not appropriate, the following troubles may be caused.

< Excessive Output Level >

- The pitch is unstable.
- The sound of irrelevant strings are heard.

< Unsufficient Output Level >

- No sound is heard unless you play the guitar hard.
- The sound does not last.

If you are annoyed by any of above troubles, see page 8 "Problem caused by improper playing manner" to solve the trouble. If the trouble still remains or only one string is in trouble, the following readjustment is required.

1. Adjust the height of the Divided Pickup as shown upper right.
2. Open the cover on the bottom of the guitar controller and rotate the knob to adjust the output level of each string.

* This level adjustment is a delicate task, so please do it in slight steps.

Adjusting the Output Level of the Guitar

- By changing the height of the Divided Pickup

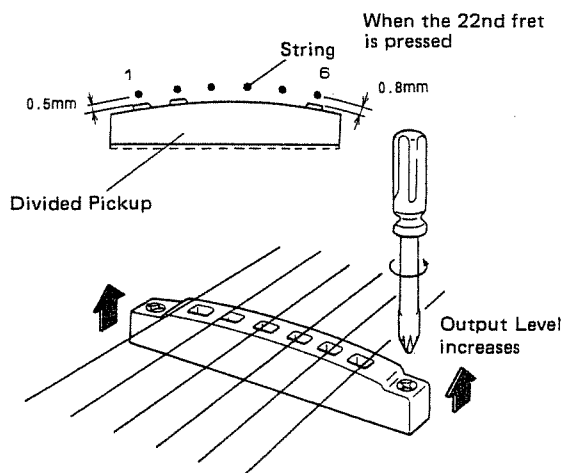

- By rotating the VR's

- G-202

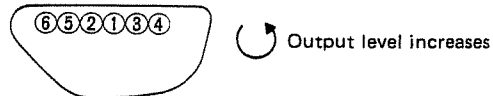

- G-303, 808

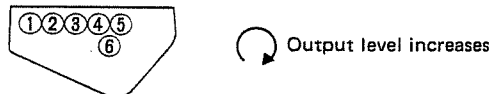

- G-505



- G-707

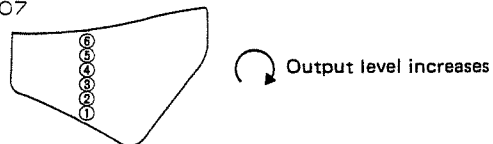

2. PLAY, EDIT & WRITE Modes

Set up the GR-700 with amplifier and speaker, etc., and power it up, and it will be ready to play. (= PLAY Mode)

There are 64 different tone colors preprogrammed (8 banks x 8 patch numbers) as shown right. And you can recall any of those patches and edit it as you like. (= EDIT Mode) This editing operation, however, does not automatically rewrite the existing patch program.

If you wish to write the edited program, and appropriate writing operation is required. Writing a new patch program, however, replaces the one currently written. (= WRITE Mode)

3. PLAY MODE

a. Tuning

The following three places should be tuned.

- 1 Guitar's strings
- 2 Synthesizer sound
- 3 Synthesizer sound in the Chromatic Mode

Operation for 1

Tune the guitar's strings with a tuner or other musical instrument.

Operation for 2

Listening to both normal and synthesizer sounds of the guitar, tune the GR-700 by rotating the Tune Knob on the rear panel.

* This tuning operation should be done with the Chromatic Switch 19 and the Chorus Switch 20 turned off.

* Use a tone color suitable for tuning, such as factory preset patch 4-8.

Now, the synthesizer sound is tuned with the guitar's strings.

	Patch							
Bank	1	2	3	4	5	6	7	8
1								
2								
3								
4								
5								
6								
7								
8								



is a Program of Bank 5, Patch Number 6. (5-6)

Operation for 3

Press the Edit Pedal to turn the GR to the Edit Mode. By pressing the Number Pedals 24, select the parameter number 48. Then, by using the Edit (or Resonance) Knob, tune the pitch of the synthesizer sound to the guitar's normal sound.

* This operation should be done by using an open string. (The number of the string picked is shown in the Display 16.)

Now, all are tuned up.

Pitch Adjustable Range : A = 438 to 446

b. Tone Color Selection

There are 64 different tone colors preprogrammed in the GR-700's memory (8 banks x 8 patch numbers) by manufacturer. When the GR-700 is first turned on, a patch program of bank 1, patch number 1 is called, the Display Windows showing "1 - 1". The Display changes as you call other tone color.

- 1) Assign the patch number of the tone color you want to call by pressing the corresponding Number Pedal 24 (1 to 8).
- 2) Press the Bank Pedal 25 first, then the Number Pedal 24 corresponding with the bank number you wish to assign.

How to call a patch program

* Either operation of 1) or 2) can be done first.

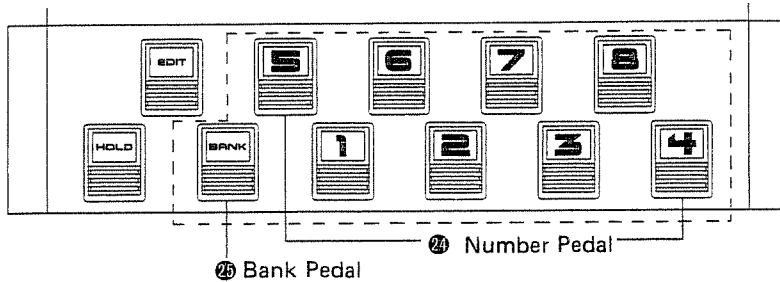

Operation	Display	Reaction
Power ON		Patch Program "1 - 1" is initially called.
Set Patch No. 3		Patch Program "1 - 3" is called.
Set Patch No. 8		Patch Program "1 - 8" is called.
Set Bank No. 4		Bank Number "1" flashes.
Set Bank No. 5 & Patch No. 6		Patch Program "4 - 8" is called.
		Bank Number "4" flashes.
		Patch Program "5 - 8" is called.
		Patch Program "5 - 6" is called.

c. Other Functions

1) Hold Pedal 27

Press the Hold Pedal 27, and the Display will show "H", and the sound currently in use will be held at its sustain level as long as the Pedal is depressed.

* This Hold function cannot be obtained if the sound in use has low sustain level or "HOLD" is not set in the String Select operation which will be described later in this manual.

The Panel Switches 17 to 22 are On/Off switches which can be used to add extra effects to the existing tone color. These switches work whatever mode the GR-700 is set to. Simply press the switch, and it will alternately turn on or off. When the switch is turned on, the indicator lights up.

* Each effect set with the Panel Switches can be written into memory by taking writing procedure explained on page 24.

Panel Switches

Indicator

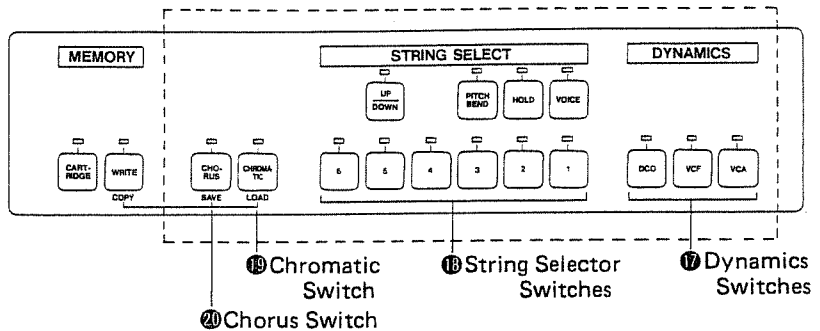

2) Chorus Switch 20

Press this switch to turn on the Chorus effect. Pressing it again will turn off. To benefit the best possible chorus effect, use two amplifiers, if possible.

5) String Selector Switches 18

Use these switches to select which of the string(s) should take on the Voice, Hold, or/and Pitch Bend function(s) work. 1 to 6 correspond to 1st to 6th strings.

3) Chromatic Switch 19

The Guitar Synthesizer is designed to pick up even the delicate pitch difference, but when this switch is on, the scale becomes chromatic (= temperament) like the keyboard's.

* In the Chromatic mode, accurate tuning of each string is required, because the synthesizer sound chromatically falls on the note that is nearest to the string's pitch. Also, pitch bending or glissando effect changes chromatically.

VOICE	Depress this switch, then by pressing the corresponding String selector Switch(es), select the string(s) which should take synthesizer voice.
HOLD	Depress this switch, then select the string(s) on which the Hold function works.
PITCH BEND	Depress this switch, then select the string(s) on which the Pitch Bend function works.
UP DOWN	Depress this switch to select Up or Down mode of the Pitch Bend function. (The indicator lights up when the Up mode is selected.) If the Pitch Bend Switch described above has been turned on, and the Up mode is selected pressing the Foot Volume will raise the pitch. And in the Down mode, the other way round.

4) Dynamics Switches 17

By using these switches, each DCO, VCF and VCA section can take on the Dynamics effect.

* The intensity of the Dynamics is set by each ENV modulation. (See "C. Parameter Table" on page 19, 21 and 22.)

4. EDIT MODE

Like any usual synthesizer, the GR-700 has various parameters (32 kinds) which can be edited for sound synthesis. The GR-700, however, does not feature knobs or switches on its panel for you to touch or move. Instead, there are two methods of synthesizing. One is using the optional programmer PG-200 which works just like panel controls of a usual synthesizer. Another is calling each parameter by using the Pedal Switches and changing its value

a. Editing without PG-200

The GR-700 has 32 different parameters, and each parameter has a number of 11 to 48. Call the parameter you wish to edit by assigning its number. Then change the value of the parameter by using the Edit (Resonance) Knob.

by using the controls on the Guitar Controller. For quicker and easier editing or synthesis from scratch, the PG-200 may be essential.

* This Editing function does not automatically rewrite the existing program, unless the appropriate procedure for rewriting (See page 24.) is done.

* See the Edit Map to find out the number of the parameter. The Edit Map is identical to the PG-200's control panel.

■ EDIT MAP

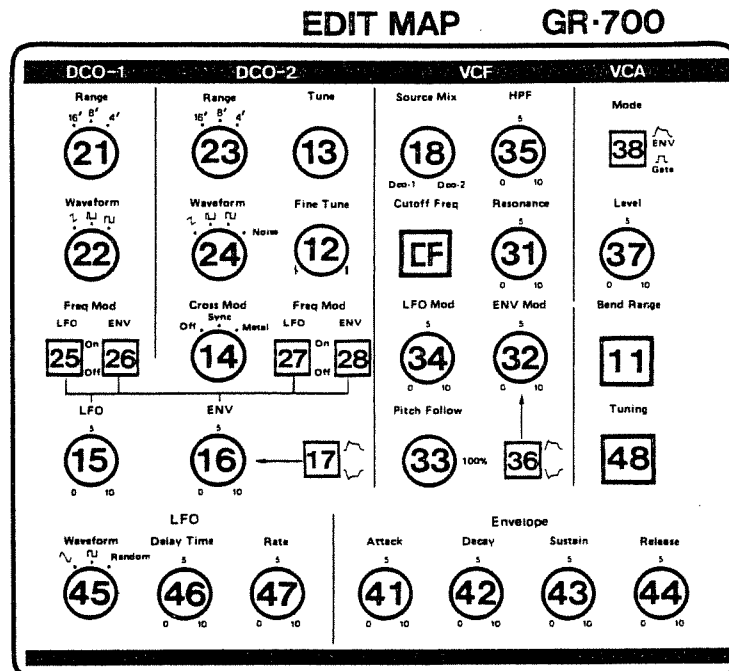

① Call a patch program you wish to edit, by using the Bank and Number Pedals.

② Press the Edit Pedal  to turn the GR-700 to the Edit mode. The Display shows " [F] × × ". " [F] " means cutoff frequency, and " × × " is its value. Now, rotating the Cutoff Frequency Knob on the guitar controller will change the value of the cutoff frequency, therefore altering the tone color, causing the value shown in the Display to change.

* If you do not wish to change the value of the cutoff frequency, skip the step ② and go directly to the step ③.

e.g. Cutoff Frequency



Call the parameter 38 (VCA mode)

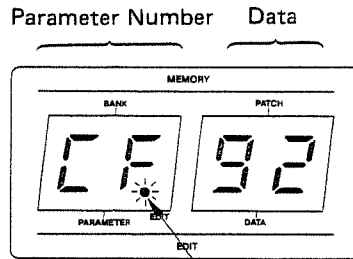
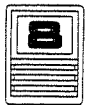

This dot flashes during editing.

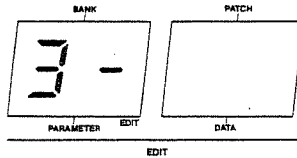

" [F] " goes out, and " - " flashes.

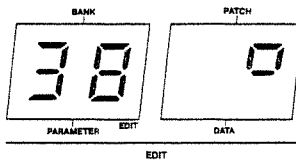







The right window shows that the Slide Switch is on ().
ENV

- ③ Assign the number of the parameter you wish to edit, by pressing the relevant Number Pedal ②④. The first pressing will change the left figure, then the Display Window ①⑤ shows a flashing bar “ — ” on the right asking you to set the right side number. The Display Window ①⑥ shows the data value of the parameter.
- ④ While actually listening to the sound, adjust the parameter by using the Edit (Resonance) Knob. Here, the Display will respond as shown below.
- ⑤ By repeating procedure ③ and ④, keep on synthesizing.

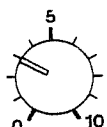
[NOTE]

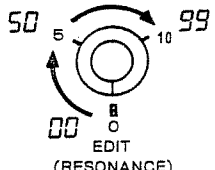
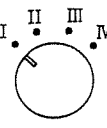
When any slight editing is done, the “ ● ” flashes indicating that the tone color currently in use is different from the one in memory. This indication helps you to understand that the edited tone color is not yet written into memory. If you wish to write the edited tone color, take an appropriate writing procedure. If you do not want to retain the edited tone color, simply call any other patch program. (Just note that calling a patch program can be done only in the Play mode.) To turn the GR-700 from Edit to Play mode, simply press the Edit Pedal ②⑤.

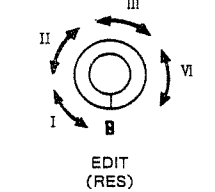
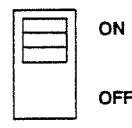
Data Display and Setting a Value

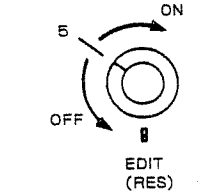
	Programmer	Data Display	Setting a Value
1	Knob 	Knob Position 0 ~ 5 ~ 10 	
2	Rotary Switch 	Switch Position I II III IV 	
3	Slider Switch 	Switch Position ON OFF 	

(): When using the controller other than the G-707.

b. Editing with PG-200

The optional programmer PG-200 can considerably simplify the editing operation. The PG-200 works like the control panel of a usual synthesizer, that is, you can edit the existing patch program or make a complete new patch from scratch, by actually using the tangible knobs and buttons.

* The function of each parameter and the reaction of the synthesizer are explained in a table from page 18 to 24.

* For hook-up, use the 6 pin DIN cable (2.5m) of the GR-700.

* Also, the PG-200 functions whatever mode the GR-700 may be set to. (Play, Edit, Manual or Write).

1) Play Mode

When the GR-700 is in this mode, editing with the guitar controller is not possible. You need the PG-200. While you are editing, the "●" will flash.

2) Edit Mode

Turn the GR-700 to the Edit mode by pressing the Edit Pedal, then assign the parameter number, and you can see the current value of the parameter in the Display ⑩.

3) Manual Mode

Pressing the Manual Button on the PG-200 will turn the GR-700 to the Programmer mode. The Display Window ⑩ shows . In this mode, the whole panel setting of the PG-200 decides the tone color. That is, now, existing patch program in memory has nothing to do with your sound synthesis. You make a new patch from scratch. This mode is cancelled when you select any other patch program, or a new program is written.

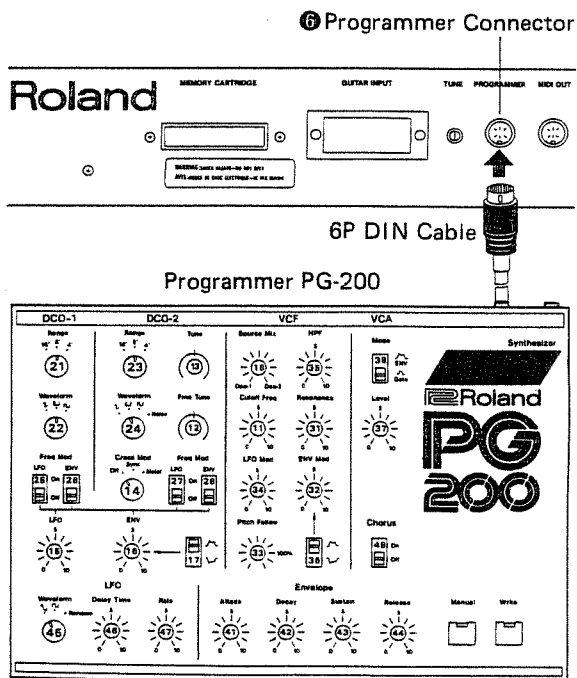

* The edited patch program, either with the guitar controller or with the PG-200, cannot be retained unless a proper wiring procedure is taken.

* While editing a parameter with the PG-200, even if the current set positions of the knobs or switches are exactly what you desire, change the position once then return it. Otherwise, the parameter data might not be affected by the PG-200 at all, thereby remain unchanged.









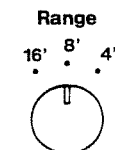
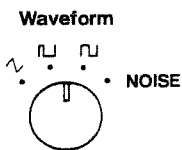
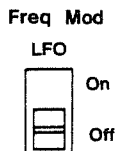
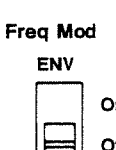

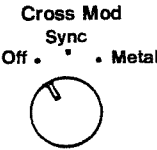
c. Parameter Table



DCO (Digitally Controlled Oscillator)

DCO is the digitally controlled oscillator that controls the pitch and generates the waveforms that are the sound source of the synthesizers. Owing to its digital control system, this offers superior pitch

stability compared to the VCO (Voltage Controlled Oscillator).

Programmer (PG-200)	Function	Display	
Parameter		Parameter Number	Parameter Value
<p>Range</p> 	<p>This is to change the pitch range of the DCO in exact one octave steps from 4' to 16' (4', 8', 16'). 8' is standard.</p>	<p>DCO-1 21</p>	<p>16' 8' 4'</p>
<p>Waveform</p> 	<p>This is to choose the output waveform of the DCO. Select □ for pulse width modulation. [NOTE 1]</p>	<p>DCO-1 22</p>	<p>Waveform icons: sine, square, pulse width modulation, NOISE</p>
<p>Frequency Modulation (LFO switch)</p> 	<p>When ON is selected, the LFO Section controls the frequency (pitch) of the DCO. To adjust the depth of modulation, use the ENV Depth Knob and the Polarity Switch. Select ~ for vibrato effect. [NOTE 2]</p>	<p>DCO-1 25 DCO-2 27</p>	<p>On Off</p>
<p>Frequency Modulation (ENV switch)</p> 	<p>When ON is selected, the ENV signal controls the frequency (pitch) of the DCO. To adjust the depth of the modulation, use the Polarity Switch.</p>	<p>DCO-1 26 DCO-2 28</p>	<p>Off</p>

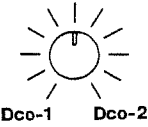
<p>Cross Modulation</p> 	<ul style="list-style-type: none"> • Sync: The frequency of the DCO-2 synchronizes with that of the DCO-1. The fundamental of the DCO-2 is decided by that of the DCO-1. Therefore, you can generate a unique waveform that is impossible to obtain by "Off" setting. • Metal: By controlling the DCO-1 with the output signal from the DCO-2, ring modulation style sound can be obtained. • Off: Each DCO-1 and DCO-2 can have different pitch and waveform. [NOTE 3] 		<p>Off 111</p> <p>14 Sync 111</p> <p>Metal 111</p>
<p>Fine Tune</p> 	<p>The frequency (pitch) of the DCO-2 can be adjusted with this parameter.</p> <ul style="list-style-type: none"> • Variable range . . . ± 15 cent (438 ~ 446 Hz) 	12	
<p>Tune</p> 	<p>This adjusts the frequency (pitch) of the DCO-2.</p> <ul style="list-style-type: none"> • Variable range . . . Approx. ± 1200 cent (1 octave) 	13	00
<p>LFO Depth</p> 	<p>When the LFO output is modulating the DCO, this parameter is used to adjust the depth of the modulation.</p>	15	99
<p>ENV Depth</p> 	<p>When the ENV output is modulating the DCO, this parameter is used to adjust the depth of the modulation.</p>	16	
<p>Polarity Switch</p> 	<p>This selects the polarity of the Envelope curve. Normally,  is used. In  mode, the ADSR patterns will be all inverted, therefore, pitch alteration, too. The depth of the modulation is adjusted with the ENV Depth.</p>	17	 

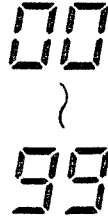
<p>Source Mix</p> <p style="text-align: center;">Source Mix</p> 	<p>This is used to adjust the volume balance between the DCO-1 and DCO-2.</p> <p>In the center position (approx. value 50), the volumes of the DCO-1 and DCO-2 are equal.</p>		
--	---	---	---

[NOTE 1]

Pulse width modulation is done only in the DCO-2. The necessary procedures are as follows.

- ① Set the Cross Mod to the SYNC position.
- ② Set the Source Mix to fully clockwise so that you can hear only the DCO-2 sound. (Turn it toward DCO-1, when the DCO-1 sound is necessary.)
- ③ By rotating the Tune Knob, you can change the pulse width. In its center position, the pulse width is 50% (square wave).

[NOTE 2]

When you control the vibrato effect by using the Touch Plates A and B of the Guitar Controller, set this switch to the Off position.



The rate of the vibrato is to be set with the Rate Knob beforehand.





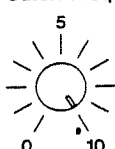

[NOTE 3]

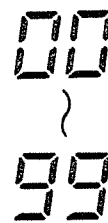
The waveform of the DCO-2 will be always a saw tooth (\nearrow).

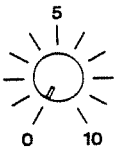
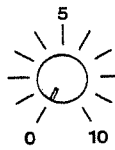
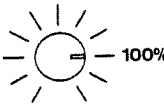
VCF (Voltage Controlled Oscillator)

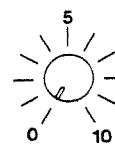
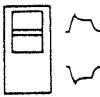
The output signal goes to the Source Mix then to the VCF to be filtered. Each VCF lets lower frequency harmonics pass and cuts off the higher ones. In other words, it is a usual low pass filter. By controlling the cutoff point and resonance, the waveform changes, thereby the tone color alters.

Programmer (PG-200)	Function	Display	
Parameter		Parameter Number	Parameter Value
<p>Cutoff Frequency</p> <p style="text-align: center;">Cutoff Freq</p> 	<p>This parameter is for changing the cutoff point of the VCF. As you rotate the knob clockwise, cutoff frequency will come down, and the waveform gradually becomes approximation of a sine wave, then the sound will fade out.</p>		

<p>Resonance</p> <p>Resonance</p> 	<p>This parameter is used to emphasize the cut-off point. As you increase the value, the created sound will become more unusual, more electronic in nature.</p>	<p>31</p>	
<p>ENV Modulation</p> <p>ENV Mod</p> 	<p>This parameter is used to control the cutoff point of the VCF in each note with the ENV curve set in the ENV section. As you increase the value, tone color within one note changes more drastically.</p>	<p>32</p>	
<p>Pitch Follow</p> <p>Pitch Follow</p> 	<p>This parameter can shift the cutoff point depending on the pitch. In the "100%" position, it prevents any inconsistency in the harmonic contents caused by pitch alteration.</p> <ul style="list-style-type: none"> ● Parameter value 92 ⇒ 100% 	<p>33</p>	<p>00 99</p>
<p>LFO Modulation</p> <p>LFO Mod</p> 	<p>This parameter is used to control the cutoff point by the waveform of the LFO section. Rotating the knob clockwise deepens the modulation.</p>	<p>34</p>	
<p>HPF Cutoff Frequency</p> <p>HPF</p> 	<p>The HPF (High Pass Filter) is a filter that passes higher frequency harmonics and cuts off the lower ones. As you increase the value, cutoff point goes up, lower frequency harmonics being cut off.</p>	<p>35</p>	
<p>Polarity Switch</p> 	<p>This is to select the polarity of the Envelope curve. Usually  may be used. In  mode, ADSR pattern will be inverted, so as the tone color alteration is. The depth of the ENV curve is adjusted with the ENV Modulation Knob.</p>	<p>36</p>	<p> </p>

VCA (Voltage Controlled Amplifier)

After filtered in the VCF, the signal is fed to the VCA where the volume (amplitude) of the sound is controlled.

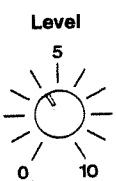
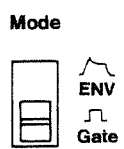
Programmer (PG-200)	Function	Display	
		Parameter Number	Parameter Value
VCA level 	This is to adjust the volume level, and can be effectively used in the writing mode. [NOTE 4]	37	00 99
VCA mode 	This is to select whether to control the VCA by the signal from the ENV (ENV waveform) or by the Gate signal (Gate waveform).	38	0 0

[NOTE 4]
Setting this VCA level too high may cause sound distortion.

LFO (Low Frequency Oscillator)

This oscillator generates extremely low frequency, so produces a vibrato or growl effect by controlling the DCO or VCF.

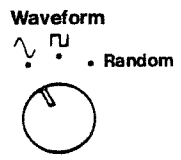
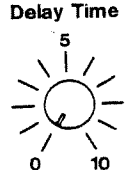
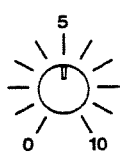
LFO Waveform 	This is for selecting the LFO output waveform.	45	~ ~ ~ ~ Random ~ ~
Delay Time 	This sets the time needed for the modulation by the LFO to start.	46	00 99
Rate 	This sets the rate (frequency) of the LFO.	47	99

[NOTE]
Even when the LFO Modulation Depth Knob is set to zero and the LFO Switch to the OFF position currently, you should not neglect the setting of each

parameter of the LFO Section. Because, each parameter is ready to work at its setting level when the vibrato is turned on by using the Touch Plates A and B of the Guitar Controller.

ENV (Envelope Generator)

This generates the control voltage (Envelope) which controls the DCO, VCF and VCA, therefore, alters the pitch, tone color and volume in each note.

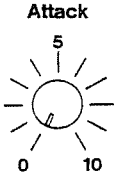
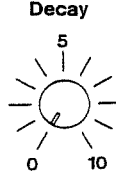
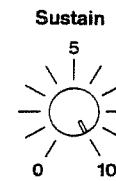
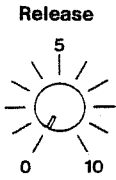
<p>Attack Time</p> <p style="text-align: center;">Attack</p> 	<p>This determines the time required for the voltage to reach its maximum from the moment the String is picked.</p>	41	00 } 99
<p>Decay Time</p> <p style="text-align: center;">Decay</p> 	<p>This determines the time required for the voltage to drop from the maximum to the sustain level.</p>	42	
<p>Sustain Level</p> <p style="text-align: center;">Sustain</p> 	<p>This sets the sustain level to which the voltage falls at the end of the decay time. Therefore, when this knob is set to "10", the setting of the Decay Time has no effect.</p>	43	
<p>Release Time</p> <p style="text-align: center;">Release</p> 	<p>This sets the time needed for the voltage to reach zero from the moment the String vibration stops.</p>	44	

Chorus

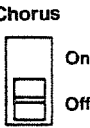
Programmer	
<p>Chorus</p> <p style="text-align: center;">Chorus</p> 	<p>This is to produce rich and expansive sounds. If this is turned on, a chorus effect is obtained.</p>

Parameter	Display	
	Parameter Number	Data
Pitch Control When the Pitch Control Jack ⑨ is used, this sets the maximum range of the Pitch Bend effect (with the pedal) from 1 to 7 (perfect 5th) in semitone steps. [NOTE 5]	11	0 (-) 7
Tuning Use this parameter to change the standard pitch of the synthesizer sound in the chromatic mode. [NOTE 5] (Refer to "a. Tuning" on page 11.)	48	

[NOTE 5]

These parameters cannot be edited with the PG-200.

5. Write Mode

a. Writing Operation

1) Writing the edited tone color into the same patch program number

- ① Set the Memory Protect Switch ⑧ to the OFF position.
- ② Turn the GR-700 to the Write mode by pressing the Memory Write Switch ⑫ or the Write Button on the PG-200. (The Memory Write Switch ⑫ lights up.)
The Display Windows show the Bank and Patch numbers of the original patch program and 0 starts flashing.
- ③ Press a Number Pedal ⑳ assigning the same patch number that is shown in the Display Window ⑮.
- * Now, writing is completed and the GR-700 is automatically turned to the Play mode.
- ④ Set the Memory Protect Switch ⑧ to the ON position.

2) Writing an edited tone color into other program number.

① Take the same procedures ① and ② of “1) Writing the edited tone color into the same patch program number.”

② Set the Bank number by pressing the Bank Pedal ⑫ then the relevant Number Pedal ⑬.

③ Set the Patch number by pressing the relevant Number.Pedal ⑬.

* Now, writing is completed and the GR-700 is automatically turned to the Play mode.

④ Set the Memory Protect Switch ⑧ to the ON position.

* Even if you happen to set a wrong Bank number in procedure ②, you can cancel it by simply pressing the Bank Pedal ⑫ again and set a correct one. This is because writing is not done until you set the Patch number.

* If you happen to press the Memory Write Switch ⑪ by mistake, simply press the switch again, and the Write mode will be cancelled.

* If the Bank Number shown in the right Display Window is what you desire, you can skip the procedure ②.

* If the Memory Protect Switch ⑧ is set to the ON position, writing is not done. The Display Windows show **Pr** **ot** right after writing procedure. If so, repeat procedure ②, ③ and ④.

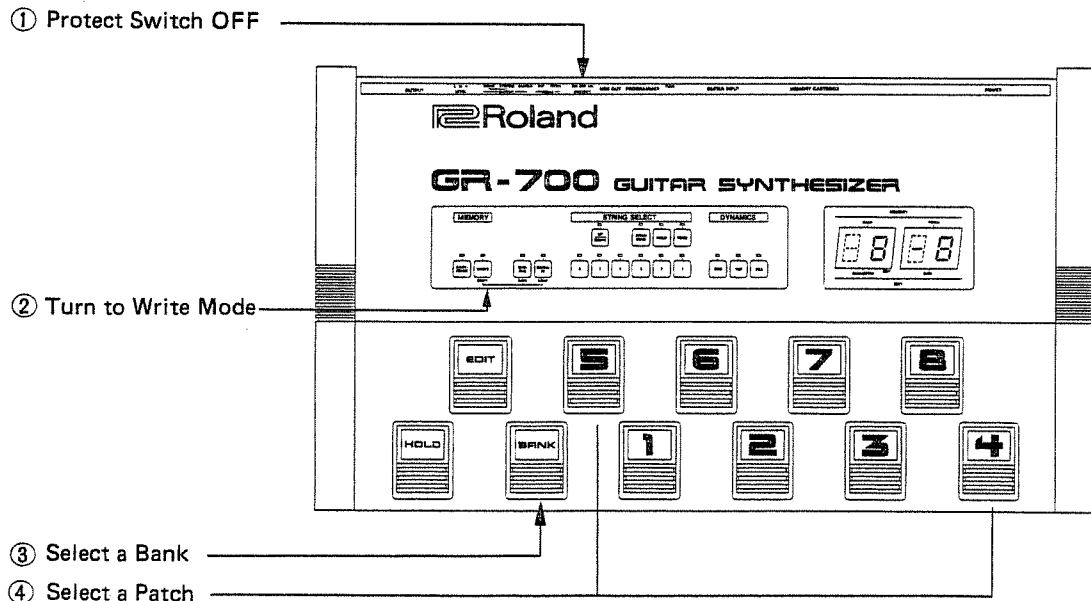

b. Copy Function

By using the Copy function, you can collect your favorite tone colors in one bank or change the places of the patch programs, etc. This copying operation, however, inevitably sacrifices one patch program.

- ① With the GR-700 in the Play mode, call the patch program number where you wish to transfer a tone color. In other words, assign the new place for the tone color. Here, if you do not want to lose the tone color written in that patch program number, you must write it somewhere else. To do that, turn GR-700 to the Write mode and write this tone color into the patch program number which you do not mind losing, by taking a usual writing operation. (If you do not remember how to write a tone color, refer to page 24.)
- ② Call the patch program you wish to transfer, then turn the GR-700 to the Write mode, and write it into a new place.

[NOTE]

Present patches 1–1 to 4–8 (32 patches) can be restored even if lost, but those of 5–1 to 8–8 (32 patches) can never be retrieved. (Refer to Sample Sound Table.)

To restore the lost patch programs, set the Memory Protect Switch **Ⓚ** to the OFF position, then press the Bank Pedal **Ⓛ** while holding the Memory Write Switch **Ⓜ** down.

Now, the whole set of 32 original preset patches 1–1 to 4–8 are restored, naturally, erasing the existing tone colors. Finally, set the Memory Protect Switch **Ⓚ** to the ON position.

(e.g.)

Copying patch program 2–1 to 1–2, keeping the tone color of 1–2, abandoning 2–4.

- ① Call 1–2 then write it to 2–4.
- ② Call 2–1 then write it to 1–2.

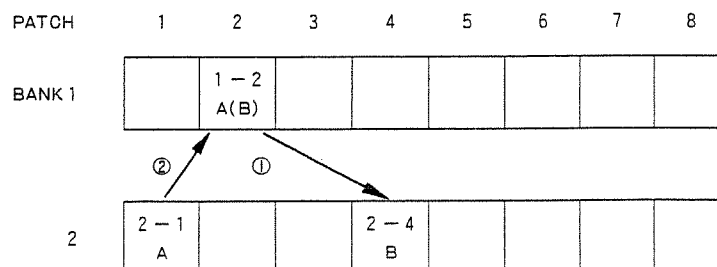

6. Memory Cartridge

The Memory Cartridge M-16C, which has the same memory capacity as the internal memory of the GR-700, expands the available patch programs up to 128. The Memory Cartridge adopts battery back-up system, and the battery will last for 5 years since it is released from the manufacturer.

a. Attaching the Memory Cartridge

Insert the cartridge securely into the Memory Cartridge Holder ④ of the GR-700 with the Protect Switch on the cartridge facing upward. (See the picture shown below.)

b. Memory Cartridge and Internal Memory

- 1) Each time you press the Cartridge Switch ⑫, the Internal Memory and the Cartridge Memory modes are alternately selected.

When it is the Cartridge mode, [C] is shown on the left of the Bank number display ⑬.

- 2) Patch selection and writing procedures are exactly the same as when the internal memory is in use.
- 3) Even after the internal memory and the cartridge memory are exchanged, the previous patch program still remains unless a new patch is assigned.

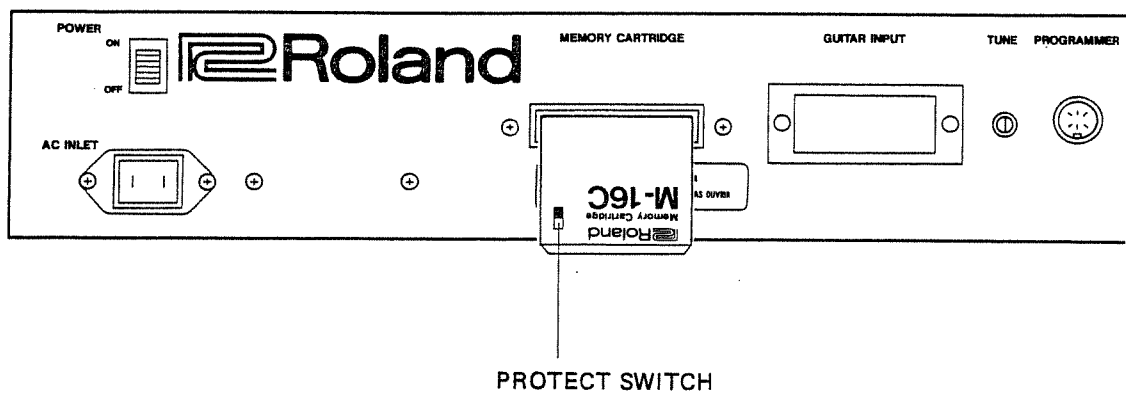

c. Patch Transfer between Internal Memory and the Cartridge Memory

1) If you wish to transfer a patch program in the GR-700's memory onto the Memory Cartridge, do as follows.

- ① Call an internal patch program you wish to transfer to the cartridge.
- ② Turn Cartridge Switch ⑫ on.
- ③ Press the Memory Write Switch ⑮ to turn the GR-700 to the Write mode.
- ④ Set the Protect Switch on the Memory Cartridge to the OFF position.
- ⑤ Assign the Patch Program number on the cartridge where you wish to transfer the patch program from the internal memory, by using the Bank Pedal ⑭ and Number Pedal ⑯.
- ⑥ Set the Protect Switch of the Memory Cartridge to the ON position.

2) If you wish to transfer a patch in the Memory Cartridge into the internal memory of the GR-700, do as follows.

- ① Turn the Cartridge Switch ⑫ on, then call the patch program you wish to transfer to the internal memory.
- ② Set the Memory Protect Switch ⑧ to the OFF position.
- ③ Press the Memory Write Switch ⑮ to turn the GR-700 to the Write mode.
- ④ Assign the internal patch program numbers where you wish to transfer the patch program from the Memory Cartridge, by using the Bank Pedal ⑭ and the Number Pedal ⑯.
- ⑤ Set the Memory Protect Switch ⑧ to the ON position.

* The moment the Patch number is assigned, writing is done, then the GR-700 is automatically turned to the Play mode.

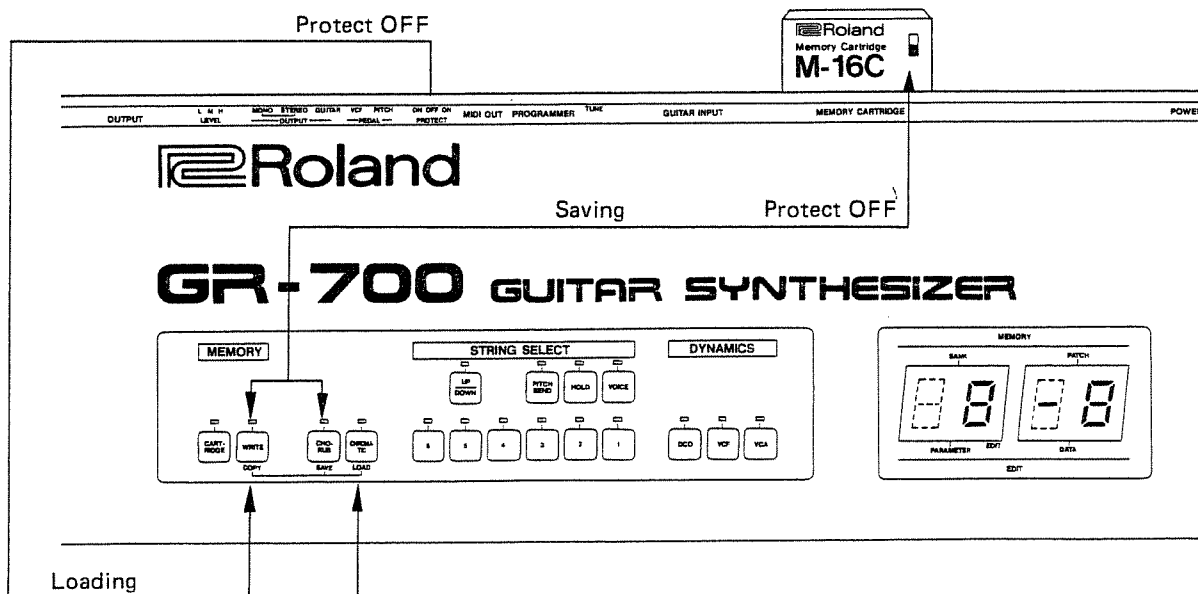

d. Saving and Loading

It is possible to save the whole data in the GR-700's memory onto the Memory Cartridge. Also, you can load the data on the cartridge into the internal memory of the GR-700.

1) Saving

- ① Set the Protect Switch on the Memory Cartridge to the OFF position.
- ② While holding the Copy Switch ⑭ down, press the Save Switch ⑮.
- ③ Set the Protect Switch on the cartridge to the ON position.

2) Loading

- ① Set the Memory Protect Switch ⑧ to the OFF position.
- ② While holding the Copy Switch ⑭ down, press the Load Switch ⑯.
- ③ Set the Memory Protect Switch ⑧ to the ON position.

Right after the Saving or Loading operation, the Display reacts as shown below.

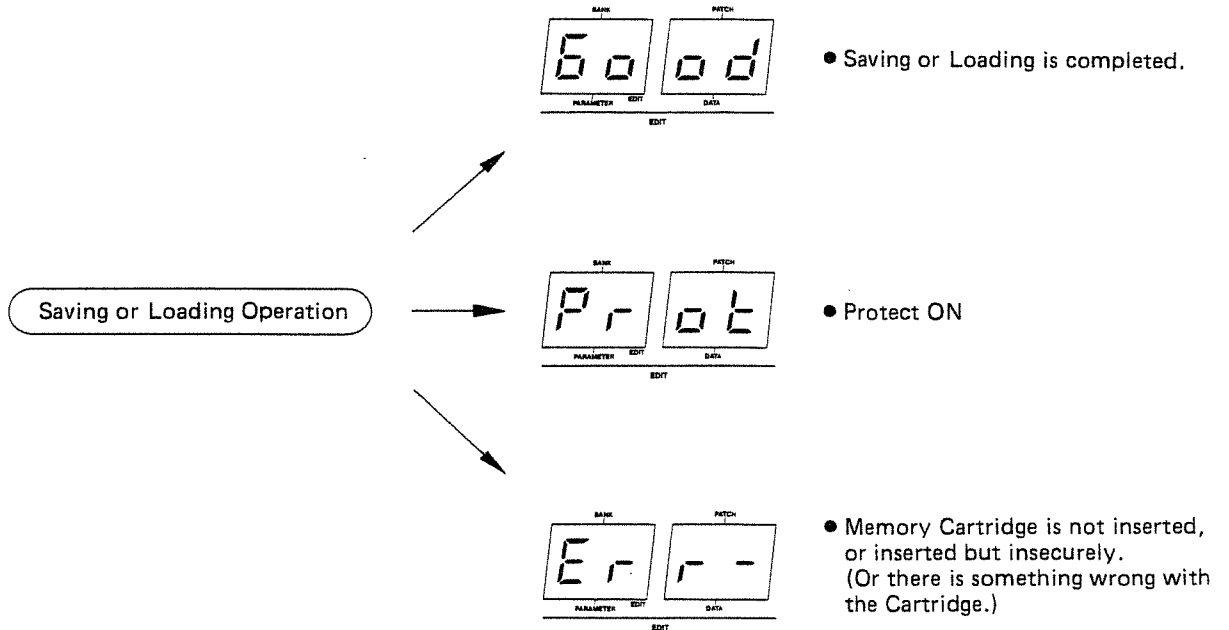

7. MIDI

The GR-700 has one MIDI Output, but no MIDI In.
The MIDI transmitter channel is always 1.

a. MIDI Transmitter Messages

Refer to the Implimentation Chart at the end of this manual.

b. Selecting the Transmitter Message(s)

The GR-700 is able to transmit various MIDI messages, but the following three messages are turned off.

1. Hold Message :

On/Off of the Hold Pedal function.

2. Program Change Message :

Sending Program Change Number corresponding to each patch program number.

If you want the message or messages 1 to 3, turn the GR-700 on while holding the corresponding String Selector Switch or Switches 1 to 3. For instance, if you want the Hold and Program Change Messages, turn the GR-700 on while holding the String Selector Switches 1 and 2 at the same time.

3. Mode Message :

OMNI OFF, POLY ON message

GR-700 Program Change Messages

Area	Bank	Patch Number							
		1	2	3	4	5	6	7	8
INT	1	0	1	2	3	4	5	6	7
	2	8	9	10	11	12	13	14	15
	3	16	17	18	19	20	21	22	23
	4	24	25	26	27	28	29	30	31
	5	32	33	34	35	36	37	38	39
	6	40	41	42	43	44	45	46	47
	7	48	49	50	51	52	53	54	55
	8	58	57	58	59	60	61	62	63
C.	1	64	65	64	67	68	69	70	71
	2	72	73	74	75	76	77	78	79
	3	80	81	82	83	84	85	86	87
	4	88	89	90	91	92	93	94	95
	5	96	97	98	99	100	101	102	103
	6	104	105	106	107	108	109	110	111
	7	112	113	114	115	116	117	118	119
	8	120	121	122	123	124	125	126	127

5 SPECIFICATIONS

GR-700

●6 Voice Programable Guitar Synthesizer

●Internal Memory

64 Patch Programs, Battery Back-up
(RAM)

●External Memory

Memory Cartridge (M-16C)

●Edit

32 Parameters
(By using a Guitar Controller)

■Front Panel

●Pedal Switches

Bank Pedal
Number Pedal (1 ~ 8)
Edit Pedal
Hold Pedal

●Panel Switches

Dynamics Switch (DCO, VCF, VCA)
String Selector Switch (VOICE, HOLD,
PITCH BEND-UP/DOWN, 1 ~ 6)
Chromatic/Load Switch
Chorus/Save Switch
Memory-Write/Copy Switch
Cartridge Switch

■Display Window

Memory: Bank Number
Patch Number
Edit: Parameter Number
Parameter Data
< 4 figure (1 inch) 7 Segment LED >

■Rear Panel

●Jacks

Output Connectors: 2
(XLR Connectors)
Output Jacks (STEREO/MONO): 2
(Standard Phone Jacks)
Guitar Output Jack: 1
(Standard Phone Jack)
VCF Pedal Jack: 1
(FV-200)
PITCH Pedal Jack: 1
(FV-200)
MIDI Output Connector: 1
(5P-DIN)
Programmer Connector: 1
(6P-DIN)
Guitar Input Connector: 1
(C-24D STD)
Memory Cartridge Slot: 1
(Specifically for M-16C)
AC Inlet

●Controls & Switches

Output Level Control
(H/M/L)
Memory Protect Switch (ON/OFF)
Tune Knob (± 50 cents)
Power Switch

■Power Consumption

This is shown on the name plate.

■Dimensions

690(W) x 375(D) x 155(H) mm
27-3/16"(W) x 14-3/4"(D) x 6-1/8"(H)

■Weight: 12 kg/26 lb. 7 oz.

■Accessories

Connection Cable (LP-25): 2
(C-24D): 1
(6P DIN/1.5m): 1
AC Cord: 1
Memory Cartridge (M-16C): 1
Owner's Manual: 1

■Options

Programmer	PG-200
Foot Volume	FV-200
Memory Cartridge	M-16C
Carrying Case	AB-700

Guitar synthesizer

MODEL GR-700 MIDI Implementation Chart

Function.....		Transmitted				Recognized		Remarks
		0	1	2	3	dis	en	
Basic Channel	Default Changed	1 ×						Transmitter only
Mode	Default Messages Altered	1 ×	1 ×	1 ×	3 ×			*****
Note Number	: True voice	36-96 *****						
Velocity	Note ON Note OFF	○ 90 v=1-127 × 90 v=0						
After Touch	Key's Ch's	× ×						
Pitch Bender		×						
Control Change		× ○ × ×						
Prog Change	True #	× × ○ × *****						0-127
System Exclusive		×						
System Common	Song Pos Song Sel Tune	× × ×						
System Real Time	Clock Commands	× ×						
Aux Messages	Local ON/OFF All Notes OFF Active Sense Reset	× ○ (123) × ×						
Notes		While pressing the STRING #3 switch, then power up, OMNI OFF, POLY ON are sent in ch-1. Transmitter only.						

Mode 1 : OMNI ON, POLY
Mode 3 : OMNI OFF, POLY

Mode 2 : OMNI ON, MONO
Mode 4 : OMNI OFF, MONO

○ : Yes
× : No

Guitar synthesizer

MODEL GR-700 MIDI Implementation

1. TRANSMITTED DATA

The GR-700 always transmits data in channel 1 POLY mode.

Status	Second	Third	Description	
1001 0000	Okkk kkkk	Ovvv vvvv	Note on kkkkkkk = 36 - 96	
1001 0000	Okkk kkkk	0000 0000	Note off kkkkkkk = 36 - 96	
1011 0000	0100 0000	0111 1111	hold on	*1
1011 0000	0100 0000	0000 0000	hold off	*1
1100 0000	0ppp pppp		Program Change ppppppp = D - 127	*2
1011 0000	0111 1011	0000 0000	ALL NOTES OFF	*3
1011 0000	0111 1100	0000 0000	OMNI OFF	*4
1011 0000	0111 1111	0000 0000	POLY ON	*4

notes:
 *1 If enabled.
 *2 If enabled.
 *3 When all notes turn OFF, this message is sent.
 *4 See next section.

Program change assignments are as follows:

For internal memory

patch bank	1	2	3	4	5	6	7	8
	Program change numbers							
1	0	1	2	3	4	5	6	7
2	8	9	10	11	12	13	14	15
3	16	17	18	19	20	21	22	23
4	24	25	26	27	28	29	30	31
5	32	33	34	35	36	37	38	39
6	40	41	42	43	44	45	46	47
7	48	49	50	51	52	53	54	55
8	56	57	58	59	60	61	62	63

For memory cartridge

patch bank	1	2	3	4	5	6	7	8
	Program change numbers							
1	64	65	66	67	68	69	70	71
2	72	73	74	75	76	77	78	79
3	80	81	82	83	84	85	86	87
4	88	89	90	91	92	93	94	95
5	96	97	98	99	100	101	102	103
6	104	105	106	107	108	109	110	111
7	112	113	114	115	116	117	118	119
8	120	121	122	123	124	125	126	127

2. FRONT PANEL CODED FUNCTION

If the power switch is turned on while pressing one of the STRING SELECT switches, MIDI functions are enabled for transmission as follows:

switch	function
1	HOLD ON / OFF
2	PROGRAM CHANGE
3	transmits OMNI OFF and POLY ON once.

Simply turn on the power, all mentioned functions are disabled.

Roland®

10155

UPC

10155



1090:

Roland®