

Roland

MIDI INTELLIGENT SYNTHESIZER

E-10

Owner's Manual

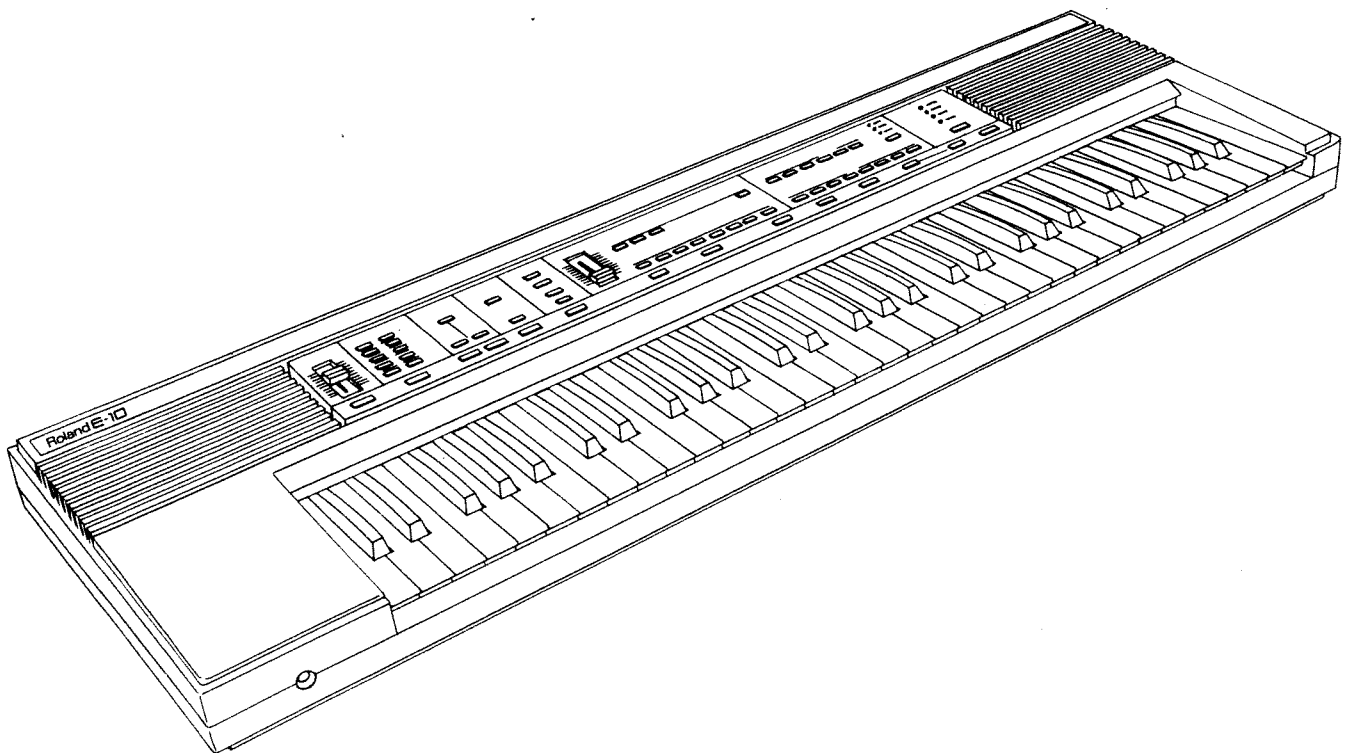

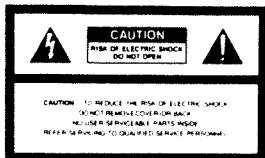

The lightning flash with arrowhead symbol, within an equilateral triangle, is intended to alert the user to the presence of un-insulated "dangerous voltage" within the product's enclosure that may be of sufficient magnitude to constitute a risk of electric shock to persons.



The exclamation point within an equilateral triangle is intended to alert the user to the presence of important operating and maintenance (servicing) instructions in the literature accompanying the product.

INSTRUCTIONS PERTAINING TO A RISK OF FIRE, ELECTRIC SHOCK OR INJURY TO PERSONS

IMPORTANT SAFETY INSTRUCTIONS

WARNING When using electric products, basic precautions should always be followed, including the following:

1. Read all the instructions before using the product.
2. To reduce the risk of injury, close supervision is necessary when a product is used near children.
3. Do not use this product near water— for example, near a bathtub, washbowl, kitchen sink, in a wet basement, or near a swimming pool, or the like.
4. This product should be used only with a cart or stand that is recommended by the manufacturer.
5. This product, either alone or in combination with an amplifier and headphones or speakers, may be capable of producing sound levels that could cause permanent hearing loss. Do not operate for a long period of time at a high volume level or at level that is uncomfortable. If you experience any hearing loss or ringing in the ears, you should consult an audiologist.
6. The product should be located so that its location or position does not interfere with its proper ventilation.
7. The product should be located away from heat sources such as radiators, heat registers or other products that produce heat.
8. The product should avoid using in where it may be effected by dust.
9. The product should be connected to a power supply only of the type described in the operating instructions or as marked on the product.
10. The power-supply cord of the product should be unplugged from the outlet when left unused for a long period of time.
11. Do not tread on the power-supply cord.
12. Do not pull the cord but hold the plug when unplugging.
13. When setting up with any other instruments, the procedure should be followed in accordance with instruction manual.
14. Care should be taken so that objects do not fall and liquids are not spilled into the enclosure through openings.
15. The product should be serviced by qualified service personnel when:
 - A. The power-supply cord or the plug has been damaged, or
 - B. Objects have fallen, or liquid has been spilled into the product, or
 - C. The product has been exposed to rain, or
 - D. The product does not appear to operate normally or exhibits a marked change in performance, or
 - E. The product has been dropped, or the enclosure damaged.
16. Do not attempt to service the product beyond that described in the user-maintenance instructions. All other servicing should be referred to qualified service personnel.

SAVE THESE INSTRUCTIONS

ADVARSEL!

Lithiumbatteri. Eksplosionsfare.
Udskriftning må kun foretages af en sagkyndig, og som beskrevet i servicemanual.

VARNING!

Lithiumbatteri. Explosionsrisk.
Får endast bytas av behörig servicetekniker.
Se instruktioner i servicemanualen.

ADVARSEL!

Lithiumbatteri. Fare for eksplosion.
Må bare skiftes av kvalifisert tekniker som beskrevet i servicemanualen.

VAROITUS!

Lithiumparisto. Räjähdyksvaara.
Pariston saa vaihtaa ainoastaan alan ammottimies.

NOTICE

This digital apparatus does not exceed the Class B limits for radio noise emission set out in the Radio Interference Regulations of the Canadian Department of Communications.

AVIS

Cet appareil numérique ne dépasse pas les limites de la classe B au niveau des émissions de bruits radio-électriques fixés dans le Règlement des signaux parasites par le Ministère canadien des Communications.

WARNING

THIS APPARATUS MUST BE EARTH GROUNDED.

The three conductors of the mains lead attached to this apparatus are identified with color as shown in the table below, together with the matching terminal on the UK type power plug. When connecting the mains lead to a plug, be sure to connect each conductor to the correct terminal, as indicated.

"This instruction applies to the product for United Kingdom."

MAINS LEADS		PLUG
Conductor	Color	Mark on the matching terminal
Live	Brown	Red or letter L
Neutral	Blue	Black or letter N
Grounding	Green-Yellow	Green, Green-Yellow, letter E or symbol

Bescheinigung des Herstellers /Importeurs

Hiermit wird bescheinigt, daß der/die/das
ROLAND SYNTHESIZER E-10

(Gerät Typ-Bezeichnung)

in Übereinstimmung mit den Bestimmungen der
Amtsbl. Vfg 1046 / 1984

(Amtsblattverfügung)

funk entstört ist

Der Deutschen Bundespost wurde das Inverkehrbringen dieses Gerätes angezeigt und die Berechtigung zur Überprüfung der Serie auf Einhaltung der Bestimmungen eingeräumt

Roland Corporation Osaka / Japan

Name des Herstellers/Importeurs

RADIO AND TELEVISION INTERFERENCE

Warning—This equipment has been verified to comply with the limits for a Class B computing device pursuant to Subpart J of Part 15 of FCC rules. Operation with non-certified or non-verified equipment is likely to result in interference to radio and TV reception.

The equipment described in this manual generates and uses radio frequency energy. If it is not installed and used properly, that is, in strict accordance with all instructions, it may cause interference with radio and television reception.

This equipment has been tested and found to comply with the limits for a Class B computing device in accordance with the specifications in Subpart J of Part 15 of FCC Rules. These limits are designed to provide reasonable protection against such interference in a residential installation. However, there is no guarantee that interference will not occur in a particular installation. If this equipment does cause interference to radio or television reception, which can be determined by turning the equipment on and off, the user is encouraged to try to correct the interference by the following measure:

- Disconnect other devices and their input/output cables one at a time. If the interference stops, it is caused by either the other device or its I/O cable.
- These devices usually require Roland designated shielded I/O cables. For Roland devices, you can obtain the proper shielded cable from your dealer. For non-Roland devices, contact the manufacturer or dealer for assistance.
- If your equipment does cause interference to radio or television reception, you can try to correct the interference by using one or more of the following measures:
 - Turn the TV or radio antenna until the interference stops.
 - Move the equipment to one side or the other of the TV or radio.
 - Move the equipment farther away from the TV or radio.
 - Plug the equipment into an outlet that is on a different circuit than the TV or radio. (That is, make certain the equipment and the radio or television set are on circuits controlled by different circuit breakers or fuses.)
- Consider installing a rooftop television antenna with equalizer attachment in between the antenna and TV.

If necessary, you should consult your dealer or an experienced radio/television technician for additional suggestions. You may find helpful the following booklet prepared by the Federal Communications Commission:

How to Identify and Resolve Radio-TV Interference Problems.
This booklet is available from the U.S. Government Printing Office, Washington, DC 20402. Stock No. 904 680 60345-4

Please read the separate volume "MIDI", before reading this owner's manual.

Copyright © 1988 by ROLAND CORPORATION

All rights reserved. No part of this publication may be reproduced in any form without the written permission of ROLAND CORPORATION.

PANEL DESCRIPTION

TOP:

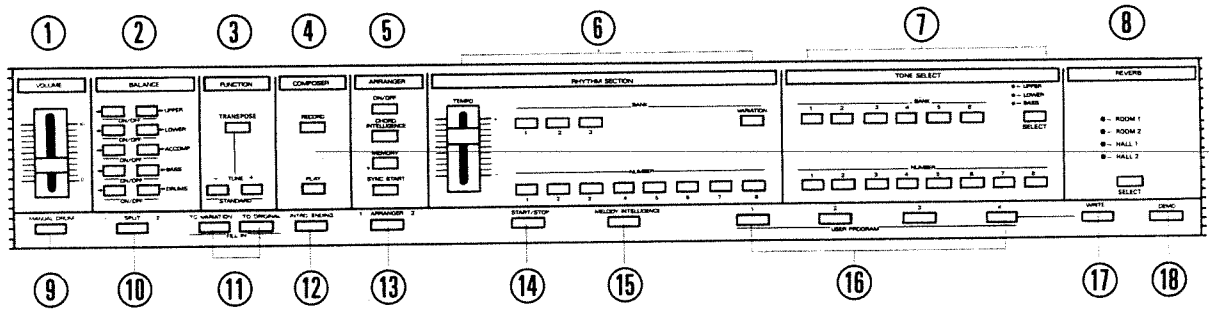
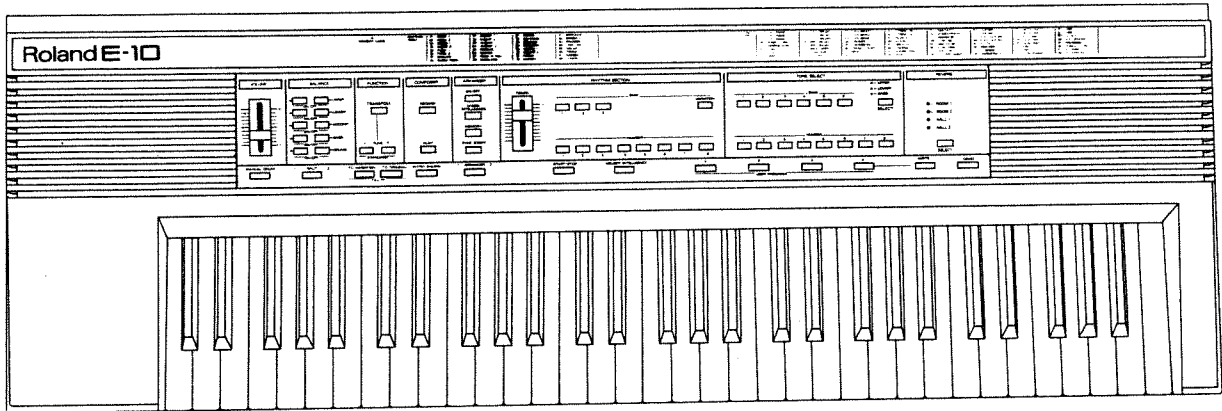

REAR:

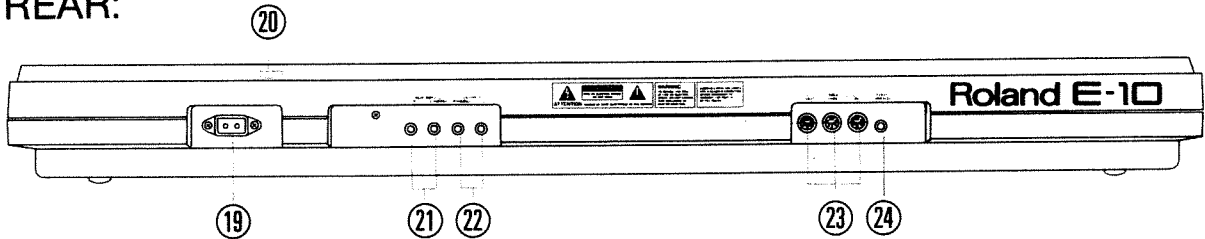

FRONT:

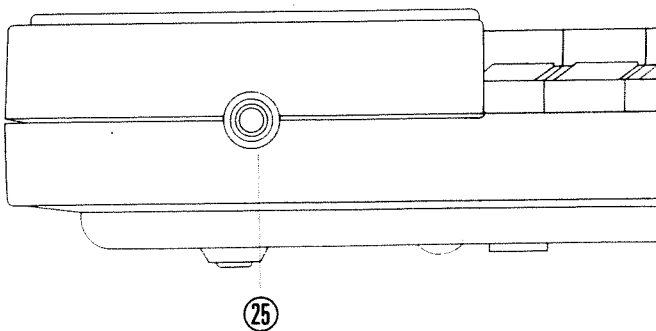

- ① MASTER VOLUME slider
(See page 13)
- ② TONE BALANCE SECTION
(See page 20)
- ③ FUNCTION CONTROL
(See page 36)
- ④ SONG COMPOSER SECTION
(See page 41)
- ⑤ ARRANGER SECTION
(See page 29 in ACCOMPANIMENT)
- ⑥ RHYTHM SECTION
(See page 21)
- ⑦ TONE SELECT SECTION
(See page 15)
- ⑧ REVERB EFFECT SECTION
(See page 35)
- ⑨ MANUAL DRUM button
(See page 26)
- ⑩ SPLIT button
(See page 16 in TONE SELECT)
- ⑪ FILL-IN buttons
(See page 30 in ACCOMPANIMENT)
- ⑫ INTRO/ENDING button
(See page 24 in RHYTHM Section)
- ⑬ ARRANGER 1 & 2 button
(See page 29 in ACCOMPANIMENT)
- ⑭ START/STOP button
(See page 24 in RHYTHM Section)
- ⑮ MELODY INTELLIGENCE button
(See page 34 in ACCOMPANIMENT)
- ⑯ USER PROGRAMS buttons 1–4
(See page 38)
- ⑰ WRITE button
(See page 40 in USER PROGRAMS)
- ⑱ DEMO button
(See page 13 in DEMO SONG)
- ⑲ AC Socket
- ⑳ POWER SWITCH
- ㉑ Stereo AUX IN Sockets
- ㉒ Stereo AUX OUT Sockets
- ㉓ MIDI Sockets
- ㉔ SUSTAIN PEDAL Socket
- ㉕ HEADPHONE Socket

FEATURES

- The E-10 is a 61-note, 32 partial, polyphonic synthesizer with dynamic keyboard.
- The E-10 uses Roland's Linear Arithmetic Synthesis (LA sound)
- LEDs provide information and directions to the player while programming the many features of the E-10 making operation quicker and easier.
- MIDI connectors are provided for connecting other MIDI devices.
- The E-10 incorporates internal speakers and amplifier of maximum output of 2×5 watts.

Thank you for purchasing the Roland E-10 Intelligent Synthesizer.

The E-10 is an easy-to-operate keyboard that anyone can play.

It gives you the benefit of Roland's superior digital technology.

The E-10 uses the same Linear Arithmetic synthesis used by our D-series professional synthesizers. The 48 tones and 30 percussion sounds of the E-10 offer you an excellent natural range of sound.

The musical functions of the E-10 add the fantastic modern musical sounds of other instruments to your keyboard playing.

This Owner's Manual is written to help you have many years of musical enjoyment with your E-10.

CONTENTS

PANEL DESCRIPTION	3
FEATURES	5
IMPORTANT NOTES	8
THE CARE OF YOUR E-10	9
CONNECTIONS	10
OPERATION	
SETTING UP THE MUSIC STAND	12
POWER ON	12
MASTER VOLUME	13
DEMO SONG	13
TONE SELECT	15
UPPER TONE SELECT	15
SPLIT	16
LOWER TONE SELECT	18
BASS TONE SELECT	19
TONE BALANCE	20
UPPER BALANCE	20
LOWER BALANCE	21
BASS BALANCE	21
RHYTHM SECTION	22
RHYTHM SELECT	22
STARTING THE RHYTHM	24
TEMPO CONTROL	24
STOPPING THE RHYTHM	25
MANUAL DRUMS	26
DRUM BALANCE	26
ACCOMPANIMENT	29
ARRANGER ON/OFF	29
ARRANGER 1 & 2	29
VARIATION	29
FILL-IN	30
MEMORY	30
SYNC START	30
CHORD INTELLIGENCE	31
PLAY INTELLIGENT CHORDS	32
MELODY INTELLIGENCE	34
ACCOMPANIMENT BALANCE	34
REVERB EFFECT	35
REVERB TYPE	35

FUNCTION	
TRANSPOSE/TUNE	36
TRANSPOSE	36
MASTER TUNE	37
SUSTAIN PEDAL (OPTIONAL)	37
USER PROGRAMS	38
WRITING A PANEL CONFIGURATION	40
SONG COMPOSER	41
RECORDING A SONG	42
PLAYING BACK A SONG	43
MIDI CONTROL	44
CONNECTIONS	44
128 TONES AVAILABLE BY EXTERNAL MIDI PROGRAM CHANGE	46
IF YOUR E-10 FAILS TO OPERATE	47
MIDI IMPLEMENTATION CHART	48
SPECIFICATIONS	49
PANEL SETTING MEMO	50

IMPORTANT NOTES

- The appropriate power supply for the keyboard unit is shown on its name plate. Please make sure that the line voltage in your country meets the requirements
- Use only the AC cord provided.
- Please do not use the same socket used for any noise generating device (such as a motor, variable lighting system).
- It is normal for this unit to become hot while being operated.
- If the unit is not to be used for a long period of time, unplug the AC cord from the socket.
- Disconnect the AC cord immediately in the event of an electrical storm.
- Before setting up this keyboard with other MIDI devices, turn this keyboard off along with all other units.
- Be sure to connect the MIDI cables securely. If the MIDI cable is disconnected while the keyboard is being played, various troubles will occur (e.g. the note may continue to sound).
- Static electricity may cause the built-in computer to malfunction. Should this occur, simply reset the keyboard by turning the power switch off and then after a few seconds, back on.
- This keyboard might not operate correctly if turned on immediately after being turned off. If this happens, simply turn it off and after a few seconds later, turn it on again.
- Operating the E-10 near a neon light, fluorescent lamp, TV or CRT display, may cause noise interference. If so, change the position of the keyboard.
- To avoid risk of electric shock, do not perform any servicing. Refer all servicing to qualified service personnel.

THE CARE OF YOUR E-10

To ensure the best use and full enjoyment of your E-10, please read this guide carefully and thoroughly.

ROOM LOCATION

Avoid using this keyboard in excessive heat or humidity conditions or where it may be affected by direct sunlight or dust and avoid places subject to high vibrations.

CABINET CARE

Use a soft dry cloth for dusting. To remove fingerprints or dulling film, use a soft cloth slightly dampened with water and a little mild detergent. Immediately wipe dry with a soft cloth. Do not use solvents such as paint thinners.

CONNECTIONS

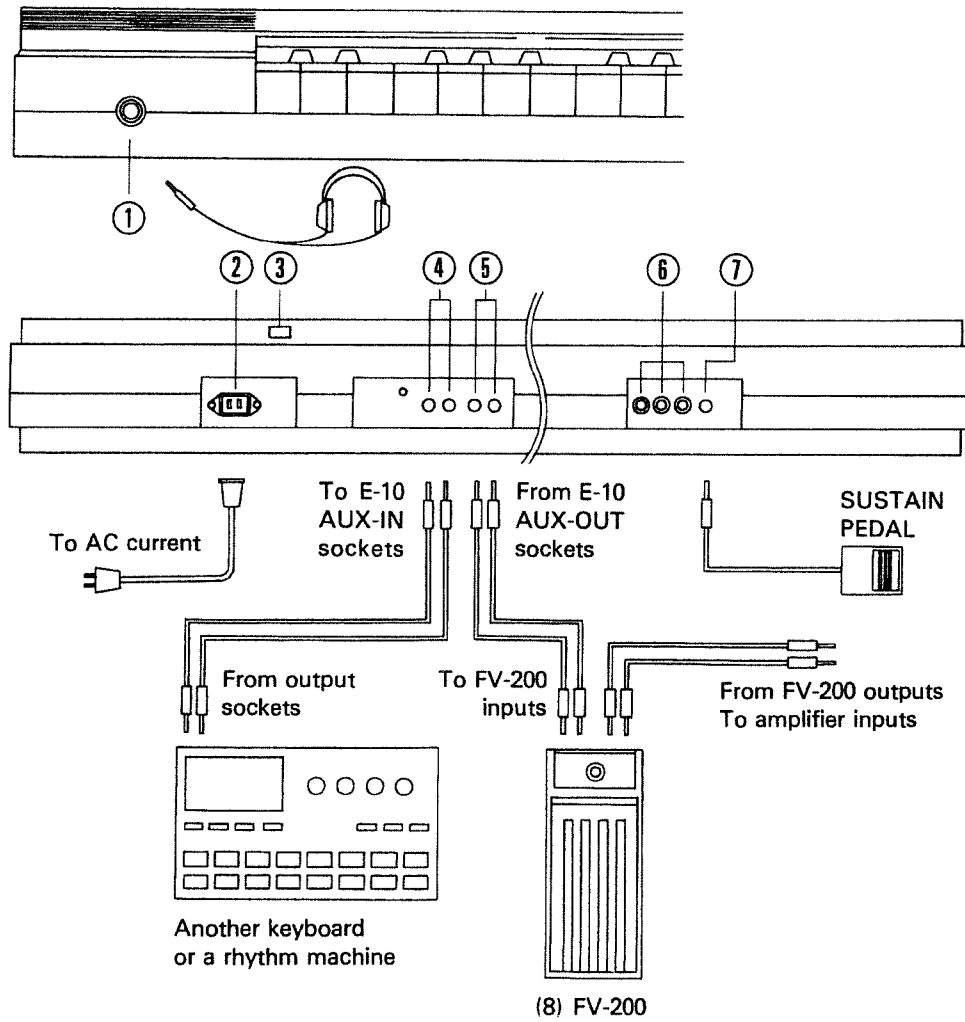

- (1) **Headphones (PHONES) Socket**
For your playing convenience, connect a set of standard stereo headphones (RH-12/RH-100) into this socket and you can play and practice in private. Connecting the headphone plug to the PHONES socket will disconnect the internal speakers. The Master Volume slider will adjust the headphone overall volume.
- (2) **AC Socket**
To connect with household AC current, use the AC power cord supplied with your E-10.
- (3) **POWER Switch**
- (4) **Stereo AUX IN Sockets**
By connecting another keyboard or rhythm machine, the E-10 internal speakers can output all the sounds. To connect a Mono instrument to the E-10, always use the «L (mono)» AUX IN socket.
- (5) **Stereo AUX OUT Sockets**
The E-10 can be connected to external amplification (Hi-Fi, tape recorder, etc.), to further amplify the sound. When connecting to a Mono amplifier, always use the «R (mono)» AUX OUT socket.
- (6) **MIDI Sockets**
See MIDI CONTROL
- (7) **SUSTAIN PEDAL Socket**
Using the optional footswitch (DP-2/DP-6), sustain of Upper tones can be controlled by the foot.
See SUSTAIN PEDAL
- (8) **FV-200 Stereo Expression Pedal**
See page 14 for details.

OPERATION

SETTING UP THE MUSIC STAND

Supplied with your E-10 is a music stand. This will be found in the keyboard carton. To attach to keyboard, insert the two feet into the two holes located on the top panel.

POWER ON

Press the Power On/Off switch (20)

The three SELECT and four REVERB LEDs will light for a few seconds. After the LEDs have been switched off, your E-10 is ready for use.

MASTER VOLUME

The keyboard can now be played in the Full Keyboard mode using the pre-selected 11 ELEC PIANO tone. Make sure that the MASTER VOLUME slider is moved to the central position.

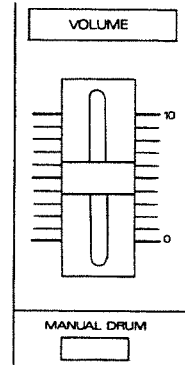

MASTER VOLUME CONTROL

The Master Volume slider control enables the overall volume of the E-10 to be raised (moving the slider away from you) or lowered (moving the slider toward you). This control will also control the overall volume when using headphones.

DEMO SONG

To show you the full sound capabilities of the E-10, four Demo songs have been included. Press the DEMO button (18) and then the START/STOP button (14) to start the Demo Songs. When the last song has been played, the E-10 will automatically stop playing. (Press the START/STOP button to stop the Demo at any time). There are a total of four Demo Songs. To select each individual Demo Song, press User Program buttons 1, 2, 3 or 4 (16) (LED will light) after pressing the DEMO button. Then press the START/STOP button to play the Demo Song chosen. (Press the START/STOP button to stop the Demo at any time).

<Reference>

When connecting to external amplification, an optional stereo expression pedal (FV-200) can be used to control the overall volume. See following illustration for connecting procedures.

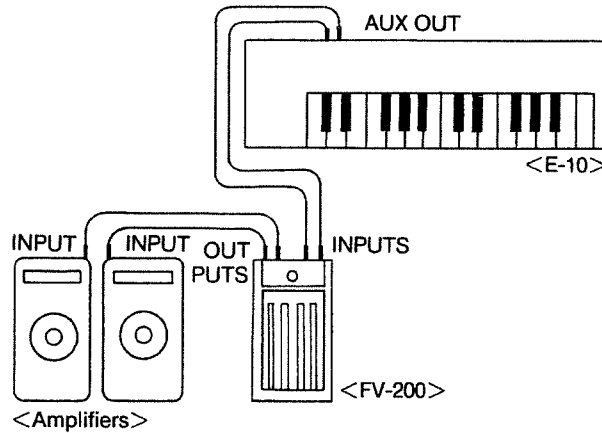

1. Be sure to turn the E-10 and any other amplification system Off.
2. Connect the E-10 to the FV-200 by inserting a couple of shielded cords into the E-10 AUX OUT and the FV-200 INPUT sockets.
3. Connect the FV-200 to an amplification system with two additional shielded cords inserted into the FV-200 OUTPUT sockets.
4. Turn the switches of all instruments ON and adjust the Master Volume control of the E-10.
5. Make sure that the overall volume is controlled by the foot pedal.

TONE SELECT

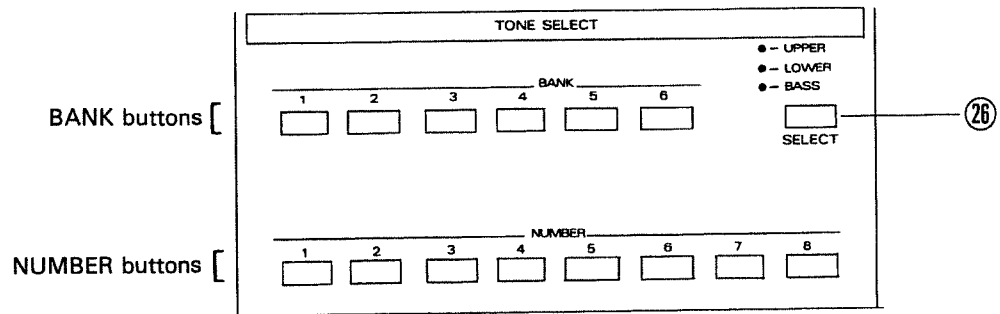

Any of the 48 different tone colors can be selected by using the BANK and NUMBER Buttons.

UPPER TONE SELECT

To change the tone in the full keyboard mode press the SELECT button ②⑥ in the TONE SELECT section until the corresponding UPPER LED will light.

To select any of the 48 tones, press a BANK button for the first digit and then a NUMBER button for the second.

Example: To select 32 STRING SECT2 tone

Press BANK button 3 and then NUMBER button 2. The corresponding LEDs will light.

All of the 61 keys can be played dynamically, that is the harder you play the key the louder the tone will sound.

- * The above procedure (pressing BANK and NUMBER buttons) can be carried out in any order you wish.
- * If the UPPER LED is already lit, simply press the two buttons of the UPPER tone you require.

SPLIT

The keyboard can also be played in a 'Split' mode. One tone on the right-hand side of the keyboard and a different tone for the left. To 'split' the keyboard press the SPLIT button **⑩** . Split 1 (left) LED light.

The keyboard will now be split between the F # and G keys in the second octave. The tone now sounding from the bottom note to and including F # will be known as the «Lower» and tones for this section are selected using the SELECT button in the TONE SELECT section (see LOWER TONE SELECT). The tone now sounding from and including the G key upwards is selected using the SELECT button (see UPPER TONE SELECT).

Pressing the SPLIT button once more will light the LED on the right-hand side of the button. This operation moves the keyboard «Split» and expands the amount of notes available for the LOWER keyboard section. Now the notes from the bottom to and including B in the second octave will be the «Lower» keyboard and notes from and including C in the third octave will be the «Upper» keyboard.

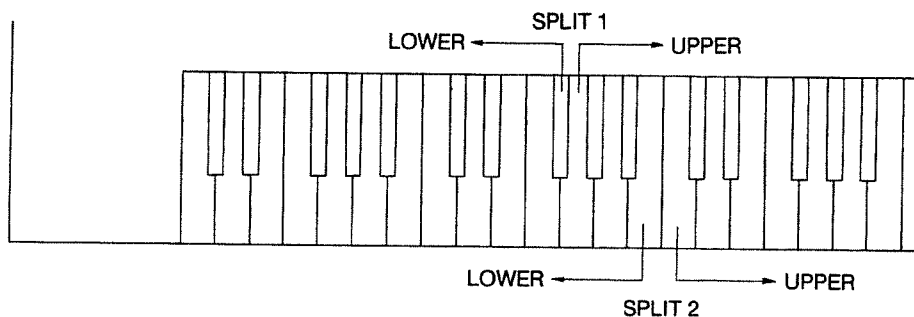

To cancel the «Split» feature and play the E-10 in the Full Keyboard mode, press the SPLIT button a third time (LEDs not lit).

The Split 2 function will also be automatically selected (if in Off position) when the following buttons are pressed:

- ARRANGER 1 & 2
- CHORD INTELLIGENCE
- MELODY INTELLIGENCE
- MEMORY
- COMPOSER RECORD
- COMPOSER PLAY
- USER PROGRAMS 1–4*

* If any of the following functions have been programmed in the On position:

- SPLIT 1 or 2
- ARRANGER 1 or 2
- CHORD INTELLIGENCE
- MELODY INTELLIGENCE
- MEMORY

When in SPLIT position (1 or 2), playing a chord in the Lower section will produce the chord sound plus a bass tone. The bass note heard, will be the root note of the chord played. To select a tone for the bass, press the SELECT button in the TONE SELECT section (see BASS TONE SELECT) until the corresponding BASS LED will light.

Chords can be played in two different ways - Easy chords (see CHORD INTELLIGENCE) and conventional chords.

LOWER TONE SELECT

To select a different tone for the left-side of the Split (Lower), press the SELECT button (26) in the TONE SELECT section until the corresponding LOWER LED will light.

To select any of the 48 notes, press a BANK button for the first digit and then a NUMBER button for the second.

Example: To select 41 FANTASY tone

Press BANK button 4 and then NUMBER button 1. The corresponding LEDs will light.

* The above procedure (pressing BANK and NUMBER buttons) can be carried out in any order you wish.

* If the LOWER LED is lit, there is no need to press the SELECT button before pressing BANK and NUMBER buttons, simply press the two buttons of the LOWER tone you require.

BASS TONE SELECT

Bass Tone Select

To change the Bass tone, press the SELECT button **(26)** in the TONE SELECT section until the corresponding BASS LED lights.

To select any of the 48 notes, press a BANK button for the first digit and then a NUMBER button for the second.

Example: To select 62 SLAP BASS 1 tone

Press BANK button 6 and then NUMBER button 2. The corresponding LEDS will light.

- * The above procedure (pressing BANK and NUMBER buttons) can be carried out in any order you wish.
- * If BASS LED is already lit, there is no need to press the SELECT button before pressing BANK and NUMBER buttons, simply press the two buttons of the BASS tone you require.

<Notes On Tone Selecting>

- * On selecting either UPPER, LOWER or BASS tones, if the BANK or the NUMBER is the same as the previous tone, there is no need to press that button.
- * The UPPER and BASS tone select procedures are the same with or without the Rhythm playing.
- * When the ARRANGER is playing, the LOWER tone will not sound, and changing the LOWER tone or modifying the LOWER volume (LOWER BALANCE: see TONE BALANCE) will not make any effect at all.
- * Changing the BASS Tone will not affect the preset BASS Tone played by the ARRANGER 1 & 2.

TONE BALANCE

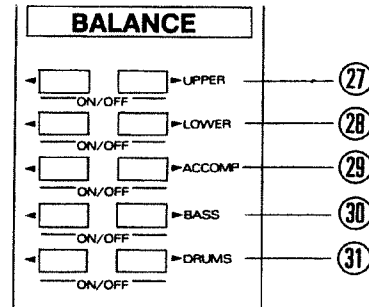

The volumes of UPPER, LOWER and BASS tones can be controlled by the buttons "▷" and "◁" in the BALANCE section.

UPPER BALANCE

To adjust the volume of the UPPER tone (or Full Keyboard tone when SPLIT is Off), press either UPPER "▷" button to increase or "◁" button to decrease the volume (27) .

To quickly turn off the Upper tone, press UPPER "▷" and "◁" buttons simultaneously.

To turn the UPPER tone on again, press UPPER "▷" and "◁" buttons again simultaneously.

LOWER BALANCE

To adjust the volume of the LOWER tone, press either LOWER "▷" button to increase or "◁" button to decrease the volume ②⑧ .

To quickly turn off the Lower tone, press LOWER "▷" and "◁" buttons simultaneously.

To turn on again the LOWER tone, press LOWER "▷" and "◁" buttons again simultaneously.

BASS BALANCE

To adjust the volume of the BASS tone, press either BASS "▷" button to increase or "◁" button to decrease the volume ③⑩ .

To quickly turn off the BASS tone, press BASS "▷" and "◁" buttons simultaneously.

To turn on again the BASS tone, press BASS "▷" and "◁" buttons again simultaneously.

RHYTHM SECTION

Your E-10 is also equipped with a built-in automatic Rhythm section.

Each rhythm includes a Drum track, Bass line and Orchestral accompaniment and preset tempo. You can select between the basic rhythm (original) and Variation (see VARIATION). The Arranger supplies the Orchestral Accompaniment with a choice of simple or complex arrangements (see ARRANGER 1 & 2 in ACCOMPANIMENT). Memory automatically holds the notes you play until new notes are played (see MEMORY in ACCOMPANIMENT).

RHYTHM SELECT

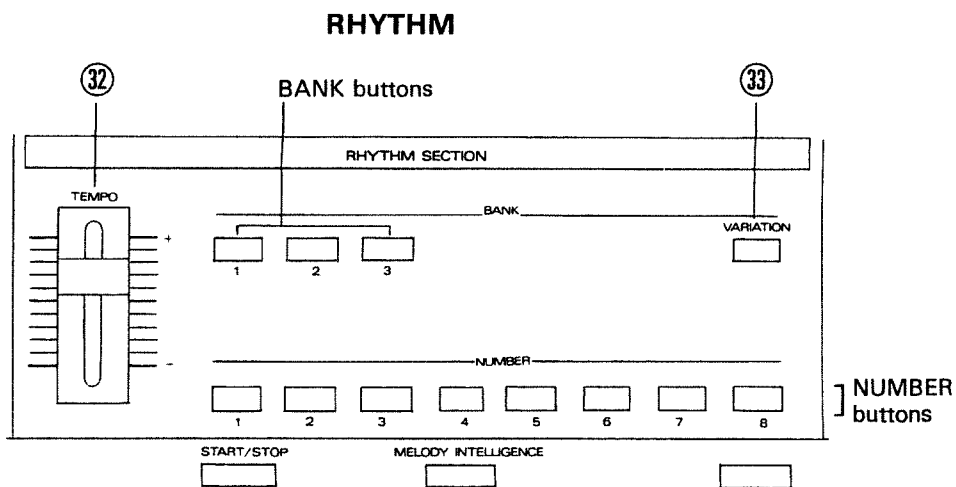

The instrument will automatically select 16 8 BEAT when it is turned on. To select a different rhythm from the 24 in the RHYTHM TABLE, press in the rhythm section a BANK button for the first digit and NUMBER button for the second. The corresponding LEDs will light.

Example: To select 38 CHA CHA rhythm

Press BANK button 3 and then NUMBER button 8. The new rhythm will be selected complete with preset tempo:

- * The above procedure (pressing BANK and NUMBER buttons) can be carried out in any order you wish.
- * On selecting a new rhythm, if the BANK or the NUMBER is the same as the previous rhythm, there is no need to press that button.
- * A new rhythm can be selected while the Rhythm is playing. In this operation, the new rhythm will not take the preset tempo but the tempo of the previous rhythm.

VARIATION

Pressing the VARIATION button  (see RHYTHM SECTION) (LED lights), will give a variation to the rhythm.

To return to the basic (original) rhythm, press the VARIATION button once more (LED is turned off).

STARTING THE RHYTHM

The rhythm can be started in three ways:

1. Press the START/STOP button ⑭ and the rhythm will start immediately.
2. Press the SYNC START button ⑳ (see ACCOMPANIMENT) (LED lights). Then press a key in the accompaniment section of the keyboard. The rhythm will automatically start (LED is turned off).

* The Sync Start function may only be selected when the rhythm is stopped.

3. Press the INTRO/ENDING button ⑫ . The rhythm will begin with a musical "introduction", length of which depends on the rhythm selected.

While the rhythm is playing, the START/STOP LED will flash in time with the tempo set, the downbeat (first beat) of the measure will flash longer. When the rhythm is stopped, the LED will just flash the beat of the tempo set.

TEMPO CONTROL

To change the tempo, move the TEMPO slider control ㉓ located in the RHYTHM SECTION to the rhythm's preset point and then away from you to increase or towards you to decrease the tempo.

The TEMPO range is from a minimum of 32 to a maximum of 250.

STOPPING THE RHYTHM

The rhythm can be stopped in two ways:

1. Press the START/STOP button and the rhythm will stop immediately.
2. Press the INTRO/ENDING button. At the next downbeat the rhythm will perform a musical "ending", the length of which depends on the rhythm selected.

You can change from one rhythm to another WITHOUT stopping the rhythm by simply pressing the appropriate BANK and NUMBER buttons in the RHYTHM section.

With this operation, the new rhythm will not be played in the rhythm's preset tempo, but will follow the tempo set by the previous rhythm.

While stopped or while playing, the volumes of each section of the rhythm (DRUM, BASS, ACCOMP and UPPER) can be modified by using the appropriate "▷" and "◁" buttons in the BALANCE section.

MANUAL DRUMS

Pressing the MANUAL DRUM button ⑨ (LED lights) enables all the 30 drum instruments to be played manually from the keyboard. All the drum instruments can be played dynamically, that is the harder you play any key the louder the drum will sound.

Underneath, at the front section of the keyboard, you will find the names of each instrument the key represents. Each of these instruments can be played without or in conjunction with the automatic rhythm. When the MANUAL DRUM button is pressed without using automatic rhythm, the keyboard from the lowest note to D # in the 4th octave (MIDI note # 75) will not play any musical note. A manual rhythm can then be played using these keys. When using automatic rhythm and ARRANGER, pressing the switch will cancel any automatic chords and bass. The keys can then be used to manually add drum voices to the automatic rhythm playing. If the MEMORY button was pressed (LED lit) prior to pressing the MANUAL DRUM button, the chord playing will remain and cannot be changed until the MANUAL DRUM button is pressed once more (LED off).

While the rhythm is stopped or playing, upper note tones can still be played from E in the 4th octave upwards when the MANUAL DRUM button is pressed.

To cancel the Manual Drums, just press the MANUAL DRUM button one more time (LED off).

DRUM BALANCE

To adjust the volume of the drums, press either DRUMS "▷" button to increase or "◁" button to decrease the volume ⑩ (see TONE BALANCE).

To quickly turn off the Drums, press DRUMS "▷" and "◁" buttons simultaneously.

To turn the Drums on again, press the DRUMS "▷" and "◁" buttons again simultaneously.

The assignment of the drum sounds are shown in the following illustration. The number represent the MIDI note number.

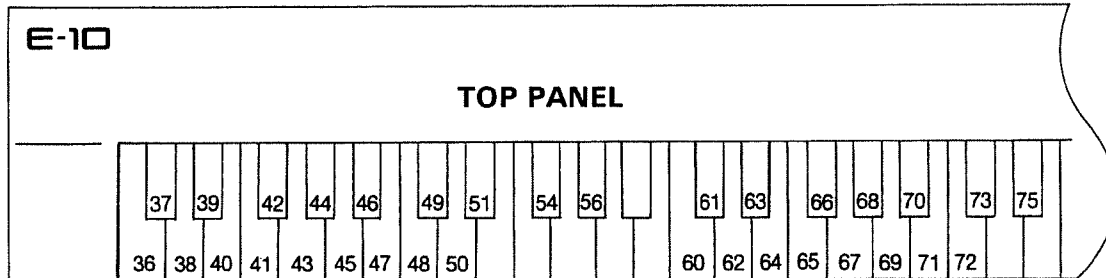

- | | |
|--|---------------------------------------|
| 36: Acou BD (Acoustic Bass Drum) | 56: Cowbell |
| 37: Rim Shot | 60: High Bongo |
| 38: Acou SD (Acoustic Snare Drum) | 61: Low Bongo |
| 39: Hand Clap | 62: Mt High Conga (Muted High Conga) |
| 40: Elec SD (Electric Snare Drum) | 63: High Conga |
| 41: Acou Low Tom (Acoustic Low Tom) | 64: Low Conga |
| 42: Clsd Hi Hat (Closed Hi-Hat) | 65: High Timbale |
| 43: Acou Low Tom (Acoustic Low Tom) | 66: Low Timbale |
| 44: Open Hi Hat2 | 67: High Agogo |
| 45: Acou Mid Tom (Acoustic Medium Tom) | 68: Low Agogo |
| 46: Open Hi Hat1 | 69: Cabasa |
| 47: Acou Mid Tom (Acoustic Medium Tom) | 70: Maracas |
| 48: Acou Hi Tom (Acoustic High Tom) | 71: Smba Whis S (Samba Whistle Short) |
| 49: Crash Cym (Crash Cymbal) | 72: Smba Whis L (Samba Whistle Long) |
| 50: Acou Hi Tom (Acoustic High Tom) | 73: Quijada |
| 51: Ride Cym (Ride Cymbal) | 75: Claves |
| 54: Tambourine | |

<Reference>

Stereo Balance of the Drum sounds

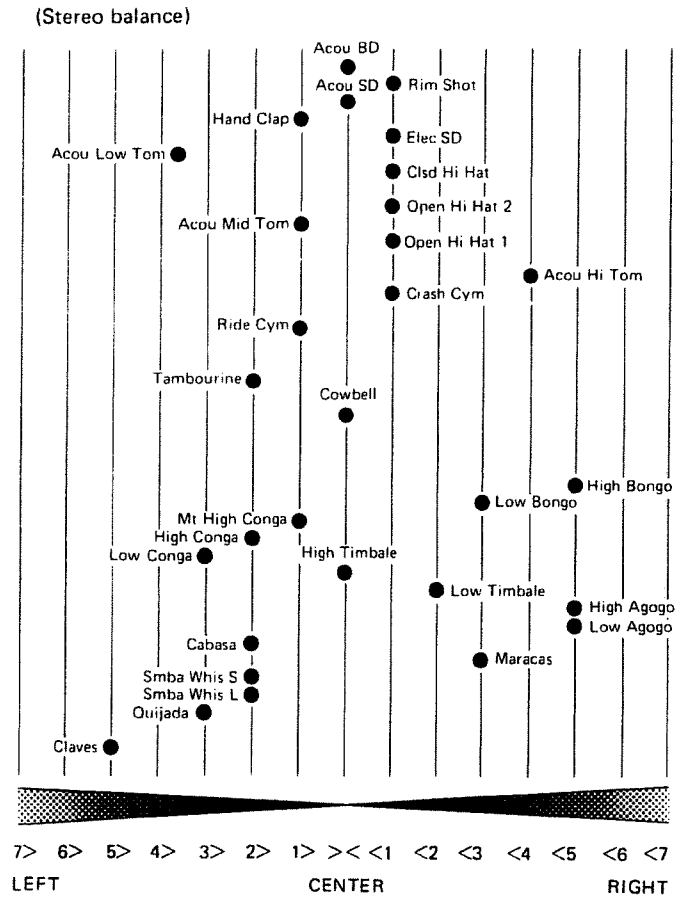

ACCOMPANIMENT

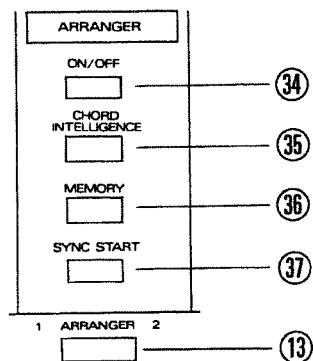

ARRANGER ON/OFF

Pressing the ARRANGER ON/OFF button (34) (LED lights) automatically turns off the LOWER tone and introduces orchestral accompaniment from chords played on the lower section of the keyboard. To switch off the ARRANGER, press the same button again (LED is turned off, Lower Tone is reactivated).

NOTE:

If you start the rhythm and stop then start again while pressing some keys with ARRANGER on, at second start, only the drums will play. Release the keys and play them again if you wish to hear the accompaniment.

ARRANGER 1 & 2

Each rhythm includes two types of arrangements - Simple and Complex. Pressing the ARRANGER 1 & 2 button (13) will select between the two arrangements (left or right LED will light).

VARIATION

Pressing the VARIATION button (33) (see RHYTHM section) (LED lights) will give a variation to each part of the rhythm (Drum track, Bass line and accompaniment).

To return to the basic (original) rhythms, press the VARIATION button once more (LED is turned Off).

FILL-IN

While playing the basic (original) rhythm, a Fill-in can be inserted by pressing the TO ORIGINAL button. This will result in a one measure fill-in and on completion will return to the basic rhythm.

While playing in the Variation, pressing the TO VARIATION button will result in a one measure fill-in and then on completion will return to the Variation.

If playing in the basic (original) rhythm and the TO VARIATION button is pressed, a one measure fill-in will occur and on completion will automatically proceed into the variation of the rhythm (VARIATION LED lights). Likewise if playing in the variation of a rhythm and the TO ORIGINAL button is pressed, a one measure fill-in will occur and on completion will automatically return to play the original rhythm (VARIATION LED is turned off).

* If either of the FILL-IN buttons are pressed within the 1st and 3rd beats (1st and 2nd on Waltz rhythms), the fill-in will be performed for the remainder of that measure. If either of the FILL-IN buttons are pressed within the 4th beat (3rd on Waltz rhythms), this operation will be interpreted as a pre-selection of the fill-in to start at the downbeat of the next measure.

MEMORY

Pressing the MEMORY button (36) (LED lights) will activate a memory circuit which will continue to play the notes played left of the SPLIT - LOWER tone (Accompaniment when ARRANGER is turned on) and bass after you release the keys. It will memorize and hold the notes until the next note(s) is played.

* Pressing the MEMORY button will automatically activate the SPLIT 2 function if the latter was not previously selected.

SYNC START

Pressing the SYNC START button (37) will synchronize the start of the rhythm when a key is played on the lower section of the keyboard. The SYNC START button can be selected before pressing the INTRO/ENDING button (LED will begin to flash), pressing a key will now start the rhythm with an "introduction".

* The SYNC START button will not function while a rhythm is running.

CHORD INTELLIGENCE

Pressing the CHORD INTELLIGENCE button  (LED lights), enables you to play chords in the lower section of the keyboard with but a finger or two. The CHORD INTELLIGENCE system let's you play major, minor, seventh, minor seventh, major seventh, minor seventh b5th, diminished, augmented, suspended fourth and suspended seventh chords.

* Pressing the CHORD INTELLIGENCE button will automatically select SPLIT 2 (if the latter was not selected previously).

The chords recognized on the E-10 are as follows:

Major (Ma)
Minor (mi)
Seventh (7)
Minor seventh (mi7)
Major seventh (Ma7)
Minor seventh b5th (ø)
Diminished (Dim)
Augmented (Aug)
Suspended fourth (Su4)
Suspended seventh (Su7)

PLAYING INTELLIGENT CHORDS

● Major Chords (Ma)

Playing just one key in the lower section of the keyboard will produce the Major chord of the same name; that is, playing C will give you C Major; G will give you G Major, etc.

C major

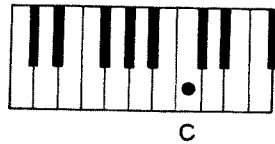

G major

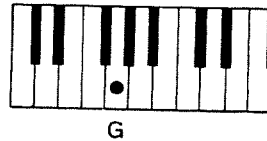

● Minor Chords (mi)

Minor Chords are formed by playing the one-note chord with an added note a minor third higher (three keys to the right).

Cm

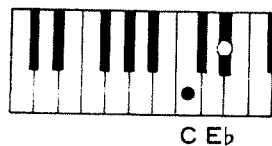

E_b m

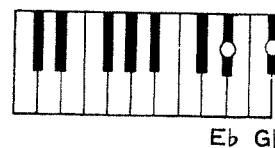

● Seventh Chords (7)

Two-note seventh chords can be formed by playing the one-note Major chord along with the note a whole step (two keys) to the left.

F7

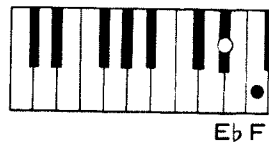

B_b 7

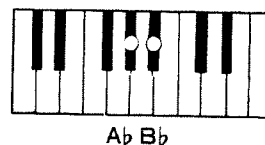

● Minor Seventh Chords (mi7)

Minor seventh chords are formed by playing the two notes that program a minor chord and then adding another note two keys to the left.

Cm7

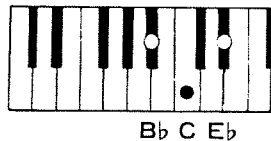

E_b m7

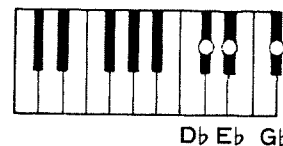

● **Major Seventh Chords (Ma7)**

Major seventh chords can be formed by playing the one-note Major chord along with the note immediately to the left.

CMa7

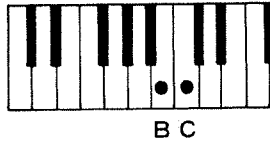

A^bMa7

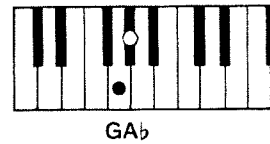

● **Minor Seventh b5th Chords (ø)**

Minor seventh b5th chords are played as four-note chords.

Cm7^b5

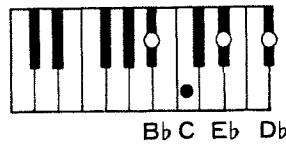

Gm7^b5

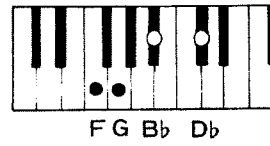

● **Diminished Chords (Dim)**

Diminished chords are played as three-note chords.

Bdim

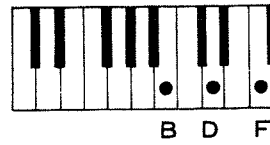

Cdim

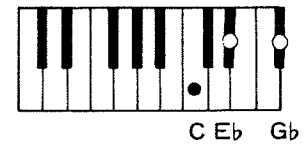

● **Augmented Chords (Aug)**

Augmented chords are played as three-note chords.

Caug

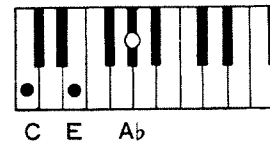

Faug

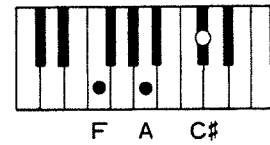

● Suspended Fourth Chords (Su4)

Suspended fourth chords are played as three-note chords..

Csu4



C F G

Fsu4



F B \flat C

● Suspended Seventh Chords (Su7)

Suspended seventh chords are played as four-note chords.

Csu7



C F G B \flat

Fsu7

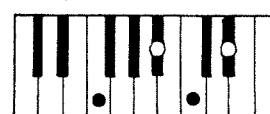

F B \flat C E \flat

* Without turning off the CHORD INTELLIGENCE, chords can still be played in the conventional way as well as the easy way described above.

MELODY INTELLIGENCE

MELODY INTELLIGENCE automatically adds a musical counter-melody note to single-note melodies. The feature operates with or without the rhythm playing. The harmonizing notes added to the melody are programmed by the type of chord that you play on the lower section of the keyboard. Pressing the MELODY INTELLIGENCE button (15) automatically selects SPLIT 2 (if the latter was not selected previously).

MELODY INTELLIGENCE will only function while a note(s) is played in the lower section or held with the MEMORY feature.

Pressing the same button again will turn off MELODY INTELLIGENCE.

ACCOMPANIMENT BALANCE

To adjust the volume of the accompaniment, press either ACCOMP "▷" button to increase or "◁" button to decrease the volume (29) (see TONE BALANCE).

To quickly turn off the Accompaniment, press ACCOMP "▷" and "◁" buttons simultaneously.

To turn the Accompaniment on again, press the ACCOMP "▷" and "◁" buttons again simultaneously.

REVERB EFFECT

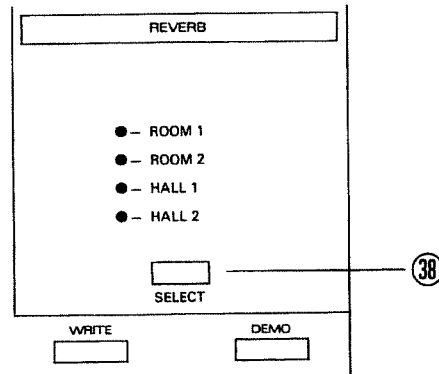

The E-10 also has a Digital Reverb unit built-in with a choice of Reverb types (see REVERB TYPE).

When the instrument is turned on, Reverb Type Room 2 will be selected. Room 2 LED will be lit.

REVERB TYPE

To change the type of Reverb effect, press the SELECT button 38 in the REVERB section. The different Reverb types can be selected by pressing the button successively. The order of selection is as follows:

OFF (no LEDS lit)
Room 1
Room 2 (turn-on setting)
Hall 1
Hall 2

* REVERB OFF/TYPE selection can be recorded into the USER PROGRAMS.

FUNCTION

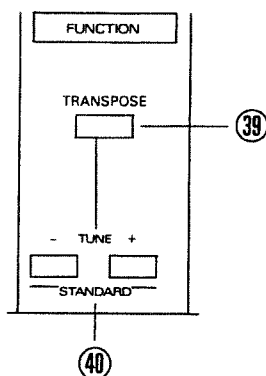

TRANS/TUNE

TRANPOSE

The Transpose feature lets you play in one key and hear the music in another key.

Press the TRANPOSE button (39) once. The TRANPOSE LED will light.

STANDARD pitch (C) is always selected when the instrument is turned on.

To change the pitch (Transpose) of the instrument, press the buttons (40) immediately below the TRANPOSE button, "+" to raise the pitch and "-" button to lower the pitch. The possible pitches that are selectable are C, C # , D, Eb, E, F, F # , G, Ab, A, Bb and B.

To quickly return the instrument to STANDARD pitch (C) press both "+" and "-" buttons simultaneously.

* TRANSPOSE settings can also be recorded into the User Programs.

MASTER TUNE

The Master Tune feature enables you to slightly raise or lower the pitch of your E-10. This feature is extremely useful when playing with other instruments that may not exactly match the pitch of the E-10.

Make sure that the TRANSPOSE LED is not lit. (If the LED is lit, press the TRANSPOSE switch once).

To change the Master Tune of the instrument, press the buttons immediately below the TRANSPOSE button, “+” to raise the Master Tune and “-” button to lower the Master Tune. The button can be pressed just once to change the Master Tune by one degree or if held will ‘scroll’ through the Master Tune range. The selectable range is from 427.5 Hz to 452.6 Hz.

* Any changes of Master Tune made will remembered even after the instrument is switched off.

To quickly return the instrument to STANDARD Tune (442.0 Hz), press both “+” and “-” buttons simultaneously.

SUSTAIN PEDAL

With the optional footswitch, sustain of the Upper tones can be controlled by the foot. The input socket (24) for the SUSTAIN PEDAL is located on the rear panel.

USER PROGRAMS

One of the advantages of the E-10 is its ability to produce a wide variety of instrumental tones and effects. Normally changing from one tone or effect to another involves activating several buttons. However, with Roland's digital technology, 4 User Programs provided on the instrument enable you to record 4 complete panel registrations of your choice which are recallable at the touch of a button.

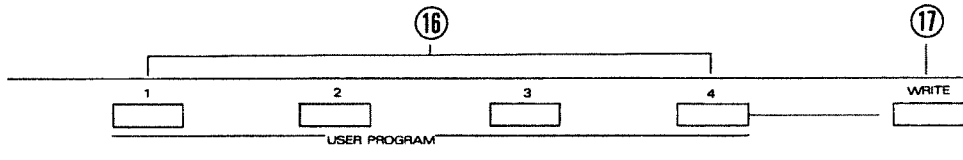

The following functions can be recorded into the User Programs:

- Upper Tone
- Lower Tone
- Bass Tone
- Volume Balance of each section (Upper, Lower, Accomp., Bass, Drum)
- Split On/Off, 1 & 2
- Rhythm
- Tempo
- Variation
- Arranger On/Off, 1 & 2
- Memory
- Sync Start
- Chord Intelligence
- Melody Intelligence
- Reverb Off/Type
- Manual Drum
- Transpose

The E-10 will arrive with 4 factory User Programs preset with the following configurations:

USER PROGRAM 1

Upper Tone — 23 SYN BRASS
Lower Tone — 11 ELEC PIANO
Bass Tone — 57 ACOU BASS
Volume Balances — as turn-on condition
Split — On, 2
Rhythm — 13 FUNK
Tempo — 110
Variation — Off
Arranger — On, 2
Memory — Off
Sync Start — Off
Chord Intelligence — Off
Melody Intelligence — Off
Reverb type — Hall 1
Manual Drum — Off
Transpose — C

USER PROGRAM 2

Upper Tone — 52 ELEC GTR
Lower Tone — 25 TROMBONE
Bass Tone — 61 ELEC BASS
Volume Balances — as turn-on condition
Split — On, 2
Rhythm — 22 ROCK 'N ROLL
Tempo — 172
Variation — Off
Arranger — On, 2
Memory — Off
Sync Start — Off
Chord Intelligence — Off
Melody Intelligence — Off
Reverb type — Room 2
Manual Drum — Off
Transpose — C

USER PROGRAM 3

Upper Tone — 25 TROMBONE
Lower Tone — 11 ELEC PIANO
Bass Tone — 57 ACOU BASS
Volume Balances — as turn-on condition
Split — On, 2
Rhythm — 24 SWING
Tempo — 120
Variation — Off
Arranger — On, 2
Memory — Off
Sync Start — Off
Chord Intelligence — Off
Melody Intelligence — Off
Reverb type — Hall 1
Manual Drum — Off
Transpose — C

USER PROGRAM 4

Upper Tone — 67 MARIMBA
Lower Tone — 17 ELEC ORGAN
Bass Tone — 57 ACOU BASS
Volume Balances — as turn-on condition
Split — On, 2
Rhythm — 38 CHA CHA
Tempo — 140
Variation — Off
Arranger — On, 2
Memory — Off
Sync Start — Off
Chord Intelligence — Off
Melody Intelligence — Off
Reverb type — Room 2
Manual Drum — Off
Transpose — C

WRITING A PANEL CONFIGURATION

1. Select any of the recordable functions you wish to record into the User Program.
2. Press the WRITE button (17) and hold.
3. While pressing the WRITE button, press one of the USER PROGRAM buttons (1-4) LED lights (16). The panel has now been recorded into the User Program number pressed.

To change another User Program, follow the same procedure as above.

The User Program contents will be retained until they are further changed. Turning the instrument off will not erase a recorded User Program.

To activate any of the User Programs, just press the number button you wish to use. The panel setting in that particular program will be recalled and the LED next to the button will light indicating which User Program is activated. To cancel a User Program, press the same User Program button a second time (LED will be turned off). The program will now be canceled and the panel registration before selecting a User Program will return. This is called User Program 0 (not indicated on the panel).

If you wish to reset the factory preset User Programs (1-4):

1. Turn the E-10 off if it is already on.
2. Press the WRITE button (17) and hold it.
3. Turn the E-10 back on.

The three Tone Select LEDs and four Reverb LEDs will light. Continue to hold the WRITE button until all four User Program LEDs light and then release. The factory User Program settings have now been loaded into the E-10.

NOTE: This procedure will erase any settings contained in the User Programs prior to loading the factory User Program settings.

SONG COMPOSER

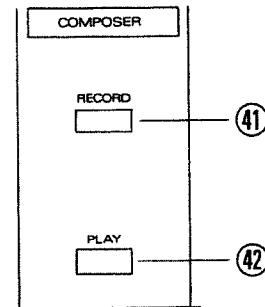

The SONG COMPOSER is a unique «Melody and Accompaniment Digital Recorder» that can record and store a complete song of melody and accompaniment for playback at any time.

The tempo of the recorded song is variable, so that a recording made at a slow speed can be replayed at a faster (or slower) tempo. What is actually recorded is the chord progression, melody notes, tones and effects.

Accompaniment and melody are recorded simultaneously.

The maximum amount of chord changes recordable in one measure is 96.

The minimum length of melody notes that can be recorded in one measure is a sixty-fourth note triplet ().

Accompaniment, melody notes, tones and effects recorded in the Composer will be retained until they are changed. Turning the instrument off will not erase a recorded song.

RECORDING A SONG

1. Stop the rhythm if already playing.
2. Press the RECORD button (41) in the Song Composer section (RECORD LED will light).

(Pressing RECORD button will automatically select SPLIT 2 position if it was switched off).

3. Select the rhythm you wish to use while recording, and select tones and effects.

The recording can be started in three ways:

- a) Press the START/STOP button and the rhythm and recording starts immediately.
- b) Press the SYNC START button (LED lights). Then press a chord in the accompaniment section of the keyboard. Rhythm and recording will begin automatically (LED off).
- c) Press the INTRO/ENDING button and the recording will start with the "introduction" to the rhythm selected.

* The Intro can also be selected with the SYNC START function. Press the INTRO/ENDING button after pressing the SYNC START button (Sync Start LED begins to flash). Then play a chord in the accompaniment section and the recording will begin with the "introduction".

In addition to recording chord and melody note information, the Composer can also record the following functions:

- Tone change (UPPER, LOWER, BASS)
- Rhythm Change
- Variation
- Arranger On/Off, 1 & 2
- Fill-In to Variation
- Fill-In to Original
- Intro
- Ending
- User Program change
- Volume Balance change (UPPER, BASS, ACCOMP, DRUMS)
- Sustain (using the optional footswitch)

The Song Composer will inform you when you are approaching the full memory capacity of the song you are recording by flashing the RECORD LED. This occurs when only 10% of the memory is remaining.

* When the total memory capacity is reached, recording will be automatically switched off. The rhythm will automatically be switched off and RECORD LED will be turned off.

PLAYING BACK A SONG

1. To play back the song you have just recorded, press the PLAY button (42) (LED lights).
2. Press the START/STOP button and playback of the song will begin.

-or-

Press the SYNC START button, then press a note in the lower section of the keyboard.

The song will automatically stop after playing the final measure, or the song can be stopped at any time by pressing the START/STOP button (PLAY LED is turned off).

If you wish the song to playback repeatedly, press the PLAY button one more time (LED will start to flash). To cancel the "loop" feature press the PLAY button again until the LED lights constantly.

MIDI CONTROL

M.I.D.I. is the acronym for Musical Instrument Digital Interface.

MIDI is a standardized interface by which all digital musical instruments also equipped with MIDI connections can exchange data. This means that your E-10 can be used as a MIDI control keyboard - to control other MIDI devices (keyboard, sequencer, etc.) or as a MIDI sound source (to be controlled by other MIDI devices).

CONNECTIONS

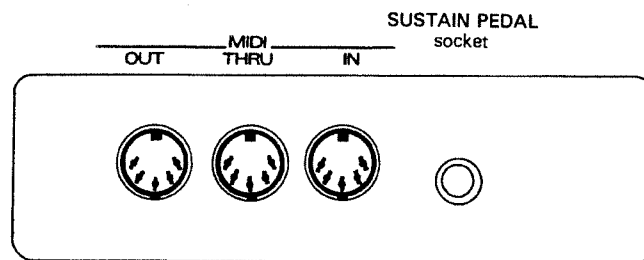

MIDI sockets on the rear panel

Switch off the E-10 and all other MIDI devices.
There are three MIDI sockets on the rear panel of the E-10 as follows:

- **MIDI OUT socket**
Use this socket for sending MIDI signals from the E-10 to control external MIDI devices.
- **MIDI THRU socket**
The exact copy of the signal fed into the MIDI IN is sent out through this socket.
- **MIDI IN socket**
Use this socket for feeding MIDI signals from an external MIDI device to control the E-10 and make it operate as a sound source.

* The signal fed into the MIDI IN is not sent out through MIDI OUT.

Example:

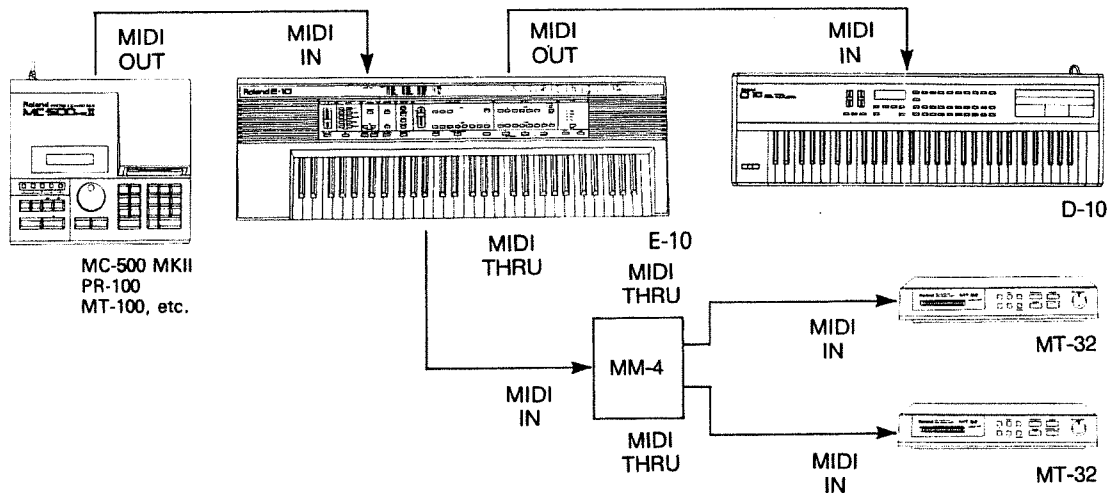

- * When connecting, switch off the E-10 and all other MIDI devices.
- * Do not connect more than 3 MIDI devices through the MIDI THRU sockets. Use the optional MIDI THRU box (MM-4) in this case.

As was explained above, the E-10 delivers a lot of musical capability with ARRANGER, VARIATION, CHORD INTELLIGENCE and MELODY INTELLIGENCE.

You can also get an additional 2 parts (1st and 2nd RX ONLY parts which cannot be played with the E-10 alone) with 128 tones available for selection when the E-10 is controlled by external MIDI devices such as the MC/PR series sequencers. Then the E-10 will perform most 9-part orchestrations.

See MIDI IMPLEMENTATION CHART for details on the MIDI data which the E-10 can transmit and receive (recognize).

- * For additional information on advanced MIDI Control, see your Roland dealer.

128 TONES AVAILABLE by EXTERNAL MIDI PROGRAM CHANGE

When using an external MIDI device to control the sound source within the E-10, a total of 128 tones can be played.

The 128 tones available are:

Tone Name	Prog-No.	HP-Prog.
Elec Piano 1	001	A11
Elec Piano 2	002	A12
Elec Piano 3	003	A13
Honkytonk	004	A14
Harpsichord 1	005	A15
Clavi 1	006	A16
Celesta 1	007	A17
Harp 1	008	A18
Elec Organ 1	009	A21
Elec Organ 2	010	A22
Elec Organ 3	011	A23
Pipe Organ 1	012	A24
Pipe Organ 2	013	A25
Breathpipe	014	A26
Shakuhachi	015	A27
Accordion	016	A28
Syn Brass 1	017	A31
Syn Brass 2	018	A32
Syn Brass 3	019	A33
Trumpet 1	020	A34
Trombone 1	021	A35
French Horn 1	022	A36
Brass Sect 1	023	A37
Sax 1	024	A38
String Sect 1	025	A41
String Sect 2	026	A42
Pizzicato	027	A43
Violin 1	028	A44
Orch Hit	029	A45
Chorale	030	A46
Soundtrack	031	A47
Whistle	032	A48
Fantasy	033	A51
Atmosphere	034	A52
Warm Bell	035	A53
Echo Bell	036	A54
Water Bell	037	A55
Echo Pan	038	A56
Doctor Solo	039	A57
Square Wave	040	A58
Guitar 1	041	A61
Guitar 2	042	A62
Elec Guitar 1	043	A63
Elec Guitar 2	044	A64
Flute 1	045	A65
Pan Pipes	046	A66
Clarinet 1	047	A67
Harmonica	048	A68
Acou Bass 1	049	A71
Acou Bass 2	050	A72
Elec Bass 1	051	A73
Slap Bass 1	052	A74
Slap Bass 2	053	A75
Fretless 1	054	A76
Fretless 2	055	A77
Contrabass	056	A78
Vibe 1	057	A81
Vibe 2	058	A82
Glock	059	A83
Xylophone	060	A84
Marimba	061	A85
Jungle Tune	062	A86
Ice rain	063	A87
Telephone	064	A88

Tone Name	Prog-No.	HP-Prog.
Acou Piano 1	065	B11
Acou Piano 2	066	B12
Acou Piano 3	067	B13
Elec Piano 4	068	B14
Elec Organ 4	069	B15
Pipe Organ 3	070	B16
Harpsichord 2	071	B17
Harpsichord 3	072	B18
Clavi 2	073	B21
Clavi 3	074	B22
Celesta 2	075	B23
Syn Brass 4	076	B24
Syn Bass 1	077	B25
Syn Bass 2	078	B26
Syn Bass 3	079	B27
Syn Bass 4	080	B28
Harmo Pan	081	B31
Glasses	082	B32
Funny Vox	083	B33
Oboe 2001	084	B34
Schooldaze	085	B35
Bellsinger	086	B36
String Sect 3	087	B37
Violin 2	088	B38
Cello 1	089	B41
Cello 2	090	B42
Harp 2	091	B43
Sitar	092	B44
Elec Bass 2	093	B45
Flute 2	094	B46
Piccolo 1	095	B47
Piccolo 2	096	B48
Recorder	097	B51
Sax 2	098	B52
Sax 3	099	B53
Sax 4	100	B54
Clarinet 2	101	B55
Oboe	102	B56
English Horn	103	B57
Bassoon	104	B58
Trumpet 2	105	B61
Trombone 2	106	B62
French Horn 2	107	B63
Tuba	108	B64
Brass Sect 2	109	B65
Syn Mallet	110	B66
Windbell	111	B67
Tube Bell	112	B68
Koto	113	B71
Sho	114	B72
Whistle 2	115	B73
Bottleblow	116	B74
Timpani	117	B75
Melodic Tom	118	B76
Deep Snare	119	B77
Elec Perc 1	120	B78
Elec Perc 2	121	B81
Taiko	122	B82
Taiko Rim	123	B83
Cymbal	124	B84
Castanets	125	B85
Triangle	126	B86
Bird Tweet	127	B87
One Note Jam	128	B88

* "HP-Prog." stands for the Program Change numbers transmitted by the Roland HP Piano series.

IF YOUR E-10 FAILS TO OPERATE:

- Make sure that the AC cord is firmly plugged into the AC socket on the rear panel. Also check that the AC wall outlet is not faulty. Plug in a lamp or radio to test the wall outlet.
- Be sure the ON/OFF switch (located on the rear of the top panel) is ON.
- In the event the instrument is still inoperable, your Roland technician or dealer is best qualified to provide you with competent service. Do not attempt any adjustments or repairs by yourself.

<Reference>

The E-10 will always select the following features, when it is turned on (These are often called the Default settings):

Upper Tone	— 11 ELEC PIANO
Lower Tone	— 32 STRING SECT2
Bass Tone	— 57 ACOU BASS
Tone Balance of each section:	
(Upper 100)	
(Lower 80)	
(Accomp 75)	
(Bass 90)	
(Drums 90)	
Split	— Off position
Rhythm	— 16 8 BEAT
Tempo	— 110
Variation	— Off position
Arranger	— Off position
Memory	— Off position
Sync Start	— Off position
Chord Intelligence	— Off position
Melody Intelligence	— Off position
Reverb Type	— Room 2
Manual Drum	— Off position
Transpose	— in C
Fine Tune	— 442.0 Hz

MIDI IMPLEMENTATION CHART

FUNCTION		TRANSMITTED	RECOGNIZED	REMARKS
Basic	Default	2—3—4—5—6 7—10	2—3—4—5—6 7—8 OFF—9 10 OFF	2=BASS 6=ACCOMP2 3=LOWER 7=ACCOMP3 4=UPPER 8=1RX ONLY 5=ACCOMP1 9=2RX ONLY 10=DRUM
Channel	Changed	*****	1—16	
Mode	Default Message Altered	MODE 3 × *****	MODE 3 × ×	
Note Number	True voice	18—102 *****	0—127 12—108	
Velocity	Note ON Note OFF	○ ×	○ ×	
After Touch	Key's Ch's	× ×	× ×	
Pitch Bender		×	○	
Control Change	1 7 10 11 12—63 64 65—120 121	× ○ × × × ○ × ×	○ ○ ○ ○ × ○ × ○	MODULATION PART VOLUME PAN POT EXPRESSION HOLD 1 RESET ALL CONTROLLERS
Program Change	True #	0-47 *****	0—127 0—127	RHYTHM PATTERN 0-47 80-83
System Exclusive		○	○	
System Common	: Song Pos. : Song Sel : Tune	× × ×	× × ×	
System Real Time	: Clock : Commands	○ ○	○ ○	
Aux Messages	: Local ON/OFF : All Notes OFF : Active Sense : Reset	× × × ×	× ○ (123—127) × ×	
Notes				

Mode 1 : OMNI ON, POLY
Mode 2 : OMNI OFF, POLY

Mode 3 : OMNI ON, MONO
Mode 4 : OMNI OFF, MONO

○ : Yes
× : No

SPECIFICATIONS

Keyboard:	61 keys velocity sensitive
Sound Source System:	LA Digital Synthesis
Built-in Effect:	Digital Reverb (4 types: Hall 1-2, Room 1-2)
Panel Switch/Control:	
VOLUME:	Master Volume Control
BALANCE:	Upper, Lower, Accomp, Bass, Drum.
FUNCTION:	Transpose/Master Tune
COMPOSER:	Record and Play (Upper and Lower keyboard) (approx. 200 measures)
ARRANGER:	On/Off, Chord Intelligence, Memory, Sync Start
RHYTHM SECTION:	Bank 1-4, Number 1-8, Tempo Slider, Variation for each rhythm.
tone SELECT:	Upper, Lower, Bass, Bank 1-4, Number 1-8.
REVERB:	Off, Type (4 types)
Real Time Switches:	Manual Drum, Split 1/2, Fill-in (To Variation, To Original), Intro/Ending, Arranger 1/2, Start/Stop, Melody Intelligence, User Program 1-4, Write, Demo.
Rear Panel Terminal:	AUX IN (Right, Left/Mono) AUX OUT (Right/Mono, Left) MIDI (OUT, THRU, IN) SUSTAIN PEDAL
Front Panel Terminal:	Headphones
Built-in Speakers:	120mm × 2
Power Amplifier:	5 W × 2 (stereo)
Dimensions:	1023 mm (W) × 100 mm (H) × 330 mm (D)
Weight:	12 kg
Options:	Footswitch (DP-2/DP-6) Stereo Expression Pedal (FV-200) Keyboard Stand (KS-8)

PANEL SETTING MEMO

Please write your original panel settings on the memo below so you will have written record of them.

SONG TITLE: _____

DATE:

	TONE NUMBER	VOLUME BALANCE	ON/OFF
UPPER			ON / OFF
LOWER			ON / OFF
BASS			ON / OFF
DRUMS			ON / OFF
ACCOMP.			ON / OFF

SPLIT	ON / OFF
SPLIT	1 / 2
VARIATION	ON / OFF
TEMPO	♩ =
ARRANGER	1 / 2
CHORD INTELLIGENCE	ON / OFF
MEMORY	ON / OFF
SYNC START	ON / OFF
MELODY INTELLIGENCE	ON / OFF
MANUAL DRUM	ON / OFF
TRANSPOSE	KEY in
REVERB EFFECT	ON / OFF
REVERB TYPE	ROOM 1, ROOM 2, HALL 1, HALL 2

MODEL: ROLAND E-10 SYNTHESIZER

PANEL SETTING MEMO

Please write your original panel settings on the memo below so you will have written record of them.

SONG TITLE: _____

DATE:

	TONE NUMBER	VOLUME BALANCE	ON/OFF
UPPER			ON / OFF
LOWER			ON / OFF
BASS			ON / OFF
DRUMS			ON / OFF
ACCOMP.			ON / OFF

SPLIT	ON / OFF
SPLIT	1 / 2
VARIATION	ON / OFF
TEMPO	J =
ARRANGER	1 / 2
CHORD INTELLIGENCE	ON / OFF
MEMORY	ON / OFF
SYNC START	ON / OFF
MELODY INTELLIGENCE	ON / OFF
MANUAL DRUM	ON / OFF
TRANSPOSE	KEY in
REVERB EFFECT	ON / OFF
REVERB TYPE	ROOM 1, ROOM 2, HALL 1, HALL 2

MODEL: ROLAND E-10 SYNTHESIZER

PANEL SETTING MEMO

Please write your original panel settings on the memo below so you will have written record of them.

SONG TITLE:

DATE:

	TONE NUMBER	VOLUME BALANCE	ON/OFF
UPPER			ON / OFF
LOWER			ON / OFF
BASS			ON / OFF
DRUMS			ON / OFF
ACCOMP.			ON / OFF

SPLIT	ON / OFF
SPLIT	1 / 2
VARIATION	ON / OFF
TEMPO	♩ =
ARRANGER	1 / 2
CHORD INTELLIGENCE	ON / OFF
MEMORY	ON / OFF
SYNC START	ON / OFF
MELODY INTELLIGENCE	ON / OFF
MANUAL DRUM	ON / OFF
TRANSPOSE	KEY in
REVERB EFFECT	ON / OFF
REVERB TYPE	ROOM 1, ROOM 2, HALL 1, HALL 2

MODEL: ROLAND E-10 SYNTHESIZER

 Roland®

17049511

UPC 17049511



18981

E-10

Printed in Italy by F.lli Anichini Ancona

89-3-E-10-DM-E

 Roland