

Roland®

# BI-AMP MONITOR DS-8/7/5

24-BIT/192 KHZ

## OWNER'S MANUAL

Thank you for purchasing the Roland Bi-Amp Monitor DS-8/7/5.

Before using this unit, carefully read the sections entitled: "IMPORTANT SAFETY INSTRUCTIONS" (p. 3), "USING THE UNIT SAFELY" (p. 4), and "IMPORTANT NOTES" (p. 5). These sections provide important information concerning the proper operation of the unit. Additionally, in order to feel assured that you have gained a good grasp of every feature provided by your new unit, Owner's manual should be read in its entirety. The manual should be saved and kept on hand as a convenient reference.

### Main Features

#### ● In Pursuit of High Sound Quality

The DS-8/7/5 powered monitor uses a two-way, bi-amplifier design to achieve high sound quality.

The LF driver and dome HF driver use separate amps sections for LF and HF, ensuring optimal sound quality.

In particular, the DS-8/7 feature completely discrete DC power amps for the highest possible quality.

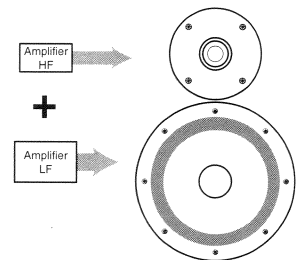

#### ● Analog Input

In addition to an XLR connector, which provides for balanced input, a 1/4" TRS phone jack accommodating either balanced or unbalanced input is also provided. This assures broad-ranging connectivity.

#### ● Digital Input

The digital inputs (coaxial and optical) support 24-bit digital audio data at sampling rates up to 192 kHz. AES/EBU professional audio format digital input is also provided.

Digitally input signals are reproduced faithfully through 24-bit D/A conversion, thus preventing noise or a drop in sound quality.

You can use the monitors with a wide variety of equipment and applications through selective use of the analog and digital settings.

#### ● Magnetically Shielded Low- and High-Frequency Drivers

This allows you to use the speakers next to CRT displays.

Copyright © 2004 ROLAND CORPORATION

All rights reserved. No part of this publication may be reproduced in any form without the written permission of ROLAND CORPORATION.



This product complies with the requirements of European Directives EMC 89/336/EEC and LVD 73/23/EEC.

For EU Countries

## FEDERAL COMMUNICATIONS COMMISSION RADIO FREQUENCY INTERFERENCE STATEMENT

This equipment has been tested and found to comply with the limits for a Class B digital device, pursuant to Part 15 of the FCC Rules. These limits are designed to provide reasonable protection against harmful interference in a residential installation. This equipment generates, uses, and can radiate radio frequency energy and, if not installed and used in accordance with the instructions, may cause harmful interference to radio communications. However, there is no guarantee that interference will not occur in a particular installation. If this equipment does cause harmful interference to radio or television reception, which can be determined by turning the equipment off and on, the user is encouraged to try to correct the interference by one or more of the following measures:

- Reorient or relocate the receiving antenna.
- Increase the separation between the equipment and receiver.
- Connect the equipment into an outlet on a circuit different from that to which the receiver is connected.
- Consult the dealer or an experienced radio/TV technician for help.

This device complies with Part 15 of the FCC Rules. Operation is subject to the following two conditions:

- (1) This device may not cause harmful interference, and
- (2) This device must accept any interference received, including interference that may cause undesired operation.

Unauthorized changes or modification to this system can void the users authority to operate this equipment.  
This equipment requires shielded interface cables in order to meet FCC class B Limit.

For the USA



## NOTICE

This Class B digital apparatus meets all requirements of the Canadian Interference-Causing Equipment Regulations.

For Canada

## AVIS

Cet appareil numérique de la classe B respecte toutes les exigences du Règlement sur le matériel brouilleur du Canada.

	<b>CAUTION</b> RISK OF ELECTRIC SHOCK DO NOT OPEN	
<b>ATTENTION:</b> RISQUE DE CHOC ELECTRIQUE NE PAS OUVRIR		
<b>CAUTION:</b> TO REDUCE THE RISK OF ELECTRIC SHOCK, DO NOT REMOVE COVER (OR BACK). NO USER-SERVICEABLE PARTS INSIDE. REFER SERVICING TO QUALIFIED SERVICE PERSONNEL.		



The lightning flash with arrowhead symbol, within an equilateral triangle, is intended to alert the user to the presence of uninsulated "dangerous voltage" within the product's enclosure that may be of sufficient magnitude to constitute a risk of electric shock to persons.



The exclamation point within an equilateral triangle is intended to alert the user to the presence of important operating and maintenance (servicing) instructions in the literature accompanying the product.

INSTRUCTIONS PERTAINING TO A RISK OF FIRE, ELECTRIC SHOCK, OR INJURY TO PERSONS.

## IMPORTANT SAFETY INSTRUCTIONS SAVE THESE INSTRUCTIONS

**WARNING** - When using electric products, basic precautions should always be followed, including the following:

1. Read these instructions.
2. Keep these instructions.
3. Heed all warnings.
4. Follow all instructions.
5. Do not use this apparatus near water.
6. Clean only with a dry cloth.
7. Do not block any of the ventilation openings. Install in accordance with the manufacturers instructions.
8. Do not install near any heat sources such as radiators, heat registers, stoves, or other apparatus (including amplifiers) that produce heat.
9. Do not defeat the safety purpose of the polarized or grounding-type plug. A polarized plug has two blades with one wider than the other. A grounding type plug has two blades and a third grounding prong. The wide blade or the third prong are provided for your safety. When the provided plug does not fit into your outlet, consult an electrician for replacement of the obsolete outlet.
10. Protect the power cord from being walked on or pinched particularly at plugs, convenience receptacles, and the point where they exit from the apparatus.
11. Only use attachments/accessories specified by the manufacturer.
12. Never use with a cart, stand, tripod, bracket, or table except as specified by the manufacturer, or sold with the apparatus. When a cart is used, use caution when moving the cart/apparatus combination to avoid injury from tip-over. 
13. Unplug this apparatus during lightning storms or when unused for long periods of time.
14. Refer all servicing to qualified service personnel. Servicing is required when the apparatus has been damaged in any way, such as power-supply cord or plug is damaged, liquid has been spilled or objects have fallen into the apparatus, the apparatus has been exposed to rain or moisture, does not operate normally, or has been dropped.

For the U.K.

**WARNING:** THIS APPARATUS MUST BE EARTHED  
**IMPORTANT:** THE WIRES IN THIS MAINS LEAD ARE COLOURED IN ACCORDANCE WITH THE FOLLOWING CODE.  
 GREEN-AND-YELLOW: EARTH, BLUE: NEUTRAL, BROWN: LIVE

As the colours of the wires in the mains lead of this apparatus may not correspond with the coloured markings identifying the terminals in your plug, proceed as follows:

The wire which is coloured GREEN-AND-YELLOW must be connected to the terminal in the plug which is marked by the letter E or by the safety earth symbol  or coloured GREEN or GREEN-AND-YELLOW.

The wire which is coloured BLUE must be connected to the terminal which is marked with the letter N or coloured BLACK.

The wire which is coloured BROWN must be connected to the terminal which is marked with the letter L or coloured RED.

# USING THE UNIT SAFELY

## INSTRUCTIONS FOR THE PREVENTION OF FIRE, ELECTRIC SHOCK, OR INJURY TO PERSONS

### About ⚠ WARNING and ⚠ CAUTION Notices

<b>⚠ WARNING</b>	Used for instructions intended to alert the user to the risk of death or severe injury should the unit be used improperly.
<b>⚠ CAUTION</b>	Used for instructions intended to alert the user to the risk of injury or material damage should the unit be used improperly. * Material damage refers to damage or other adverse effects caused with respect to the home and all its furnishings, as well to domestic animals or pets.

### About the Symbols

	The ⚠ symbol alerts the user to important instructions or warnings. The specific meaning of the symbol is determined by the design contained within the triangle. In the case of the symbol at left, it is used for general cautions, warnings, or alerts to danger.
	The ⚡ symbol alerts the user to items that must never be carried out (are forbidden). The specific thing that must not be done is indicated by the design contained within the circle. In the case of the symbol at left, it means that the unit must never be disassembled.
	The ● symbol alerts the user to things that must be carried out. The specific thing that must be done is indicated by the design contained within the circle. In the case of the symbol at left, it means that the power-cord plug must be unplugged from the outlet.

### ALWAYS OBSERVE THE FOLLOWING

<b>⚠ WARNING</b>	<b>⚠ WARNING</b>	<b>⚠ CAUTION</b>
<ul style="list-style-type: none"> <li>Before using this unit, make sure to read the instructions below, and the Owner's Manual. </li> </ul>	<ul style="list-style-type: none"> <li>Do not allow any objects (e.g., flammable material, coins, pins); or liquids of any kind (water, soft drinks, etc.) to penetrate the unit. </li> </ul>	<ul style="list-style-type: none"> <li>The unit should be located so that its location or position does not interfere with its proper ventilation. </li> </ul>
<ul style="list-style-type: none"> <li>Do not open or perform any internal modifications on the unit. </li> </ul>	<ul style="list-style-type: none"> <li>Immediately turn the power off, remove the power cord from the outlet, and request servicing by your retailer, the nearest Roland Service Center, or an authorized Roland distributor, as listed on the "Information" page when:                             <ul style="list-style-type: none"> <li>The power-supply cord, or the plug has been damaged; or</li> <li>If smoke or unusual odor occurs</li> <li>Objects have fallen into, or liquid has been spilled onto the unit; or</li> <li>The unit has been exposed to rain (or otherwise has become wet); or</li> <li>The unit does not appear to operate normally or exhibits a marked change in performance.</li> </ul> </li> </ul>	<ul style="list-style-type: none"> <li>Always grasp only the plug on the power-supply cord when plugging into, or unplugging from, an outlet or this unit. </li> </ul>
<ul style="list-style-type: none"> <li>Do not attempt to repair the unit, or replace parts within it (except when this manual provides specific instructions directing you to do so). Refer all servicing to your retailer, the nearest Roland Service Center, or an authorized Roland distributor, as listed on the "Information" page. </li> </ul>	<ul style="list-style-type: none"> <li>In households with small children, an adult should provide supervision until the child is capable of following all the rules essential for the safe operation of the unit. </li> </ul>	<ul style="list-style-type: none"> <li>At regular intervals, you should unplug the power plug and clean it by using a dry cloth to wipe all dust and other accumulations away from its prongs. Also, disconnect the power plug from the power outlet whenever the unit is to remain unused for an extended period of time. Any accumulation of dust between the power plug and the power outlet can result in poor insulation and lead to fire. </li> </ul>
<ul style="list-style-type: none"> <li>Never use or store the unit in places that are:                             <ul style="list-style-type: none"> <li>Subject to temperature extremes (e.g., direct sunlight in an enclosed vehicle, near a heating duct, on top of heat-generating equipment); or are </li> <li>Damp (e.g., baths, washrooms, on wet floors); or are </li> <li>Humid; or are</li> <li>Exposed to rain; or are</li> <li>Dusty; or are</li> <li>Subject to high levels of vibration.</li> </ul> </li> </ul>	<ul style="list-style-type: none"> <li>Protect the unit from strong impact. (Do not drop it!) </li> </ul>	<ul style="list-style-type: none"> <li>Try to prevent cords and cables from becoming entangled. Also, all cords and cables should be placed so they are out of the reach of children. </li> </ul>
<ul style="list-style-type: none"> <li>Make sure you always have the unit placed so it is level and sure to remain stable. Never place it on stands that could wobble, or on inclined surfaces. </li> </ul>	<ul style="list-style-type: none"> <li>Do not force the unit's power-supply cord to share an outlet with an unreasonable number of other devices. Be especially careful when using extension cords—the total power used by all devices you have connected to the extension cord's outlet must never exceed the power rating (watts/ amperes) for the extension cord. Excessive loads can cause the insulation on the cord to heat up and eventually melt through. </li> </ul>	<ul style="list-style-type: none"> <li>Never climb on top of, nor place heavy objects on the unit. </li> </ul>
<ul style="list-style-type: none"> <li>The unit should be connected to a power supply only of the type described in the operating instructions, or as marked on the rear side of unit. </li> </ul>	<ul style="list-style-type: none"> <li>Before using the unit in a foreign country, consult with your retailer, the nearest Roland Service Center, or an authorized Roland distributor, as listed on the "Information" page. </li> </ul>	<ul style="list-style-type: none"> <li>Never handle the power cord or its plugs with wet hands when plugging into, or unplugging from, an outlet or this unit. </li> </ul>
<ul style="list-style-type: none"> <li>Use only the attached power-supply cord. Also, the supplied power cord must not be used with any other device. </li> </ul>	<ul style="list-style-type: none"> <li>Do not put anything that contains water (e.g., flower vases) on this unit. Also, avoid the use of insecticides, perfumes, alcohol, nail polish, spray cans, etc., near the unit. Swiftly wipe away any liquid that spills on the unit using a dry, soft cloth. </li> </ul>	<ul style="list-style-type: none"> <li>Before moving the unit, disconnect the power plug from the outlet, and pull out all cords from external devices. </li> </ul>
<ul style="list-style-type: none"> <li>Do not excessively twist or bend the power cord, nor place heavy objects on it. Doing so can damage the cord, producing severed elements and short circuits. Damaged cords are fire and shock hazards! </li> </ul>		<ul style="list-style-type: none"> <li>Before cleaning the unit, turn off the power and unplug the power cord from the outlet. </li> </ul>
<ul style="list-style-type: none"> <li>This unit, either alone or in combination with an amplifier and headphones or speakers, may be capable of producing sound levels that could cause permanent hearing loss. Do not operate for a long period of time at a high volume level, or at a level that is uncomfortable. If you experience any hearing loss or ringing in the ears, you should immediately stop using the unit, and consult an audiologist. </li> </ul>		<ul style="list-style-type: none"> <li>Whenever you suspect the possibility of lightning in your area, pull the plug on the power cord out of the outlet. </li> </ul>
		<ul style="list-style-type: none"> <li>The top of the unit may become hot, so take care to avoid burns. </li> </ul>

# IMPORTANT NOTES

In addition to the items listed under “IMPORTANT SAFETY INSTRUCTIONS” and “USING THE UNIT SAFELY” on pages page 3 and page 4, please read and observe the following:

## Power Supply

- Do not connect this unit to same electrical outlet that is being used by an electrical appliance that is controlled by an inverter (such as a refrigerator, washing machine, microwave oven, or air conditioner), or that contains a motor. Depending on the way in which the electrical appliance is used, power supply noise may cause this unit to malfunction or may produce audible noise. If it is not practical to use a separate electrical outlet, connect a power supply noise filter between this unit and the electrical outlet.
- Before connecting this unit to other devices, turn off the power to all units. This will help prevent malfunctions and/or damage to speakers or other devices.
- Although the LCD and LEDs are switched off when the POWER switch is switched off, this does not mean that the unit has been completely disconnected from the source of power. If you need to turn off the power completely, first turn off the POWER switch, then unplug the power cord from the power outlet. For this reason, the outlet into which you choose to connect the power cord’s plug should be one that is within easy reach.

## Placement

- Using the unit near power amplifiers (or other equipment containing large power transformers) may induce hum. To alleviate the problem, change the orientation of this unit; or move it farther away from the source of interference.
- This device may interfere with radio and television reception. Do not use this device in the vicinity of such receivers.
- Noise may be produced if wireless communications devices, such as cell phones, are operated in the vicinity of this unit. Such noise could occur when receiving or initiating a call, or while conversing. Should you experience such problems, you should relocate such wireless devices so they are at a greater distance from this unit, or switch them off.
- Do not expose the unit to direct sunlight, place it near devices that radiate heat, leave it inside an enclosed vehicle, or otherwise subject it to temperature extremes. Also, do not allow lighting devices that normally are used while their light source is very close to the unit (such as a piano light), or powerful spotlights to shine upon the same area of the unit for extended periods of time. Excessive heat can deform or discolor the unit.
- When moved from one location to another where the temperature and/or humidity is very different, water droplets (condensation) may form inside the unit. Damage or malfunction may result if you attempt to use the unit in this condition. Therefore, before using the unit, you must allow it to stand for several hours, until the condensation has completely evaporated.
- Do not allow rubber, vinyl, or similar materials to remain on the unit for long periods of time. Such objects can discolor or otherwise harmfully affect the finish.
- Do not paste stickers, decals, or the like to this instrument. Peeling such matter off the instrument may damage the exterior finish.

## Maintenance

- To clean the unit, use a dry, soft cloth; or one that is slightly dampened. Try to wipe the entire surface using an equal amount of strength, moving the cloth along with the grain of the wood. Rubbing too hard in the same area can damage the finish.
- Never use benzene, thinners, alcohol or solvents of any kind, to avoid the possibility of discoloration and/or deformation.

## Additional Precautions

- Use a reasonable amount of care when using the unit’s buttons, sliders, or other controls; and when using its jacks and connectors. Rough handling can lead to malfunctions.
- When connecting / disconnecting all cables, grasp the connector itself—never pull on the cable. This way you will avoid causing shorts, or damage to the cable’s internal elements.
- A small amount of heat will radiate from the unit during normal operation.
- To avoid disturbing your neighbors, try to keep the unit’s volume at reasonable levels (especially when it is late at night).
- When you need to transport the unit, package it in the box (including padding) that it came in, if possible. Otherwise, you will need to use equivalent packaging materials.
- Use a cable from Roland to make the connection. If using some other make of connection cable, please note the following precautions.
  - Some connection cables contain resistors. Do not use cables that incorporate resistors for connecting to this unit. The use of such cables can cause the sound level to be extremely low, or impossible to hear. For information on cable specifications, contact the manufacturer of the cable.
- Avoid inserting fingers into the bass reflex ducts when transporting or handling the unit. Otherwise, you risk getting your fingers stuck.

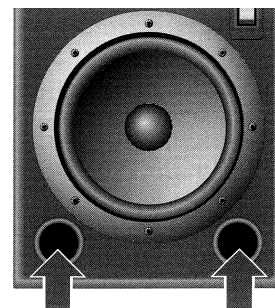

# Panel Descriptions

## Front

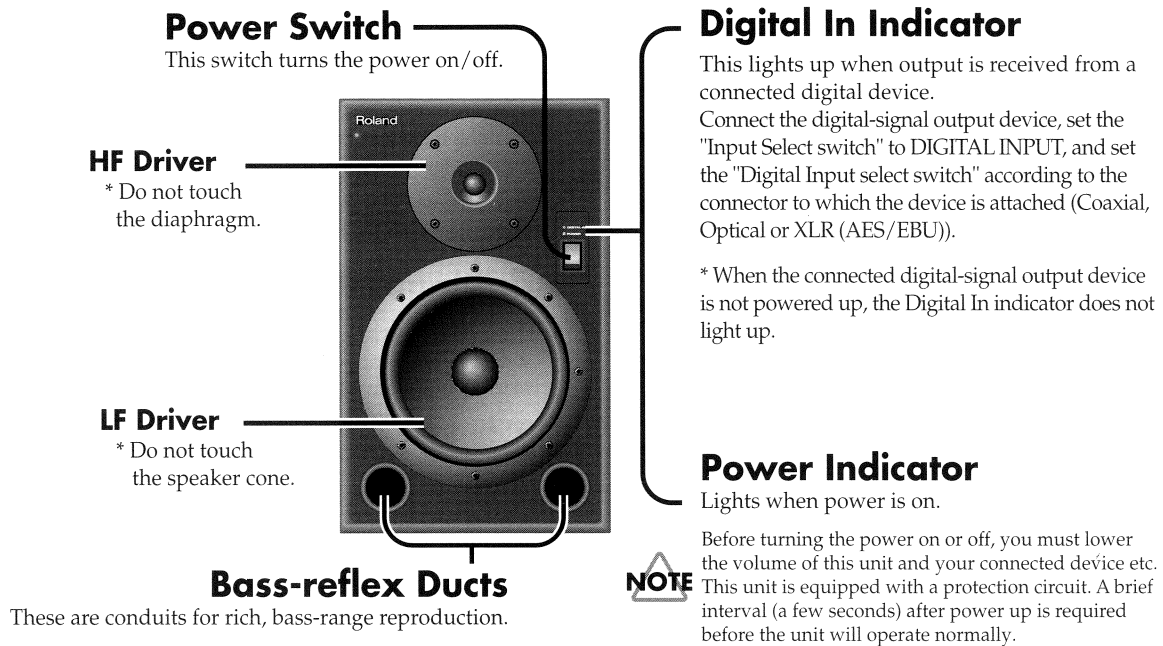

## Rear

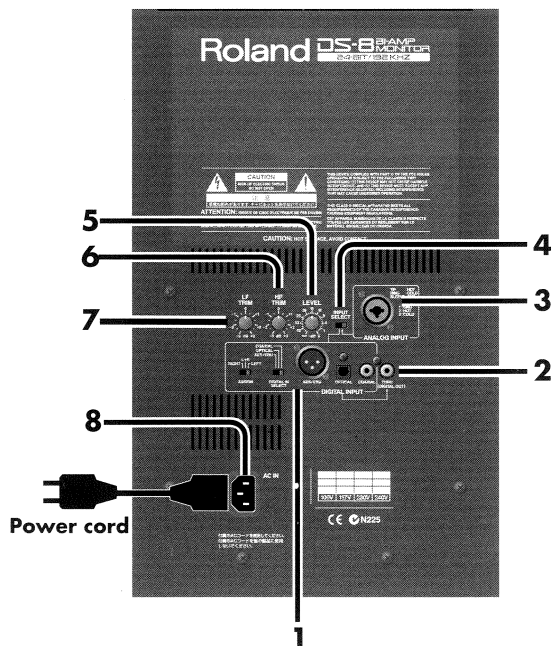

### 1 Digital Input

#### Coaxial Input Connector (Digital Input)

This is the digital input connector for coaxial cable.



It cannot be used for input of analog audio signals (no sound is produced).

#### Optical Input Connector (Digital Input)

This is the digital input connector for optic-fiber cable. Use commercially available optical cable for audio equipment to make the connection.

#### XLR Input Connector (Digital Input)

This is a digital input for AES/EBU professional format digital audio.



It cannot be used for input of analog audio signals (no sound is produced).

### Digital Input Select Switch

This switch selects AES/EBU, Optical or Coaxial. Select the connector used for the input signal.

### Assign Switch

This switch selects the stereo position of the digital signal. It selects Right, L+R, or Left when using two DS-8/7/5 monitors for stereo sound (with digital signals). Choose the setting appropriate for your setup.

#### MEMO

With the DS-8/7/5, there is no difference between L and R. When using the digital input connectors of two DS-8/7/5 monitors for stereo sound, the digital signal can be input to either L or R.

### 2 Thru (Digital Out) Connector

When connecting multiple DS-8/7/5 monitors with digital signals, this connector is used for output to the second DS-8/7/5.

#### HINT

Refer to **Connection Examples** (p. 8).

### 3 Analog Input

#### XLR/TRS Phone Input Connector (Analog Input)

This is for connecting XLR or TRS phone plugs.

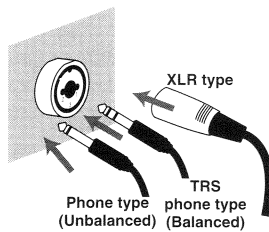

Both balanced and unbalanced connections are possible.

This instrument is equipped with balanced (XLR/TRS) type input jacks. Wiring diagrams for these jacks are shown below. Make connections after first checking the wiring diagrams of other equipment you intend to connect.

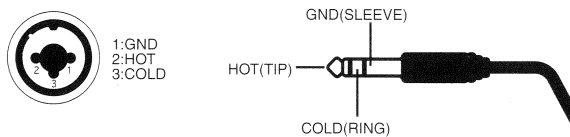

### 4 Input Select Switch

Used to select Digital Input or Analog Input. Select the connector used for the input signal.

### 5 Level Control

This adjusts the input level. Turning the control clockwise increases the sound from the speakers.

### 6 HF Trim Control

This adjusts the sound quality of the treble range. It adjusts the output level of the HF driver. (+/-3 dB above the crossover frequency)

### 7 LF Trim Control

This adjusts the sound quality of the bass range (80 Hz, +/-3 dB).

#### MEMO

The LF Trim and HF Trim controls on the DS-8/7/5 are designed to correct the sound quality of the sonic field. Use these to make fine adjustments to match the usage conditions.

### 8 AC Inlet

Connect the included Power cord here. Plug it firmly in, so that the cable does not accidentally become disconnected.

# Connection Examples

## Using Two DS-8/7/5 Monitors for Stereo Sound

Example for  
Using Analog Input Connectors

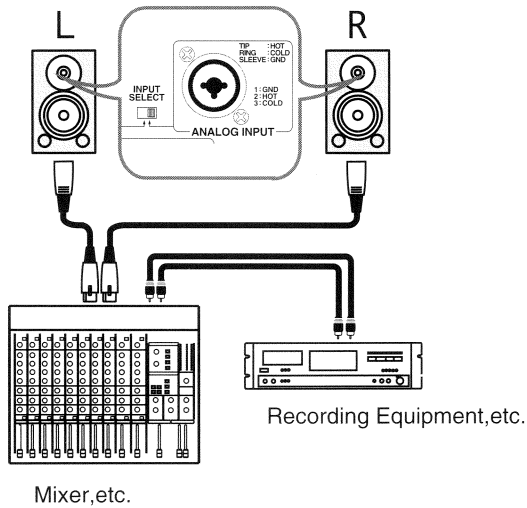

Example for  
Using Digital Input Connectors

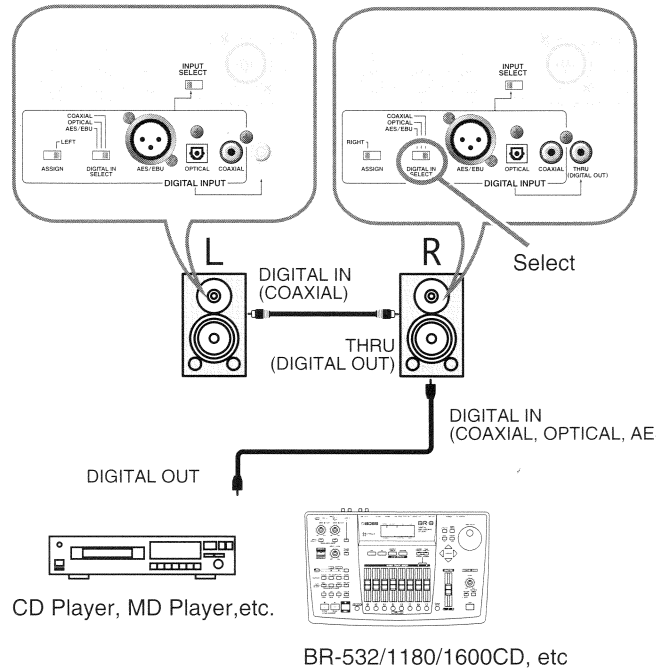

### Tips about high sound quality playback

- Please pay careful attention to the placement location. In order to take full advantage of the low-frequency playback capabilities of this device, we recommend that you place it on a hard and strong base.
- When using digital in connections, turn down the LEVEL knob of this device and raise the output level of the connected device. This will take advantage of the full number of bits in the digital signal, improving the audio quality.



## Important Notes on Placement

- During setup and transport, be careful not to damage the vibrating portions (the speaker cone and diaphragm).
- Be sure to place the monitor so that the slits on the top to radiate the heat is not obstructed. Also, make sure the monitor does not touch any curtains or other fabrics.
- This unit performs cooling when the monitor is placed as shown below. Do not place the monitor on its side or upside down.

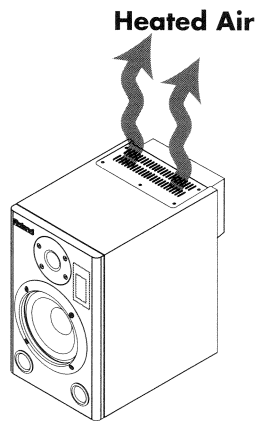

- When this unit is in operation, the top side will become hot. Take care not to touch it.
- Do not put anything on the unit.
- During operation, this unit must be placed at a distance of no less than 20 cm (7-7/8 inches) from any walls.

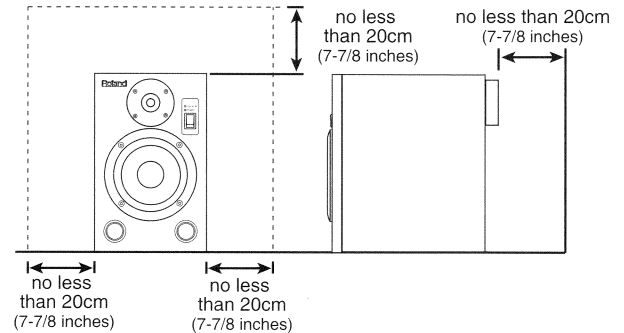

\* Please also refer to "Placement" in **IMPORTANT NOTES** (p. 5).

## Precautions When Connecting and Turning on the Power

- To prevent malfunction and/or damage to speakers or other devices, always turn down the volume, and turn off the power on all devices before making any connections.
- Once the connections have been completed, turn on power to your various devices in the order specified. By turning on devices in the wrong order, you risk causing malfunction and/or damage to speakers and other devices. (When turning the power off, reverse this procedure.)
  1. Turn on the power on the devices connected to the DS-8/7/5.
  2. Turn on the power on the DS-8/7/5.
- This unit is equipped with a protection circuit. A brief interval (a few seconds) after power up is required before the unit will operate normally.
- When connection cables with resistors are used, the volume level of equipment connected to the inputs (Analog Input) may be low. If this happens, use connection cables that do not contain resistors, such as those from the Roland PCS series.

# Reference

## Troubleshooting

If there is no sound or if the unit does not operate as you expect, please check the following points first. If this does not resolve the problem, contact the nearest Roland service center or authorized Roland distributor.

### There's No Sound

- Make sure the Input Level control has not been turned fully counterclockwise.
- Make sure the Input Select switch has been set to the connector where the input signal is connected (Digital Input or Analog Input).
- Make sure the Digital Input select switch has been set to the connector where the input signal is connected (AES/EBU, Optical or Coaxial).
- Input a digital signal to the Digital Input connector. No sound is produced when an analog signal is input.

### The volume level of the instrument connected to ANALOG INPUT is too low

- Could you be using a connection cable that contains a resistor? Use a connection cable that does not contain a resistor.

### During Digital Signal Input, the Stereo Image Is Reversed or Sounds Unnatural, or Output Doesn't Sound Like Stereo

- Check the setting of the Assign switch (Right, L+R, or Left). The DS-8/7/5 uses an identical construction for the left and right monitors, and makes no distinction between left and right. During digital signal input, set the Assign switch L or R as appropriate for your setup.

## Dimensions

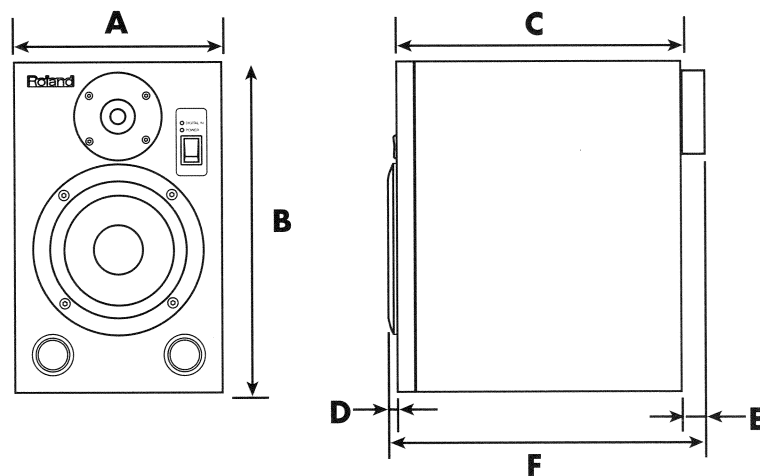

\* Not include the power cord.

	DS-8	DS-7	DS-5
A	254 mm (10 inches)	209 mm (8-1/4 inches)	184 mm (7-1/4 inches)
B	406 mm (16 inches)	336 mm (13-1/4 inches)	295 mm (11-5/8 inches)
C	317.5 mm (12-1/2 inches)	262 mm (10-3/8 inches)	228.6 mm (9 inches)
D	7.5 mm (5/16 inches)	7.5 mm (5/16 inches)	7 mm (5/16 inches)
E	42 mm (1-11/16 inches)	37 mm (1-1/2 inches)	32 mm (1-5/16 inches)
F	367 mm (14-1/2 inches)	306.5 mm (12-1/8 inches)	267.6 mm (10-9/16 inches)

# Frequency Response

**DS-8**

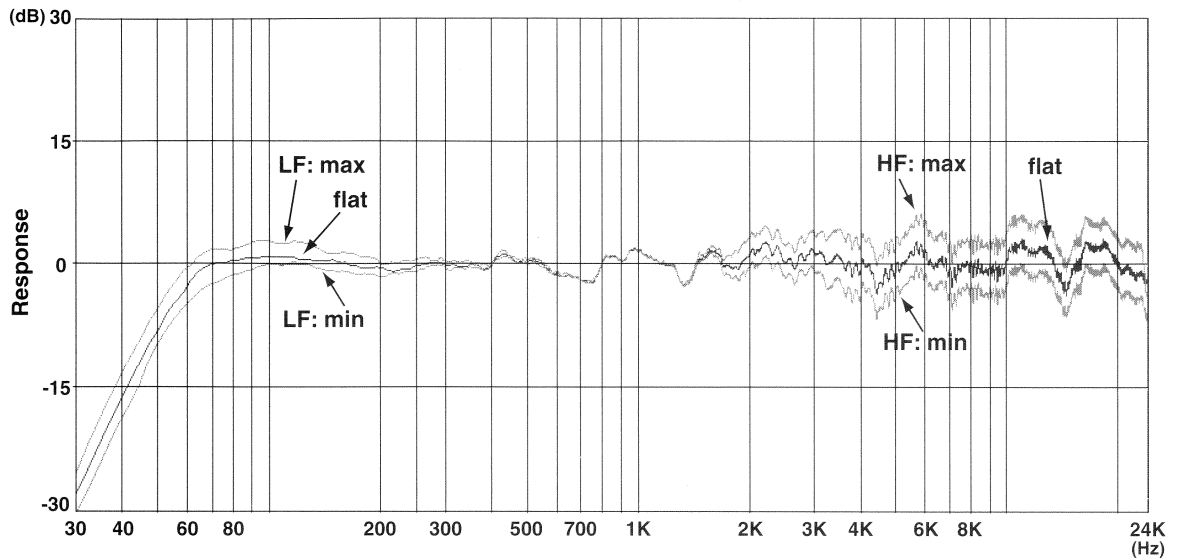

**DS-7**

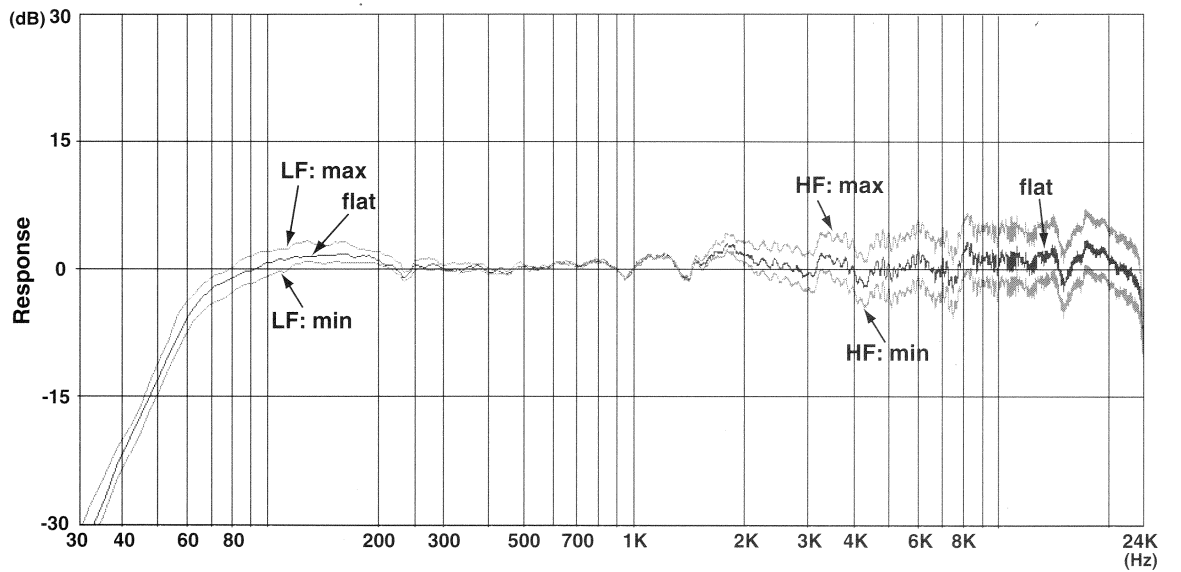

**DS-5**

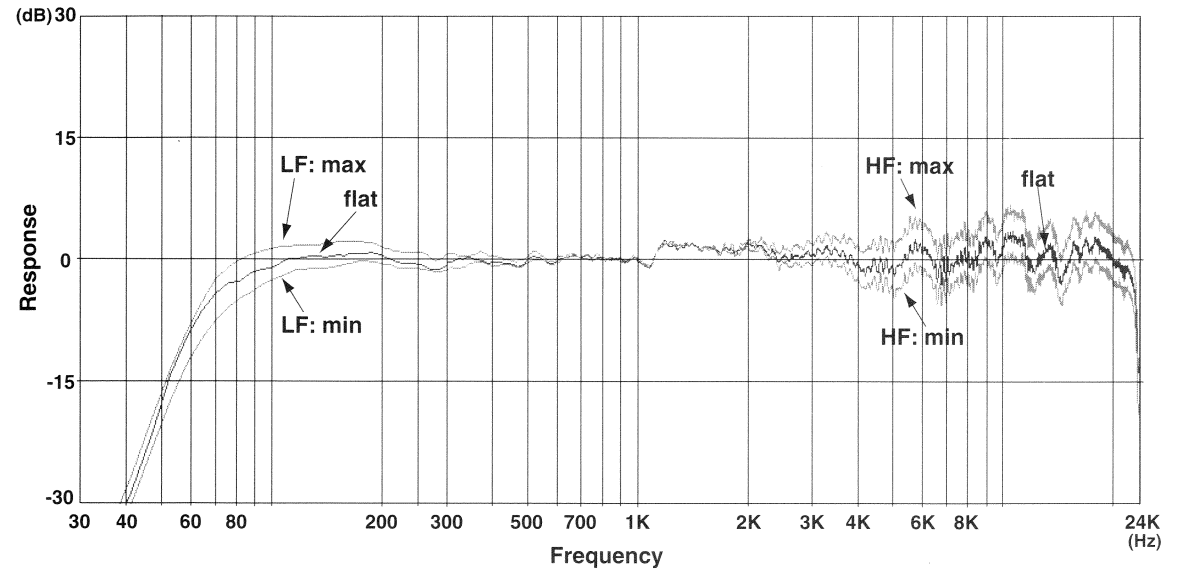

# Specifications

	DS-8	DS-7	DS-5
<b>System</b>	2-Way Bi-Amplified Monitor		
<b>Enclosure</b>	Bass-reflex type		
<b>Cabinet</b>	3/4" MDF (Baffle: 1" MDF)	5/8" MDF (Baffle: 3/4" MDF)	1/2" MDF (Baffle: 5/8" MDF)
<b>LF Driver</b>	200 mm (8") Polypropylene cone type, magnetically shielded	160 mm (6-1/2") Polypropylene cone type, magnetically shielded	130 mm (5-1/4") Polypropylene cone type, magnetically shielded
<b>HF Driver</b>	25 mm (1") Soft dome type, magnetically shielded	19 mm (3/4") Soft dome type, magnetically shielded	19 mm (3/4") Soft dome type, magnetically shielded
<b>Frequency Response</b>	58 Hz to 24 kHz (+/-3 dB)	68 Hz to 23 kHz (+/-3 dB)	78 Hz to 23 kHz (+/-3 dB)
<b>Crossover Frequency</b>	2.3 kHz (active fourth order)	2.7 kHz (active fourth order)	3.3 kHz (active fourth order)
<b>LF Amplifier Power</b>	80 W	40 W	30 W
<b>HF Amplifier Power</b>	40 W	20 W	15 W
<b>Analog In Input Sensitivity</b>	0 dBu (0.775 Vrms)		
<b>Input Impedance</b>	20 k ohms (Balanced/Unbalanced)		
<b>Digital In Format</b>	Conformity with AES/EBU and IEC60958		
<b>Sample Rate</b>	32 kHz to 192 kHz (automatically) (de-emphasis: OFF)		
<b>Word Length</b>	24 bit		
<b>DA Converter</b>	24 bit		
<b>Controls</b>	LEVEL Knob LF TRIM Knob HF TRIM Knob INPUT SELECT SW (Analog In/Digital In) ASSIGN SW (Right/L+R/Left) DIGITAL INPUT SELECT SW (AES/EBU / Optical / Coaxial) POWER SW		
<b>Indicators</b>	POWER DIGITAL IN		
<b>Connectors</b>	ANALOG INPUT (XLR / 1/4 inch TRS phone type) DIGITAL INPUT (XLR) DIGITAL INPUT (Optical) DIGITAL INPUT (Coaxial) DIGITAL THRU OUT (Coaxial)		
<b>Power Supply</b>	AC 117 V, AC 220 V, AC 230 V, AC 240 V (50/60 Hz)		
<b>Power Consumption</b>	125 W	75 W	55 W
<b>Dimensions</b>	254 (W) x 367 (D) x 406 (H) mm 10 (W) x 14-1/2 (D) x 16 (H) inches	209 (W) x 306.5 (D) x 336 (H) mm 8-1/4 (W) x 12-1/8 (D) x 13-1/4 (H) inches	184 (W) x 267.6 (D) x 295 (H) mm 7-1/4 (W) x 10-9/16(D) x 11-5/8 (H) inches
<b>Weight</b>	17.2 kg/37 lbs 15 oz	9.7 kg/21 lbs 7 oz	7.2 kg/15 lbs 14 oz
<b>Accessories</b>	Owner's Manual, Power Cord		

\* In the interest of product improvement, the specifications and/or appearance of this unit are subject to change without prior notice.



 Roland®

C5100021

UPC

C5100021



1499:

**Roland**