



DR-770 Dr. Rhythm

Owner's Manual

Thank you, and congratulations on your choice of the BOSS DR-770 Dr. Rhythm.

Before using this unit, carefully read the sections entitled:

- **USING THE UNIT SAFELY** (page 2-3)
- **IMPORTANT NOTES** (page 9)

These sections provide important information concerning the proper operation of the unit.

Additionally, in order to feel assured that you have gained a good grasp of every feature provided by your new unit, Owner's manual should be read in its entirety. The manual should be saved and kept on hand as a convenient reference.

Copyright © 1999 BOSS CORPORATION

All rights reserved. No part of this publication may be reproduced in any form without the written permission of BOSS CORPORATION.

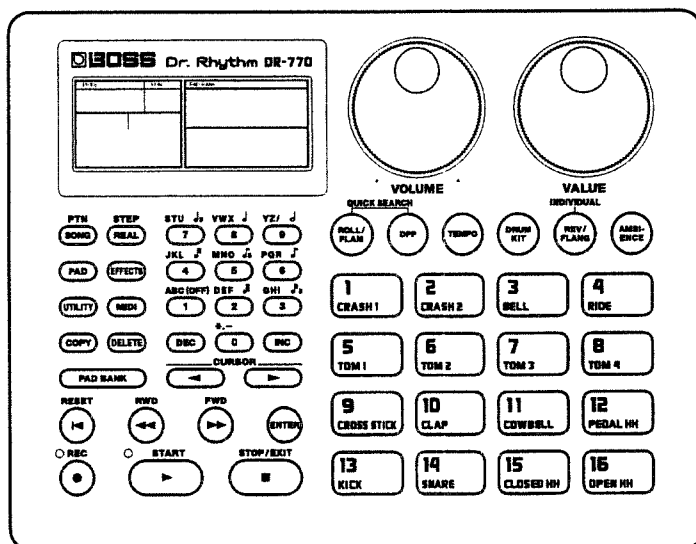

USING THE UNIT SAFELY

INSTRUCTIONS FOR THE PREVENTION OF FIRE, ELECTRIC SHOCK, OR INJURY TO PERSONS

About ⚠ WARNING and ⚠ CAUTION Notices

⚠ WARNING	Used for instructions intended to alert the user to the risk of death or severe injury should the unit be used improperly.
⚠ CAUTION	Used for instructions intended to alert the user to the risk of injury or material damage should the unit be used improperly. * Material damage refers to damage or other adverse effects caused with respect to the home and all its furnishings, as well to domestic animals or pets.

About the Symbols

	The ⚠ symbol alerts the user to important instructions or warnings. The specific meaning of the symbol is determined by the design contained within the triangle. In the case of the symbol at left, it is used for general cautions, warnings, or alerts to danger.
	The ⓧ symbol alerts the user to items that must never be carried out (are forbidden). The specific thing that must not be done is indicated by the design contained within the circle. In the case of the symbol at left, it means that the unit must never be disassembled.
	The Ⓢ symbol alerts the user to things that must be carried out. The specific thing that must be done is indicated by the design contained within the circle. In the case of the symbol at left, it means that the power-cord plug must be unplugged from the outlet.

ALWAYS OBSERVE THE FOLLOWING

⚠ WARNING

- Before using this unit, make sure to read the instructions below, and the Owner's Manual.
- Do not open (or modify in any way) the unit or its AC adaptor.
- Do not attempt to repair the unit, or replace parts within it (except when this manual provides specific instructions directing you to do so). Refer all servicing to your retailer, the nearest Roland Service Center, or an authorized Roland distributor, as listed on the "Information" page.
- Never use or store the unit in places that are:
 - Subject to temperature extremes (e.g., direct sunlight in an enclosed vehicle, near a heating duct, on top of heat-generating equipment); or are
 - Damp (e.g., baths, washrooms, on wet floors); or are
 - Humid; or are
 - Exposed to rain; or are
 - Dusty; or are
 - Subject to high levels of vibration.
- Make sure you always have the unit placed so it is level and sure to remain stable. Never place it on stands that could wobble, or on inclined surfaces.

⚠ WARNING

- Be sure to use only the AC adaptor supplied with the unit. Also, make sure the line voltage at the installation matches the input voltage specified on the AC adaptor's body. Other AC adaptors may use a different polarity, or be designed for a different voltage, so their use could result in damage, malfunction, or electric shock.
- Avoid damaging the power cord. Do not bend it excessively, step on it, place heavy objects on it, etc. A damaged cord can easily become a shock or fire hazard. Never use a power cord after it has been damaged.
- This unit, either alone or in combination with an amplifier and headphones or speakers, may be capable of producing sound levels that could cause permanent hearing loss. Do not operate for a long period of time at a high volume level, or at a level that is uncomfortable. If you experience any hearing loss or ringing in the ears, you should immediately stop using the unit, and consult an audiologist.
- Do not allow any objects (e.g., flammable material, coins, pins); or liquids of any kind (water, soft drinks, etc.) to penetrate the unit.

⚠ WARNING

- Immediately turn the power off, remove the AC adaptor from the outlet, and request servicing by your retailer, the nearest Roland Service Center, or an authorized Roland distributor, as listed on the "Information" page when:
 - The AC adaptor, the power-supply cord, or the plug has been damaged; or
 - Objects have fallen into, or liquid has been spilled onto the unit; or
 - The unit has been exposed to rain (or otherwise has become wet); or
 - The unit does not appear to operate normally or exhibits a marked change in performance.
-
- In households with small children, an adult should provide supervision until the child is capable of following all the rules essential for the safe operation of the unit.
-
- Protect the unit from strong impact. (Do not drop it!)
-
- Do not force the unit's power-supply cord to share an outlet with an unreasonable number of other devices. Be especially careful when using extension cords—the total power used by all devices you have connected to the extension cord's outlet must never exceed the power rating (watts/ amperes) for the extension cord. Excessive loads can cause the insulation on the cord to heat up and eventually melt through.
-
- Before using the unit in a foreign country, consult with your retailer, the nearest Roland Service Center, or an authorized Roland distributor, as listed on the "Information" page.
-

⚠ CAUTION

- The unit and the AC adaptor should be located so their location or position does not interfere with their proper ventilation.
-
- Always grasp only the plug on the AC adaptor cord when plugging into, or unplugging from, an outlet or this unit.
-
- Whenever the unit is to remain unused for an extended period of time, disconnect the AC adaptor.
-
- Try to prevent cords and cables from becoming entangled. Also, all cords and cables should be placed so they are out of the reach of children.
-
- Never climb on top of, nor place heavy objects on the unit.
-
- Never handle the AC adaptor or its plugs with wet hands when plugging into, or unplugging from, an outlet or this unit.
-
- Before moving the unit, disconnect the AC adaptor and all cords coming from external devices.
-
- Before cleaning the unit, turn off the power and unplug the AC adaptor from the outlet.
-
- Whenever you suspect the possibility of lightning in your area, disconnect the AC adaptor from the outlet.
-

Contents

Main Features	8
IMPORTANT NOTES	9
Panel Descriptions.....	10

Quick Start

Making Connections.....	12
Turning On the Power	14
Turning Off the Power	14
Restoring the Factory Settings (Factory Reset)	15
Listening to the Demo Song	17
Using the Pads to Play Sounds	19
Playing Different Sounds (Switching the Pad Bank).....	19
Playing a Roll	21
Playing Patterns	22
Selecting and Playing a Pattern	22
Adjusting the Tempo.....	23
Playing a Previously Selected Pattern (DPP)	24
Selecting Patterns Quickly (Quick Search)	25
Playing Other Sounds (Switching the Drum Kit).....	27
Applying Effects to Get the Sound You Want (Ambience).....	29
Recording a Pattern (Realtime Recording).....	31
To Re-Do Your Recording.....	34
Re-Recording Only a Specific Instrument	34
Re-Recording from the Beginning	35
Recording a Song (Step Recording)	37
To Re-Do the Recording.....	39

Chapter 1. Before You Create Rhythms.....	41
Drum Kits and Pad Banks	41
Drum kits.....	41
Pad Bank.....	41
Creating Rhythms.....	42
Create a Pattern	42
Create a Song	43
Operating Modes of the DR-770.....	44
Song Mode	44
Pattern Mode	44
Pad Mode	44
Effect Mode	44
Utility Mode.....	44
MIDI Mode.....	44
Using [VALUE]/[DEC] [INC]/Numeric Keys	45
Chapter 2. Playing Rhythms	46
Playing Sounds from the Pads.....	46
Selecting a Drum Kit.....	46
Selecting the Pad Bank	46
Using Both Pad Banks a and B Simultaneously (Pad Bank Layer).....	46
Using a Pad to Play a Roll.....	47
Changing the Roll Settings	47
Modifying the Flam Settings	47
An Easy Way to Apply Effects (Ambience).....	48
Playing Patterns	48
Adjusting the Tempo.....	48
Using the DPP Function to Play Patterns	48
Assigning a Pattern to a Pad	49
Using Quick Search to Select a Pattern	49
Adding a Fill-in (Realtime Pattern Change).....	50
Playing a Song.....	51
Playing from the Middle of a Song.....	52
Consecutive Playback of Multiple Songs (Song Chain)	52
Chapter 3. Recording a Pattern	53
Realtime Recording a Pattern.....	53
Step Recording a Pattern.....	54
Changing the Metronome Settings	56
Chapter 4. Editing a Pattern.....	57
Deleting an Individual Note	57
Adding an Individual Note	57

Adjusting the Volume of an Individual Note	57
Replacing an Instrument.....	58
Replacing a Drum Kit.....	59
Adding a “Swing” Feel to a Pattern (Swing).....	59
Shifting the Timing at Which an Instrument Sounds (Timing Shift)	60
Specifying the Original/Fill-in/Variation Patterns	61
Naming a Pattern	61
Deleting a Pattern.....	62
Copying a Pattern	62
Chapter 5. Recording a Song.....	63
Realtime Recording.....	63
Using the DPP Function to Realtime Recording	63
Step Recording.....	64
Chapter 6. Editing a Song	65
Preventing the Drum Kit from Being Changed.....	65
Naming a Song.....	65
Specifying the Song Tempo (Initial Tempo)	66
Deleting an Unwanted Pattern	66
Inserting a Pattern within a Song.....	67
Deleting a Song.....	67
Copying a Song.....	68
Chapter 7. Performing with a Foot Switch.....	69
Using a Foot Switch to Start/Stop Playback.....	69
Using a Foot Switch to Insert a Fill-in.....	69
Chapter 8. Creating an Original Drum Kit.....	71
Selecting a Drum Kit from Which to Start	71
Modifying the Settings of an Instrument.....	71
Selecting an Instrument and Assigning It to a Pad (Instrument Assign)	71
Adjusting the Volume (Level)	72
Adjusting the Pitch (Pitch).....	72
Lengthening or Tightening the Decay (Decay).....	73
Adjusting the Location of the Strike (Nuance)	73
Setting the Stereo Location (Pan).....	74
Preventing / Allowing Simultaneous Instruments (Assign Type).....	75
Selecting How Pad Striking Force Will Affect the Sound (Sensitivity Curve).....	76
Naming a Drum Kit (Drum Kit Name)	77
Effect Settings	77
Using the Ambience Function to Make Approximate Settings.....	77

Adjusting the Reverb Settings.....	78
Adjusting the Flanger Settings.....	79
Adjusting the Equalizer Settings.....	80
Adjusting the Reverb/Flanger Depth.....	80
Adjusting the Reverb Depth.....	81
Adjusting the Flanger Depth.....	81
Routing Sound to the Individual Output.....	82
Adjusting the Output Level.....	83
Copying a Drum Kit.....	84
Chapter 9. Connecting External MIDI Devices	85
What Is MIDI?.....	85
MIDI Connectors.....	85
MIDI Channels	85
MIDI Messages Used by the DR-770.....	85
About the MIDI Implementation Chart.....	86
Using an External MIDI Device to Play the DR-770 /	
Using the DR-770 to Play an External MIDI Device.....	86
MIDI Channel Setting.....	86
Settings for Playing the DR-770 Instruments.....	87
Other MIDI Settings.....	87
Synchronized Playback.....	88
Transmitting DR-770 Data (Bulk Dump)	89
Restoring the Transmitted Data Back to the DR-770.....	90
Chapter 10. Restoring the Factory Settings (Factory Reset).....	91
Error Messages	92
Troubleshooting.....	93
Parameter List.....	94
Instrument List	96
Preset Drum Kit List.....	98
Preset Pattern List	106
MIDI Implementation	107
MIDI Implementation Chart.....	114
Specifications.....	115
Index.....	116
Blank Chart	120

Main Features

High-Quality Sound Generator

255 different high-quality rhythm instrument sounds are included, covering the needs of a wide variety of musical styles, from rock and jazz, to Latin and rap.

128 Different Drum Kits

A drum kit consists of 55 sounds selected from the 255 available sounds. The DR-770 provides 64 preset drum kits, and allows you to create 64 user drum kits.

By editing each sound of a user drum kit, you can create a total of 3,520 original sounds (55 sounds x 64 drum kits).
(→ page 71)

Velocity-Sensitive Pads

The DR-770 features velocity-sensitive pads, so the timbre and volume change depending on the force with which you strike the pads. In addition, aftertouch sensitivity allows you to produce realistic changes in the volume of a roll by applying pressure to a pad after striking it.

Pad Bank Layering

You can switch between pad banks A/B to play two different sounds from a single pad. In addition, the Pad Bank Layer function lets you layer banks A and B, so sounds can be switched or layered by varying the force with which a pad is struck. This can be used in a variety of interesting ways.
(→ page 46)

Create 400 Different Rhythm Patterns

In addition to the 400 preset rhythm patterns, you can create 400 original rhythm patterns of your own. (→ page 53)

DPP and Quick Search

The DR-770 features convenient functions for playing rhythm patterns. "DPP" (Direct Pattern Play) allows you to play an entire rhythm pattern simply by striking a pad.
(→ page 48)

Quick Search lets you rapidly find and play rhythm patterns from a specified category, such as rock or jazz. (→ page 49)

Realtime Pattern Change

Realtime Pattern Change lets you rapidly move to a fill-in pattern or variation pattern by simply pressing a button while a rhythm pattern is playing back. (→ page 50)

Create 100 Songs

Up to 100 songs can be created, each consisting of rhythm patterns connected in a desired order. Each song can consist of up to 250 patterns, and all songs can use up to 10,000 patterns. (→ page 63)

By using the Song Chain function, you can play back up to 100 songs consecutively. (→ page 52)

Ambience Function Allows Easy Effects Settings

In addition to the built-in reverb/flanger/chorus effects, the DR-770 provides an Ambience function, which allows these three effects to be controlled comprehensively. By using this function, you can easily set up a combination of effect settings to produce the desired acoustic atmosphere, such as playing in a concert hall or in a club. (→ page 48)

Individual Outputs

In addition to conventional output jacks, the DR-770 provides individual output jacks, which output the sound unprocessed by the effects. By using these jacks you can apply an external effect only to a specific sound, or mix sounds in a more sophisticated way. (→ page 82)

Foot Switch Control

A foot switch can be connected to the foot switch jack to start/stop playback without using your hands. In addition, a separately sold PCS-31 connection cable can be used to connect two foot switches. One foot switch can be used to start/stop playback, and the other foot switch used to play a fill-in, etc. (→ page 69)

MIDI Connectors

The DR-770 provides MIDI IN/OUT connectors, allowing you to synchronize the unit to an external sequencer, or save DR-770 data by transmitting it to a sequencer. (→ page 85)

IMPORTANT NOTES

In addition to the items listed under “USING THE UNIT SAFELY” on page 2–3, please read and observe the following:

Power Supply

- Do not use this unit on the same power circuit with any device that will generate line noise (such as an electric motor or variable lighting system).
- The AC adaptor will begin to generate heat after long hours of consecutive use. This is normal, and is not a cause for concern.
- Before connecting this unit to other devices, turn off the power to all units. This will help prevent malfunctions and/or damage to speakers or other devices.

Placement

- Using the unit near power amplifiers (or other equipment containing large power transformers) may induce hum. To alleviate the problem, change the orientation of this unit; or move it farther away from the source of interference.
- This device may interfere with radio and television reception. Do not use this device in the vicinity of such receivers.
- Do not expose the unit to direct sunlight, place it near devices that radiate heat, leave it inside an enclosed vehicle, or otherwise subject it to temperature extremes. Excessive heat can deform or discolor the unit.
- To avoid possible breakdown, do not use the unit in a wet area, such as an area exposed to rain or other moisture.

Maintenance

- For everyday cleaning wipe the unit with a soft, dry cloth or one that has been slightly dampened with water. To remove stubborn dirt, use a cloth impregnated with a mild, non-abrasive detergent. Afterwards, be sure to wipe the unit thoroughly with a soft, dry cloth.
- Never use benzine, thinners, alcohol or solvents of any kind, to avoid the possibility of discoloration and/or deformation.

Repairs and Data

- Please be aware that all data contained in the unit's memory may be lost when the unit is sent for repairs. Important data should always be backed up in another MIDI device (e.g., a sequencer), or written down on paper (when possible). During repairs, due care is taken to avoid the loss of data. However, in certain cases (such as when circuitry related to memory itself is out of order), we regret that it may not be possible to restore the data, and Roland assumes no liability concerning such loss of data.

Memory Backup

- This unit contains a battery which powers the unit's memory circuits while the main power is off. When this battery becomes weak, the message shown below will appear in the display. Once you see this message, have the battery replaced with a fresh one as soon as possible to avoid the loss of all data in memory. To have the battery replaced, consult with your retailer, the nearest Roland Service Center, or an authorized Roland distributor, as listed on the “Information” page.

“Battery Low!”

Additional Precautions

- Please be aware that the contents of memory can be irretrievably lost as a result of a malfunction, or the improper operation of the unit. To protect yourself against the risk of losing important data, we recommend that you periodically save a backup copy of important data you have stored in the unit's memory in another MIDI device (e.g., a sequencer).
- Unfortunately, it may be impossible to restore the contents of data that was stored in another MIDI device (e.g., a sequencer) once it has been lost. Roland Corporation assumes no liability concerning such loss of data.
- Use a reasonable amount of care when using the unit's buttons, sliders, or other controls; and when using its jacks and connectors. Rough handling can lead to malfunctions.
- Never strike or apply strong pressure to the display.
- When connecting / disconnecting all cables, grasp the connector itself—never pull on the cable. This way you will avoid causing shorts, or damage to the cable's internal elements.
- To avoid disturbing your neighbors, try to keep the unit's volume at reasonable levels. You may prefer to use headphones, so you do not need to be concerned about those around you (especially when it is late at night).
- When you need to transport the unit, package it in the box (including padding) that it came in, if possible. Otherwise, you will need to use equivalent packaging materials.

Panel Descriptions

■ Front Panel

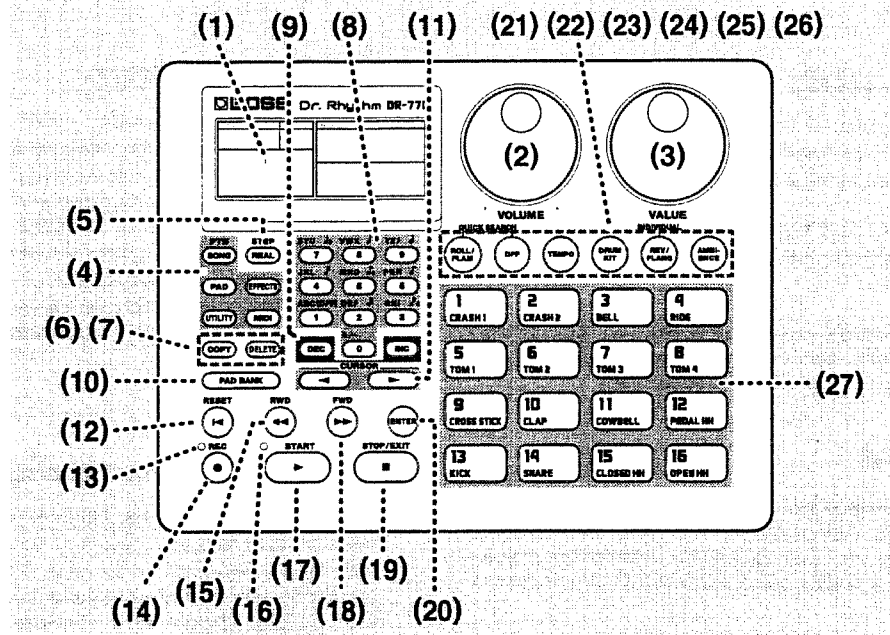

- | | | | |
|------|--|------|----------------------------------|
| (1) | Display | (21) | Roll/Flam button |
| (2) | Volume dial | (22) | Direct Pattern Play (DPP) button |
| (3) | Value dial | (23) | Tempo button |
| (4) | Mode Select button | (24) | Drum Kit button |
| | Song/Pattern | (25) | Reverb/Flanger button |
| | Pad | (26) | Ambience button |
| | Effects | (27) | pads (1-16) |
| | Utility | | |
| | MIDI | | |
| (5) | Realtime/Step button | | |
| (6) | Copy button | | |
| (7) | Delete button | | |
| (8) | Numeric keys | | |
| (9) | Decrement (DEC) button /Increment (INC) button | | |
| (10) | Pad Bank button | | |
| (11) | Cursor button | | |
| (12) | Reset button | | |
| (13) | REC (Record) indicator | | |
| (14) | Record button | | |
| (15) | Rewind button | | |
| (16) | Tempo indicator | | |
| (17) | Start button | | |
| (18) | Forward button | | |
| (19) | Stop/Exit button | | |
| (20) | Enter button | | |

■ Rear Panel

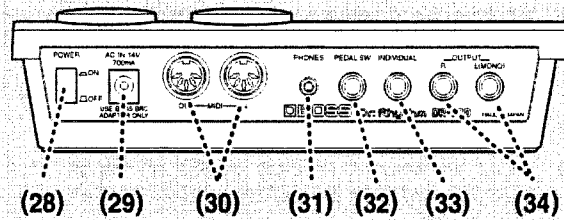

- | | |
|------|-------------------------|
| (28) | Power switch |
| (29) | AC Adaptor jack |
| (30) | MIDI connector (In/Out) |
| (31) | Headphone jack |
| (32) | Pedal Switch jack |
| (33) | Individual jack |
| (34) | Output jack (L/R(mono)) |

Quick Start

Printing Conventions in This Manual

In order to present information as clearly as possible, the following conventions are used in this Manual

- Text, numerals or symbol enclosed in square brackets [] indicate buttons or dials.

[TEMPO]	Tempo button
[◀][▶]	Cursor buttons
[◀CURSOR]	Cursor ◀ button
[CURSOR▶]	Cursor ▶ button
[VALUE]	Value dial

- Reference such as (p. **) indicate pages in this manual to which you can refer.

Making Connections

The DR-770 does not contain an amp or speakers. In order to produce sound, you must provide an amp or audio system, or use stereo headphones.



Audio cables, MIDI cables, stereo headphones, and foot switches are not included. They can be purchased separately from your dealer.

1. Before you begin making connections, please check the following points.

- Have the volume controls of the DR-770 and the connected amp system been turned to the minimum position?
- Has the power of the DR-770 and the connected amp system been turned off?



To prevent malfunction and/or damage to speakers or other devices, always turn down the volume, and turn off the power on all devices before making any connections.

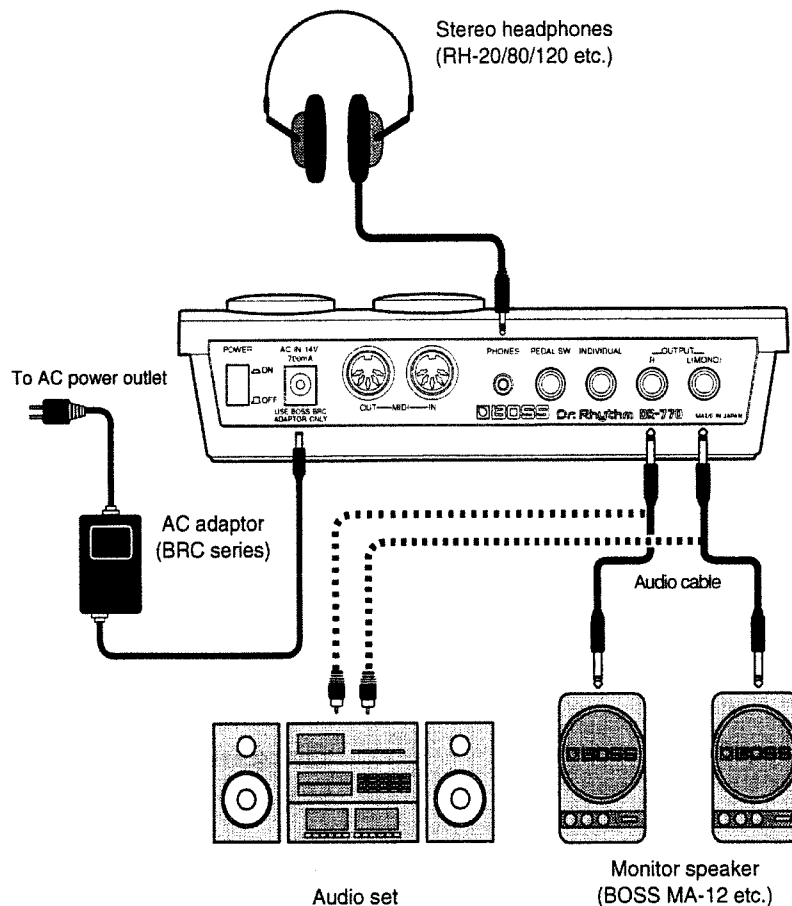

2. Connect the included AC adapter to the DR-770, and plug it into an AC outlet.

3. Connect your amp or audio system as shown in the diagram.

Alternately, you could connect a set of stereo headphones.



In order to take full advantage of the DR-770's capabilities, we recommend that you play it in stereo.

If you want to use it in mono, make connections to the OUTPUT L (MONO) jack.



For details on MIDI connector connections, refer to p. 85.

For details on PEDAL SW jack connections, refer to p. 69.

For details on INDIVIDUAL jack connections, refer to p. 82.

Turning On the Power

Once the connections have been completed, turn on power to your various devices in the order specified. By turning on devices in the wrong order, you risk causing malfunction and /or damage to speakers and other devices.

1. Before turning on the power, check the following points.

- Have connections with external devices been made correctly?
- Has the volume of the DR-770 and the connected amp system been turned to the minimum position?

2. Turn on the POWER switch located on the rear panel of the DR-770.

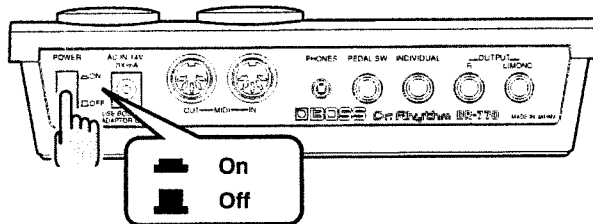

3. Turn on the power of your amp system.

4. While striking the pads, rotate [VOLUME] to adjust the volume of the DR-770.

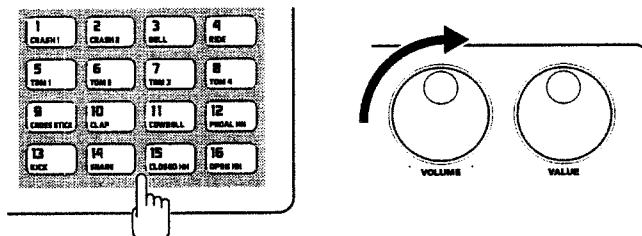

Adjust the volume of the connected amp system to an appropriate level.



This unit is equipped with a protection circuit. A brief interval (a few seconds) after power up is required before the unit will operate normally.

Turning Off the Power

1. Before you turn off the power, check the following points.

- Have the volume controls of the DR-770 and the connected amp system been turned to the minimum position?

2. Turn off the power of the amp system.

3. Turn off the power of the DR-770.

Restoring the Factory Settings (Factory Reset)

If you have modified the settings of the DR-770 after purchasing it, it may not function exactly as described in this Quick Start manual. Should this be the case, please use the following Factory Reset procedure to restore the factory settings before you read the Quick Start manual.



When you perform the Factory Reset operation, all data in memory will be returned to the factory settings. If memory contains important data that you want to keep, use the bulk dump operation (p. 89) to save the data on an external MIDI device (sequencer or the like) before performing a Factory Reset.

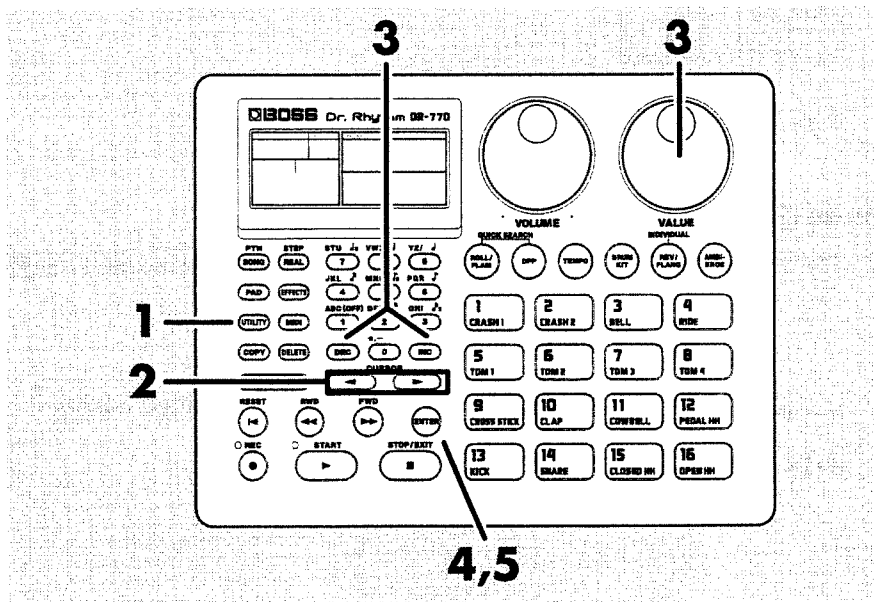

1. Press [UTILITY] so the display indicates "UTILITY."

MODE	FUNC
REAL	
UTILITY	

2. Use [◀] [▶] to select "9 F.RST."

MODE	FUNC
REAL	
UTILITY	
9 F.RST ALL	

3. Use [DEC] [INC] or [VALUE] to select "ALL."

4. Press [ENTER].

The display will ask "Sure?," asking you to confirm that you want to execute the Factory Reset operation.

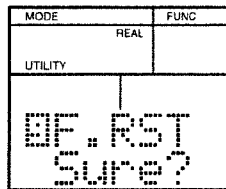

If you decide not to execute Factory Reset, press [STOP / EXIT].

5. Press [ENTER] once again.

The display will indicate "Done," indicating that Factory Reset has been completed.



It is also possible to restore only a portion of the data to the factory settings.

Refer to "Restoring the factory settings" (p. 91).

Listening to the Demo Song

The DR-770 contains a demo song that takes advantage of its functionality. Here's how to listen to the demo song.

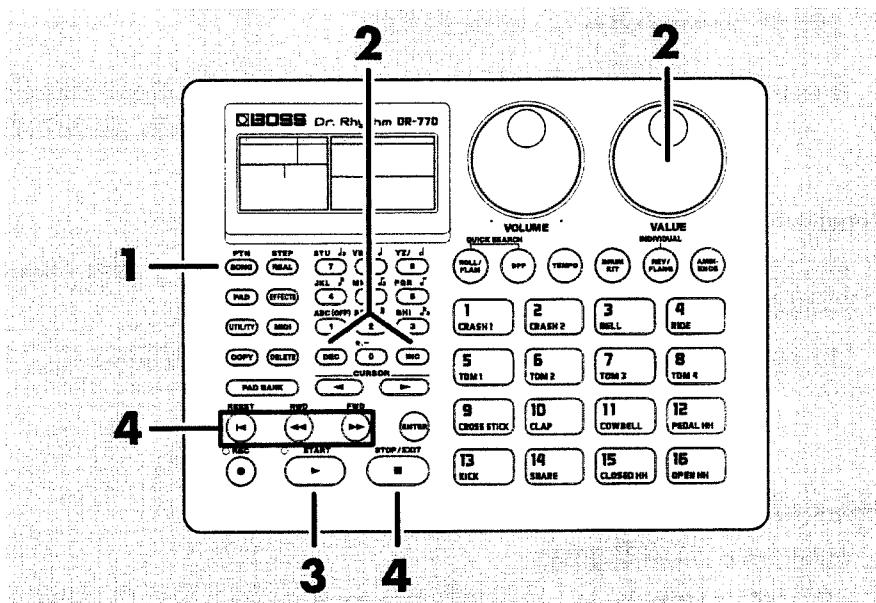

1. Press [SONG/PTN] so the display indicates "SONG."

MODE	FUNC
SONG	REAL

2. Use [DEC] [INC] or [VALUE] to cause the display to show "-- --".

NOTE

The demo song is located before song number 1.

MODE	FUNC	PAD BANK	A
SONG	REAL	TEMPO	-- -- --
DEMO DocsFty		SONG	-- -- --

Demo song name

Song number

3. Press [START] to begin playback.

“DEMO” message will blink during playback.

Song Title: Doctor’s Party

Music by Naoki Matsuura

Copyright ©1999, Roland Corporation

4. Press [STOP/EXIT] to stop playback.

If you press [START] once again, playback will resume from where it had stopped. (This is called Continue Play.)

Hold down [RESET] and press [START] to start playback from the beginning of the song.

Profiles of the Composers

Naoki Matsuura (GigBag)

GIGBAG left Japan for the U.S. in 1982, then started his professional activities while he was still in the Berklee College of Music. He gained popularity as a bassist in Boston, Europe and Asia.



All rights reserved. Unauthorized use of this material for purposes other than private, personal enjoyment is a violation of applicable laws.



No data for the music that is played will be output from MIDI OUT.

Using the Pads to Play Sounds

Here's how to use the pads to play the rhythm instrument sounds of the DR-770.

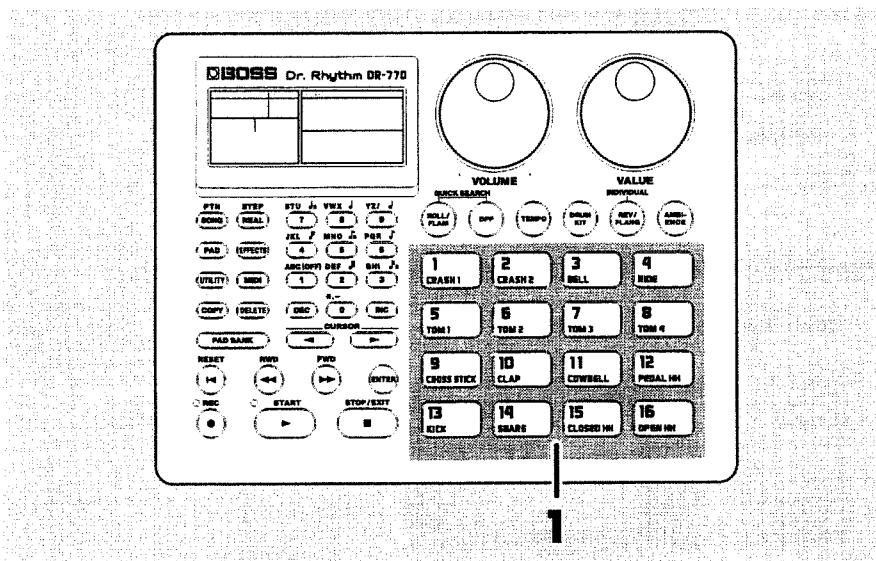

1. When you strike a pad, the instrumental sound (instrument) assigned to that pad will play.

Since the pads are velocity-sensitive, the volume and tone will change depending on how strongly a pad is struck.

Playing Different Sounds (Switching the Pad Bank)

You can switch the Pad Bank so that the same pads play different instruments.



A **Pad Bank** is a group of instruments assigned to the sixteen pads. There are two pad banks: A and B.

For details refer to "Drum kits and pad banks" (p. 41).

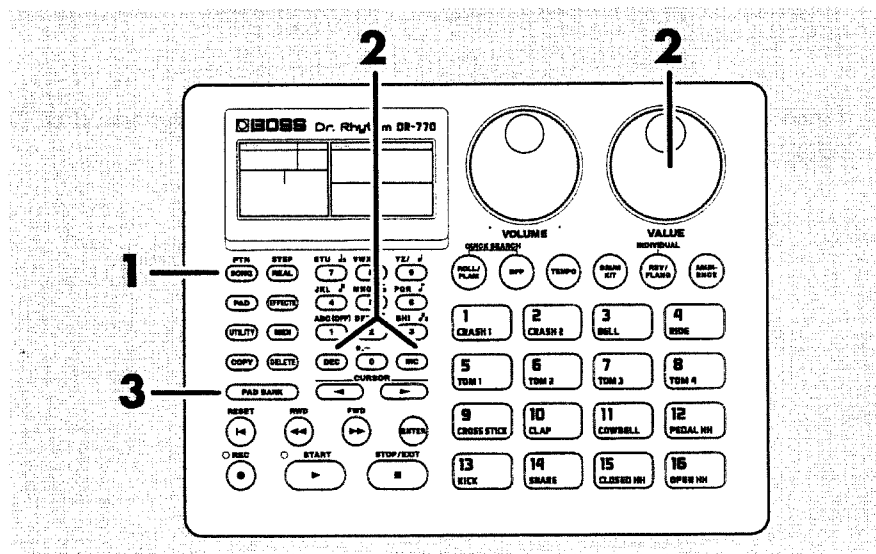

1. Press [SONG/PTN] so the display indicates "PATTERN."

MODE	FUNC
PATTERN	REAL

2. Use [DEC] [INC] or [VALUE] so the display indicates "1."

Select the pattern number 1.

MODE	REAL	FUNC	PAD BANK	A
PATTERN			TEMPO	120
	BEAT LENGTH		PATTERN	1
0010 08		HdRck10		

↑
Pattern number

3. Press [PAD BANK].

Each time you press the button, the setting will cycle through A -> B -> AB (both A and B), and the pad bank will be switched between A -> B -> AB (both A and B).

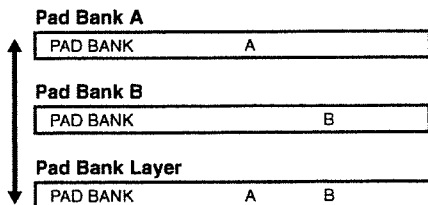

When the pad bank is changed, different sounds (instruments) will be heard when you strike the pad.



If both A and B are displayed, both sounds will sound simultaneously. (Pad Bank Layer function: p. 46)

Playing a Roll

A “roll” is a performance technique by which an instrument is played repeatedly at regular intervals.

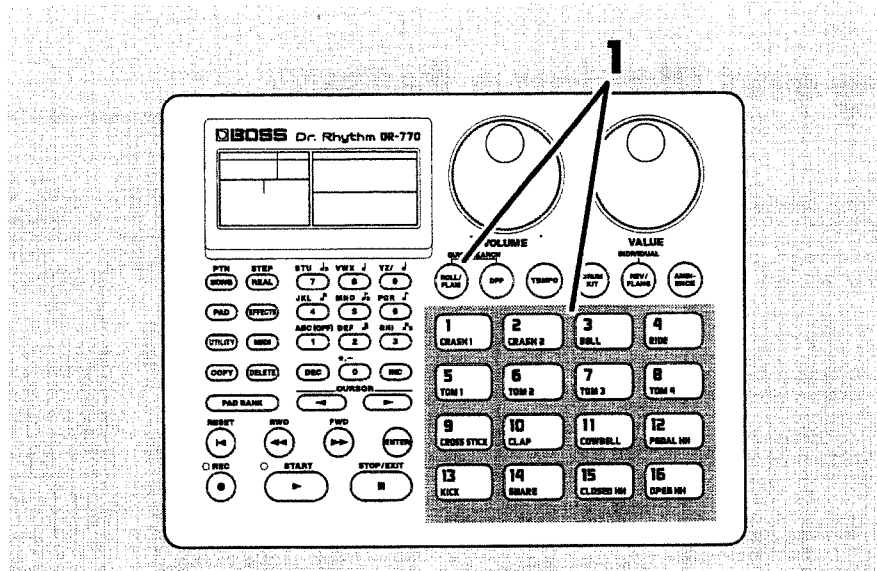

1. While holding down [ROLL/FLAM], continue pressing a pad.



You can adjust the spacing of the roll.

Refer to “Changing the roll settings” (p. 47).



You can make settings so that a **Flam** is played when you press [ROLL/FLAM].

Refer to “changing the roll settings” (p. 47).

Playing Patterns

The DR-770 contains 400 preset patterns and 400 user patterns. Use the following procedure to play back and listen to patterns.



On the DR-770, a **Pattern** is a section of rhythm data that can be 1, 2, or 3 measures long.

Selecting and Playing a Pattern

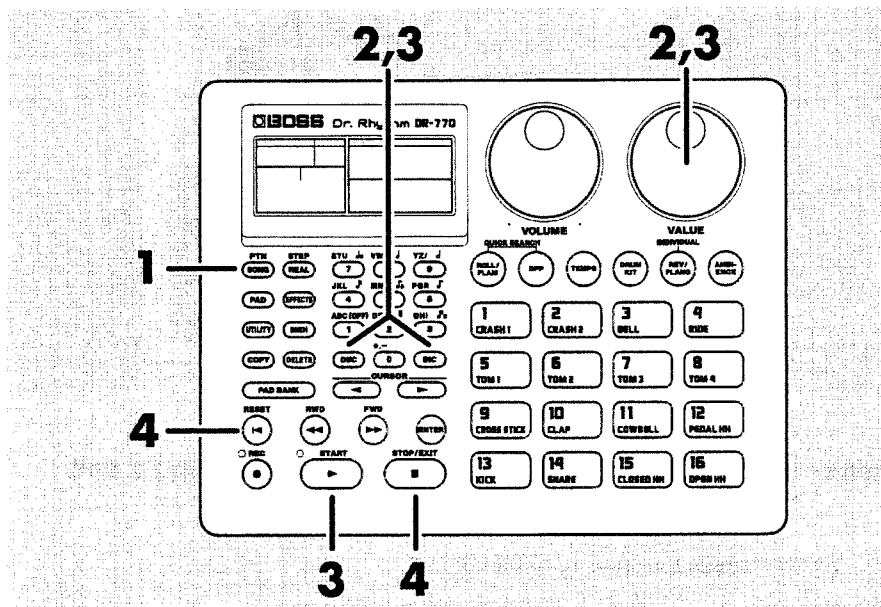

1. Press [SONG/PTN] so the display indicates "PATTERN."

MODE	FUNC
PATTERN	REAL

2. Use [DEC] [INC] or [VALUE] to select the pattern (1–400) that you want to play.

Numbers 1–400 are preset patterns, and numbers 401–800 are user patterns.

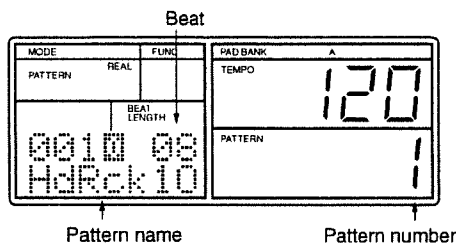

3. Press [START] to play back the selected pattern.

The tempo indicator will blink on each beat, and the beat counter will change as the pattern plays.

While a pattern is playing, you can use [DEC] [INC] or [VALUE] to get the display to show "NEXT PTN." You can then select the pattern to be played next.

When the current pattern has finished playing, the selected pattern will begin.

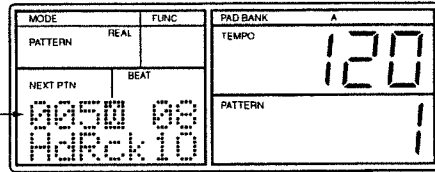

Pattern number to be played next

4. Press [STOP/EXIT] to stop playback.

When you press [START] once again, playback will resume from the point at which it was stopped. (This is referred to as Continue Play.)

If you press [RESET] and then press [START], playback will start from the beginning of the pattern.

Adjusting the Tempo

Here's how to adjust the tempo at which the pattern plays.

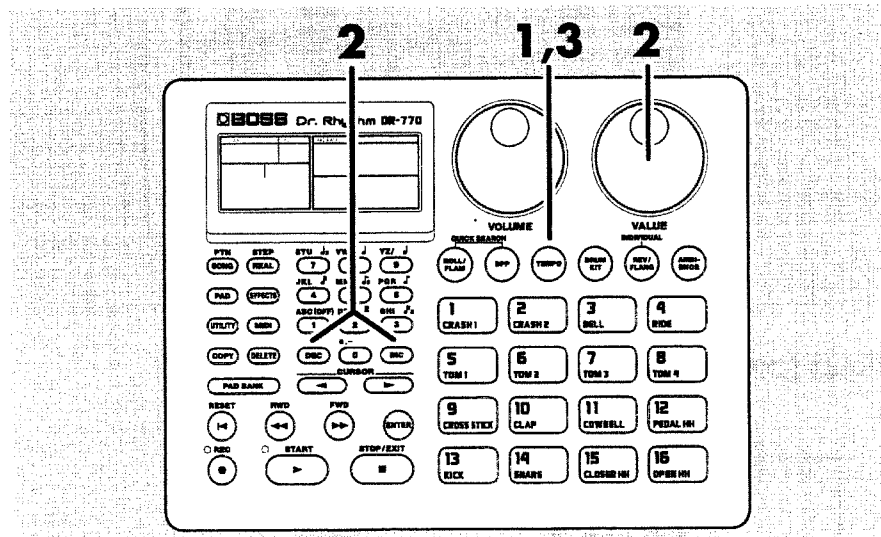

1. Press [TEMPO] to make "TEMPO" blink.

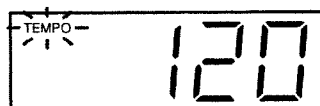

2. Use [DEC] [INC] or [VALUE] to adjust the tempo.

The tempo can be adjusted in the range of 20–260.

3. After you have set the desired tempo, press [TEMPO] once again.

“TEMPO” will change from blinking to the normal display.

Playing a Previously Selected Pattern (DPP)

Normally, striking a pad will play the instrument that has been assigned to that pad. However, the DPP (Direct Pattern Play) function lets you use the pads to play patterns that have been assigned to each pad.

DPP lets you play back patterns simply by pressing the pads.

Here’s how you can try out the DPP function to listen to the patterns that were assigned to the pads when the DR-770 was shipped from the factory.

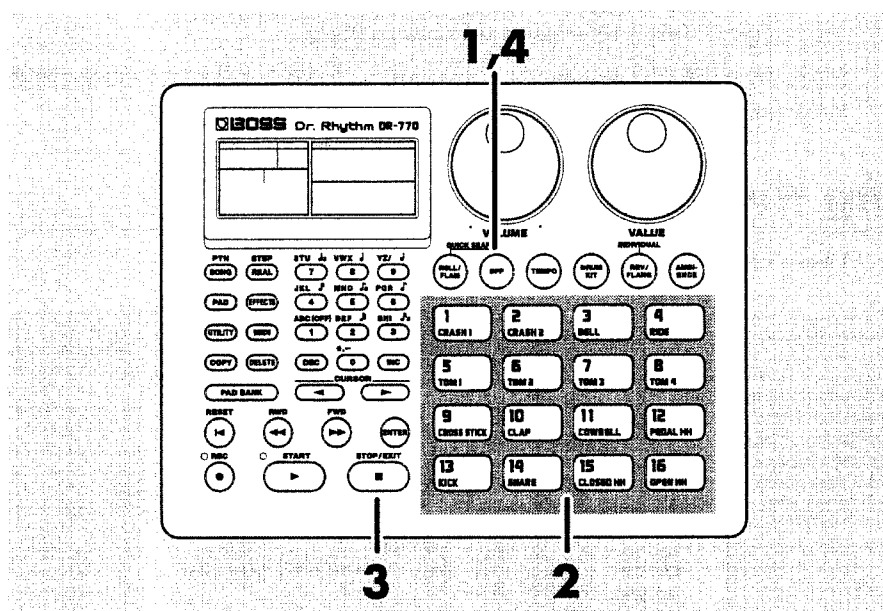

1. Press [DPP] so the display indicates “DPP.”

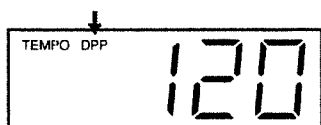

2. Strike a pad, and the pattern assigned to the pad will begin playing.

The tempo indicator will blink on each beat, and the beat number will change as playback continues.

The display will indicate the number and name of the pattern that is playing.

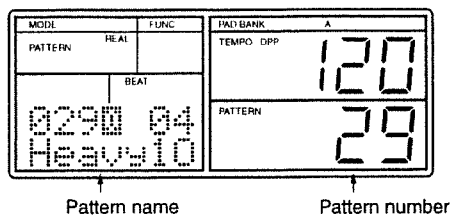

If you press a different pad during playback, the currently playing pattern will continue playing to the end, and then the pattern assigned to the pad you pressed will begin playing.

3. Press [STOP/EXIT] to stop playback.

If you press the pad once again, playback will start from the beginning of the pattern.

4. To turn off the DPP (Direct Pattern Play) function, press [DPP] to turn off the “DPP” display.



For details on how to assign a pattern to a pad, refer to “Assigning a pattern to a pad” (p. 49).

Selecting Patterns Quickly (Quick Search)

The Quick Search function lets you search for a desired pattern by **Category** (e.g., musical genre such as rock or jazz).

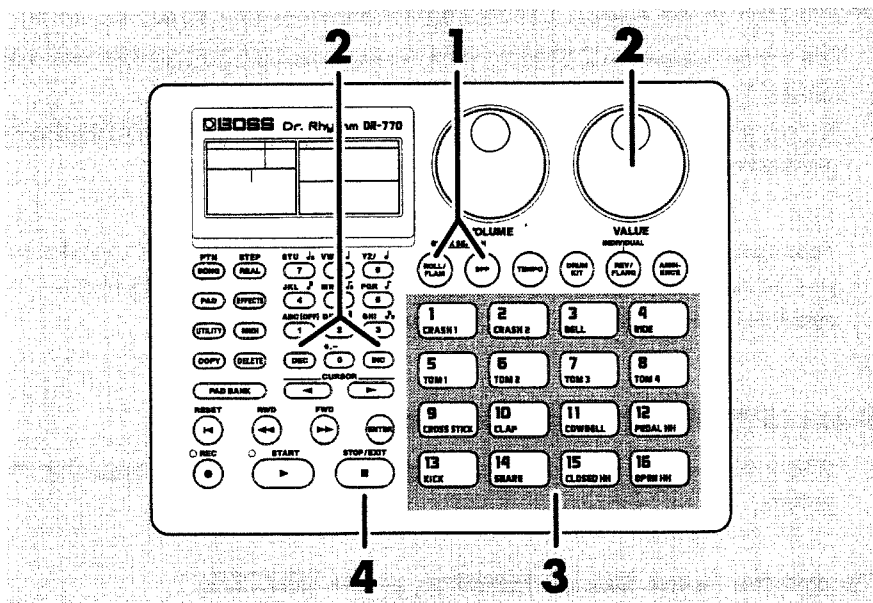

1. While holding down [ROLL/FLAM], press [DPP].

QUICK START

The following display will appear.

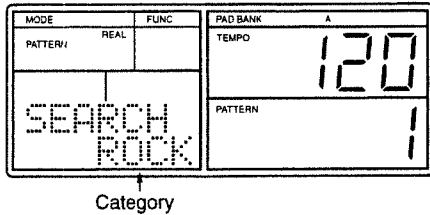

2. Use [DEC] [INC] or [VALUE] to select the desired category.

- HD ROCK..... Hard Rock, Heavy Metal
- ROCK Rock
- POP Pops, 16 beat, 8 beat
- FNK&BLS Funk, Blues, Soul
- JAZZ.....Jazz, Fusion
- DANCE Hip-Hop, Techno, etc.
- LATIN Bossa Nova, Samba, etc.
- WORLD World
- USER 1..... User Pattern 401–416
- USER 2..... User Pattern 417–432
- USER 3..... User Pattern 433–448
- : :
- USER25..... User Pattern 785–800

When you select a category, patterns within that category will be assigned to the pads (1–16).

3. When you strike a pad, the assigned pattern will begin playing.

The tempo indicator will blink on each measure, and the beat number will change as playback continues.

If you strike a different pad during playback, the pattern assigned to the later-pressed pad will begin playing from the next beat.



Depending on the category that you select, not all sixteen pads may have a pattern assigned to them. In this case, pressing a pad to which no pattern has been assigned will cause “- - -” to appear for approximately one second in the lower right of the display.

4. Press [STOP/EXIT] to stop playback.

When you press the pad once again, playback will start from the beginning of the pattern.

5. To exit the Quick Search function, press [ENTER].

Playing Other Sounds (Switching the Drum Kit)

Even with the same pattern, changing the instruments that make up the pattern can change the feeling (performance and sound) of the pattern.

The following explains how you can switch the drum kit while a pattern is playing, and play the same pattern using various instruments.



A “drum kit” is a set of 55 instruments selected from the total of 255 instruments that the DR-770 has onboard.

The unit provides 64 preset drum kits. Additionally, another 64 user drum kits, which can be modified anyway you like, are provided.

For details, refer to “Drum Kits and Pad Banks” (p. 41).

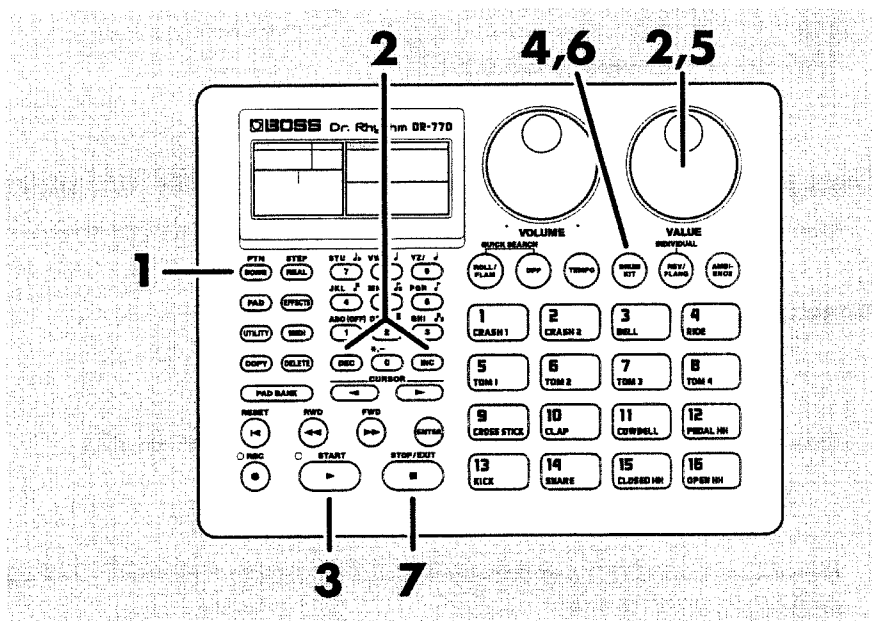

1. Press [SONG/PTN] so the display indicates “PATTERN.”

MODE	FUNC
PATTERN	REAL

2. Use [DEC] [INC] or [VALUE] to select pattern number “1.”
You can select a different pattern if you wish.
3. Press [START] to start playback.
4. Press [DRUM KIT] to make “DRUM KIT” blink.



5. Use [DEC] [INC] or [VALUE] to select a drum kit number.

Select various drum kits and hear how the sound changes.

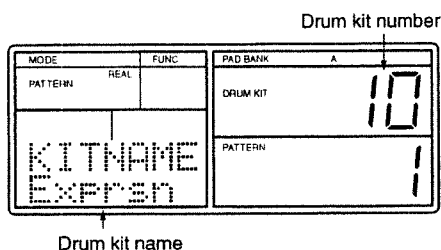

6. Press [DRUM KIT] once again to exit the drum kit selection process.

The "DRUM KIT" indication will change from blinking to the normal display.

7. Press [STOP/EXIT] to stop the pattern playback.



For a list of the preset drum kits, refer to "Preset Drum Kit List" (p. 98).



If you want to modify the settings of the drum kit, refer to "Chapter 8. Creating an original drum kit" (p. 71).

Applying Effects to Get the Sound You Want (Ambience)

Here's how you can create the desired atmosphere by using Ambience to apply an effect to the pattern playback.



Ambience is a function that comprehensively controls the three internal effects (reverb/flanger/equalizer) to quickly and easily create an effect sound. This function lets you create effect settings for the desired type of acoustic feel, such as "playing in a concert hall" or "playing in a club."

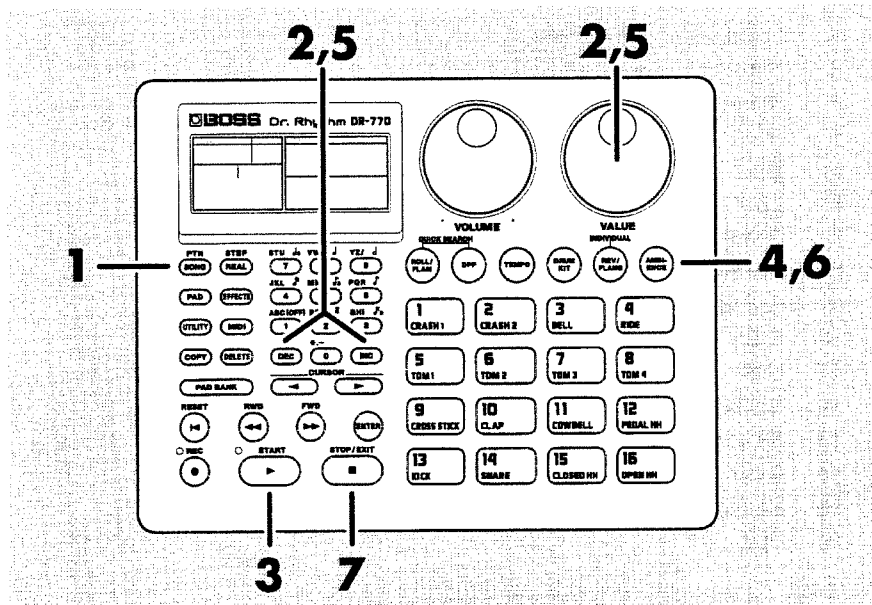

1. Press [SONG/PTN] so the display indicates "PATTERN."

MODE	REAL	FUNC
PATTERN		

2. Use [DEC] [INC] or [VALUE] to select pattern number "1."

You may select a different pattern if you wish.

3. Press [START] to start playback.

4. Press [AMBIENCE].

The following display will appear.

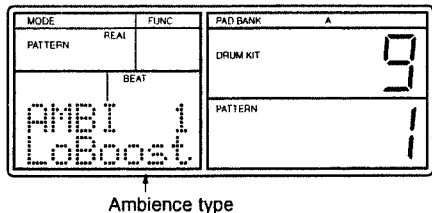

5. Use [DEC] [INC] or [VALUE] to select the type of ambience.

- 1 **LoBoost** (Lo-Boost)
- 2 **Flang'n** (Flanging)
- 3 **Bright**
- 4 **Hi-Fi**
- 5 **Dark**
- 6 **Lo-Fi**
- 7 **Room**
- 8 **Studio**
- 9 **Garage**
- 10 **Club**
- 11 **Hall**
- 12 **Stadium**
- 13 **Space**
- 14 **Echo**
- 15 **Doublin** (Doubling)
- 16 **Flat**

Select various ambience types and listen to the result.

6. To turn ambience off, press [AMBIENCE] once again.

Each time you press [AMBIENCE], ambience will be switched on/off.

7. Press [STOP/EXIT] to stop pattern playback.



For details on making settings for each effect (reverb/flanger/equalizer), refer to "Effect settings" (p. 77).



For the reverb and flanger effects, you can adjust the effect depth independently for each instrument. For details refer to "Adjusting the reverb/flanger depth" (p. 80).

Recording a Pattern (Realtime Recording)

The DR-770 allows you to create 400 of your own original patterns. Here's how to use **realtime recording** to actually record a simple pattern.



Realtime recording is a method of recording in which you strike the pads in time with the metronome to record a pattern just as you play it.

Another method of recording is Step Recording, in which you specify the timing of individual notes for each sound (instrument).

For details refer to "Creating rhythms" (p. 42).

Let's record the following pattern in pattern number 401.

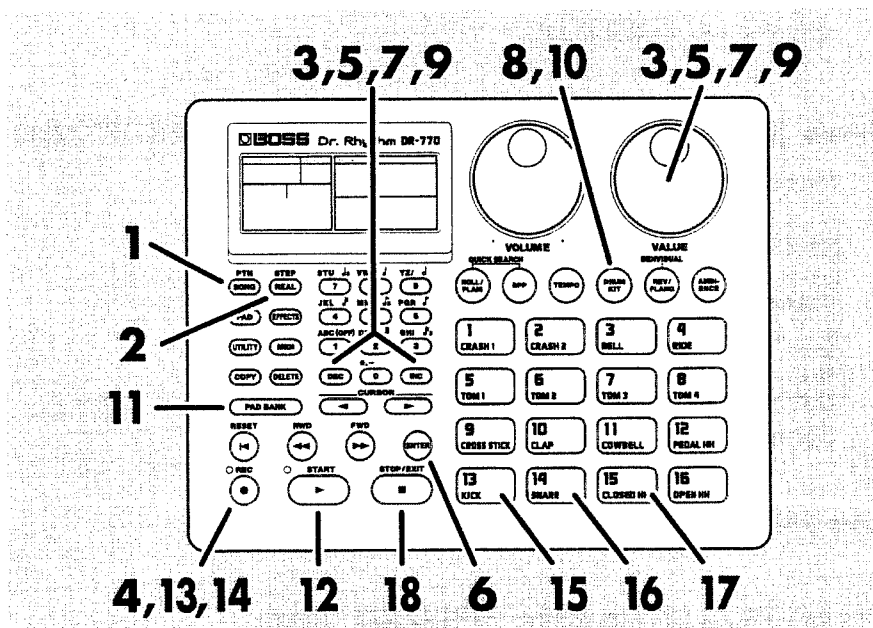
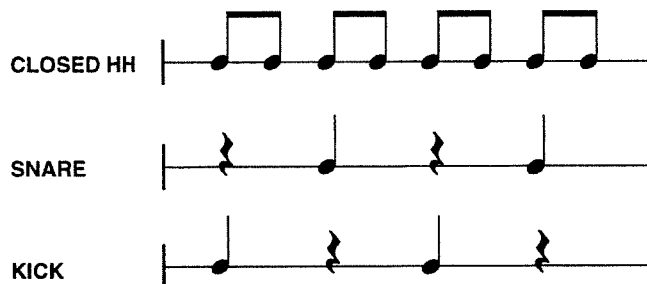

1. Press [SONG/PTN] so the display indicates "PATTERN."

2. Press [REAL/STEP] so the display indicates "REAL."

Realtime recording has been selected.

MODE	FUNC
PATTERN	REAL

3. Use [DEC] [INC] or [VALUE] to select pattern number “401.”

4. Press [REC].

The REC indicator will light, and the display will indicate “QUANTIZE.”

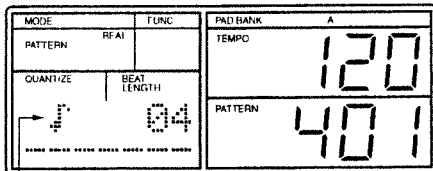

Quantize

5. Use [DEC] [INC] or [VALUE] to set Quantize to “♪” (8th notes).



Quantize is a function that corrects inaccuracies of timing that occur when you strike the pads during recording. Normally, you should set Quantize to the smallest note value that you want to record.

6. Press [CURSOR▶] to make the beat (“BEAT LENGTH”) blink.

The beat length is the number of quarter notes in one pattern.

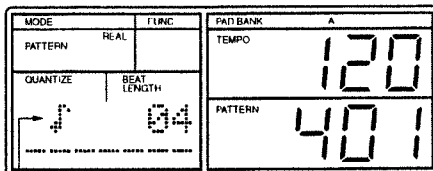

Quantize

7. Use [DEC] [INC] or [VALUE] to set this to “04.”

8. Press [DRUM KIT] to make “DRUM KIT” blink.

9. Use [DEC] [INC] or [VALUE] to select drum kit number “8” (Ambient).

Strike several pads to locate the sounds you want.

10. Press [DRUM KIT].

“DRUM KIT” will change from blinking to the normal display.

11. Press [PAD BANK] so the display indicates only “A.”

Pad Bank A has been selected.

12. Press [START].

The metronome will begin sounding, and the tempo indicator will light in synchronization with the count.

13. Press [REC] to make the REC indicator go dark.

The metronome will continue sounding, but striking the pads will not cause notes to be recorded.

Strike the pads in time with the metronome to **rehearse**.

If the **metronome tempo is too fast (slow)**, use the following procedure to adjust the tempo.

- 1) Press [TEMPO] to make "TEMPO" blink.
- 2) Use [DEC] [INC] or [VALUE] to adjust the tempo.
- 3) When you have set the desired tempo, press [TEMPO] once again.

When you are finished rehearsing, continue with the following steps.

14. Press [REC] to make the REC indicator light.**15. Strike pad 13 to record the kick.**

Strike the pad at the following timing.



The kick will continue playing repeatedly.



The force (velocity) with which you strike the pad will also be recorded.

16. Strike pad 14 to record the snare.

Strike the pad at the following timing.

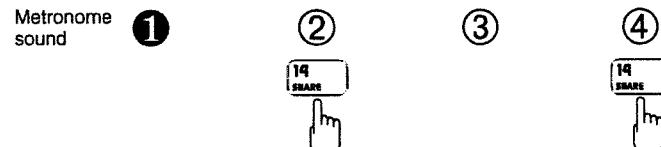

The kick and snare will continue playing repeatedly.

17. Strike pad 15 to record the closed hi-hat.

Strike the pad at the following timing.

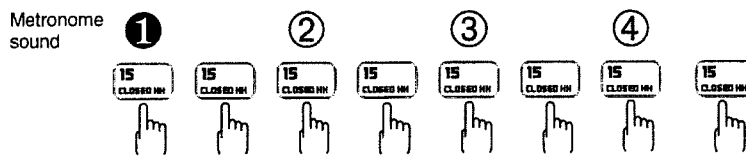

All the sounds you recorded will continue playing back repeatedly.

18. Press [STOP/EXIT] to stop recording.

To Re-Do Your Recording

Listen to the pattern that you recorded. If you are not satisfied with the result, you can re-do the recording.

Re-Recording Only a Specific Instrument

If you want to re-record only a specific instrument, such as the closed hi-hat, use the following procedure.

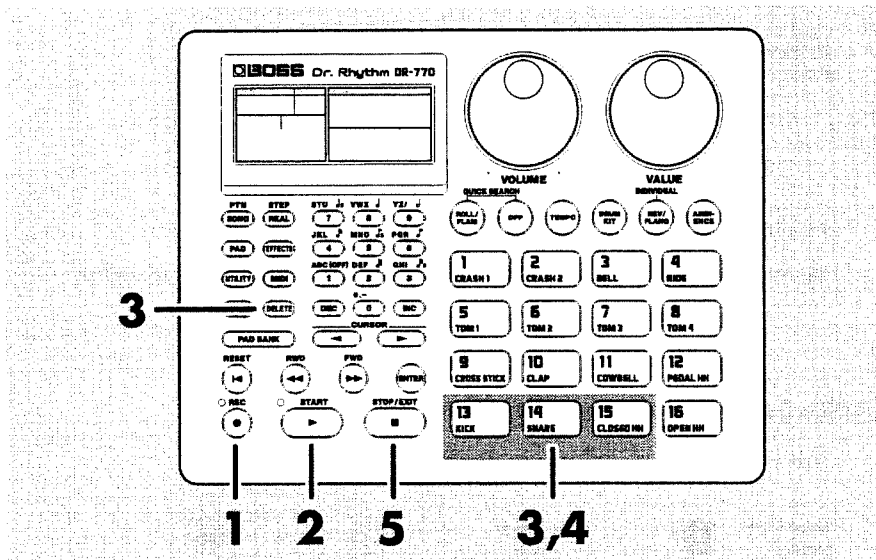

1. Press [REC] to make the REC indicator light.

2. Press [START] to enter record-ready mode.

3. Hold down [DELETE], and press the pad to which the instrument that you want to re-record is assigned.

The notes of that instrument will be erased for as long as you continue pressing [DELETE] and that pad.

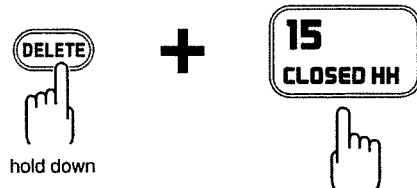

4. Strike the pad to re-record.
5. When you finish recording, press [STOP/EXIT].

Re-Recording from the Beginning

If you want to re-record all instruments, use the following procedure. (This will delete the pattern that you recorded.)

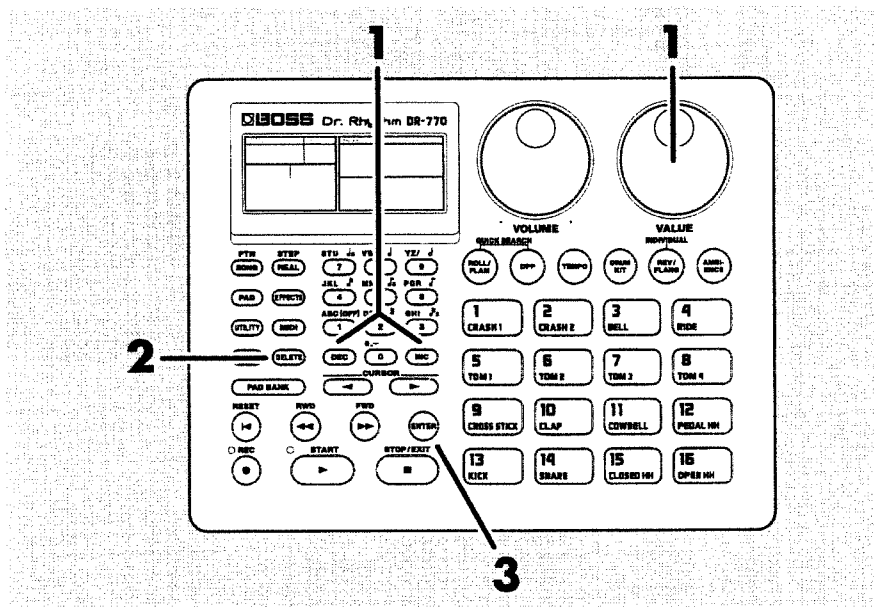

1. Use [DEC] [INC] or [VALUE] to select the pattern that you want to re-record.
2. When playback is stopped, press [DELETE]. (The display will indicate "DELETE.")

The display will ask "Sure?" so that you can confirm whether you really wish to delete the pattern.

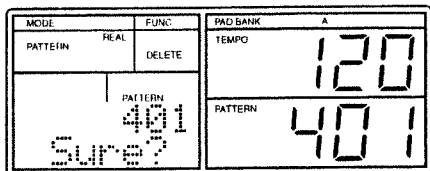

3. Press [ENTER].

The pattern will be erased, and the display will indicate "Done."

You can assign a name of up to seven characters to a pattern that you record.

→ "Naming a pattern" (p. 61)

You can make detailed adjustments to individual notes that you record.

→ "Deleting an individual note" (p. 57)

→ "Adding an individual note" (p. 57)

→ "Adjusting the volume of an individual note" (p. 57)

Recording a Song (Step Recording)

On the DR-770, you can create a song by placing patterns in a desired playback order. Here's how you can use **step recording** to record a simple song.



Step recording is a method in which you use the numeric or other keys to specify the order of the patterns that will be played back.

Another recording method is **realtime** recording, in which you record the playback of patterns in a song just as playback occurs.

For details refer to "Creating rhythms" (p. 42).

In this example we will record the following song in song number 1.

Part 001	002	003	004
Pattern No. 45	Pattern No. 45	Pattern No. 46	Pattern No. 47
005	006	007	008
Pattern No. 47	Pattern No. 45	Pattern No. 45	Pattern No. 48

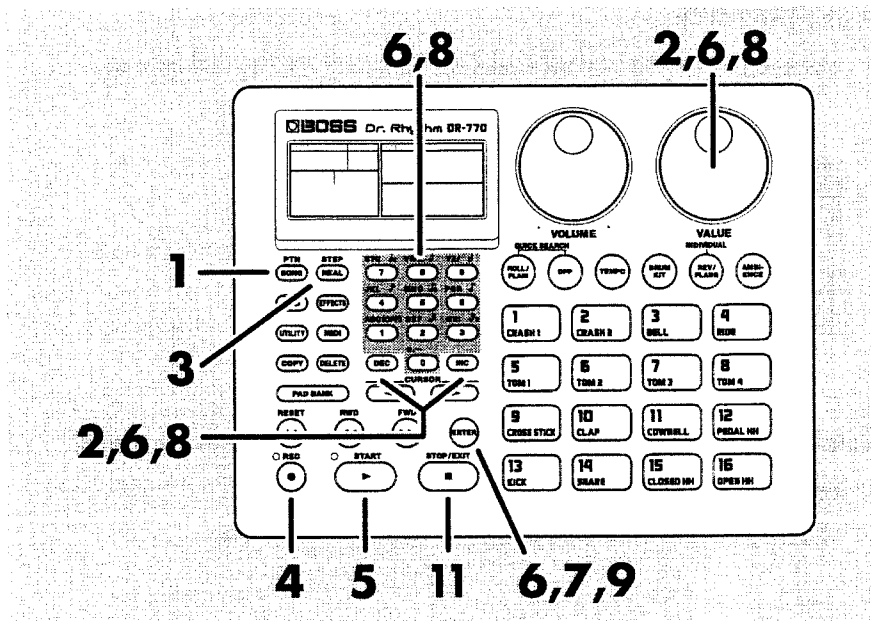

1. Press [SONG/PTN] so the display indicates "SONG."

MODE	FUNC	
SONG	REAL	

2. Use [DEC] [INC] or [VALUE] to select song number "1."

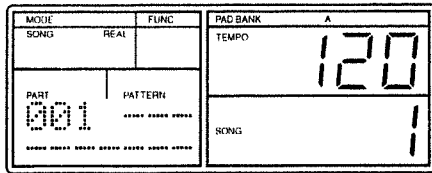

3. Press [REAL/STEP] so the display indicates “STEP.”

This selects Step Recording.

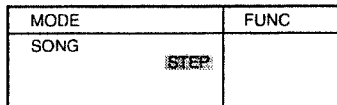

4. Press [REC] to make the REC indicator light.

5. Press [START].

The tempo indicator will light, and the following display will appear.

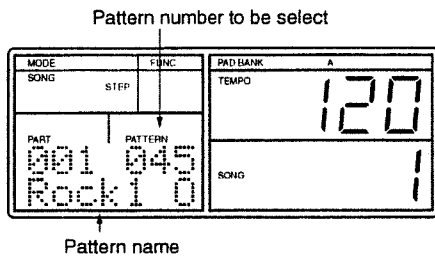

6. Select the first pattern (number 45) that you want to record.

Press numeric keys [4] and [5], and then press [ENTER].



You can also select patterns by using [DEC] [INC] or [VALUE].



Part (“PART”) indicates the order of patterns within the song. The beginning of the song is part number 1.

7. Press [ENTER].

When you press [ENTER] you will advance to the next part.

8. Select the pattern that you want to record next.

Use the numeric keys to select the number, and then press [ENTER].

Alternatively, you can use [DEC] [INC] [VALUE] to select the number.

To continue to select the same number, go to step 9.

MODE	LUTIC		PAD BANK	A
SONG	STEP		TEMPO	120
PART	PATTERN		SONG	1
002	045			
Rock1	0			

9. Press [ENTER].
10. Repeat steps 8–9 to select all the desired patterns.
11. Press [STOP/EXIT] when you are finished recording.

To Re-Do the Recording

If you specify the wrong pattern while recording, use the following procedure to re-record the pattern correctly.

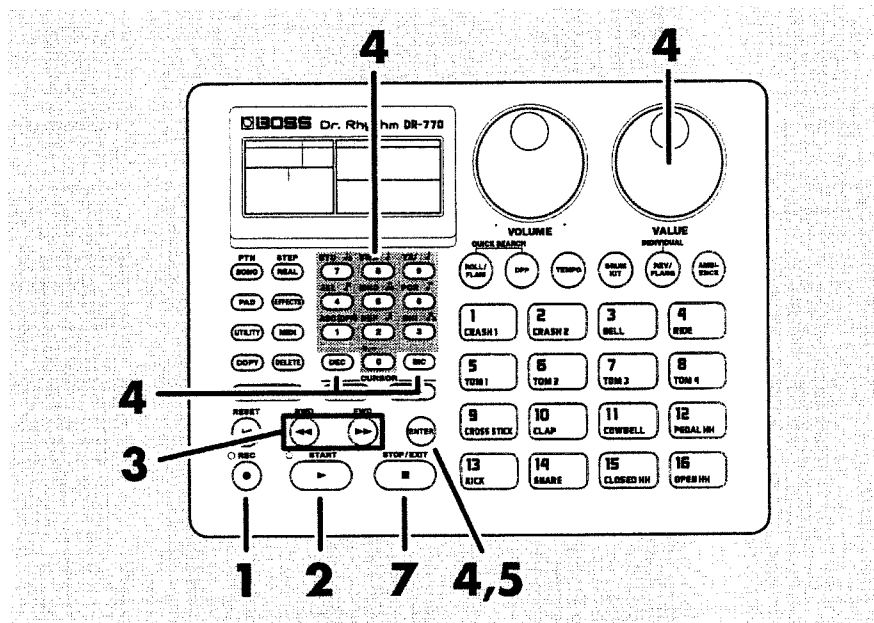

1. Press [REC] to make the REC indicator light.
2. Press [START] to enter record-ready mode.
3. Use [RWD] / [FWD] to select the part in which you recorded the wrong pattern.

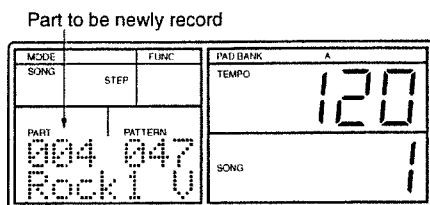

- 4.** Select the pattern that you want to newly record.
Use the numeric keys to select the number, and then press [ENTER].
Alternatively, you can use [DEC] [INC] [VALUE] to select the number.
- 5.** Press [ENTER].
- 6.** Repeat steps 3–5 as necessary.
- 7.** Press [STOP/EXIT] to stop recording.

Chapter 1. Before You Create Rhythms

This chapter provides a basic overview of the DR-770.

Drum Kits and Pad Banks

Drum kits

A drum kit is a set of 55 instruments selected from the 255 onboard instruments (instrumental sounds). The 55 instruments are assigned a number (**pad number**) in the range of 1–55.

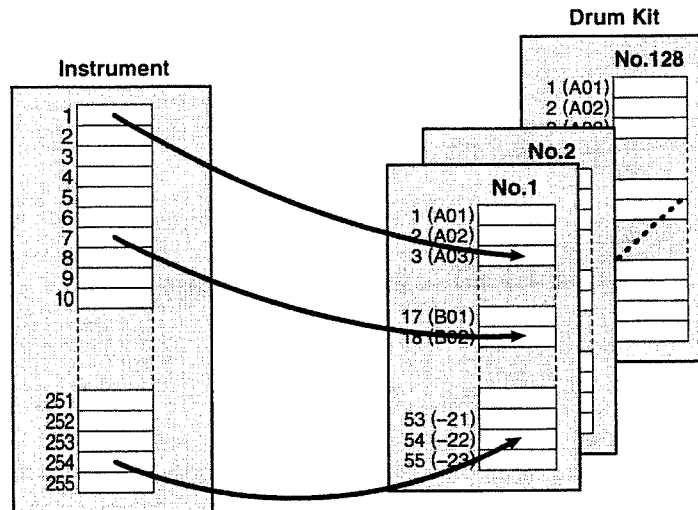

- The DR-770 has 64 preset drum kits (numbers 1–64), and 64 user drum kits, which you are free to modify (numbers 65–128).
- You may edit the sound (volume, pitch, etc.) of instruments that are assigned to a user drum kit, which means that you can use them as new instruments in addition to the built-in instruments.
- On the DR-770, only one drum kit can be used when creating a pattern. It is not possible to use multiple drum kits in a single pattern.
- A pattern records the number of the drum kit that was used to create that pattern. This means that if you play back a different pattern, the drum kit will also be changed.

Pad Bank

A pad bank is a group of settings that assigns a drum kit instrument to each of the sixteen pads. There are two pad banks: A and B.

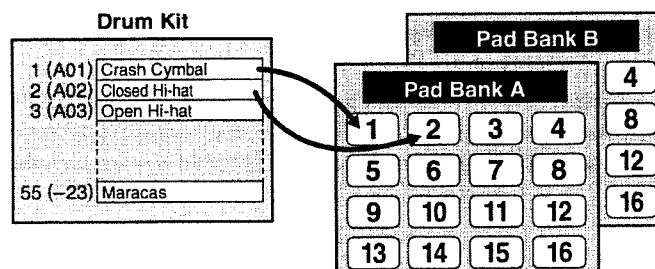

Drum kit pad numbers 1–16 correspond to pad 1–16 of pad bank A, and pad numbers 17–32 correspond to pad 1–16 of pad bank B. This means that the instruments of pad numbers 1–32 can be played by striking the pads.

NOTE

The instruments of pad numbers 33–55 cannot be played by striking the pads, but can be played via MIDI (p. 85). And, they can be recorded using the step recording (p. 58).

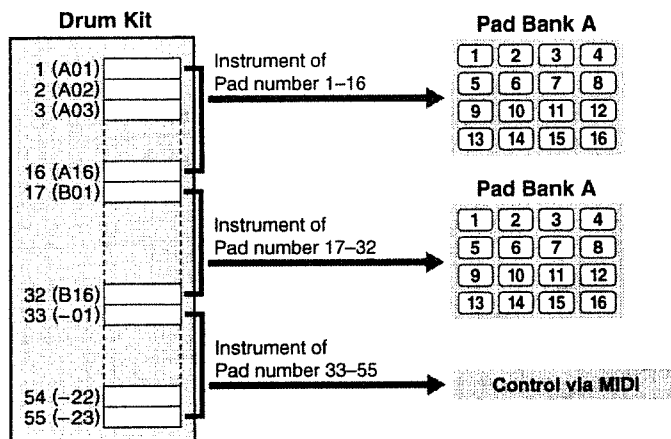

Creating Rhythms

Broadly speaking, the following two steps are necessary in order to create rhythm patterns for one song on the DR-770.

Create a Pattern

Create (record) a musical pattern for a portion of the song. Up to 400 user patterns can be created.

There are two ways to record a pattern.

Realtime Recording

In this method you strike the pads in time to a metronome to record the pattern just as you play it. Even if the timing at which you strike the pads is slightly inaccurate, the Quantize function can be used to ensure that the notes are recorded at precise timings.

Step Recording

In this method you specify things such as the timing (step) and volume of each instrument, for each note. Users who are not comfortable with realtime recording can use this method to accurately record a pattern.

Step recording is also used to edit individual notes of a pattern after recording.

You can also use a combination of realtime recording and step recording to record a pattern.

For example, you might realtime-record a pattern, and then use step recording to make minor corrections to it. Alternatively, you could use step recording to record the basic pattern, and then use realtime recording to add ad-lib notes to complete the pattern.

Number of notes that can be recorded simultaneously

Up to nine notes can be recorded at the same step. It is not possible to record any more notes than this.

Create a Song

Arrange user patterns you've created, or any of the 400 preset patterns into a desired playback order to create (record) a song. As with patterns, there are two ways to record a song.

Realtime Recording

This method allows you to select and play patterns, and record your selections as a song. This is a quick and easy way to record a song.

Step Recording

This method allows you to use the numeric keys to individually specify each pattern, and the order in which it will play back (the "part"). Step recording makes it possible to accurately record songs containing complex combinations of patterns, which might be difficult to record in realtime.

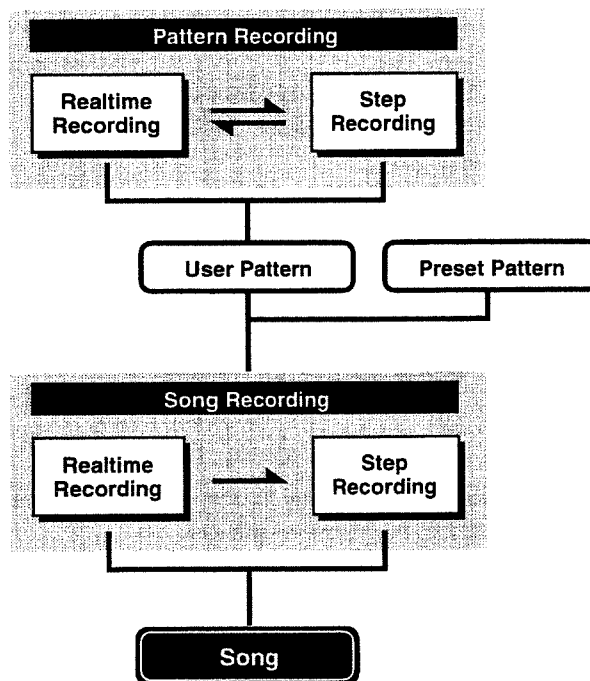

Operating Modes of the DR-770

The DR-770 provides a large number of functions that help you to create patterns or songs, and to edit sounds. These functions are grouped into the following six modes.

Song Mode

In this mode you can play/record/edit songs.
When this mode is selected, the display will indicate "SONG."

Pattern Mode

In this mode you can play/record/edit patterns.
When this mode is selecting, the display will indicate "PATTERN."

Pad Mode

In this mode you can assign instruments to the pads, and specify how the instruments will sound.
When this mode is selected, the display will indicate "PAD."

Effect Mode

In this mode you can make reverb, flanger, and equalizer settings.
When this mode is selected, the display will indicate "EFFECTS."

Utility Mode

In this mode you can adjust Roll and Metronome settings, and specify Swing and Timing Shift settings to modify the way in which a pattern is played.
The "Factory Reset" operation, which restores the internal data to the factory settings is also found in this mode.
When this mode is selected, the display will indicate "UTILITY."

MIDI Mode

In this mode you can make settings for when using the DR-770 as a MIDI sound module, or when transmitting DR-770 data to an external sequencer.
When this mode is selected, the display will indicate "MIDI."

Changing Modes

To change modes, make sure that playback is stopped, and press the desired mode button ([SONG/PTN] [PAD] [EFFECTS] [UTILITY] [MIDI]).

Using [VALUE]/[DEC] [INC]/Numeric Keys

You can use [VALUE]/[DEC] [INC]/numeric keys to modify or set various values while operating the DR-770, for example to select patterns or songs, to adjust the tempo, or to modify effect settings.

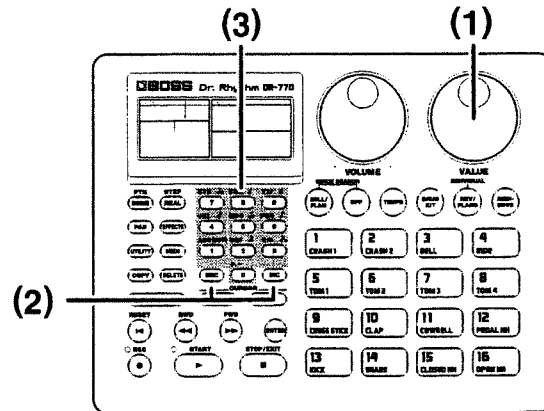

(1) [VALUE]

Use this knob to make large changes in a value. The value will change continuously, according to the speed at which the knob is rotated.

(2) [DEC] [INC]

Use these buttons to make fine adjustments to a value. If you continue holding a button, the value will change continuously.

If you continue holding a button and then press the other button, the value will change more rapidly.

(3) Numeric Keys

Use these when you wish to specify a value directly. After using the numeric keys to input a value, press [ENTER] to finalize the value.

For example, if you want to select pattern number "50," you would press: [5], [0], [ENTER].

When specifying note values (as when making Quantize (p. 53) settings), you can use the numeric keys to select the note value that is printed at the upper right of each key.

Pressing [1] will turn a setting OFF.

When inputting characters for a pattern name (p. 61) or song name (p. 65), use the numeric keys to select the alphabetical characters and symbols printed at the upper left of each key.

Each time you press a numeric key, the character or symbol will change as follows.

(Example)

When [1] is pressed: 1 → A → B → C → a → b → c

When [0] is pressed: 0 → * → . → -

In the explanations in chapter 2 and following, button names will be abbreviated as [VALUE*] in cases where it does not matter whether you use [VALUE] or [DEC] [INC] or the numeric keys.

Chapter 2. Playing Rhythms

Playing Sounds from the Pads

1. When you strike a pad, the instrument that has been assigned to that pad will sound.

The volume, tone, etc., will change in response to the force with which you strike the pad.

Selecting a Drum Kit

From the 64 preset drum kits and 64 user drum kits, select the drum kit that you want to use.

1. Press [DRUM KIT] to make "DRUM KIT" blink.
2. Use [VALUE*] to select the desired drum kit.
Preset: 1–64
User: 65–128

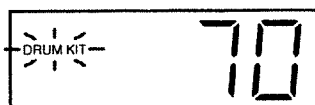

3. After selecting a drum kit, press [DRUM KIT] once again.
"DRUM KIT" will change from blinking back to the normal display.



For a list of the preset drum kits, refer to "Preset Drum Kit List" (p. 98).

Selecting the Pad Bank

Here's how to switch between pad banks A and B.

1. Press [PAD BANK].
Each time you press the button, the pad bank will cycle between A → B → AB.

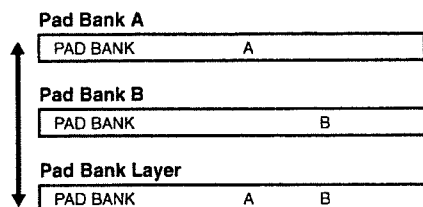

When both A and B are displayed, the Pad Bank Layer function is active. (See the following item.)



The instruments recorded in a pattern cannot be changed later by pressing [PAD BANK].

Using Both Pad Banks a and B Simultaneously (Pad Bank Layer)

Pad Bank Layer is a function that simultaneously plays the instruments of both pad banks A and B.

1. Press [PAD BANK] to make "AB" appear.

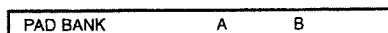

The Pad Bank Layer setting is stored in the currently selected drum kit.

Taking Advantage of This Function



If you assign the same instrument to the same pad of both pad banks A and B, and slightly lower the pitch (p. 72) of one instrument, using Pad Bank Layer to play both instruments simultaneously will produce a richer sound.



If you assign different instruments to pad bank A and pad bank B, and make separate Sensitivity Curve settings (p. 76) for each instrument, differences in the force with which you strike the pad when Pad Bank Layer is used will allow you to shift between the two instruments, or create other complex tonal changes.

Using a Pad to Play a Roll

You can play a “roll” (a succession of evenly spaced notes) on an instrument.

1. Hold down [ROLL/FLAM], and press and hold a pad.

Changing the Roll Settings

You can adjust the spacing (density) of the roll. This setting also allows you to play a **flam**.



Flam is a performance technique in which the sticks held in both hands are used to strike the same drum (snare, etc.) with a slight difference in timing and force.

1. Press [UTILITY] to get the display to read “UTILITY.”
The DR-770 is now in Utility mode.
2. Use [◀] [▶] to select “1 ROLL TYPE.”

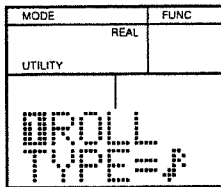

3. Use [VALUE*] to set the interval of the roll.
To produce a flam, use [DEC] [INC] or [VALUE] to select “FL.”

Display	Interval	Display	Interval
	32nd note		Quarter note triplets
	16th note triplets		Quarter note
	16th note		Half note
	8th note triplets	FL	Flam
	8th note		

Modifying the Flam Settings

When ROLL TYPE is set to Flam, you can modify the Flam Interval and Flam Ratio to change the way that the flam is played.

Flam Interval (0-31)

This sets the interval of time that will elapse between the two notes of the flam. With a setting of 0 there will be no flam.

Flam Ratio (0-7)

This sets the ratio of striking force (velocity) between the first and second strikes. With a setting of 0, the ornamental note will not sound.

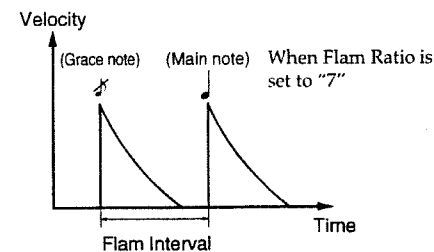

1. Press [UTILITY] to get the display to read “UTILITY.”
The DR-770 is now in Utility mode.
2. Use [◀] [▶] to select the parameter that you wish to change. If you wish to adjust the interval, select “2 FLAM INT.” If you wish to change the flam ratio, select “3 FLAM RATIO.”

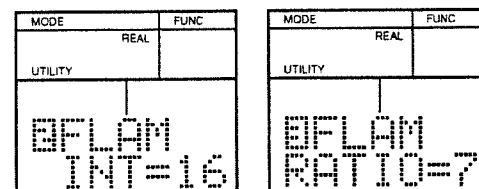

3. Use [VALUE*] to adjust the value of the setting.

An Easy Way to Apply Effects (Ambience)

The Ambience function provides a way to comprehensively control the three built-in effects (reverb, flanger, equalizer), making it easy to apply effects.

NOTE

When you turn Ambience on, the effect settings (p. 80) of the drum kit and of each instrument will be ignored, and effects will be applied according to the Ambience setting.

NOTE

When the drum kit where the Individual (p. 82) is set has been selected, the Ambience cannot be used.

1. Press [AMBIENCE].

The following display will appear.

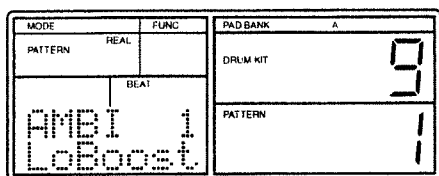

Ambience type

2. Use [DEC] [INC] or [VALUE] to select the Ambience type.

- | | | |
|----|---------|------------|
| 1 | LoBoost | (Lo-Boost) |
| 2 | Flang'n | (Flanging) |
| 3 | Bright | |
| 4 | Hi-Fi | |
| 5 | Dark | |
| 6 | Lo-Fi | |
| 7 | Room | |
| 8 | Studio | |
| 9 | Garage | |
| 10 | Club | |
| 11 | Hall | |
| 12 | Stadium | |
| 13 | Space | |
| 14 | Echo | |
| 15 | Doublin | (Doubling) |
| 16 | Flat | |

3. To turn Ambience off, press [AMBIENCE] once again. Each time you press [AMBIENCE], the Ambience function will be switched on or off.

Playing Patterns

Here's how to select and play a pattern from the 400 preset patterns or 400 user patterns.

1. Press [SONG/PTN] so the display indicates "PATTERN."

The DR-770 is now in Pattern mode.

2. Use [VALUE*] to select the desired pattern.

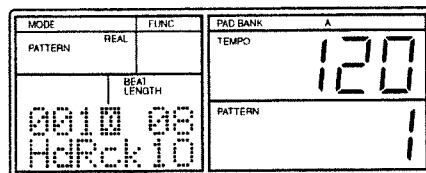

Pattern name

Pattern number

3. Press [START] to start playback.

MEMO

The Pattern number will also be shown above the Pattern name only while the Original pattern (p. 50) is selected.

Adjusting the Tempo

1. Press [TEMPO] to make "TEMPO" blink.

2. Use [VALUE*] to adjust the tempo.

The tempo can be adjusted in the range of 20–260.

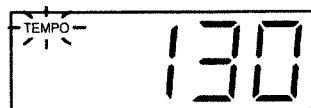

3. When you are satisfied with the tempo, press [TEMPO] once again.

"TEMPO" will change from blinking back to the normal display.

Using the DPP Function to Play Patterns

The DPP (Direct Pattern Play) function lets you play patterns that have been assigned to the pads (1–16).

1. Press [DPP] so the display indicates "DPP."

The DR-770 is now in DPP mode.

2. When you press a pad, the pattern assigned to that pad will begin playing.

The tempo indicator will blink on each beat, and the beat number will change as playback progresses.

The display will indicate the name and number of the pattern that is playing.

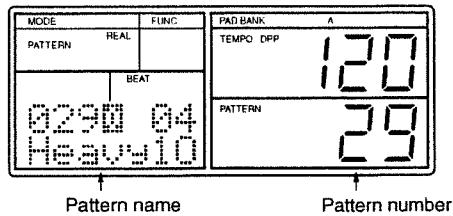

If you press a different pad during playback, the current pattern will finish playing, and then the pattern assigned to the last-pressed pad will begin playing.

NOTE

If you press [PAD BANK], the pattern cannot be changed.

3. Press [STOP/EXIT] to stop playback.
If you press the pad once again, the pattern will start playing from the beginning.
4. To exit the DPP function, press [DPP] once again to cancel the "DPP" display.

Assigning a Pattern to a Pad

Here's how to assign a pattern (1–16) to a pad so that you can use the Direct Pattern Play function.

1. Press [DPP] so the display indicates "DPP."
The DR-770 is now in DPP mode.
2. Use [VALUE*] to select the pattern that you want to assign to a pad.
3. Hold down [DPP] while you press the desired pad.
The currently selected pattern will be assigned to the pad you pressed.
4. Repeat steps 2–3 as necessary.
5. When you have finished making settings, press [DPP].
You will exit DPP mode.

Using Quick Search to Select a Pattern

The Quick Search function lets you search for a desired pattern by **category**.

NOTE

Quick Search cannot be used while recording a pattern or song (i.e., while the REC indicator is lit).

1. While holding down [ROLL/FLAM], press [DPP].
2. Use [DEC] [INC] or [VALUE] to select the desired category.

HD ROCK	Hard Rock, Heavy Metal	
ROCK	Rock	
POP	Pops, 16 beat, 8 beat	
FNK&BLS	Funk, Blues, Soul	
JAZZ	Jazz, Fusion	
DANCE	Hip-Hop, Techno, etc.	
LATIN	Bossa Nova, Samba, etc.	
WORLD	World	
USER 1	User Pattern	401–416
USER 2	User Pattern	417–432
USER 3	User Pattern	433–448
:	:	:
USER25	User Pattern	785–800

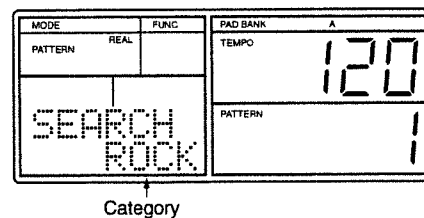

Patterns belonging to the selected category will be assigned to the pads (1–16).

3. When you press a pad, the pattern assigned to it will start playing.
The tempo indicator will blink on each beat, and the beat number will change as playback progresses.
The display will indicate the name and number of the pattern that is playing.
If you press another pad while the pattern is still playing, the pattern assigned to the last-pressed key will begin playing on the next beat.

NOTE

Depending on the category you selected, some pads may not have a pattern assigned to them. If such a pad is pressed, the lower right of the display will indicate "---" for approximately one second.

4. To stop playback, press [STOP/EXIT].
If you press the pad once again, the pattern will start playing from the beginning.
5. To exit the Quick Search function, press [ENTER].

Adding a Fill-in (Realtime Pattern Change)

Realtime Pattern Change is a function that lets you switch the playback to a previously selected pattern by using the [RWD] [FWD] buttons while a pattern is playing.

By using this function, you can quickly add a fill-in during a performance. The Realtime Pattern Change function handles patterns as follows.

Original Pattern

This is the pattern from which you start.

Variation Pattern

This is the pattern that is used as a variation of the original pattern.

Fill-in to Original Pattern

This is the pattern used as a fill-in before playing the original pattern.

Fill-in to Variation Pattern

This is the pattern used as a fill-in before playing the variation pattern.



Preset patterns consist of the above four patterns as a set. Refer to "Preset Pattern List" (p. 106).

1. Press [SONG/PTN] so the display indicates "PATTERN."
The DR-770 is now in Pattern mode.
2. Use [VALUE*] to select the original pattern that you wish to play.

Display of Original Pattern

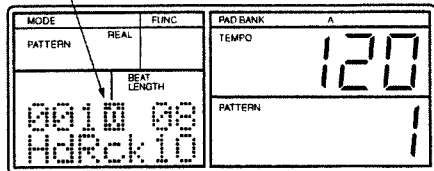

The Pattern number will also be shown above the Pattern name only while the Original pattern is selected.

3. Press [START] to play back the pattern.

- When you press [START] during playback, the playback will continue to the end of the current pattern, and will then switch to the Variation Pattern.

Display of Variation Pattern

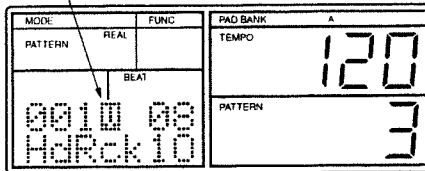

- When you press [START] during playback the Variation Pattern, the playback will continue to the end of the current pattern, and will then switch to the Original Pattern.
- When you press [RWD] during playback, the Fill-in To Original Pattern will start playing.
When it finishes playing, playback will switch to the Original Pattern.

Display of Fill-in To Original Pattern

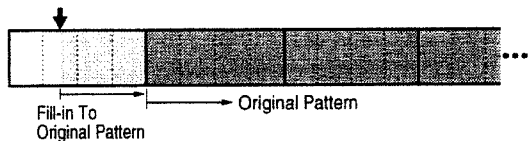
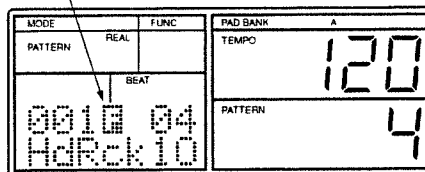

- When you press [FWD] during playback, the Fill-in To Variation Pattern will start playing.
When it finishes playing, playback will switch to the Variation Pattern.

Display of Fill-in To Variation Pattern

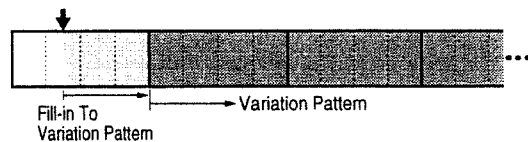
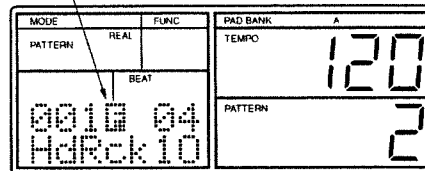

- If you press [RWD] between the last beat of the pattern and the beginning of the next pattern, the Fill-in To Original Pattern will be played from the beginning of the next pattern, and then playback will switch to the Original Pattern.

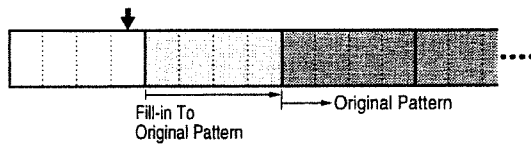

- If you press [FWD] between the last beat of the pattern and the beginning of the next pattern, the Fill-in To Variation Pattern will be played from the beginning of the next pattern, and then playback will switch to the Variation Pattern.

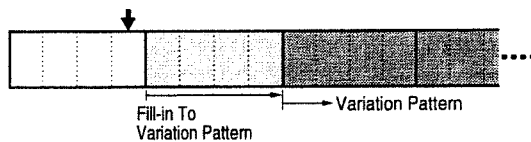

- If you press [STOP/EXIT] to stop playback while the Variation Pattern / Fill-in Pattern is playing, and then press [RESET], you will return to the beginning of the Original Pattern.

MEMO

For details on specifying the original/fill-in/variation patterns for a User Pattern, refer to "Specifying the original/fill-in/variation patterns" (p.61).

Playing a Song

1. Press [SONG/PTN] so the display indicates "SONG." The DR-770 is now in Song mode.
2. Use [VALUE*] to select the song you wish to play.

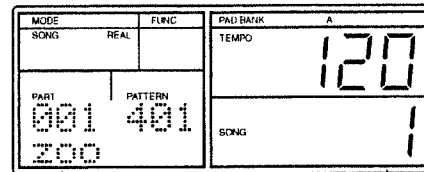

Song name

Song number

NOTE

If the selected song contains no musical data, the following display will appear.

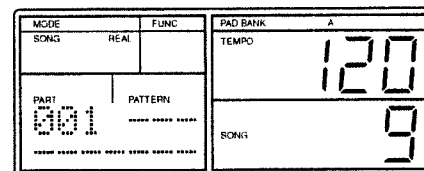

3. Press [START] to start playback.
The tempo indicator will blink on each beat, and the number of the currently playing part will be displayed.
4. Press [STOP/EXIT] to stop playback.
If you press [START] once again, playback will resume from where it had been stopped.
If you first press [RESET] and then press [START], playback will start from the beginning of the song.

Playing from the Middle of a Song

You can choose to start playback from a specified part within a song. This is convenient when you wish to begin playing from the middle of a song that consists of many parts. With song playback stopped, use the following procedure.

1. Use [RWD] [FWD] to select the part at which you wish to begin playing.

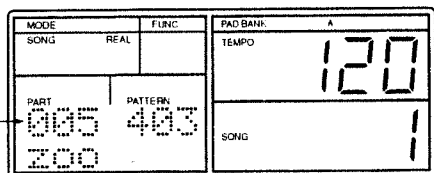

Part where play starts

2. When you press [START], playback will start from the specified part.

Consecutive Playback of Multiple Songs (Song Chain)

The Song Chain function allows you to consecutively play back two or more songs.

For each song, you can specify the number of the song that is to be played next. In this way, you can consecutively play back up to 100 songs.

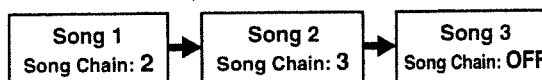

Use the following procedure to create a song chain.

1. Press [SONG/PTN] so the display indicates "SONG." The DR-770 is now in Song mode.
2. Use [VALUE*] to select the song for which you wish to make song chain settings.
3. Press [REC]. The REC indicator will light.
4. Press [◀ CURSOR] twice to select "CHN" (song chain).
5. Use [VALUE*] to select the song that will be played next.

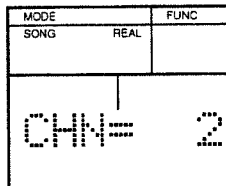

For the last song of consecutive playback, select "OFF" (no song chain).

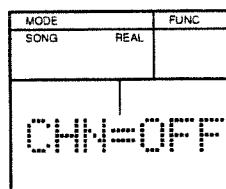

6. After selecting the song, press [STOP/EXIT].
7. Repeat steps 2–6 as necessary to create the desired song chain.

Chapter 3. Recording a Pattern

User patterns can be recorded either by realtime recording or step recording.

● Notes on Pattern Recording

- If you have recorded a pattern by using Pad Bank Layer with Pad Bank A or B, all instrument sounds will be automatically played in Pad Bank Layer when the pattern is played back.
- The instruments recorded in a pattern cannot be changed later by pressing [PAD BANK].
- Even if you select Pad Bank A or B by pressing [PAD BANK] to play back the pattern recorded with Pad Bank Layer, only the instrument of Pad Bank A will be played.

Realtime Recording a Pattern

1. Press [SONG/PTN] so the display indicates "PATTERN."
The DR-770 is now in Pattern mode.
2. Press [REAL/STEP] so the display indicates "REAL."
This selects realtime recording.
3. Use [VALUE*] to select the pattern (user pattern) that you wish to record.
4. Press [REC].
The REC indicator will light, and the display will indicate "QUANTIZE."

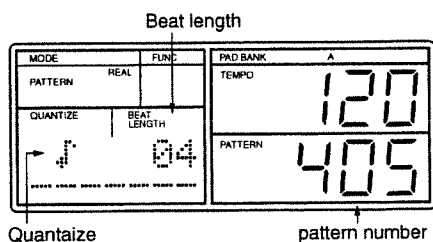

5. Use [VALUE*] to specify the Quantize setting.
Quantize is a function that corrects inaccuracies in the timing at which you strike pads during recording, so that notes are aligned precisely with the beat. Normally you should set the Quantize setting to the smallest note value that you intend to record.

Display	Quantize	Display	Quantize
OFF	no quantize		8th note
	32nd note		Quarter note triplets
	16th note triplets		Quarter note
	16th note		Half note
	8th note triplets		

If you do not wish to quantize, select "OFF." If OFF is selected, the notes will be recorded at the exact timing at which you strike the pads.

6. Press [CURSOR ►] to make the Beat Length display blink.
7. Use [VALUE*] to specify the Beat Length.
Beat Length is the number of quarter notes in the pattern.
For example, if you wanted to record a pattern consisting of one measure of 4/4 time, you would set Beat Length to "4." If you wanted to record a two-measure pattern in 3/4 time, you would set Beat Length to "6."
8. Press [DRUM KIT] to make "DRUM KIT" blink.
9. Use [VALUE*] to select a drum kit.
You can choose from preset drum kits 1–64 and user drum kits 65–128.

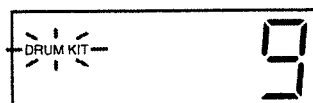

MEMO

For details on the preset drum kits, refer to "Preset Drum Kit List" (p. 98).

10. After selecting a drum kit, press [DRUM KIT] once again.
"DRUM KIT" will change from blinking back to the normal display.
11. Press [START].
The metronome will begin sounding, and the tempo indicator will light in time with the count.
12. Press [REC] to make the REC indicator go dark. This will select rehearsal mode.
The metronome will continue sounding, but nothing will be recorded when you strike the pads.
Strike the pads in time with the metronome to rehearse your pattern.

- If the metronome tempo is too fast (slow), use the following procedure to set a comfortable tempo.

- 1) Press [TEMPO] to make "TEMPO" blink.
- 2) Use [VALUE*] to adjust the tempo.
- 3) When you are satisfied with the tempo, press [TEMPO] once again.

NOTE

The tempo you specify is temporary, and will not be stored in the pattern.

When you have finished rehearsing, continue with the following steps.

13. Press [REC] to make the REC indicator light, and start recording.

14. In time with the metronome, strike the pads to which the instruments you want to record are assigned. The velocity (force with which you strike the pads) will also be recorded.

The sounds you record will continue playing repeatedly.

- As necessary, use [PAD BANK] to switch the pad bank.
- By holding [ROLL/FLAM] while you strike a pad, you can record a roll (flam).

NOTE

Even if a roll has been set to play notes at an extremely short interval, the notes that are actually recorded will be spaced at intervals of the specified Quantize value. If you want to record the roll as it was originally specified (Interval: p. 47), set Quantize to "OFF."

NOTE

Up to nine instruments can be recorded on the same step. If you attempt to record more than this, the tenth and subsequent will be ignored.

NOTE

It is not possible to record two or more instruments of the same pad number on the same step.

- To delete a previously recorded note while recording
While holding down [DELETE], press the pad to which the instrument you want to delete has been assigned. Notes of the corresponding instrument will be deleted as long as you continue holding [DELETE] and that pad.

15. When you finish recording, press [STOP/EXIT].

Step Recording a Pattern

1. Press [SONG/PTN] so the display indicates "PATTERN."
The DR-770 is now in Pattern mode.
2. Press [REAL/STEP] so the display indicates "STEP."
This selects step recording.

MODE	FUNC
PATTERN	STEP

3. Use [VALUE*] to select the pattern (user pattern) that you want to record.
4. Press [REC].
The REC indicator will light, and the display will indicate "QUANTIZE."

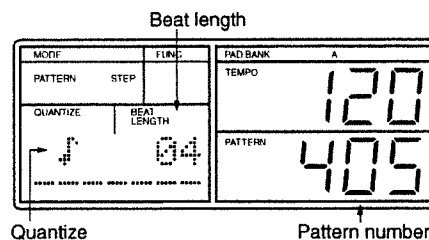

5. Use [VALUE*] to make Quantize settings.
For step recording, the Quantize setting specifies how finely each beat will be divided.
The number of steps per clock is calculated as ♩=96 clocks.

Display	Quantize (Clock)	Display	Quantize (Clock)
OFF	no quantize (1)	♪	8th note (48)
♪	32nd note (12)	♪ ₃	Quarter note triplets (64)
♪ ₃	16th note triplets (16)	♪	Quarter note (96)
♪	16th note (24)	♩	Half note (192)
♪ ₃	8th note triplets (32)		

6. Press [CURSOR ►] to make the Beat Length display blink.
7. Use [VALUE*] to specify the Beat Length.
Beat Length is the number of quarter notes in the pattern.
For example, if you wanted to record a one-measure pattern in 4/4 time, you would set a beat length of "4." If you wanted to record a two-measure pattern in 3/4 time, you would set a beat length of "6."

8. Press [TEMPO] to make "TEMPO" blink.
9. Use [VALUE*] to adjust the tempo.
10. When you are satisfied with the tempo, press [TEMPO] once again.
11. Press [DRUM KIT] to make "DRUM KIT" blink.
12. Use [VALUE*] to select the desired drum kit.
You can choose from preset drum kits 1–64 and user drum kits 65–128.



MEMO

For details on the preset drum kits, refer to "Preset Drum Kit List" (p. 98).

13. After selecting a drum kit, press [DRUM KIT] once again.
"DRUM KIT" will change from blinking to the normal display.
14. Press [START] to make the tempo indicator light, and start recording.
15. Use [RWD] [FWD] to specify the step (beat/clock) that you want to record.

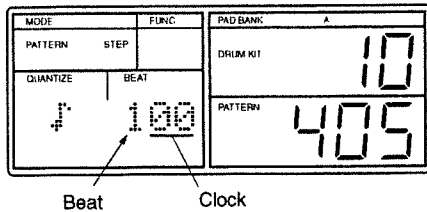

(Example) When Quantize is set to ♩ =48

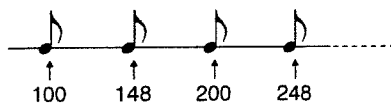

16. Strike the pad to which the instrument you want to record is assigned.
The velocity (the force with which you strike the pad) will also be recorded.
You will automatically advance by one step.
 - If desired, use [PAD BANK] to switch the pad bank.
 - When the Roll type is set to flam, you can recorded a flam by holding down [ROLL/FLAM] while you strike a pad.

17. Repeat steps 15–16 as many times as needed.

18. When you want to record another instrument, use [VALUE*] to modify the Quantize setting as necessary, and repeat steps 15–16 as many times as required.

NOTE

Up to nine instruments can be recorded on the same step. If you attempt to record more than this, the tenth and subsequent will be ignored.

NOTE

It is not possible to record two or more instruments of the same pad number on the same step.

MEMO

If you press [RWD] [FWD] on a step that has already been recorded, the instruments that were recorded on that step will sound. The name of the instrument first recorded on that step will blink in the display.

● To audition the recorded notes

If you press [START] during recording, the recorded pattern will play back together with the metronome. If the tempo is too fast (slow), you can adjust it. Press [STOP] to stop the playback.

NOTE

Be aware that if you strike a pad during this playback, the instrument assigned to that pad will be recorded.

● To delete an already-recorded note during recording

Use [RWD] [FWD] to specify the step, and hold down [DELETE] while you press the pad to which the instrument you want to delete is assigned.
If the instrument that you want to delete is assigned to a pad number 33 (-01)–55 (-23), use [◀] [▶] to select the instrument that you want to delete, and hold down [DELETE] while you press [ENTER].

19. When you finish recording, press [STOP/EXIT].

Changing the Metronome Settings

You can change the volume and time signature (count interval) of the metronome.

1. Press [UTILITY] so the display indicates "UTILITY."
The DR-770 is now in Utility mode.
2. Using [◀][▶], select "6 CLICK LEVEL" if you want to adjust the volume, or "7 CLICK SEL" if you want to change the time signature.

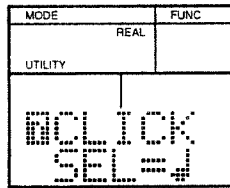
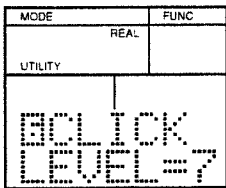

3. Use [VALUE*] to change the setting.
Volume: 0-7
Time signature: Refer to table shown below

Display	Beat
	16th note
	8th note triplets
	8th note
	Quarter note triplets
	Quarter note

Chapter 4. Editing a Pattern

Deleting an Individual Note

Perform the steps below to delete only a single note from a pattern.

1. Press [SONG/PTN] so the display indicates "PATTERN."
The DR-770 is now in Pattern mode.
2. Press [REAL/STEP] so the display indicates "STEP."
This selects Step Recording.
3. Use [VALUE*] to select the desired pattern (user pattern).
4. Press [REC].
The REC indicator will light.
5. Press [START].
The tempo indicator will light.
6. Use [RWD] [FWD] to select the step at which the instrument you want to delete was recorded.
7. Press [CURSOR ►] to select the instrument that you want to delete.
Each time you press [CURSOR ►], each instrument that was recorded at the selected step and its velocity will be displayed, blinking alternately.
To return to the previous display, press [◀ CURSOR].
Pressing [ENTER] here will play the instrument currently selected.

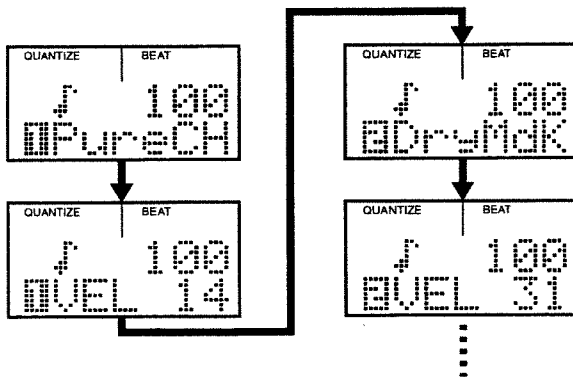

8. Hold down [DELETE] and press [ENTER].
The instrument will be deleted.

MEMO

You can also delete an instrument by holding down [DELETE] and play back the pad to which the instrument is assigned.

9. To end the procedure, press [STOP/EXIT].

Adding an Individual Note

If you wish to add an individual note to a pattern, use the following procedure.

1. Press [SONG/PTN] so the display indicates "PATTERN."
The DR-770 is now in Pattern mode.
2. Press [REAL/STEP] so the display indicates "STEP."
Step Recording will be selected.
3. Use [VALUE*] to select the desired pattern (user pattern).
4. Press [REC].
The REC indicator will light.
5. Press [START].
The tempo indicator will light.
6. Use [RWD] [FWD] to select the step at which you wish to add an instrument.
7. Strike the pad to which the instrument you want to record has been assigned.

NOTE

A maximum of nine instruments can be recorded in the same step. If you attempt to record more, the tenth and subsequent instruments will be ignored.

NOTE

It is not possible to record two or more instruments of the same pad number at the same step.

Adjusting the Volume of an Individual Note

If you wish to adjust the volume (velocity) of an individual note within a pattern, use the following procedure.

1. Press [SONG/PTN] so the display indicates "PATTERN."
The DR-770 is now in Pattern mode.
2. Press [REAL/STEP] so the display indicates "STEP."
Step Recording will be selected.
3. Use [VALUE*] to select the desired pattern (user pattern).
4. Press [REC].
The REC indicator will light.
5. Press [START].
The tempo indicator will light.

6. Use [RWD] [FWD] to select the step at which the instrument whose velocity you wish to adjust was recorded.
7. Press [CURSOR ▶] to select the velocity that you wish to adjust.
Each time you press [CURSOR ▶], each instrument that was recorded at the selected step and its velocity will be displayed, blinking alternately.
To return to the previous display, press [◀ CURSOR].
Pressing [ENTER] here will play the instrument currently selected.

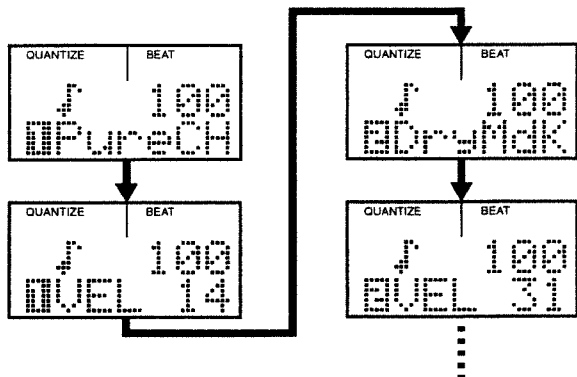

8. Use [VALUE*] to modify the velocity.
Value: 1-31
9. To end the procedure, press [STOP/EXIT].

Replacing an Instrument

If you wish to replace a recorded instrument with a different instrument, use the following procedure.

1. Press [SONG/PTN] so the display indicates "PATTERN."
The DR-770 is now in Pattern mode.
2. Press [REAL/STEP] so the display indicates "STEP."
Step Recording has been selected.
3. Use [VALUE*] to select the desired pattern (user pattern).
4. Press [REC].
The REC indicator will light.
5. Press [START].
The tempo indicator will light.
6. Use [RWD] [FWD] to select the step at which the instrument you wish to replace has been recorded.

7. Press [CURSOR ▶] to select the instrument that you wish to replace.
Each time you press [CURSOR ▶], each instrument that was recorded at the selected step and its velocity will be displayed, blinking alternately.
To return to the previous display, press [◀ CURSOR].
Pressing [ENTER] here will play the instrument currently selected.

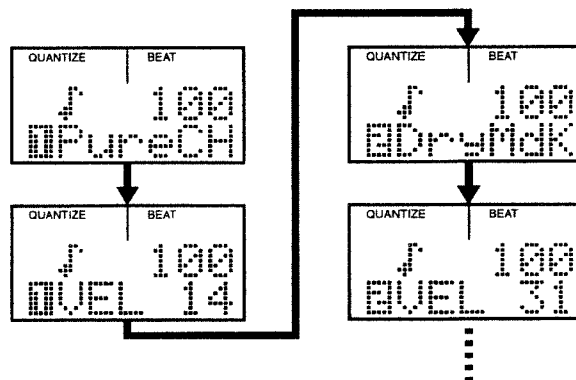

8. Use [DEC] [INC] or [VALUE] to change the instrument.
You can even select the instruments assigned to pad number 33 (-01) -55 (-23).
As necessary, press [CURSOR ▶] to display the velocity, and use [VALUE*] to modify the velocity.

NOTE

It is not possible to select an instrument that is not found in the currently selected drum kit.

NOTE

It is not possible to record two or more instruments of the same pad number at the same step.

9. To end the procedure, press [STOP/EXIT].

Replacing a Drum Kit

If you wish to replace the drum kit used during recording with a different drum kit, use the following procedure.

1. Press [SONG/PTN] so the display indicates "PATTERN."
The DR-770 is now in Pattern mode.
2. Press [REAL/STEP] so the display indicates "STEP."
Step Recording has been selected.
3. Use [VALUE*] to select the desired pattern (user pattern).
4. Press [REC].
The REC indicator will light.
5. Press [START].
The tempo indicator will light.
6. Press [DRUM KIT] to make "DRUM KIT" blink.
7. Use [VALUE*] to select the desired drum kit.
You can choose from preset drum kits 1–64 and user drum kits 65–128.



8. After selecting a drum kit, press [DRUM KIT] once again.
"DRUM KIT" will change from blinking back to the normal display.
9. To end the procedure, press [STOP/EXIT].

Adding a "Swing" Feel to a Pattern (Swing)

By making Swing settings you can give the rhythm a bouncy feel when it is played, even if the written note values are evenly spaced. This is done by delaying the timing at which backbeats of the quantized note value are sounded.

1. Press [SONG/PTN] so the display indicates "PATTERN."
The DR-770 is now in Pattern mode.
2. Use [VALUE*] to select the pattern (user pattern) for which you want to make Swing settings.
3. Press [UTILITY] so the display indicates "UTILITY."
The DR-770 is now in Utility mode.
4. Use [◀][▶] to select "4 SWING."

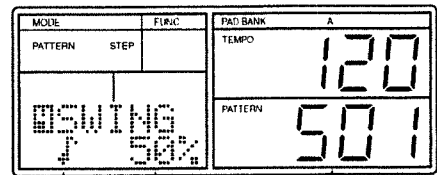

Quantize Swing value Pattern where Swing is to be set

5. Use [◀][▶] to make the Quantize setting blink.
6. Use [VALUE*] to set the Quantize value.

Display	Quantize
	32nd note
	16th note
	8th note
	Quarter note

7. Press [CURSOR ▶] to make the Swing value blink.
8. Use [VALUE*] to set the Swing value.

Values: 50%, 54%, 58%, 62%, 67%, 71%, 75%, 80%

Swing specifies the percentage by which the note will be delayed. Increasing this value will delay the note more, producing a stronger sense of swing. A setting of 50% will space the notes equally, and a setting of 67% will produce triplets.

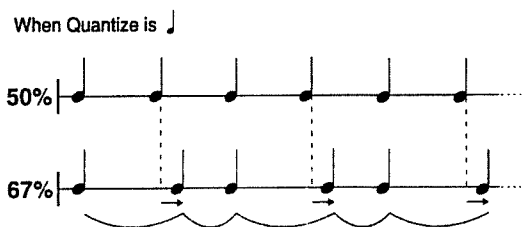

9. Press [ENTER].
The display will ask you to confirm the operation — "Sure?."
10. To make the swing settings, press [ENTER].
To cancel, press [STOP/EXIT].

Shifting the Timing at Which an Instrument Sounds (Timing Shift)

Timing Shift is a function that moves a recorded instrument backward or forward within a pattern by a specified number of clocks. This can be used to create “rushing” or “dragging” effects, to make a pattern sound more natural.

NOTE

After Timing Shift has been set, it is not possible to return to the previous condition. If you want to keep the previous pattern, copy it (p. 62) to another pattern before executing the Timing Shift operation.

1. Press [SONG/PTN] so the display indicates “PATTERN.”
The DR-770 is now in Pattern mode.
2. Use [VALUE*] to select the pattern (user pattern) for which you want to set Timing Shift.
3. Press [UTILITY] so the display indicates “UTILITY.”
The DR-770 is now in Utility mode.
4. Use [◀] [▶] to select “5 SHIFT.”

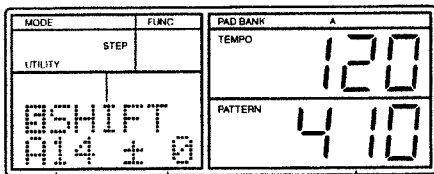

Pad number Value Pattern where Timing Shift is to be set

5. Select the pad to which the instrument you want to time-shift has been assigned.
You can also use [DEC] [INC] or [VALUE] to make a selection.

NOTE

You can use [PAD BANK] to switch the pad bank, but it will not be possible to select Pad Bank Layer (p. 46).

NOTE

If you have selected a pattern that was created with a drum kit that uses Pad Bank Layer, the display will indicate “L,” and it will not be possible to switch the pad bank by pressing [PAD BANK].

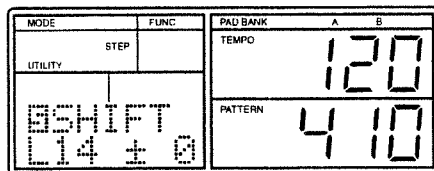

Display of Pad Bank Layer

6. Press [CURSOR ▶] to make the Timing Shift value blink.
7. Use [VALUE*] to set the Timing Shift value.
This setting specifies the number of clocks the instrument will be moved from the original step. With ♩ = 96 clocks, the instrument can be moved over a range of -96→+96. Negative (-) settings will move the note forward, and positive (+) settings will move the note backward.

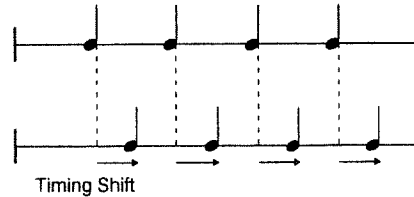

8. Press [ENTER].
The display will ask if you are “Sure?” you want to set Timing Shift.
9. To confirm the Timing Shift setting, press [ENTER].
To cancel, press [STOP/EXIT].

NOTE

Instruments that were moved outside of the pattern as a result of Timing Shift will not be played. A rest will occur at any blank area that is created.

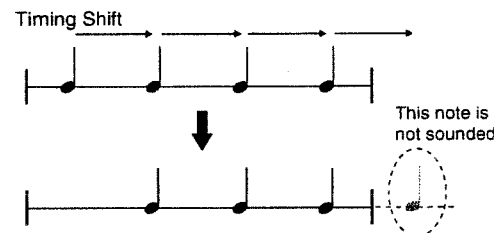

Specifying the Original/Fill-in/ Variation Patterns

Here's how to specify the Original/Fill-in/Variation patterns that are used by Realtime Pattern Change (p. 50).

1. Press [SONG/PTN] so the display indicates "PATTERN."
The DR-770 is now in Pattern mode.
2. Use [VALUE*] to select the user pattern that will be the Original pattern.
3. Press [REC].
The REC indicator will light.
4. Press [◀ CURSOR] once to access the Realtime Pattern Change settings.

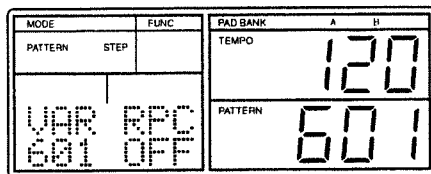

5. Use [DEC] [INC] or [VALUE] to turn RPC "ON."
If this is turned "OFF," the Realtime Pattern Change settings will be ignored.
6. Press [◀ CURSOR] to make the Variation Pattern number (VAR) blink.
7. Use [VALUE*] to select the pattern that will be the Variation pattern.

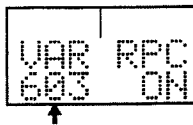

8. Press [◀ CURSOR] to make the Fill-in To Variation Pattern number (FTV) blink.

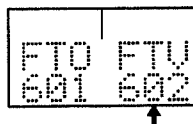

9. Use [VALUE*] to select the pattern that will be the Fill-in To Variation pattern.
10. Press [◀ CURSOR] to make the Fill-in To Original Pattern number (FTO) blink.

11. Use [VALUE*] to select the pattern that will be the Fill-in To Original pattern.

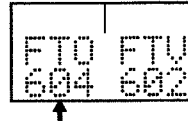

12. When you have finished making settings, press [STOP/EXIT].



After having set each pattern to Original/Fill-in Variation, the Pattern number will also be shown above the Pattern name only while the Original pattern is selected.

Naming a Pattern

Each user pattern can be assigned a name (pattern name) of up to seven characters.

1. Press [SONG/PTN] so the display indicates "PATTERN."
The DR-770 is now in Pattern mode.
2. Use [VALUE*] to select the user pattern to which you want to assign a name.
3. Press [REC].
The REC indicator will light.
4. Press [CURSOR ▶] twice to make the pattern name display area blink.
The far left character will blink.

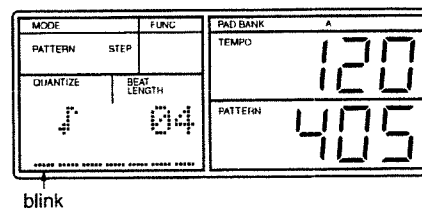

5. Use [VALUE*] to select a character (alphabet/number/symbol).

Space	!	"	#	\$	%	&	'	()
*	+	,	-	.	/	0	-	9	:
;	<	=	>	?	@	A	-	Z	[
]	^	_	`	a	-	z	{		}
~	÷	←							

6. After selecting the desired character, press [CURSOR ▶] once to advance to the next location.

7. Repeat steps 5–6 as many times as necessary to specify the pattern name.
8. When you have finished specifying the pattern name, press [STOP/EXIT].

Deleting a Pattern

An unneeded pattern can be deleted.

NOTE

It is not possible to delete a preset pattern (1–400).

1. Press [SONG/PTN] so the display indicates "PATTERN."
The DR-770 is now in Pattern mode.
2. Use [VALUE*] to select the user pattern that you want to delete.
3. With playback stopped, press [DELETE]. (The display will indicate "DELETE.")
The display will ask "Sure?," so that you can confirm whether you want to delete the pattern.

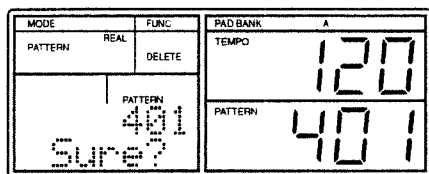

NOTE

If you try to delete the pattern that has no performance data, the display will show "Pattern Empty!." Pressing [STOP/EXIT], however, will retrieve the step 2.

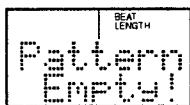

4. To delete the pattern, press [ENTER].
The pattern will be deleted, and the display will indicate "Done."
If you decide not to delete, press [STOP/EXIT].
The display will indicate "Aborted," and the pattern will not be deleted.

Copying a Pattern

A pattern can be copied to another pattern.

1. Press [SONG/PTN] so the display indicates "PATTERN."
The DR-770 is now in Pattern mode.
2. Use [VALUE*] to select the copy source pattern.
3. With playback stopped, press [COPY]. (The display will indicate "COPY.")

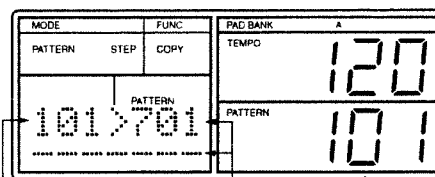

Source Pattern number Destination Pattern (number / name)
Source Pattern number

NOTE

If you try to copy the pattern that has no performance data, the display will show "Pattern Empty!." Pressing [STOP/EXIT], however, will retrieve the step 2.

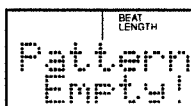

4. Use [VALUE*] to select the copy destination pattern (user pattern).

NOTE

Be aware that if the copy destination pattern has already been recorded, its data will be overwritten by the copy operation, and will be lost.

5. Press [ENTER].
The display will ask "Sure?," so that you can confirm whether you really want to copy the pattern.

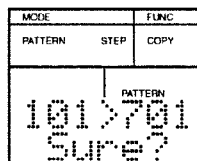

6. To copy the pattern, press [ENTER].
The pattern will be copied, and the display will indicate "Done."
If you decide not to execute the operation, press [STOP/EXIT].
The display will indicate "Aborted," and the pattern will not be copied.

Chapter 5. Recording a Song

- You can record up to 100 songs.
- Each song can contain up to 250 patterns, and all songs together can total up to 10,000 patterns.

Realtime Recording

This method lets you select and play patterns, and record your selections immediately as a song.

NOTE

It is not possible to realtime-record onto an already-recorded song.

1. Press [SONG/PTN] so the display indicates "PATTERN."
Pattern mode will be selected.
2. Use [VALUE*] to select the pattern that you want to record first.
3. Press [SONG/PTN] so the display indicates "SONG."
The DR-770 is now in Song mode.
4. Press [REAL/STEP] so the display indicates "REAL."
Realtime Recording will be selected.
5. Use [VALUE*] to select the song that you want to record.
6. Press [REC].
The REC indicator will light.
7. Press [START] to begin recording.
At the moment you press [START], the first-selected pattern will begin playing.
The tempo indicator will blink on each beat.

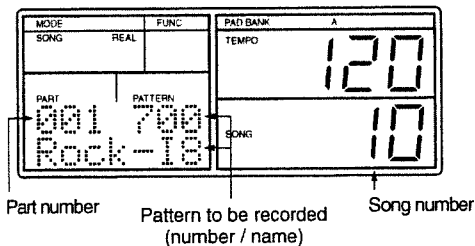

NOTE

The playback will continue repeating (and being recorded) until you select the next pattern to record.

8. Use [VALUE*] to select the pattern that you want to record next.

- In the case of an Original pattern for which you have made Realtime Pattern Change settings (p. 50), the Fill-in and Variation patterns you select by pressing [START] [RWD] [FWD] will be recorded just as you select them.

9. Repeat step 8 as many times as desired to record enough patterns for your song.

NOTE

If the number of parts reaches 250, recording will stop automatically.

10. To stop recording, press [STOP/EXIT].

Using the DPP Function to Realtime Recording

1. Press [SONG/PTN] so the display indicates "SONG."
The DR-770 is now in Song mode.
2. Press [REAL/STEP] so the display indicates "REAL."
Realtime Recording will be selected.
3. Use [VALUE*] to select the song that you want to record.
4. Press [REC].
The REC indicator will light.
5. Press [DPP] so the display indicates "DPP."
The DR-770 is now in DPP mode.
6. Press a pad to which the Pattern to be recorded first is assigned.
The Pattern will be played and the recording will be started at the same time.

NOTE

The playback will continue repeating (and being recorded) until you select the next pattern to record.

7. Select the Pattern to be recorded next by pressing the relevant pad.
8. Repeat step 7 as many times as needed.
9. To stop recording, press [STOP/EXIT].

While you are realtime-recording, suppose that you used Realtime Pattern Change (p. 50) to record a Fill-in or Variation pattern while playing the Original pattern. If you later use step-recording to edit this song, the pattern (i.e., Original or Variation) that that changed to the Fill-in pattern will have an "*" added to its pattern number.

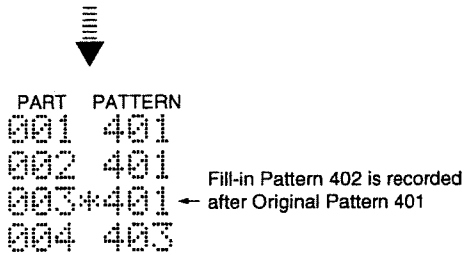
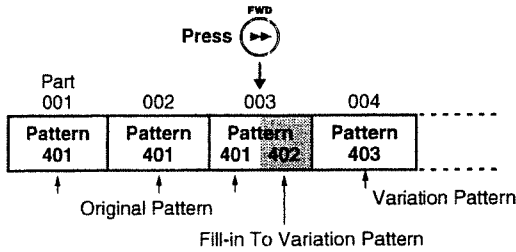

Step Recording

In this method of recording, you specify individual patterns in the desired order (part) for playback.

1. Press [SONG/PTN] so the display indicates "SONG."
The DR-770 is now in Song mode.
2. Use [VALUE*] to select the song that you want to record.
3. Press [REAL/STEP] so the display indicates "STEP."
Step recording will be selected.
4. Press [REC].
The REC indicator will light.
5. Press [START] to begin recording.

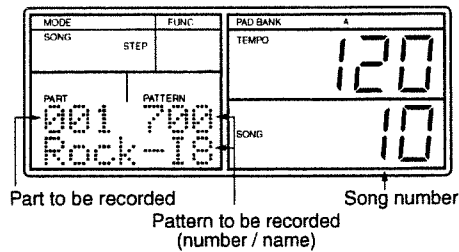

6. Use [VALUE*] to select the pattern that you want to record.
 - By using DPP (p. 48) , you can strike a pad to record the pattern that is assigned to that pad.
7. When you have found the desired pattern, press [ENTER].
The pattern will be recorded at the current part, and the part will automatically advance by one.
 - If you press [START], the currently selected pattern will play back. Press [STOP/EXIT] to stop playback.
 - While recording, you can use the following procedure to change an already-recorded pattern to a different pattern.
 - 1) Use [RWD] [FWD] to select the part that you want to re-record.
 - 2) Use [VALUE*] to select the pattern that you want to newly record.
 - 3) When you have found the desired pattern, press [ENTER].
8. Repeat steps 6–7 as many times as necessary to record patterns for your song.
9. To stop recording, press [STOP/EXIT].

Chapter 6. Editing a Song

Preventing the Drum Kit from Being Changed

Normally, when the pattern changes while playing a song, the drum kit will also switch to the drum kit that was used when recording that pattern. However, if you switch off the "Drum Kit Change" setting, the drum kit that was selected when the song was started will play all the way to the end of the song.

1. Press [SONG/PTN] so the display indicates "SONG."
The DR-770 is now in Song mode.
2. Use [VALUE*] to select the song whose Drum Kit Change setting you want to modify.
3. Press [REC].
The REC indicator will light, and the Drum Kit Change setting ("KIT") will appear.

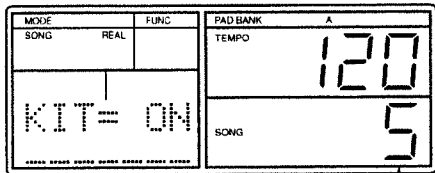

Song number

4. Use [INC][DEC] or [VALUE] to turn the setting "OFF."
ON: When the pattern changes the drum kit will also change, but it will not be possible to change the drum kit during playback by pressing [DRUM KIT].
OFF: The drum kit that was selected when the song was started will continue playing to the end of the song, but you can change the drum kit during playback by pressing [DRUM KIT].
5. When you finish making settings, press [STOP/EXIT].

Naming a Song

You can assign a name (song name) of up to seven characters to a song you record. The song name will appear in the display when the song is played back.

1. Press [SONG/PTN] so the display indicates "SONG."
The DR-770 is now in Song mode.
2. Use [VALUE*] to select the song that you want to name.
3. Press [REC].
The REC indicator will light.
4. Use [◀][▶] to make the song name display area blink.
The far left space will blink.

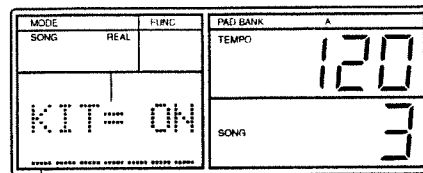

blink

5. Use [VALUE*] to select a character (alphabet/numeral/symbol).

Space	!	"	#	\$	%	&	'	()
*	+	,	-	.	/	0	-	9	:
;	<	=	>	?	@	A	-	Z	[
]	^	_	`	a	-	z	<		
}	~								

6. When you have selected the desired character, press [CURSOR▶] once to advance to the next character location.
7. Repeat steps 5-6 as many times as necessary to assign the desired song name.
8. When you have finished assigning the song name, press [STOP/EXIT].

Specifying the Song Tempo (Initial Tempo)

You can specify the Initial Tempo that will be used to play back the song. If you specify an Initial Tempo, the song will be played back at the specified tempo, regardless of the current tempo display.

1. Press [SONG/PTN] so the display indicates "SONG."
The DR-770 is now in Song mode.
2. Use [VALUE*] to select the song for which you want to specify the Initial Tempo.
3. Press [REC].
The REC indicator will light.
4. Use [◀CURSOR] so the display indicates "INT."

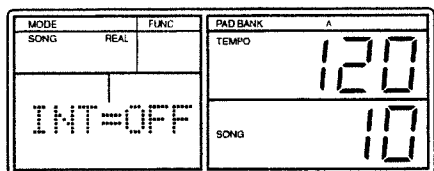

Song number

5. Use [VALUE*] to specify the Initial Tempo.
If this is turned "OFF," the song will play back at the currently displayed tempo.
6. After you have set the Initial Tempo, press [STOP/EXIT].

Deleting an Unwanted Pattern

Here's how you can delete an unwanted pattern from a song.

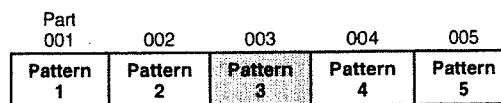

Delete

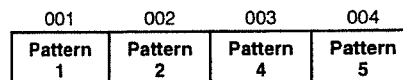

1. Press [SONG/PTN] so the display indicates "SONG."
The DR-770 is now in Song mode.
2. Use [VALUE*] to select the song from which you want to delete a pattern.
3. Press [REAL/STEP] so the display indicates "STEP."
Step recording will be selected.
4. Press [REC].
The REC indicator will light.
5. Press [START].
6. Use [RWD] [FWD] to select the pattern that you want to delete.

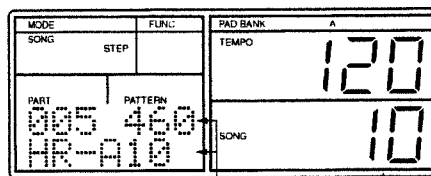

Pattern to be deleted (number / name)

Song number

7. Press [DELETE]. (The display will indicate "DELETE.")
The display will ask "Sure?," allowing you to confirm whether you want to delete the pattern.

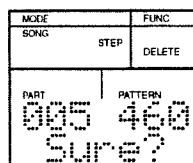

8. To delete the pattern, press [ENTER].
The pattern will be deleted, and the display will indicate "Done."
If you decide not to delete the pattern, press [STOP/EXIT].
The display will indicate "Aborted," and the pattern will not be deleted.
9. To end the procedure, press [STOP/EXIT].
The REC/tempo indicator will go dark.

Inserting a Pattern within a Song

Here's how you can insert a pattern into the middle of a song.

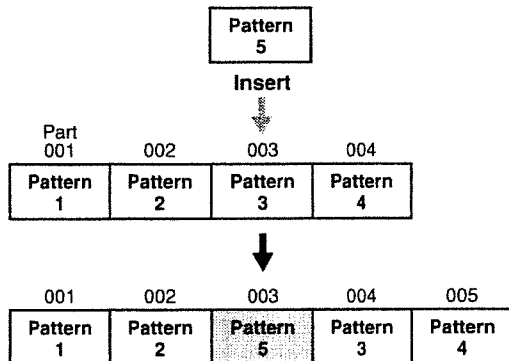

1. Press [SONG/PTN] so the display indicates "SONG."
The DR-770 is now in Song mode.
2. Use [VALUE*] to select the song into which you want to insert a pattern.
3. Press [REAL/STEP] so the display indicates "STEP."
Step recording will be selected.
4. Press [REC].
The REC indicator will light.
5. Press [START].
6. Use [RWD] [FWD] to select the part at which you want to insert a pattern.
7. Press [COPY]. (The display will indicate "INSERT" "COPY.")
8. Use [VALUE*] to select the pattern that you want to insert.

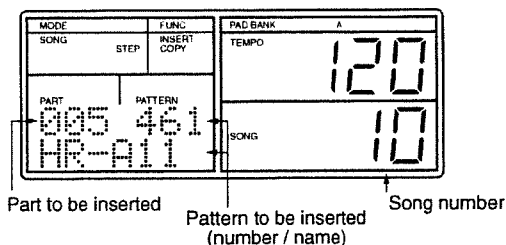

9. Press [ENTER].
The display will ask "Sure?," allowing you to confirm whether you want to insert a pattern.

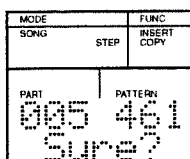

10. To insert the pattern, press [ENTER].
The pattern will be inserted, and the display will indicate "Done."
If you decide not to insert the pattern, press [STOP/EXIT].
The display will indicate "Aborted," and the pattern will not be inserted.
11. To end the procedure, press [STOP/EXIT].
The REC/tempo indicator will go dark.

Deleting a Song

Here's how to delete a song that you no longer need.

NOTE

It is not possible to delete a demo song.

1. Press [SONG/PTN] so the display indicates "SONG."
The DR-770 is now in Song mode.
2. Use [VALUE*] to select the song that you want to delete.
3. With playback stopped, press [DELETE]. (The display will indicate "DELETE.")
The display will ask "Sure?," so that you can confirm whether or not you want to delete the song.

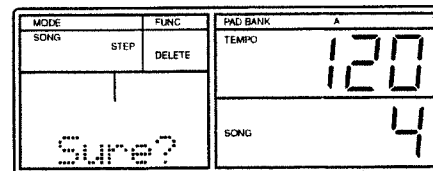

Song to be deleted

NOTE

If you try to delete the song that has no performance data, the display will show "Song Empty!." Pressing [STOP/EXIT], however, will retrieve the step 2.

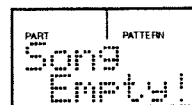

4. To delete the song, press [ENTER].
The song will be deleted, and the display will indicate "Done."
If you decide not to delete the song, press [STOP/EXIT].
The display will indicate "Aborted," and the song will not be deleted.
5. To end the procedure, press [STOP/EXIT].
The REC/tempo indicator will go dark.

Copying a Song

Here's how to copy a song to another song.

NOTE

It is not possible to copy a demo song.

1. Press [SONG/PTN] so the display indicates "SONG."
The DR-770 is now in Song mode.
2. Use [VALUE*] to select the copy source song.
3. With playback stopped, press [COPY]. (The display will indicate "COPY.")

NOTE

If you try to copy the song that has no performance data, the display will show "Song Empty!." Pressing [STOP/EXIT], however, will retrieve the step 2.

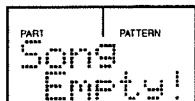

4. Use [VALUE*] to select the copy destination song.

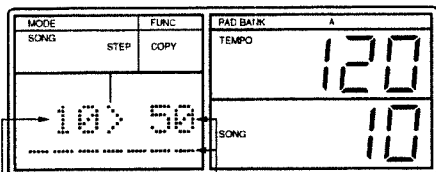

Source Song Destination Song
(number / name)

NOTE

Be aware that if the copy destination song has already been recorded, any previous data in the copy destination song will be lost when the Copy operation is executed.

5. Press [ENTER].
The display will ask "Sure?," allowing you to confirm whether you want to execute the operation.

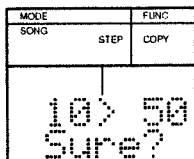

6. To copy the song, press [ENTER].
The song will be copied, and the display will indicate "Done."
If you decide not to copy the song, press [STOP/EXIT]. The display will indicate "Aborted," and the song will not be copied.
7. To end the procedure, press [STOP/EXIT].
The REC/tempo indicator will go dark.

Chapter 7. Performing with a Foot Switch

Using a Foot Switch to Start/Stop Playback

If you connect a foot switch (FS-5U or similar; optional) to the rear panel PEDAL SW jack, you can use the foot switch to start/stop playback.

Connections

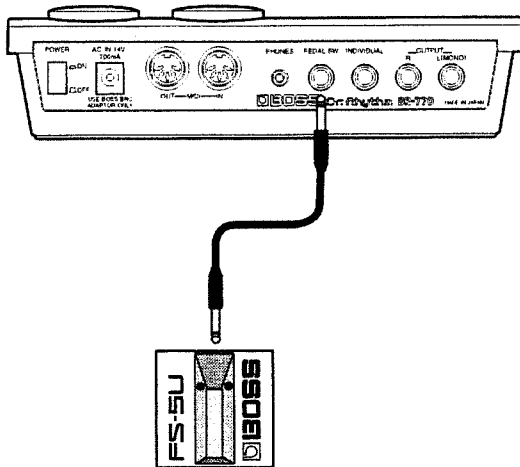

NOTE

To prevent malfunction and/or damage to speakers or other devices, always turn down the volume, and turn off the power on all devices before connecting the foot switch.

NOTE

When connecting a foot switch (FS-5U; optional) to the PEDAL SW jack, set the polarity switch as described below.

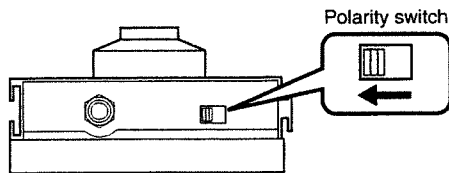

Procedure

- When song/pattern playback is stopped, pressing the foot switch will start playback.
- When a song/pattern is playing, pressing the foot switch will stop playback.

Using a Foot Switch to Insert a Fill-in

If you use a special cable (PCS-31; optional) to connect the foot switch, you can connect up to two foot switches. One foot switch will be dedicated to starting/stopping playback, and the other foot switch can be assigned to play a fill-in or to another function.

Connections

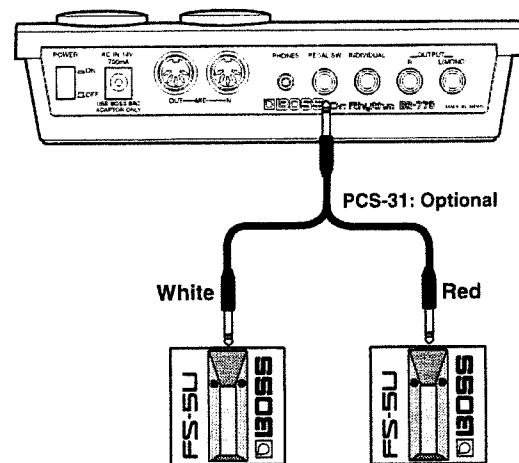

The foot switch connected to the plug with the white line will be dedicated to starting/stopping playback.

Assigning a Function to the Foot Switch

1. Press [UTILITY] so the display indicates "UTILITY." The DR-770 is now in Utility mode.
2. Use [◀] [▶] to select "8 FOOT 2."

MODE	REAL	FUNC
UTILITY		
8 FOOT 2 CHASE		

3. Use [DEC] [INC] or [VALUE] to select the function that will be assigned.

Display	Function
CHASE:	Reserves the pattern that will be played following the currently playing pattern. When not in DPP mode: Reserves the pattern of "pattern number + 1" When in DPP mode: Reserves the pattern assigned to "pad number + 1"
FWD:	When you press the foot switch while playing a pattern for which Realtime Pattern Change settings have been made, the Fill-in To Variation pattern will be played. After the Fill-in To Variation pattern finishes playing, playback will move to the Variation pattern.
RWD :	When you press the foot switch while playing a pattern for which Realtime Pattern Change settings have been made, the Fill-in To Original pattern will be played. After the Fill-in To Original pattern finishes playing, playback will move to the Original pattern.
RESET:	The playback location will return to the beginning of the pattern.
REC:	When pattern recording is possible, the DR-770 will move to record-standby mode.
PAD 1–16:	Pressing the foot switch will have the same result as striking the pad of the corresponding number. If the DR-770 is in DPP mode, a pattern will play back.
RST_S/S:	Start/stop playback of the song/pattern. The difference from Foot Switch 1 is that if you stop during playback, the playback will resume from the beginning of the song/pattern the next time you press the foot switch.

Chapter 8. Creating an Original Drum Kit

You can modify various settings for a drum kit and create up to 64 of your own original drum kits (user drum kits).

- You can use the pads of pad banks A and B to select instruments assigned to pad numbers 01 (A01)–32 (B16), and then modify the settings of each instrument.
- It is also possible to modify the settings of the instruments that are assigned to pad numbers 33 (-01)–55 (-23) and therefore cannot be played from the pads.

Selecting a Drum Kit from Which to Start

First, select the drum kit whose settings you wish to modify.

NOTE

For the preset drum kits (1–64), settings other than the drum kit name (p.77) can be modified temporarily, but they will return to their original settings when you select another drum kit.

1. Press [DRUM KIT] to make "DRUM KIT" blink.



2. Use [VALUE*] to select a drum kit.

Preset: 1–64

User: 65–128

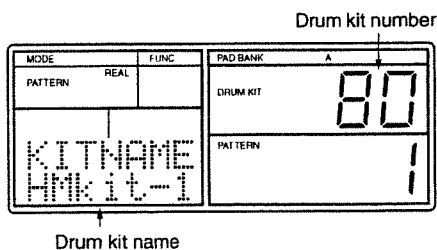

3. After selecting a drum kit, press [DRUM KIT] once again.
"DRUM KIT" will change from blinking back to the normal display.

Modifying the Settings of an Instrument

Selecting an Instrument and Assigning It to a Pad (Instrument Assign)

Here's how to select instruments and assign them to the pads of pad banks A and B and to pad numbers 33 (-01)–55 (-23).

MEMO

For a list of the 255 built-in instruments, refer to "Instrument List" (p. 96).

1. After selecting a drum kit, press [PAD] so the display indicates "PAD."

The DR-770 is now in Pad mode.

2. Use [◀] [▶] to select "1 ASSIGN."

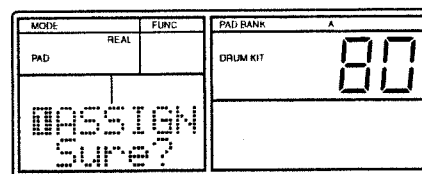

3. Press [ENTER].

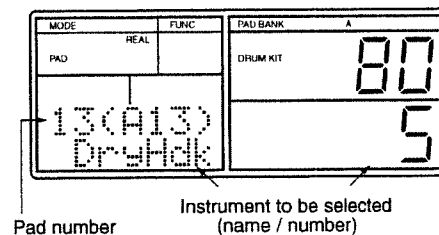

4. Press [PAD BANK] to select the desired pad bank.
5. Press the pad whose instrument you want to change.
 - To change the instrument of a pad number 33 (-01)–55 (-23), use [◀] [▶] to select the pad number.
6. Use [VALUE*] to select the instrument that you want to newly assign.
If you do not wish to assign any instrument, select "OFF."
- Press [ENTER], and you will be able to play the selected instrument.
7. Repeat steps 4–6 as necessary.
8. When you are finished, after selecting an instrument for a pad number 33 (-01)–55 (-23), press [STOP/EXIT].
9. After selecting the desired instrument, press [STOP/EXIT].

Adjusting the Volume (Level)

Here's how to adjust the volume (level) of each instrument. The velocity at which you strike the pad will change the volume inside the level you specify here.

1. After selecting a drum kit, press [PAD] so the display indicates "PAD."
The DR-770 is now in Pad mode.
2. Use [◀] [▶] to select "2 LEVEL."

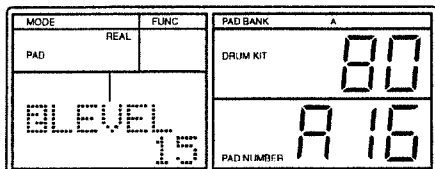

3. Press [PAD BANK] to select the desired pad bank.

NOTE

If you select pad bank layering, the display will blink "LAYER." It is not possible to adjust the level in this condition.

4. Press the pad for the instrument whose level you want to adjust.
 - If you wish to adjust the level of an instrument for pad numbers 33 (-01)–55 (-23), use the following procedure to select the pad number.
 - 1) Press [ENTER].
 - 2) Use [◀] [▶] to select the pad number.
 When you wish to go back to using the pads to select instruments, press [STOP/EXIT].
5. Use [VALUE*] to set the level.
Range: 0–15
- If a pad number 33(-01)–55(-23) is selected, you can press [ENTER] to play the instrument.
6. Repeat steps 3–5 as necessary.
7. To end the procedure after adjusting the level of instruments for pad numbers 33 (-01)–55 (-23), press [STOP/EXIT].

Adjusting the Pitch (Pitch)

The pitch of each instrument can be adjusted in 10-cent steps.

1. After selecting a drum kit, press [PAD] so the display indicates "PAD."
The DR-770 is now in Pad mode.
2. Use [◀] [▶] to select "3 PITCH."

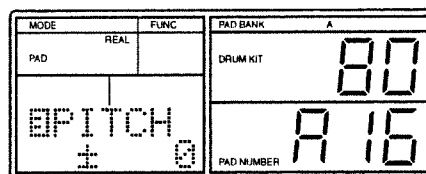

3. Press [PAD BANK] to select the desired pad bank.

NOTE

If the pad banks are layered, the display will blink "LAYER." In this state it is not possible to set the pitch.

4. Press the pad for the instrument whose pitch you want to set.
 - If you wish to set the pitch of an instrument for pad numbers 33 (-01)–55 (-23), use the following procedure to select the pad number.
 - 1) Press [ENTER].
 - 2) Use [◀] [▶] to select the pad number.
 When you wish to go back to using the pads to select instruments, press [STOP/EXIT].
5. Use [VALUE*] to adjust the pitch.
Range: -2400– +2400
±0: Original pitch
+ settings: Increasing the value will raise the pitch. 100 cents will raise the pitch one semitone.
- settings: Increasing the value will lower the pitch. 100 cents will lower the pitch one semitone.

NOTE

For some instruments, the pitch may not change beyond a certain point.

- If a pad number 33(-01)–55(-23) is selected, you can press [ENTER] to play the instrument.
6. Repeat steps 3–5 as many times as necessary.
 7. If you have been adjusting the pitch for the instruments of pad numbers 33 (-01)–55 (-23), press [STOP/EXIT] to end the procedure.

Lengthening or Tightening the Decay (Decay)

You can specify the time over which the sound of each instrument decays to silence.

1. After selecting a drum kit, press [PAD] so the display indicates "PAD."

The DR-770 is now in Pad mode.

2. Use [◀] [▶] to select "4 DECAy."

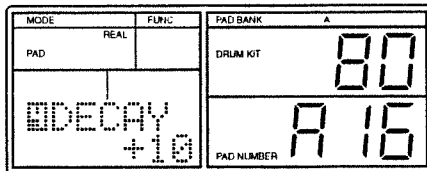

3. Press [PAD BANK] to select the desired pad bank.

NOTE

If the pad banks are layered, the display will blink "LAYER." In this state it is not possible to set the decay.

4. Press the pad for the instrument whose decay you want to set.

- If you wish to set the decay for an instrument of pad numbers 33 (-01)–55 (-23), use the following procedure to select the pad number.

- 1) Press [ENTER].
- 2) Use [◀] [▶] to select the pad number.

When you wish to resume using the pads to select instruments, press [STOP/EXIT].

5. Use [VALUE*] to adjust the decay.

Range: -31– +31

- ±0: Original decay
 - + settings: Increasing the value will lengthen the decay.
 - settings: Increasing the value will shorten the decay.
- For some instruments, may not produce as much change as you expect.

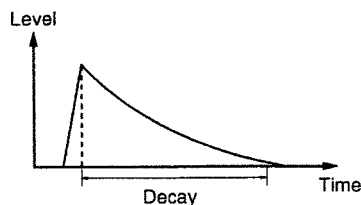

- If a pad number 33(-01)–55(-23) is selected, you can press [ENTER] to play the instrument.
6. Repeat steps 3–5 as many times as necessary.
 7. To end the procedure after modifying the decay for instruments of pad numbers 33 (-01)–55 (-23), press [STOP/EXIT].

Adjusting the Location of the Strike (Nuance)

When a cymbal (for example) is struck, the tone will differ depending on whether it was struck near the center or near the edge.

Instruments marked with * or ** in the "Instrument List" (p. 96) provide a Nuance setting that you can adjust to modify the tone in a way that reflects the location of the strike.

1. After selecting a drum kit, press [PAD] so the display indicates "PAD."

The DR-770 is now in Pad mode.

2. Use [◀] [▶] to select "5 NUANCE."

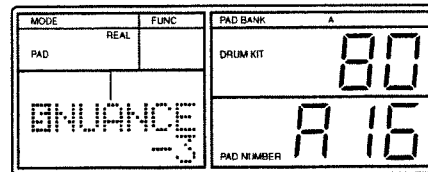

3. Press [PAD BANK] to select the desired pad bank.

NOTE

If the pad banks are layered, the display will blink "LAYER." In this state it is not possible to adjust the Nuance.

4. Press the pad for the instrument whose Nuance you want to set.

- If you wish to adjust the Nuance for instruments of pad numbers 33 (-01)–55 (-23), use the following procedure to select the pad number.

- 1) Press [ENTER].
- 2) Use [◀] [▶] to select the pad number.

When you wish to resume using the pads to select instruments, press [STOP/EXIT].

5. Use [VALUE*] to adjust the Nuance.

Range: -7– +7

NOTE

For instruments that do not provide a Nuance setting, the display will show the value as "---."

Instrument marked by *

- ±0: Original nuance
- + values: Increasing the value will boost the low-frequency components. (simulated strike toward the center.)
- values: Increasing the value will diminish the low-frequency components. (simulated strike toward the edge.)

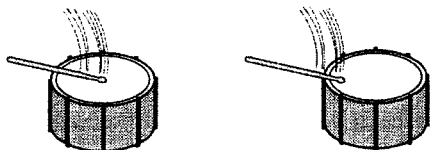

Instrument marked by ** (hi-hat, ride cymbal, etc.)

- ±0: Original nuance
- + values: Increasing the value will move the simulated strike toward the center.
- values: Increasing the value will move the simulated strike toward the edge.

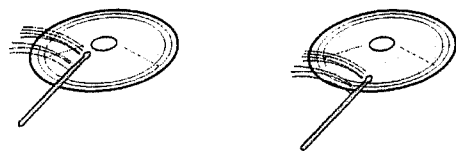

- If a pad number 33 (-01)–55 (-23) is selected, you can press [ENTER] to play the instrument.
- 6. Repeat steps 3–5 as many times as necessary.
- 7. To end the procedure after modifying the Nuance for instruments of pad numbers 33 (-01)–55 (-23), press [STOP/EXIT].

Setting the Stereo Location (Pan)

For each instrument of a drum kit, you can select a location within the stereo sound field (pan) from among 15 available positions.

1. After selecting a drum kit, press [PAD] so the display indicates "PAD."
The DR-770 is now in Pad mode.
2. Use [◀] [▶] to select "6 PAN."

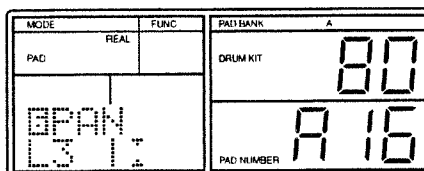

3. Press [PAD BANK] to select the desired pad bank.

NOTE

If the pad banks are layered, the display will blink "LAYER." In this state it is not possible to set the pan.

4. Press the pad for the instrument whose pan you want to set.
 - If you wish to set the pan for the instruments of pad numbers 33 (-01)–55 (-23), use the following procedure to select the pad number.
 - 1) Press [ENTER].
 - 2) Use [◀] [▶] to select the pad number.
 When you wish to resume using the pads to select instruments, press [STOP/EXIT].
5. Use [DEC] [INC] or [VALUE] to set the pan.
Range: L7–C–R7, INDIV
If "INDIV" is selected, the sound will not be output from OUTPUT L/R and the PHONES jack.

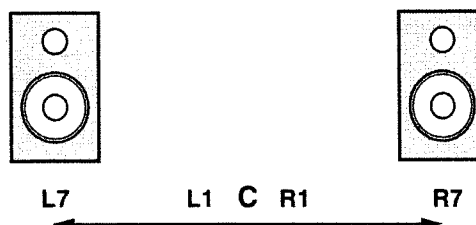

NOTE

The pan setting (except when "INDIV") of Instrument marked with *** in the "Instrument List" (p. 96) will be ignored.

NOTE

Even if "INDIV" is selected, sound will not be output from the INDIV jack unless the Individual Output setting (p. 82) is set to "IND."

- If a pad number 33 (-01)–55 (-23) is selected, you can press [ENTER] to play the instrument.
- 6. Repeat steps 3–5 as many times as necessary.
- 7. If you have been setting the pan for the instruments of pad numbers 33 (-01)–55 (-23), end the procedure by pressing [STOP/EXIT].

Preventing/Allowing Simultaneous Instruments (Assign Type)

For each instrument, you can specify how it will be allowed to sound (Assign Type) when multiple notes are played on that instrument or on other instruments.

1. After selecting a drum kit, press [PAD] so the display indicates "PAD."
The DR-770 is now in Pad mode.
2. Use [◀] [▶] to select "7 A.TYPE."

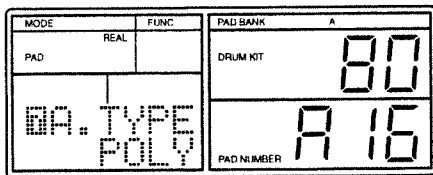

3. Press [PAD BANK] to select the desired pad bank.

NOTE

If the pad banks are layered, the display will blink "LAYER." In this state it is not possible to set the assign type.

4. Press the pad for the instrument whose assign type you want to set.
 - If you wish to set the assign type for the instruments of pad numbers 33 (-01)–55 (-23), use the following procedure to select the pad number.
 - 1) Press [ENTER].
 - 2) Use [◀] [▶] to select the pad number.
 When you wish to resume using the pads to select instruments, press [STOP/EXIT].
5. Use [DEC] [INC] or [VALUE] to set the assign type.
Range: POLY, POLY EXC1–7, MONO, MONO EXC1–7

POLY

When an individual instrument is played repeatedly, each successive note will be layered onto the currently sounding notes (i.e., without muting them). This is effective on sounds that have a long decay, such as cymbals.

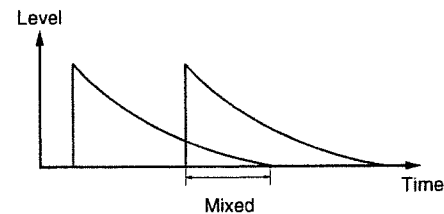
**POLY EXC**

Repeated strikes on an individual instrument will be layered, but will not sound together with any other instrument that is set to the same EXC number. This is effective for instruments such as open hi-hat and closed hi-hat, which normally cannot sound simultaneously, but which will produce layered notes when an individual instrument is struck repeatedly.

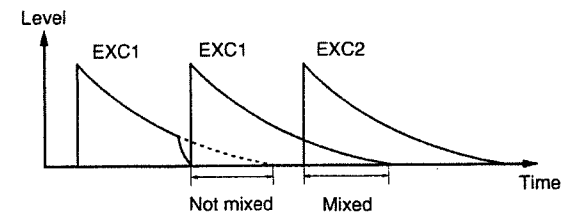
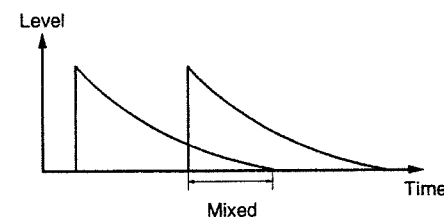
**MONO**

When an individual instrument is struck repeatedly, the previously sounding note will be muted (silenced) before the next note is sounded.

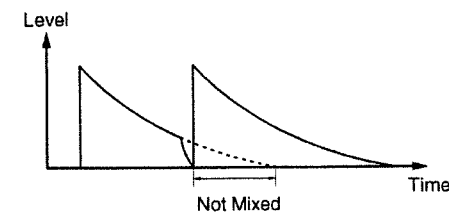

MONO EXC

The instrument will not sound simultaneously with any other instrument that is assigned to the same EXC number. Nor will repeated strikes on the instrument be layered. This is effective on instruments such as Guiro Short or Guiro Long, where it is normally impossible for the two performance techniques to be heard simultaneously.

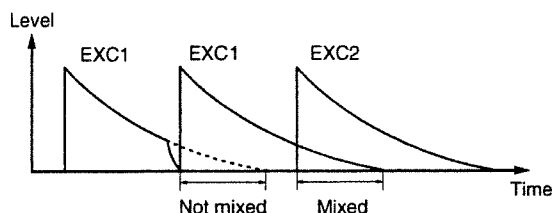
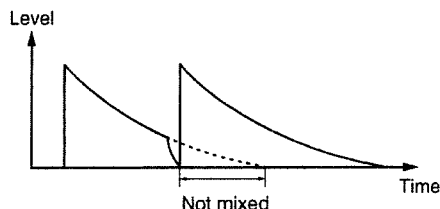

- If a pad number 33(-01)-55(-23) is selected, you can press [ENTER] to play the instrument.
- 6. Repeat steps 3-5 as many times as necessary.
- 7. To end the procedure after modifying the assign type for instruments of pad numbers 33 (-01)-55 (-23), press [STOP/EXIT].

Selecting How Pad Striking Force Will Affect the Sound (Sensitivity Curve)

For each pad bank A and B, you can select a response curve (Sensitivity Curve) that will determine how volume, tone, etc., will change in response to the force with which you strike the pads.

NOTE

It is not possible to set the Sensitivity Curve independently for each pad.

1. After selecting a drum kit, press [PAD] so the display indicates "PAD."
The DR-770 is now in Pad mode.
2. Use [◀] [▶] to select "8 CRV."

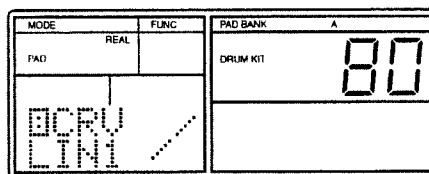

3. Press [PAD BANK] to select the desired pad bank.

NOTE

If the pad banks are layered, the display will flash the word "LAYER." In this state it is not possible to set the sensitivity curve.

4. Use [DEC] [INC] or [VALUE] to select the Sensitivity Curve.
Range: EXP1, LIN1, EXP2, LIN2, XFDO, XFDI, FIX1, FIX2

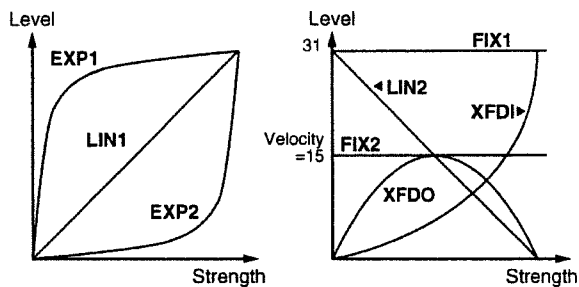

If XFDI or XFDO are selected, you can use pad bank layering to produce a feeling of natural dynamics.

5. Repeat steps 3-4 as many times as necessary.

Naming a Drum Kit (Drum Kit Name)

If a drum kit other than a preset drum kit (numbers 1–64) is selected, you can assign it a name (drum kit name) of up to seven characters.

1. After selecting a drum kit, press [PAD] so the display indicates "PAD."
The DR-770 is now in Pad mode.
2. Use [◀][▶] to select "9 KITNAM."

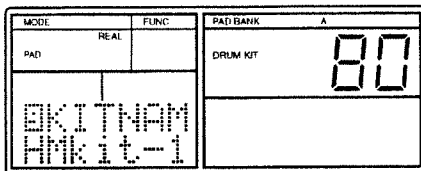

3. Use [VALUE*] to select a character (letter/numeral/symbol).

Space	!	"	#	\$	%	&	'	(
*	+	,	-	.	/	0	-	9
:	<	=	>	?	@	A	-	Z
[]	^	_	`	a	-	z	{
}	~	←						

4. After selecting the desired character, press [CURSOR ▶] once to move to the next character.
5. Repeat steps 3–4 as many times as necessary to assign a drum kit name.

Effect Settings

By modifying the settings of the built-in effects (reverb/flanger/equalizer), you can adjust the effects to your taste.

Using the Ambience Function to Make Approximate Settings

You can copy Ambience settings to the effect settings that have been made for a user drum kit (numbers 65–128), and then modify the copied settings as you wish.

By first copying a set of Ambience settings and then modifying the settings for each effect, you can achieve the desired result more efficiently.



You cannot copy the setting of the Ambience into a preset drum kit, but you can make the same setting as the "preset drum kit + Ambience" by copying it to a user drum kit using the procedure shown on page 84, then copy the setting of the Ambience to the drum kit.

1. Select the user drum kit to which you want to copy Ambience settings. (p. 71)
2. Press [AMBIENCE].
The following display will appear.

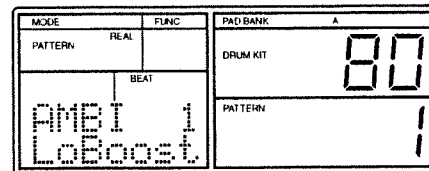

Ambience type

3. Use [VALUE*] to select the type of Ambience that you want to copy.
4. Press [COPY].
The display will ask "Modify Kit?" to confirm that you want to copy Ambience settings.

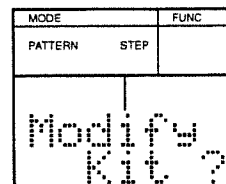

5. To copy the data, press [ENTER].
The Ambience settings will be copied, and the display will indicate "Done."
If you decide not to copy the settings, press [STOP/EXIT].
The display will indicate "Aborted," and the ambience settings will not be copied.

Adjusting the Reverb Settings

Here's how you can select and modify settings (parameters) for reverb.

1. After selecting a drum kit, press [EFFECTS] so the display indicates "EFFECTS."
The DR-770 is now in Effects mode.

2. Use [◀] [▶] to select the parameter that you want to modify.

1 R.TYPE (reverb type)

Range: HALL, ROOM, PLATE, DELAY, PAN-DLY

MODE	FUNC
REAL EFFECTS	
DR. TYPE HALL	

2 R.TIME (reverb time)

Range: 0-31

MODE	FUNC
REAL EFFECTS	
DR. TIME 18	

3 R.LPF (reverb low pass filter)

Range: 0-7

MODE	FUNC
REAL EFFECTS	
DR. LPF 3	

4 D.FDBK (delay feedback)

Range: 0-15

MODE	FUNC
REAL EFFECTS	
DR. FDBK 7	

3. Use [VALUE*] to adjust the value.

Functions of Each Parameter

1 R.TYPE (reverb type)

- HALL: This simulates the reverberation of a concert hall.
ROOM: This simulates the reverberation of a room.
PLATE: This simulates a metal-plate reverb device.
DELAY: This is a conventional delay.
PAN-DLY: This alternates the delay sound between left and right.

2 R.TIME (reverb time)

This adjusts the length of reverberation. Increasing the value will lengthen the reverberation, producing a more spacious sensation.

3 R.LPF (reverb low pass filter)

This specifies the cutoff frequency at which the high-frequency components of the reverberation will be cut. Increasing this value will cause a greater portion of the high-frequency components to be cut, producing a milder reverberation.

4 D.FDBK (delay feedback)

When the reverb type is set to DELAY or PAN-DLY, this parameter adjusts the number of times that the delay sound will be repeated.

Adjusting the Flanger Settings

Here's how you can select and modify settings (parameters) for the flanger.

1. After selecting a drum kit, press [EFFECTS] so the display indicates "EFFECTS."
The DR-770 is now in Effects mode.
2. Use [◀] [▶] to select the parameter that you want to adjust.

5 F.TYPE (flanger type)

Range: CHORUS, FLANGER

MODE	REAL	FUNC
	REAL EFFECTS	
F.F. TYPE FLANGER		

6 F.DPTH (flanger depth)

Range: 0-15

MODE	REAL	FUNC
	REAL EFFECTS	
F.F. DPTH 10		

7 F.RATE (flanger rate)

Range: 0-15

MODE	REAL	FUNC
	REAL EFFECTS	
F.F. RATE 4		

8 F.FDBK (flanger feedback)

Range: 0-15

MODE	REAL	FUNC
	REAL EFFECTS	
F.F. FDBK 2		

9 F.DLY (flanger delay)

Range: 0-31

MODE	REAL	FUNC
	REAL EFFECTS	
F.F. DLY 10		

3. Use [VALUE*] to adjust the value.

Functions of Each Parameter

5 F.TYPE (flanger type)

FLANGER: The sound will be given a twisting or "swooshing" character.

CHORUS: A chorus effect will be applied to give the sound a spacious feeling.

6 F.DPTH (flanger depth)

Adjust the modulation depth for the flanger or chorus. Increasing this value will produce deeper modulation.

7 F.RATE (flanger rate)

Specify the modulation frequency for the flanger or chorus. Increasing this value will speed up the modulation.

8 F.FDBK (flanger feedback)

Specify the amount of feedback for the flanger or chorus. Increasing this value will produce a more strongly distinctive sound.

Feedback amount: The amount of sound that is once again processed by the flanger or chorus after already having been processed.

9 F.DLY (flanger delay)

Specify the delay time for the flanger or chorus. Increasing this value will produce a long delay time.

Adjusting the Equalizer Settings

Here's how you can select and modify settings (parameters) for the equalizer.

1. After selecting a drum kit, press [EFFECTS] so the display indicates "EFFECTS."
The DR-770 is now in Effects mode.
2. Use [◀] [▶] to select the parameter that you want to modify.

EQ HIGH (equalizer high gain)

Range: -12-±0- +12 dB

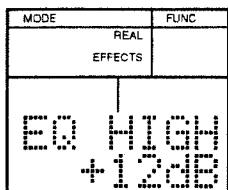

EQ LOW (equalizer low gain)

Range: -12-±0- +12 dB

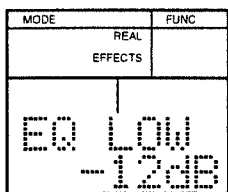

3. Use [DEC] [INC] or [VALUE] to adjust the value.

Functions of Each Parameter

EQ HIGH (equalizer high gain)

This adjusts the level (volume) of the high-frequency range in 2 dB steps. A setting of ±0 dB is the original level, negative (-) settings will decrease the level, and positive (+) settings will increase the level.

EQ LOW (equalizer low gain)

This adjusts the level (volume) of the low-frequency range in 2 dB steps. A setting of ±0 dB is the original level, negative (-) settings will decrease the level, and positive (+) settings will increase the level.

NOTE

You may hear a noise when the value of the equalizer is being changed (when an ambience or drum kit is changed to a different one).

Adjusting the Reverb/Flanger Depth

The depth of the reverb and flanger can be adjusted both for the entire drum kit and for each individual instrument.

Drum kits and instruments are connected to the reverb/flanger effects as shown in the following .

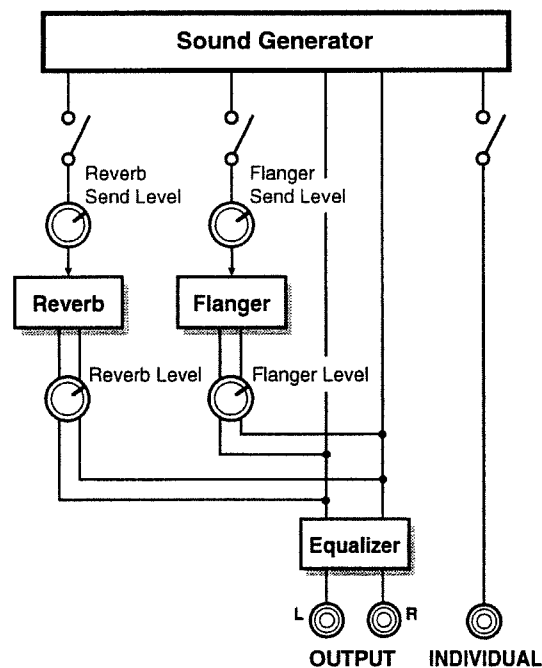

- To adjust the overall reverb/flanger depth for the entire drum kit, adjust the Reverb Level or Flanger Level.
- To adjust the reverb/flanger depth for an individual instrument, adjust the level of the signal that is sent to the reverb/flanger (Send Level).

NOTE

You cannot, however, adjust the depth of the equalizer for an individual instrument.

Adjusting the Reverb Depth

NOTE

If the output destination has been set to the individual output, reverb cannot be used.

1. After selecting a drum kit, press [REV/FLANG] several times to make "REVERB" blink.
2. Use [VALUE*] to set the Reverb Level (the overall reverb depth for the entire drum kit).
Range: 0–9

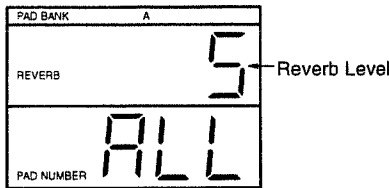

NOTE

If the Reverb Level is set to "0," no reverb will be heard even if the Reverb Send Level (see below) is raised.

3. Press the pad for the instrument whose Reverb Send Level you want to set.
As necessary, use [PAD BANK] to switch the pad bank.
The pad number and the current Reverb Send Level will be displayed.

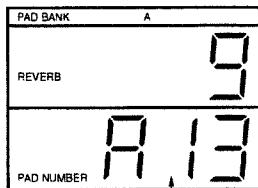

Pad number where the Reverb Send Level should be set

- If you wish to set the Reverb Send Level for the instruments of pad numbers 33 (-01)–55 (-23), use the following procedure to select the pad number.
 - 1) Press [ENTER].
 - 2) Use [◀] [▶] to select the pad number.
At this time you can press [ENTER] to play the instrument.
- 4. Use [VALUE*] to set the Reverb Send Level.
Range: 0–9
- If you press [STOP/EXIT] you will return to the Reverb Level setting (the display will indicate "ALL").

If in step 3 you use [PAD BANK] to layer the pad banks, you can set the Reverb Send Level for instruments of both banks A and B simultaneously.

This is a convenient way to make settings for a drum kit that uses pad bank layering.

However, if different values have been set for banks A and B, using [VALUE*] will adjust the values while preserving their proportion.

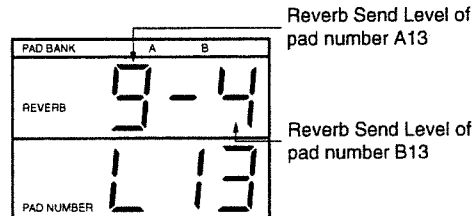

Adjusting the Flanger Depth

1. After selecting a drum kit, press [REV/FLANG] several times to make "FLANGER" blink.
2. Use [VALUE*] to adjust the Flanger Level (the overall flanger depth for the entire drum kit).
Range: 0–9

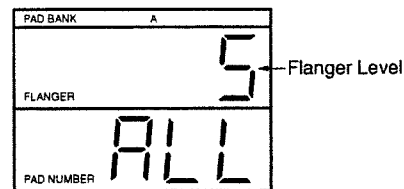

NOTE

If the Flanger Level is "0," no flanger effect will be heard even if the Flanger Send Level (see below) is raised.

3. Press the pad for the instrument whose Flanger Send Level you want to set.
If necessary, use [PAD BANK] to switch the pad bank.
The display will indicate the pad number and the current Flanger Send Level.

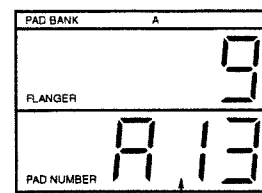

Pad number where the Flanger Send Level should be set

- If you wish to set the Flanger Send Level for the instruments of pad numbers 33 (-01)–55 (-23), use the following procedure to select the pad number.
 - 1) Press [ENTER].
 - 2) Use [◀] [▶]] to select the pad number.
 At this time, you can press [ENTER] to play the instrument.
- 4. Use [VALUE*] to adjust the Flanger Send Level. Range: 0–9
- By pressing [STOP/EXIT] you can return to the Flanger Level setting (the display will indicate "ALL").

If in step 3 you use [PAD BANK] to layer the pad banks, you can set the Flanger Send Level for instruments of both banks A and B simultaneously. This is a convenient way to make settings for a drum kit that uses pad bank layering. However, if different values have been set for banks A and B, using [VALUE*] will adjust the values while preserving their proportion.

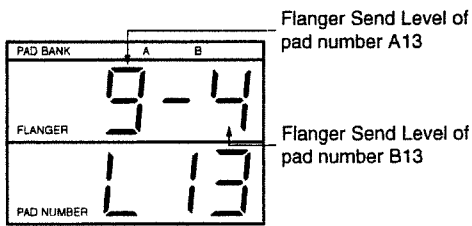

Routing Sound to the Individual Output

For each instrument of a drum kit, you can specify whether the sound will be sent from the individual output.

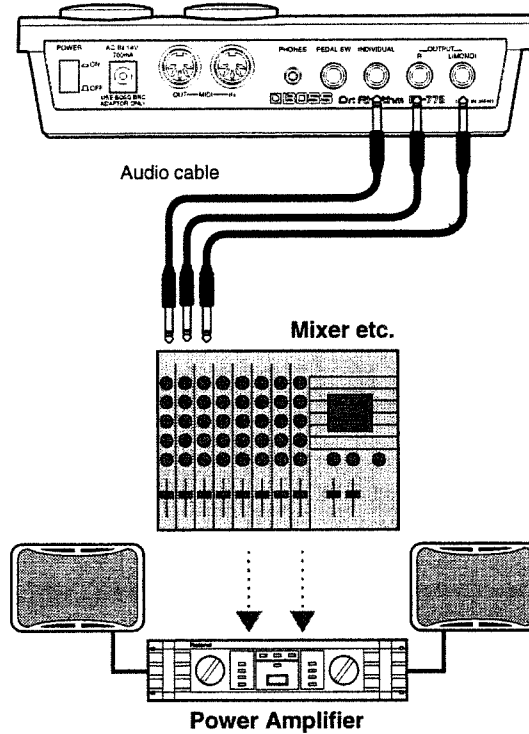

MEMO

Effects (reverb/flanger/equalizer) will not be applied to the sound that is sent from the individual output. Nor is it possible to adjust the output level (volume).

NOTE

Instruments that are sent from the individual output will not be output from the stereo outputs.

NOTE

When you use the individual output, reverb will not be applied to the sound from the stereo outputs either.

NOTE

The Ambience cannot be used for the drum kit where the individual has been set.

1. After selecting a drum kit, press [PAD] so the display indicates "PAD."
The DR-770 is now in Pad mode.
2. Use [◀] [▶] to select "6 PAN."

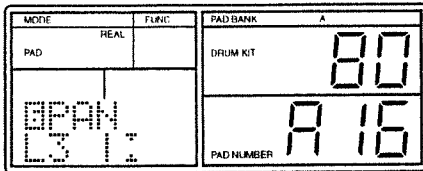

3. Press [PAD BANK] to select the desired pad bank.

NOTE

If the pad banks are layered, the display will blink "LAYER." In this state it is not possible to set the pan.

4. Press the pad for the instrument that you want to send from the individual output.
 - To select instruments of pad numbers 33 (-01)–55 (-23), use the following procedure to select the pad number.
 - 1) Press [ENTER].
 - 2) Use [◀] [▶] to select the pad number.
 When you wish to resume using the pads to select instruments, press [STOP/EXIT].
5. Use [DEC] [INC] or [VALUE] to select "INDIV."
 - If a pad number 33(-01)–55(-23) is selected, you can press [ENTER] to play the instrument.
6. Repeat steps 3–5 as many times as necessary.
7. To end the procedure after selecting "INDIV" for instruments of pad numbers 33 (-01)–55 (-23), press [STOP/EXIT].

Adjusting the Output Level

The volume (level) that will be output from the individual output can be specified independently for each instrument.

1. Press [REV/FLANG].
Either "IND" or "REVERB" will blink.
2. Use [◀] [▶] to make "IND" blink.
3. Press a pad whose instrument is being sent from the individual output.
As necessary, use [PAD BANK] to switch the pad bank.

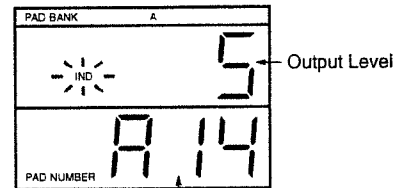

Pad number where the Output Level should be set

- To send instruments of pad numbers 33 (-01)–55 (-23) from the individual output, use the following procedure to select the pad number.
 - 1) Press [ENTER].
 - 2) Use [◀] [▶] to select the pad number.
 At this time, you can press [ENTER] to play the instrument.
When you wish to resume using the pads to select instruments, press [STOP/EXIT].
- 4. Use [VALUE*] to set the output level.
Range: 0–9
- 5. Repeat steps 3–4 as many times as necessary.

If in step 4 you use [PAD BANK] to layer the pad banks, you can adjust the output level for instruments of both banks A and B simultaneously.

This is a convenient way to make settings for a drum kit that uses pad bank layering.

However, if different values have been set for banks A and B, using [VALUE*] will adjust the values while preserving their proportion.

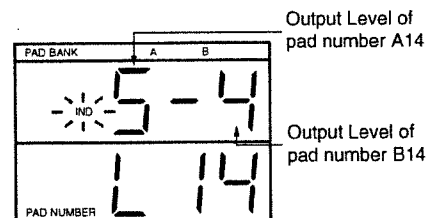

Copying a Drum Kit

You can copy a drum kit to another user drum kit (numbers 65–128).

The following settings will be copied.

● Reverb/Flanger

Reverb Level, Flanger Level
Reverb Send Level, Flanger Send Level

● Instrument settings

Instrument Assign, Level, Pitch, Decay, Nuance, Pan, Assign Type, Sensitivity Curve

● Effect settings

Reverb Type, Reverb Time, Reverb Low Pass Filter, Delay Feedback, Flanger Type, Flanger Depth, Flanger Rate, Flanger Feedback, Flanger Delay, Equalizer High Gain, Equalizer Low Gain

● Pad Bank Layer

● Note Number Assign (P.87)

● Drum Kit Name

1. Press [DRUM KIT] to make "DRUM KIT" blink.
2. Use [VALUE*] to select the copy source drum kit.
3. Press [COPY]. (The display will indicate "COPY.")
4. Use [VALUE*] to select the copy destination user drum kit.

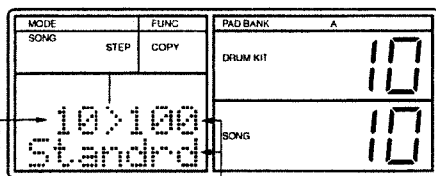

Source Drum Kit

Destination Drum Kit
(number / name)

NOTE

It is not possible to select a preset drum kit (numbers 1–64).

5. Press [ENTER].

The display will ask "Sure?," allowing you to confirm whether you want to copy the data.

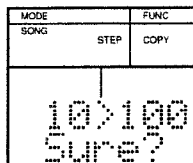

6. To copy the data, press [ENTER].

The drum kit will be copied, and the display will indicate "Done."

To cancel the operation, press [STOP/EXIT].

The drum kit copy operation will be canceled, and the display will indicate "Aborted."



If you have selected an ambience type by pressing [AMBIENCE] when a preset drum kit is being selected:

Taking steps 3–6 will copy both setting of the preset drum kit and the setting of the ambience selected right before [COPY] was pressed into the user drum kit.

Chapter 9. Connecting External MIDI Devices

What Is MIDI?

MIDI (Musical Instrument Digital Interface) is an international standard which provides for the exchange of music data among electronic musical instruments and computers. Devices that have MIDI connectors can be connected via MIDI cable and used to transmit and receive data.

MIDI Connectors

The DR-770 has a MIDI IN connector and a MIDI OUT connector.

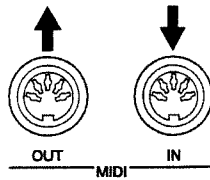

MIDI In

This connector receives data from an external MIDI device. Connect it to the MIDI OUT connector of the external MIDI device.

MIDI Out

This connector transmits data from the DR-770. Connect it to the MIDI IN connector of the external MIDI device. If the "MIDI Thru Switch" (MIDI mode setting; p. 88) is turned ON, data received at MIDI IN will be re-transmitted without change from MIDI OUT.

MIDI Channels

MIDI uses the concept of MIDI channels (channels 1–16), which are somewhat analogous to television channels. Data is received only if the MIDI channel of the receiving device matches the MIDI channel on which the data is being transmitted.

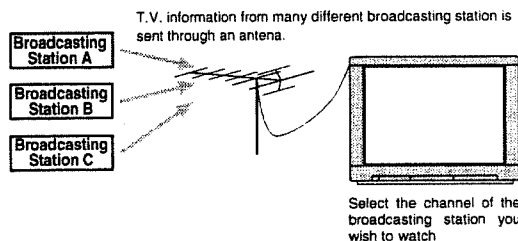

If MIDI channels are set as shown below, only sound module B will produce sound when the keyboard is played.

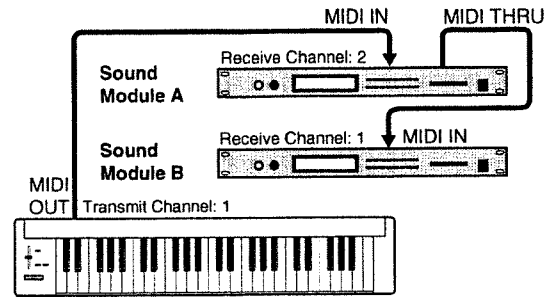

MIDI Messages Used by the DR-770

MIDI uses many different types of messages to convey a wide range of musical information. MIDI messages can be classified broadly into messages that are handled separately for each MIDI channel ("channel messages"), and messages that are handled without regard to the MIDI channel ("system messages").

Messages Handled Separately for Each MIDI Channel (Channel Messages)

These messages are used to convey musical performance actions.

Note Messages

The DR-770 uses these messages to convey drum performance information. On a keyboard instrument, they convey information about which notes are played. Note messages include the following information.

- Note Number:** Data that specifies the instrument (the number of the pad to which the instrument is assigned)
- Note On:** A pad is struck
- Note Off:** A pad is released
- Velocity:** The force with which the pad was struck

The note number is a value from 0 through 127, and middle C (C4) is 60. On the DR-770, a different note number is assigned to each instrument of a drum kit.

This means that each note number will play a different instrument.

NOTE

The DR-770 uses note numbers 27–81.

Program Change Messages

The DR-770 uses these messages to switch drum kits.

Control Change Messages

These messages can be used to control the overall volume of the DR-770.

Messages That Are Handled Without Regard to MIDI Channel (System Messages)

System messages include exclusive data, synchronization data, and messages used to prevent problems in the system.

System Exclusive Messages

These messages are used to transmit DR-770 patterns or drum kit settings to another DR-770 or external sequencer for storage.

Common Messages

This category of messages includes the Song Select message used to select songs, and the Song Position Pointer message used to specify a location within a song.

Realtime Messages

These messages are used for synchronization. They include Clock messages used to synchronize the tempo, Start and Stop messages to start/stop playback, and Continue (which re-starts playback from where it was last stopped). Active Sensing messages are used to prevent “stuck” notes on an external MIDI sound module in the event that a MIDI cable is accidentally disconnected.

About the MIDI Implementation Chart

Not all MIDI devices are able to send and receive all types of MIDI message. In order for a particular type of MIDI message to be conveyed between two MIDI devices, both MIDI devices must be capable of using that message. For this reason, the owner’s manual of every MIDI device includes a MIDI implementation chart, which provides a way to quickly tell which MIDI messages can be conveyed between any two devices. By comparing the MIDI implementation charts of two devices, you can verify the messages that they can exchange.

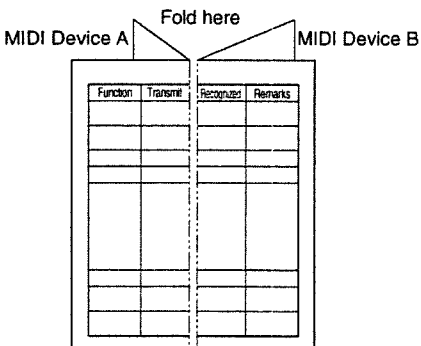

Using an External MIDI Device to Play the DR-770 / Using the DR-770 to Play an External MIDI Device

Musical data sent from an external MIDI device can be used to play the DR-770. Similarly, you can operate the DR-770 to play sounds on an external MIDI device.

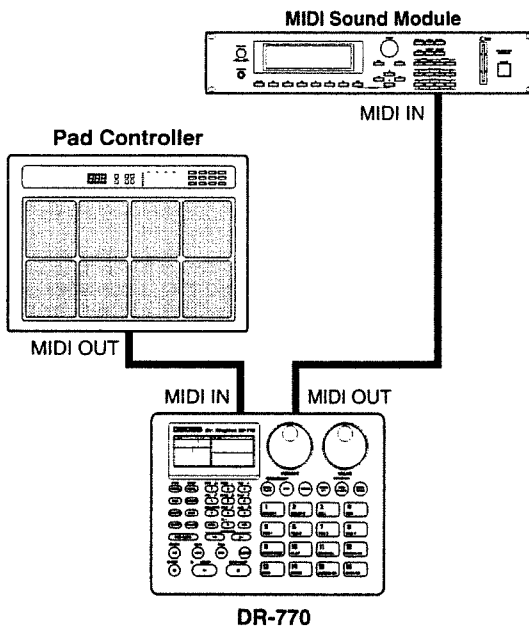

MIDI Channel Setting

You must set the MIDI channel of the DR-770 so that it will be able to transmit and receive MIDI messages to and from the external MIDI device.

1. Press [MIDI] so the display indicates “MIDI.”
The DR-770 is now in MIDI mode.
2. Use [◀][▶] to select “2 MIDIch.”

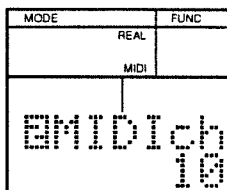

3. Use [VALUE*] to set the MIDI channel.
Set this to the same channel as the MIDI device that you have connected.
Range: 1-16

Settings for Playing the DR-770 Instruments

If you wish to play the DR-770's instruments from an external MIDI device, you must specify the instrument that will be played by each incoming note number. You can specify a note number for each instrument of the drum kit.

NOTE

The preset drum kits (1–64) can be modified temporarily, but they will return to their original settings when you select another drum kit.

1. Press [DRUM KIT] to make "DRUM KIT" blink.
2. Use [VALUE*] to select the user drum kit for which you will specify note numbers.
3. After selecting the drum kit, press [DRUM KIT] once again.
4. Press [MIDI] to make "MIDI" light.
5. Use [◀] [▶] to select "1 NOTE#."
6. Press [ENTER].

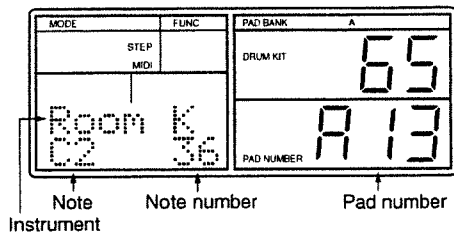

7. Press the pad for the instrument whose note number you want to set.
As necessary, use [PAD BANK] to switch the pad bank.
- To specify note numbers for the instruments of pad numbers 33 (-01)–55 (-23), use [◀] [▶] to select the pad number.
8. Use [VALUE*] to specify the note number.
Range: 27–81
9. Repeat steps 7–8 as many times as necessary.
10. To end the procedure, press [STOP/EXIT].

NOTE

Even if you specify the same note number for two or more instruments, only one of them will sound. In this case, the instruments of pad bank A will take priority, and the instrument assigned to the lowest-numbered pad will sound.

NOTE

When the pads of the DR-770 are struck, the note numbers you specify here will be transmitted. However, it is not possible to transmit note numbers for the instruments of pad numbers 33 (-01)–55 (-23).

Other MIDI Settings

These settings specify how the DR-770 will handle MIDI messages.

1. Press [MIDI] to make "MIDI" light.
The DR-770 is now in MIDI mode.
2. Use [◀] [▶] to select the item (parameter) that you want to set.

4 PRG (program change switch)

Range: ON/OFF

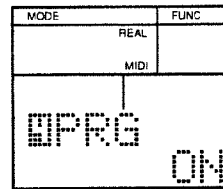

5 RxVOL (volume receive switch)

Range: 0–127, ON/OFF

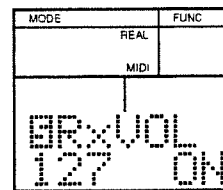

MIDI Volume

6 RxEXPR (expression receive switch)

Range: ON/OFF

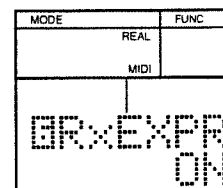

7 RxEXC (exclusive receive switch)

Range: ON/OFF

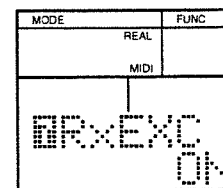

8 THRU (MIDI thru switch)

Range: ON/OFF

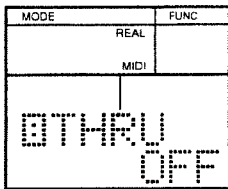

3. Use [DEC] [INC] or [VALUE] to turn each parameter ON/OFF.

Functions of Each Parameter

4 PRG (program change switch)

This specifies whether or not program change messages will be transmitted and received. If this is turned ON, an incoming program change message will switch the drum kit, and when a drum kit is selected on the DR-770, a program change message will be transmitted.

Program numbers 1-128 correspond to drum kit numbers 1-128.

5 RxVOL (volume receive switch)

This specifies whether or not volume messages will be received. If this is ON, incoming volume messages will control the overall volume of the DR-770, and the value of the received MIDI volume message will be displayed. You can use [◀] [▶] to make the value blink, and then use [VALUE*] to modify the MIDI volume value, and the MIDI volume of the edited value will be transmitted through MIDI OUT.

6 RxEXPR (expression receive switch)

This specifies whether or not expression messages will be received. If this is ON, incoming expression messages will modify the overall volume of the DR-770. The expression value is not remembered, and will be reset to the maximum value when the power is turned on.

7 RxEXC (exclusive receive switch)

This specifies whether or not exclusive messages will be received. If this is ON, exclusive messages will be received.

8 THRU (MIDI thru switch)

This specifies whether or not messages received at MIDI IN will be re-transmitted without change from MIDI OUT. If this is ON, messages received at MIDI IN will be re-transmitted without change from MIDI OUT, but musical data produced by the DR-770 itself will no longer be transmitted from MIDI OUT. If this is OFF, messages received at MIDI IN will not be re-transmitted from MIDI OUT.

NOTE

During a Bulk Dump (p. 89), the Thru setting will be temporarily switched off even if this setting has been set to ON.

Synchronized Playback

External MIDI devices, such as another rhythm machine or sequencer, can play back in synchronization with the DR-770.

- If the DR-770 is to play back in synchronization with the tempo and start/stop operations of the external MIDI device, the external MIDI device will be the master and the DR-770 will be the slave.

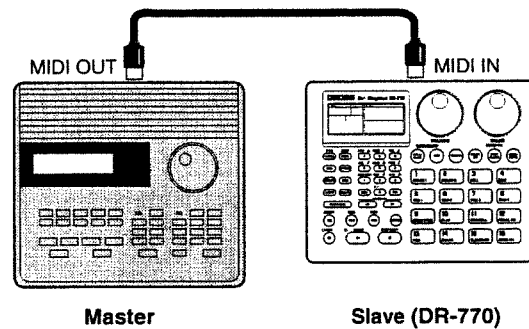

If the master device is able to transmit Song Select or Song Position Pointer messages, the song number and song playback location specified on the master device will also be specified for the DR-770.

- If the external MIDI device is to play back in synchronization with the tempo and start/stop operations of the DR-770, the DR-770 will be the master and the external MIDI device will be the slave.

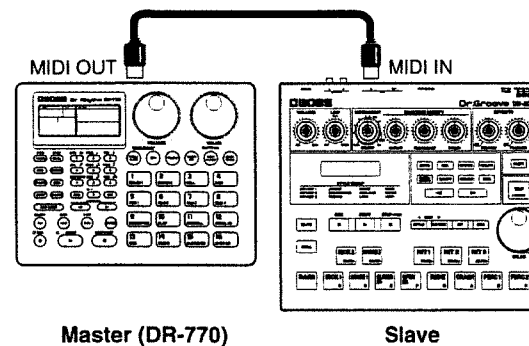

If the slave device is able to receive Song Select and Song Position Pointer messages, the song number and song playback location that are specified on the DR-770 will also be specified on the slave device.

To perform synchronized playback, make the following settings.

NOTE

Operate the other device as described in its owner's manual.

1. Press [MIDI] to make "MIDI" light.
The DR-770 is now in MIDI mode.
2. Use [◀] [▶] to select "2 MIDIch."
3. Use [VALUE*] to set the MIDI channel.
Set this to the same channel as the other MIDI device.
Range: 1–16
4. Use [◀] [▶] to select "3 SYNC."

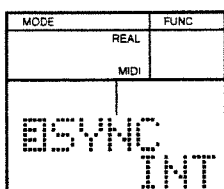

5. Use [DEC] [INC] or [VALUE] to set the sync mode.
 - INT: Select this for the DR-770 to be the master. The external MIDI device will synchronize to the tempo of the DR-770.
 - MIDI: Select this for the DR-770 to be the slave. The DR-770 will synchronize to the MIDI Clock messages from the external MIDI device.

NOTE

The sync mode setting is not memorized. The unit will be always set to "INT" when switched on.

About the Tempo Display

If the sync mode is set to "MIDI," the tempo display will appear as follows, and it will not be possible to control the tempo on the DR-770.

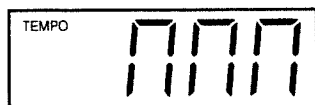

In this case if you press [START] when no timing clock messages are being transmitted from the external device, the tempo display will continue to indicate "Playing," but playback will not start until timing clock messages begin to arrive.

Transmitting DR-770 Data (Bulk Dump)

DR-770 data can be transmitted to a sequencer or to another DR-770. This process is called Bulk Dump.

The data is transmitted in the form of exclusive messages.

Connections

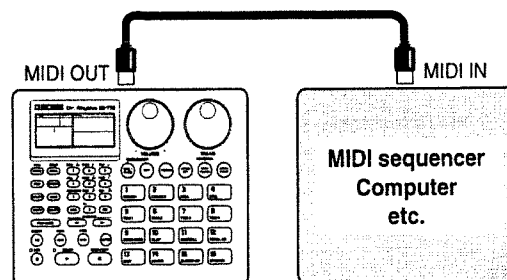

Transmit device (DR-770)

Receive device

Procedure

1. Press [MIDI] to make "MIDI" light.
The DR-770 is now in MIDI mode.
2. Use [◀] [▶] to select "9 BULK."

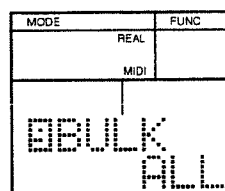

Data to be transferred

3. Use [DEC] [INC] or [VALUE] to select the type of data that will be transmitted.
 - ALL: All data of the DR-770
 - SEQ: All patterns and songs
 - GLOBAL: DPP/roll/metronome/MIDI settings
 - DRMKITS: All user drum kits
 - 1DRMKIT: A specified individual drum kit (If this data is transmitted to the DR-770, the drum kit that is currently selected on the receiving device will change to the drum kit settings that were received.)
4. Press [ENTER].
The display will ask "Sure?," allowing you to confirm whether you really want to execute the bulk dump.



- If you selected "1DRMKIT," use [DEC] [INC] or [VALUE] to select the drum kit whose data you want to transmit.
5. To execute the bulk dump, press [ENTER].
 The display will indicate "Trnsmit" (transmitting) → "Done," and the bulk dump will be completed.
 If you decide to cancel, press [STOP/EXIT].
 The bulk dump will be canceled, and the display will indicate "Aborted."

NOTE

If you select "ALL" and execute the Bulk Dump, the memory on the receive device will be full before the Bulk Dump is completed, not being able to receive any more data.
 If this happens, change the data to be transferd to "SEQ," "GLOBAL," "DRMKITS," or "1DRMKIT," then execute the Bulk Dump again.

Restoring the Transmitted Data Back to the DR-770

Here's how data that was previously saved on a sequencer can be transmitted back to the DR-770, or how data transmitted from one DR-770 can be received by another DR-770.

Connections

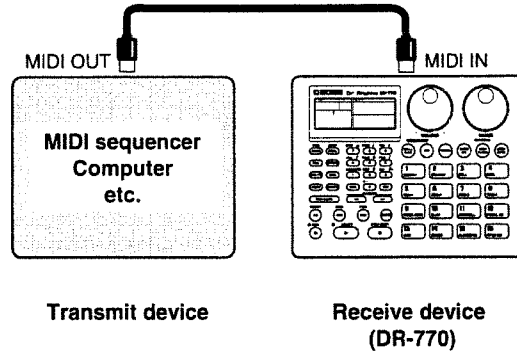

Connections

1. Press [MIDI] to make "MIDI" light.
 The DR-770 is now in MIDI mode.
 2. Use [◀] [▶] to select "2 MIDIch."
 3. Use [VALUE*] to set the MIDI channel.
- If you want to restore data that was formerly transmitted to a sequencer, set the unit to the same MIDI channel that was used when transmitting the data.
 - If you want to receive data that is being transmitted from another DR-770, set both DR-770 units to the same MIDI channel.
4. Use [◀] [▶] to select "7 RxEXC."

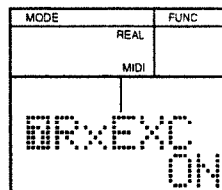

5. Use [DEC] [INC] or [VALUE] to turn the setting "ON."
 With playback stopped on the DR-770, receive the data.

Chapter 10. Restoring the Factory Settings (Factory Reset)

The DR-770 can be returned to the factory settings.
This operation is called Factory Reset. "

1. Press [UTILITY] so the display indicates "UTILITY."
The DR-770 is now in Utility mode.
2. Use [◀][▶] to select "9 F.RST."

MODE	REAL	FUNC
UTILITY		

9 F.RST
ALL

3. Use [INC] [DEC] or [VALUE] to select the data that will be restored to the factory settings.

ALL: All patterns/songs will be erased. (Other settings will be returned to the factory settings.)

SONG: All songs will be erased.

PATTERN: All patterns will be erased. (Drum kit settings will be returned to the factory settings.)

DRUMKIT: All drum kits will be returned to the factory settings.

EFFECT: The effect settings of the currently selected drum kit will be returned to the factory settings.

4. Press [ENTER].

The display will ask "Sure?," allowing you to confirm whether you want to execute the Factory Reset operation.

MODE	REAL	FUNC
UTILITY		

9 F.RST
SURE?

5. To execute, press [ENTER].

The Factory Reset operation will be completed, and the display will indicate "Done."

To cancel, press [STOP/EXIT].

The Factory Reset operation will be canceled, and the display will indicate "Aborted."

Error Messages

If you attempt an incorrect operation or if an operation could not be executed, the display will indicate an error message. Refer to this list and take the appropriate action.

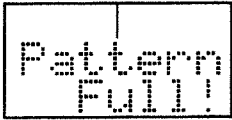

- No more patterns can be recorded.
- Press [STOP/EXIT]. If you want to continue recording patterns, you must first delete unneeded patterns. (p. 62)



- No more songs can be recorded.
- Press [STOP/EXIT]. If you want to continue recording songs, you must first delete unneeded songs. (p. 67)

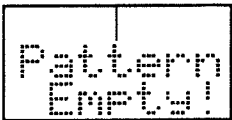

- During pattern editing, using "Copy Pattern" or "Delete Pattern," the selected pattern contained no data.
- Press [STOP/EXIT], then select a different pattern.

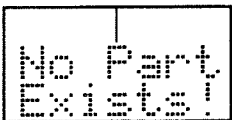

- During song editing, using "Insert Pattern" or "Delete Pattern," the selected pattern contained no data.
- Press [STOP/EXIT], then select a different part.

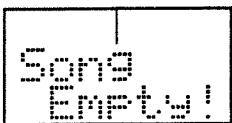

- During song editing, using "Copy Song" or "Delete Song," the selected song contained no data.
- Press [STOP/EXIT], then select a different song.

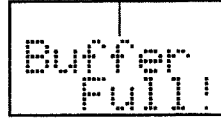

- An excessive amount of MIDI data was received all at once, and the DR-770 was unable to process it.
Press [STOP/EXIT],
- If this message appears while receiving data, reduce the amount of MIDI data that is being transmitted to the DR-770.
- Change the MIDI mode setting so unnecessary MIDI messages are not transmitted or received. (p. 87)



- An exclusive message could not be received correctly.
- Press [STOP/EXIT], then try the operation once again.



- The memory backup battery inside the DR-770 has run down. (This message will appear when the power is turned on.)
- Replace the battery as soon as possible. For battery replacement, please contact a Roland Service Center.

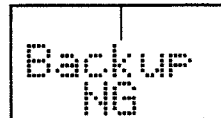

- The data in internal memory has been lost. (This message will appear when the power is turned on.)
- After this message is shown, "Press ENTER" appears, then pressing [ENTER] will recall the factory settings.

Troubleshooting

No sound

- Is the [VOLUME] turned down to the minimum position? (p. 14)
- Is the instrument level set to "0"? (p. 72)
- Have you selected a pattern or song that contains no musical data?
- Is the Pan parameter set to "INDIV"? (p. 74)

Notes are interrupted

- Are you attempting to play more than 14 notes simultaneously?
The DR-770 is able to play up to 14 notes (voices) simultaneously.
- Is the Assign Type setting correct? (p.75)

Can't play a roll or flam

- Is the roll type set to "FL"? (p. 47)
- Are the Flam Interval and Flam Ratio set correctly? (p. 47)

Playback doesn't begin when you press [START]

- Has the Sync Mode been set to "MIDI"? (p. 89)
- Have you selected a pattern or song that contains no musical data?

Can't use quick search

- Are you in pattern / song record mode (REC indicator lit)?

(When recording a pattern) The REC indicator does not light even by pressing [REC]

- Have you selected a Preset Pattern (1–400)? (p. 53, 57)

Metronome does not sound

- Is the metronome level set to "0"? (p. 56)

Can't realtime-record a song

- Have you selected an already recorded song? (p. 63)

The modified settings of the Drum Kit is returned as previously set

- Have you selected a Preset Drum Kit (1–64)? (p. 71)

Can't apply reverb/flanger

- Have you made settings to send the sound from the individual output? (p. 82)
- Is the Reverb/Flanger Level set to "0"? (p. 81)
- Is the Reverb/Flanger Send Level set to "0"? (p. 81)

Can't play the DR-770 from an external MIDI device

Can't play an external MIDI device from the DR-770

- Is the MIDI channel setting correct? (p. 86)
- Is the Note number setting correct? (p. 87)

Parameter List

[SONG/PTN] (Pattern)

--	Pattern Name	Maximum 7 characters
--	Realtime Pattern Change	OFF / ON, Variation (VAR), Fill-in to Variation (FTV), Fill-in to Original (FTO),

[SONG/PTN] (Song)

--	Song Name	Maximum 7 characters
CHAIN	Song Chain	1-100 / OFF
INT	Initial Tempo	20-260 / OFF
KIT	Drum Kit Change	OFF / ON

[PAD]

KITNAM	Drum Kit Name	Maximum 7 characters
ASSIGN	Instrument Assign	refer to the Instrument List (p. 96)
LEVEL	Instrument Level	0-15
PITCH	Instrument Pitch	-2400- ±0- +2400
DECAY	Instrument Decay	-31- ±0- +31
NUANCE	Instrument Nuance	-7- ±0- +7
PAN	Instrument Pan	L7-C-R7, INDIV
A.TYPE	Instrument Assign Type	POLY, POLY EXC1-7, MONO, MONO EXC1-7
CRV	Sensitivity Curve	EXP1, LIN1, EXP2, LIN2, XFDO, XFDI, FIX1, FIX2

[EFFECTS]

R.TYPE	Reverb Type	HALL, ROOM, PLATE, DELAY, PAN-DLY
R.TIME	Reverb Time	0-31
R.LPF	Reverb Low Pass Filter	0-7
D.FDBK	Dalay Feedback	0-15
F.TYPE	Flanger Type	CHORUS, FLANGER
F.DPTH	Flanger Depth	0-15
F.RATE	Flanger Rate	0-15
F.FDBK	Flanger Feedback	0-15
F.DLY	Flanger Delay	0-31
EQ HIGH	Equalizer High Gain	-12- ±0- +12 dB
EQ LOW	Equalizer Low Gain	-12- ±0- +12 dB

[UTILITY]

ROLL TYPE	Roll Type	32nd note, 16th note triplets, 16th note, 8th note triplets, 8th noe, Quarter note triplets, Quarter note, Half note, FL (Flam)
FLAM INT	Flam Interval	0-31
FLAM RATIO	Flam Ratio	0-7

SWING	Swing	Quantize: 32nd note, 16th note, 8th note, Quarter note 50%, 54%, 58%, 62%, 67%, 71%, 75%, 80%
SHIFT	Timing Shift	A01–A16, B01–B16, -01– -23; -96– ±0– +96
CLICK LEVEL	Metronome Click Level	0–7
CLICK SEL	Metronome Click select	16th note, 8th note triplets, 8th note, Quarter note triplets, Quarter note
FOOT 2	Foot Switch 2 Assign	CHASE, FWD, RWD, RESET, REC, PAD1–16
F.RST	Factory Reset	ALL, SONG, PATTERN, DRUMKIT, EFFECT

[MIDI]

NOTE #	Note Number Assign	27–81
MIDIch	MIDI Channel	1–16
SYNC	Synchro Mode	INT, MIDI
PRG	Program Change Switch	OFF / ON
RxVOL	Volume Receive Switch	0–127, OFF / ON
RxEXPR	Expression Receive Switch	OFF / ON
RxEXC	Exclusive Receive Switch	OFF / ON
THRU	MIDI Thru Switch	OFF / ON
BULK	Bulk Dump	ALL, SEQ, GLOBAL, DRMKITS, 1DRMKIT

[QUICK SEARCH]

SEARCH	Category	HD ROCK, ROCK, POP, FUNK&BLS, JAZZ, DANCE, LATIN, WORLD, USER 1–USER25
--------	----------	--

[TEMPO]

TEMPO	Standard Tempo	20–260
-------	----------------	--------

[DRUM KIT]

DRUM KIT	Drum Kit	1–128
----------	----------	-------

[REV/FLANG] (Reverb/Flanger)

REVERB	Reverb Level	0–9
	reverb Send Level	0–9
FLANGER	Flanger Level	0–9
	Flanger Send Level	0–9
IND	Individual Output Level	0–9

[AMBIENCE]

AMBI	Ambience Type	LoBoost, Flang'n, Bright, Hi-Fi, Dark, Lo-Fi, Room, Studio, Garage, Club, Hall, Stadium, Space, Echo, Dublin, Flat
------	---------------	--

Instrument List

No.	Display	Instrument Name
* 1	AttckK	attack kick
2	RIDryK	real dry kick
* 3	Dry K	dry kick
* 4	DryMdK	dry medium kick
* 5	DryHdK	dry hard kick
* 6	HeavyK	heavy kick
* 7	PillwK	pillow kick
* 8	VntgK1	vintage kick 1
* 9	VntgK2	vintage kick 2
* 10	JazzK1	jazz kick 1
* 11	JazzK2	jazz kick 2
* 12	MapleK	maple kick
* 13	MpPlwK	maple pillow kick
* 14	MpRvbK	maple reverb kick
* 15	Real K	real kick
* 16	26DepK	26" deep kick
17	Mid K1	medium kick 1
* 18	Mid K2	medium kick 2
* 19	BigLoK	big low kick
* 20	WdBtrK	wood beater kick
* 21	HbrdK1	hybrid kick 1
22	HbrdK2	hybrid kick 2
* 23	AmbntK	ambient kick
24	BoomrK	boomer kick
25	CompK1	comp kick 1
26	CompK2	comp kick 2
* 27	Deep K	deep kick
28	RvrBk1	reverb kick 1
* 29	RvrBk2	reverb kick 2
* 30	Room K	room kick
* 31	DpRomK	deep room kick
* 32	MdVrbK	mondo reverb kick
* 33	MonDpK	mondo deep kick
* 34	Easy K	easy kick
* 35	Soft K	soft acoustic kick
* 36	SolidK	solid kick
* 37	ElecK1	electronic kick 1
* 38	ElecK2	electronic kick 2
* 39	HouseK	house kick
* 40	DanceK	dance kick
* 41	Rap K1	rap kick 1
* 42	Rap K2	rap kick 2
43	PlstcK	plastic kick
* 44	GubbaK	gubba kick
45	JngleK	jungle kick
* 46	808 K1	TR-808 kick 1
* 47	808 K2	TR-808 kick 2

No.	Display	Instrument Name
* 48	808EIK	808 electronic kick
* 49	808BmK	808 boom kick
* 50	909 K1	TR-909 kick 1
51	909 K2	TR-909 kick 2
* 52	909HdK	909 hard kick
* 53	Mid SS	medium snare soft
* 54	Mid SR	medium snare rim shot
* 55	Stl SH	steel snare hard
* 56	Stl SR	steel snare rim shot
* 57	BechSS	beech snare soft
* 58	BechSR	beech snare rim shot
* 59	PiccSS	piccolo snare soft
* 60	PiccSH	piccolo snare Hard
* 61	HiPicS	high piccolo snare
* 62	OpnRmS	open rim shot snare
* 63	SlDrSS	slam dry snare soft
*** 64	SlDrSH	slam dry snare hard
*** 65	SlRmSS	slam room snare soft
*** 66	SlRmSH	slam room snare hard
*** 67	DryHdS	dry hard snare
*** 68	RngHdS	ring hard snare
*** 69	RckOnS	rock-on snare
*** 70	Funk S	funk snare
71	SharpS	sharp snare
*** 72	WrmHdS	warm hard snare
73	DrFatS	dry fat snare
74	SnapyS	snappy snare
75	Dry SS	dry snare soft
76	Dry SH	dry snare hard
*** 77	Wet S	wet snare
* 78	LAFatS	L.A.fat snare
* 79	AcRimS	acoustic rim shot snare
* 80	AmbntS	ambient snare
* 81	AttckS	attack snare
* 82	BgShtS	big shot snare
* 83	Hall S	hall snare
* 84	Hard S	hard snare
* 85	LtMplS	light maple snare
* 86	LooseS	loose snare
87	NatrIS	natural snare
88	PowerS	power snare
* 89	RocknS	rockin' snare
* 90	RckRmS	rock rim shot snare
* 91	Real S	real snare
*** 92	RockS1	rock snare 1
* 93	RockS2	rock snare 2
* 94	RngMpS	ring maple snare

No.	Display	Instrument Name
95	BrRIS1	brush roll snare 1
* 96	BrRIS2	brush roll snare 2
* 97	BrSIS1	brush slap snare 1
* 98	BrSIS2	brush slap snare 2
* 99	BrSIS3	brush slap snare 3
* 100	BrSwiS	brush swish snare
* 101	RegaeS	reggae snare
* 102	SwingS	swing snare
* 103	90's S	90's snare
* 104	DanceS	dance snare
* 105	DopinS	dopin' snare
* 106	HouseS	house snare
* 107	HsDpnS	house dopin' snare
108	JgTnyS	jungle tiny snare
* 109	ElecS1	electronic snare 1
* 110	ElecS2	electronic snare 2
* 111	808 S1	TR-808 snare 1
112	808 S2	TR-808 snare 2
* 113	TR909S	TR-909 snare
114	AmbStk	ambient cross stick
*** 115	HalStk	hall cross stick
116	NatStk	natural cross stick
117	MtlStk	metal cross stick
118	808Stk	TR-808 cross stick
119	909Stk	TR-909 cross stick
* 120	StdT1S	studio tom 1 soft
* 121	StdT1H	studio tom 1 hard
* 122	StdT2S	studio tom 2 soft
* 123	StdT2H	studio tom 2 hard
* 124	VintT1	vintage tom 1
* 125	VintT2	vintage tom 2
* 126	JazzT1	jazz tom 1
* 127	JazzT2	jazz tom 2
* 128	FuseT1	fusion tom 1
* 129	FuseT2	fusion tom 2
* 130	BowlT1	bowl tom 1
* 131	BowlT2	bowl tom 2
* 132	AmboT1	ambient tom 1
* 133	AmboT2	ambient tom 2
* 134	BrshT1	brush slap tom 1
* 135	BrshT2	brush slap tom 2
* 136	DbHdT1	double head tom 1
* 137	DbHdT2	double head tom 2
* 138	LiteT1	light tom 1
* 139	LiteT2	light tom 2
* 140	RealT1	real tom 1
* 141	RealT2	real tom 2

No.	Display	Instrument Name	No.	Display	Instrument Name	No.	Display	Instrument Name
* 142	RingT1	ring tom1	189	Tambrn	tambourine	** 236	HiQ	high-Q
* 143	RingT2	ring tom2	190	SlBell	sleigh bell	237	TapRwd	tape rewind
* 144	RoomT1	room tom 1	191	Casta	castanet	238	PhilHt	philly hit
* 145	RoomT2	room tom 2	192	Triang	triangle open	239	DncShk	dance shaker
* 146	RockT1	rock tom 1	193	Wodblk	woodblock	** 240	BeamHQ	beam high-Q
* 147	RockT2	rock tom 2	* 194	BongoH	bongo high	241	MISwp	metal sweep
* 148	ElecT1	electronic tom 1	* 195	BongoL	bongo low	** 242	AngBrd	analog bird
* 149	ElecT2	electronic tom 2	* 196	CngHMt	conga high mute	** 243	RevKik	reverse kick
* 150	808Tom	TR-808 tom	* 197	CngSlp	conga high slap	** 244	RevSnr	reverse snare
* 151	909Tom	TR-909 tom	* 198	CngHOp	conga high open	** 245	RevTom	reverse tom
** 152	PureCH	pure closed hi-hat	* 199	CngLOp	conga low open	246	RevCym	reverse cymbal
** 153	PureOH	pure open hi-hat	* 200	TmbIHl	timbale high	*** 247	KikAmb	kick ambience
** 154	PedIHH	pedal closed hi-hat	* 201	TmbILO	timbale low	*** 248	SnrAmb	snare ambience
** 155	16 CHH	16" closed hi-hat	202	TmbISd	timbale side	*** 249	TomAmb	tom ambience
** 156	16HFOH	16" half open hi-hat	* 203	Claves	claves	*** 250	LngVrb	long reverb
157	16 OHH	16" open hi-hat	204	Vibslp	vibraslap	*** 251	GatVrb	gate reverb
158	16PdHH	16" pedal closed hi-hat	205	GuiroS	guiro short	* 252	AcouBs	acoustic bass
** 159	PopCHH	pop closed hi-hat	206	GuiroL	guiro long	253	FingBs	fingered bass
** 160	PopOHH	pop open hi-hat	207	Marcas	maracas	254	SlapBs	slap bass
** 161	RealCH	real closed hi-hat	208	Shaker	shaker	255	303 Bs	TB-303 bass
** 162	RealOH	real open hi-hat	209	Cabasa	cabasa	256	Off	Off
163	BrsCHH	brush closed hi-hat	210	WhisLS	samba whistle short			
164	BrsOHH	brush open hi-hat	211	WhisL	samba whistle long			
** 165	808CHH	TR-808 closed hi-hat	** 212	Agogo	agogo			
** 166	808OHH	TR-808 open hi-hat	213	CuicHi	cuica high			
167	909CHH	TR-909 closed hi-hat	214	CuicLo	cuica low			
168	909OHH	TR-909 open hi-hat	* 215	SurdMt	surdo mute			
169	78 CHH	CR-78 closed hi-hat	* 216	SurdOp	surdo open			
170	78 OHH	CR-78 open hi-hat	** 217	Tabla1	tabla 1			
171	CrshC1	crash cymbal 1	218	Tabla2	tabla 2			
172	CrshC2	crash cymbal 2	** 219	Tabla3	tabla 3			
173	CrshC3	crash cymbal 3	220	RIClap	real clap			
174	SftCrC	soft crash cymbal	221	55Clav	DR-55 claves			
** 175	PgyCrC	pgy crash cymbal	222	78Cow	CR-78 cowbell			
176	SplshC	splash cymbal	223	78Beat	CR-78 metallic beat			
177	ChinaC	chinese cymbal	224	78Guir	CR-78 guiro			
** 178	RideC1	ride cymbal 1	225	78Tamb	CR-78 tambourine			
** 179	RideC2	ride cymbal 2	226	78Marc	CR-78 maracas			
** 180	SzlRdC	sizzle ride cymbal	* 227	808Cng	TR-808 conga			
** 181	RdBIC1	ride bell cymbal 1	228	808Clv	TR-808 claves			
** 182	RdBIC2	ride bell cymbal 2	229	808Mrc	TR-808 maracas			
183	BrCrsS	brush crash cymbal	230	808Clp	TR-808 hand clap			
184	BrRidC	brush ride cymbal	231	808Cow	TR-808 cowbell			
185	LrgGng	large gong	** 232	ScrCh1	scratch 1			
186	TR808C	TR-808 cymbal	** 233	ScrCh2	scratch 2			
187	TR606C	TR-606 cymbal	** 234	ScrtSn	scratch snare			
** 188	Cowbel	cowbell	235	JnglHH	jungle hat			

* The sound will alter depending on the strength you strike the pads or the Nuance setting (p. 73).

** The sound will alter depending on the Nuance setting.

*** The Pan setting (p. 74) will be ignored (except when "INDIV").

Preset Drum Kit List

	No. 1 Standrd	No. 2 Room 1	No. 3 Power 1	No. 4 Electro1	No. 5 TR808 1	No. 6 Jazz 1	No. 7 Brushes	No. 8 Ambient
Pad No.	Note # Instrument	Note # Instrument	Note # Instrument	Note # Instrument	Note # Instrument	Note # Instrument	Note # Instrument	Note # Instrument
1 (A01)	49 171 CrshC1	49 171 CrshC1	49 171 CrshC1	49 171 CrshC1	49 186 TR808C	49 174 SftCrC	49 183 BrCrsS	49 171 CrshC1
2 (A02)	57 172 CrshC2	57 173 CrshC3	57 172 CrshC2	57 187 TR606C	57 187 TR606C	57 172 CrshC2	57 184 BrRidC	57 172 CrshC2
3 (A03)	53 182 RdBIC2	53 182 RdBIC2	53 182 RdBIC2	53 181 RdBIC1	53 182 RdBIC2	53 181 RdBIC1	53 181 RdBIC1	53 182 RdBIC2
4 (A04)	51 179 RideC2	51 179 RideC2	51 179 RideC2	51 179 RideC2	51 179 RideC2	51 180 SziRdC	51 184 BrRidC	51 178 RideC1
5 (A05)	50 120 StdT1S	50 144 RoomT1	50 132 AmboT1	50 148 ElecT1	50 150 808Tom	50 126 JazzT1	50 134 BrshT1	50 146 RockT1
6 (A06)	48 120 StdT1S	48 144 RoomT1	48 132 AmboT1	48 148 ElecT1	48 150 808Tom	48 126 JazzT1	48 134 BrshT1	48 146 RockT1
7 (A07)	45 120 StdT1S	45 144 RoomT1	45 132 AmboT1	45 148 ElecT1	45 150 808Tom	45 127 JazzT2	45 134 BrshT1	45 147 RockT2
8 (A08)	41 122 StdT2S	41 145 RoomT2	41 133 AmboT2	41 148 ElecT1	41 150 808Tom	41 127 JazzT2	41 135 BrshT2	41 147 RockT2
9 (A09)	37 116 NatStk	37 114 AmbStk	37 115 HalStk	37 119 909Stk	37 118 808Stk	37 116 NatStk	37 116 NatStk	37 114 AmbStk
10 (A10)	39 53 Mid SS	39 230 808Clp	39 230 808Clp	39 230 808Clp	39 230 808Clp	39 79 AcRimS	39 97 BrSIS1	40 84 Hard S
11 (A11)	56 188 Cowbel	56 188 Cowbel	56 188 Cowbel	56 188 Cowbel	56 231 808Cow	56 188 Cowbel	56 188 Cowbel	56 188 Cowbel
12 (A12)	44 154 PedlHH	44 154 PedlHH	44 158 16PdHH	44 165 808CHH	44 166 808OHH	44 154 PedlHH	44 154 PedlHH	44 158 16PdHH
13 (A13)	36 4 DryMdK	36 30 Room K	36 33 MonDpK	36 37 ElecK1	36 46 808 K1	36 11 JazzK2	36 10 JazzK1	36 36 SolidK
14 (A14)	38 54 Mid SR	38 89 RocknS	38 93 RockS2	38 109 ElecS1	38 111 808 S1	38 86 LooseS	38 100 BrSwiS	38 81 AttckS
15 (A15)	42 152 PureCH	42 161 RealCH	42 156 16HfOH	42 165 808CHH	42 165 808CHH	42 152 PureCH	42 163 BrsCWH	42 155 16 CHH
16 (A16)	46 153 PureOH	46 162 RealOH	46 157 16 OHH	46 166 808OHH	46 166 808OHH	46 153 PureOH	46 164 BrsOH	46 157 16 OHH
17 (B01)	69 209 Cabasa	69 209 Cabasa	69 209 Cabasa	69 209 Cabasa	69 209 Cabasa	69 209 Cabasa	69 209 Cabasa	69 256 Off
18 (B02)	75 203 Claves	75 203 Claves	75 203 Claves	75 203 Claves	75 228 808Civ	75 203 Claves	75 203 Claves	75 256 Off
19 (B03)	70 207 Marcas	70 207 Marcas	70 207 Marcas	70 207 Marcas	70 229 808Mrc	70 207 Marcas	70 207 Marcas	70 256 Off
20 (B04)	58 204 Vibslp	58 204 Vibslp	58 204 Vibslp	58 204 Vibslp	58 204 Vibslp	58 204 Vibslp	58 204 Vibslp	58 256 Off
21 (B05)	67 212 Agogo	67 212 Agogo	67 212 Agogo	67 212 Agogo	67 212 Agogo	67 212 Agogo	67 212 Agogo	67 249 TomAmb
22 (B06)	68 212 Agogo	68 212 Agogo	68 212 Agogo	68 212 Agogo	68 212 Agogo	68 212 Agogo	68 212 Agogo	68 249 TomAmb
23 (B07)	73 205 GuiroS	73 205 GuiroS	73 205 GuiroS	73 205 GuiroS	73 224 78Guir	73 205 GuiroS	73 205 GuiroS	73 249 TomAmb
24 (B08)	74 206 GuiroL	74 206 GuiroL	74 206 GuiroL	74 206 GuiroL	74 224 78Guir	74 206 GuiroL	74 206 GuiroL	74 249 TomAmb
25 (B09)	60 194 BongoH	60 194 BongoH	60 194 BongoH	60 194 BongoH	60 194 BongoH	60 194 BongoH	60 194 BongoH	60 256 Off
26 (B10)	61 195 BongoL	61 195 BongoL	61 195 BongoL	61 195 BongoL	61 195 BongoL	61 195 BongoL	61 195 BongoL	61 248 SnrAmb
27 (B11)	66 201 TmbLlo	66 201 TmbLlo	66 201 TmbLlo	66 201 TmbLlo	66 201 TmbLlo	66 201 TmbLlo	66 201 TmbLlo	66 256 Off
28 (B12)	65 200 TmbLhi	65 200 TmbLhi	65 200 TmbLhi	65 200 TmbLhi	65 200 TmbLhi	65 200 TmbLhi	65 200 TmbLhi	65 256 Off
29 (B13)	54 189 Tambn	54 189 Tambn	54 189 Tambn	54 189 Tambn	54 225 78Tamb	54 189 Tambn	54 189 Tambn	54 247 KikAmb
30 (B14)	62 196 CngHMT	62 196 CngHMT	62 196 CngHMT	62 196 CngHMT	62 227 808Cng	62 196 CngHMT	62 196 CngHMT	62 248 SnrAmb
31 (B15)	63 198 CngHOp	63 198 CngHOp	63 198 CngHOp	63 198 CngHOp	63 227 808Cng	63 198 CngHOp	63 198 CngHOp	63 256 Off
32 (B16)	64 199 CngLOp	64 199 CngLOp	64 199 CngLOp	64 199 CngLOp	64 227 808Cng	64 199 CngLOp	64 199 CngLOp	64 256 Off
33 (-01)	27 236 HiQ	27 236 HiQ	27 236 HiQ	27 236 HiQ	27 236 HiQ	27 236 HiQ	27 236 HiQ	27 236 HiQ
34 (-02)	28 220 RiClap	28 220 RiClap	28 220 RiClap	28 220 RiClap	28 230 808Clp	28 220 RiClap	28 220 RiClap	28 230 808Clp
35 (-03)	29 232 Scrch1	29 232 Scrch1	29 232 Scrch1	29 232 Scrch1	29 233 Scrch2	29 232 Scrch1	29 232 Scrch1	29 232 Scrch1
36 (-04)	30 232 Scrch1	30 232 Scrch1	30 232 Scrch1	30 232 Scrch1	30 233 Scrch2	30 232 Scrch1	30 232 Scrch1	30 232 Scrch1
37 (-05)	31 115 HalStk	31 115 HalStk	31 115 HalStk	31 115 HalStk	31 115 HalStk	31 115 HalStk	31 115 HalStk	31 115 HalStk
38 (-06)	32 221 55Clav	32 221 55Clav	32 221 55Clav	32 221 55Clav	32 221 55Clav	32 221 55Clav	32 221 55Clav	32 221 55Clav
39 (-07)	33 223 78Beat	33 223 78Beat	33 223 78Beat	33 223 78Beat	33 223 78Beat	33 223 78Beat	33 223 78Beat	33 223 78Beat
40 (-08)	34 223 78Beat	34 223 78Beat	34 223 78Beat	34 223 78Beat	34 223 78Beat	34 223 78Beat	34 223 78Beat	34 223 78Beat
41 (-09)	35 5 DryHdK	35 27 Deep K	35 6 HeavyK	35 38 ElecK2	35 47 808 K2	35 10 JazzK1	35 35 Soft K	35 29 RvrBk2
42 (-10)	40 58 BechSR	40 90 RckRmS	40 82 BgShiS	40 110 ElecS2	40 112 808 S2	40 59 PiccSS	40 96 BrRIS2	39 230 808Clp
43 (-11)	43 122 StdT2S	43 145 RoomT2	43 133 AmboT2	43 148 ElecT1	43 150 808Tom	43 127 JazzT2	43 135 BrshT2	43 147 RockT2
44 (-12)	47 120 StdT1S	47 144 RoomT1	47 132 AmboT1	47 148 ElecT1	47 150 808Tom	47 126 JazzT1	47 134 BrshT1	47 146 RockT1
45 (-13)	52 177 ChinaC	52 177 ChinaC	52 177 ChinaC	52 177 ChinaC	52 170 78 OHH	52 177 ChinaC	52 177 ChinaC	52 177 ChinaC
46 (-14)	55 176 SplshC	55 176 SplshC	55 185 LrgGng	55 176 SplshC	55 176 SplshC	55 176 SplshC	55 176 SplshC	55 176 SplshC
47 (-15)	59 178 RideC1	59 178 RideC1	59 178 RideC1	59 178 RideC1	59 178 RideC1	59 178 RideC1	59 180 SziRdC	59 179 RideC2
48 (-16)	71 210 WhislS	71 210 WhislS	71 210 WhislS	71 210 WhislS	71 210 WhislS	71 210 WhislS	71 210 WhislS	71 210 WhislS
49 (-17)	72 211 WhislL	72 211 WhislL	72 211 WhislL	72 211 WhislL	72 211 WhislL	72 211 WhislL	72 211 WhislL	72 211 WhislL
50 (-18)	76 193 Wodblk	76 193 Wodblk	76 193 Wodblk	76 193 Wodblk	76 193 Wodblk	76 193 Wodblk	76 193 Wodblk	76 193 Wodblk
51 (-19)	77 193 Wodblk	77 193 Wodblk	77 193 Wodblk	77 193 Wodblk	77 193 Wodblk	77 193 Wodblk	77 193 Wodblk	77 193 Wodblk
52 (-20)	78 213 CuicHi	78 213 CuicHi	78 213 CuicHi	78 213 CuicHi	78 213 CuicHi	78 213 CuicHi	78 213 CuicHi	78 213 CuicHi
53 (-21)	79 214 CuicLo	79 214 CuicLo	79 214 CuicLo	79 214 CuicLo	79 214 CuicLo	79 214 CuicLo	79 214 CuicLo	79 214 CuicLo
54 (-22)	80 192 Triang	80 192 Triang	80 192 Triang	80 192 Triang	80 192 Triang	80 192 Triang	80 192 Triang	80 192 Triang
55 (-23)	81 192 Triang	81 192 Triang	81 192 Triang	81 192 Triang	81 192 Triang	81 192 Triang	81 192 Triang	81 192 Triang

	No. 9 Big	No. 10 Exprsn	No. 11 Power 2	No. 12 Loud	No. 13 Studio	No. 14 Power 3	No. 15 TR808 2	No. 16 TR909
Pad No.	Note # Instrument	Note # Instrument	Note # Instrument	Note # Instrument	Note # Instrument	Note # Instrument	Note # Instrument	Note # Instrument
1 (A01)	49 171 CrshC1	49 171 CrshC1	49 171 CrshC1	49 171 CrshC1	49 171 CrshC1	49 171 CrshC1	49 186 TR808C	49 187 TR606C
2 (A02)	57 172 CrshC2	57 172 CrshC2	57 172 CrshC2	57 173 CrshC3	57 172 CrshC2	57 172 CrshC2	57 170 78 OHH	57 186 TR808C
3 (A03)	53 181 RdBIC1	53 181 RdBIC1	53 182 RdBIC2	53 181 RdBIC1	53 182 RdBIC2	53 182 RdBIC2	53 182 RdBIC2	53 182 RdBIC2
4 (A04)	51 179 RideC2	51 179 RideC2	51 179 RideC2	51 179 RideC2	51 179 RideC2	51 179 RideC2	51 179 RideC2	51 179 RideC2
5 (A05)	50 124 VintT1	50 121 StdT1H	50 121 StdT1H	50 146 RockT1	50 121 StdT1H	50 140 RealT1	50 150 808Tom	50 151 909Tom
6 (A06)	48 124 VintT1	48 121 StdT1H	48 121 StdT1H	48 146 RockT1	48 121 StdT1H	48 140 RealT1	48 150 808Tom	48 151 909Tom
7 (A07)	45 125 VintT2	45 121 StdT1H	45 121 StdT1H	45 147 RockT2	45 121 StdT1H	45 140 RealT1	45 150 808Tom	45 151 909Tom
8 (A08)	41 125 VintT2	41 123 StdT2H	41 123 StdT2H	41 147 RockT2	41 123 StdT2H	41 141 RealT2	41 150 808Tom	41 151 909Tom
9 (A09)	37 116 NatStk	37 114 AmbStk	37 115 HalStk	37 115 HalStk	37 116 NatStk	37 114 AmbStk	37 118 808Stk	37 119 909Stk
10 (A10)	39 57 BechSS	40 60 PiccSH	39 230 808Cip	39 230 808Cip	39 53 Mid SS	39 230 808Cip	39 230 808Cip	39 102 SwingS
11 (A11)	56 188 Cowbel	56 188 Cowbel	56 188 Cowbel	56 188 Cowbel	56 188 Cowbel	56 188 Cowbel	56 231 808Cow	56 231 808Cow
12 (A12)	44 158 16PdHH	44 154 PedlHH	44 158 16PdHH	44 154 PedlHH	44 158 16PdHH	44 158 16PdHH	44 166 808OHH	44 168 909OHH
13 (A13)	36 16 26DepK	36 3 Dry K	36 28 RvrbK1	36 1 AttkK	36 9 VntgK2	36 18 Mid K2	36 47 808 K2	36 52 909HdK
14 (A14)	38 58 BechSR	38 54 Mid SR	38 80 AmbntS	38 72 WrhmHdS	38 62 OpnRmS	38 77 Wet S	38 112 808 S2	38 113 TR909S
15 (A15)	42 155 16 CHH	42 152 PureCH	42 156 16HfOH	42 152 PureCH	42 155 16 CHH	42 156 16HfOH	42 165 808CHH	42 167 909CHH
16 (A16)	46 156 16HfOH	46 153 PureOH	46 157 16 OHH	46 153 PureOH	46 157 16 OHH	46 157 16 OHH	46 166 808OHH	46 168 909OHH
17 (B01)	69 209 Cabasa	69 174 StfCrC	69 209 Cabasa	69 209 Cabasa	69 209 Cabasa	69 209 Cabasa	69 209 Cabasa	69 209 Cabasa
18 (B02)	75 203 Claves	75 174 StfCrC	75 203 Claves	75 203 Claves	75 203 Claves	75 203 Claves	75 228 808Clv	75 228 808Clv
19 (B03)	70 207 Marcas	70 181 RdBIC1	70 207 Marcas	70 207 Marcas	70 207 Marcas	70 207 Marcas	70 229 808Mrc	70 229 808Mrc
20 (B04)	58 204 Vibsip	58 179 RideC2	58 204 Vibsip	58 204 Vibsip	58 204 Vibsip	58 204 Vibsip	58 204 Vibsip	58 204 Vibsip
21 (B05)	67 212 Agogo	67 120 StdT1S	67 212 Agogo	67 212 Agogo	67 212 Agogo	67 212 Agogo	67 212 Agogo	67 212 Agogo
22 (B06)	68 212 Agogo	68 120 StdT1S	68 212 Agogo	68 212 Agogo	68 212 Agogo	68 212 Agogo	68 212 Agogo	68 212 Agogo
23 (B07)	73 205 GuiroS	73 120 StdT1S	73 205 GuiroS	73 205 GuiroS	73 205 GuiroS	73 205 GuiroS	73 224 78Guir	73 224 78Guir
24 (B08)	74 206 GuiroL	74 122 StdT2S	74 206 GuiroL	74 206 GuiroL	74 206 GuiroL	74 206 GuiroL	74 224 78Guir	74 224 78Guir
25 (B09)	60 194 BongoH	60 114 AmbStk	60 194 BongoH	60 194 BongoH	60 194 BongoH	60 194 BongoH	60 194 BongoH	60 194 BongoH
26 (B10)	61 195 BongoL	61 59 PiccSS	61 195 BongoL	61 195 BongoL	61 195 BongoL	61 195 BongoL	61 195 BongoL	61 195 BongoL
27 (B11)	66 201 TmbILo	64 188 Cowbel	66 201 TmbILo	66 201 TmbILo	66 201 TmbILo	66 201 TmbILo	66 201 TmbILo	66 201 TmbILo
28 (B12)	65 200 TmbIHi	63 154 PedlHH	65 200 TmbIHi	65 200 TmbIHi	65 200 TmbIHi	65 200 TmbIHi	65 200 TmbIHi	65 200 TmbIHi
29 (B13)	54 189 Tambm	54 12 MapleK	54 189 Tambm	54 189 Tambm	54 189 Tambm	54 189 Tambm	54 225 78Tamb	54 225 78Tamb
30 (B14)	62 196 CngHMT	62 53 Mid SS	62 196 CngHMT	62 196 CngHMT	62 196 CngHMT	62 196 CngHMT	62 227 808Cng	62 227 808Cng
31 (B15)	63 198 CngHOP	66 152 PureCH	63 198 CngHOP	63 198 CngHOP	63 198 CngHOP	63 198 CngHOP	63 227 808Cng	63 227 808Cng
32 (B16)	64 199 CngLOP	65 153 PureOH	64 199 CngLOP	64 199 CngLOP	64 199 CngLOP	64 199 CngLOP	64 227 808Cng	64 227 808Cng
33 (-01)	27 236 HIQ	27 236 HIQ	27 236 HIQ	27 236 HIQ	27 236 HIQ	27 236 HIQ	27 236 HIQ	27 236 HIQ
34 (-02)	28 220 RIClap	28 230 808Cip	28 220 RIClap	28 220 RIClap	28 220 RIClap	28 220 RIClap	28 230 808Cip	28 230 808Cip
35 (-03)	29 232 Scrch1	29 232 Scrch1	29 232 Scrch1	29 232 Scrch1	29 232 Scrch1	29 232 Scrch1	29 233 Scrch2	29 234 Scrtn
36 (-04)	30 232 Scrch1	30 232 Scrch1	30 232 Scrch1	30 232 Scrch1	30 232 Scrch1	30 232 Scrch1	30 233 Scrch2	30 234 Scrtn
37 (-05)	31 115 HalStk	31 115 HalStk	31 115 HalStk	31 115 HalStk	31 115 HalStk	31 115 HalStk	31 115 HalStk	31 115 HalStk
38 (-06)	32 221 55Clav	32 221 55Clav	32 221 55Clav	32 221 55Clav	32 221 55Clav	32 221 55Clav	32 221 55Clav	32 221 55Clav
39 (-07)	33 223 78Beat	33 223 78Beat	33 223 78Beat	33 223 78Beat	33 223 78Beat	33 223 78Beat	33 223 78Beat	33 223 78Beat
40 (-08)	34 223 78Beat	34 223 78Beat	34 223 78Beat	34 223 78Beat	34 223 78Beat	34 223 78Beat	34 223 78Beat	34 223 78Beat
41 (-09)	35 12 MapleK	35 6 HeavyK	35 24 BoomrK	35 26 CompK2	35 5 DryHdK	35 6 HeavyK	35 48 808EIK	35 47 808 K2
42 (-10)	40 55 Stl SH	39 230 808Cip	40 65 SlRmSS	40 64 SlDrSH	40 87 NatrlS	40 82 BgShtS	40 105 DoplnS	40 112 808 S2
43 (-11)	43 125 VintT2	43 123 StdT2H	43 123 StdT2H	43 147 RockT2	43 123 StdT2H	43 133 AmboT2	43 150 808Tom	43 151 909Tom
44 (-12)	47 124 VintT1	47 121 StdT1H	47 121 StdT1H	47 146 RockT1	47 121 StdT1H	47 132 AmboT1	47 150 808Tom	47 151 909Tom
45 (-13)	52 177 ChinaC	52 177 ChinaC	52 177 ChinaC	52 177 ChinaC	52 177 ChinaC	52 177 ChinaC	52 170 78 OHH	52 170 78 OHH
46 (-14)	55 176 SplshC	55 176 SplshC	55 185 LrgGng	55 176 SplshC	55 176 SplshC	55 185 LrgGng	55 176 SplshC	55 176 SplshC
47 (-15)	59 178 RideC1	59 178 RideC1	59 178 RideC1	59 178 RideC1	59 178 RideC1	59 178 RideC1	59 178 RideC1	59 178 RideC1
48 (-16)	71 210 WhislS	71 210 WhislS	71 210 WhislS	71 210 WhislS	71 210 WhislS	71 210 WhislS	71 210 WhislS	71 210 WhislS
49 (-17)	72 211 WhislL	72 211 WhislL	72 211 WhislL	72 211 WhislL	72 211 WhislL	72 211 WhislL	72 211 WhislL	72 211 WhislL
50 (-18)	76 193 Wodblk	76 193 Wodblk	76 193 Wodblk	76 193 Wodblk	76 193 Wodblk	76 193 Wodblk	76 193 Wodblk	76 193 Wodblk
51 (-19)	77 193 Wodblk	77 193 Wodblk	77 193 Wodblk	77 193 Wodblk	77 193 Wodblk	77 193 Wodblk	77 193 Wodblk	77 193 Wodblk
52 (-20)	78 213 CuicHi	78 213 CuicHi	78 213 CuicHi	78 213 CuicHi	78 213 CuicHi	78 213 CuicHi	78 213 CuicHi	78 213 CuicHi
53 (-21)	79 214 CuicLo	79 214 CuicLo	79 214 CuicLo	79 214 CuicLo	79 214 CuicLo	79 214 CuicLo	79 214 CuicLo	79 214 CuicLo
54 (-22)	80 192 Triang	80 192 Triang	80 192 Triang	80 192 Triang	80 192 Triang	80 192 Triang	80 192 Triang	80 192 Triang
55 (-23)	81 192 Triang	81 192 Triang	81 192 Triang	81 192 Triang	81 192 Triang	81 192 Triang	81 192 Triang	81 192 Triang

	No. 17 Dance 1		No. 18 Rock		No. 19 Funk 1		No. 20 Funk 2		No. 21 HipHop		No. 22 House		No. 23 DrumBs		No. 24 Techno	
Pad No.	Note #	Instrument	Note #	Instrument	Note #	Instrument	Note #	Instrument	Note #	Instrument	Note #	Instrument	Note #	Instrument	Note #	Instrument
1 (A01)	49	173 CrshC3	49	171 CrshC1	49	172 CrshC2	49	172 CrshC2	49	171 CrshC1	49	172 CrshC2	49	172 CrshC2	49	172 CrshC2
2 (A02)	57	173 CrshC3	57	174 SttCrC	57	172 CrshC2	57	175 PgyCrC	57	172 CrshC2	57	187 TR606C	57	187 TR606C	57	187 TR606C
3 (A03)	53	182 RdBIC2	53	182 RdBIC2	53	182 RdBIC2	53	181 RdBIC1	53	182 RdBIC2	53	182 RdBIC2	53	182 RdBIC2	53	182 RdBIC2
4 (A04)	51	179 RideC2	51	178 RideC1	51	178 RideC1	51	178 RideC1	51	178 RideC1	51	179 RideC2	51	179 RideC2	51	179 RideC2
5 (A05)	50	121 StdT1H	50	140 RealT1	50	124 VintT1	50	140 RealT1	50	120 StdT1S	50	150 808Tom	50	151 909Tom	50	151 909Tom
6 (A06)	48	121 StdT1H	48	140 RealT1	48	124 VintT1	48	140 RealT1	48	120 StdT1S	48	150 808Tom	48	151 909Tom	48	151 909Tom
7 (A07)	45	121 StdT1H	45	141 RealT2	45	124 VintT1	45	141 RealT2	45	120 StdT1S	45	150 808Tom	45	151 909Tom	45	151 909Tom
8 (A08)	41	121 StdT1H	41	141 RealT2	41	125 VintT2	41	141 RealT2	41	122 StdT2S	41	150 808Tom	41	151 909Tom	41	151 909Tom
9 (A09)	37	114 AmbStk	37	114 AmbStk	37	116 NatStk	37	114 AmbStk	37	116 NatStk	37	118 808Stk	37	118 808Stk	37	119 909Stk
10 (A10)	39	230 808Clp	39	230 808Clp	39	53 Mid SS	39	230 808Clp	39	220 RlClap	39	230 808Clp	39	230 808Clp	39	230 808Clp
11 (A11)	56	222 78Cow	56	188 Cowbel	56	188 Cowbel	56	188 Cowbel	56	188 Cowbel	56	231 808Cow	56	231 808Cow	56	231 808Cow
12 (A12)	44	165 808CHH	44	154 PedlHH	44	154 PedlHH	44	154 PedlHH	44	154 PedlHH	44	158 16PdHH	44	235 JnglHH	44	154 PedlHH
13 (A13)	36	39 HouseK	36	26 CompK2	36	4 DryMdK	36	22 HbrdK2	36	4 DryMdK	35	39 HouseK	36	51 909K2	36	51 909K2
14 (A14)	38	106 HouseS	38	87 NatrIS	38	58 BechSR	38	70 Funk S	38	61 HiPicS	40	112 808 S2	38	106 HouseS	38	113 TR909S
15 (A15)	42	169 78 CHH	42	161 RealCH	42	152 PureCH	42	161 RealCH	42	152 PureCH	42	167 909CHH	42	169 78 CHH	42	167 909CHH
16 (A16)	46	170 78 OHH	46	164 BrsOHH	46	153 PureOH	46	162 RealOH	46	153 PureOH	46	168 909OHH	46	170 78 OHH	46	168 909OHH
17 (B01)	69	209 Cabasa	69	209 Cabasa	69	209 Cabasa	69	209 Cabasa	69	209 Cabasa	69	209 Cabasa	69	209 Cabasa	69	209 Cabasa
18 (B02)	75	203 Claves	75	203 Claves	75	203 Claves	75	203 Claves	75	203 Claves	75	228 808Clv	75	228 808Clv	75	228 808Clv
19 (B03)	70	207 Marcas	70	207 Marcas	70	207 Marcas	70	207 Marcas	70	207 Marcas	70	229 808Mrc	70	229 808Mrc	70	229 808Mrc
20 (B04)	58	204 Vibslp	58	204 Vibslp	58	204 Vibslp	58	204 Vibslp	58	204 Vibslp	58	204 Vibslp	58	204 Vibslp	58	204 Vibslp
21 (B05)	67	212 Agogo	67	212 Agogo	67	212 Agogo	67	212 Agogo	67	148 ElecT1	67	212 Agogo	67	212 Agogo	67	212 Agogo
22 (B06)	68	212 Agogo	68	212 Agogo	68	212 Agogo	68	212 Agogo	68	148 ElecT1	68	212 Agogo	68	212 Agogo	68	212 Agogo
23 (B07)	73	205 GuiroS	73	205 GuiroS	73	205 GuiroS	73	205 GuiroS	73	148 ElecT1	73	224 78Guir	73	224 78Guir	73	224 78Guir
24 (B08)	74	206 GuiroL	74	206 GuiroL	74	206 GuiroL	74	206 GuiroL	74	148 ElecT1	74	224 78Guir	74	224 78Guir	74	224 78Guir
25 (B09)	60	194 BongoH	60	194 BongoH	60	194 BongoH	60	194 BongoH	60	104 DanceS	60	194 BongoH	60	194 BongoH	60	194 BongoH
26 (B10)	61	195 BongoL	61	195 BongoL	61	195 BongoL	61	195 BongoL	61	185 LrgGng	61	195 BongoL	61	195 BongoL	61	195 BongoL
27 (B11)	66	201 TmbLLo	66	201 TmbLLo	66	201 TmbLLo	66	201 TmbLLo	66	201 TmbLLo	66	201 TmbLLo	66	201 TmbLLo	66	201 TmbLLo
28 (B12)	65	200 TmbLHi	65	200 TmbLHi	65	200 TmbLHi	65	200 TmbLHi	65	200 TmbLHi	65	200 TmbLHi	65	200 TmbLHi	65	200 TmbLHi
29 (B13)	54	189 Tambm	54	189 Tambm	54	189 Tambm	54	189 Tambm	54	189 Tambm	54	225 78Tamb	54	44 GubbaK	54	225 78Tamb
30 (B14)	62	196 CngHMT	62	196 CngHMT	62	196 CngHMT	62	196 CngHMT	62	196 CngHMT	62	227 808Cng	62	227 808Cng	62	227 808Cng
31 (B15)	63	197 CngSlp	63	197 CngSlp	63	198 CngHop	63	198 CngHop	63	198 CngHop	63	227 808Cng	63	227 808Cng	63	227 808Cng
32 (B16)	64	199 CngLOp	64	199 CngLOp	64	199 CngLOp	64	199 CngLOp	64	199 CngLOp	64	227 808Cng	64	227 808Cng	64	227 808Cng
33 (-01)	27	240 BeamHQ	27	240 BeamHQ	27	236 HiQ	27	236 HiQ	27	236 HiQ	27	236 HiQ	27	236 HiQ	27	236 HiQ
34 (-02)	28	230 808Clp	28	220 RlClap	28	220 RlClap	28	220 RlClap	28	191 Casta	28	220 RlClap	28	220 RlClap	28	220 RlClap
35 (-03)	29	232 Scrch1	29	232 Scrch1	29	232 Scrch1	29	232 Scrch1	29	232 Scrch1	29	233 Scrch2	29	233 Scrch2	29	233 Scrch2
36 (-04)	30	232 Scrch1	30	232 Scrch1	30	232 Scrch1	30	232 Scrch1	30	232 Scrch1	30	233 Scrch2	30	233 Scrch2	30	233 Scrch2
37 (-05)	31	115 HalStk	31	115 HalStk	31	115 HalStk	31	115 HalStk	31	115 HalStk	31	115 HalStk	31	115 HalStk	31	115 HalStk
38 (-06)	32	221 55Clav	32	221 55Clav	32	221 55Clav	32	221 55Clav	32	221 55Clav	32	221 55Clav	32	221 55Clav	32	221 55Clav
39 (-07)	33	223 78Beat	33	223 78Beat	33	223 78Beat	33	223 78Beat	33	223 78Beat	33	223 78Beat	33	246 RevCym	33	223 78Beat
40 (-08)	34	223 78Beat	34	223 78Beat	34	223 78Beat	34	223 78Beat	34	223 78Beat	34	223 78Beat	34	239 DncShk	34	223 78Beat
41 (-09)	35	17 Mid K1	35	18 Mid K2	35	5 DryHdK	35	25 CompK1	35	5 DryHdK	36	51 909K2	35	49 808BmK	35	43 PlstcK
42 (-10)	40	103 90's S	40	92 RockS1	40	57 BechSS	40	90 RckRmS	40	58 BechSR	38	113 TR909S	40	112 808 S2	40	112 808 S2
43 (-11)	43	121 StdT1H	43	141 RealT2	43	122 StdT2S	43	141 RealT2	43	122 StdT2S	43	150 808Tom	43	151 909Tom	43	151 909Tom
44 (-12)	47	121 StdT1H	47	140 RealT1	47	120 StdT1S	47	140 RealT1	47	120 StdT1S	47	150 808Tom	47	151 909Tom	47	151 909Tom
45 (-13)	52	177 ChinaC	52	177 ChinaC	52	177 ChinaC	52	177 ChinaC	52	177 ChinaC	52	170 78 OHH	52	170 78 OHH	52	170 78 OHH
46 (-14)	55	185 LrgGng	55	185 LrgGng	55	176 SplshC	55	176 SplshC	55	176 SplshC	55	176 SplshC	55	176 SplshC	55	176 SplshC
47 (-15)	59	178 RideC1	59	178 RideC1	59	178 RideC1	59	178 RideC1	59	178 RideC1	59	178 RideC1	59	178 RideC1	59	178 RideC1
48 (-16)	71	210 WhislS	71	210 WhislS	71	210 WhislS	71	210 WhislS	71	210 WhislS	71	210 WhislS	71	210 WhislS	71	210 WhislS
49 (-17)	72	211 WhislL	72	211 WhislL	72	211 WhislL	72	211 WhislL	72	211 WhislL	72	211 WhislL	72	211 WhislL	72	211 WhislL
50 (-18)	76	193 Wodbk	76	193 Wodbk	76	193 Wodbk	76	193 Wodbk	76	193 Wodbk	76	193 Wodbk	76	193 Wodbk	76	193 Wodbk
51 (-19)	77	193 Wodbk	77	193 Wodbk	77	193 Wodbk	77	193 Wodbk	77	193 Wodbk	77	193 Wodbk	77	193 Wodbk	77	193 Wodbk
52 (-20)	78	213 CuicHi	78	213 CuicHi	78	213 CuicHi	78	213 CuicHi	78	213 CuicHi	78	213 CuicHi	78	213 CuicHi	78	213 CuicHi
53 (-21)	79	214 CuicLo	79	214 CuicLo	79	214 CuicLo	79	214 CuicLo	79	214 CuicLo	79	214 CuicLo	79	214 CuicLo	79	214 CuicLo
54 (-22)	80	192 Triang	80	192 Triang	80	192 Triang	80	192 Triang	80	192 Triang	80	192 Triang	80	192 Triang	80	192 Triang
55 (-23)	81	192 Triang	81	192 Triang	81	192 Triang	81	192 Triang	81	192 Triang	81	192 Triang	81	192 Triang	81	192 Triang

	No. 25 Brazil		No. 26 India		No. 27 Room 2		No. 28 Room 3		No. 29 Fusion		No. 30 Natural		No. 31 Ballad		No. 32 Groove	
Pad No.	Note #	Instrument	Note #	Instrument	Note #	Instrument	Note #	Instrument	Note #	Instrument	Note #	Instrument	Note #	Instrument	Note #	Instrument
1 (A01)	49	171 CrshC1	49	171 CrshC1	49	171 CrshC1	49	172 CrshC2	49	171 CrshC1	49	171 CrshC1	49	171 CrshC1	49	171 CrshC1
2 (A02)	57	172 CrshC2	57	172 CrshC2	57	172 CrshC2	57	172 CrshC2	57	172 CrshC2	57	172 CrshC2	57	172 CrshC2	57	173 CrshC3
3 (A03)	53	182 RdBIC2	53	182 RdBIC2	53	182 RdBIC2	53	181 RdBIC1	53	182 RdBIC2	53	181 RdBIC1	53	181 RdBIC1	53	182 RdBIC2
4 (A04)	51	179 RideC2	51	179 RideC2	51	179 RideC2	51	178 RideC1	51	179 RideC2	51	178 RideC1	51	178 RideC1	51	179 RideC2
5 (A05)	50	196 CngHMT	50	217 Tabla1	50	132 AmboT1	50	146 RockT1	50	128 FuseT1	50	140 RealT1	50	124 VintT1	50	144 RoomT1
6 (A06)	48	197 CngSlp	48	217 Tabla1	48	132 AmboT1	48	146 RockT1	48	128 FuseT1	48	140 RealT1	48	124 VintT1	48	144 RoomT1
7 (A07)	45	198 CngHOp	45	218 Tabla2	45	133 AmboT2	45	147 RockT2	45	129 FuseT2	45	141 RealT2	45	125 VintT2	45	144 RoomT1
8 (A08)	41	198 CngHOp	41	219 Tabla3	41	133 AmboT2	41	147 RockT2	41	129 FuseT2	41	141 RealT2	41	125 VintT2	41	145 RoomT2
9 (A09)	40	199 CngLOp	37	116 NatStk	37	115 HalStk	37	114 AmbStk	37	114 AmbStk	37	116 NatStk	37	116 NatStk	37	116 NatStk
10 (A10)	39	203 Claves	39	230 808Clp	39	230 808Clp	39	230 808Clp	39	230 808Clp	39	75 Dry SS	39	54 Mid SR	39	230 808Clp
11 (A11)	54	189 Tambm	56	188 Cowbel	56	188 Cowbel	56	188 Cowbel	56	188 Cowbel	56	188 Cowbel	56	188 Cowbel	56	188 Cowbel
12 (A12)	44	154 PedlHH	44	154 PedlHH	44	154 PedlHH	44	154 PedlHH	44	154 PedlHH	44	154 PedlHH	44	158 16PdHH	44	154 PedlHH
13 (A13)	36	10 JazzK1	36	35 Soft K	36	17 Mid K1	36	31 DpRomK	36	7 PillwK	36	25 CompK1	36	16 26DepK	36	25 CompK1
14 (A14)	38	56 Sli SR	38	79 AcRimS	38	63 SIDrSS	38	66 SIRMSh	38	55 Sli SH	38	87 NatriS	38	53 Mid SS	38	78 LAFatS
15 (A15)	42	152 PureCH	42	152 PureCH	42	152 PureCH	42	161 RealCH	42	152 PureCH	42	152 PureCH	42	155 16 CHI	42	161 RealCH
16 (A16)	46	153 PureOH	46	153 PureOH	46	153 PureOH	46	162 RealOH	46	160 PopOHH	46	153 PureOH	46	157 16 OHH	46	162 RealOH
17 (B01)	69	209 Cabasa	69	209 Cabasa	69	209 Cabasa	69	209 Cabasa	69	209 Cabasa	69	209 Cabasa	69	209 Cabasa	69	209 Cabasa
18 (B02)	70	209 Cabasa	75	203 Claves	75	203 Claves	75	203 Claves	75	203 Claves	75	203 Claves	75	203 Claves	75	203 Claves
19 (B03)	75	207 Marcas	70	207 Marcas	70	207 Marcas	70	207 Marcas	70	207 Marcas	70	207 Marcas	70	207 Marcas	70	207 Marcas
20 (B04)	58	204 Vibslp	58	204 Vibslp	58	204 Vibslp	58	204 Vibslp	58	204 Vibslp	58	204 Vibslp	58	204 Vibslp	58	204 Vibslp
21 (B05)	67	212 Agogo	67	212 Agogo	67	212 Agogo	67	212 Agogo	67	212 Agogo	67	212 Agogo	67	212 Agogo	67	212 Agogo
22 (B06)	68	212 Agogo	68	212 Agogo	68	212 Agogo	68	212 Agogo	68	212 Agogo	68	212 Agogo	68	212 Agogo	68	212 Agogo
23 (B07)	73	205 GuiroS	73	205 GuiroS	73	205 GuiroS	73	205 GuiroS	73	205 GuiroS	73	205 GuiroS	73	205 GuiroS	73	222 78Cow
24 (B08)	74	206 GuiroL	74	206 GuiroL	74	206 GuiroL	74	206 GuiroL	74	206 GuiroL	74	206 GuiroL	74	206 GuiroL	74	239 DncShk
25 (B09)	60	194 BongoH	60	194 BongoH	60	194 BongoH	60	194 BongoH	60	194 BongoH	60	194 BongoH	60	194 BongoH	60	194 BongoH
26 (B10)	61	195 BongoL	61	195 BongoL	61	195 BongoL	61	195 BongoL	61	195 BongoL	61	195 BongoL	61	195 BongoL	61	195 BongoL
27 (B11)	66	201 TmbLlo	66	201 TmbLlo	66	201 TmbLlo	66	201 TmbLlo	66	201 TmbLlo	66	201 TmbLlo	66	201 TmbLlo	66	201 TmbLlo
28 (B12)	65	200 TmbLHi	65	200 TmbLHi	65	200 TmbLHi	65	200 TmbLHi	65	200 TmbLHi	65	200 TmbLHi	65	200 TmbLHi	65	200 TmbLHi
29 (B13)	64	202 TmbLSd	54	189 Tambm	54	189 Tambm	54	189 Tambm	54	189 Tambm	54	189 Tambm	54	189 Tambm	54	189 Tambm
30 (B14)	56	209 Cabasa	62	196 CngHMT	62	196 CngHMT	62	196 CngHMT	62	196 CngHMT	62	196 CngHMT	62	196 CngHMT	62	196 CngHMT
31 (B15)	62	188 Cowbel	63	198 CngHOp	63	198 CngHOp	63	198 CngHOp	63	198 CngHOp	63	198 CngHOp	63	198 CngHOp	63	198 CngHOp
32 (B16)	63	188 Cowbel	64	199 CngLOp	64	199 CngLOp	64	199 CngLOp	64	199 CngLOp	64	199 CngLOp	64	199 CngLOp	64	199 CngLOp
33 (-01)	27	236 HiQ	27	236 HiQ	27	236 HiQ	27	236 HiQ	27	236 HiQ	27	236 HiQ	27	236 HiQ	27	236 HiQ
34 (-02)	28	220 RIClap	28	220 RIClap	28	220 RIClap	28	220 RIClap	28	220 RIClap	28	220 RIClap	28	220 RIClap	28	220 RIClap
35 (-03)	29	232 Scrch1	29	232 Scrch1	29	232 Scrch1	29	232 Scrch1	29	232 Scrch1	29	232 Scrch1	29	232 Scrch1	29	232 Scrch1
36 (-04)	30	232 Scrch1	30	232 Scrch1	30	232 Scrch1	30	232 Scrch1	30	232 Scrch1	30	232 Scrch1	30	232 Scrch1	30	232 Scrch1
37 (-05)	31	115 HalStk	31	115 HalStk	31	115 HalStk	31	115 HalStk	31	115 HalStk	31	115 HalStk	31	115 HalStk	31	115 HalStk
38 (-06)	32	221 55Clav	32	221 55Clav	32	221 55Clav	32	221 55Clav	32	221 55Clav	32	221 55Clav	32	221 55Clav	32	221 55Clav
39 (-07)	33	223 78Beat	33	223 78Beat	33	223 78Beat	33	223 78Beat	33	223 78Beat	33	223 78Beat	33	223 78Beat	33	223 78Beat
40 (-08)	34	223 78Beat	34	223 78Beat	34	223 78Beat	34	223 78Beat	34	223 78Beat	34	223 78Beat	34	223 78Beat	34	223 78Beat
41 (-09)	35	9 VntgK2	35	5 DryHdK	35	27 Deep K	35	27 Deep K	35	6 HeavyK	35	26 CompK2	35	5 DryHdK	35	27 Deep K
42 (-10)	37	116 NatStk	40	91 Real S	40	90 RckRmS	40	90 RckRmS	40	82 BgShtS	40	74 SnapyS	40	58 BechSR	40	90 RckRmS
43 (-11)	43	198 CngHOP	43	218 Tabla2	43	133 AmboT2	43	147 RockT2	43	129 FuseT2	43	141 RealT2	43	122 StdT2S	43	145 RoomT2
44 (-12)	47	197 CngSlp	47	217 Tabla1	47	132 AmboT1	47	146 RockT1	47	128 FuseT1	47	140 RealT1	47	120 StdT1S	47	144 RoomT1
45 (-13)	52	177 ChinaC	52	177 ChinaC	52	177 ChinaC	52	177 ChinaC	52	177 ChinaC	52	177 ChinaC	52	177 ChinaC	52	177 ChinaC
46 (-14)	55	176 SplshC	55	176 SplshC	55	176 SplshC	55	176 SplshC	55	176 SplshC	55	176 SplshC	55	176 SplshC	55	176 SplshC
47 (-15)	59	178 RideC1	59	178 RideC1	59	178 RideC1	59	178 RideC1	59	178 RideC1	59	178 RideC1	59	178 RideC1	59	178 RideC1
48 (-16)	71	210 WhisLS	71	210 WhisLS	71	210 WhisLS	71	210 WhisLS	71	210 WhisLS	71	210 WhisLS	71	210 WhisLS	71	210 WhisLS
49 (-17)	72	211 WhisLL	72	211 WhisLL	72	211 WhisLL	72	211 WhisLL	72	211 WhisLL	72	211 WhisLL	72	211 WhisLL	72	211 WhisLL
50 (-18)	76	193 Wodblk	76	193 Wodblk	76	193 Wodblk	76	193 Wodblk	76	193 Wodblk	76	193 Wodblk	76	193 Wodblk	76	193 Wodblk
51 (-19)	77	193 Wodblk	77	193 Wodblk	77	193 Wodblk	77	193 Wodblk	77	193 Wodblk	77	193 Wodblk	77	193 Wodblk	77	193 Wodblk
52 (-20)	78	213 CuicHi	78	213 CuicHi	78	213 CuicHi	78	213 CuicHi	78	213 CuicHi	78	213 CuicHi	78	213 CuicHi	78	213 CuicHi
53 (-21)	79	214 CuicLo	79	214 CuicLo	79	214 CuicLo	79	214 CuicLo	79	214 CuicLo	79	214 CuicLo	79	214 CuicLo	79	214 CuicLo
54 (-22)	80	192 Triang	80	192 Triang	80	192 Triang	80	192 Triang	80	192 Triang	80	192 Triang	80	192 Triang	80	192 Triang
55 (-23)	81	192 Triang	81	192 Triang	81	192 Triang	81	192 Triang	81	192 Triang	81	192 Triang	81	192 Triang	81	192 Triang

Preset Drum Kit List

	No. 33 Boom	No. 34 Jazz 2	No. 35 Afro 1	No. 36 HvyFunk	No. 37 Folk	No. 38 StdLyr	No. 39 Blues	No. 40 Gospel
Pad No.	Note # Instrument	Note # Instrument	Note # Instrument	Note # Instrument	Note # Instrument	Note # Instrument	Note # Instrument	Note # Instrument
1 (A01)	49 187 TR606C	49 174 SftCrC	49 173 CrshC3	49 171 CrshC1	49 174 SftCrC	49 171 CrshC1	49 171 CrshC1	49 171 CrshC1
2 (A02)	57 187 TR606C	57 172 CrshC2	57 172 CrshC2	57 172 CrshC2	57 183 BrCrS	57 172 CrshC2	57 173 CrshC3	57 172 CrshC2
3 (A03)	53 181 RdBIC1	53 181 RdBIC1	53 182 RdBIC2	53 181 RdBIC1	53 182 RdBIC2	53 182 RdBIC2	53 182 RdBIC2	53 182 RdBIC2
4 (A04)	51 179 RideC2	51 180 SziRdC	51 179 RideC2	51 179 RideC2	51 184 BrRidC	51 179 RideC2	51 180 SziRdC	51 179 RideC2
5 (A05)	50 148 ElecT1	50 136 DbHdT1	50 121 StdT1H	50 140 RealT1	50 138 LiteT1	50 121 StdT1H	50 126 JazzT1	50 136 DbHdT1
6 (A06)	48 148 ElecT1	48 136 DbHdT1	48 121 StdT1H	48 140 RealT1	48 138 LiteT1	48 120 StdT1S	48 126 JazzT1	48 136 DbHdT1
7 (A07)	45 148 ElecT1	45 137 DbHdT2	45 121 StdT1H	45 140 RealT1	45 138 LiteT1	45 120 StdT1S	45 126 JazzT1	45 136 DbHdT1
8 (A08)	41 148 ElecT1	41 137 DbHdT2	41 123 StdT2H	41 141 RealT2	41 139 LiteT2	41 122 StdT2S	41 127 JazzT2	41 137 DbHdT2
9 (A09)	37 119 909Stk	37 116 NatStk	37 116 NatStk	37 116 NatStk	37 116 NatStk	37 115 HalStk	37 115 HalStk	37 75 Dry SS
10 (A10)	39 230 808Clp	39 86 LooseS	39 53 Mid SS	39 57 BechSS	39 99 BrSIS3	39 220 RIClap	39 220 RIClap	39 220 RIClap
11 (A11)	56 188 Cowbel	56 188 Cowbel	56 188 Cowbel	56 188 Cowbel	56 220 RIClap	56 188 Cowbel	56 189 Tambm	56 188 Cowbel
12 (A12)	44 167 909CHH	44 154 PedlHH	44 158 16PdHH	44 154 PedlHH	44 154 PedlHH	44 154 PedlHH	44 154 PedlHH	44 154 PedlHH
13 (A13)	36 50 909 K1	36 16 26DepK	36 39 HouseK	36 18 Mid K2	36 35 Soft K	36 6 HeavyK	36 11 JazzK2	36 12 MapleK
14 (A14)	38 107 HsDprNS	38 86 LooseS	38 91 Real S	38 58 BechSR	38 57 BechSS	38 64 SIDrSH	38 67 DryHdS	38 87 NatriS
15 (A15)	42 167 909CHH	42 152 PureCH	42 155 16 CHH	42 152 PureCH	42 152 PureCH	42 152 PureCH	42 152 PureCH	42 152 PureCH
16 (A16)	46 168 909OHH	46 153 PureOH	46 157 16 OHH	46 153 PureOH	46 153 PureOH	46 153 PureOH	46 153 PureOH	46 153 PureOH
17 (B01)	69 209 Cabasa	69 209 Cabasa	69 207 Marcas	69 209 Cabasa	69 209 Cabasa	69 174 SftCrC	69 174 SftCrC	69 209 Cabasa
18 (B02)	75 203 Claves	75 203 Claves	75 203 Claves	75 203 Claves	75 203 Claves	75 179 RideC2	75 179 RideC2	75 203 Claves
19 (B03)	70 207 Marcas	70 207 Marcas	70 207 Marcas	70 207 Marcas	70 207 Marcas	70 178 RideC1	70 178 RideC1	70 207 Marcas
20 (B04)	58 204 Vibslp	58 204 Vibslp	58 206 GuioL	58 204 Vibslp	58 204 Vibslp	58 179 RideC2	58 179 RideC2	58 204 Vibslp
21 (B05)	67 222 78Cow	67 212 Agogo	67 212 Agogo	67 212 Agogo	67 212 Agogo	67 138 LiteT1	67 256 Off	67 212 Agogo
22 (B06)	68 237 TapRwd	68 212 Agogo	68 212 Agogo	68 212 Agogo	68 212 Agogo	68 139 LiteT2	68 256 Off	68 212 Agogo
23 (B07)	73 234 ScrtSn	73 205 GuioS	73 202 TmblSd	73 205 GuioS	73 205 GuioS	73 139 LiteT2	73 256 Off	73 205 GuioS
24 (B08)	74 206 GuioL	74 206 GuioL	74 206 GuioL	74 206 GuioL	74 206 GuioL	74 139 LiteT2	74 256 Off	74 206 GuioL
25 (B09)	60 194 BongoH	60 194 BongoH	60 194 BongoH	60 194 BongoH	60 194 BongoH	60 256 Off	60 256 Off	60 194 BongoH
26 (B10)	61 195 BongoL	61 195 BongoL	61 195 BongoL	61 195 BongoL	61 195 BongoL	61 256 Off	61 256 Off	61 195 BongoL
27 (B11)	66 201 TmblLo	66 201 TmblLo	66 199 CngLop	66 201 TmblLo	66 201 TmblLo	66 188 Cowbel	66 256 Off	66 201 TmblLo
28 (B12)	65 200 TmblHi	65 200 TmblHi	65 199 CngLop	65 200 TmblHi	65 200 TmblHi	65 154 PedlHH	65 256 Off	65 200 TmblHi
29 (B13)	54 189 Tambm	54 189 Tambm	54 189 Tambm	54 189 Tambm	54 189 Tambm	54 12 MapleK	54 256 Off	54 189 Tambm
30 (B14)	62 196 CngHmt	62 196 CngHmt	62 196 CngHmt	62 196 CngHmt	62 196 CngHmt	62 63 SIDrSS	62 53 Mid SS	62 196 CngHmt
31 (B15)	63 198 CngHop	63 198 CngHop	63 198 CngHop	63 198 CngHop	63 198 CngHop	63 152 PureCH	63 256 Off	63 198 CngHop
32 (B16)	64 199 CngLop	64 199 CngLop	64 198 CngHop	64 199 CngLop	64 199 CngLop	64 153 PureOH	64 256 Off	64 199 CngLop
33 (-01)	27 236 HIQ	27 236 HIQ	27 236 HIQ	27 236 HIQ	27 236 HIQ	27 236 HIQ	27 236 HIQ	27 236 HIQ
34 (-02)	28 220 RIClap	28 220 RIClap	28 220 RIClap	28 220 RIClap	28 230 808Clp	28 230 808Clp	28 230 808Clp	28 230 808Clp
35 (-03)	29 232 Scrch1	29 232 Scrch1	29 232 Scrch1	29 232 Scrch1	29 232 Scrch1	29 232 Scrch1	29 232 Scrch1	29 232 Scrch1
36 (-04)	30 232 Scrch1	30 232 Scrch1	30 232 Scrch1	30 232 Scrch1	30 232 Scrch1	30 232 Scrch1	30 232 Scrch1	30 232 Scrch1
37 (-05)	31 115 HalStk	31 115 HalStk	31 115 HalStk	31 115 HalStk	31 115 HalStk	31 115 HalStk	31 115 HalStk	31 115 HalStk
38 (-06)	32 221 55Clav	32 221 55Clav	32 221 55Clav	32 221 55Clav	32 221 55Clav	32 221 55Clav	32 221 55Clav	32 221 55Clav
39 (-07)	33 223 78Beat	33 223 78Beat	33 223 78Beat	33 223 78Beat	33 223 78Beat	33 223 78Beat	33 223 78Beat	33 223 78Beat
40 (-08)	34 223 78Beat	34 223 78Beat	34 223 78Beat	34 223 78Beat	34 223 78Beat	34 223 78Beat	34 223 78Beat	34 223 78Beat
41 (-09)	35 38 ElecK2	35 10 JazzK1	35 5 DryHdK	35 5 DryHdK	35 5 DryHdK	35 5 DryHdK	35 5 DryHdK	35 5 DryHdK
42 (-10)	40 110 ElecS2	40 59 PiccSS	40 87 NatriS	40 58 BechSR	40 58 BechSR	40 58 BechSR	40 58 BechSR	40 75 Dry SS
43 (-11)	43 148 ElecT1	43 127 JazzT2	43 123 StdT2H	43 122 StdT2S	43 139 LiteT2	43 122 StdT2S	43 122 StdT2S	43 137 DbHdT2
44 (-12)	47 148 ElecT1	47 126 JazzT1	47 121 StdT1H	47 120 StdT1S	47 138 LiteT1	47 120 StdT1S	47 120 StdT1S	47 136 DbHdT1
45 (-13)	52 177 ChinaC	52 177 ChinaC	52 177 ChinaC	52 177 ChinaC	52 177 ChinaC	52 177 ChinaC	52 177 ChinaC	52 177 ChinaC
46 (-14)	55 176 SplshC	55 176 SplshC	55 176 SplshC	55 176 SplshC	55 176 SplshC	55 176 SplshC	55 176 SplshC	55 176 SplshC
47 (-15)	59 178 RideC1	59 178 RideC1	59 178 RideC1	59 178 RideC1	59 178 RideC1	59 178 RideC1	59 178 RideC1	59 178 RideC1
48 (-16)	71 210 WhislS	71 210 WhislS	71 210 WhislS	71 210 WhislS	71 210 WhislS	71 210 WhislS	71 210 WhislS	71 210 WhislS
49 (-17)	72 211 WhislL	72 211 WhislL	72 211 WhislL	72 211 WhislL	72 211 WhislL	72 211 WhislL	72 211 WhislL	72 211 WhislL
50 (-18)	76 193 Wodbk	76 193 Wodbk	76 193 Wodbk	76 193 Wodbk	76 193 Wodbk	76 193 Wodbk	76 193 Wodbk	76 193 Wodbk
51 (-19)	77 193 Wodbk	77 193 Wodbk	77 193 Wodbk	77 193 Wodbk	77 193 Wodbk	77 193 Wodbk	77 193 Wodbk	77 193 Wodbk
52 (-20)	78 213 CuicHi	78 213 CuicHi	78 213 CuicHi	78 213 CuicHi	78 213 CuicHi	78 213 CuicHi	78 213 CuicHi	78 213 CuicHi
53 (-21)	79 214 CuicLo	79 214 CuicLo	79 214 CuicLo	79 214 CuicLo	79 214 CuicLo	79 214 CuicLo	79 214 CuicLo	79 214 CuicLo
54 (-22)	80 192 Triang	80 192 Triang	80 192 Triang	80 192 Triang	80 192 Triang	80 192 Triang	80 192 Triang	80 192 Triang
55 (-23)	81 192 Triang	81 192 Triang	81 192 Triang	81 192 Triang	81 192 Triang	81 192 Triang	81 192 Triang	81 192 Triang

	No. 41 Jazz 3		No. 42 BigFunk		No. 43 Samba		No. 44 Reggae		No. 45 Salsa		No. 46 Tabla		No. 47 Electro2		No. 48 Vintage	
Pad No.	Note #	Instrument	Note #	Instrument	Note #	Instrument	Note #	Instrument	Note #	Instrument	Note #	Instrument	Note #	Instrument	Note #	Instrument
1 (A01)	49	171 CrshC1	49	171 CrshC1	49	171 CrshC1	49	176 SplshC	49	171 CrshC1	49	171 CrshC1	49	172 CrshC2	49	171 CrshC1
2 (A02)	57	172 CrshC2	57	177 ChinaC	57	172 CrshC2	57	173 CrshC3	57	173 CrshC3	57	172 CrshC2	57	176 SplshC	57	172 CrshC2
3 (A03)	53	182 RdBIC2	53	182 RdBIC2	53	182 RdBIC2	53	182 RdBIC2	53	182 RdBIC2	53	182 RdBIC2	53	181 RdBIC1	53	181 RdBIC1
4 (A04)	51	179 RideC2	51	179 RideC2	51	179 RideC2	51	179 RideC2	51	179 RideC2	51	179 RideC2	51	178 RideC1	51	178 RideC1
5 (A05)	50	126 JazzT1	50	140 RealT1	50	210 WhisS	50	142 RingT1	50	136 DbHdT1	62	217 Tabla1	50	149 ElecT2	50	130 BowT1
6 (A06)	48	126 JazzT1	48	140 RealT1	48	211 WhisL	48	142 RingT1	48	136 DbHdT1	63	217 Tabla1	48	149 ElecT2	48	130 BowT1
7 (A07)	45	126 JazzT1	45	140 RealT1	45	215 SurdMt	45	142 RingT1	45	136 DbHdT1	64	219 Tabla3	45	149 ElecT2	45	131 BowT2
8 (A08)	41	127 JazzT2	41	141 RealT2	41	216 SurdOp	41	143 RingT2	41	137 DbHdT2	66	218 Tabla2	41	149 ElecT2	41	131 BowT2
9 (A09)	37	115 HalStk	37	115 HalStk	37	116 NatStk	37	116 NatStk	37	116 NatStk	65	219 Tabla3	37	115 HalStk	37	115 HalStk
10 (A10)	39	220 RIClap	39	220 RIClap	39	53 Mid SS	39	220 RIClap	39	53 Mid SS	39	53 Mid SS	39	230 808Cip	39	220 RIClap
11 (A11)	56	189 Tambrn	56	189 Tambrn	56	188 Cowbel	56	188 Cowbel	56	188 Cowbel	56	188 Cowbel	56	188 Cowbel	56	188 Cowbel
12 (A12)	44	154 PedlHH	44	154 PedlHH	44	154 PedlHH	44	154 PedlHH	44	154 PedlHH	44	154 PedlHH	44	158 16PdHH	44	154 PedlHH
13 (A13)	36	11 JazzK2	36	12 MapleK	36	12 MapleK	36	25 CompK1	36	9 VntgK2	36	22 HbrdK2	36	38 ElecK2	36	12 MapleK
14 (A14)	38	54 Mid SR	38	77 Wet S	38	54 Mid SR	38	101 Regaes	38	55 Stil SH	38	87 NatrIS	38	110 ElecS2	38	56 Stil SR
15 (A15)	42	152 PureCH	42	161 RealCH	42	152 PureCH	42	152 PureCH	42	152 PureCH	42	152 PureCH	42	161 RealCH	42	152 PureCH
16 (A16)	46	153 PureOH	46	162 RealOH	46	153 PureOH	46	153 PureOH	46	153 PureOH	46	153 PureOH	46	162 RealOH	46	153 PureOH
17 (B01)	69	174 SttCrC	69	179 RideC2	69	209 Cabasa	69	209 Cabasa	69	207 Marcas	69	209 Cabasa	69	209 Cabasa	69	209 Cabasa
18 (B02)	75	179 RideC2	75	179 RideC2	75	203 Claves	75	203 Claves	75	203 Claves	75	203 Claves	75	203 Claves	75	203 Claves
19 (B03)	70	178 RideC1	70	179 RideC2	70	207 Marcas	70	207 Marcas	70	208 Shaker	70	207 Marcas	70	207 Marcas	70	207 Marcas
20 (B04)	58	179 RideC2	58	179 RideC2	58	204 Vibslp	58	204 Vibslp	58	204 Vibslp	58	204 Vibslp	58	204 Vibslp	58	204 Vibslp
21 (B05)	67	256 Off	67	256 Off	67	212 Agogo	67	212 Agogo	67	212 Agogo	67	212 Agogo	67	212 Agogo	67	212 Agogo
22 (B06)	68	256 Off	68	256 Off	68	212 Agogo	68	212 Agogo	68	212 Agogo	68	212 Agogo	68	212 Agogo	68	212 Agogo
23 (B07)	73	256 Off	73	256 Off	73	213 CuicHi	73	213 CuicHi	73	205 GuiroS	73	205 GuiroS	73	205 GuiroS	73	205 GuiroS
24 (B08)	74	256 Off	74	256 Off	74	214 CuicLo	74	214 CuicLo	74	206 GuiroL	74	206 GuiroL	74	206 GuiroL	74	206 GuiroL
25 (B09)	60	256 Off	60	256 Off	60	194 BongoH	60	194 BongoH	60	194 BongoH	50	120 StdT1S	60	194 BongoH	60	194 BongoH
26 (B10)	61	256 Off	61	256 Off	61	195 BongoL	61	195 BongoL	61	195 BongoL	48	120 StdT1S	61	195 BongoL	61	195 BongoL
27 (B11)	66	256 Off	66	256 Off	66	201 TmbLlo	66	201 TmbLlo	66	201 TmbLlo	45	120 StdT1S	66	201 TmbLlo	66	201 TmbLlo
28 (B12)	65	256 Off	65	256 Off	65	200 TmbLhi	65	200 TmbLhi	65	200 TmbLhi	41	122 StdT2S	65	200 TmbLhi	65	200 TmbLhi
29 (B13)	54	256 Off	54	35 Soft K	54	189 Tambrn	54	189 Tambrn	54	189 Tambrn	37	116 NatStk	54	189 Tambrn	54	189 Tambrn
30 (B14)	62	53 Mid SS	62	67 DryHdS	62	196 CngHmt	62	196 CngHmt	62	196 CngHmt	60	194 BongoH	62	196 CngHmt	62	196 CngHmt
31 (B15)	63	256 Off	63	256 Off	63	198 CngHOp	63	198 CngHOp	63	198 CngHOp	61	195 BongoL	63	198 CngHOp	63	198 CngHOp
32 (B16)	64	256 Off	64	256 Off	64	199 CngLOp	64	199 CngLOp	64	199 CngLOp	54	189 Tambrn	64	199 CngLOp	64	199 CngLOp
33 (-01)	27	236 HiQ	27	236 HiQ	27	236 HiQ	27	236 HiQ	27	236 HiQ	27	236 HiQ	27	236 HiQ	27	236 HiQ
34 (-02)	28	230 808Cip	28	230 808Cip	28	220 RIClap	28	230 808Cip	28	220 RIClap	28	220 RIClap	28	220 RIClap	28	230 808Cip
35 (-03)	29	232 Scrch1	29	232 Scrch1	29	232 Scrch1	29	232 Scrch1	29	232 Scrch1	29	232 Scrch1	29	232 Scrch1	29	232 Scrch1
36 (-04)	30	232 Scrch1	30	232 Scrch1	30	232 Scrch1	30	232 Scrch1	30	232 Scrch1	30	232 Scrch1	30	232 Scrch1	30	232 Scrch1
37 (-05)	31	115 HalStk	31	115 HalStk	31	115 HalStk	31	115 HalStk	31	115 HalStk	31	115 HalStk	31	115 HalStk	31	115 HalStk
38 (-06)	32	221 55Clav	32	221 55Clav	32	221 55Clav	32	221 55Clav	32	197 CngSlp	32	221 55Clav	32	221 55Clav	32	221 55Clav
39 (-07)	33	223 78Beat	33	223 78Beat	33	223 78Beat	33	223 78Beat	33	223 78Beat	33	223 78Beat	33	223 78Beat	33	223 78Beat
40 (-08)	34	223 78Beat	34	223 78Beat	34	223 78Beat	34	223 78Beat	34	223 78Beat	34	223 78Beat	34	223 78Beat	34	223 78Beat
41 (-09)	35	5 DryHdK	35	5 DryHdK	35	5 DryHdK	35	5 DryHdK	35	5 DryHdK	35	34 Easy K	35	44 GubbaK	35	20 WdBrk
42 (-10)	40	58 BechSR	40	58 BechSR	40	58 BechSR	40	58 BechSR	40	58 BechSR	40	85 LImplS	40	109 ElecS1	40	55 Stil SH
43 (-11)	43	122 StdT2S	43	122 StdT2S	43	216 SurdOp	43	143 RingT2	43	137 DbHdT2	43	122 StdT2S	43	149 ElecT2	43	131 BowT2
44 (-12)	47	120 StdT1S	47	120 StdT1S	47	215 SurdMt	47	142 RingT1	47	136 DbHdT1	47	120 StdT1S	47	149 ElecT2	47	130 BowT1
45 (-13)	52	177 ChinaC	52	177 ChinaC	52	177 ChinaC	52	177 ChinaC	52	177 ChinaC	52	177 ChinaC	52	177 ChinaC	52	177 ChinaC
46 (-14)	55	176 SplshC	55	176 SplshC	55	176 SplshC	55	176 SplshC	55	176 SplshC	55	176 SplshC	55	172 CrshC2	55	172 CrshC2
47 (-15)	59	178 RideC1	59	178 RideC1	59	178 RideC1	59	178 RideC1	59	178 RideC1	59	178 RideC1	59	178 RideC1	59	178 RideC1
48 (-16)	71	210 WhisS	71	210 WhisS	71	191 Casta	71	210 WhisS	71	210 WhisS	71	210 WhisS	71	210 WhisS	71	210 WhisS
49 (-17)	72	211 WhisL	72	211 WhisL	72	190 SIBell	72	211 WhisL	72	211 WhisL	72	211 WhisL	72	211 WhisL	72	211 WhisL
50 (-18)	76	193 Wodbk	76	193 Wodbk	76	193 Wodbk	76	193 Wodbk	76	193 Wodbk	76	193 Wodbk	76	193 Wodbk	76	193 Wodbk
51 (-19)	77	193 Wodbk	77	193 Wodbk	77	193 Wodbk	77	193 Wodbk	77	193 Wodbk	77	193 Wodbk	77	193 Wodbk	77	193 Wodbk
52 (-20)	78	213 CuicHi	78	213 CuicHi	78	228 808Clv	78	191 Casta	78	213 CuicHi	78	213 CuicHi	78	213 CuicHi	78	213 CuicHi
53 (-21)	79	214 CuicLo	79	214 CuicLo	79	229 808Mrc	79	190 SIBell	79	214 CuicLo	79	214 CuicLo	79	214 CuicLo	79	214 CuicLo
54 (-22)	80	192 Triang	80	192 Triang	80	192 Triang	80	192 Triang	80	192 Triang	80	192 Triang	80	192 Triang	80	192 Triang
55 (-23)	81	192 Triang	81	192 Triang	81	192 Triang	81	192 Triang	81	192 Triang	81	192 Triang	81	192 Triang	81	192 Triang

Preset Drum Kit List

	No. 49 Ring		No. 50 Light		No. 51 Afro 2		No. 52 Dance 2		No. 53 Delay		No. 54 FingDly		No. 55 Drum&Prc		No. 56 SFX									
Pad No.	Note #	Instrument	Note #	Instrument	Note #	Instrument	Note #	Instrument	Note #	Instrument	Note #	Instrument	Note #	Instrument	Note #	Instrument								
1 (A01)	49	174	StfCrC	49	174	StfCrC	49	172	CrshC2	49	171	CrshC1	49	176	SpshC	49	185	LrgGng	64	236	HiQ			
2 (A02)	57	171	CrshC1	57	171	CrshC1	57	176	SpshC	57	187	TR60C	57	172	CrshC2	57	176	SpshC	65	236	HiQ			
3 (A03)	53	181	RdBIC1	53	181	RdBIC1	53	182	RdBIC2	53	182	RdBIC2	53	182	RdBIC2	53	182	RdBIC2	66	237	TapRwd			
4 (A04)	51	178	RideC1	51	179	RideC2	51	179	RideC2	51	179	RideC2	51	179	RideC2	51	179	RideC2	67	238	PhilHt			
5 (A05)	50	142	RingT1	50	138	LiteT1	50	136	DbHdT1	50	150	808Tom	50	146	RockT1	50	140	RealT1	50	136	DbHdT1	68	239	DncShk
6 (A06)	48	142	RingT1	48	138	LiteT1	48	137	DbHdT2	48	150	808Tom	48	146	RockT1	48	140	RealT1	48	136	DbHdT1	69	240	BeamHQ
7 (A07)	45	143	RingT2	45	139	LiteT2	45	215	SurdMt	45	150	808Tom	45	147	RockT2	45	141	RealT2	45	136	DbHdT1	70	240	BeamHQ
8 (A08)	41	143	RingT2	41	139	LiteT2	41	216	SurdOp	41	150	808Tom	41	147	RockT2	41	141	RealT2	41	137	DbHdT2	71	241	MtISwp
9 (A09)	37	115	HalStk	37	116	NatStk	37	116	NatStk	37	118	808Stk	37	115	HalStk	37	118	808Stk	37	116	NatStk	72	242	AngBrd
10 (A10)	39	85	LtMplS	39	99	BrSlS3	39	56	St SR	39	107	HsDpnS	39	88	PowerS	39	230	808Clp	39	213	CuicHi	73	242	AngBrd
11 (A11)	56	188	Cowbel	56	188	Cowbel	56	188	Cowbel	56	231	808Cow	56	188	Cowbel	56	188	Cowbel	56	188	Cowbel	74	250	LngVrb
12 (A12)	44	154	PedlHH	44	154	PedlHH	44	154	PedlHH	44	235	JnglHh	44	154	PedlHH	44	154	PedlHH	44	154	PedlHH	75	251	GatVrb
13 (A13)	36	7	PillwK	36	35	Soft K	36	26	CompK2	36	51	909 K2	36	29	FvrbK2	36	40	DanceK	36	26	CompK2	76	243	RevKik
14 (A14)	38	94	RngMpS	38	79	AcRimS	38	55	Stl SH	38	108	JgTnyS	38	83	Hall S	38	105	DopInS	38	61	HiPicS	77	244	RevSnr
15 (A15)	42	152	PureCH	42	161	RealCH	42	152	PureCH	42	167	909CHH	42	161	RealCH	42	161	RealCH	42	159	PopCHH	78	245	RevTom
16 (A16)	46	153	PureOH	46	162	RealOH	46	153	PureOH	46	168	909OHH	46	162	RealOH	46	162	RealOH	46	160	PopOHH	79	246	RevCym
17 (B01)	69	209	Cabasa	69	209	Cabasa	69	209	Cabasa	69	239	DncShk	69	209	Cabasa	69	209	Cabasa	69	256	Off	49	172	CrshC2
18 (B02)	75	203	Claves	75	203	Claves	75	203	Claves	75	228	808Clv	75	203	Claves	75	203	Claves	75	241	MtISwp	57	171	CrshC1
19 (B03)	70	207	Marcas	70	207	Marcas	70	207	Marcas	70	229	808Mrc	70	207	Marcas	70	207	Marcas	70	212	Agogo	53	181	RdBIC1
20 (B04)	58	204	Vibslp	58	204	Vibslp	58	204	Vibslp	58	242	AngBrd	58	204	Vibslp	58	204	Vibslp	58	190	SiBell	58	179	RideC2
21 (B05)	67	212	Agogo	67	212	Agogo	67	192	Triang	67	212	Agogo	67	212	Agogo	67	212	Agogo	67	194	BongoH	50	132	AmboT1
22 (B06)	68	212	Agogo	68	212	Agogo	68	192	Triang	68	212	Agogo	68	212	Agogo	68	212	Agogo	68	194	BongoH	48	132	AmboT1
23 (B07)	73	205	GuiroS	73	205	GuiroS	73	212	Agogo	73	224	78Guir	73	205	GuiroS	73	205	GuiroS	73	200	TmbIHl	45	132	AmboT1
24 (B08)	74	206	GuiroL	74	206	GuiroL	74	212	Agogo	74	188	Cowbel	74	206	GuiroL	74	206	GuiroL	74	201	TmbLlO	41	133	AmboT2
25 (B09)	60	194	BongoH	60	194	BongoH	60	194	BongoH	60	238	PhilHt	60	194	BongoH	60	194	BongoH	60	210	WhislS	37	114	AmbStk
26 (B10)	61	195	BongoL	61	195	BongoL	61	195	BongoL	61	240	BeamHQ	61	195	BongoL	61	195	BongoL	61	230	808Clp	39	63	SlDrSS
27 (B11)	66	201	TmbLlO	66	201	TmbLlO	66	201	TmbLlO	66	201	TmbLlO	66	201	TmbLlO	66	201	TmbLlO	64	240	BeamHQ	56	188	Cowbel
28 (B12)	65	200	TmbLlHi	65	200	TmbLlHi	65	200	TmbLlHi	65	200	TmbLlHi	65	200	TmbLlHi	65	200	TmbLlHi	63	256	Off	44	158	16PdHH
29 (B13)	54	189	Tambrn	54	189	Tambrn	54	189	Tambrn	54	189	Tambrn	54	189	Tambrn	54	189	Tambrn	54	217	Tabla1	36	18	Mid K2
30 (B14)	62	196	CngHMT	62	196	CngHMT	62	196	CngHMT	62	246	RevCym	62	196	CngHMT	62	196	CngHMT	62	189	Tambrn	38	66	SlRmSH
31 (B15)	63	198	CngHOp	63	198	CngHOp	63	198	CngHOp	63	190	SiBell	63	198	CngHOp	63	198	CngHOp	66	223	78Beat	42	156	16HOH
32 (B16)	64	199	CngLOp	64	199	CngLOp	64	199	CngLOp	64	225	78Tamb	64	199	CngLOp	64	199	CngLOp	65	206	GuiroL	46	157	16 OHH
33 (-01)	27	236	HiQ	27	236	HiQ	27	236	HiQ	27	236	HiQ	27	236	HiQ	27	236	HiQ	27	236	HiQ	27	236	HiQ
34 (-02)	28	220	RIClap	28	220	RIClap	28	220	RIClap	28	220	RIClap	28	220	RIClap	28	220	RIClap	28	220	RIClap	28	220	RIClap
35 (-03)	29	232	Scrch1	29	232	Scrch1	29	232	Scrch1	29	233	Scrch2	29	232	Scrch1	29	232	Scrch1	29	232	Scrch1	29	232	Scrch1
36 (-04)	30	232	Scrch1	30	232	Scrch1	30	232	Scrch1	30	233	Scrch2	30	232	Scrch1	30	232	Scrch1	30	232	Scrch1	30	232	Scrch1
37 (-05)	31	115	HalStk	31	115	HalStk	31	115	HalStk	31	115	HalStk	31	115	HalStk	31	115	HalStk	31	115	HalStk	31	115	HalStk
38 (-06)	32	221	55Clav	32	221	55Clav	32	221	55Clav	32	221	55Clav	32	221	55Clav	32	221	55Clav	32	221	55Clav	32	221	55Clav
39 (-07)	33	223	78Beat	33	223	78Beat	33	223	78Beat	33	246	RevCym	33	223	78Beat	33	223	78Beat	33	223	78Beat	33	223	78Beat
40 (-08)	34	223	78Beat	34	223	78Beat	34	223	78Beat	34	239	DncShk	34	223	78Beat	34	223	78Beat	34	223	78Beat	34	223	78Beat
41 (-09)	35	15	Real K	35	34	Easy K	35	9	VntgK2	35	49	808BmK	35	14	MpRvbK	35	41	Rap K1	35	5	DryHDk	35	2	RIrDryK
42 (-10)	40	90	RckRmS	40	61	HiPicS	40	60	PiccSH	40	113	TR909S	40	84	Hard S	40	102	SwingS	40	87	NatrFS	40	65	SlRmSS
43 (-11)	43	143	RingT2	43	139	LiteT2	43	137	DbHdT2	43	150	808Tom	43	147	RockT2	43	141	RealT2	43	123	StdT2H	43	133	AmboT2
44 (-12)	47	142	RingT1	47	138	LiteT1	47	137	DbHdT2	47	150	808Tom	47	146	RockT1	47	140	RealT1	47	121	StdT1H	47	132	AmboT1
45 (-13)	52	177	ChinaC	52	177	ChinaC	52	177	ChinaC	52	170	78 OHH	52	177	ChinaC	52	177	ChinaC	52	177	ChinaC	52	177	ChinaC
46 (-14)	55	172	CrshC2	55	172	CrshC2	55	176	SpshC	55	176	SpshC	55	172	CrshC2	55	172	CrshC2	55	176	SpshC	54	189	Tambrn
47 (-15)	59	178	RideC1	59	178	RideC1	59	178	RideC1	59	178	RideC1	59	178	RideC1	59	178	RideC1	59	178	RideC1	59	178	SpshC
48 (-16)	71	210	WhislS	71	210	WhislS	71	210	WhislS	71	210	WhislS	71	210	WhislS	71	210	WhislS	71	210	WhislS	58	204	Vibslp
49 (-17)	72	211	WhislL	72	211	WhislL	72	211	WhislL	72	211	WhislL	72	211	WhislL	72	211	WhislL	72	211	WhislL	59	178	RideC1
50 (-18)	76	193	Wodblk	76	193	Wodblk	76	193	Wodblk	76	193	Wodblk	76	193	Wodblk	76	193	Wodblk	76	193	Wodblk	60	194	BongoH
51 (-19)	77	193	Wodblk	77	193	Wodblk	77	193	Wodblk	77	193	Wodblk	77	193	Wodblk	77	193	Wodblk	77	193	Wodblk	61	195	BongoL
52 (-20)	78	213	CuicHi	78	213	CuicHi	78	213	CuicHi	78	213	CuicHi	78	213	CuicHi	78	213	CuicHi	78	213	CuicHi	62	196	CngHMT
53 (-21)	79	214	CuicLo	79	214	CuicLo	79	214	CuicLo	79	214	CuicLo	79	214	CuicLo	79	214	CuicLo	79	214	CuicLo	63	198	CngHOp
54 (-22)	80	192	Triang	80	192	Triang	80	192	Triang	80	192	Triang	80	192	Triang	80	192	Triang	80	192	Triang	80	192	Triang
55 (-23)	81	192	Triang	81	192	Triang	81	192	Triang	81	192	Triang	81	192	Triang	81	192	Triang	81	192	Triang	81	192	Triang

	No. 57 CtryBas		No. 58 SmbaBas		No. 59 BluzBas		No. 60 RockBas		No. 61 FunkBas		No. 62 BrshBas		No. 63 SynBass		No. 64 AcoBass	
Pad No.	Note #	Instrument	Note #	Instrument	Note #	Instrument	Note #	Instrument	Note #	Instrument	Note #	Instrument	Note #	Instrument	Note #	Instrument
1 (A01)	49	171 CrshC1	69	209 Cabasa	64	253 FingBs	64	254 SlapBs	49	171 CrshC1	64	252 AcouBs	64	255 303 Bs	49	174 SftCrC
2 (A02)	57	172 CrshC2	75	203 Claves	65	253 FingBs	65	254 SlapBs	57	177 ChinaC	65	252 AcouBs	65	255 303 Bs	57	172 CrshC2
3 (A03)	53	182 RdBIC2	70	207 Marcas	66	253 FingBs	66	254 SlapBs	53	182 RdBIC2	66	252 AcouBs	66	255 303 Bs	53	181 RdBIC1
4 (A04)	51	179 RideC2	58	204 Vibslp	67	253 FingBs	67	254 SlapBs	51	179 RideC2	67	252 AcouBs	67	255 303 Bs	51	180 SziRdC
5 (A05)	50	140 RealT1	71	252 AcouBs	68	253 FingBs	68	254 SlapBs	50	120 StdT1S	68	252 AcouBs	68	255 303 Bs	50	126 JazzT1
6 (A06)	48	140 RealT1	72	252 AcouBs	69	253 FingBs	69	254 SlapBs	48	120 StdT1S	69	252 AcouBs	69	255 303 Bs	48	126 JazzT1
7 (A07)	45	140 RealT1	73	252 AcouBs	70	253 FingBs	70	254 SlapBs	45	120 StdT1S	70	252 AcouBs	70	255 303 Bs	45	127 JazzT2
8 (A08)	41	141 RealT2	74	252 AcouBs	71	253 FingBs	71	254 SlapBs	41	122 StdT2S	71	252 AcouBs	71	255 303 Bs	41	127 JazzT2
9 (A09)	37	116 NatStk	60	194 BongoH	72	253 FingBs	72	254 SlapBs	37	116 NatStk	72	252 AcouBs	72	255 303 Bs	37	116 NatStk
10 (A10)	39	220 RiClap	61	195 BongoL	73	253 FingBs	73	254 SlapBs	39	75 Dry SS	73	252 AcouBs	73	255 303 Bs	39	79 AcRimS
11 (A11)	56	188 Cowbel	66	201 TmbLLo	74	253 FingBs	74	254 SlapBs	56	188 Cowbel	74	252 AcouBs	74	255 303 Bs	56	188 Cowbel
12 (A12)	44	154 PedLHH	65	200 TmbLHi	75	253 FingBs	75	254 SlapBs	44	154 PedLHH	75	252 AcouBs	75	255 303 Bs	44	154 PedLHH
13 (A13)	36	12 MapleK	54	189 Tambrn	76	253 FingBs	76	254 SlapBs	36	12 MapleK	76	252 AcouBs	76	255 303 Bs	36	11 JazzK2
14 (A14)	38	73 DrFatS	62	196 CngHMT	77	253 FingBs	77	254 SlapBs	38	77 Wet S	77	252 AcouBs	77	255 303 Bs	38	86 LooseS
15 (A15)	42	161 RealCH	63	198 CngHOP	78	253 FingBs	78	254 SlapBs	42	161 RealCH	78	252 AcouBs	78	255 303 Bs	42	152 PureCH
16 (A16)	46	162 RealOH	64	199 CngLOp	79	253 FingBs	79	254 SlapBs	46	162 RealOH	79	252 AcouBs	79	255 303 Bs	46	153 PureOH
17 (B01)	64	252 AcouBs	49	171 CrshC1	49	171 CrshC1	49	172 CrshC2	64	254 SlapBs	49	183 BrCrS	49	187 TR606C	64	252 AcouBs
18 (B02)	65	252 AcouBs	57	172 CrshC2	57	173 CrshC3	57	177 ChinaC	65	254 SlapBs	57	174 SftCrC	57	171 CrshC1	65	252 AcouBs
19 (B03)	66	252 AcouBs	53	182 RdBIC2	53	182 RdBIC2	53	181 RdBIC1	66	254 SlapBs	53	182 RdBIC2	53	182 RdBIC2	66	252 AcouBs
20 (B04)	67	252 AcouBs	51	179 RideC2	51	180 SziRdC	51	179 RideC2	67	254 SlapBs	51	184 BrRidC	51	179 RideC2	67	252 AcouBs
21 (B05)	68	252 AcouBs	50	120 StdT1S	50	126 JazzT1	50	132 AmboT1	68	254 SlapBs	50	134 BrshT1	50	151 909Tom	68	252 AcouBs
22 (B06)	69	252 AcouBs	48	120 StdT1S	48	126 JazzT1	48	132 AmboT1	69	254 SlapBs	48	134 BrshT1	48	151 909Tom	69	252 AcouBs
23 (B07)	70	252 AcouBs	45	120 StdT1S	45	126 JazzT1	45	132 AmboT1	70	254 SlapBs	45	134 BrshT1	45	151 909Tom	70	252 AcouBs
24 (B08)	71	252 AcouBs	41	122 StdT2S	41	127 JazzT2	41	133 AmboT2	71	254 SlapBs	41	135 BrshT2	41	151 909Tom	71	252 AcouBs
25 (B09)	72	252 AcouBs	37	116 NatStk	37	116 NatStk	37	114 AmbStk	72	254 SlapBs	37	116 NatStk	37	119 909Stk	72	252 AcouBs
26 (B10)	73	252 AcouBs	39	53 Mid SS	39	53 Mid SS	39	63 SiDrSS	73	254 SlapBs	39	97 BrSIS1	39	102 SwingS	73	252 AcouBs
27 (B11)	74	252 AcouBs	56	188 Cowbel	56	188 Cowbel	56	188 Cowbel	74	254 SlapBs	56	188 Cowbel	56	231 808Cow	74	252 AcouBs
28 (B12)	75	252 AcouBs	44	154 PedLHH	44	154 PedLHH	44	158 16PdHH	75	254 SlapBs	44	154 PedLHH	44	168 909OHH	75	252 AcouBs
29 (B13)	76	252 AcouBs	36	4 DryMdK	36	11 JazzK2	36	18 Mid K2	76	254 SlapBs	36	8 VntgK1	36	52 909HdK	76	252 AcouBs
30 (B14)	77	252 AcouBs	38	54 Mid SR	38	67 DryHdS	38	66 SiRmSH	77	254 SlapBs	38	96 BrRIS2	38	113 TR909S	77	252 AcouBs
31 (B15)	78	252 AcouBs	42	152 PureCH	42	152 PureCH	42	156 16HfOH	78	254 SlapBs	42	152 PureCH	42	167 909CHH	78	252 AcouBs
32 (B16)	79	252 AcouBs	46	153 PureOH	46	153 PureOH	46	157 16 OHH	79	254 SlapBs	46	153 PureOH	46	168 909OHH	79	252 AcouBs
33 (-01)	27	236 HiQ	27	236 HiQ	27	236 HiQ	27	236 HiQ	27	236 HiQ	27	236 HiQ	27	236 HiQ	27	236 HiQ
34 (-02)	28	220 RiClap	28	220 RiClap	28	220 RiClap	28	220 RiClap	28	220 RiClap	28	220 RiClap	28	220 RiClap	28	220 RiClap
35 (-03)	29	232 Scrch1	29	232 Scrch1	29	232 Scrch1	29	232 Scrch1	29	232 Scrch1	29	232 Scrch1	29	233 Scrch2	29	232 Scrch1
36 (-04)	30	232 Scrch1	30	232 Scrch1	30	232 Scrch1	30	232 Scrch1	30	232 Scrch1	30	232 Scrch1	30	233 Scrch2	30	232 Scrch1
37 (-05)	31	115 HalStk	31	115 HalStk	31	115 HalStk	31	115 HalStk	31	115 HalStk	31	115 HalStk	31	115 HalStk	31	115 HalStk
38 (-06)	32	221 55Clav	32	221 55Clav	32	221 55Clav	32	221 55Clav	32	221 55Clav	32	221 55Clav	32	221 55Clav	32	221 55Clav
39 (-07)	33	223 78Beat	33	223 78Beat	33	223 78Beat	33	223 78Beat	33	223 78Beat	33	223 78Beat	33	246 RevCym	33	223 78Beat
40 (-08)	34	223 78Beat	34	223 78Beat	34	223 78Beat	34	223 78Beat	34	223 78Beat	34	223 78Beat	34	239 DncShk	34	223 78Beat
41 (-09)	35	22 HbrdK2	35	8 VntgK1	35	22 HbrdK2	35	22 HbrdK2	35	22 HbrdK2	35	10 JazzK1	35	49 808BmK	35	10 JazzK1
42 (-10)	40	61 HiPicS	40	62 OpnRmS	40	61 HiPicS	40	61 HiPicS	40	61 HiPicS	40	100 BrSwiS	40	112 808 S2	40	98 BrSIS2
43 (-11)	43	141 RealT2	43	122 StdT2S	43	122 StdT2S	43	122 StdT2S	43	122 StdT2S	43	135 BrshT2	43	150 808Tom	43	122 StdT2S
44 (-12)	47	140 RealT1	47	120 StdT1S	47	120 StdT1S	47	120 StdT1S	47	120 StdT1S	47	134 BrshT1	47	150 808Tom	47	120 StdT1S
45 (-13)	52	177 ChinaC	52	177 ChinaC	52	177 ChinaC	52	177 ChinaC	52	172 CrshC2	52	177 ChinaC	52	177 ChinaC	52	177 ChinaC
46 (-14)	54	189 Tambrn	55	176 SplshC	54	189 Tambrn	54	189 Tambrn	54	189 Tambrn	54	189 Tambrn	54	189 Tambrn	54	189 Tambrn
47 (-15)	55	176 SplshC	59	178 RideC1	55	176 SplshC	55	176 SplshC	55	176 SplshC	55	176 SplshC	55	176 SplshC	55	176 SplshC
48 (-16)	58	204 Vibslp	67	212 Agogo	58	204 Vibslp	58	204 Vibslp	58	204 Vibslp	58	204 Vibslp	58	204 Vibslp	58	204 Vibslp
49 (-17)	59	178 RideC1	68	212 Agogo	59	178 RideC1	59	178 RideC1	59	178 RideC1	59	178 RideC1	59	178 RideC1	59	178 RideC1
50 (-18)	60	194 BongoH	76	193 Wodbik	60	194 BongoH	60	194 BongoH	60	194 BongoH	60	194 BongoH	60	194 BongoH	60	194 BongoH
51 (-19)	61	195 BongoL	77	193 Wodbik	61	195 BongoL	61	195 BongoL	61	195 BongoL	61	195 BongoL	61	195 BongoL	61	195 BongoL
52 (-20)	62	196 CngHMT	78	213 CuicHi	62	196 CngHMT	62	196 CngHMT	62	196 CngHMT	62	196 CngHMT	62	196 CngHMT	62	196 CngHMT
53 (-21)	63	198 CngHOP	79	214 CuicLo	63	198 CngHOP	63	198 CngHOP	63	198 CngHOP	63	198 CngHOP	63	198 CngHOP	63	198 CngHOP
54 (-22)	80	192 Triang	80	192 Triang	80	192 Triang	80	192 Triang	80	192 Triang	80	192 Triang	80	192 Triang	80	192 Triang
55 (-23)	81	192 Triang	81	192 Triang	81	192 Triang	81	192 Triang	81	192 Triang	81	192 Triang	81	192 Triang	81	192 Triang

Preset Pattern List

This consists of only the Original Patterns. The other Patterns are shown as follows;

- Original Pattern's number +1 → Fill-in to Variation
- Original Pattern's number +2 → Variation
- Original Pattern's number +3 → Fill-in to Original

No.	Display	(Recommend) Tempo	Pattern Name
1	HdRck1O	136	Hard Rock 1
5	HdRck2O	120	Hard Rock 2
9	HdRck3O	120	Hard Rock 3
13	HdRck4O	120	Hard Rock 4
17	HdRck5O	160	Hard Rock 5
21	HdRck6O	162	Hard Rock 6
25	HdRck7O	110	Hard Rock 7
29	Heavy1O	120	Heavy Metal 1
33	Heavy2O	130	Heavy Metal 2
37	FastHRO	120	Fast Hard Rock
41	PunkBsO	100	Punk Bass
45	Rock1 O	120	Rock 1
49	Rock2 O	130	Rock 2
53	Rock3 O	130	Rock 3
57	Rock4 O	140	Rock 4
61	Rock5 O	156	Rock 5
65	Rock6 O	170	Rock 6
69	Rock7 O	93	Rock 7
73	Rock8 O	120	Rock 8
77	AcoRckO	110	Acoustic Rock
81	EleRckO	130	Electronic Rock
85	RockBsO	90	Rock Bass
89	8Feel1O	120	8th Note Feel 1
93	8Feel2O	120	8th Note Feel 2
97	8Feel3O	120	8th Note Feel 3
101	16Fel1O	120	16th Note Feel 1
105	16Fel2O	120	16th Note Feel 2
109	ShffleO	130	Shuffle
113	6/8FeO	120	6/8 Feel
117	Balad1O	104	Ballade 1
121	Balad2O	120	Ballade 2
125	RkablyO	80	Rockabilly
129	BluGrsO	125	Bluegrass
133	Cntry1O	120	Country 1
137	Cntry2O	120	Country 2
141	CtryBsO	100	Country Bass
145	Funk1 O	150	Funk 1

No.	Display	(Recommend) Tempo	Pattern Name
149	Funk2 O	120	Funk 2
153	Funk3 O	120	Funk 3
157	Funk4 O	114	Funk 4
161	FunkBsO	112	Funk Bass
165	Blues O	120	Blues
169	MedBlzO	120	Medium Blues
173	6/8BlzO	100	6/8 Blues
177	Soul1 O	114	Soul 1
181	Soul2 O	125	Soul 2
185	Soul3 O	90	Soul 3
189	Gosp1O	120	Gospel 1
193	Gosp12O	120	Gospel 2
197	Jazz1 O	120	Jazz 1
201	Jazz2 O	132	Jazz 2
205	Brush O	150	Brush
209	BigBndO	120	Big Band
213	JzWltzO	130	Jazz Waltz
217	5Jazz O	150	Jazz in 5
221	Fuse1 O	120	Fusion 1
225	Fuse2 O	100	Fusion 2
229	Fuse3 O	135	Fusion 3
233	Fuse4 O	110	Fusion 4
237	GrvIn6O	120	Groove In 6
241	SmthJzO	100	Smooth Jazz
245	HvyFnkO	120	Heavy Funk
249	TechFsO	120	Technical Fusion
253	HipHp1O	98	Hip Hop 1
257	HipHp2O	122	Hip Hop 2
261	HipHp3O	95	Hip Hop 3
265	HipHp4O	115	Hip Hop 4
269	DrmBs1O	160	Drum 'n' Bass 1
273	DrmBs2O	160	Drum 'n' Bass 2
277	DrmBs3O	140	Drum 'n' Bass 3
281	Tchno1O	130	Techno 1
285	Tchno2O	140	Techno 2
289	House1O	130	House 1
293	House2O	140	House 2

No.	Display	(Recommend) Tempo	Pattern Name
297	Boom O	140	Boom
301	Disco O	110	Disco
305	Bossa1O	130	Bossa Nova 1
309	Bossa2O	130	Bossa Nova 2
313	Samba1O	120	Samba 1
317	Samba2O	120	Samba 2
321	Samba3O	140	Samba 3
325	SmbaBsO	115	Samba Bass
329	Salsa1O	95	Salsa 1
333	Salsa2O	100	Salsa 2
337	Mambo O	110	Mambo
341	MerengeO	145	Merenge
345	LtPop1O	130	Latin Pop 1
349	LtPop2O	120	Latin Pop 2
353	LtPop3O	95	Latin Pop 3
357	Regae1O	150	Reggae 1
361	Regae2O	150	Reggae 2
365	Regae3O	150	Reggae 3
369	Regae4O	172	Reggae 4
373	Songo1O	115	Songo 1
377	Songo2O	115	Songo 2
381	Polka O	120	Polka
385	India1O	135	India 1
389	India2O	110	India 2
393	Afro1 O	142	Afro 1
397	Afro2 O	115	Afro 2

1. RECOGNIZED RECEIVE DATA

■ Channel Voice Message

● Note On

Status	Second	Third
9nH	kkH	vvH
n = MIDI Channel No.:		0H - FH (ch.1 - ch.16)
kk = Note No.:		1BH - 51H (27 - 81)
vv = Velocity:		01H - 7FH (1 - 127)

● Control Change

○ Expression

Recognized when RxEXPR is set to "ON" in MIDI mode.

Status	Second	Third
BnH	0BH	vvH
n = MIDI Channel No.:		0H - FH (ch.1 - ch.16)
vv = Expression:		00H - 7FH (0 - 127)

○ Volume

Recognized when RxVOL is set to "ON" in MIDI mode.

Status	Second	Third
BnH	07H	vvH
n = MIDI Channel No.:		0H - FH (ch.1 - ch.16)
vv = Volume:		00H - 7FH (0 - 127)

- * Controls total volume.

● Program Change

Recognized when PRG is set to "ON" in MIDI mode.

Status	Second	Third
CnH	ppH	
n = MIDI Channel No.:		0H - FH (ch.1 - ch.16)
pp = Program Number:		00H - 7FH (prog.1 - prog.128)

- * Receiving program change switches the Drum kit.
- * The first Note On after receiving a Program change sounds a voice with a new tone with exception of the voices which have been sounded before the Program change is received.
- * Indicates correspondence between Program number and Drum kit as follows.

Program number	Drum kit
prog.1	1
prog.2	2
:	:
prog.128	128

■ System Exclusive Messages

Status	Data Bytes	Status
F0H	iiH, ddH, ..., eeH	F7H
F0H:	Status of System Exclusive Message	
ii = ID number:	41 = Roland	
	7E = Universal Non-Realtime Message	
	7F = Universal Realtime Message	
dd, ..., ee = Data:	00H - 7FH (0 - 127)	
F7H:	EOX (End Of Exclusive)	

● Data Request (RQ1)

Byte	Description
F0H	Status of System Exclusive Messages
41H	Manufacturer ID (Roland)
dev	Device ID (00H - 0FH)
00H	Model ID MSB (DR-770)
1CH	Model ID LSB (DR-770)
11H	Command ID (RQ1)
aaH	Address MSB
aaH	Address
aaH	Address
aaH	Address LSB
ssH	Size MSB
ssH	Size
ssH	Size
ssH	Size LSB
sum	Check Sum
F7H	EOX (End of System Exclusive Message)

- * Device ID is the value set by MIDIch in MIDI mode. Actual Device ID is smaller than the MIDIch number by 1.

- * The DR-770 receives Data Request message only when sequencer is in stop and MIDI Bulk dump is not performed.

● Data Set (DT1)

Byte	Description
F0H	Status of System Exclusive Messages
41H	Manufacturer ID (Roland)
dev	Device ID (00H - 0FH)
00H	Model ID MSB (DR-770)
1CH	Model ID LSB (DR-770)
12H	Command ID (DT1)
aaH	Address MSB
aaH	Address
aaH	Address
aaH	Address LSB
ddH	Data MSB
:	:
ddH	Data LSB
sum	Check Sum
F7H	EOX (End of System Exclusive Message)

- * Device ID is smaller the MIDIch number by 1 in MIDI mode.

- * The DR-770 receives Data Set message only when MIDI Bulk dump is not performed and it is in stop.

● Universal Non-Realtime System Exclusive Message

○ Identity Request

Status	Data Bytes	Status
F0H	7EH, dev, 06H, 01H	F7H

Byte	Description
F0H	Status of System Exclusive Messages
7EH	ID Number (Universal Non-Realtime Message)
dev	Device ID (00H-0FH(0-15) or 7FH(Broadcast))
06H	Sub ID#1 (General Information)
01H	Sub ID#2 (Identity Request)
F7H	EOX (End of System Exclusive Message)

- * When Identity Request message is received, Identity Reply message will be transmitted.

- * Device ID is smaller the MIDIch number by 1 in MIDI mode.

- * Reply is executed by the unique Device ID when Device ID receives the "Identity Request message" in the Broadcast (7FH).

■ System Common Messages

Recognized only when the DR-770 is in stop and "SYNC" of the MIDI mode is set at MIDI.

● Song Position Pointer

Status	Second	Third
F2H	llH	mmH
mm, ll = Value: 00H, 00H - 7FH, 7FH (0 - 16383)		

- * Only in Song Play mode, the DR-770 receives Song Position Pointer, and locates the position in the song.

● Song Select

Status	Second
F3H	ssH
ss = Song number: 00H - 63H (0 - 99)	

- * When received in Song mode, it changes the songs.
- * Indicates correspondence between Song number and Song as follows.

Song number	Song
0	1
1	2
:	:
99	100

■ System Realtime Message

Recognized only when "SYNC" of the MIDI mode is set at MIDI.

● Timing Clock

Status
F8H

● Start

Status
FAH

● Continue

Status
FBH

● Stop

Status
FCH

2. TRANSMITTED DATA

■ Channel Voice Message

● Note Off

Status	Second	Third
9n	kkH	00H
n = MIDI Channel No.:		0H - FH (ch.1 - ch.16)
kk = Note No.:		1BH - 51H (27 - 81)

● Note On

Status	Second	Third
9nH	kkH	vvH
n = MIDI Channel No.:		0H - FH (ch.1 - ch.16)
kk = Note No.:		1BH - 51H (27 - 81)
vv = Velocity:		01H - 7FH (1 - 127)

- * Note number assigned to each instrument at current Drum kit is used.
- * The data is transmitted by MIDI channel using the value set by MIDIch in MIDI mode.
- * Gate time (the interval from "Note On" to "Note Off") is about 50msec. It may be shortened when same instrument is sounded repeatedly in short interval.

● Control Change

▷ Volume

Transmitted when RxVOL is set to 'ON' in MIDI mode.

Status	Second	Third
BnH	07H	vvH
n = MIDI Channel No.:		0H - FH (ch.1 - ch.16)
vv = Volume:		00H - 7FH (0 - 127)

- * If a value of RxVOL in the MIDI mode is changed, the DR-770 transmit this message by the MIDI channel set by MIDIch in MIDI mode.

● Program Change

Transmitted when PRG is set to "ON" in the MIDI mode.

Status	Second
CnH	ppH
n = MIDI Channel No.: 0H - FH (ch.1 - ch.16)	
pp = Program Number: 00H - 7FH (prog.1 - prog.128)	

- * The Program change will be transmitted on the MIDI channel set by "MIDIch" in the MIDI mode if the Drum kit is changed.
- * Indicates correspondence between Drum kit and Program number as follows.

Drum kit	Program number
1	prog.1
2	prog.2
:	:
128	prog.128

■ System Exclusive Messages

Status	Data Bytes	Status
F0H	iiH, ddH, ..., eeH	F7H
F0H: Status of System Exclusive Message		
ii = ID number: 41 = Roland		
7E = Universal Non-Realtime Message		
7F = Universal Realtime Message		
dd, ..., ee = Data: 00H - 7FH (0 - 127)		
F7H: EOX (End Of Exclusive)		

●Data Set (DT1)

Byte	Description
F0H	Status of System Exclusive Messages
41H	Manufacturer ID (Roland)
dev	Device ID (00H - 0FH)
00H	Model ID MSB (DR-770)
1CH	Model ID LSB (DR-770)
12H	Command ID (DT1)
aaH	Address MSB
aaH	Address
aaH	Address
aaH	Address LSB
ddH	Data MSB
:	:
ddH	Data LSB
sum	Check Sum
F7H	EOX (End of System Exclusive Message)

- * Device ID is smaller the MIDIch number by 1 in MIDI mode.
- * Data Set message is transmitted when MIDI Bulk dump is performed in MIDI mode.

●Universal Non-Realtime System Exclusive Message

○Identity Reply

Status	Data Bytes	Status
F0H	7EH,dev,06H,02H	F7H
	41H,1CH,01H,00H,00H	
	00H,02H,00H,00H	

Byte	Description
F0H	Status of System Exclusive Messages
7EH	ID Number (Universal Non-Realtime Message)
dev	Device ID (00H-0FH(0-15) or 7FH(Broadcast))
06H	Sub ID #1 (General Information)
02H	Sub ID #2 (Identity Reply)
41H	Manufacturer (Roland)
1CH,01H	Device Family Code
00H,00H	Device Family Number Code
00H,02H,00H,00H	Software Revision Level
F7H	EOX (End of System Exclusive Message)

- * Device ID is smaller the MIDIch number by 1 in MIDI mode.
- * When Identity Request message is received, Identity Reply message will be transmitted.

■System Common Message

Not transmitted when "SYNC" of the MIDI mode is set at MIDI.

●Song Position Pointer

Status	Second	Third
F2H	11H	mmH

mm.ll = Value: 00H,00H - 7FH,7FH (0 - 16383)

- * Transmitted when the PART is specified by pressing RWD or FWD in SONG mode.

●Song Select

Status	Second
F3H	ssH

ss = Song number: 00H - 63H (0 - 99)

- * Transmitted when SONG mode is selected or new song is selected in SONG mode.
- * Indicates correspondence between Song and Song number as follows.

Song	Song number
0	1
1	2
:	:
99	100

■System Realtime Message

Not transmitted when "SYNC" of the MIDI mode is set at MIDI.
When RESET is pressed with the DR-770 in playing, Stop and Start messages are transmitted continuously.

●Timing Clock

Status
F8H

●Start

Status
FAH

●Continue

Status
FBH

●Stop

Status
FCH

●Active Sensing

Status
FEH

- * Transmitted about 250 msec interval.

3. Messages stored in patterns

■ Channel Voice Message

● Note On

Status	Second	Third
9nH	kkH	vvH
n = MIDI Channel No.:		0H - FH (ch.1 - ch.16)
kk = Note No.:		1BH - 51H (27 - 81)
vv = Velocity:		01H - 7FH (1 - 127)

* Velocity is converted and stored in a pattern.

Received velocity	Memorized velocity
1 - 7	1
8 - 11	2
12 - 15	3
16 - 19	4
20 - 23	5
24 - 27	6
28 - 31	7
32 - 35	8
36 - 39	9
40 - 43	10
44 - 47	11
48 - 51	12
52 - 55	13
56 - 59	14
60 - 63	15
64 - 67	16
68 - 71	17
72 - 75	18
76 - 79	19
80 - 83	20
84 - 87	21
88 - 91	22
92 - 95	23
96 - 99	24
100 - 103	25
104 - 107	26
108 - 111	27
112 - 115	28
116 - 119	29
120 - 123	30
124 - 127	31

* In transmitting, velocity memorized in a pattern is converted as follows.

Memorized velocity	Transmitted velocity
1	7
2	11
3	15
4	19
5	23
6	27
7	31
8	35
9	39
10	43
11	47
12	51
13	55
14	59
15	63
16	67
17	71
18	75
19	79
20	83
21	87
22	91
23	95
24	99
25	103
26	107
27	111
28	115
29	119
30	123
31	127

4. Parameter Address Map

Address are shown in every 7-bit hexadecimal.

Address	MSB			LSB
Binary	0aaa aaaa	0bbb bbbb	0ccc cccc	0ddd dddd
7 bit hex.	AA	BB	CC	DD

■ Parameter base address

With the DR-770, the parameters can be transferred either by bulk dump or by individual parameter control.

By individual address, each parameter can be received and transmitted individually.

By bulk address, the plural parameters as one group are received and transmitted.

By individually, only current Drum kit(selected)parameter and global parameter can be received and transmitted.

Start Address	Block	Note
00 00 00 00	Current Drum kit	Individual
01 00 00 00	Global Parameters	Individual
02 00 00 00	All User Drum kits	Bulk
03 00 00 00	All Songs	Bulk
04 00 00 00	All User Patterns	Bulk

● Current Drum kit (Individual)

This is the data on currently selected Drum kit.

○ Pad

pp=pad number 00H - 36H (A01 - A16, B01 - B16, -01 - -23)

Offset Address(H)	Data(H)	Description
00 00 pp 00	00 - FF	Instrument number upper 4bits (1 - 256) *1
00 00 pp 01		Instrument number lower 4bits *1
00 00 pp 02	00 - 0F	Level (0 - 15)
00 00 pp 03	00 - 0E	Nuance (-7 - -7)
00 00 pp 04	0000 - 01E0	Pitch upper 2bits (-2400 - -2400, 10step) *2
00 00 pp 05		Pitch lower 7bits *2
00 00 pp 06	00 - 3E	Decay (-31 - +31)
00 00 pp 07	00 - 0F	Pan (L7 - C - R7, INDIV)
00 00 pp 08	00 - 01	Polyphony (MONO, POLY) *3
00 00 pp 09	00 - 07	Assign Group (OFF, EXC1-7) *3
00 00 pp 0A	00 - 09	Reverb Send Level/IND Level (0 - 9)
00 00 pp 0B	00 - 09	Flanger Send Level (0 - 9)

*1 Instrument number is transferred by dividing value 00H - FFH into 4bit MSB and 4bit LSB.

*2 Pitch is expressed -2400 as 0000H and it is transferred by dividing value into 2bit MSB and 7bit LSB.

*3 With combination of Polyphony and Assign Group, A.TYPE is defined as follows.

Polyphony	Assign Group	A. TYPE
0 (MONO)	0 (OFF)	MONO
0 (MONO)	1 (EXC1)	M EXC1
0 (MONO)	2 (EXC2)	M EXC2
0 (MONO)	3 (EXC3)	M EXC3
0 (MONO)	4 (EXC4)	M EXC4
0 (MONO)	5 (EXC5)	M EXC5
0 (MONO)	6 (EXC6)	M EXC6
0 (MONO)	7 (EXC7)	M EXC7
1 (POLY)	0 (OFF)	POLY
1 (POLY)	1 (EXC1)	P EXC1
1 (POLY)	2 (EXC2)	P EXC2
1 (POLY)	3 (EXC3)	P EXC3
1 (POLY)	4 (EXC4)	P EXC4
1 (POLY)	5 (EXC5)	P EXC5
1 (POLY)	6 (EXC6)	P EXC6
1 (POLY)	7 (EXC7)	P EXC7

○Note Number Assign

pp=pad number 00H - 36H (A01 - A16, B01 - B16, -01 - -23)

Offset	Address(H)	Data(H)	Description
00 01 pp 00	1B	51	Note number (27 - 81)

○Effect

Offset	Address(H)	Data(H)	Description
00 02 00 00	00	04	Reverb Type (HALL, ROOM, PLATE, DELAY, FAN-DLY)
00 02 00 01	00	1F	Reverb Time (0 - 31)
00 02 00 02	00	07	Reverb LFF (0 - 7)
00 02 00 03	00	0F	Delay Feedback (0 - 15)
00 02 00 04	00	09	Reverb Output Level (0 - 9)
00 02 00 05	00	01	Reverb Output SW (Reverb, IND)
00 02 00 06	00	01	Flanger Type (CHORUS, FLANGER)
00 02 00 07	00	1F	Flanger Delay time (0 - 31)
00 02 00 08	00	0F	Flanger Depth (0 - 15)
00 02 00 09	00	0F	Flanger Rate (0 - 15)
00 02 00 0A	00	0F	Flanger Feedback (0 - 15)
00 02 00 0B	00	09	Flanger Output Level (0 - 9)
00 02 00 0C	00	0C	EQ High Gain (-12dB - +12dB, 2dB step)
00 02 00 0D	00	0C	EQ Low Gain (-12dB - +12dB, 2dB step)

○Sensitivity Curve, Pad Bank Layer

Offset	Address(H)	Data(H)	Description
00 03 00 00	00	07	Sensitivity Curve Pad Bank-A
(EXP1, LIN1, EXP2, LIN2, XFDO, XFDI, FIX1, FIX2)	00 03 00 01	00	Sensitivity Curve Pad Bank-B
(EXP1, LIN1, EXP2, LIN2, XFDO, XFDI, FIX1, FIX2)	00 03 00 02	00	Pad Bank Layer SW (OFF, ON) *3

* 3 When set to ON, Pad bank is layered.

○Drum kit Name

Offset	Address(H)	Data(H)	Description
00 04 00 00	20	7F	Name.1
:	:	:	:
00 04 00 06	20	7F	Name.7

●Global (Individual)

○MIDI SW

Offset	Address(H)	Data(H)	Description
01 00 00 00	00	01	Sync Mode (INT, MIDI)
01 00 00 01	00	01	Program Change SW (OFF, ON)
01 00 00 02	00	01	Rx Volume SW (OFF, ON)
01 00 00 03	00	01	Rx Expression SW (OFF, ON)
01 00 00 04	00	01	Soft Through SW (OFF, ON)

○Roll, Flam, Metronome

Offset	Address(H)	Data(H)	Description
01 01 00 00	01	09	Roll Type (1/32, 1/16(3), 1/16, 1/8(3), 1/8, 1/4(3), 1/4, 1/2, FL)
01 01 00 01	00	1F	Flam Interval (0 - 31)
01 01 00 02	00	07	Flam Ratio (0 - 7)
01 01 00 03	00	07	Click Level (0 - 7)
01 01 00 04	03	07	Click Select (1/16, 1/8(3), 1/8, 1/4(3), 1/4)

○Direct Pattern Play

pp=pad number 00H - 0FH (PAD1 - PAD16)

Offset	Address(H)	Data(H)	Description
01 02 pp 00	0000	31F	Pattern number bit15-12 (PTN001 - PTN800)
01 02 pp 01			Pattern number bit11-8
01 02 pp 02			Pattern number bit7-4
01 02 pp 03			Pattern number bit3-0

●All User Drum kits (Bulk)

This area is the data of the all user Drum kits(Drum kit 65-128).

If you want to send Data Request to the DR-770 in this area, set the address to 02 00 00 00. A size is ignored.
The size of this area is 00 03 12 00.

Address(H)	Data(H)	Description
02 00 00 00	---	All User Drum kits

●All Songs (Bulk)

This area is the data of the all songs (SONG 1-100) except demo song.

If you want to send Data Request to the DR-770 in this area, set the address to 03 00 00 00. A size is ignored.
The size of this area is 00 02 4E 30.

Address(H)	Data(H)	Description
03 00 00 00	---	All Songs (except DEMO Song)

●All User Patterns (Bulk)

This area is the data of the all user patterns (PTN401 - PTN800).

If you want to send Data Request to the DR-770 in this area, set the address to 04 00 00 00. A size is ignored.
The size of this area is 00 05 37 28.

Address(H)	Data(H)	Description
04 00 00 00	---	All User Patterns

5. Supplementary material

●Decimal/Hexadecimal table

(hexadecimal values are indicated by a following "H")

MIDI uses 7-bit hexadecimal values to indicate data values and the address and size of exclusive messages. The following table shows the correspondence between decimal and hexadecimal numbers.

D	H	D	H	D	H	D	H
0	00H	32	20H	64	40H	96	60H
1	01H	33	21H	65	41H	97	61H
2	02H	34	22H	66	42H	98	62H
3	03H	35	23H	67	43H	99	63H
4	04H	36	24H	68	44H	100	64H
5	05H	37	25H	69	45H	101	65H
6	06H	38	26H	70	46H	102	66H
7	07H	39	27H	71	47H	103	67H
8	08H	40	28H	72	48H	104	68H
9	09H	41	29H	73	49H	105	69H
10	0AH	42	2AH	74	4AH	106	6AH
11	0BH	43	2BH	75	4BH	107	6BH
12	0CH	44	2CH	76	4CH	108	6CH
13	0DH	45	2DH	77	4DH	109	6DH
14	0EH	46	2EH	78	4EH	110	6EH
15	0FH	47	2FH	79	4FH	111	6FH
16	10H	48	30H	80	50H	112	70H
17	11H	49	31H	81	51H	113	71H
18	12H	50	32H	82	52H	114	72H
19	13H	51	33H	83	53H	115	73H
20	14H	52	34H	84	54H	116	74H
21	15H	53	35H	85	55H	117	75H
22	16H	54	36H	86	56H	118	76H
23	17H	55	37H	87	57H	119	77H
24	18H	56	38H	88	58H	120	78H
25	19H	57	39H	89	59H	121	79H
26	1AH	58	3AH	90	5AH	122	7AH
27	1BH	59	3BH	91	5BH	123	7BH
28	1CH	60	3CH	92	5CH	124	7CH
29	1DH	61	3DH	93	5DH	125	7DH
30	1EH	62	3EH	94	5EH	126	7EH
31	1FH	63	3FH	95	5FH	127	7FH

D: decimal
H: hexadecimal

- * Decimal expressions such as used for MIDI channel, Bank Select, and Program Change will be the value 1 greater than the decimal value given in the above table.
- * Since each MIDI byte carries 7 significant data bits, each byte can express a maximum of 128 different values. Data for which higher resolution is required must be transmitted using two or more bytes. For example a value indicated as a two-byte value of aa bbH would have a value of aa x 128 + bb.
- * For a signed number (+/-), 00H = -64, 40H = +/-0, and 7FH = -63. I.e., the decimal equivalent will be 64 less than the decimal value given in the above table. For a two-byte signed number, 00 00H = -8192, 40 00H = +/-0, and 7F 7FH = -8191. For example the decimal expression of aa bbH would be aa bbH - 40 00H = (aa x 128 + bb - 64 x 128).
- * Hexadecimal notation in two 4-bit units is used for data indicated as 'nibbled'. The nibbled two-byte value of 0a 0b H would be a x 16 + b.

<Example 1>

What is the decimal equivalent of 5AH?

From the above table, 5AH = 90.

<Example 2>

What is the decimal equivalent of the 7-bit hexadecimal values 12 34H?

From the above table, 12H = 18 and 34H = 52
Thus, 18 x 128 + 52 = 2356

○Examples of actual MIDI messages

<Example 1> 99 3E 7F

CnH is the Note On status and "n" is the MIDI channel number. Since 9H = 9, 3EH = 62, and 7FH = 127, this is a Note On message of MIDI CH = 10, Note number 62.

<Example 2> CE 49

CnH is the Program Change status and "n" is the MIDI channel number. Since 9H = 9, and 49H = 73, this is a Program Change message of MIDI CH = 10, Program number 74.

○Examples of exclusive messages and calculating the checksum

Roland exclusive messages (RQ1, DT1) are transmitted with a checksum at the end of the data (before F7) to check that the data was received correctly. The value of the checksum is determined by the address and data (or size) of the exclusive message.

○How to calculate the checksum

(hexadecimal values are indicated by a "H")

The checksum consists of a value whose lower 7 bits are 0 when the address, size and checksum itself are added.

The following formula shows how to calculate the checksum when the exclusive message to be transmitted has an address of aa bb cc ddH, and data or size of ee ffH.

$$aa - bb + cc + dd + ee + ff = \text{total}$$

$$\text{total} / 128 = \text{quotient} \dots \text{remainder}$$

$$128 - \text{remainder} = \text{checksum}$$

Checksum is 0 if the remainder is 0.

<Example 1> Setting the Instrument of the PAD A03 of the current Drum kit to 182.

The "Parameter address map" indicates that the starting address of the current Drum kit is 00 00 00 00H, that the Instrument of the PAD A03 offset address is 00 00 02 00H, and that the Instrument address is 00 00 00 00H. Thus, the address is:

$$\begin{array}{r} 00\ 00\ 00\ 00H \\ 00\ 00\ 02\ 00H \\ +) 00\ 00\ 00\ 00H \\ \hline 00\ 00\ 02\ 00H \end{array}$$

Instrument 182 is parameter value B5H (182(B6H - 1)), and divides value into 4bit MSB and 4bit LSB, so it is 0B 05H.

F0H	41H	09H	00	1CH	12H	00	00	02	00H	0B	05H	??H	F7H
(1)	(2)	(3)	(4)	(5)	address	data		checksum	(6)				

- (1) Exclusive status
- (2) ID number (Roland)
- (3) device ID (10)
- (4) model ID (DR-770)
- (5) command ID (DT1)
- (6) End of Exclusive

Next we calculate the checksum.

$$00H + 00H + 02H + 00H + 0BH + 05H = 0 + 0 + 2 + 0 + 11 + 5 = 18 \text{ (sum)}$$

$$18 \text{ (total)} + 128 \text{ (quotient)} = 0 \text{ (quotient)} \dots 18 \text{ (remainder)}$$

$$\text{checksum} = 128 - 18 \text{ (quotient)} = 110 = 6EH$$

This means that the message transmitted will be F0 41 09 00 1C 12 00 00 02 00 0B 05 6E F7.

<Example 2> Retrieving data for PAD B01 of the current Drum kit.

The "Parameter address map" indicates that the starting address of the current Drum kit is 00 00 00 00H, and that the PAD B01 offset address is 00 00 10 00H. Thus, the address is:

$$\begin{array}{r} 00\ 00\ 00\ 00H \\ +) 00\ 00\ 10\ 00H \\ \hline 00\ 00\ 10\ 00H \end{array}$$

Since the size of the PAD parameter is 00 00 00 0CH.

F0H	41H	09H	00	1CH	11H	00	00	10	00H	00	00	00	0CH	??H	F7H
(1)	(2)	(3)	(4)	(5)	address	size		checksum	(6)						

- (1) Exclusive status
- (2) ID number (Roland)
- (3) device ID(10)
- (4) model ID (DR-770)
- (5) command ID (RQ1)
- (6) End of Exclusive

Next we calculate the checksum.

$00H + 00H + 10H + 00H + 00H + 00H + 00H + 0CH = 0 + 0 + 16 + 0 + 0 + 0 + 0 + 12 = 28$
 (sum)
 $28 \text{ (total)} \div 128 \text{ (quotient)} = 0 \text{ (quotient)} \dots 28 \text{ (remainder)}$
 $\text{checksum} = 128 - 28 \text{ (quotient)} = 100 = 64H$

This means that the message transmitted will be F0 41 09 00 1C 11 00 00 10 00 00 00 00 0C 64 F7.

●ASCII code table

On the DR-770, the following ASCII code set is used for processing data such as the Pattern Name, Song Name, etc.

Char	Hex.	Char	Hex.	Char	Hex.	Char	Hex.
SP	20H						
A	41H	a	61H	0	30H	:	3AH
B	42H	b	62H	1	31H	:	3BH
C	43H	c	63H	2	32H	<	3CH
D	44H	d	64H	3	33H	=	3DH
E	45H	e	65H	4	34H	>	3EH
F	46H	f	66H	5	35H	?	3FH
G	47H	g	67H	6	36H	ø	40H
H	48H	h	68H	7	37H	!	5BH
I	49H	i	69H	8	38H	\	5CH
J	4AH	j	6AH	9	39H]	5DH
K	4BH	k	6BH	!	21H	^	5EH
L	4CH	l	6CH	*	22H	_	5FH
M	4DH	m	6DH	#	23H	~	60H
N	4EH	n	6EH	S	24H	(7BH
O	4FH	o	6FH	%	25H		7CH
P	50H	p	70H	&	26H)	7DH
Q	51H	q	71H	'	27H	->	7EH
R	52H	r	72H	(28H	<-	7FH
S	53H	s	73H)	29H		
T	54H	t	74H	*	2AH		
U	55H	u	75H	+	2BH		
V	56H	v	76H	,	2CH		
W	57H	w	77H	-	2DH		
X	58H	x	78H	.	2EH		
Y	59H	y	79H	/	2FH		
Z	5AH	z	7AH				

Note: SP indicates "space."

Dr. Rhythm
Model DR-770

MIDI Implementation Chart

Date : Jan. 11, 1999
Version : 1.00

Function...		Transmitted	Recognized	Remarks
Basic Channel	Default Changed	1-16 1-16	1-16 1-16	Memorized
Mode	Default Messages Altered	Mode 3 X *****	Mode 3 X	
Note Number :	True Voice	27-81 *****	27-81 27-81	* 1
Velocity	Note ON Note OFF	O 9n, v=1-127 X	O X	
After Touch	Key's Ch's	X X	X X	
Pitch Bend		X	X	
Control Change	7 11	O X	O * 2 O * 2	Volume Expression
Prog Change	: True #	O * 2 *****	O * 2	Drum Kit change
System Exclusive		O	O	
System Common	: Song Pos : Song Sel : Tune	O * 3 O * 3 x	O * 4 O * 4 x	0-99
System Real Time	: Clock : Command	X * 3 X * 3	O * 4 O * 4	
Aux Message	: Local ON/OFF : All Notes OFF : All sound off : Reset all controllers : Active Sense : System Reset	X X X X O X	X X X X X X	
Notes		* 1 Relationship between Percussion instrument and Note number is common to transmit and receive. * 2 Can be set to O or X . * 3 Sync = INT only. * 4 Sync = MIDI only.		

Mode 1 : OMNI ON, POLY Mode 2 : OMNI ON, MONO
Mode 3 : OMNI OFF, POLY Mode 4 : OMNI OFF, MONO

O : Yes
X : No

Specifications

DR-770: Dr. Rhythm

● Maximum Polyphony

14 voices

● Instruments

255

● Rhythm Patterns

User Patterns: 400

Preset Patterns: 400

● Songs

Songs: 100

Song Length: Maximum 250 parts for a song

Total Parts for songs: 10,000

● Resolution

Per quarter note: 96

● Tempo

Quarter note: 20–260

● Data Input Method

Realtime / Step

● Maximum Note Storage

approx. 11,200 note

● Display

Custom LCD

● Connectors

Output Jacks (L, R(Mono))

Individual Output Jack

Headphone Jack (stereo miniature phone type)

Pedal Switch Jack

MIDI Connectors (IN, OUT)

AC Adaptor Jack (AC 14 V)

● Power Supply

AC Adaptor (BOSS BRC series)

● Current Draw

700 mA

● Dimensions

215 (W) x 165 (D) x 59 (H) mm

8-1/2 (W) x 6-1/2 (D) x 2-3/8 (H) inches

● Weight

715 g / 1 lbs 10 oz

● Accessories

AC Adaptor (BOSS BRC series)

Owner's Manual

Roland Service (information sheet)

● Options

Foot Switch: FS-5U

Pedal Switch: DP-2

Foot Switch Cable: PCS-31

* *In the interest of product improvement, the specifications and/or appearance of this unit are subject to change without prior notice.*

Index

A

A	20, 46
A.TYPE	75
AB	20, 46
Adding a Fill-in	50, 69
Adjusting the Tempo	23, 48, 66
ALL	15, 81
Ambience	29, 48, 77
Applying Effects	29, 48
ASSIGN	71
Assign Type	75

B

B	20, 46
BEAT LENGTH	32
Beat Length	32, 53
BULK	89
Bulk Dump	89

C

Category	25, 49
CHASE	70
CHN	52
CHORUS	79
CLICK LEVEL	56
CLICK SEL	56
Clock	55
Continue Play	23
Control Change Message	85
COPY	62, 67–68, 84
Copy	62, 68, 77, 84
Copying a Drum Kit	84
Copying a Pattern	62
Copying a Song	68
CRV	76

D

D.FDBK	78
DECAY	73
Decay	73
Delay Feedback	78
DELETE	35, 62, 66–67
Deleting a Pattern	62, 66
Deleting a Song	67
Direct Pattern Play	24, 48
DPP	24, 48–49, 63
DPP Mode	48–49
DRUM KIT	46, 71, 87
Drum Kit	27, 41, 46
Drum Kit Change	65
Drum Kit Name	77

E

Editing a Drum Kit	71
Editing a Pattern	57
Editing a Song	65
Editing Effects	77–81
Effect Mode	44
EFFECTS	44, 78–80
EQ HIGH	80
EQ LOW	80
Equalizer	80
Equalizer High Gain	80
Equalizer Low Gain	80
Exclusive Receive Switch	87–88
Expression Receive Switch	87–88

F

F.DLY	79
F.DPTH	79
F.FDBK	79
F.RATE	79
F.RST	15, 91
F.TYPE	79
Factory Reset	15, 91
Fill-in	50, 69
Fill-in To Original Pattern	50, 61
Fill-in To Original Pattern number	61
Fill-in To Variation Pattern	50, 61
Fill-in To Variation Pattern Number	61
FL	47
Flam	21, 47
FLAM INT	47
Flam Interval	47
FLAM RATIO	47
Flam Ratio	47
FLANGER	81
Flanger	79–80
Flanger Delay	79
Flanger Depth	79
Flanger Feedback	79
Flanger Level	80–81
Flanger Rate	79
Flanger Send Level	81
Flanger Type	79
FOOT 2	69
Foot Switch	69
FTO	61
FTV	61

I

IND	83
INDIV	74, 83
Individual Output	82

Initial Tempo	66
INSERT	67
Instrument	19, 41, 46
Instrument Assign	71
INT	66, 89
K	
KIT	65
KITNAM	77
L	
LEVEL	72
Level	72
M	
Master	88
Metronome	33, 53, 56
MIDI	44, 85, 89
MIDI Channel	85
MIDI channel	86
MIDI Connector	85
MIDI Implementation Chart	86
MIDI In	85
MIDI Mode	44
MIDI Out	85
MIDI Thru Switch	88
MIDIch	86, 89–90
MONO	75
MONO EXC	76
N	
NEXT PTN	23
Note Messages	85
Note Number	85
NOTE#	87
NUANCE	73
Nuance	73
O	
Original Pattern	50
Output Level	83
P	
PAD	44
Pad	19, 46
Pad Bank	19, 41, 46
Pad Bank A	42
Pad Bank B	42
Pad Bank Layer	20, 46
Pad Mode	44
Pad Number	41
PAN	74, 83
Pan	74
Parameter	78–80
PART	38
Part	38
PATTERN	22, 31, 44, 48, 53–54
Pattern	22, 42
Pattern Mode	44, 48, 53
Pattern mode	54
Pattern Name	61
PEDAL SW jack	69
PITCH	72
Playing Patterns	22, 24, 48, 69
Playing Songs	51–52, 69
Polarity Switch	69
POLY	75
POLY EXC	75
Preset Drum Kit	41, 46
Preset Pattern	22, 48
PRG	87–88
Program Change Message	85
Program Change Switch	87–88
Q	
Quantize	32, 53–54, 59
Quick Search	25, 49
R	
R.LPF	78
R.TIME	78
R.TYPE	78
REAL	31, 53, 63
Realtime Pattern Change	50, 61
Realtime Recording	31, 37, 42–43, 53, 63
REC Indicator	32, 38, 53, 63–64
Recording a Pattern	31, 53–54
Recording a Song	37, 63–64
Rehearse	33
REVERB	81, 83
Reverb	78, 80
Reverb Level	80–81
Reverb Low Pass Filter	78
Reverb Send Level	81
Reverb Time	78
Reverb Type	78
Roll	21, 47
ROLL TYPE	47
RPC	61
RxEXC	87–88, 90
RxEXPR	87–88
RxVOL	87–88
S	
Sensitivity Curve	76
SHIFT	60

Slave	88
SONG	37, 44, 51, 63–64
Song	43, 51
Song Chain	52
Song Mode	44, 51, 63–64
Song Name	65
STEP	38, 54, 64
Step	55
Step Recording	31, 37, 42–43, 54
SWING	59
Swing	59
Switching the Drum Kit	27, 46, 59
SYNC	89
Sync Mode	89
System Exclusive Message	86

T

TEMPO	23, 48
Tempo	23, 48
Tempo Indicator	33, 38, 53, 55, 63
THRU	88
Timing Shift	60

U

User Drum Kit	41, 46
User Pattern	22, 42
User Patterns	48
UTILITY	15, 44
Utility Mode	44

V

[VALUE*]	45
VAR	61
Variation Pattern	50, 61
Variation Pattern Number	61
Velocity	33, 47, 85
Volume Receive Switch	87–88

MEMO

■ **Drum Kit**

Drum Kit No. _____ Name _____

Pad No.	Note #	Instrument	Level	Pitch	Decay	Nuance	Pan	Assign Type	Sensitivity Curve
1 (A01)									
2 (A02)									
3 (A03)									
4 (A04)									
5 (A05)									
6 (A06)									
7 (A07)									
8 (A08)									
9 (A09)									
10 (A10)									
11 (A11)									
12 (A12)									
13 (A13)									
14 (A14)									
15 (A15)									
16 (A16)									
17 (B01)									
18 (B02)									
19 (B03)									
20 (B04)									
21 (B05)									
22 (B06)									
23 (B07)									
24 (B08)									
25 (B09)									
26 (B10)									
27 (B11)									
28 (B12)									
29 (B13)									
30 (B14)									
31 (B15)									
32 (B16)									
33 (-01)									
34 (-02)									
35 (-03)									
36 (-04)									
37 (-05)									
38 (-06)									
39 (-07)									
40 (-08)									
41 (-09)									
42 (-10)									
43 (-11)									
44 (-12)									
45 (-13)									
46 (-14)									
47 (-15)									
48 (-16)									
49 (-17)									
50 (-18)									
51 (-19)									
52 (-20)									
53 (-21)									
54 (-22)									
55 (-23)									

● **Effects**

R. TYPE	R. TIME	R. LPF	D. FDBK	F. TYPE	F. DPTH	F. RATE	F. FDBK	F. DLY	EQ HIGH	EQ LOW

For the U.K.

IMPORTANT: THE WIRES IN THIS MAINS LEAD ARE COLOURED IN ACCORDANCE WITH THE FOLLOWING CODE.

BLUE: NEUTRAL
BROWN: LIVE

As the colours of the wires in the mains lead of this apparatus may not correspond with the coloured markings identifying the terminals in your plug, proceed as follows:

The wire which is coloured BLUE must be connected to the terminal which is marked with the letter N or coloured BLACK.
The wire which is coloured BROWN must be connected to the terminal which is marked with the letter L or coloured RED.
Under no circumstances must either of the above wires be connected to the earth terminal of a three pin plug.

For EU Countries

Apparatus containing Lithium batteries

CAUTION

Danger of explosion if battery is incorrectly replaced.
Replace only with the same or equivalent type recommended by the manufacturer.
Discard used batteries according to the manufacturer's instructions.

ADVARSEL!

Lithiumbatteri - Eksplosionsfare ved fejlagtig håndtering.
Udskiftning må kun ske med batteri af samme fabrikat og type.
Lever det brugte batteri tilbage til leverandøren.

VARNING

Explosionsfara vid felaktigt batteribyte.
Använd samma batterityp eller en ekvivalent typ som rekommenderas av apparattillverkaren.
Kassera använda batteri enligt fabrikantens instruktion.

ADVARSEL

Eksplosjonsfare ved feilaktig skifte av batteri.
Benytt samme batteritype eller en tilsvarende type anbefalt av apparatfabrikanten.
Brukte batterier kasseres i henhold til fabrikantens instruksjoner.

VAROITUS

Paristo voi räjähdyttää, jos se on virheellisesti asennettu.
Vaihda paristo ainoastaan laitevalmistajan suosittelemaan tyyppiin. Hävitetyt paristot kassataan ohjeiden mukaisesti.

For EU Countries



This product complies with the requirements of European Directive 89/336/EEC.

For the USA

FEDERAL COMMUNICATIONS COMMISSION RADIO FREQUENCY INTERFERENCE STATEMENT

This equipment has been tested and found to comply with the limits for a Class B digital device, pursuant to Part 15 of the FCC Rules. These limits are designed to provide reasonable protection against harmful interference in a residential installation. This equipment generates, uses, and can radiate radio frequency energy and, if not installed and used in accordance with the instructions, may cause harmful interference to radio communications. However, there is no guarantee that interference will not occur in a particular installation. If this equipment does cause harmful interference to radio or television reception, which can be determined by turning the equipment off and on, the user is encouraged to try to correct the interference by one or more of the following measures:

- Reorient or relocate the receiving antenna.
- Increase the separation between the equipment and receiver.
- Connect the equipment into an outlet on a circuit different from that to which the receiver is connected.
- Consult the dealer or an experienced radio/TV technician for help.

Unauthorized changes or modification to this system can void the user's authority to operate this equipment.
This equipment requires shielded interface cables in order to meet FCC class B Limit.

For Canada

NOTICE

This Class B digital apparatus meets all requirements of the Canadian Interference-Causing Equipment Regulations.

AVIS

Cet appareil numérique de la classe B respecte toutes les exigences du Règlement sur le matériel brouilleur du Canada.

Roland[®]

71452501

UPC

71452501



:098:

BOSS[®]

01788545

'00-2-E3-31N