



DR-3 Dr. Rhythm

Owner's Manual

Thank you, and congratulations on your choice of the BOSS DR-3 Dr. Rhythm.

Before using this unit, carefully read the sections entitled:

- **USING THE UNIT SAFELY** (page 2–4)
- **IMPORTANT NOTES** (page 5)

These sections provide important information concerning the proper operation of the unit.

Additionally, in order to feel assured that you have gained a good grasp of every feature provided by your new unit, Owner's manual should be read in its entirety. The manual should be saved and kept on hand as a convenient reference.

■ Printing Conventions in This Manual

- Text or numerals enclosed in square brackets [] indicate buttons.

[SONG] SONG button

START [▶/■] START button

- Reference such as (p. **) indicate pages in this manual to which you can refer.



Copyright © 2003 BOSS CORPORATION

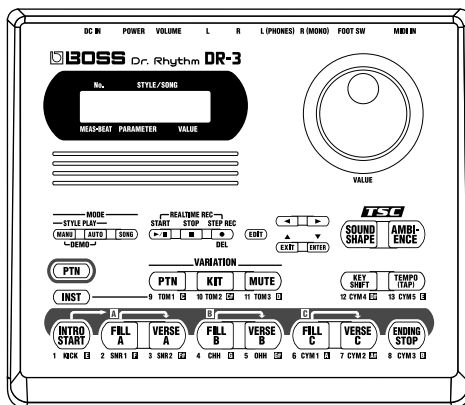

All rights reserved. No part of this publication may be reproduced in any form without the written permission of BOSS CORPORATION.









USING THE UNIT SAFELY

INSTRUCTIONS FOR THE PREVENTION OF FIRE, ELECTRIC SHOCK, OR INJURY TO PERSONS

About  WARNING and  CAUTION Notices

 WARNING	Used for instructions intended to alert the user to the risk of death or severe injury should the unit be used improperly.
 CAUTION	Used for instructions intended to alert the user to the risk of injury or material damage should the unit be used improperly. * Material damage refers to damage or other adverse effects caused with respect to the home and all its furnishings, as well to domestic animals or pets.

About the Symbols

	The  symbol alerts the user to important instructions or warnings. The specific meaning of the symbol is determined by the design contained within the triangle. In the case of the symbol at left, it is used for general cautions, warnings, or alerts to danger.
	The  symbol alerts the user to items that must never be carried out (are forbidden). The specific thing that must not be done is indicated by the design contained within the circle. In the case of the symbol at left, it means that the unit must never be disassembled.
	The  symbol alerts the user to things that must be carried out (are required). The specific thing that must be done is indicated by the design contained within the circle. In the case of the symbol at left, it means that the power-cord plug must be unplugged from the outlet.



ALWAYS OBSERVE THE FOLLOWING

WARNING

- Before using this unit, make sure to read the instructions below, and the Owner's Manual. 

- Do not open (or modify in any way) the unit or its AC adaptor. 

- Do not attempt to repair the unit, or replace parts within it (except when this manual provides specific instructions directing you to do so). Refer all servicing to your retailer, the nearest Roland Service Center, or an authorized Roland distributor, as listed on the "Information" page. 

- Never use or store the unit in places that are: 
 - Subject to temperature extremes (e.g., direct sunlight in an enclosed vehicle, near a heating duct, on top of heat-generating equipment); or are 
 - Damp (e.g., baths, washrooms, on wet floors); or are
 - Humid; or are
 - Exposed to rain; or are
 - Dusty; or are
 - Subject to high levels of vibration.

WARNING

- Make sure you always have the unit placed so it is level and sure to remain stable. Never place it on stands that could wobble, or on inclined surfaces. 

- Use only the specified AC adaptor (PSA-series), and make sure the line voltage at the installation matches the input voltage specified on the AC adaptor's body. Other AC adaptors may use a different polarity, or be designed for a different voltage, so their use could result in damage, malfunction, or electric shock. 

- Do not excessively twist or bend the power cord, nor place heavy objects on it. Doing so can damage the cord, producing severed elements and short circuits. Damaged cords are fire and shock hazards! 

⚠ WARNING

- This unit, either alone or in combination with an amplifier and headphones or speakers, may be capable of producing sound levels that could cause permanent hearing loss. Do not operate for a long period of time at a high volume level, or at a level that is uncomfortable. If you experience any hearing loss or ringing in the ears, you should immediately stop using the unit, and consult an audiologist.



- Do not allow any objects (e.g., flammable material, coins, pins); or liquids of any kind (water, soft drinks, etc.) to penetrate the unit.



- Immediately turn the power off, remove the AC adaptor from the outlet, and request servicing by your retailer, the nearest Roland Service Center, or an authorized Roland distributor, as listed on the "Information" page when:



- The AC adaptor or the power-supply cord has been damaged; or
- If smoke or unusual odor occurs
- Objects have fallen into, or liquid has been spilled onto the unit; or
- The unit has been exposed to rain (or otherwise has become wet); or
- The unit does not appear to operate normally or exhibits a marked change in performance.

- In households with small children, an adult should provide supervision until the child is capable of following all the rules essential for the safe operation of the unit.



- Protect the unit from strong impact. (Do not drop it!)



⚠ WARNING

- Do not force the unit's power-supply cord to share an outlet with an unreasonable number of other devices. Be especially careful when using extension cords—the total power used by all devices you have connected to the extension cord's outlet must never exceed the power rating (watts/ amperes) for the extension cord. Excessive loads can cause the insulation on the cord to heat up and eventually melt through.



- Before using the unit in a foreign country, consult with your retailer, the nearest Roland Service Center, or an authorized Roland distributor, as listed on the "Information" sheet.





- Batteries must never be recharged, heated, taken apart, or thrown into fire or water.





 **CAUTION**

- The unit and the AC adaptor should be located so their location or position does not interfere with their proper ventilation. 

- Always grasp only the output plug or the body of the AC adaptor when plugging into, or unplugging from, this unit or an outlet. 

- Any accumulation of dust between the AC adaptor and the power outlet can result in poor insulation and lead to fire. Periodically wipe away such dust with a dry cloth. Also, disconnect the power plug from the power outlet whenever the unit is to remain unused for an extended period of time. 

- Try to prevent cords and cables from becoming entangled. Also, all cords and cables should be placed so they are out of the reach of children. 

- Never climb on top of, nor place heavy objects on the unit. 



- Never handle the AC adaptor body, or its output plugs, with wet hands when plugging into, or unplugging from, an outlet or this unit. 

- Before moving the unit, disconnect the AC adaptor and all cords coming from external devices. 

- Before cleaning the unit, turn off the power and unplug the AC adaptor from the outlet (P. 16). 

 **CAUTION**

- Whenever you suspect the possibility of lightning in your area, disconnect the AC adaptor from the outlet. 

- If used improperly, batteries may explode or leak and cause damage or injury. In the interest of safety, please read and observe the following precautions (P. 15). 

 - Carefully follow the installation instructions for batteries, and make sure you observe the correct polarity.
 - Avoid using new batteries together with used ones. In addition, avoid mixing different types of batteries.
 - Remove the batteries whenever the unit is to remain unused for an extended period of time.
 - If a battery has leaked, use a soft piece of cloth or paper towel to wipe all remnants of the discharge from the battery compartment. Then install new batteries. To avoid inflammation of the skin, make sure that none of the battery discharge gets onto your hands or skin. Exercise the utmost caution so that none of the discharge gets near your eyes. Immediately rinse the affected area with running water if any of the discharge has entered the eyes.
 - Never keep batteries together with metallic objects such as ballpoint pens, necklaces, hairpins, etc.

- Used batteries must be disposed of in compliance with whatever regulations for their safe disposal that may be observed in the region in which you live. 

IMPORTANT NOTES

In addition to the items listed under “USING THE UNIT SAFELY” on page 2–4, please read and observe the following:

Power Supply: Use of Batteries

- Do not use this unit on the same power circuit with any device that will generate line noise (such as an electric motor or variable lighting system).
- The AC adaptor will begin to generate heat after long hours of consecutive use. This is normal, and is not a cause for concern.
- The use of an AC adaptor is recommended as the unit’s power consumption is relatively high. Should you prefer to use batteries, please use the alkaline type.
- When installing or replacing batteries, always turn off the power on this unit and disconnect any other devices you may have connected. This way, you can prevent malfunction and/or damage to speakers or other devices.
- Batteries are supplied with the unit. The life of these batteries may be limited, however, since their primary purpose was to enable testing.
- Before connecting this unit to other devices, turn off the power to all units. This will help prevent malfunctions and/or damage to speakers or other devices.

Placement

- Using the unit near power amplifiers (or other equipment containing large power transformers) may induce hum. To alleviate the problem, change the orientation of this unit; or move it farther away from the source of interference.
- This device may interfere with radio and television reception. Do not use this device in the vicinity of such receivers.
- Noise may be produced if wireless communications devices, such as cell phones, are operated in the vicinity of this unit. Such noise could occur when receiving or initiating a call, or while conversing. Should you experience such problems, you should relocate such wireless devices so they are at a greater distance from this unit, or switch them off.
- Do not expose the unit to direct sunlight, place it near devices that radiate heat, leave it inside an enclosed vehicle, or otherwise subject it to temperature extremes. Excessive heat can deform or discolor the unit.
- When moved from one location to another where the temperature and/or humidity is very different, water droplets (condensation) may form inside the unit. Damage or malfunction may result if you attempt to use the unit in this condition. Therefore, before using the unit, you must allow it to stand for several hours, until the condensation has completely evaporated.

Maintenance

- For everyday cleaning wipe the unit with a soft, dry cloth or one that has been slightly dampened with water. To remove stubborn dirt, use a cloth impregnated with a mild, non-abrasive detergent. Afterwards, be sure to wipe the unit thoroughly with a soft, dry cloth.
- Never use benzine, thinners, alcohol or solvents of any kind, to avoid the possibility of discoloration and/or deformation.

Additional Precautions

- Please be aware that the contents of memory can be irretrievably lost as a result of a malfunction, or the improper operation of the unit. To protect yourself against the risk of losing important data, we recommend that you periodically save a backup copy of important data you have stored in the unit’s memory on a paper.
- Unfortunately, it may be impossible to restore the contents of data that was stored in another MIDI device (e.g., a sequencer) once it has been lost. Roland Corporation assumes no liability concerning such loss of data.
- Use a reasonable amount of care when using the unit’s buttons, sliders, or other controls; and when using its jacks and connectors. Rough handling can lead to malfunctions.
- Never strike or apply strong pressure to the display.
- When connecting / disconnecting all cables, grasp the connector itself—never pull on the cable. This way you will avoid causing shorts, or damage to the cable’s internal elements.
- To avoid disturbing your neighbors, try to keep the unit’s volume at reasonable levels. You may prefer to use headphones, so you do not need to be concerned about those around you (especially when it is late at night).
- When you need to transport the unit, package it in the box (including padding) that it came in, if possible. Otherwise, you will need to use equivalent packaging materials.

Main Features

■ Making Your Own Rhythm Pattern Arrangements with Style Play

With the DR-3, you can enjoy performing rhythm patterns made up of drum and bass sounds. You can add fill-ins and switch patterns while you play, making it easy to develop choruses, bridges, and solos for your songs.

■ 100 Different Preset Styles

The DR-3 comes with 100 different prepared Styles in a variety of genres, including Rock, Funk, Hip Hop, Jazz, Latin, and more. You can also create up to 100 of your own original Styles.

■ TSC (Total Sound Control) Function

This includes two types of effects, “Sound Shape,” which adjusts the overall tone of the sound, and “Ambience,” which alters the overall acoustic characteristics.

This feature makes it easy to attain the sound you want, whether it be a harder sound for Rock, an acoustic sound for Jazz, or the sound you get when performing live on stage.

Sound Shape and Ambience each includes eight presets and eight memories you can use to store your own favorite settings.

■ Control the DR-3 with a Foot Switch

The DR-3 allows you to connect up to two (optional) foot switches. You can use your foot to control the DR-3 as you perform, making this perfect for jam sessions and live performances. You can a variety of functions to the foot switches, including switching patterns and turning the Variation function on and off.

■ Variation Function Lets You Enjoy a Wide Variety of Arrangements

The DR-3 includes a Variation function that lets you play different arrangements within songs, for example arrangements to build up the excitement, quieter ones for vocal solos, along with a wide variety of other arrangements.

■ Produce Rhythm Patterns Automatically in Auto Mode

In Auto mode, you can produce songs by having the rhythm patterns be changed automatically every eight or sixteen measures, allowing you to enjoy jam sessions once you start a song, without having to operate the DR-3.

■ High-Quality Instrument Sounds—Ghost Notes, Too

The DR-3 features special “soft shot,” “double shot,” and “buzz shot” sounds for use as snare ghost notes. Using these makes it possible to get even more realistic rhythm patterns.

■ Dynamics-Capable Pad Keys

The pad keys on the DR-3 are capable of producing dynamics. The volume changes in response to the force you use to play the pads.

This lets you alter the sound you play depending on how hard you hit the pads, such as for hard shots and soft shots on the snare.

■ **Setting the Tempo with Tap Tempo Function**

You can set tempos just by tapping the button at the desired timing.

■ **Key Shift Function**

You can easily change the key in which you are playing.

You can also easily get flat-tuning of a guitar, or match the key used by a different instrument, such as a sax.

■ **Convenient Song Composing and Performing Functions**

While basically following procedures similar to those used in performing Styles, you can create songs intuitively with the panel pads.

After you create a song, you can add cymbal crashes, change bass phrases, and edit specific portions of songs.

■ **Synchronize Performances with Digital Recorders and Sequencers**

Using MIDI, you can synchronize performances with digital recorders (such as those in the BR Series) and sequencers, or start and stop the DR-3 using a GT-6.

■ **Equipped with Both Phono Jacks and Phone Jacks**

In addition to 1/4" phone jacks, the DR-3 also features RCA phono jacks, which let you connect a variety of other devices, such as mixers, amps, and audio systems.

■ **Compact Body**

The DR-3 is lightweight, compact, and very portable. And since the unit can be powered with batteries, you can use it just about anywhere.

Contents

USING THE UNIT SAFELY	2
IMPORTANT NOTES	5
Main Features	6
Panel Descriptions	12
Before You Play	15
Install Batteries	15
Making Connections.....	16
Turning On/Off the Power	17
Reset to Default Factory Settings (Factory Reset)	18

Quick Start20

Let's Listen to the Demo	21
Let's Play a Style	22
Performing Styles with Selecting Patterns ([MANU])	22
Performing Variations on Styles (VARIATION).....	24
Selecting Styles	26
Changing the Tempo ([TEMPO])	27
Setting the Tempo by Tapping It Out (Tap Tempo).....	27
Changing the Key ([KEY SHIFT])	28
Let's Use a Foot Switch	29
Connecting the Foot Switch	29
Using the Foot Switch	30
Let's Perform with the Patterns Switched Automatically ([AUTO])	31
Let's Change the Overall Tone of the Sound and Acoustics (TSC)	32

Chapter 1 Overview of the DR-3.....	34
The DR-3's Performance Modes	34
Style Play Mode	34
Makeup of a Style	35
Song Mode	37
Switching the Pad Functions.....	37
Main Screens and Functions.....	38
Starting and Stopping Performances and Recording.....	40
Adjusting the Tempo ([TEMPO]).....	41
Changing the Key of the Performance ([KEY SHIFT]).....	42
Chapter 2 Playing Styles (Manual Mode [MANU])	43
How the Pads Work When Performing Styles	43
Selecting Styles	43
Selecting the Patterns to be Played.....	44
Starting/Stopping.....	44
How to Change Patterns.....	44
Selecting Variations (VARIATION).....	45

Chapter 3 Playing Styles (Auto Mode [AUTO])	46
Selecting a Style.....	46
Performing in Auto Mode	46
Changing the Pattern Progression in Auto Mode.....	47
Chapter 4 Controlling the Styles with a Foot Switch	48
Starting and Stopping Performances	48
Switching Verses	48
Assigning Functions to the Foot Switch.....	49
Chapter 5 Changing the Overall Tone of the Sound and Acoustics (TSC)	51
Changing the Overall Tone of the Sound ([SOUND SHAPE]).....	51
Altering the Acoustic Characteristics of the Overall Sound ([AMBIENCE])..	52
Changing the Sound Shape Parameters	53
How to Make the Settings	53
Changing the Equalizer Parameters	53
Changing the Compressor Parameters.....	54
Naming the Settings	55
Copying the Settings	55
Changing the Ambience Parameters	56
How to Make the Settings	56
Changing the Ambience Parameters	56
Naming the Settings	57
Copying the Settings	57
Chapter 6 Performing with the Pads	58
Playing Drum Sounds.....	59
Playing Percussion Sounds	59
Playing Bass Sounds.....	59
Selecting a Different Sound (VARIATION [KIT]).....	60
Chapter 7 Creating Styles	61
Procedure for Creating Styles	61
<1> Selecting a Number for the Style	62
<2> Making the Settings for the New Style	62
Setting the Tempo for the Style	62
Setting the Beat.....	62
Setting Up the Kit	63
Changing the Sound to Be Muted	63
Making the TSC Settings for the Style	64
Determining the Number of Measures for Each Pattern	64
<3> Recording the Patterns	65
Using Realtime Recording.....	65
• Recording the Drum Part	65
• Recording the Bass Part.....	66
Using Step Recording.....	67
• Recording the Drum Part	67
• Recording the Bass Part.....	68
Adding Dynamics to the Sounds (Velocity Edit).....	69
Transposing the Pattern's Bass Part.....	70
Playing Back Recorded Patterns.....	70

<4> Confirming the Created Style.....	70
Performing the Created Style.....	70
Editing the Settings.....	70
Naming, Copying, and Deleting Styles	71
Naming the Style	71
Copying the Style.....	71
Clearing the Style.....	72
Copying and Deleting Patterns	72
Copying Patterns	72
Clearing Patterns	73
Chapter 8 Creating and Performing Songs ([SONG])	74
What is a Song?	74
Procedure for Creating Songs	74
<1> Selecting a Number for the Song	75
<2> Make the Settings for the New Song	75
Setting the Basic Tempo.....	75
Making the TSC Settings for the Song	76
<3> Recording the Song.....	76
When Using Step Recording	76
When Using Realtime Recording	77
Editing Notes to Drum Parts and Bass Parts in the Song	78
<4> Editing Songs.....	80
Adding Patterns In the Song (INSERT).....	80
Deleting Specified Segments (DELETE).....	81
Copying Specified Segments (COPY).....	82
Changing the Tempo Part Way Through a Song (TEMPO).....	83
<5> Checking the Created Song	83
Performing the Created Song.....	83
Editing the Settings.....	83
Naming, Copying, and Deleting Songs.....	84
Naming the Song	84
Copying the Song	84
Clearing the Song.....	85
Performing Songs	85
Performing Songs	85
Switching Patterns With a Foot Switch	86
Playing Multiple Songs Continuously (Song Chain)	87
Chapter 9 Changing the Operating Environment (System).....	88
How to Make the Settings	88
Setting the Parts To Be Output from the OUTPUT Jacks.....	89
Adjusting the Pad Sensitivity.....	89
Setting the Reference Pitch for the Bass Part	89
Changing the Volume of the Metronome Sound	89
Chapter 10 Creating Your Own Kits.....	90
How to Make the Settings	90
Selecting the Sounds Assigned to the Pads.....	91
Setting the Volume	91
Setting the Position of the Sound	91
Naming the Kit.....	91
Copying the Kit	92

Chapter 11 Connecting and Using External MIDI Devices	93
What is MIDI?	93
Starting/Stopping and Synchronizing Performances on the DR-3 from an External MIDI Device.....	93
Setting the MIDI Channels	94
Setting Sync Mode	95
Using An External MIDI Device to Play the DR-3.....	95
Using the DR-3 to Record Performances Played by External MIDI Devices ...	96

Appendices.....98

Troubleshooting	99
Message List	100
Parameter List.....	101
Instrument/Bass Tone List	104
Preset Kit List	106
Preset Style List.....	116
MIDI Implementation	117
MIDI Implementation Chart	120
Specifications	122
Index	123

Panel Descriptions

Front Panel

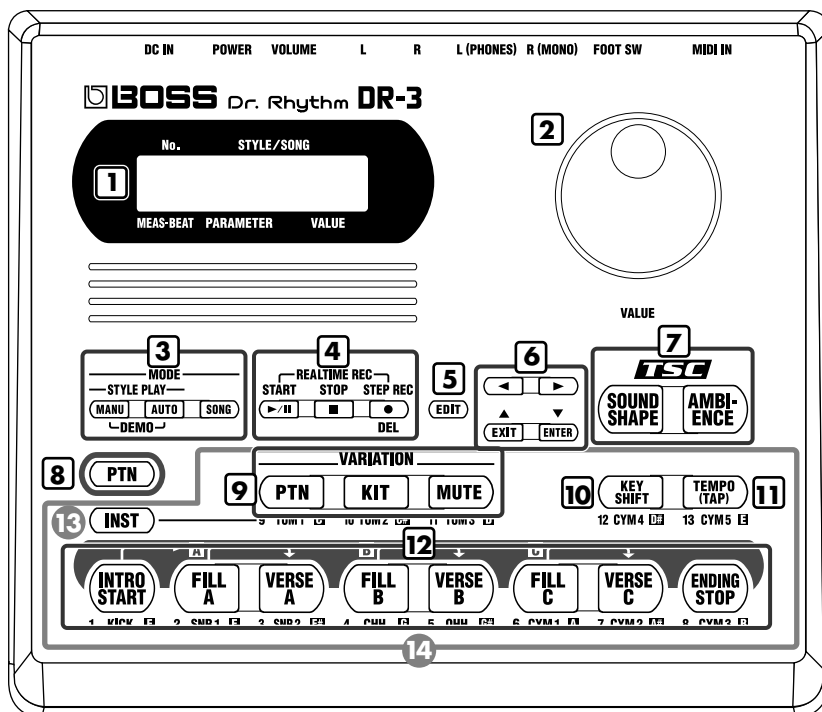

1. Display

- * The explanations in this manual include illustrations that depict what should typically be shown by the display. Note, however, that your unit may incorporate a newer, enhanced version of the system (e.g., includes newer sounds), so what you actually see in the display may not always match what appears in the manual.

2. VALUE dial

Selects Styles and songs.

You can set tempos by rotating the dial after pressing the TEMPO button (11).

This is also used during editing to input settings values.

3. MODE button

MANU (Manual) button

Press this button to switch to Manual mode, in which you perform by switching the patterns yourself.

AUTO button

Press this button to switch to Auto mode, in which the patterns are switched automatically during play of Styles.

SONG button

Press this button to switch to Song mode, in which you play songs.

4.**START ▶/■ button**

Starts and pauses Styles/songs playback or recording.

STOP ■ button

This stops the performance of the Styles or songs.

STEP REC ● button

This starts Step Recording of Styles and songs.

Pressing START button during Step Recording then starts Realtime Recording.

5. EDIT button

Uses this when making settings related to the performance and the usage environment for the DR-3.

6. ◀ / ▶ / ▲ /EXIT / ▼ /ENTER buttons

The four buttons, ◀, ▶, ▲ and ▼ are called the **cursor buttons**.

Cursor buttons are used to select parameters and changes screens (pages). EXIT button is pressed to stop an operation. ENTER button is used to “lock in” a value you’ve set or to execute an operation.

7. TSC (Total Sound Control) buttons**SOUND SHAPE button**

Adjusts the overall tone of the sound.

AMBIENCE button

Alters the acoustic characteristics of the overall sound.

8. PTN button

* These are indicated in this manual as .

Press this button to switch patterns with the pads (12).

When this button is ON (lit), the 9–12 buttons switch to the following functions.

9. VARIATION buttons**PTN button**

The Pattern’s variation is played.

KIT button

Plays with the Kit’s variation sound.

MUTE button

Some instrument sounds of the pattern are muted.

10. KEY SHIFT button

Changes the key of the Patterns and songs (transposing).

11. TEMPO (TAP) button

Adjusts the tempo.

You can tap this button at least four times to set the tempo to the interval between the taps.

12. Pattern Pads

When the PTN button (8) is on, you can switch the patterns with these eight pads.

13. INST (Instrument) button

Press this button to use the pads to play drum and bass sounds.

When this button is on (lit), the 9–12 buttons play the drum and bass sounds. Also, you can press this button to switch the sound groups for the pads (14).

14. Pads

When INST button (13) is ON (lit), drum and bass sounds are played with these pads.

Rear Panel

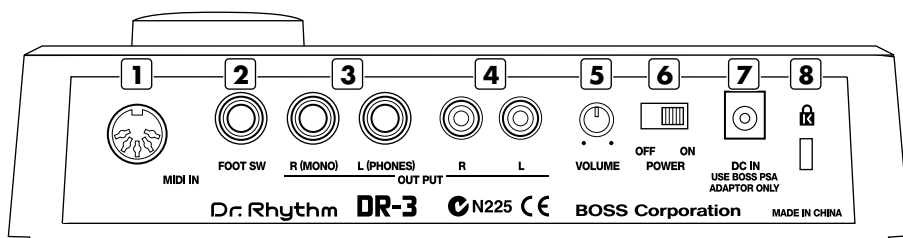

1. MIDI IN connector

External MIDI device can be connected to this connector.

2. FOOT SW (Switch) jack

By connecting a foot switch, you can obtain pedal control over the start and stop of performances, switching the patterns, or other actions.

3. OUTPUT jack R (MONO) / L (PHONES)

Provides output of the audio signals. Connect to your amp, stereo system, or similar equipment.

For monaural output use the R (MONO) jack.

For a set of headphones use the L (PHONES) jack.

* You cannot get monaural output while simultaneously using the headphones.

4. OUTPUT jack R / L

Provides output of the audio signals. Connect to your amp, stereo system, or similar equipment.

Connect cables having RCA phono plugs here.

5. VOLUME knob

Adjusts the volume from the OUTPUT jacks.

6. POWER switch

Switches the power on and off.

7. AC Adaptor jack

You can use a separately sold AC adapter (BOSS PSA series).

8. Security Slot ()

<http://www.kensington.com/>

Before You Play

Install Batteries

- 1 Make sure that the power is turned off.

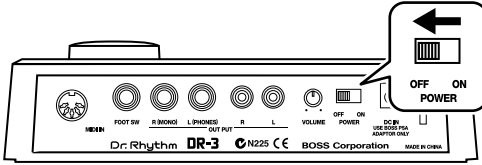

- 2 Remove the battery cover on the unit's underside.

- 3 Insert six AA batteries in the battery case, taking care to ensure that the positive (+) and negative (-) terminals are not reversed.

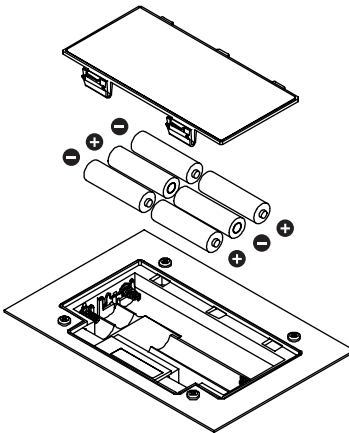

- 4 Close the battery cover.

NOTE

When turning the unit upside-down, get a bunch of newspapers or magazines, and place them under the four corners or at both ends to prevent damage to the buttons and controls. Also, you should try to orient the unit so no buttons or controls get damaged.

NOTE

When turning the unit upside-down, handle with care to avoid dropping it, or allowing it to fall or tip over.

MEMO

We recommend the use of alkaline batteries for extended battery life.

NOTE

Do not mix new batteries with partially used batteries, and do not mix batteries of differing types.

MEMO

When the battery power begins to run low, "Battery Low!" appears in the display when the power is turned on. When this occurs, replace with new (six AA) batteries.

Making Connections

The DR-3 is not equipped with an internal amp or speakers. To hear sound, either connect an amplifier and speakers or use stereo headphones.

Audio cables, MIDI cables, Stereo headphones, and foot switches are not included. Please purchase these items from your dealer.

1

Before you begin making connections, confirm the following.

- Is the volume level of the DR-3 or connected amp turned all the way down?
- Is the power to the DR-3 or connected amp turned off?

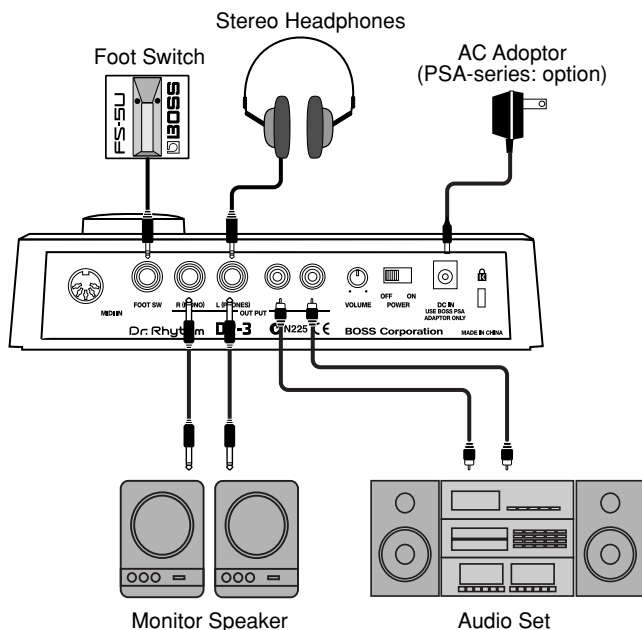

2

Connect the amp and audio gear, or the headphones as shown in the diagram.

In order to take full advantage of the DR-3's sound we recommend that you play it in stereo.

When using the system in mono, connect to the OUTPUT R (MONO) jack.

NOTE

To prevent malfunction and/or damage to speakers or other devices, always turn down the volume, and turn off the power on all devices before making any connections with the DR-3.



For instructions on connecting to the MIDI connectors, refer to p. 93.

For instructions on connecting to the FOOT SW jack, refer to p. 29.

NOTE

You cannot get monaural output while simultaneously using the headphones.

Turning On/Off the Power

■ Turning on the power

Once the connections have been completed (p. 16), turn on power to your various devices in the order specified. By turning on devices in the wrong order, you risk causing malfunction and/or damage to speakers and other devices.

1

Before you turn the power on, make sure of the following points.

- Are external devices connected correctly?
- Is the volume level of the DR-3 or connected amp turned all the way down?

2

Turn on the POWER switch located on the rear panel of the DR-3.

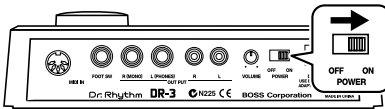

3

Turn on the power of the amp.

Press the flashing [INTRO/START] button to start the performance. Rotate the VOLUME knob on the rear panel to adjust the DR-3's volume level.

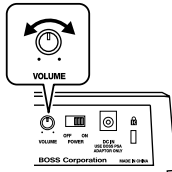

Also adjust the volume levels for amps and other connected gear.

■ Turning Off the Power

1

Before turning off the DR-3's power, make sure that:

- Is the volume level of the DR-3 or connected amp turned all the way down?

2

Switch off any amps and other external equipment.

3

Turn off the power of the DR-3.

NOTE

This unit is equipped with a protection circuit. A brief interval (a few seconds) after power up is required before the unit will operate normally.

MEMO

Press STOP [■] to stop the performance.

Reset to Default Factory Settings (Factory Reset)

This returns all settings on the DR-3 to the values they had when the unit shipped from the factory. This is called Factory Reset.

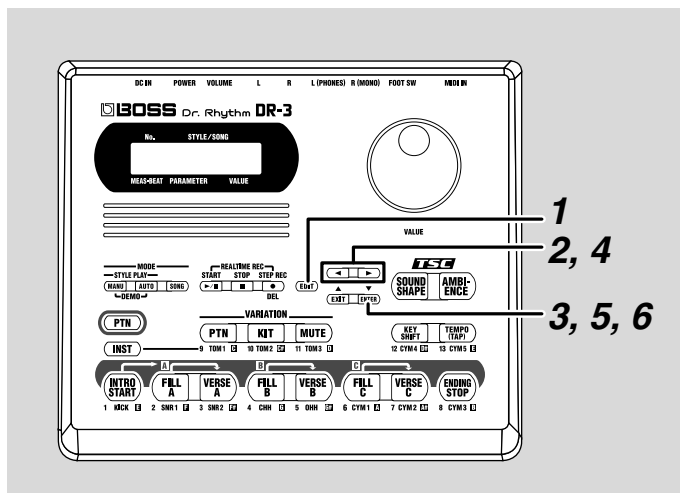

- 1** With the performance stopped, press [EDIT].

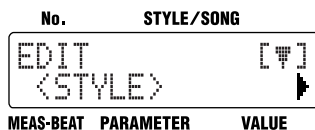

- 2** Press [▶] to select a <SYSTEM>.

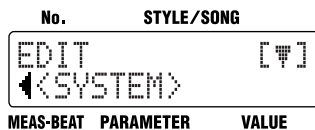

- 3** Press [ENTER].

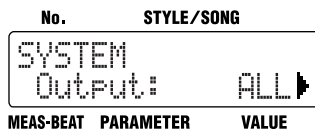

4

Press [▶] to select a <FACTORY RESET>.

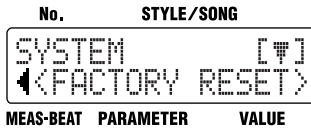

5

Press [ENTER].

A message confirming that you want to proceed with Factory Reset is displayed.

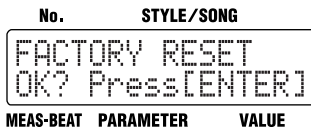

To cancel, press [EXIT].

6

To execute Factory Reset, press [ENTER].

Factory Reset is executed.

When Factory Reset is done, the previous screen is displayed.

All of the settings are restored to their original factory status.

Quick Start

This Quick Start manual describes how to enjoy performing the rhythm used in the DR-3's **Styles**.

Pre-programmed **Styles** are provided in Rock, Jazz, and a variety of other musical genres.

Once you select a **Style** in the desired genre, you can put together backing that matches your own performances by switching **Patterns**. The **Patterns** prepared for each **Style** include not only an "intro" and "ending," but up to three types of "fill-ins" and "verses" (main rhythm patterns). You can perform the rhythm in a variety of ways.

Let's Listen to the Demo

Now listen to the demo performance, which brings the DR-3's "Styles" to life.

The "Patterns" in the demo performance are switched automatically. The pattern pads light when the corresponding Patterns are playing.

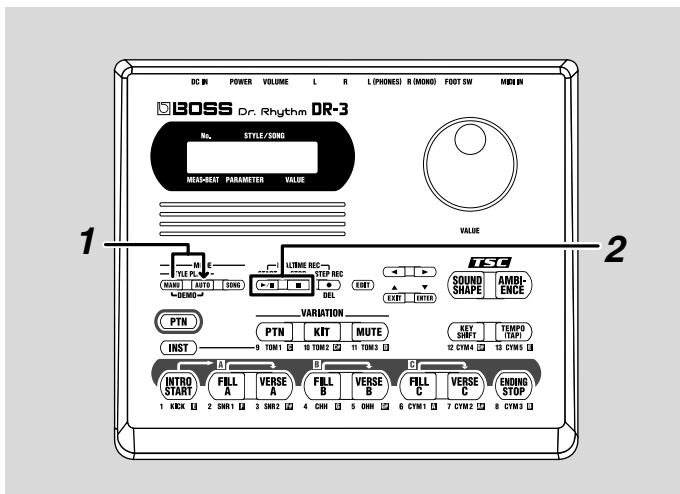

1 Hold down [MANU] and press [AUTO].

The DR-3 switches to Demo mode, and the performance begins. If a Pattern or song is playing, press STOP [■] to stop the performance, then perform Step 1.



The Style name which is playing, is displayed.

2 Press STOP [■] to stop the demo performance.

If you want to listen to the demo performance again, press START [▶/■].

MEMO

Songs and Patterns — Song performances require rhythm patterns that vary a little for each section of the performance (intro, fill-ins, ending, and so on). The DR-3 features eight prepared rhythm patterns expressing these variations within the songs. Eight patterns are grouped together in what is called a "Style." The DR-3 features 100 pre-programmed internal Styles (Preset Styles) to suit a variety of musical genres. You can also put together your own combinations of Patterns to create whole new Styles (User Styles).

NOTE

All rights reserved. Unauthorized use of this material for purposes other than private, personal enjoyment is a violation of applicable laws.

NOTE

You cannot switch Patterns by pressing the pattern pads while the demo performance is playing. For information about performances which do allow you to switch the Patterns, refer to "Let's Play a Style" (p. 22).

MEMO

When using [MANU], [AUTO], or [SONG] to switch modes, stop the performance first before you press the button.

Let's Play a Style

There are two ways to perform Styles, using "Manual mode," in which you switch the Pattern yourself, or "Auto mode," where the DR-3 switches Patterns automatically.
Now, try performing in Manual mode.

MEMO

For more information on "Auto mode," please refer to p. 31.

Performing Styles with Selecting Patterns ([MANU])

Each Style includes eight prepared rhythm patterns; intro, fill-in A, verse A, fill-in B, verse B, fill-in C, verse C and ending.
In Manual mode, you play switching Patterns yourself.

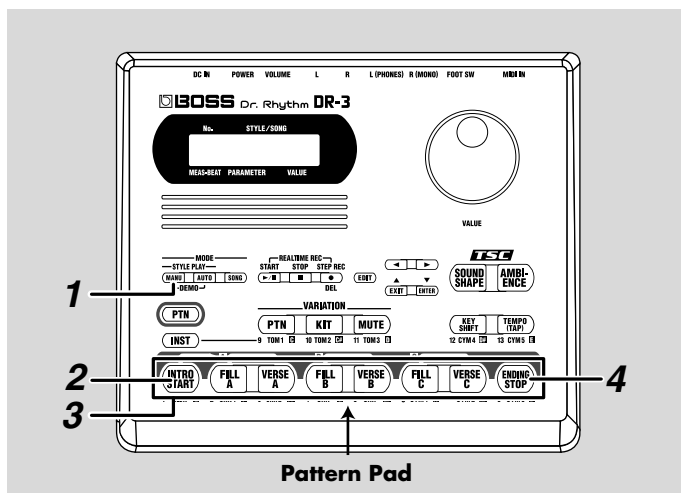

1

With the performance stopped, press [MANU] so the button lights up.

This puts the DR-3 in Manual mode.
The Style screen appears in the display.

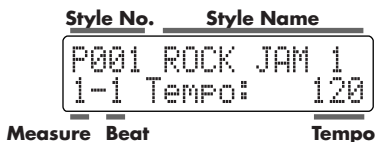

MEMO

If [INST] is lit, then drum or bass sounds are played when you press the pads (p. 58).
To switch Patterns with the pads, press [PTN] so that this button lights up.

2 Press [INTRO/START] to start the performance from the intro.

3 Press one of the pattern pads to switch Patterns.

The Patterns assigned to the pattern pads are shown below.

Pad Name	INTRO/START	FILL A	VERSE A	FILL B	VERSE B	FILL C	VERSE C	ENDING/STOP
Description	After the intro is played, the Style proceeds to Verse A.	After Fill-In A is played, the Style proceeds to Verse A.	This is the main performance Pattern.	After Fill-In B is played, the Style proceeds to Verse B.	This is a complementary Pattern to Verse A.	After Fill-In C is played, the Style proceeds to Verse C.	This is the most elaborate of the Patterns A–C.	The ending is played, and then the performance stops.

When you press a pattern pad, the pattern for the pad you've pressed will start playing as soon as the one that's currently playing has finished.

When you press [FILL], the fill-in is played, and then the verse corresponding to that fill-in is automatically played. For example, if you press [FILL A], the DR-3 automatically switches to [VERSE A] after the fill-in.

4 When you press [ENDING/STOP], the ending is played and then the performance stops.

MEMO

When you press a pattern pad other than [INTRO/START], the performance begins from that pattern.

MEMO

What is a Fill-In? —These are lively performance Patterns inserted in spaces between phrases and other points in songs and Styles. Fill-ins of up to one whole measure in length are played according to when you press the [FILL].

MEMO

To stop the Style without having the ending played, press STOP [■].

Performing Variations on Styles (VARIATION)

You can use the three VARIATION buttons to add variety to the performance, even with the same Style.

Button Name	PTN	KIT	MUTE
Description	The Pattern's variation is played.	This substitutes the kits, thereby changing the tone.	This mutes a part of the drum set.

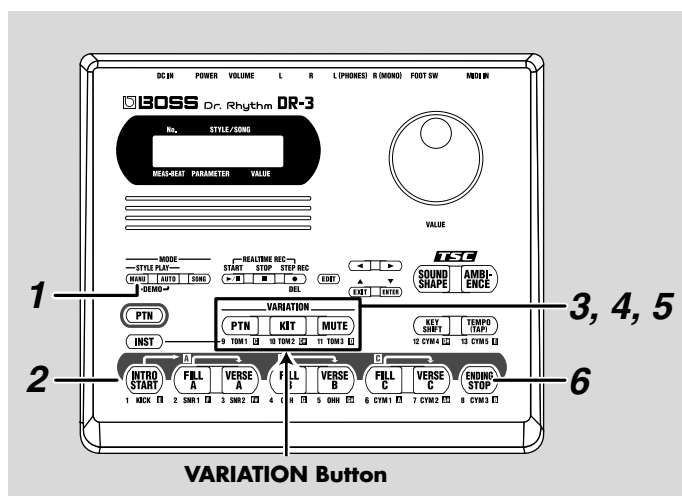

1

With the performance stopped, press [MANU] so the button lights up.

This puts the DR-3 in Manual mode.

2

When you press [INTRO/START], the performance starts from the intro.

3

Press VARIATION [PTN].

VARIATION [PTN] lights up, and the variation for the Pattern currently being performed is played.

When you press VARIATION [PTN] once again, the button's light goes out, and the original Pattern is played.

MEMO

What is a Kit? — These are sounds, selected from those built into the DR-3, consisting of 26 drum sounds and one bass sound that are grouped together as a single set.

MEMO

The settings used when you press a VARIATION button differ according to the Style.

MEMO

You can use the VARIATION buttons not only in Manual mode, but in Auto mode and Song mode (p. 37) as well.

NOTE

The VARIATION [PTN] button does not have any effect on patterns other than verses.

4**Press VARIATION [KIT].**

VARIATION [KIT] lights up, and the drum set and bass sounds changes.

When you press VARIATION [KIT] once again, the button's light goes out, and the original Pattern is played.

5**Press VARIATION [MUTE].**

VARIATION [MUTE] lights up, and a part of sounds are muted.

When you press VARIATION [MUTE] once again, the button's light goes out, and the muted sounds play again.

6

When you press [ENDING/STOP], the ending is played and then the performance stops.

MEMO

With some Styles, the sound may not change.

Selecting Styles

The DR-3 comes with 100 pre-programmed Styles already built in.

Now try listening to some of the different Styles.

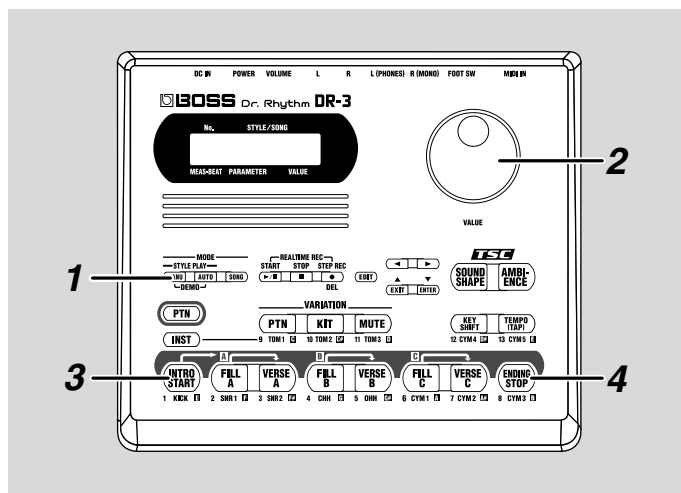

- 1 With the performance stopped, press [MANU] so the button lights up.

The Style screen appears in the display.

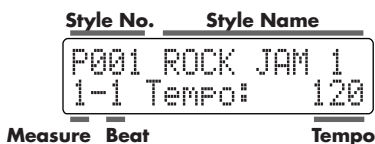

- 2 Turn the VALUE dial to select a Style.

- 3 Press [INTRO/START] to start the performance from the intro.

You can change Styles by turning the VALUE dial, even during the performance.

- 4 When you press [ENDING/STOP], the ending is played and then the performance stops.

MEMO

You can also create your own Styles. For more information, refer to “Chapter 7 Creating Styles” (p. 61).

MEMO

If you switch the style during its performance, a “” mark appears in front of the style name which will be played next.

The style switches after the currently playing pattern ends, and the “” mark disappears.

MEMO

When you press a pattern pad other than [INTRO/START], the performance begins from that pattern.



“Preset Style List” (p. 116)

Changing the Tempo ([TEMPO])

Now let's try changing the performance tempo.

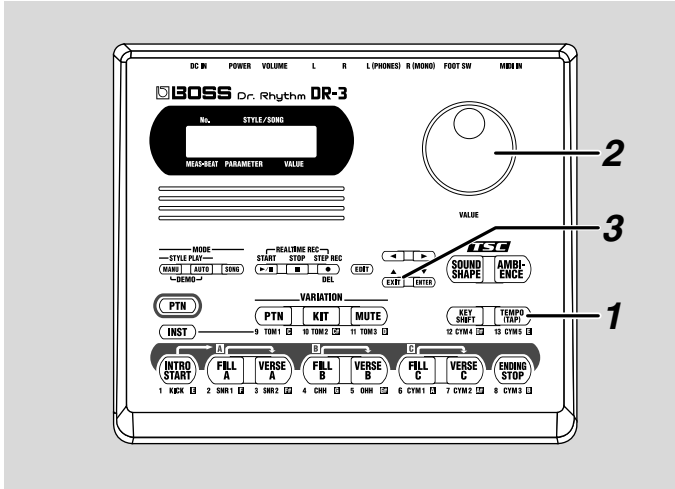

- 1 Press [TEMPO (TAP)].

The Tempo screen appears.



- 2 Adjust the tempo with the VALUE dial.
The tempo can be set to any value from 20 to 260.
- 3 Press [EXIT] to return you to the previous screen.

■ Setting the Tempo by Tapping It Out (Tap Tempo)

You can have the tempo be set to match an interval that you've demonstrated by tapping the button. This function is called "Tap Tempo."

- 1 Press [TEMPO (TAP)] at least four times.

The interval between presses of the button is set as the tempo.

Changing the Key ([KEY SHIFT])

You can perform Styles in different keys (transposed). This function is called "Key Shift."

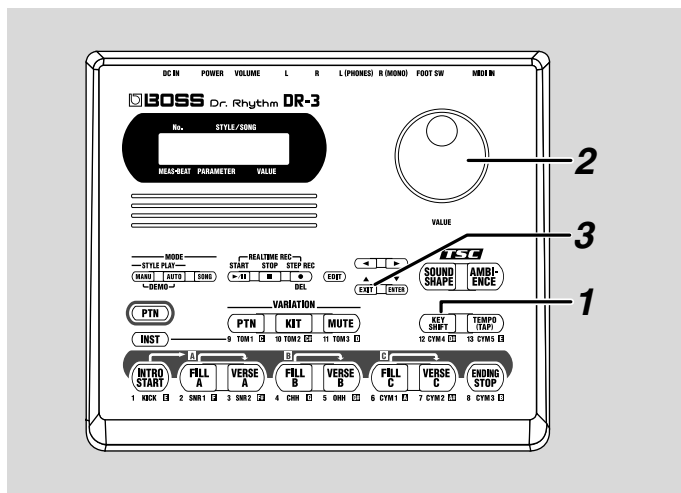

1

Press [KEY SHIFT].

The Key Shift screen appears.



2

Set the key with the VALUE dial.

You can set the value in semitone units within the range from -12 to +12, or one octave lower to one octave higher.

This changes the key of the performance.

3

Press [EXIT] to return you to the previous screen.

To return to the original key, press [KEY SHIFT], then set the key to "0" using the VALUE dial.

Let's Use a Foot Switch

You can use a foot switch (such as the optional FS-5U) to start and stop performances and switch verses (p. 23). This is convenient, as it allows you to switch the Patterns with your foot. You can connect up to two foot switches.

Connecting the Foot Switch

1

Connect the foot switch to the FOOT SW jack on the rear panel.

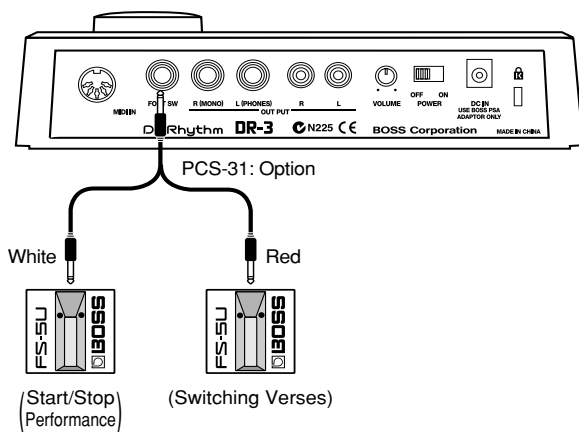

When Connecting Two Foot Switches

With the factory settings, foot switches connected using the plug with a white ring are used for starting and stopping performances, and foot switches connected using the plug with a red ring are used for switching verses.

NOTE

To prevent malfunction and/or damage to speakers or other devices, always turn down the volume, and turn off the power on all devices before connecting a foot switch.

NOTE

A special PCS-31 cable (optional) is required when connecting two foot switches.

MEMO

When connecting the foot switch (the optional FS-5U) to the FOOT SW jack, set the polarity switch as shown in the following figure.

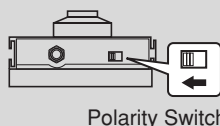

MEMO

You can change the foot switch functions. For more details, refer to "Assigning Functions to the Foot Switch" (p. 49).

Using the Foot Switch

The example here describes use of the DR-3 with two foot switches connected.

When you have only one foot switch connected, you can only use it to start and stop the performance.

1 With the performance stopped, press [MANU] so the button lights up.

This puts the DR-3 in Manual mode.

2 When you press the foot switch connected with the plug with a white ring, the performance begins.

The performance starts from the intro.

3 Pressing the foot switch connected with the plug that has a red ring switches to the next verse after the verse currently being played.

4 When you press the foot switch connected with the plug with the white ring, the ending is played, and then the performance stops.

MEMO

You can change the foot switch functions. For more details, refer to "Assigning Functions to the Foot Switch" (p. 49).

MEMO

When you press the foot switch with the red ring, a fill-in is played after the verse currently being played, and the performance switches to the next verse. Pressing the foot switch while Verse A is playing switches the performance to Verse B, pressing the foot switch during Verse B switches the performance to Verse C, and pressing the foot switch during Verse C switches the performance to Verse A. By continuing to press the foot switch, you can select subsequent verses according to the number of times you press the foot switch.

Let's Perform with the Patterns Switched Automatically ([AUTO])

When you perform Styles in Auto mode, the DR-3 switches the Patterns automatically, even without the pattern pads being pressed.

This lets you enjoy session-like performances without having to take your hands off the guitar or other instrument you are playing.

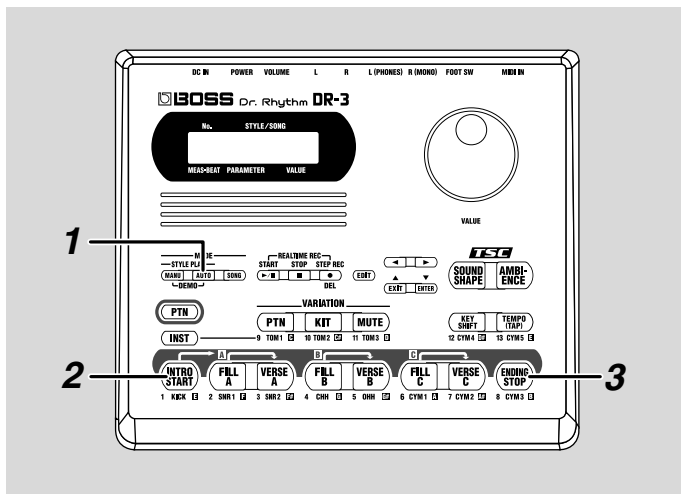

1

With the performance stopped, press [AUTO] so the button lights up.

This puts the DR-3 in Auto mode.



2

Press [INTRO/START] to start the performance from the intro.

In Auto mode, the Patterns are played automatically, repeating the sequence of INTRO → VERSE A → FILL B → VERSE B → FILL C → VERSE C → FILL A → VERSE A... and so on (according to the factory settings).

3

When you press [ENDING/STOP], the ending is played and then the performance stops.

MEMO

You can change the Pattern progression in Auto mode. For more details, refer to “Changing the Pattern Progression in Auto Mode” (p. 47).

MEMO

To stop the Style without having the ending played, press STOP [■].

Let's Change the Overall Tone of the Sound and Acoustics (TSC)

“TSC,” short for “Total Sound Control,” is a function that lets you change the acoustic effects for the overall performance just by pressing a few buttons.

TSC includes two types of effect, “Sound Shape,” which changes the overall tone of the sound, and “Ambience,” which alters the overall acoustic characteristics.

MEMO

You can save your preferred “Sound Shape” and “Ambience” settings. For more details, refer to “Changing the Sound Shape Parameters” (p. 53) and “Changing the Ambience Parameters” (p. 56).

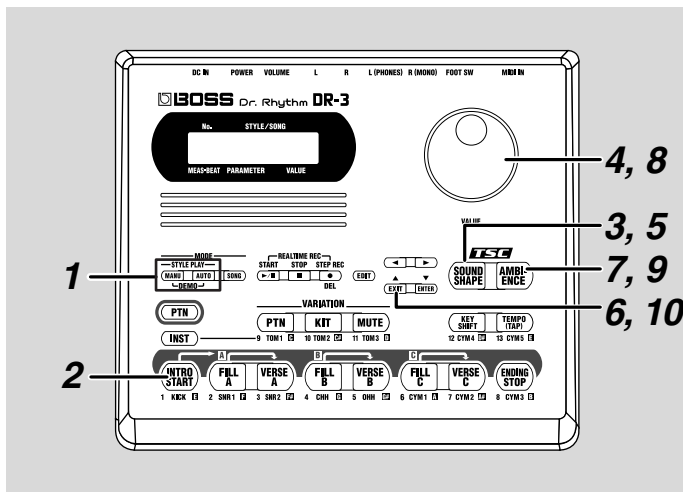

1 With the performance stopped, press [MANU] or [AUTO] so the button lights up.

2 Press [INTRO/START] to start the performance.

3 Press TSC [SOUND SHAPE].

The TSC screen is displayed.



4 Turn the VALUE dial to select a Sound Shape effect.

5 Press [SOUND SHAPE] so the button lights up.

Sound Shape is applied to the performance.

Each time you press [SOUND SHAPE], it alternately turns the button on (lit) and off (unlit).

6 Press [EXIT] to return you to the previous screen.

7 Press TSC [AMBIENCE].

The TSC screen is displayed.

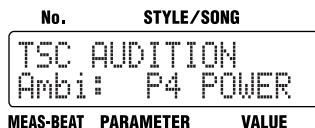

8 Turn the VALUE dial to select a Ambience effect.

9 Press [AMBIENCE] so the button light up.

Ambience is applied to the performance.

Each time you press [AMBIENCE], it alternately turns the button on (lit) and off (unlit).

10 Press [EXIT] to return you to the previous screen.

When you press [ENDING/STOP], the ending is played and then the performance stops.

MEMO

For more details about Sound Shape and Ambience, refer to "Chapter 5 Changing the Overall Tone of the Sound and Acoustics (TSC)" (p. 51).

Chapter 1 Overview of the DR-3

The DR-3's Performance Modes

The DR-3 features two performance modes, **Style Play mode**, in which the rhythm patterns are switched as you play, and **Song mode**, in which you create data by arranging the patterns beforehand, and then perform.

Furthermore, "Style Play mode" features a **Manual mode**, in which you switch the rhythm patterns yourself, and an **Auto mode**, where the rhythm patterns are switched automatically.

A **Style** contains a set of rhythm patterns that are needed for performance of a song. In order to perform a song, you need to have different rhythm patterns set in different parts of the song. For example, a rhythm pattern may change like this: Intro/melody A/melody B/chorus/ending. To express the variation in such a song, each Style includes eight prepared rhythm patterns.

The DR-3 includes 100 different Preset Styles (internal Styles) in rock, jazz, and various other genres, so you can play all the rhythm patterns for a single song by selecting the genre you want to play in and then switching the patterns.

A **Song** is created by arranging the sequence of rhythm patterns that make up the song.

You can also create a song by setting up a sequence of patterns from different Styles. What's more, you can prepare further song data after you have created a song by editing parts of a song, for example by changing bass phrases.

Switch between these three modes with the MODE button shown below.

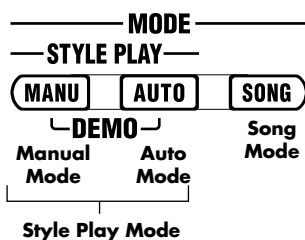

Style Play Mode

Manual Mode

Switch to Manual mode by pressing the MODE [MANU] button.

In Manual mode, you can switch patterns by pressing the pattern pads. You can perform freely as you switch the patterns.

Auto Mode

Switch to Auto mode by pressing the MODE [AUTO] button.

In AUTO mode, you can have patterns switch automatically after the performance starts, which then lets you enjoy jamming.

* When using a MODE button to switch modes, stop the performance first before you press the button.

Makeup of a Style

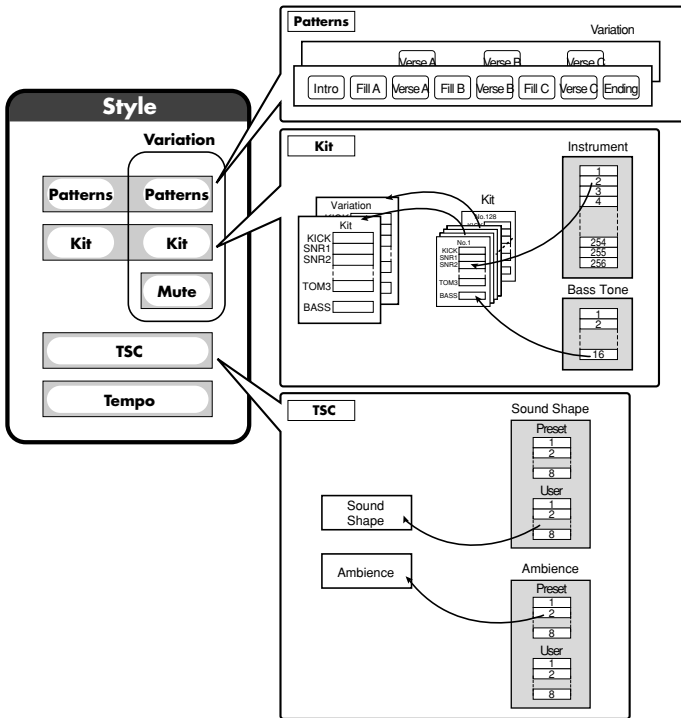

Patterns

The following eight patterns are set up for the different parts of the song.

Pattern Name	Description
INTRO	This is played at the beginning of the song.
VERSE A, B, C	These are the main performance Patterns. A is the basic performance Pattern, and B and C are Patterns complementary to Verse A.
FILL A, B, C	These are lively performance Patterns inserted in spaces between phrases and other points in songs. Select Fill-In A, B, or C according to the verse you want to have played after the fill-in.
ENDING	This is the performance Pattern used to finish the song.

Each of the eight patterns is assigned to a pattern pad. Press the pattern pads as the Style is played to switch the patterns.

Pattern Pad

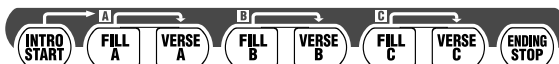

Kits

The drum, percussion, and bass sounds used in performing patterns are referred to as “kits.” The Styles have predetermined kits assigned to them, so you can change kits by changing Styles, and thus change the sounds played with the pads.

Variation

Variation is a function that alters performances, for example building up the performance or toning it down.

There are three kinds of variations, [PTN] (Pattern), [KIT], and [MUTE].

[PTN]	[KIT]	[MUTE]
This alternates the Pattern.	This substitutes the kits, thereby changing the sound.	This mutes a part of the drum set. This is used to tone down the performance and bring solos out to the forefront.

The three kinds of variations are switched on and off with the VARIATION [PTN], [KIT] and [MUTE].



TSC

“TSC,” short for “Total Sound Control,” is a function that lets you change the overall tone of the sound and acoustics.

TSC includes two kinds of effects, “SOUND SHAPE” and “AMBIENCE.”

“SOUND SHAPE” adjusts the overall tone of the sound with a three-band equalizer and three-band compressor that are used to boost or cut specific pitches (frequency bands).

“AMBIENCE” adjusts the breadth of the sound by altering the acoustic characteristics of the sound.

You can select the TSC settings that sound best with each Style, and you can switch [SOUND SHAPE] and [AMBIENCE] on and off independently.



Tempo

Each Style includes a tempo setting suited to that Style.

After you select a Style, you can perform with a different tempo, and even change the tempo while the performance is in progress.

Song Mode

Switch to Song mode by pressing the MODE [SONG] button.

In Song mode, you create songs by recording the sequence in which the patterns are to be played, or play the song that you have created.

* When using a MODE button to switch modes, stop the performance first before you press the button.

Switching the Pad Functions

The DR-3's [PTN] and [INST] are used to switch between two different functions.

Specifying Patterns with the Pads ([PTN] is Lit)

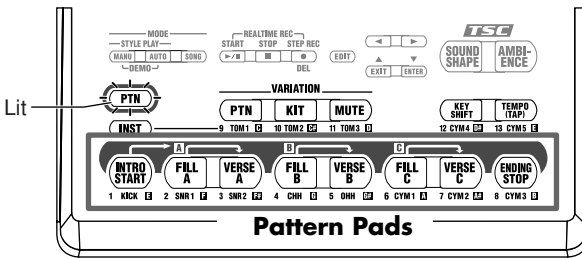

When you press [PTN], you can then switch the patterns with the pattern pads.

Furthermore, you can press the VARIATION [PTN], [KIT], [MUTE], [KEY SHIFT], and [TEMPO (TAP)] to use the functions marked for each of these buttons.

Playing Instruments (Instrument Sounds) with the Pads ([INST] is Lit)

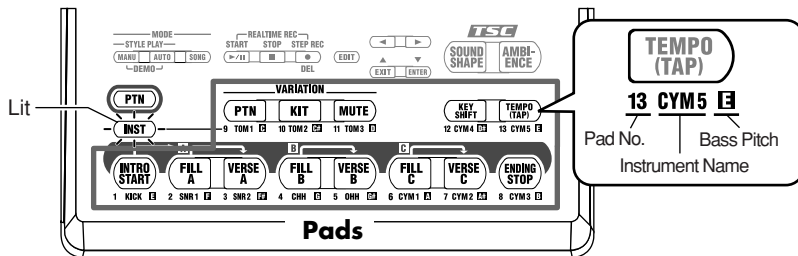

When you press [INST], different sounds are assigned to the pads, and you can then press the pads to play these drum and bass sounds. The instrument names and the bass pitch names assigned to the pads are printed under each pads.

You cannot use the VARIATION [PTN], [KIT], [MUTE], [KEY SHIFT], and [TEMPO (TAP)] functions when [INST] is lit.

Also, when [INST] is lit, you can use the VALUE dial or [INST] to switch the sound groups (drums, percussion, bass) for the pads.

Main Screens and Functions

Style screen

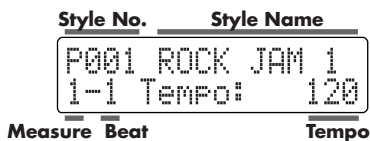

With the performance stopped, pressing [MANU] or [AUTO] causes the button to light up, switches the DR-3 to Style Play mode, and calls up the Style screen.

When the DR-3 is in Style Play mode, pressing the [EXIT] button returns the Style screen to the display.

Song screen



With the performance stopped, pressing [SONG] causes the button to light up, switches the DR-3 to Song mode, and calls up the Song screen.

When the DR-3 is in Song mode, pressing the [EXIT] button returns the Song screen to the display.

Edit screen

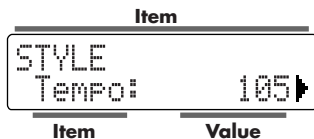

With the performance stopped, pressing [EDIT], switches the DR-3 to Edit mode, and calls up the Edit screen.

In Edit mode, you can press [◀] [▶] to switch “pages,” turn the VALUE dial to change the values, press [ENTER] to set the values, and press [EXIT] to cancel operations.

Step Recording screen



In Style Play mode ([MANU] or [AUTO] lit), you can press STEP REC [●] to start Step Recording and call up the Step Recording screen.

When you press STOP [■], recording stops and you're returned to the Style screen.

Realtime Recording screen

<u>Style No.</u>	<u>Pattern Name</u>
U001	INTRO
1-1	Pad: DRUM ♯

Measure Beat Sound Group Quantize

When you press START [▶/■] after pressing STEP REC [●] in Style Play mode ([MANU] or [AUTO] lit), Realtime Recording starts and the Realtime Recording screen is displayed.

When you press STOP [■], recording stops and you're returned to the Style screen.

Velocity Edit screen

<u>Measure</u>	<u>Beat</u>	<u>Tick</u>
VELO EDIT	1-1	00
<DRUM KICK:	127	>

Pad Name Velocity

When you press [EDIT] during Style Step Recording (STEP REC [●] lit), the Velocity Edit screen is displayed.

Pressing [EXIT] returns you to the Step Recording screen.

Song Recording screen

<u>Song No.</u>	<u>Style No.</u>
S001	Style:P001
001	VERSE A

Measure Pattern Name

In Song mode ([SONG] lit), you can press STEP REC [●] to start Step Recording and call up the Song Recording screen.

In Song mode, the Song Recording screen is also displayed during Realtime Recording.

When you press STOP [■], recording stops and you're returned to the Song screen.

Song Edit screen

<u>Item</u>	<u>Value</u>
INS [ROCK	JAM 1]
Style:	P001▶

Item Value

When you press [EDIT] during Step Recording (STEP REC [●] lit) in Song mode ([SONG] lit), the Song Edit screen is displayed.

Pressing [EXIT] returns you to the Song Recording screen.

■ Starting and Stopping Performances and Recording

Use these buttons to start, pause, stop, and record performances of Styles and songs.

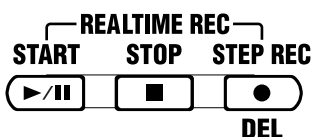

START [▶/||]

Press START [▶/||] when the performance is stopped to start the performance of the Style or song.

When you press START [▶/||] while the performance is playing, the performance of the Style or song is paused. Press the button once again to resume the performance from the point where it was paused.

If you press START [▶/||] while Step Recording (STEP REC [▶/||] lit) is in progress, Realtime Recording will start.

STOP [■]

This stops the performance and recording of the Style or song.

STEP REC [▶/||]

This starts Step Recording of Styles and songs.

If you press START [▶/||] while Step Recording (STEP REC [▶/||] lit) is in progress, Realtime Recording will start.



Realtime recording...p. 65, p. 77

Step recording...p. 67, p. 76



Notes Concerning Editing and Recording

Edited or recorded data is not saved if the power is turned off while editing or recording is still in progress. Be sure to carry out the following.

- To quit editing, press [EXIT].
- To finish recording press STOP [■].

The message “Keep Power ON! Now Working...” appears when these operations are in progress.

Never turn off the power while this message is displayed.

■ Adjusting the Tempo ([TEMPO])

Use the following procedure to adjust Style and song tempos.

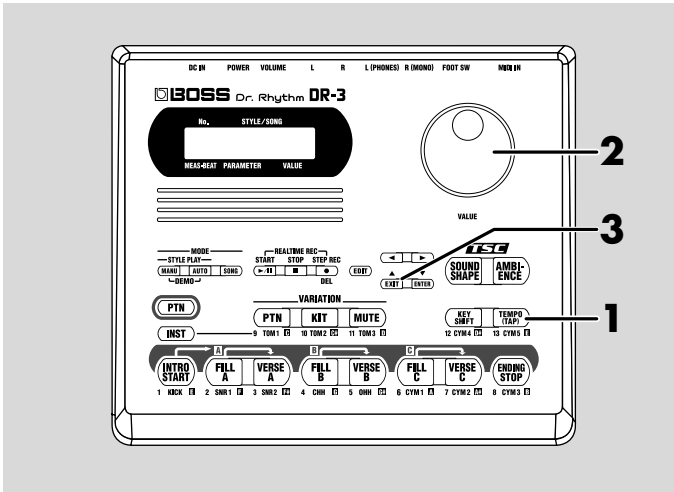

1. Press [TEMPO (TAP)].

The Tempo screen appears in the display.



2. Adjust the tempo with the VALUE dial.

The tempo can be set to any value from 20 to 260.

3. Press [EXIT] to return to the previous screen.



You can tap [TEMPO (TAP)] at least four times to set the tempo to the interval between the taps. For more details, refer to “Setting the Tempo by Tapping It Out (Tap Tempo)” (p. 27).

■ Changing the Key of the Performance ([KEY SHIFT])

Use the following procedure to change the key of the Styles and songs (transposing).

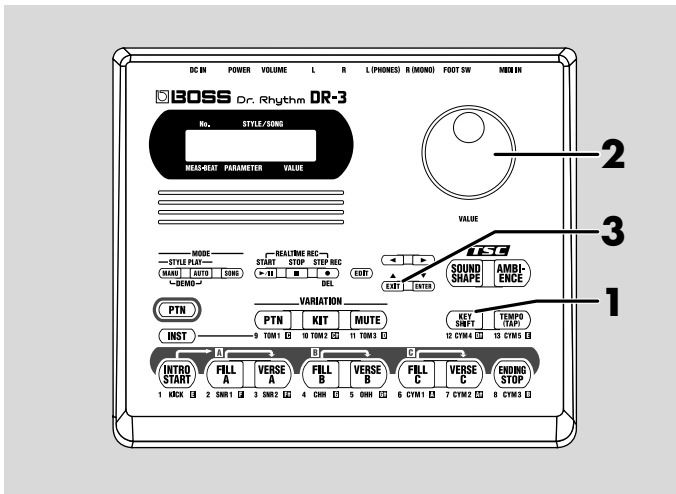

1. Press [KEY SHIFT].

The Key Shift screen appears in the display.



2. Set the key with the VALUE dial.

You can set the value in semitone units within the range from -12 to +12, or one octave lower to one octave higher. This changes the key of the performance.

3. Press [EXIT] to return to the previous screen.

To return to the original key, press [KEY SHIFT], then set the key to "0" using the VALUE dial.

MEMO

If notes whose pitches are changed using the Key Shift function are in registers that are unplayable for the DR-3, the notes in the expressible range above or below that octave are sounded.

Chapter 2 Playing Styles (Manual Mode [MANU])

The DR-3 features 100 pre-programmed internal Styles in a variety of musical genres. You can perform by selecting the Styles and switching the Patterns in "Manual mode."

■ How the Pads Work When Performing Styles

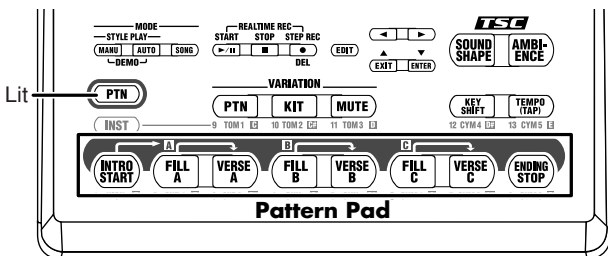

The DR-3's pads can be switched between two modes of operation, [PTN] and [INST] (p. 37).

Patterns are switched with the pads when [PTN] is lit. When switching Patterns and performing Styles in Manual mode, be sure to confirm that [PTN] is lit.

Selecting Styles

Use this procedure to select the Styles to be performed.

1. With the performance stopped, press [MANU] so the button lights up.

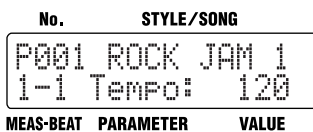

2. Turn the VALUE dial to select a Style.

Style numbers for the Preset Styles (internal Styles) are preceded by a "P"; Style numbers for the User Styles (p. 61) are preceded by a "U."



For more on "Auto mode," in which the Patterns are selected automatically, refer to "Chapter 3 Playing Styles (Auto Mode [AUTO])" (p. 46).



For more on creating Styles, refer to "Chapter 7 Creating Styles" (p. 61).

MEMO

When [INST] is lit, drum and bass sounds are played with the pads while the patterns are in progress.

For more information on [INST], refer to "Chapter 6 Performing with the Pads" (p. 58).

MEMO

If you switch the style during its performance, a "⬆" mark appears in front of the style name which will be played next.

The style switches after the currently playing pattern ends, and the "⬆" mark disappears.

MEMO

Depending on its settings, there may be some delay for the TSC (p. 51) to change, if the style is switched while it is being performed.



"Preset Style List" (p. 116)

Selecting the Patterns to be Played

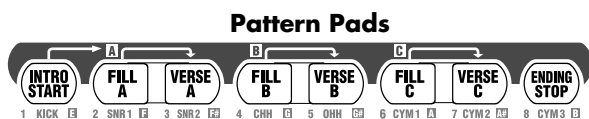

A single Style is divided into eight performance units called "Patterns," which are assigned to the pattern pads.

Pattern Pad	INTRO/START	FILL A	VERSE A	FILL B	VERSE B	FILL C	VERSE C	ENDING/STOP
Description	After the intro is played, the Style proceeds to Verse A.	After Fill-In A is played, the Style proceeds to Verse A.	This is the main performance Pattern.	After Fill-In B is played, the Style proceeds to Verse B.	This is a complementary Pattern to Verse A.	After Fill-In C is played, the Style proceeds to Verse C.	This is the most elaborate of the Patterns A–C.	The ending is played, and then the performance stops.

Starting/Stopping

1. Press any pattern pad.

With the performance stopped, press any of the pattern pads to start the performance.

When you press [INTRO/START], the performance starts from the intro. After the intro is played, the Style proceeds to Verse A.

2. Press [ENDING/STOP].

The ending is played, and then the performance stops.

If you press STOP [■], the performance stops without the ending being played.

How to Change Patterns

1. Press any of the pattern pads while the performance is in progress.

If while a Pattern is being played you press a pad for a different Pattern, the pad you have pressed begins to flash, indicating that this is to be the next Pattern played. When the currently playing pattern ends, the pattern is switched, and the pad that was flashing will instead light steadily.

When you press any of the [FILL A–C] buttons, a fill-in of up to one measure in length is played, and that is followed by the corresponding [VERSE A–C].

When you press [ENDING/STOP], the ending is played, and then the performance stops.

Selecting Variations (VARIATION)

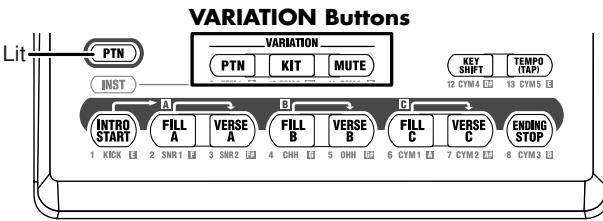

Each Style includes three different variations, which you can use to add variety to the performance, even with the same Style.

The functions of the three VARIATION buttons are described below.

Button Name	PTN	KIT	MUTE
Description	This alternates the Patterns.	This substitutes the kits, thereby changing the sound.	This mutes a part of the drum set.

1. While the performance is in progress, press VARIATION [PTN], [KIT], or [MUTE] so the button lights up.

The pressed button lights up (indicating it is on).

When you press the button once more, the button's light goes out (indicating it is off), and the original Pattern is played.

You can also perform with more than one of these buttons on.

MEMO

You can use the VARIATION buttons not only in Manual mode, but in Auto mode (p. 46) and Song mode (p. 85) as well.

MEMO

The settings used when you press a VARIATION button differ according to the Style.

Chapter 3 Playing Styles (Auto Mode [AUTO])

When you perform Styles in Auto mode, the DR-3 switches the Patterns automatically, even without the pattern pads being pressed.

This lets you enjoy session-like performances without having to take your hands off the guitar or other instrument you are playing. When performing in Auto mode, the Patterns are basically played in the following sequence. You can also press a button other than [INTRO/START] to begin the performance from that Pattern.



“Patterns” (p. 35)

● Pattern Progression in Auto Mode

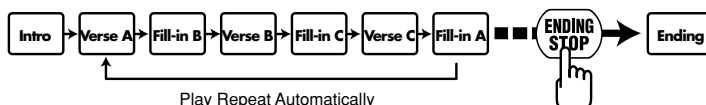

Selecting a Style

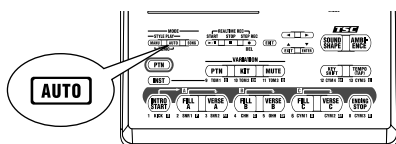

1. With the performance stopped, press [AUTO] so the button lights up.
2. Turn the VALUE dial to select a Style.

Style numbers for the Preset Styles (internal Styles) are preceded by a “P”; Style numbers for the User Styles (p. 61) are preceded by a “U.”

Performing in Auto Mode

1. Press any of the pattern pads.

When the performance of the Pattern initially specified is finished, the next Pattern is played automatically.

To see the sequence in which the Patterns are played, please refer to the figure “Pattern Progression in Auto Mode.”

If you press a pattern pad while the performance is in progress, the Style switches to the Pattern corresponding to the pressed pad, and the performance then continues by repeating the Pattern progression sequence.

2. When you press [ENDING/STOP], the ending is played and then the performance stops.

To stop the Style without having the ending played, press STOP [■].

MEMO

You can change the Pattern progressions and the number of measures repeated. Refer to “Changing the Pattern Progression in Auto Mode” (p. 47).

MEMO

When [INST] is lit, drum and bass sounds are played with the pads while the patterns are in progress.

For more information on [INST], refer to “Chapter 6 Performing with the Pads” (p. 58).

MEMO

When the performance is stopped, pressing any pattern pad will start the performance.

■ Changing the Pattern Progression in Auto Mode

You can change the pattern progression when performing in Auto mode.

1. With the performance stopped, press [EDIT].

The Edit Menu screen appears.

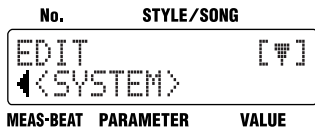

2. Press [▶], select a <SYSTEM>, then press [ENTER].

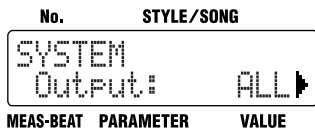

3. Press [▶], select a <Auto Type> to be set.



4. Turn the VALUE dial to set the value.

Parameter	Value
AutoType	ABC, ABC 4, ABC 8, ABC 16, AB, AB 4, AB 8, AB 16

The letters indicates the sequence of the verses.

The numeral represents the number of measures performed in each verse.

When the number of measures has been specified by means of a value that has been set, then regardless of the original number of measures in each verse, the verse is repeated only for the number of measures specified.

Example: When performing a Style with a Verse A of four measures, a Verse B of two measures, and Verse C of two measures.

- With "ABC" for "AutoType"

The sequence with Verses A, B, and C played once each is repeated.

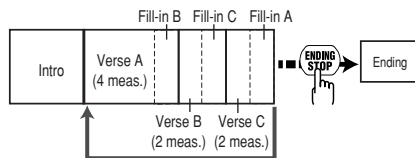

Performance repeats automatically

- With "ABC4" for "AutoType"

The sequence in which four measures of Verses A, B, and C are played is repeated.

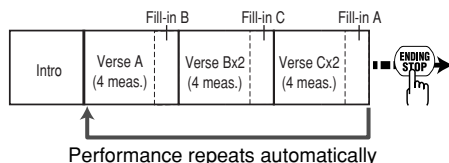

Performance repeats automatically

5. Press [EXIT] a number of times until you exit Edit mode.

Chapter 4 Controlling the Styles with a Foot Switch

You can use a foot switch (such as the optional FS-5U) to start and stop performances and switch verses (p. 44). This is convenient, as it allows you to switch the Patterns with your foot.

You can connect up to two foot switches.

When using the special cable (PCS-31), the foot switch connected with the white-striped plug is used to start and stop performances, and the foot switch connected with the red-striped plug is used to switch verses (as set at the factory).

Starting and Stopping Performances

You can use a foot switch to start and stop the performance of Styles and songs (p. 85).

1. With the performance stopped, press the foot switch.

When [MANU] or [AUTO] is lit: performance of the Style begins from the intro.

When [SONG] is lit: performance of the song begins.

2. Press the foot switch while the performance is in progress.

When [MANU] or [AUTO] is lit: the ending is played, and then the performance stops.

When [SONG] is lit: the song stops.

Switching Verses

You can press the foot switch during performance of the Style to have a fill-in inserted in the current verse and then switch to the next verse. For example, if you press the foot switch while Verse A is playing, the DR-3 inserts a fill-in B and switches to Verse B.

1. Press the foot switch while the performance is in progress.

A fill-in is inserted, and the DR-3 switches to the verse following the verse currently being played.

Pressing the foot switch while Verse A is playing switches the performance to Verse B, pressing the foot switch during Verse B switches the performance to Verse C, and pressing the foot switch during Verse C switches the performance to Verse A.

By continuing to press the foot switch, you can select subsequent verses according to the number of times you press the foot switch. Pressing the switch while the performance is in progress switches the DR-3 to the next verse specified for the song.

MEMO

For instructions on connecting the foot switch, refer to “Connecting the Foot Switch” (p. 29).

NOTE

During recording or editing in Edit mode (p. 38), depressing the foot switch will have no effect.

MEMO

Wiring diagrams for the foot switch jack is shown at below.

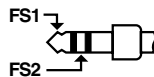

MEMO

If two foot switches are connected, press the foot switch connected using the plug with the white ring.

MEMO

When connecting two foot switches, press the foot switch connected using the plug with the red ring. If you have only one foot switch connected, use the procedure described in the following section “Assigning Functions to the Foot Switch” to assign “VERSE, LOOP” to the foot switch.

Assigning Functions to the Foot Switch

You can assign functions other than starting and stopping performances and switching verses to the foot switch.

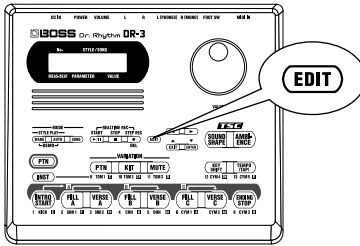

1. Press the [EDIT] button.
2. Press [▶] to select a <SYSTEM>.

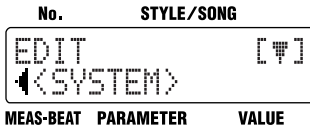

3. Press [ENTER].
4. Press [◀][▶] to select a <FS1> or a <FS2>.

If you have two foot switches connected using the special cable (PCS-31), select <FS1> when making settings for the foot switch with the white ring, and <FS2> when making settings for the foot switch connected using the plug with the red ring.

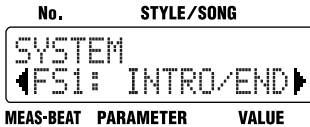

5. Turn the VALUE dial to select the function to be assigned.

Refer to the following chart to see which functions can be assigned.

Press [EXIT] a number of times to return to the previous screen.

MEMO

With the factory settings, <FS1> is set to "INTRO/END" and <FS2> is set to "VERSE, LOOP."

Functions That Can Be Assigned to Foot Switches

Settings	Function
INTRO/ END	<p>When [MANU] or [AUTO] is lit: When the foot switch is pressed while the performance is stopped, the performance starts from the intro. If the foot switch is pressed while the performance is in progress, the ending is played, and then the performance stops.</p> <p>When [SONG] is lit: When the foot switch is pressed while the performance is stopped, the performance of the song begins, and if pressed while the performance is in progress, the performance stops.</p>
VERSE, LOOP	<p>When [MANU] or [AUTO] is lit: A fill-in is played after the verse currently being played, and the performance switches to the next verse in the Pattern. Pressing the foot switch while Verse A is playing switches the performance to Verse B, pressing it during Verse B switches the performance to Verse C, and pressing it during Verse C switches the performance to Verse A. No action results when the foot switch is pressed during the intro or ending. By continuing to press the foot switch, you can select subsequent verses according to the number of times you press the foot switch.</p> <p>When [SONG] is lit: The function that is used when you press the pedal varies according to the [EDIT] <SONG> “LoopType” setting. * Refer to “Switching Patterns With a Foot Switch” (p. 86)</p>
VAR PTN	This has the same function as VARIATION [PTN] (p. 45).
VAR KIT	This has the same function as VARIATION [KIT] (p. 45).
VAR MUTE	This has the same function as VARIATION [MUTE] (p. 45).

Settings	Function
TAP TEMPO	When the foot switch is pressed four or more times, the tempo is specified according to the interval between each press (Tap Tempo, p. 27).
STRT/ PAUSE	This has the same function as START [▶/■].
START/ STOP	When the foot switch is pressed while the performance is stopped, the performance begins, and if pressed while the performance is in progress, the performance stops.
STYLE FWD	This switches from the Style currently being played to the next higher-numbered Style. * If the current Style number is “P100,” the DR-3 switches to “U001”; if the current Style number is “U100,” the DR-3 switches to “P001.”
STYLE BWD	This switches from the Style currently being played to the Style one number lower. * If the current Style number is “P001,” the DR-3 switches to “U100”; if the current Style number is “U001,” the DR-3 switches to “P100.”
INTRO	This has the same function as [INTRO/START].
FILL A	This has the same function as [FILL A].
VERSE A	This has the same function as [VERSE A].
FILL B	This has the same function as [FILL B].
VERSE B	This has the same function as [VERSE B].
FILL C	This has the same function as [FILL C].
VERSE C	This has the same function as [VERSE C].
ENDING	This has the same function as [ENDING/STOP].
DRUM KICK- DRUM CYM5	This plays the sounds assigned to DRUM KICK – DRUM CYM5 in the kit (p. 58) currently being played.
PERC 1- PERC 13	This plays the sounds assigned to PERC 1 – PERC 13 in the kit (p. 58) currently being played.

Chapter 5 Changing the Overall Tone of the Sound and Acoustics (TSC)

“TSC,” short for “Total Sound Control,” is a function that lets you change the overall tone of the sound and acoustics.

TSC includes two types of effect, “Sound Shape,” which changes the overall tone of the sound, and “Ambience,” which alters the acoustic characteristics of the overall sound.

“Sound Shape” and “Ambience” each feature eight pre-programmed groups of settings (Preset), but you can also add up to eight more of your own settings (User settings) to these.

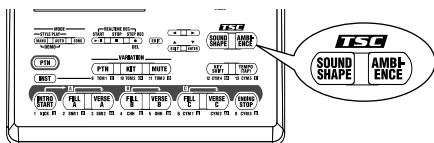

MEMO

With the Preset Styles, settings for the two types of TSC effects are predetermined for each Style individually, allowing you to attain the acoustic effect most suitable for each Style.

Changing the Overall Tone of the Sound ([SOUND SHAPE])

“Sound Shape” allows you to adjust the overall tone of the sound with a three-band equalizer and three-band compressor that are used to boost or cut specific pitches (frequency bands).

1. Press [SOUND SHAPE].

The TSC screen appears.



Each time you press [SOUND SHAPE], it alternately turns the button on (lit) and off (unlit).

2. Turn the VALUE dial to select the effect.

Value	Name	Value	Name
P1	ROCK	P2	LOUD
P3	TIGHT	P4	ENHANC
P5	ACSTIC	P6	LIVE
P7	LO-FI	P8	HRDCMP
U1-8	When the unit left the factory, the User settings (U1-U8) contained the same settings as the Preset (P1-P8).		

3. Press [EXIT] to return you to the previous screen.

MEMO

You can change the parameters of the Sound Shape settings and name the settings. You can store up to eight settings. For more details, refer to “Changing the Sound Shape Parameters” (p. 53).

Altering the Acoustic Characteristics of the Overall Sound ([AMBIENCE])

“Ambience” adjusts the breadth of the sound by altering the acoustic characteristics of the sound.

1. Press [AMBIENCE].

The TSC screen appears.



Each time you press [AMBIENCE], it alternately turns the button on (lit) and off (unlit).

2. Turn the VALUE dial to select the effect.

Value	Name	Value	Name
P1	NATURL	P2	LARGE
P3	BRIGHT	P4	POWER
P5	ROOM 1	P6	ROOM 2
P7	ROOM 3	P8	HALL
U1-8	When the unit left the factory, the User settings (U1-U8) contained the same settings as the Preset (P1-P8).		

3. Press [EXIT] to return you to the previous screen.

MEMO

You can change the parameters of the Ambience settings and name the settings. You can store up to eight settings. For more details, refer to “Changing the Ambience Parameters” (p. 56).

Changing the Sound Shape Parameters

You can store up to eight edited Sound Shape parameters.

- * Unable to change the settings for the Preset Sound Shape, with a “P” appended to their number.
- * When the unit left the factory, the User settings (U1–U8) contained the same settings as the Preset (P1–P8).
- * If the parameters below are changed during the performance of a style or song, the changes are nullified when you press [EDIT], restoring the settings for the currently selected style or song.
 - Key Shift value (p. 42)
 - Tempo value (p. 41)
 - Sound Shape and Ambience values (p. 51, p. 52)
- * Certain data cannot be changed while it is being performed. First stop the performance, then make the changes.

■ How to Make the Settings

1. With the performance stopped, press [EDIT]. The Edit Menu screen appears.

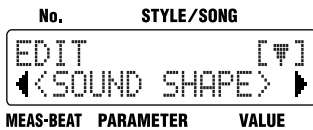

2. Press [▶], select a <SOUND SHAPE>, then press [ENTER].

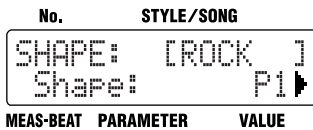

3. Turn the VALUE dial to select the Sound Shape number to be set.
4. Press [◀] [▶], select the parameter to be set.
5. Turn the VALUE dial to set the value.
6. When you have finished making the setting, press [EXIT] a number of times until you exit Edit mode.

■ Changing the Equalizer Parameters

This changes the parameters of the Sound Shape 3-Band equalizer.

The values that can be set for each of the parameters are shown below.

Parameter	Value	Description
EQ / Switch	OFF, ON	This parameter turns the equalizer effect on/off.
EQ / Input	-24 dB–+12 dB	Sets the overall volume before passing through the equalizer.
EQ (Low) / Type	Shelving, Peaking	Sets the equalizer type (shelving, peaking) for the lower range.
EQ (Low) / Gain	-12 dB–+12 dB	Sets the amount of boost or cut in the lower range.
EQ (Low) / Freq	20 Hz–2.0 kHz	Sets the center frequency for the lower range.
EQ (Low) / Q (*1)	0.3–16.0	Sets the steepness of the frequency response curve for the lower range's center frequency.
EQ (Mid) / Gain	-12 dB–+12 dB	Sets the amount of boost or cut in the middle range.
EQ (Mid) / Freq	20 Hz–8.0 kHz	Sets the center frequency for the middle range.
EQ (Mid) / Q	0.3–16.0	Sets the steepness of the frequency response curve for the middle range's center frequency.
EQ (High) / Type	Shelving, Peaking	Sets the equalizer type (shelving, peaking) for the upper range.
EQ (High) / Gain	-12 dB–+12 dB	Sets the amount of boost or cut in the upper range.
EQ (High) / Freq	500 Hz–14.0 kHz	Sets the center frequency for the upper range.
EQ (High) / Q (*1)	0.3–16.0	Sets the steepness of the frequency response curve for the upper range's center frequency.
EQ / Out Level	-24 dB–+12 dB	Sets the overall volume level after equalization.

(*1) The “EQ (Low) / Q” and “EQ (High) / Q” is disabled when “Shelving” (shelving type equalization) is selected for the “EQ (Low) / Type” or “EQ (High) / Type.”

■ Changing the Compressor Parameters

This changes the parameters of the Sound Shape compressor.

The Compressor compresses the overall output signal when the input volume level exceeds a set value.

The values that can be set for each of the parameters are shown below.

Parameter	Value	Description
COMP / Switch	OFF, ON	This parameter turns the compressor effect on/off.
COMP / SplitL	20 Hz–800 Hz	This sets the frequency (in the lower range) at which the source sound is split into three separate ranges.
COMP / SplitH	1.6 kHz–14.0 kHz	This sets the frequency (in the upper range) at which the source sound is split into three separate ranges.
COMP (Low) / Thres	-30 dB–+6 dB	This sets the volume level at which the lower-range compressor goes into effect.
COMP (Low) / Ratio	1:1.00–1:16.0, 1:INF	This sets the ratio of suppression of the lower-range output when the input level exceeds the Lo threshold level (COMP (Low) / Thres).
COMP (Low) / Attack	0 ms–100 ms	This sets the time it takes for the lower-range compressor to go into effect once the input level exceeds the Lo threshold level.
COMP (Low) / Release	50 ms–5000 ms	This sets the time it takes for the lower-range compressor effect to stop once the input level falls below the Lo threshold level.
COMP(Mid) / Thres	-30 dB–+6 dB	This sets the volume level at which the midrange compressor goes into effect.
COMP(Mid) / Ratio	1:1.00–1:16.0, 1:INF	This sets the ratio of suppression of the midrange output when the input level exceeds the Middle threshold level (COMP(Mid) / Thres).

Parameter	Value	Description
COMP(Mid) / Attack	0 ms–100 ms	This sets the time it takes for the midrange compressor to go into effect once the input level exceeds the Middle threshold level.
COMP(Mid) / Release	50 ms–5000 ms	This sets the time it takes for the lower-range compressor effect to stop once the input level falls below the Middle threshold level.
COMP(Hi) / Thres	-30 dB–+6 dB	This sets the volume level at which the upper-range compressor goes into effect.
COMP(Hi) / Ratio	1:1.00–1:16.0, 1:INF	This sets the ratio of suppression of the upper-range output when the input level exceeds the Hi threshold level (COMP(Hi) / Thres).
COMP(Hi) / Attack	0 ms–100 ms	This sets the time it takes for the upper-range compressor to go into effect once the input level exceeds the Hi threshold level.
COMP(Hi) / Release	50 ms–5000 ms	This sets the time it takes for the upper-range compressor effect to stop once the input level falls below the Hi threshold level.
* With the compressor, the level is automatically adjusted to the optimum setting according to the threshold (Thres) and ratio (Ratio) settings. In addition, since lengthening the attack (Attack) setting may result in distortion, a buffer (margin) of -6 dB is provided. Adjust the following parameter levels as needed.		
COMP / Low Lev	-60 dB–+6 dB	Sets the volume level of the lower range after the signal passes through the expander and compressor.
COMP / Mid Lev	-60 dB–+6 dB	Sets the volume level of the midrange after the signal passes through the expander and compressor.
COMP / High Lev	-60 dB–+6 dB	Sets the volume level of the upper range after the signal passes through the expander and compressor.
COMP / OutLevel	-60 dB–+6 dB	Sets the overall volume level after compressor.

■ Naming the Settings

Select a <NAME> on step 4 in p. 53, then press [ENTER].

You can edit the name of the currently selected Sound Shape setting, using up to six characters for the name.

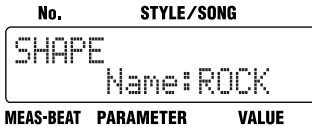

Press [◀] [▶] to move to the point where you want to enter the character(s).

Each time you press [ENTER], it switches between upper and lower case for the text being input.

Turn the VALUE dial to select the character.

When you have finished making the setting, press [EXIT] a number of times until you exit Edit mode.

■ Copying the Settings

Select a <COPY> on step 4 in p. 53, then press [ENTER].

Copy the currently selected Sound Shape setting to the User settings (U1–U8).

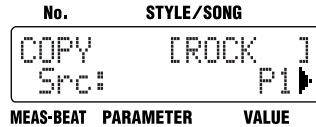

Turn the VALUE dial to select the number for the Sound Shape to be copied, then press [▶].

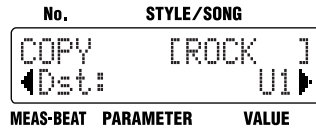

Turn the VALUE dial to select the copy-destination Sound Shape number, then press [▶].



Press [ENTER] to execute the copy.

If you press [◀], the copy is cancelled, and you're taken back to the screen you were in immediately before that.

When you have finished making the setting, press [EXIT] a number of times until you exit Edit mode.

Changing the Ambience Parameters

You can store up to eight edited Ambience parameters.

- * Unable to change the settings for the Preset Ambience, with a "P" appended to their number.
- * When the unit left the factory, the User settings (U1–U8) contained the same settings as the Preset (P1–P8).
- * If the parameters below are changed during the performance of a style or song, the changes are nullified when you press [EDIT], restoring the settings for the currently selected style or song.
 - Key Shift value (p. 42)
 - Tempo value (p. 41)
 - Sound Shape and Ambience values (p. 51, p. 52)
- * Certain data cannot be changed while it is being performed. First stop the performance, then make the changes.

How to Make the Settings

1. With the performance stopped, press [EDIT]. The Edit Menu screen appears.

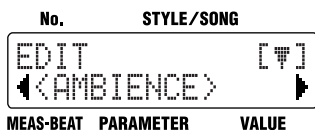

2. Press [▶], select a <AMBIENCE>, then press [ENTER].

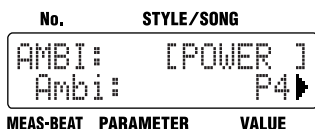

3. Turn the VALUE dial to select the Ambience number to be set.
4. Press [◀][▶], select the parameter to be set.
5. Turn the VALUE dial to set the value.
6. When you have finished making the setting, press [EXIT] a number of times until you exit Edit mode.

Changing the Ambience Parameters

The values that can be set for each of the parameters are shown below.

Parameter	Value	Description
Size	5.6 m–20.5 m	This parameter adjusts the size of the room which is simulated.
Time	0.1–32.0	This parameter adjusts the duration (time) of the reverb.
Level	0–100	This parameter adjusts the effect level.
PreDelay	0 ms–20 ms	This parameter adjusts the time interval between the direct sound and the beginning of the reverb sound.
Density	0–100	Adjust the density of the whole reverb sound.
ErLevel	0–100	This parameter adjusts the volume level of the sound (Early Reflections) that arrives at the listener after bouncing off the walls once or a few times.
RelDensity	0–100	This parameter adjusts the density of the sound that reaches the listener after many repeated reflections.
Low Damp / Gain	-36.0 dB–0.0 dB	This parameter adjusts the amount of damping for Low Damp. No low-frequency damping occurs when set to "0."
Low Damp / Freq	55 Hz–4.00 kHz	This parameter adjusts the standard frequency at which the low-frequencies are damped. The reverb sound in the band below this frequency is damped.
Hi Damp / Gain	-36.0 dB–0.0 dB	This parameter adjusts the amount of damping for High Damp. No high-frequency damping occurs when set to "0."

Parameter	Value	Description
Hi Damp / Freq	400 Hz–16 kHz	This parameter adjusts the standard frequency at which the high-frequencies are damped. The reverb sound in the band above the standard frequency is damped.
Low Cut / Freq	20 Hz–2.0 kHz	This parameter adjusts the frequency at which the low-frequencies are cut.
High Cut / Freq	250 Hz–14.0 kHz, FLAT	This parameter adjusts the frequency at which the low-frequencies are cut. No effect occurs when set to “FLAT.”

■ Naming the Settings

Select a <NAME> on step 4 in p. 56, then press [ENTER].

You can edit the name of the currently selected Ambience setting, using up to six characters for the name.

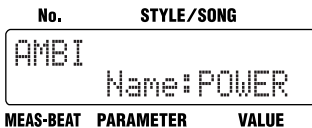

Press [◀][▶] to move to the point where you want to enter the character(s).

Each time you press [ENTER], it switches between upper and lower case for the text being input.

Turn the VALUE dial to select the character.

When you have finished making the setting, press [EXIT] a number of times until you exit Edit mode.

■ Copying the Settings

Select a <COPY> on step 4 in p. 56, then press [ENTER].

Copy the currently selected Ambience setting to the User settings (U1–U8).

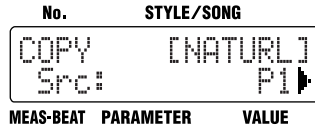

Turn the VALUE dial to select the number for the Ambience to be copied, then press [▶].

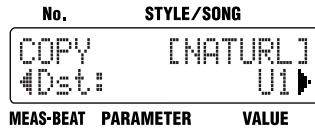

Turn the VALUE dial to select the copy-destination Ambience number, then press [▶].



Press [ENTER] to execute the copy.

If you press [◀], the copy is cancelled, and you're taken back to the screen you were in immediately before that.

When you have finished making the setting, press [EXIT] a number of times until you exit Edit mode.

Chapter 6 Performing with the Pads

When you press [INST], the button lights up, and you can then play drum set and bass sounds by pressing the pads. You can also turn [INST] on while Styles and songs are in progress to play sounds with the pads.

You can perform using the following pads when [INST] is lit.

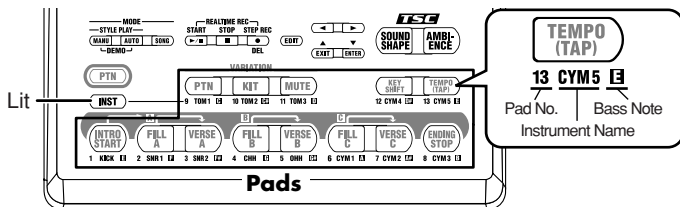

You can perform with the pads using three groups of sounds (DRUM, PERC, BASS).

Select the desired group by pressing [INST], and cycling through the available choices:

“DRUM” → “PERC” → “BASS” → “oct BASS” → “oct BASS” → “DRUM” and so on.

The name of the sound group appears in the display.

Dis- played	Group Name	Sound
DRUM	Drum Set	The sounds in the drum set are assigned to the pads. The sound names are printed under the pads.
PERC	Percussion	Various percussion instrument sounds are assigned to the pads.
BASS	Bass	The various pitches of the scale for the specified bass sound are assigned to the pads. The note names are printed under the pads.
oct BASS		The bass sound one octave lower is assigned to the pads.
oct BASS		The bass sound one octave higher is assigned to the pads.

When you tap a pad, the sound of the instrument assigned to that pad or the specified pitch is played.

The volume and tone change according to how hard you tap the pads.

MEMO

The tones that are assigned to the pads in the Preset Styles are predetermined for each Style.

MEMO

Press [] when using the pads to switch Patterns. For more details, refer to “Switching the Pad Functions” (p. 37).

MEMO

You can adjust the pad sensitivity. For more details, refer to “Adjusting the Pad Sensitivity” (p. 89).

Playing Drum Sounds

1. Press [INST] a number of times until “DRUM” appears in the display.

No.	STYLE/SONG
P001	ROCK JAN 1
1-1 Pad:	DRUM
MEAS-BEAT	PARAMETER VALUE

2. Tap the pads to perform.

The instrument sounds assigned to the pads are played.

The names of the assigned instruments are printed under the pads.

Playing Percussion Sounds



1. Press [INST] a number of times until “PERC” appears in the display.

No.	STYLE/SONG
P001	ROCK JAN 1
1-1 Pad:	PERC
MEAS-BEAT	PARAMETER VALUE

2. Tap the pads to perform.

The instrument sounds assigned to the pads are played.

Playing Bass Sounds

1. Press [INST] a number of times until “BASS,” “oct  BASS” or “oct  BASS” appears in the display.

No.	STYLE/SONG
P001	ROCK JAN 1
1-1 Pad:	BASS
MEAS-BEAT	PARAMETER VALUE

2. Tap the pads to perform.

The bass sound is played at the pitch assigned to a particular pad.

The bass sound stops playing when you release the pad.

The names of the notes assigned to the pads are printed under the pads.

MEMO

For details on the sounds assigned to the pads, refer to the “Preset Kit List” (p. 106).

NOTE

You cannot play more than one bass sound at the same time.

Selecting a Different Sound (VARIATION [KIT])

When [INST] is on, the set of three groups of sounds played with the pads (DRUM, PERC, BASS) is called the “drum kit.”

A single Style has two drum kits included with it, and you can switch between these two drum kits by turning VARIATION [KIT] on and off.

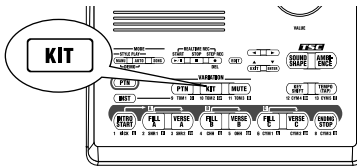

1. Press [] so the button lights up.
2. Press VARIATION [KIT] so the button lights up.
3. Press [INST] so the button lights up.

When you press the pads, the variation drum kit plays.

To return to the original drum kit, press [] and then VARIATION [KIT], causing the button lights to go out.

MEMO

You can change the instrument sounds contained in a drum kit, and create original drum kits. You can also change the volume and pan (sound localization) settings.

For further details, refer to “Chapter 10 Creating Your Own Kits” (p. 90).

MEMO

Turning VARIATION [KIT] on switches not only the pad drum kit, but also the drum kit for the Style or song currently being played.

Chapter 7 Creating Styles

Even though the DR-3 comes with a great variety of styles, representing many genres, you can also create your own original styles. Such original styles are called “User styles.”

User styles have a “U” at the beginning of the style number, for example “U001.” You can create and store up to 100 User styles in the DR-3.

Procedure for Creating Styles

Here are the steps you need to take to create a new style:

<1> Select a Number for the Style You Are Creating

<2> Make the Settings for the New Style

- Set the Tempo
- Set the Beat
- Set Up the Drum Kit
- Set VARIATION [MUTE]
- Make the TSC Settings
- Determine the Number of Measures for Each Pattern (These settings can be changed after the patterns are recorded.)

<3> Record the Patterns (Realtime Recording/Step Recording)

- Record the Drum Part
- Record the Bass Part
- Change Dynamics to the Sounds (Velocity Edit)
- Transpose the Bass Part

<4> Check the Created Style

- Edit the Settings

<Finish the Style>

- Name the Style

There are two ways to record the patterns in Step <3>.

Realtime Recording

With this method, the key pads are played in time with a metronome count, with the pattern being recorded just as it is performed. Even if there is a little unevenness in the timing used in tapping the key pads, the Quantize function allows you to record with the timing corrected. (Refer to step 3 on p. 65)

Step Recording

With this method, you “record” by specifying the timing (step), volume, etc., of each instrument sound, one at a time. This allows patterns to be recorded accurately, even those that are hard to record using Realtime Recording.

You can also record patterns using both Realtime and Step Recording.

After recording the basic pattern using Step Recording, finish creating the Pattern by using Realtime Recording to add sounds in a freer ad-lib style.

Convenient Functions for Creating Styles

You can speed up the process of creating a new style by first copying a Preset style, or the patterns in a Preset style to a User style, and then modifying that to create the new style.

- Copying and Deleting Styles (p. 71)
- Copying and Deleting Patterns (p. 72)



Creating Two-Measure Patterns from Four-Measure Patterns

When you copy a four-measure pattern, and then, using the procedure described in “Determining the Number of Measures for Each Pattern” (p. 64), set the number of measures to “2,” it results in a pattern in which only the first two measures of the original pattern are played. In this manner, you can use the setting described on p. 64 to create a pattern after copying a pattern that is shorter than the one you start with.



Changing the Key of the Bass Part (Key Transpose)

After copying or recording a pattern, you can change the key of its bass part.

<1> Selecting a Number for the Style

1. With the performance stopped, press [MANU].

The Style screen appears.

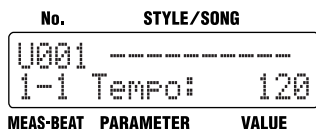

2. Turn the VALUE dial to select the number (U001–U100) for the style you are creating.

You cannot record to the Preset styles (P001–P100).

<2> Making the Settings for the New Style

* If the parameters below are changed during the performance of a style, the changes are nullified when you press [EDIT], restoring the settings for the currently selected style or song.

- Key Shift value (p. 42)

- Tempo value (p. 41)

- Sound Shape and Ambience values (p. 51, p. 52)

* Certain data cannot be changed while it is being performed. First stop the performance, then make the changes.

* VARIATION [PTN] [KIT] and [MUTE] will have no effect in Edit mode.

■ Setting the Tempo for the Style

1. Select the style to be set, then press [EDIT].

The Edit Menu screen appears.

2. Select a <STYLE>, then press [ENTER].

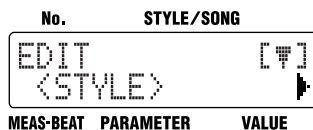

3. Select a <Tempo>.

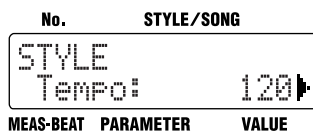

4. Turn the VALUE dial to set the tempo.

The tempo can be set to any value from 20 to 260.

5. When you press [EXIT], the setting is changed, and you're returned to the previous screen.

■ Setting the Beat

* When you copy a style, the new style uses the beat of the original style.

1. Select the style to be set, then press [EDIT].

The Edit Menu screen appears.

2. Select a <STYLE>, then press [ENTER].

3. Press [▶], select a <Beat>.

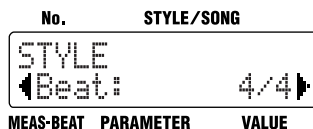

4. Turn the VALUE dial to set the beat.

2/4, 3/4,... 8/4,

4/8, 5/8,... 16/8

5. When you press [EXIT], the setting is changed, and you're returned to the previous screen.

■ Setting Up the Kit

Changing the kit changes the sounds used in the style being created.

When setting kit's variation (p. 36), select <Kit2> in Step 3 below.

* You can also create kits using the instruments you prefer (User kits). For more details, refer to "Chapter 10 Creating Your Own Kits" (p. 90).

1. Select the style to be set, then press [EDIT].

The Edit Menu screen appears.

2. Select a <STYLE>, then press [ENTER].

3. Press [▶], select a <Kit1> or a <Kit2>.

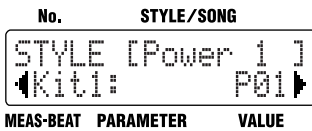

4. Turn the VALUE dial to select the kit.

Each contains settings P01–P50 and U01–U50.

For more on the instrument that make up each kit, refer to the "Preset Kit List" (p. 106).

5. When you press [EXIT], the setting is changed, and you're returned to the previous screen.

■ Changing the Sound to Be Muted

When VARIATION [MUTE] is on, this sets the sound to be played.

If you press VARIATION [MUTE] while the currently selected style is playing, the sound selected in this setting is played, and all other sounds are muted.

1. Select the style to be set, then press [EDIT].

The Edit Menu screen appears.

2. Select a <STYLE>, then press [ENTER].

3. Press [▶], select a <Mute>.

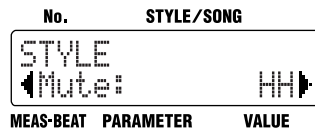

4. Turn the VALUE dial to select the sound to be performed with VARIATION [MUTE] is set to ON.

Item	Value
Mute	HH (High Hat and Cymbal), Kick, Bass, HH&Kc (High Hat & Kick), Kc&Bs (Kick & Bass), HH&Bs (High Hat & Bass), Drums

5. When you press [EXIT], the setting is changed, and you're returned to the previous screen.

■ Making the TSC Settings for the Style

Make the TSC (Sound Shape and Ambience) settings for the style you are creating.

1. Select the style to be set, then press [EDIT].
The Edit Menu screen appears.
2. Select a <STYLE>, then press [ENTER].
3. Press [▶], select the item to be set.

Item	Value	Description
Shape Sw	ON, OFF	This sets the Sound Shape On/Off setting to be used when this Style is selected.
Shape	P1-P8, U1-U8	This sets the Sound Shape when this Style is selected.
Ambi Sw	ON, OFF	This sets the Ambience On/Off setting to be used when this Style is selected.
Ambi	P1-P8, U1-U8	This sets the Ambience when this Style is selected.

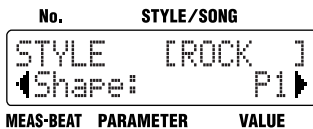
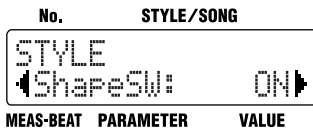

4. Turn the VALUE dial to set the value.
5. When you press [EXIT], the setting is changed, and you're returned to the previous screen.

■ Determining the Number of Measures for Each Pattern

* Fill-Ins A-C are set at one measure each. This setting cannot be changed.

1. Press [EDIT].
The Edit Menu screen appears.
2. Select a <STYLE>, then press [ENTER].
3. Press [▶], select a <PATTERN>, then press [ENTER].



4. Press [◀][▶] to select the pattern to change the setting.
Select the pattern with "PATTERN MEAS" displayed the upper part of the screen.

* For more on "PTN KEY TRANS" in the upper row and the screens that are displayed, refer to "Transposing the Pattern's Bass Part" (p. 70).

5. Turn the VALUE dial to select the number of measures.
You can set patterns to a maximum length of four measures.

6. When you press [EXIT] twice, the setting is changed, and you're returned to the previous screen.

* When changing the number of measures in a copied pattern, even though you set the copied pattern so it has fewer measures than the original pattern, the amount of data remains the same as that of the original.

<3> Recording the Patterns

■ Using Realtime Recording

The following explains the Realtime Recording procedure, in which you record by pressing the pads in time with the tempo provided by the metronome.

- * When you record to a pattern which has already been recorded, the sounds are layered without the previously recorded sounds being erased.
- * You cannot record to the Preset Styles (P001–P100).
- * The tempo, Sound Shape, and Ambience settings that are set at the time of recording are saved to the recorded pattern.

• Recording the Drum Part

- * With the drum part, you cannot record multiple notes from the same pad number at the same step (timing).

Make sure you have pressed [MANU] to switch to Manual mode.

1. Hold down [PTN] and press any of the pattern pads to specify the pattern to be recorded.

The pattern pad flashes when pressed.

2. Hold down STEP REC [●] and press START [▶/■].

STEP REC [●] lights up, and START [▶/■] flashes. Recording begins after one measure metronome count. The “MEAS-BEAT” indication counts in time with the metronome count.





[INST] lights up, and the pads are enabled for performing instrument sounds.

Style No.	Pattern Name
U001	VERSE A
1-1 Pad:	DRUM

Measure Beat Sound Group Quantize

3. Turn the VALUE dial to set the quantization.

This corrects mistakes in the rhythm played to the closest selected note value.

Display	Description		
--	Off Sounds are recorded without quantization, with the same timing used in tapping the pads.		
	32th note		16th note triplets
	16th note		8th note triplets
	8th note		

- * For more detailed information about the Quantize function, refer to the column on p. 66.

4. Press [INST] to select either “DRUM” or “PERC” as the instrument to be recorded.

5. Record the performance, pressing the pads while following the rhythm provided by the metronome.

The force used to tap the pads is recorded as velocity (the strength or stress of the sound). Recorded sounds are played back repeatedly. Sounds continue to be layered as the sounds that have already been recorded are played back.

6. Repeat Steps 3–5 as needed.

7. To stop recording, press STOP [■].

Erasing Previously Recorded Sounds As You Continue Recording

You can use the following procedure to erase specified instrument sounds in the pattern currently being recorded.



1. Hold down STEP REC [●] and press the pad to which the instrument whose sound you want to erase is assigned.

For example, when recording with “DRUM” selected for [INST], holding down STEP REC [●] and pressing [VERSE A (SNR 2)] erases the SNR 2 sounds that have already been recorded.

• Recording the Bass Part

* Bass parts are monophonic. Even if multiple notes are layered in a recording, only one sound is played.

Steps 1–3 are identical to those in “Recording the Drum Part” above.

- 4. Press [INST] to select “BASS,” “ BASS” or “ BASS.”**

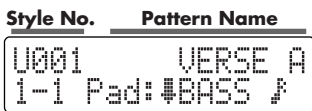

Measure	Beat	Octave	Sound	Quantize
			for bass	Group

- 5. Record the performance, pressing the pads while following the rhythm provided by the metronome.**

The force used to tap the pads is recorded as velocity (the strength or stress of the sound). Recorded sounds are played back repeatedly.

- 6. Repeat Steps 4–5 as needed.**
- 7. To stop recording, press STOP [].**

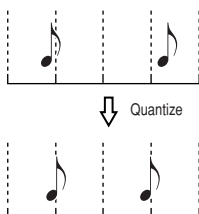

What is Quantize?

You can correct for timing discrepancies in a recorded performance by automatically aligning the music with the timing you specify. This is called “Quantizing.”



Erasing Previously Recorded Sounds As You Continue Recording

You can use the following procedure to erase the bass sounds in the pattern currently being recorded.

- 1. Hold down STEP REC [] and press any one pad.**
- All bass sounds, regardless of pitch, are erased while STEP REC [] and the pad are held down.

* When erasing long note sounds, press the key pad at the point the sound begins to play. Regardless of the length of the note, the entire sound recorded at that time is erased.

■ Using Step Recording

What is Step Recording?

This is a recording method whereby measures are divided into units called “steps,” and the timing of each sound to be played is specified.

The step length is set in “Quantize.” For example, if the value in Quantize is set to the eighth note, then when the time signature (beat) is set to 4/4, eight notes can be input in one measure.

When you press the pads while recording drum parts, one step length of the sound assigned to that pad will be input.

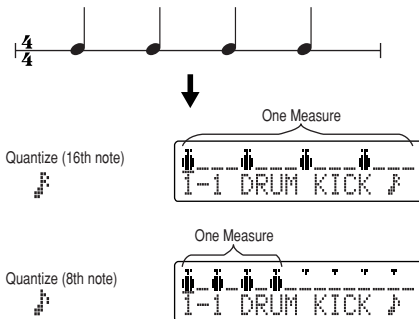

When recording bass parts, pressing a pad inputs one step length of the pitch corresponding to that pad. To record a long note, input the note by holding down the pad and pressing [▶].

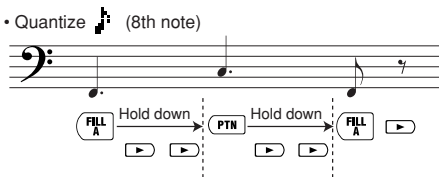

• Recording the Drum Part

Make sure you have pressed [MANU] to switch to Manual mode.

1. Hold down [PTM] and press any of the pattern pads to specify the pattern to be recorded.

The pattern pad flashes when pressed.

2. Press STEP REC [●].

The STEP REC [●] button lights up, and the “Step Recording screen” is displayed.



3. Press [ENTER] to move the cursor to the quantization value, then turn the VALUE dial to set the quantization.

In Step Recording, the quantization value represents the unit for the length of one note (the step).

Display	Description	
	32th note	16th note triplets
	16th note	8th note triplets
	8th note	

4. Press [EXIT].

The cursor moves to the step display.

5. Press [INST] to select either “DRUM” or “PERC” as the sound group to be recorded.

6. Press [◀][▶] to specify the step to be recorded.

7. Tap the pad for the instrument to be recorded.

At this time, the force used to tap the key pads is recorded as velocity.

The recording automatically advances by one step.

When you press the pad for an instrument other than the instrument shown in the screen, the indication in the display changes. The screen always shows the step for the instrument currently being input.

Erasing Sounds That've Been Input

1. Press [◀] [▶] to move to the step to be deleted.
2. Hold down STEP REC [●] and press the pad to which the instrument you want to erase is assigned.

Changing the Instrument Displayed Without Inputting

Hold down [INST] and press the pad for the instrument you want to display.

8. Repeat Steps 3–7 as needed.

Confirming the Input Sound

Press [◀] [▶] in the Step Recording screen to move to other steps.

You can move continuously through steps by holding down [◀] [▶]. If there is a note present when you press [▶], the note is played.

When you press [▶] to move through the steps, START [▶/■] lights up at the start of the beat (■).

9. To stop recording, press STOP [■].

The STEP REC [●] goes out.

- * *Note that pressing START [▶/■] during Step Recording (while STEP REC [●] is lit) switches the DR-3 to Realtime Recording (p. 65).*

• Recording the Bass Part

- * *Bass parts are monophonic. Even if multiple notes are layered in a recording, only one sound is played.*

Steps 1–4 are identical to those in “Recording the Drum Part” above.

5. Press [INST] to select “BASS,” “BASS oct ♭” or “BASS oct ♮.”

Select “BASS oct ♭” when you want to input the bass sound one octave lower.

Select “BASS oct ♮” when you want to input the bass sound one octave higher.

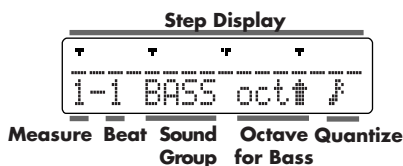

6. Press [◀] [▶] to specify the step to be recorded.

7. Tap the pad for the instrument to be recorded.

At this time, the force used to tap the key pads is recorded as velocity.

The recording automatically advances by one step.

Inputting Long Notes

Hold down the pad being recorded and press [▶]; press this the same number of times as the number of steps that you want the sound to be extended.

The length of the note is then set when you release the pad.

Erasing Sounds That've Been Input

1. Press [◀] [▶] to move to the step to be deleted.
2. Hold down STEP REC [●] and press one of the pad.

8. Repeat Steps 5–7 as needed.**Confirming the Input Sound**

Press [◀] [▶] in the Step Recording screen to move to other steps.

You can move continuously through steps by holding down [◀] [▶].

If there is a note present when you press [▶], the note is played.

With extended notes, only the sound in the first step is played.

- * Using a rougher Quantize value (such as eighth notes) makes it easier to check detailed phrases.

When you press [▶] to move through the steps, START [▶/■] lights up at the start of the beat ("■").

9. To stop recording, press STOP [■].

The STEP REC [●] goes out.

- * Note that pressing START [▶/■] during Step Recording (while STEP REC [●] is lit) switches the DR-3 to Realtime Recording (p. 65).

■ Adding Dynamics to the Sounds (Velocity Edit)

You can change the dynamics (velocity) of specific notes in patterns that have already been recorded. Adding accents to the notes lets you give the rhythm greater liveliness.

Make sure you have pressed [MANU] to switch to Manual mode.

- 1. Hold down [] and press any of the pattern pads to specify the pattern to be recorded.**
The pattern pad flashes when pressed.
- 2. Press STEP REC [●] to display the Step Recording screen.**
- 3. Press [EDIT].**

The Velocity Edit screen is displayed.

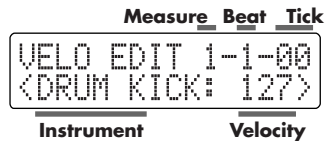

The position of the note is indicated as “measure-beat-tick.”

Tick is a term used to refer to units of time shorter than a beat.

- 4. Press [◀] [▶] to find the note whose velocity is to be changed.**

When you press [◀] [▶], all notes are displayed one by one, regardless of whether they are in the drum part or bass part.

Hold down the button to seek the note (moving through the notes continuously).

When you press [▶], the sound for the displayed note is played.

When you press [ENTER], the sound for the displayed note is played. This does not move you to another note.

- 5. Turn the VALUE dial to change the value.**
You can set the velocity to any value from 1 to 127.
- 6. Repeat Steps 4 and 5 as needed.**
- 7. Press [EXIT] to quit Velocity Edit.**

The Step Recording screen appears.

When you press STOP [■], you're returned to the Style screen.

■ Transposing the Pattern's Bass Part

Use this procedure to transpose the bass part and store the pattern (Key Transpose).

- * *Key Transpose settings are disregarded when recording patterns.*
- * *If notes whose pitches are changed using the Key Transpose function are in registers that are unplayable for the DR-3, the notes in the expressible range above or below that octave are sounded.*

1. Press [EDIT].

The Edit Menu screen appears.

2. Select a <STYLE>, then press [ENTER].

3. Press [▶], select a <PATTERN>, then press [ENTER].

4. Press [▶], select a <PTN KEY TRANS>.

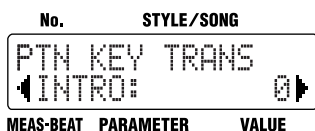

5. Press [◀] [▶] to select the pattern to be set the key.

Select the pattern with "PTN KEY TRANS" displayed the upper part of the screen.

The pattern names appear as "VERSE Av," "VERSE Bv," and "VERSE Cv" when VARIATION [PTN] is on.

6. Turn the VALUE dial to select the key.

You can set the value in semitone units within the range from -12 to +12.

7. When you press [EXIT] twice, the setting is changed, and you're returned to the previous screen.

■ Playing Back Recorded Patterns

After recording each of the patterns, play them back to check out how they sound.

1. If recording is in progress, press STOP [■] to stop the recording.

2. Press START [▶/■].

The recorded pattern is played.

3. Press STOP [■] to stop the performance.

<4> Confirming the Created Style

Now play back the new style to check the tempo and drum kits.

You can also press the TSC and VARIATION [PTN], [KIT] and [MUTE] to check the settings, and adjust these settings if necessary.

■ Performing the Created Style

1. Press [MANU] or [AUTO].

2. Press any of Pattern Pads or START [▶/■] to start the performance.

3. Press [ENDING/STOP] or STOP [■] to stop the performance.

■ Editing the Settings

You can make changes to the following settings, even after creation of the style is finalized.

- Style Tempo —
"Setting the Tempo for the Style" (p. 62)
- Kit Settings —
"Setting Up the Kit" (p. 63)
- TSC Settings —
"Making the TSC Settings for the Style" (p. 64)
- VARIATION [MUTE] Settings —
"Changing the Sound to Be Muted" (p. 63)

Naming, Copying, and Deleting Styles

■ Naming the Style

You can edit the name of the currently selected style, using up to ten characters for the name.

1. Select the style to be set, then press [EDIT].
The Edit Menu screen appears.
2. Select a <STYLE>, then press [ENTER].
3. Press [▶], select a <NAME>, then press [ENTER].

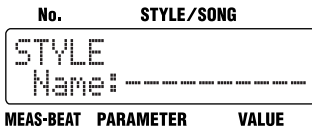

4. Press [◀][▶] to move to the point where you want to enter the character(s).
5. Turn the VALUE dial to select the character.
Each time you press [ENTER], it switches between upper and lower case for the text being input.
6. Repeat Steps 4–5 as needed.
7. When you press [EXIT] twice, the setting is changed, and you're returned to the previous screen.

■ Copying the Style

This copies the Style to the User styles.

1. Press [EDIT].
The Edit Menu screen appears.
2. Select a <STYLE>, then press [ENTER].
3. Press [▶], select a <COPY>, then press [ENTER].



4. Turn the VALUE dial to select the number for the Style to be copied, then press [▶].

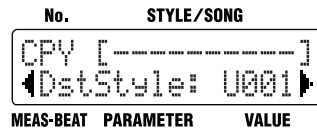

5. Turn the VALUE dial to select the copy-destination Style number, then press [▶].



If you press [◀], you're taken back to the screen you were in immediately before that.

6. Press [ENTER] to execute the copy.
You can press [EXIT] to cancel the procedure, and go back to the previous screen.

■ Clearing the Style

1. Press [EDIT].
The Edit Menu screen appears.
2. Select a <STYLE>, then press [ENTER].
3. Press [▶], select a <CLEAR>, then press [ENTER].

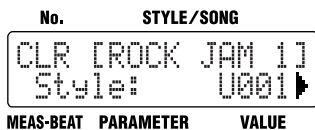

4. Turn the VALUE dial to select the number for the Style to be cleared, then press [▶].

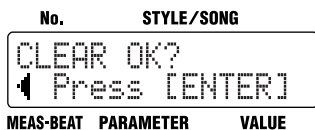

If you press [◀], you're taken back to the screen you were in immediately before that.

5. Press [ENTER] to execute the clearing.
You can press [EXIT] to cancel the procedure, and go back to the previous screen.

Copying and Deleting Patterns

■ Copying Patterns

This copies patterns and User Styles to specified patterns.

1. Press [EDIT].
The Edit Menu screen appears.
2. Select a <STYLE>, then press [ENTER].
3. Press [▶], select a <PATTERN>, then press [ENTER].
4. Press [▶], select a <COPY>, then press [ENTER].

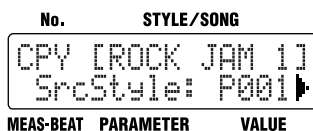

5. Turn the VALUE dial to select the number for the Style to be copied, then press [▶].

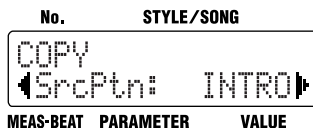

6. Turn the VALUE dial to select the pattern to be copied, then press [▶].

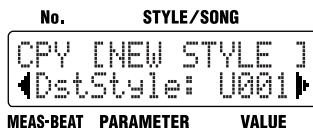

7. Turn the VALUE dial to select the copy-destination Style number, then press [▶].

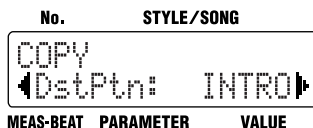

8. Turn the VALUE dial to select the copy-destination pattern, then press [►].



If you press [◀], you're taken back to the screen you were in immediately before that.

9. Press [ENTER] to execute the copy.
You can press [EXIT] to cancel the procedure, and go back to the previous screen.

■ Clearing Patterns

This clears the specified pattern.

1. Press [EDIT].
The Edit Menu screen appears.
2. Select a <STYLE>, then press [ENTER].
3. Press [►], select a <PATTERN>, then press [ENTER].
4. Press [►], select a <CLEAR>, then press [ENTER].



5. Turn the VALUE dial to select the Style, then press [►].

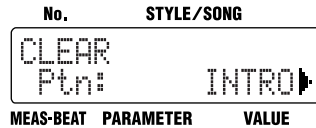

6. Turn the VALUE dial to select the pattern to be cleared, then press [►].



If you press [◀], you're taken back to the screen you were in immediately before that.

7. Press [ENTER] to execute the clearing.
You can press [EXIT] to cancel the procedure, and go back to the previous screen.

Chapter 8 Creating and Performing Songs ([SONG])

With the DR-3, it's easy and convenient to create "songs" by arranging patterns in the sequence they are to be played.

This chapter explains how to create and perform such songs.

■ What is a Song?

A number of patterns arranged in the sequence in which they are played is called a "song."

You can create and save up to 100 songs on the DR-3.

You can record up to a maximum of 250 patterns in one song.

* *The DR-3 contains no song data when shipped from the factory.*

* *For more on performing songs, refer to "Performing Songs" (p. 85).*

Procedure for Creating Songs

Here are the steps you need to take to create a new song:

<1> Select a Number for the Song You Are Creating



<2> Make the Settings for the New Song

- Set the Initial Tempo
- Make the TSC Settings
(These settings can be changed after the patterns are recorded.)



<3> Record the Song

- Place the Patterns
(Step Recording / Realtime Recording)
- Edit Notes to Drum Parts and Bass Parts in the Song



<4> Edit the Song

- Insert
- Delete
- Copy
- Change the Tempo Part Way Through a Song



<5> Check the Created Song

- Edit the Settings



<Finish the Song>

- Name the Song

There are two ways to record the patterns in Step <3>.

Realtime Recording

Performances in Manual mode (p. 43) are recorded as songs just as they are.

You can use Realtime Recording to record the drum part and bass part independently. After arranging the patterns to create a song, you can then add drum and bass sounds, and make other changes to the song (p. 78).

Step Recording

This is a recording method whereby patterns are arranged in a sequence, one by one.

Convenient Functions for Creating Songs

Copying a song is useful and convenient whenever you want to take a previously created song, replace some of its patterns, change the tempo and other settings, and then store the result as a new song.

- Copying and Deleting Songs (p. 84)

Using a Foot Switch to Specify Switching of Song Patterns

By using a foot switch while playing back songs, you can set the DR-3 so that a single pattern plays back repeatedly until you press the foot switch, at which point the song advances to the next pattern.

Using these settings, you don't have to determine how many times the patterns are to be played, but instead you can record each pattern just one time each in the sequence they are to be played, then use the foot switch to switch the patterns during playback.

When using a foot switch to switch song patterns, set the [EDIT] <SONG> "LoopType" to "BLOCK." For more details, refer to "Setting a Specified Segment for Playing Repeatedly" (p. 87).

<1> Selecting a Number for the Song

1. With the performance stopped, press [SONG].
2. Turn the VALUE dial to select the number (S001–S100) for the song you are creating.

Song No.	Song Name
S001
001	P001 LP:OFF

Measure Style No. Loop Play Mode

<2> Make the Settings for the New Song

- * If the parameters below are changed during the performance of a song, the changes are nullified when you press [EDIT], restoring the settings for the currently selected style or song.
- Key Shift value (p. 42)
 - Tempo value (p. 41)
 - Sound Shape and Ambience values (p. 51, p. 52)

■ Setting the Basic Tempo

This sets the tempo that serves as the reference (the initial tempo) when the song is performed.

1. Press [EDIT].

The Edit Menu screen appears.

No.	STYLE/SONG
EDIT	[#]
<SONG>	▶

MEAS-BEAT PARAMETER VALUE

2. Select a <SONG>, then press [ENTER].
3. Select a <InitTempo>.

No.	STYLE/SONG
SONG	
InitTempo:	120▶

MEAS-BEAT PARAMETER VALUE

4. Turn the VALUE dial to set the initial tempo.

The tempo can be set to any value from 20 to 260.

5. When you press [EXIT], the setting is changed, and you're returned to the previous screen.

■ Making the TSC Settings for the Song

Make the TSC (Sound Shape and Ambience) settings for the song you are creating.

1. Select the song to be set, then press [EDIT].
The Edit Menu screen appears.
2. Select a <SONG>, then press [ENTER].
3. Press [◀] [▶], select the item to be set.

Item	Value	Description
Shape Sw	ON, OFF	This sets the Sound Shape On/Off setting to be used when this song is selected.
Shape	P1–P8, U1–U8	This sets the Sound Shape when this song is selected.
Ambi Sw	ON, OFF	This sets the Ambience On/Off setting to be used when this song is selected.
Ambi	P1–P8, U1–U8	This sets the Ambience when this song is selected.

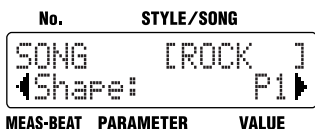
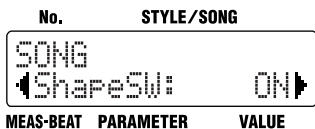

4. Turn the VALUE dial to set the value.
5. When you press [EXIT], the setting is changed, and you're returned to the previous screen.

<3> Recording the Song

■ When Using Step Recording

This lets you record the song by specifying patterns one at a time in the order they are to be played.

* With Step Recording, the data is recorded in pattern units. You cannot record specified measures.

Make sure you have pressed [SONG] to switch to Song mode.

1. With the performance stopped, press STEP REC [●].

The STEP REC [●] button lights up, and the "Step Recording screen" is displayed.



2. Turn the VALUE dial to select the style, use the pattern pads to select the pattern to record, and specify the Variation with the VARIATION [PTN], [KIT] and [MUTE].

The screen appears as follows.

Display	Step	Description
INTRO	Press [INTRO/START]	INTRO is input
VERSE A–C	Press [VERSE A–C]	Verse A–C is input
/FA /FB /FC	These are alternately shown or are hidden in the display each time [FILL A–C] is pressed	Fill A–C is input The last measure of the verse becomes a fill-in.
v	These are alternately shown or are hidden in the display each time VARIATION [PTN], [KIT] or [MUTE] is pressed	Indicates one or more VARIATIONs are on
ENDING	Press [ENDING/STOP]	ENDING is input

* Normally, fill-ins are added at the end of the verse, but you can also input fill-ins in empty steps. Empty steps are indicated by "----" when [EXIT] is pressed in the Song screen.

3. Press [ENTER] to determine the pattern to be recorded.

The measure numbers advance automatically. The asterisk (*) indicates that the pattern displayed has not been confirmed. If you press [EXIT] at this point, the pattern that has already been set appears in the display. If no pattern has been confirmed, “- - -” is displayed. Once you confirm the pattern, the asterisk disappears.

4. Press [◀][▶] to change the step to be recorded.

5. Repeat Steps 2–4 as needed to record the data for the song.

6. To stop recording, press STOP [■].

The STEP REC [●] goes out.

* Note that pressing START [▶/■] during Step Recording (while STEP REC [●] is lit) switches the DR-3 to Realtime Recording.

Erasing Previously Recorded Sounds As You Continue Recording

You can use the following procedure to delete the displayed pattern.

1. Press [◀][▶] to display the pattern to be deleted.

2. Hold down STEP REC [●] and press [ENTER].

The pattern is deleted, and the subsequent patterns are shifted forward.

■ When Using Realtime Recording

The sounds are recorded as the patterns are switched with the pads.

* When recording over a song that has already been recorded, the newly recorded data overwrites the previously recorded data, which is discarded.

Make sure you have pressed [SONG] to switch to Song mode.

1. Hold down STEP REC [●] and press START [▶/■].

No.	STYLE/SONG
S001	Style:P001
Press [PAD] !	
MEAS-BEAT	PARAMETER VALUE

2. Turn the VALUE dial to select the style, and press a pattern pad to specify the first pattern to be recorded.

Recording begins from the pattern specified. The Song Recording screen appears.

Song No.	Style No.
S001	Style:P001
001	INTRO
Measure	Pattern Name

3. Perform by switching the patterns with the pattern pads.

Perform exactly as in Style Manual mode (p. 43). The ON/OFF status of the VARIATION [PTN], [KIT] and [MUTE] (p. 45) is also recorded.

You can also change styles by turning the VALUE dial.

* If you switch the style during its performance, a “⏏” mark appears in front of the style name which will be played next. The style switches after the currently playing pattern ends, and the “⏏” mark disappears.

* The ON/OFF status of the VARIATION buttons and fill-ins can be recorded only in a unit of pattern.

4. When you press [ENDING/STOP], the ending is played, and then both the performance and the recording stop.

If you want to stop the recording immediately, press STOP [■].

Substituting Recorded Patterns

When you record using Realtime Recording into a song that already has material recorded in it, the patterns in the segment in which you record are overwritten, allowing you to replace them with the new patterns.

1. **With the performance stopped, press [◀] [▶] to select a measure slightly ahead of where you want to record.**
2. **Hold down STEP REC [●] and press START [▶/■].**
The prerecorded pattern starts to play.
3. **When you reach the measure before the one you want to substitute, select the next pattern to be recorded.**
4. **To stop recording, press STOP [■].**
The previously recorded pattern data after the point where you stop the recording remains unchanged.

Editing Notes to Drum Parts and Bass Parts in the Song

You can use Realtime Recording to add and edit notes to drum and bass parts in songs you have recorded.

When editing sounds, begin recording from a point slightly before the point where you want to edit the sounds.

- * You cannot record notes into empty songs that contain no recorded data.
- * The performance recorded here is only stored in the song as exclusive patterns. The edited notes are not reflected in performances of patterns in Style Play mode (when [MANU] or [AUTO] is lit). Additionally, changing patterns in Style Play mode has no effect on the songs.
- * You can have up to 100 exclusive patterns for all of the songs.

Make sure you have pressed [SONG] to switch to Song mode.

1. **With the performance stopped, press [◀] [▶] to select a measure slightly ahead of where you want to record.**
2. **Press STEP REC [●].**
The Song Recording screen appears.
3. **Press [INST].**
A message screen is displayed.





No.	STYLE/SONG
INST REC [START]	Pad: DRUM
MEAS-BEAT	PARAMETER VALUE

4. **Press [INST] to select the sound group to be recorded.**

Displayed	Group Name
DRUM	Drum Set
PERC	Percussion
BASS	Bass
♩ BASS	The bass sound one octave lower
♩ BASS	The bass sound one octave higher

5. Turn the VALUE dial to set the quantization.

This corrects mistakes in the rhythm played to the closest selected note value.

Display	Description		Description
--	Off. Sounds are recorded without quantization, with the same timing used in tapping the pads.		32nd note
	16th note triplets		16th note
	8th note triplets		8th note

6. Press START [▶/■].

STEP REC [●] lights up, START [▶/■] flashes, and the metronome begins playing.

No.	STYLE/SONG
5001	Style:P001
004	Pad: DRUM 
MEAS-BEAT	PARAMETER VALUE

7. Record the performance, pressing the pads while following the rhythm provided by the metronome.

The force used to tap the pads is recorded as velocity (the strength or stress of the sound). Only the bass sounds recorded afterwards are stored.



- * When too many notes are recorded within one recording period, a "Memory Full!!" message appears, and the recording stops.
You can edit the notes continuously once the recording is stopped.

8. To stop recording, press STOP [■].

Erasing Previously Recorded Sounds As You Continue Recording

1. Hold down STEP REC [●] and press the pad to which the instrument whose sound you want to erase is assigned.

All bass sounds, regardless of pitch, are erased while STEP REC [●] and the pad are held down.

- * In both Step Recording and Realtime Recording, patterns with edited notes are indicated by a  mark before the pattern name.
- * If you record a different pattern to a pattern that has edited notes, the previous pattern is replaced, and the " mark disappears from the pattern name. You cannot turn on VARIATION [PTN] or add fill-ins with patterns that have edited notes.
Turning on VARIATION [PTN] or adding fill-ins deletes the pattern if it has edited notes.

<4> Editing Songs

You can copy and delete specified segments of recorded songs.

■ Adding Patterns In the Song (INSERT)

This operation inserts a pattern at a point within the song.

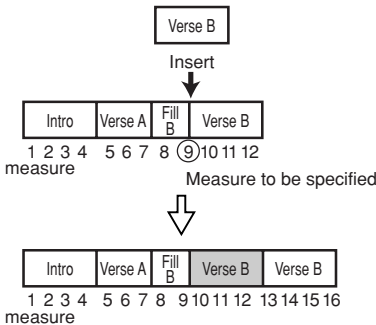

* Patterns are inserted in units of a whole pattern.

You cannot specify only a certain number of measures within a recorded pattern to be inserted.

* You cannot turn the VARIATION on and off or add fill-ins. If you want to turn the VARIATION on or off, or add a fill-in, first insert the pattern, then edit using Step Recording.

1. Press [SONG] so that the button lights up, then press STEP REC [●].

The Song Recording screen appears.

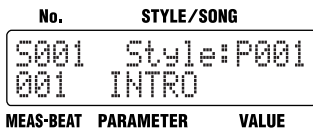

2. Press [◀] [▶] until the measure in which you want to insert a pattern is displayed.

3. Press [EDIT].



4. Select a <INSERT>, then press [ENTER].



5. Turn the VALUE dial to select the Style of the pattern to be inserted, then press [▶].



6. Turn the VALUE dial to select the pattern to be inserted, then press [▶].

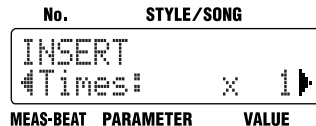

7. Turn the VALUE dial to set the number of times the inserted pattern is to be repeated, then press [▶].

* The maximum number of steps permitted for a song is 250. For this reason, the "Times" setting cannot be given a value that would cause the song to have more than the maximum number of steps.

A confirmation screen is displayed.



If you press [◀], the immediately preceding screen returns to the display.

8. Press [ENTER] and the pattern will be inserted.

If you press [EXIT], the operation is cancelled, and you're returned to the previous screen.

9. Press [EXIT] a number of times to return to the Song Recording screen.

If you press Stop [■], the Song screen is appeared.

■ Deleting Specified Segments (DELETE)

This deletes unneeded patterns from songs.

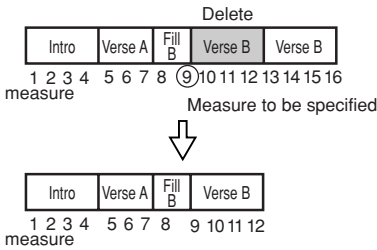

1. Press [SONG] so that the button lights up, then press STEP REC [●].
The Song Recording screen appears.
2. Press [EDIT].
3. Press [▶], select a <DELETE>, then press [ENTER].

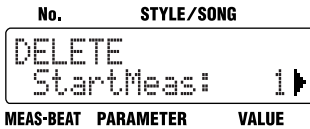

4. Turn the VALUE dial to select the beginning measure of the segment you want to delete, then press [▶].

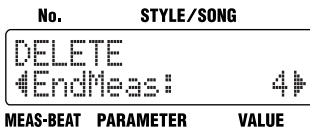

5. Turn the VALUE dial to select the last measure of the segment you want to delete, then press [▶].

* You cannot set the final measure of the segment to be deleted ahead of the beginning measure.

A confirmation screen is displayed.



If you press [◀], the immediately preceding screen returns to the display.

6. Press [ENTER] to delete the segment you've specified.

If you press [EXIT], the operation is cancelled, and you're returned to the previous screen.

* Note that the delete process may take up to a minute or more to complete when the data contains exclusive patterns (p. 78).

7. Press [EXIT] a number of times to return to the Song Recording screen.

If you press Stop [■], the Song screen is appeared.

■ Copying Specified Segments (COPY)

You can copy a specified segment of a song, and then insert the segment elsewhere in the same song.

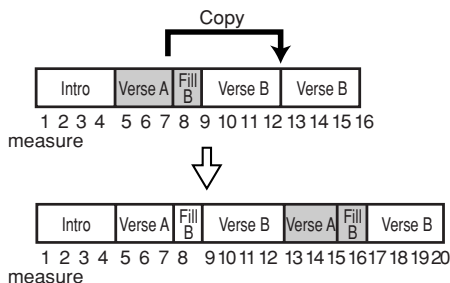

1. Press [SONG] so that the button lights up, then press STEP REC [●].
The Song Recording screen is displayed.
2. Press [EDIT].
3. Press [▶], select a <COPY>, then press [ENTER].

No.	STYLE/SONG
COPY	
StartMeas:	1▶
MEAS-BEAT	PARAMETER VALUE

4. Turn the VALUE dial to select the beginning measure of the segment you want to copy, then press [▶].

No.	STYLE/SONG
COPY	
EndMeas:	4▶
MEAS-BEAT	PARAMETER VALUE

* The maximum number of steps permitted for a song is 250. For this reason, the "EndMeas" setting cannot be given a value that would cause the song to have more than the maximum number of steps.

5. Turn the VALUE dial to select the last measure of the segment you want to copy, then press [▶].

No.	STYLE/SONG
COPY	
To:	8▶
MEAS-BEAT	PARAMETER VALUE

6. Turn the VALUE dial to select the measure in which you want to insert the copied segment, then press [▶].

No.	STYLE/SONG
COPY	
Times:	x 1▶
MEAS-BEAT	PARAMETER VALUE

7. Turn the VALUE dial to set the number of times the inserted pattern is to be repeated, then press [▶].

* The maximum number of steps permitted for a song is 250. For this reason, the "Times" setting cannot be given a value that would cause the song to have more than the maximum number of steps.

A confirmation screen is displayed.

No.	STYLE/SONG
COPY OK?	
Press [ENTER]	
MEAS-BEAT	PARAMETER VALUE

If you press [◀], the immediately preceding screen returns to the display.

8. Press [ENTER] and the pattern will be copied.

If you press [EXIT], the operation is cancelled, and you're returned to the previous screen.

* Note that the copy process may take up to a minute or more to complete when the data contains exclusive patterns (p. 78).

9. Press [EXIT] a number of times to return to the Song Recording screen.

If you press Stop [■], the Song screen is appeared.

■ Changing the Tempo Part Way Through a Song (TEMPO)

You can have the tempo change at a specified measure within the song.

This changes the tempo setting in all measures following the specified measure.

1. Press [SONG] so that the button lights up, then press STEP REC [●].
The Song Recording screen is displayed.
2. Press [◀] [▶] until the measure where you want the tempo to change is displayed.
3. Press [TEMPO (TAP)].

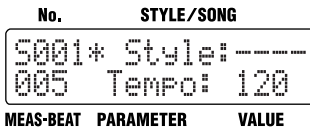

4. Turn the VALUE dial to select the tempo.
You can tap [TEMPO (TAP)] at least four times to set the tempo.
5. Press [ENTER] and the tempo change will be recorded.

If you press [EXIT], the immediately preceding screen returns to the display.

Press [■] and the Song display appears.

Undoing Tempo Changes

1. Press [SONG] so that the button lights up, then press STEP REC [●].
The Song Recording screen is displayed.
2. Press [◀] [▶] to move to the step in which the tempo has been changed.
“Tempo” appears in the display for steps in which the tempo has been changed.
3. Hold down STEP REC [●] and press [ENTER].
The tempo change is cancelled.

<5> Checking the Created Song

Play back the recorded song to confirm the tempo and TSC settings.

Change the settings as needed.

■ Performing the Created Song

1. Press [SONG].
2. Press START [▶/||] to start the performance.
3. Press STOP [■] to stop the performance.

■ Editing the Settings

You can make changes to the following settings, even after creation of the song is finalized.

- Initial Tempo —
“Setting the Basic Tempo” (p. 75)
- TSC Settings —
“Making the TSC Settings for the Song” (p. 76)

Naming, Copying, and Deleting Songs

■ Naming the Song

You can edit the name of the currently selected song, using up to ten characters for the name.

1. Select the song to be set, then press [EDIT].
The Edit Menu screen appears.
2. Select a <SONG>, then press [ENTER].
3. Press [▶], select a <NAME>, then press [ENTER].

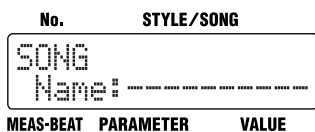

4. Press [◀] [▶] to move to the point where you want to enter the character(s).
5. Turn the VALUE dial to select the character.
Each time you press [ENTER], it switches between upper and lower case for the text being input.
6. When you press [EXIT] twice, the setting is changed, and you're returned to the previous screen.

■ Copying the Song

1. Press [EDIT].
The Edit Menu screen appears.
2. Select a <SONG>, then press [ENTER].
3. Press [▶], select a <COPY>, then press [ENTER].

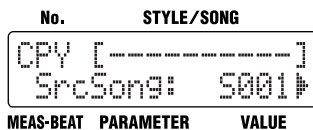

4. Turn the VALUE dial to select the number for the song to be copied, then press [▶].

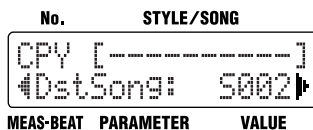

5. Turn the VALUE dial to select the copy-destination song number, then press [▶].

A confirmation screen is displayed.



If you press [◀], you're taken back to the screen you were in immediately before that.

6. Press [ENTER] to execute the copy.
You can press [EXIT] to cancel the procedure, and go back to the screen you were in right before that.

* Note that the copy process may take up to a minute or more to complete when the data contains exclusive patterns (p. 78).

■ Clearing the Song

1. Press [EDIT].
The Edit Menu screen appears.
2. Select a <SONG>, then press [ENTER].
3. Press [▶], select a <CLEAR>, then press [ENTER].

No.	STYLE/SONG
CLR [-----]	
Song:	S001
MEAS-BEAT	PARAMETER VALUE

4. Turn the VALUE dial to select the number for the song to be cleared, then press [▶].

A confirmation screen is displayed.

No.	STYLE/SONG
CLEAR OK?	
Press [ENTER]	
MEAS-BEAT	PARAMETER VALUE

If you press [◀], you're taken back to the screen you were in immediately before that.

5. Press [ENTER] to execute the clearing.
You can press [EXIT] to cancel the procedure, and go back to the screen you were in right before that.

* Note that the clear process may take up to a minute or more to complete when the data contains exclusive patterns (p. 78).

Performing Songs

Play back the recorded song.

In addition to the normal way of performing songs, you can also do the following.

- Repeat playback of a specified segment (Loop Play)
- Switch patterns with a foot switch (Block Loop)
- Play multiple songs in succession (Song Chain)

■ Performing Songs

1. With the performance stopped, press [SONG] so the button lights up.
This puts the DR-3 in Song mode.

Song No.	Song Name
S001	-----
001 P001	LP:OFF
Measure	Style No. Loop Play Mode

2. Turn the VALUE dial to select a song.
3. Press START [▶/■] to start the performance.
4. Press STOP [■] to stop the performance.

* Pressing a pattern pad in Song mode while [PTM] is on and the performance is stopped starts the performance. You cannot switch the patterns with the pattern pads.

■ Switching Patterns With a Foot Switch

Normally, when a song is played, the patterns in the song switch in the same sequence as they are recorded in the song. However, you can set the DR-3 so that a single pattern plays back repeatedly until you press the foot switch, at which point the song advances to the next pattern with “Loop Type” set to “BLOCK” (Block Loop).

When recording a song, you can record each pattern just once in the desired sequence, without having to determine the number of repeats for any pattern. You can then control how many times any one pattern is to be repeated by pressing the foot switch during playback.

You can press the foot switch during performances with “Loop Type” set to “AB” to repeat the performance of the segment specified with the following “LoopStart” and “LoopEnd” parameters (Loop Play). Press the foot switch once again to exit Loop Play and resume playing the rest of the performance.

If you want to switch patterns with a foot switch, first assign the “VERSE,LOOP” function to the foot switch. For more detailed information, refer to “Assigning Functions to the Foot Switch” (p. 49).

You can also execute this same function by pressing [ENTER] instead of the foot switch.

• When Set to “Block”

Pressing the foot switch advances the performance to the next verse.

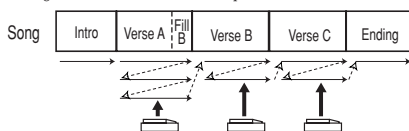

• When Set to “AB”

Loop Play is switched on and off.

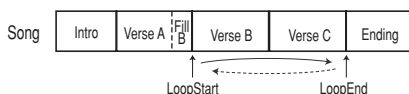

1. Select the song to play, then press [EDIT].
The Edit Menu screen appears.
2. Select a <SONG>, then press [ENTER].
3. Press [▶], select a <LoopType>.

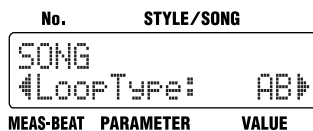

4. Turn the VALUE dial to select the value.

Value	Description
AB	Loop Play is alternately switched on and off each time you press the foot switch or [ENTER]. “LP:ON” appears in the display when Loop Play is ON. The measures at which Loop Play begins and ends are set with “LoopStart” and “LoopEnd.” Please refer to “Setting a Specified Segment for Playing Repeatedly” (p. 87).
BLOCK	When the foot switch or [ENTER] is pressed, then the song proceeds to the next pattern. “LP:BLK” appears in the display when Block Loop is ON.

* “LP:OFF” appears in the Song screen when Loop Play is switched OFF.

5. When you press [EXIT], the setting is changed, and you’re returned to the previous screen.

Setting a Specified Segment for Playing Repeatedly

This sets the specified segment for playing repeatedly (Loop Play).

1. Select the song to play, then press [EDIT].
The Edit Menu screen appears.

2. Select a <SONG>, then press [ENTER].

3. Press [▶] to select a <LoopStart> or a <LoopEnd>, then press [ENTER].
The measure where Loop Play begins is set with "LoopStart"; the measure where Loop Play stops is set with the "LoopEnd" setting.

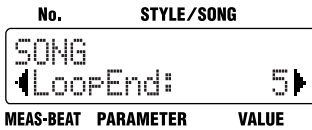
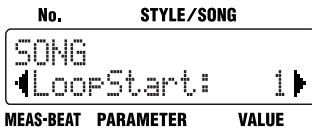

4. Turn the VALUE dial to set the starting or ending measure for Loop Play.
5. When you press [EXIT], the setting is changed, and you're returned to the previous screen.

Playing Multiple Songs Continuously (Song Chain)

You can specify the song number of the song that you want to have played right after the currently selected song, when it is played. By setting in each song the number of the song that is to follow it, you can achieve continuous playback of up to 100 songs.

You can also have the performance of any particular song(s) be repeated.



1. Select the song to play, then press [EDIT].
The Edit Menu screen appears.
2. Select a <SONG>, then press [ENTER].
3. Press [▶], select a <Chain>.



4. Turn the VALUE dial to select the value.

Value	Description
OFF	Plays back the currently selected song one time and then stops.
REPEAT	Playback of the song(s) is repeated.
S001–S100	The selected song is played back, and is followed by playback of the next specified song.

5. When you press [EXIT], the setting is changed, and you're returned to the previous screen.

* Depending on its settings, there may be some delay for the TSC (p. 51) to change, if the song is switched while Song Chain is in progress.

Chapter 9 Changing the Operating Environment (System)

These settings include those for the DR-3's pad sensitivity, Master Tuning, and other global settings.

■ How to Make the Settings

1. With the performance stopped, press [EDIT].

The Edit Menu screen appears.

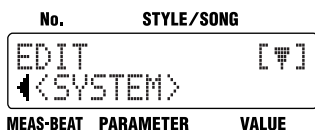

2. Press [▶], select a <SYSTEM>, then press [ENTER].

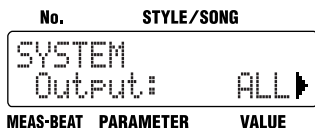

3. Press [◀][▶], select the parameter to be set.

Display	Description	Page
Output	Sets the parts output from the OUTPUT jacks.	p. 89
Auto Type	Changes the pattern progression when performing in Auto mode.	p. 47
FS1	Assigns the function controlled with Foot Switch 1.	p. 49
FS2	Assigns the function controlled with Foot Switch 2.	p. 49
PadSens	Adjust the pad sensitivity	p. 89
Mstr Tune	Sets the reference pitch for the bass part.	p. 89
Click Level	Adjusts the volume of the metronome sound.	p. 89
Sync	When connecting an external MIDI device and synchronizing the performance, this determines whether the DR-3 is to be the slave.	p. 95

Display	Description	Page
Drum MidiCh	Sets the MIDI channel for the drum part.	p. 94
Bass MidiCh	Sets the MIDI channel for the bass part.	p. 94
<FACTORY RESET>	Restores all of the settings to the original factory settings.	p. 18

4. Turn the VALUE dial to set the value.

5. When you press [EXIT], the setting is changed, and you're returned to the previous screen.

Setting the Parts To Be Output from the OUTPUT Jacks

You can set the parts that are to be heard from the external audio device connected to the OUTPUT jacks.

No.	STYLE/SONG
SYSTEM	Output: ALL ▶
MEAS-BEAT	PARAMETER VALUE

Parameter	Value	Description
Output	ALL	The sounds from all parts are played.
	DRUM	Only the drum part sounds are played. The bass part is muted.
	BASS	Only the bass part sounds are played. The drum part is muted.

Adjusting the Pad Sensitivity

The pads are less sensitive when this is set to a lower value. Although strong accents are not produced unless you tap the pads with force, it allows you to impart more subtlety and nuance to your performances.

Raising the value increases the sensitivity. Although this allows you to produce strong accents even with gentle taps, you lose the ability to add subtle changes.

No.	STYLE/SONG
SYSTEM	◀ PadSens: 5 ▶
MEAS-BEAT	PARAMETER VALUE

Parameter	Value	Description
PadSens	1-10	
	Fix	The velocity will not be affected by the strength of your tapping the pads.

Setting the Reference Pitch for the Bass Part

The reference pitch for the bass part can be set within the range of A = 438 Hz to A = 445 Hz.

* Changing this setting does not change the drum parts.

No.	STYLE/SONG
SYSTEM	◀ MstrTune: 440Hz ▶
MEAS-BEAT	PARAMETER VALUE

Parameter	Value
MstrTune	438-445 Hz

Changing the Volume of the Metronome Sound

This changes the metronome volume when Realtime Recording (p. 65) is used to record patterns.

No.	STYLE/SONG
SYSTEM	◀ ClickLevel: 5 ▶
MEAS-BEAT	PARAMETER VALUE

Parameter	Value
ClickLevel	1-10

Chapter 10 Creating Your Own Kits

You can change (edit) the settings for the User style kits, including those for the kit instruments and the way the sounds are played.

You can store up to 50 kits with edited settings as “User kits.”

- * Unable to change the settings for the Preset kit, with a “P” appended to their number.
- * When the unit left the factory, the User kits (U01–U50) contained the same settings as the Preset kits (P01–P50).
- * Certain data cannot be changed while it is being performed. First stop the performance, then make the changes.

■ How to Make the Settings

1. With the performance stopped, press [EDIT].

The Edit Menu screen appears.

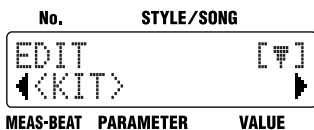

2. Press [▶], select a <KIT>, then press [ENTER].

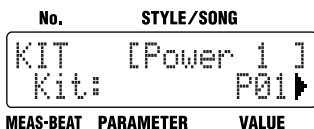

3. Turn the VALUE dial to select the number for the kit to be set, then press [▶].



4. Turn the VALUE dial to select the sound group.

Displayed	Group Name
DRUM	Drum Set
PERC	Percussion
BASS	Bass
oct BASS	The bass sound one octave lower
oct BASS	The bass sound one octave higher

5. Press the pad to be edited.

There is no need to specify the pad when “BASS” is selected for the sound group.

6. Press [◀] [▶], select the parameter to be set.

Display	Description	Page
Inst	Selects the sound assigned to the pad.	p. 91
Level	Sets the instrument’s volume level.	p. 91
Pan	Sets the positioning (pan) of the instrument’s sound.	p. 91
<NAME>	Names the drum kit.	p. 91
<COPY>	Copies the drum kit.	p. 92

7. Turn the VALUE dial to set the value.

8. Repeat Steps 4–7 as needed.

9. When you have finished making the setting, press [EXIT] a number of times until you exit Edit mode.

- * When you exit Edit mode, the kit values return to those set in the style or song (p. 63).

Selecting the Sounds Assigned to the Pads

This selects the instruments to be assigned to the pads.



Parameter	Value
Inst	Refer to the “Instrument/Bass Tone List” (p. 104).

* You cannot select bass tones for the drum parts, and cannot select drum instruments for the bass part.

Setting the Volume

This sets the volume (the level) for each instrument. The velocity when you actually tap the key pads is changed within the level range set here.

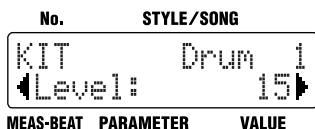

Parameter	Value
Level	0–15

Setting the Position of the Sound

This sets the placement (Pan) of each instrument, with fifteen degrees of adjustment.

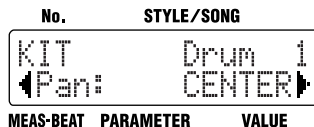

Parameter	Value
Pan	L7-CENTER-R7



Naming the Kit

You can edit the name of the currently selected kit, using up to eight characters for the name.

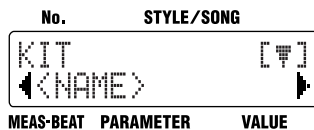

Press [ENTER].

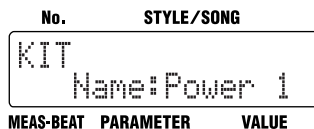

Press [◀][▶] to move to the point where you want to enter the character(s).

Each time you press [ENTER], it switches between upper and lower case for the text being input.

Turn the VALUE dial to select the character.

Copying the Kit

This copies the kit to the User kit (U01–U50).

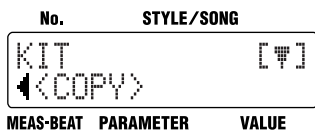

Press [ENTER].

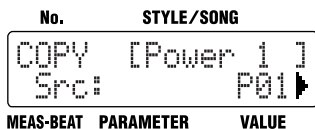

Turn the VALUE dial to select the number for the kit to be copied, then press [▶].

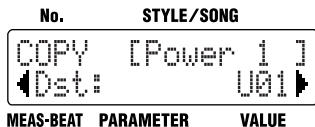

Turn the VALUE dial to select the copy-destination kit number, then press [▶].



Press [ENTER] to execute the copy.

If you press [◀], you're taken back to the screen you were in immediately before that.

You can press [EXIT] to cancel the procedure, and go back to the previous screen.

Chapter 11 Connecting and Using External MIDI Devices

■ What is MIDI?

MIDI (Musical Instrument Digital Interface) is a universal standard that allows for the exchange of performance data and other information among electronic musical instruments and computers. Once MIDI cables are used to connect together devices equipped with MIDI connectors, each device can send data to, or receive data from any of the others.

MIDI Connector

The DR-3 is equipped with a MIDI IN connector.

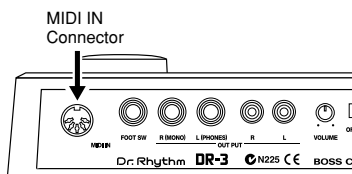

MIDI IN

Receives data from an external MIDI device. Connect to the MIDI OUT connector on the external MIDI device.

With the DR-3, you can use MIDI data to do the following.

- Use an external MIDI device to play the DR-3
- Starting/stopping and synchronizing performances on the DR-3 from a digital recorder or MIDI sequencer
- Using the DR-3 to record performances played by external MIDI devices

MIDI Implementation Chart

In order to exchange MIDI data, the data transmitted by the MIDI devices must be common to both. The owner's manuals for a MIDI device always includes a MIDI Implementation Chart, which allows you to quickly check the compatibility of that device with other devices. By comparing the MIDI Implementation Charts of each device you are using, you can confirm which kinds of data can be exchanged.

* For more details concerning the way MIDI has been implemented on this unit, please refer to "MIDI Implementation" (p. 117).

* Some MIDI messages cannot be received while editing is in progress.

Starting/Stopping and Synchronizing Performances on the DR-3 from an External MIDI Device

You can synchronize the DR-3's performances with digital recorders, MIDI sequencers, rhythm machines, and other such devices.

Master and Slave

When synchronizing two or more devices, one is made the "master" device and all others "slaves."

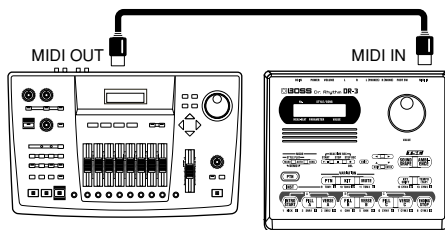

Master

Slave (DR-3)

When the master device is started or stopped, a MIDI message for that operation is transmitted. The slave or slaves then start or stop in accordance with the transmitted MIDI message.

Furthermore, timing clock data corresponding to the tempo is transmitted by the master device. Slave devices synchronize their performances to this timing clock.

Other data transmitted from the master device to slave devices includes song numbers (Song Select) and the position of song performances (Song Position Pointer).

Data Synchronized with the DR-3

The following MIDI messages are handled during synchronization with the DR-3.

- Start
- Timing Clock
- Continue
- Song Select
- Stop
- Song Position Pointer

* For more information on the MIDI messages handled by the devices you are connecting, refer to the owner's manual for each device.

* When synchronizing a drum machine connected to the DR-3, you should set things up so that sounds are not played by the DR-3's internal sound generator in response to Note messages received from the connected drum machine. Either prevent Note messages from being transmitted by the connected device, or set the DR-3 so it doesn't receive Note messages. For more on the DR-3's MIDI channel settings, refer to the following.

■ Setting the MIDI Channels

To enable proper reception of performance data, the MIDI channels for the transmitting and receiving devices must be matched.

You can assign the drum part and bass part to different MIDI channels.

1. With the performance stopped, press [EDIT].

The Edit Menu screen appears.

2. Press [▶], select a <SYSTEM>, then press [ENTER].

3. Press [▶], select a <DrumMidiCh> or a <BassMidiCh> to be set.

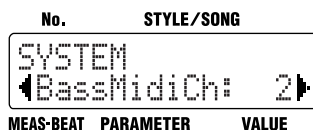
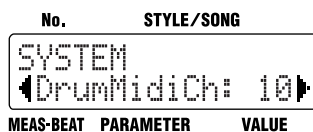

4. Turn the VALUE dial to set the value.

Parameter	Value	
Drum MidiCh	OFF, 1-16	Sets the drum part MIDI channel When set to "OFF," Note and Program Change messages are not received.
Bass MidiCh	OFF, 1-16	Sets the bass part MIDI channel When set to "OFF," Note messages are not received.

* Program Change messages are received on the drum part MIDI channel.

5. Press [EXIT] a number of times until you exit Edit mode.

■ Setting Sync Mode

When connecting an external MIDI device and synchronizing the performance, this determines whether the DR-3 is to be the slave.

1. **With the performance stopped, press [EDIT].**
The Edit Menu screen appears.
2. **Press [▶], select a <SYSTEM>, then press [ENTER].**
3. **Press [▶], select a <Sync>.**

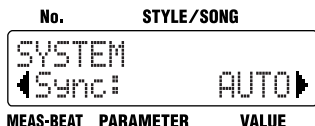

4. **Turn the VALUE dial to set the value.**

Parameter	Value	Description
Sync	AUTO	When the performance is stopped and a Start message is input from an external MIDI device, the DR-3 automatically switches to slave.
	REMOTE	Messages input from the external MIDI device are used only to control starting and stopping.
	INT	You can use Note messages from external MIDI devices to play the DR-3's internal sound generator, without synchronization.

5. **Press [EXIT] a number of times until you exit Edit mode.**

* When the DR-3 is functioning as a slave device, the tempo cannot be controlled from the DR-3.

Using An External MIDI Device to Play the DR-3

You can use performance data transmitted from an external MIDI device to play the DR-3.

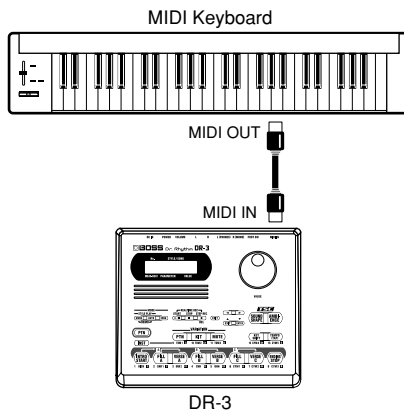

MIDI Channels

In order to exchange performance data between an external MIDI device and the DR-3, the MIDI channel settings must be the same for both devices. Performance data can be exchanged successfully only when the MIDI channels match. For more on the DR-3's MIDI channel settings, refer to "Setting the MIDI Channels" (p. 94).

Performance Data Handled by the DR-3

- Note Messages

These are messages that convey the performance status of drum parts and bass parts. These are equivalent to the performance data for keys on a keyboard. The different kinds of Note messages are shown below.

Note Number	Pad number to which an instrument or bass tone is assigned
Note On	Pad is tapped
Note Off	Pad is released
Velocity	Force used to tap the pad

This correspondence of the DR-3's pads to Note Number as shown below.

- Select "DRUM" for the "INST"



- Select "PERC" for the "INST"

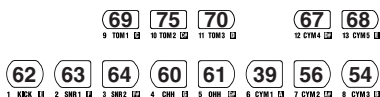

- Note numbers are 28–64 when BASS is selected for INST.

When you tap one of the DR-3's pads, the Note Number for that pad is transmitted.

When a Note Number is received from an external MIDI device, the instrument or bass tone assigned to the pad corresponding to that Note Number is played.

- * Note Numbers that do not correspond to any of the pads are disregarded if received.

- Program Change

This message switches the drum kit.

- * Program Change messages are received on the drum part MIDI channel.

- * For more information on the messages that can be handled by the devices you are connecting, refer to the owner's manual for each device.

Using the DR-3 to Record Performances Played by External MIDI Devices

The DR-3 can be used to record, in real time, what is being played on a MIDI keyboard or MIDI pads. You can also use the DR-3 to record performance data from sequencers and rhythm machines.

- * When recording performances from an external device, set "Sync" in [EDIT] <SYSTEM> to "AUTO" (p. 95).
- * To enable proper reception of performance data, the MIDI channels for the transmitting and receiving devices must be matched. For more on MIDI channel settings, refer to p. 94.

Recording Performances on MIDI Keyboards and MIDI Pads

When recording MIDI keyboard or MIDI pad performances as DR-3 patterns, the patterns are recorded in real time.

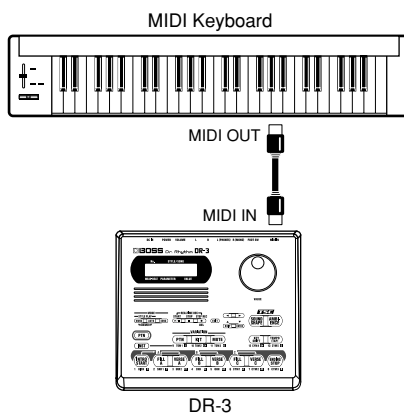

First, follow the instructions in "<2> Making the Settings for the New Style" (p. 62) to make the necessary settings. Follow the instructions in Step 5 of "• Recording the Drum Part" (p. 65) (or "• Recording the Bass Part" (p. 66)) to play the MIDI keyboard or MIDI pad performance.

To stop recording, press STOP [■].

Recording Sequencer and Rhythm Machine Performances

When connecting a sequencer or rhythm machine and recording the performance data from it, the start of recording with the DR-3 is controlled from the connected device.

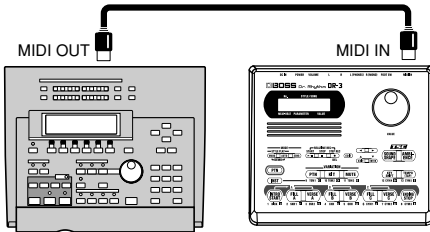

MIDI Sequencer
etc.

DR-3

Press [MANU] on the DR-3 so that the button lights up, then press STEP REC [●]. The DR-3 begins recording at the same time the performance from the connected sequencer or rhythm machine is played back.

To stop recording, press STOP [■].

Appendices

Troubleshooting

If you find the DR-3 is not operating correctly, check the items listed below.

If the DR-3 still does not work properly after you check these points, consult your local Roland Service or your dealer.

Problem	Check/Solution
No sound	Is the volume turned down (p. 17)?
	Is the Output set to "DRUM" or "BASS" (p. 89)?
	Is the instrument's level set to "0" (p. 91)?
	Have you selected a style, pattern or song containing no performance data?
Sounds drop out	Are you playing too many sounds simultaneously? The DR-3 has a maximum polyphony of 12 sounds.
Performance does not start when START [▶/] is pressed	Have you selected a style, pattern or song containing no performance data?
The button does not flash when STEP REC [●] is pressed / Recording does not start STEP REC [●] is held down and START [▶/] is pressed	Have you selected a Preset Style? Select User Styles with a "U" appended to their number (p. 62).
	Have you selected Edit mode? Press [EXIT] in number of times until you exit Edit mode.
No metronome sound when Realtime Recording is used	Is the metronome level (Click Level) set to "0" (p. 89)?
Cannot change the settings (Kits, Styles, TSC)	Have you selected a Preset? Select User settings with a "U" appended to their number (p. 90, p. 62, p. 75)
	Certain data cannot be changed while it is being performed. First stop the performance, then make the changes.
Cannot play the DR-3 using an external MIDI device / Cannot play external MIDI device from the DR-3	Are the MIDI channel settings correct (p. 94)?
	Are the note numbers correct (p. 96)?
	Some MIDI messages cannot be received while editing is in progress. Press [EXIT] in number of times until you exit Edit mode.
	Are the foot switch properly connected (p. 29)?
Foot switch does not work	Are the foot switch properly connected (p. 29)?
	During recording or editing, depressing the foot switch will have no effect.

Message List

Message Keep Power On! Now Working...

- Cause** Data is being saved to memory.
- Action** Never turn off the power while this message is displayed. This may cause damage to the internal memory, rendering it useless.

Message Battery Low!

- Cause** The DR-3's batteries are running low.
- Action** Use the AC adapter, or change the batteries promptly (p. 15). Press any button to clear the message. Sounds may become distorted, or the DR-3 may not operate correctly if you continue to use it in this condition.

Message Can Not Edit!

- Cause** Unable to change the settings for the Preset Styles, Preset kits, or TSC presets with a "P" appended to their number.
- Action** Select User Styles, User kits, and TSC presets with a "U" appended to their number.
- Action** When basing your data on Preset data, copy the preset data to the User memory before changing the settings.

Message Can Not Record

- Cause** Unable to record on the Preset Styles.
- Action** Select User Style and record performance.

Message Data Empty!

- Cause** No data.

Message Memory Full!

- Cause** Memory is full.
- Action** Try the operation once again.
- Action** Delete unneeded patterns or songs (p. 73, p. 85).

Message Song Data Full!

- Cause** No space remains in the song for any more patterns to be recorded.
- Action** You can record or copy up to a maximum of 250 patterns in one song.

Message Excl. Ptn Full!

- Cause** The exclusive patterns for songs are full (p. 78).
- Action** To continue recording or copying, first delete the exclusive patterns.

Message Stop SEQ!

- Cause** The operation you attempted cannot be carried out while a Style or song is being performed or recorded.
- Action** Press STOP [■] to stop the performance or recording of the Style or song, then try the operation again.

Message MIDI Off Line!

- Cause** A MIDI Active Sensing error has occurred. An abnormality has been detected in the device or cable connected to MIDI IN.
- Action** Check the device or cable connected to MIDI IN.

Message MIDI Full!

- Cause** Too many MIDI messages were received all at once, and the DR-3 was unable to process all of them.
- Action** Reduce the volume of the MIDI messages being sent by the transmitting device.

Message Too Busy!

- Cause** The system attempted to concurrently process abnormally large amounts of data, but was unable to succeed.
- Action** Make sure that the unit is not being forced to handle an overly large amount of data (in patterns, or received MIDI messages) all at once, and try to reduce the amount of data.

Message System Error!

- Cause** An unknown error has occurred in the system.
- Action** Immediately stop using the unit, and consult your dealer or nearest Roland Service Center.

Parameter List

Parameter	Display	Value
Temporary (These parameters are not saved. These are reset each time the DR-3's power is turned on.)		
Sound Shape	TSC AUDITION / Shape	P1 - P8, U1 - U8
Ambience	TSC AUDITION / Ambi	P1 - P8, U1 - U8
Tempo	PLAY TEMPO / Tempo	20 - 260
Key Shift	PLAY KEY SHIFT / KeyShift	-12 - +12
Style (This is selectable in Style Play Mode)		
Tempo	Tempo	20 - 260
Beat	Beat	2/4 - 8/4, 4/8 - 16/8
Kit	Kit1	P01 - P50, U01 - U50
Kit Variation	Kit2	P01 - P50, U01 - U50
Mute Variation	Mute	HH, Kick, Bass, HH&Kick, Kick&Bass, HH&Bass, Drums
Sound Shape Switch	ShapeSw	OFF, ON
Sound Shape	Shape	P1 - P8, U1 - U8
Ambience Switch	AmbiSw	OFF, ON
Ambience	Ambi	P1 - P8, U1 - U8
<Pattern>	<PATTERN>	
Pattern Measure / PATTERN MEAS	INTRO, VERSE A, VERSE B, VERSE C, ENDING	1 - 4
Pattern Key Transpose / PTN KEY TRANS	INTRO, FILL A, VERSE A, VERSE Av, FILL B, VERSE B, VERSE Bv, FILL C, VERSE C, VERSE Cv, ENDING	-12 - +12
Pattern Copy	<COPY>	
Pattern Clear	<CLEAR>	
Style Name	<NAME>	10 letters
Style Copy	<COPY>	
Style Clear	<CLEAR>	
Song (This is selectable in Song Mode)		
Initial Tempo	InitTempo	20 - 260
Sound Shape Switch	ShapeSw	OFF, ON
Sound Shape	Shape	P1 - P8, U1 - U8
Ambience Switch	AmbiSw	OFF, ON
Ambience	Ambi	P1 - P8, U1 - U8
Loop Type	LoopType	AB, BLOCK
Loop Start	LoopStart	1 - Last mesure number of the song
Loop End	LoopEnd	1 - Last mesure number of the song
Song Chain	Chain	OFF, REPEAT, S001 - S100
Song Name	<NAME>	10 letters
Song Copy	<COPY>	
Song Clear	<CLEAR>	

Parameter List

Kit		
Kit	Kit	P1 - P50, U1 - U50
Instrument	Inst	"Instrument/Bass Tone List" (p. 104)
Level	Level	0 - 15
Pan	Pan	L7 - CENTER - R7
Kit Name	<NAME>	8 letters
Kit Copy	<COPY>	
Sound Shape		
Sound Shape	Shape	P1 - P8, U1 - U8
Equalizer Switch	EQ / Switch	OFF, ON
Equalizer Input	EQ / Input	-24 dB - +12 dB
Equalizer Low Type	EQ (Low) / Type	Shelving, Peaking
Equalizer Low Gain	EQ (Low) / Gain	-12 dB - +12 dB
Equalizer Low Frequency	EQ (Low) / Freq	20 Hz - 2.0 kHz
Equalizer Low Q	EQ (Low) / Q	0.3 - 16.0
Equalizer Middle Gain	EQ (Mid) / Gain	-12 dB - +12 dB
Equalizer Middle Frequency	EQ (Mid) / Freq	20 Hz - 8.0 kHz
Equalizer Middle Q	EQ (Mid) / Q	0.3 - 16.0
Equalizer High TYPE	EQ (High) / Type	Shelving, Peaking
Equalizer High Gain	EQ (High) / Gain	-12 dB - +12 dB
Equalizer High Frequency	EQ (High) / Freq	500 Hz - 14.0 kHz
Equalizer High Q	EQ (High) / Q	0.3 - 16.0
Equalizer Out Level	EQ / OutLevel	-24 dB - +12 dB
Compressor Switch	COMP / Switch	OFF, ON
Compressor Sprit Frequency L	COMP / SpritL	20 Hz - 800 Hz
Compressor Sprit Frequency H	COMP / SpritH	1.6 kHz - 14.0 kHz
Compressor Low Threshold	COMP(Low) / Thres	-30 dB - +6 dB
Compressor Low Ratio	COMP(Low) / Ratio	1: 1.00 - 1: 16.0, 1: INF
Compressor Low Attack	COMP(Low) / Attack	0 ms - 100 ms
Compressor Low Release	COMP(Low) / Release	50 ms - 5000 ms
Compressor Middle Threshold	COMP(Mid) / Thres	-30 dB - +6 dB
Compressor Middle Ratio	COMP(Mid) / Ratio	1: 1.00 - 1: 16.0, 1: INF
Compressor Middle Attack	COMP(Mid) / Attack	0 ms - 100 ms
Compressor Middle Release	COMP(Mid) / Release	50 ms - 5000 ms
Compressor High Threshold	COMP(Hi) / Thres	-30 dB - +6 dB
Compressor High Ratio	COMP(Hi) / Ratio	1: 1.00 - 1: 16.0, 1: INF
Compressor High Attack	COMP(Hi) / Attack	0 ms - 100 ms
Compressor High Release	COMP(Hi) / Release	50 ms - 5000 ms
Compressor Low Level	COMP / Low Lev	-60 dB - +6 dB
Compressor Middle Level	COMP / Mid Lev	-60 dB - +6 dB
Compressor High Level	COMP / High Lev	-60 dB - +6 dB
Compressor Out Level	COMP / OutLevel	-60 dB - +6 dB
Sound Shape Name	<NAME>	6 letter
Sound Shape Copy	<COPY>	

Ambience		
Ambience	Ambi	P1 - P8, U1 - U8
Reverb Size	Size	5.6 m - 20.5 m
Reverb Time	Time	0.1 - 32.0
Reverb Level	Level	0 - 100
Pre Delay	PreDelay	0 ms - 20 ms
Density	Density	0 - 100
Early Reflection Level	ErLevel	0 - 100
Release Density	RelDensity	0 - 100
Low Damp Gain	Low Damp / Gain	-36.0 dB - 0.0 dB
Low Damp Frequency	Low Damp / Freq	55 Hz - 4.00 kHz
High Damp Gain	Hi Damp / Gain	-36.0 dB - 0.0 dB
High Damp Frequency	Hi Damp / Freq	400 Hz - 14 kHz
Low Cut Frequency	Low Cut / Freq	20 Hz - 2.0 kHz
High Cut Frequency	High Cut / Freq	250 Hz - 14.0 kHz, FLAT
Ambience Name	<NAME>	6 letters
Ambience Copy	<COPY>	
System		
Output	Output	ALL, DRUM, BASS
Auto Repeat Type	AutoType	ABC, ABC4, ABC8, ABC16, AB, AB4, AB8, AB16
Foot Switch 1	FS1	INTRO/END, VERSE, LOOP, VAR PTN, VAR KIT, VAR MUTE, TAP TEMPO, STRT/PAUSE, START/STOP, STYLE FWD, STYLE BWD, INTRO, FILL A, VERSE A, FILL B, VERSE B, FILL C, VERSE C, ENDING, DRUM KICK - DRUM CYM5, PERC 1 - PERC 13
Foot Switch 2	FS2	
Pad Sensitivity	PadSens	1 - 10, FIX
Master Tune	MstrTune	438 Hz - 445 Hz
Click Level	ClickLevel	0 - 10
MIDI Synchro Mode	Sync	AUTO, REMOTE, INT
Drum MIDI Channel	DrumMidiCh	OFF, 1 - 16
Bass MIDI Channel	BassMidiCh	OFF, 1 - 16
Factory Reset	<FACTORY RESET>	

Instrument/Bass Tone List

Instrument

Inst. No.	v	Display	Instrument
K01		Maple	Maple Kick
K02		Rnd1	Round Kick 1
K03		Rnd2	Round Kick 2
K04		Dry	Dry Hard Kick
K05		Comp	Comp Kick
K06		Rev1	Reverb Kick 1
K07		Rev2	Reverb Kick 2
K08		Stdio	Studio Kick
K09		26"dp	26" Deep Kick
K10		Jazz	Jazz Kick
K11		Elec	Electronic Kick
K12		TR909	TR-909 Kick
S01	v	Wet	Wet Snare / Soft Shot
S02		Warm	Warm Snare Hard Shot
S03		Maple	Maple Snare
S04	v	Maple	Maple Snare / Beach Soft Shot
S05		BchH	Beech Snare Hard Rim Shot
S06		BchS	Beech Snare Soft Shot
S07	v	Beech	Beech Snare Rim / Beech Snare Soft
S08		Open	Open Snare Rim Shot
S09	v	Open	Open Sanre / Beech Snare Soft Shot
S10		Dry	Dry Snare Hard Shot
S11	v	Dry	Dry Snare Hard Shor / Med Soft Shot
S12		MdSft	Medium Soft Shot
S13		NatrI	Natural Snare
S14	v	NatrI	Natural Snare / BeechSoft
S15	v	Rock	Rock Rim Shot / Med Soft
S16		Picco	Piccolo Rim Shot Snare
S17		House	House Snare
S18		Soft	Soft Shot
S19		BrshR	Brush Roll
S20		BrshS	Brush Slap
S21	v	BrshS	Brush Slap / Swish
S22		Whack	Whack Snare
S23		Regga	Reggae Snare
S24		Elec	Electronic Snare
S25		TR808	TR-808 Snare
S26		Doubl	Double Shot Ghost
S27		Buzz	Buzz Snare Ghost
S28		Stck1	Ambient Cross Stick
S29		Stck2	Natural Cross Stick
S30		Stck3	TR-808 Cross Stick

Inst. No.	v	Display	Instrument
T01		VintH	Vintage Tom High
T02		VintM	Vintage Tom Mid
T03		VintL	Vintage Tom Low
T04		AmbiH	Ambient Tom High
T05		AmbiM	Ambient Tom Mid
T06		AmbiL	Ambient Tom Low
T07		DbIH	Double Head Tom High
T08		DbIM	Double Head Tom Mid
T09		DbIL	Double Head Tom Low
T10		RockH	Rock Tom High
T11		RockM	Rock Tom Mid
T12		RockL	Rock Tom Low
T13		BrshH	Brush Slap Tom High
T14		BrshM	Brush Slap Tom Mid
T15		BrshL	Brush Slap Tom Low
T16		ElecH	Electronic Tom High
T17		ElecM	Electronic Tom Mid
T18		ElecL	Electronic Tom Low
T19		TR H	TR-808 Tom High
T20		TR M	TR-808 Tom Mid
T21		TR L	TR-808 Tom Low
H01		PureC	Pure Closed Hi-Hat *1
H02		PureO	Pure Open Hi-Hat *1
H03		PureP	Pure Pedal Closed Hi-Hat *1
H04	v	PureO	Pure HH Open / Pedal *1
H05		16"C	16" Closed Hi-Hat *1
H06		16"O	16" Open Hi-Hat *1
H07		16"P	16" Pedal Closed Hi-Hat *1
H08	v	16"O	16" HH Open / Pedal *1
H09		RealC	Real Closed Hi-Hat *1
H10		RealO	Real Open Hi-Hat *1
H11	v	RealO	Real HH Open / Pedal *1
H12		BrshC	Brush Closed Hi-Hat *1
H13		BrshO	Brush Open Hi-Hat *1
C01		Crsh1	Crash Cymbal 1 *2
C02		Crsh2	Crash Cymbal 2 *3
C03		Crsh3	Crash Cymbal 3 *4
C04		Chok1	Choked Crash 1 *2
C05		Chok2	Choked Crash 2 *3
C06		Chok3	Choked Crash 3 *4
C07		Splsh	Splash Cymbal
C08		China	Chinese Cymbal

Inst. No.	v	Display	Instrument
C09		Ride1	Ride Cymbal 1
C10		Ride2	Ride Cymbal 2
C11		Bell1	Ride Bell Cymbal 1
C12		Bell2	Ride Bell Cymbal 2
C13		BrshC	Brush Crash Cymbal
C14		BrshR	Brush Ride Cymbal
C15		Gong	Large Gong
P01		Cowbl	Cowbell
P02		Tmbrn	Tambourine
P03		BngoH	Bongo High
P04		BngoL	Bongo Low
P05		CngHM	Conga High Mute
P06		CngHO	Conga High Open
P07		CngaL	Conga Low Open
P08		TmbIH	Timbale High
P09		TmbIL	Timbale Low
P10		Clave	Clave
P11		Vibra	Vibraslap
P12		GuirS	Guiro Short
P13		GuirL	Guiro Long
P14		Marcs	Maracas
P15		Shakr	Shaker
P16		Cabas	Cabasa
P17		WhsIS	Whistle Short
P18		WhsIL	Whistle Long
P19		AgogH	Agogo High
P20		AgogL	Agogo Low
P21		CuicH	Cuica High
P22		CuicL	Cuica Low
P23		SurdM	Surdo Mute
P24		SurdO	Surdo Open
P25		Tbla1	Tabla 1
P26		Tbla2	Tabla 2
P27		Tbla3	Tabla 3
P28		Clap1	Real Clap
P29		Clap2	TR-808 Clap

v...The sound will alter depending on the strength you tap the pads.

*1-*4...will not sound simultaneously with other percussion instruments of the same number.

Bass Tone

Inst. No.	Display	Instrument
B01	Fing1	Fingered Bass 1
B02	Fing2	Fingered Bass 2
B03	MuteB	Mute Bass
B04	Frtls	Fretless Bass
B05	Pick1	Picked Bass 1
B06	Pick2	Picked Bass 2
B07	Acous	Acoustic Bass
B08	Slap	Slap Bass
B09	Stick	Stick
B10	Solid	Solid Bass
B11	Pluck	Pluck Bass
B12	Sine	Sine Wave Bass

Preset Kit List

Kit No. Kit Name	No. P01 Power1		No. P02 BigFunk		No. P03 Groove		No. P04 Studio 1		No. P05 Room 1	
	Inst. No.	Instrument	Inst. No.	Instrument	Inst. No.	Instrument	Inst. No.	Instrument	Inst. No.	Instrument
DRUM KICK	K03	Rnd2	K01	Maple	K02	Rnd1	K04	Dry	K06	Rev1
DRUM SNR1	S01	v Wet	S01	v Wet	S01	v Wet	S09	v Open	S08	Open
DRUM SNR2	S28	Stck1	S27	Buzz	S27	Buzz	S26	Doubl	S28	Stck1
DRUM CHH	H05	16"C	H09	RealC	H09	RealC	H05	16"C	H09	RealC
DRUM OHH	H08	v 16"O	H10	RealO	H11	v RealO	H08	v 16"O	H10	RealO
DRUM CYM1	C12	Bell2	C12	Bell2	C12	Bell2	C12	Bell2	C12	Bell2
DRUM CYM2	C10	Ride2	C10	Ride2	C10	Ride2	C10	Ride2	C10	Ride2
DRUM CYM3	C01	Crsh1	C01	Crsh1	C01	Crsh1	C01	Crsh1	C01	Crsh1
DRUM TOM1	T07	DbIH	T07	DbIH	T07	DbIH	T04	AmbiH	T04	AmbiH
DRUM TOM2	T08	DbIM	T08	DbIM	T08	DbIM	T05	AmbiM	T05	AmbiM
DRUM TOM3	T09	DbIL	T09	DbIL	T09	DbIL	T06	AmbiL	T06	AmbiL
DRUM CYM4	C02	Crsh2	C04	Chok1	C03	Crsh3	C07	Splsh	C03	Crsh3
DRUM CYM5	C08	China	C08	China	C08	China	C08	China	C07	Splsh
PERC 1	P05	CngHM	P05	CngHM	P05	CngHM	P05	CngHM	P05	CngHM
PERC 2	P06	CngHO	P06	CngHO	P06	CngHO	P06	CngHO	P06	CngHO
PERC 3	P07	CngaL	P07	CngaL	P07	CngaL	P07	CngaL	P07	CngaL
PERC 4	P03	BngoH	P03	BngoH	P03	BngoH	P03	BngoH	P03	BngoH
PERC 5	P04	BngoL	P04	BngoL	P04	BngoL	P04	BngoL	P04	BngoL
PERC 6	P29	Clap2	P29	Clap2	P29	Clap2	P29	Clap2	P29	Clap2
PERC 7	P01	Cowbl	P01	Cowbl	P01	Cowbl	P01	Cowbl	P01	Cowbl
PERC 8	P02	Tmbrn	P02	Tmbrn	P02	Tmbrn	P02	Tmbrn	P02	Tmbrn
PERC 9	P16	Cabas	P16	Cabas	P16	Cabas	P16	Cabas	P16	Cabas
PERC 10	P10	Clave	P10	Clave	P10	Clave	P10	Clave	P10	Clave
PERC 11	P14	MarcS	P14	MarcS	P14	MarcS	P14	MarcS	P14	MarcS
PERC 12	P19	AgogH	P19	AgogH	P19	AgogH	P19	AgogH	P19	AgogH
PERC 13	P20	AgogL	P20	AgogL	P20	AgogL	P20	AgogL	P20	AgogL
Bass	B05	Pick1	B09	Stick	B08	Slap	B01	Fing1	B05	Pick1

Kit No. Kit Name	No. P06 Loud		No. P07 Power 2		No. P08 Big		No. P09 Funk 1		No. P10 Natural1	
	Inst. No.	Instrument	Inst. No.	Instrument	Inst. No.	Instrument	Inst. No.	Instrument	Inst. No.	Instrument
DRUM KICK	K06	Rev1	K07	Rev2	K09	26"dp	K04	Dry	K05	Comp
DRUM SNR1	S02	Warm	S02	Warm	S07	v Beech	S07	v Beech	S14	v Natrl
DRUM SNR2	S28	Stck1	S28	Stck1	S26	Doubl	S26	Doubl	S28	Stck1
DRUM CHH	H05	16°C	H05	16°C	H05	16°C	H01	PureC	H01	PureC
DRUM OHH	H08	v 16"O	H08	v 16"O	H08	v 16"O	H04	v PureO	H04	v PureO
DRUM CYM1	C08	China	C12	Bell2	C11	Bell1	C12	Bell2	C11	Bell1
DRUM CYM2	C10	Ride2	C10	Ride2	C10	Ride2	C09	Ride1	C09	Ride1
DRUM CYM3	C01	Crsh1	C01	Crsh1	C01	Crsh1	C02	Crsh2	C01	Crsh1
DRUM TOM1	T10	RockH	T04	AmbiH	T07	DbIH	T01	VintH	T07	DbIH
DRUM TOM2	T11	RockM	T05	AmbiM	T08	DbIM	T02	VintM	T08	DbIM
DRUM TOM3	T12	RockL	T06	AmbiL	T09	DbIL	T03	VintL	T09	DbIL
DRUM CYM4	C02	Crsh2	C02	Crsh2	C02	Crsh2	C07	Splsh	C02	Crsh2
DRUM CYM5	C15	Gong	C15	Gong	C08	China	C08	China	C08	China
PERC 1	P05	CngHM	P05	CngHM	P05	CngHM	P05	CngHM	P05	CngHM
PERC 2	P06	CngHO	P06	CngHO	P06	CngHO	P06	CngHO	P06	CngHO
PERC 3	P07	CngaL	P07	CngaL	P07	CngaL	P07	CngaL	P07	CngaL
PERC 4	P03	BngoH	P03	BngoH	P03	BngoH	P03	BngoH	P03	BngoH
PERC 5	P04	BngoL	P04	BngoL	P04	BngoL	P04	BngoL	P04	BngoL
PERC 6	P29	Clap2	P29	Clap2	P29	Clap2	P29	Clap2	P29	Clap2
PERC 7	P01	Cowbl	P01	Cowbl	P01	Cowbl	P01	Cowbl	P01	Cowbl
PERC 8	P02	Tmbrn	P02	Tmbrn	P02	Tmbrn	P02	Tmbrn	P02	Tmbrn
PERC 9	P16	Cabas	P16	Cabas	P16	Cabas	P16	Cabas	P16	Cabas
PERC 10	P10	Clave	P10	Clave	P10	Clave	P10	Clave	P10	Clave
PERC 11	P14	MarcS	P14	MarcS	P14	MarcS	P14	MarcS	P14	MarcS
PERC 12	P19	AgogH	P19	AgogH	P19	AgogH	P19	AgogH	P19	AgogH
PERC 13	P20	AgogL	P20	AgogL	P20	AgogL	P20	AgogL	P20	AgogL
Bass	B05	Pick1	B06	Pick2	B09	Stick	B08	Slap	B06	Pick2

Preset Kit List

Kit No. Kit Name	No. P11 Gospel		No. P12 Room 2		No. P13 Ambient		No. P14 HeavyFnk		No. P15 Whack	
	Inst. No.	Instrument	Inst. No.	Instrument	Inst. No.	Instrument	Inst. No.	Instrument	Inst. No.	Instrument
DRUM KICK	K01	Maple	K06	Rev1	K06	Rev1	K03	Rnd2	K03	Rnd2
DRUM SNR1	S14	v Natrl	S15	v Rock	S15	v Rock	S15	v Rock	S22	Whack
DRUM SNR2	S29	Stck2	S28	Stck1	S01	v Wet	S27	Buzz	S15	v Rock
DRUM CHH	H05	16°C	H01	PureC	H05	16°C	H09	RealC	H05	16°C
DRUM OHH	H08	v 16"O	H04	v PureO	H08	v 16"O	H11	v RealO	H08	v 16"O
DRUM CYM1	C12	Bell2	C12	Bell2	C12	Bell2	C11	Bell1	C11	Bell1
DRUM CYM2	C10	Ride2	C10	Ride2	C09	Ride1	C10	Ride2	C10	Ride2
DRUM CYM3	C01	Crsh1	C01	Crsh1	C01	Crsh1	C01	Crsh1	C01	Crsh1
DRUM TOM1	T07	DbIH	T04	AmbiH	T10	RockH	T07	DbIH	T04	AmbiH
DRUM TOM2	T08	DbIM	T05	AmbiM	T11	RockM	T08	DbIM	T05	AmbiM
DRUM TOM3	T09	DbIL	T06	AmbiL	T12	RockL	T09	DbIL	T06	AmbiL
DRUM CYM4	C07	Splsh	C02	Crsh2	C02	Crsh2	C02	Crsh2	C02	Crsh2
DRUM CYM5	C08	China	C08	China	C08	China	C08	China	C08	China
PERC 1	P05	CngHM	P05	CngHM	P05	CngHM	P05	CngHM	P05	CngHM
PERC 2	P06	CngHO	P06	CngHO	P06	CngHO	P06	CngHO	P06	CngHO
PERC 3	P07	CngaL	P07	CngaL	P07	CngaL	P07	CngaL	P07	CngaL
PERC 4	P03	BngoH	P03	BngoH	P03	BngoH	P03	BngoH	P03	BngoH
PERC 5	P04	BngoL	P04	BngoL	P04	BngoL	P04	BngoL	P04	BngoL
PERC 6	P28	Clap1	P29	Clap2	P29	Clap2	P29	Clap2	P29	Clap2
PERC 7	P01	Cowbl	P01	Cowbl	P01	Cowbl	P01	Cowbl	P01	Cowbl
PERC 8	P02	Tmbrn	P02	Tmbrn	P02	Tmbrn	P02	Tmbrn	P02	Tmbrn
PERC 9	P16	Cabas	P16	Cabas	P16	Cabas	P16	Cabas	P16	Cabas
PERC 10	P10	Clave	P10	Clave	P10	Clave	P10	Clave	P10	Clave
PERC 11	P14	MarcS	P14	MarcS	P14	MarcS	P14	MarcS	P14	MarcS
PERC 12	P19	AgogH	P19	AgogH	P19	AgogH	P19	AgogH	P19	AgogH
PERC 13	P20	AgogL	P20	AgogL	P20	AgogL	P20	AgogL	P20	AgogL
Bass	B01	Fing1	B01	Fing1	B02	Fing2	B09	Stick	B05	Pick1

Kit No. Kit Name	No. P16 Standrd1		No. P17 Express		No. P18 Vintage		No. P19 Fusion		No. P20 Funk 2	
	Inst. No.	Instrument	Inst. No.	Instrument	Inst. No.	Instrument	Inst. No.	Instrument	Inst. No.	Instrument
DRUM KICK	K04	Dry	K02	Rnd1	K01	Maple	K08	Stdio	K05	Comp
DRUM SNR1	S11	v Dry	S10	Dry	S04	v Maple	S04	v Maple	S16	Picco
DRUM SNR2	S29	Stck2	S26	Doubl	S28	Stck1	S26	Doubl	S28	Stck1
DRUM CHH	H01	PureC	H01	PureC	H01	PureC	H01	PureC	H09	RealC
DRUM OHH	H04	v PureO	H04	v PureO	H02	PureO	H04	v PureO	H11	v RealO
DRUM CYM1	C12	Bell2	C11	Bell1	C11	Bell1	C12	Bell2	C11	Bell1
DRUM CYM2	C10	Ride2	C10	Ride2	C09	Ride1	C10	Ride2	C09	Ride1
DRUM CYM3	C01	Crsh1	C01	Crsh1	C01	Crsh1	C01	Crsh1	C02	Crsh2
DRUM TOM1	T07	DbIH	T04	AmbiH	T01	VintH	T07	DbIH	T07	DbIH
DRUM TOM2	T08	DbIM	T05	AmbiM	T02	VintM	T08	DbIM	T08	DbIM
DRUM TOM3	T09	DbIL	T06	AmbiL	T03	VintL	T09	DbIL	T09	DbIL
DRUM CYM4	C02	Crsh2	C02	Crsh2	C02	Crsh2	C07	Splsh	C07	Splsh
DRUM CYM5	C08	China	C08	China	C08	China	C08	China	C08	China
PERC 1	P05	CngHM	P05	CngHM	P05	CngHM	P05	CngHM	P05	CngHM
PERC 2	P06	CngHO	P06	CngHO	P06	CngHO	P06	CngHO	P06	CngHO
PERC 3	P07	CngaL	P07	CngaL	P07	CngaL	P07	CngaL	P07	CngaL
PERC 4	P03	BngoH	P03	BngoH	P03	BngoH	P03	BngoH	P03	BngoH
PERC 5	P04	BngoL	P04	BngoL	P04	BngoL	P04	BngoL	P04	BngoL
PERC 6	P29	Clap2	P29	Clap2	P29	Clap2	P29	Clap2	P29	Clap2
PERC 7	P01	Cowbl	P01	Cowbl	P01	Cowbl	P01	Cowbl	P01	Cowbl
PERC 8	P02	Tmbrn	P02	Tmbrn	P02	Tmbrn	P02	Tmbrn	P02	Tmbrn
PERC 9	P16	Cabas	P16	Cabas	P16	Cabas	P16	Cabas	P16	Cabas
PERC 10	P10	Clave	P10	Clave	P10	Clave	P10	Clave	P10	Clave
PERC 11	P14	MarcS	P14	MarcS	P14	MarcS	P14	MarcS	P14	MarcS
PERC 12	P19	AgogH	P19	AgogH	P19	AgogH	P19	AgogH	P19	AgogH
PERC 13	P20	AgogL	P20	AgogL	P20	AgogL	P20	AgogL	P20	AgogL
Bass	B01	Fing1	B02	Fing2	B01	Fing1	B05	Pick1	B09	Stick

Kit No. Kit Name	No. P21 Electro		No. P22 Dance		No. P23 Hip Hop		No. P24 Techno		No. P25 Drm'n'Bs	
	Inst. No.	Instrument	Inst. No.	Instrument	Inst. No.	Instrument	Inst. No.	Instrument	Inst. No.	Instrument
DRUM KICK	K11	Elec	K12	TR909	K02	Rnd1	K12	TR909	K12	TR909
DRUM SNR1	S24	Elec	S25	TR808	S17	House	S17	House	S17	House
DRUM SNR2	S30	Stck3	S13	Natrl	S05	BchH	S30	Stck3	S25	TR808
DRUM CHH	H12	BrshC	H12	BrshC	H12	BrshC	H12	BrshC	H12	BrshC
DRUM OHH	H13	BrshO	H13	BrshO	H13	BrshO	H13	BrshO	H13	BrshO
DRUM CYM1	C11	Bell1	C12	Bell2	C12	Bell2	C11	Bell1	C12	Bell2
DRUM CYM2	C10	Ride2	C10	Ride2	C09	Ride1	C10	Ride2	C10	Ride2
DRUM CYM3	C01	Crsh1	C01	Crsh1	C03	Crsh3	C02	Crsh2	C02	Crsh2
DRUM TOM1	T16	ElecH	T19	TR H	T16	ElecH	T16	ElecH	T19	TR H
DRUM TOM2	T17	ElecM	T20	TR M	T17	ElecM	T17	ElecM	T20	TR M
DRUM TOM3	T18	ElecL	T21	TR L	T18	ElecL	T18	ElecL	T21	TR L
DRUM CYM4	C07	Splsh	C03	Crsh3	C02	Crsh2	C03	Crsh3	C03	Crsh3
DRUM CYM5	C08	China	C07	Splsh	C15	Gong	C07	Splsh	C07	Splsh
PERC 1	P27	Tbla3	P05	CngHM	P05	CngHM	P05	CngHM	P05	CngHM
PERC 2	P26	Tbla2	P06	CngHO	P06	CngHO	P06	CngHO	P06	CngHO
PERC 3	P25	Tbla1	P07	CngaL	P07	CngaL	P07	CngaL	P07	CngaL
PERC 4	P03	BngoH	P03	BngoH	P03	BngoH	P03	BngoH	P03	BngoH
PERC 5	P04	BngoL	P04	BngoL	P04	BngoL	P04	BngoL	P04	BngoL
PERC 6	P29	Clap2	P29	Clap2	P29	Clap2	P29	Clap2	P29	Clap2
PERC 7	P01	Cowbl	P01	Cowbl	P01	Cowbl	P01	Cowbl	P01	Cowbl
PERC 8	P02	Tmbrn	P02	Tmbrn	P02	Tmbrn	P02	Tmbrn	P02	Tmbrn
PERC 9	P16	Cabas	P16	Cabas	P16	Cabas	P16	Cabas	P16	Cabas
PERC 10	P10	Clave	P10	Clave	P10	Clave	P10	Clave	P10	Clave
PERC 11	P14	MarcS	P14	MarcS	P14	MarcS	P14	MarcS	P14	MarcS
PERC 12	P19	AgogH	P19	AgogH	P19	AgogH	P19	AgogH	P19	AgogH
PERC 13	P20	AgogL	P20	AgogL	P20	AgogL	P20	AgogL	P20	AgogL
Bass	B10	Solid	B12	Sine	B10	Solid	B11	Pluck	B12	Sine

Kit No. Kit Name	No. P26 House		No. P27 Boom		No. P28 Jazz 1		No. P29 Jazz 2		No. P30 Country	
	Inst. No.	Instrument	Inst. No.	Instrument	Inst. No.	Instrument	Inst. No.	Instrument	Inst. No.	Instrument
DRUM KICK	K12	TR909	K12	TR909	K10	Jazz	K10	Jazz	K01	Maple
DRUM SNR1	S25	TR808	S25	TR808	S06	BchS	S11	v Dry	S12	MdSft
DRUM SNR2	S30	Stck3	S30	Stck3	S29	Stck2	S28	Stck1	S29	Stck2
DRUM CHH	H12	BrshC	H12	BrshC	H01	PureC	H01	PureC	H09	RealC
DRUM OHH	H13	BrshO	H13	BrshO	H04	v PureO	H04	v PureO	H10	RealO
DRUM CYM1	C12	Bell2	C12	Bell2	C11	Bell1	C09	Ride1	C12	Bell2
DRUM CYM2	C10	Ride2	C10	Ride2	C10	Ride2	C10	Ride2	C10	Ride2
DRUM CYM3	C02	Crsh2	C02	Crsh2	C01	Crsh1	C01	Crsh1	C01	Crsh1
DRUM TOM1	T19	TR H	T19	TR H	T01	VintH	T01	VintH	T07	DbIH
DRUM TOM2	T20	TR M	T20	TR M	T02	VintM	T02	VintM	T08	DbIM
DRUM TOM3	T21	TR L	T21	TR L	T03	VintL	T03	VintL	T09	DbIL
DRUM CYM4	C03	Crsh3	C03	Crsh3	C02	Crsh2	C02	Crsh2	C02	Crsh2
DRUM CYM5	C07	Splsh	C07	Splsh	C03	Crsh3	C03	Crsh3	C08	China
PERC 1	P27	Tbla3	P05	CngHM	P05	CngHM	P05	CngHM	P05	CngHM
PERC 2	P26	Tbla2	P06	CngHO	P06	CngHO	P06	CngHO	P06	CngHO
PERC 3	P25	Tbla1	P07	CngaL	P07	CngaL	P07	CngaL	P07	CngaL
PERC 4	P03	BngoH	P03	BngoH	P03	BngoH	P03	BngoH	P03	BngoH
PERC 5	P04	BngoL	P04	BngoL	P04	BngoL	P04	BngoL	P04	BngoL
PERC 6	P28	Clap1	P29	Clap2	P28	Clap1	P28	Clap1	P28	Clap1
PERC 7	P01	Cowbl	P01	Cowbl	P01	Cowbl	P01	Cowbl	P01	Cowbl
PERC 8	P02	Tmbrn	P02	Tmbrn	P02	Tmbrn	P02	Tmbrn	P02	Tmbrn
PERC 9	P16	Cabas	P16	Cabas	P16	Cabas	P16	Cabas	P16	Cabas
PERC 10	P10	Clave	P10	Clave	P10	Clave	P10	Clave	P10	Clave
PERC 11	P14	MarcS	P14	MarcS	P14	MarcS	P14	MarcS	P14	MarcS
PERC 12	P19	AgogH	P19	AgogH	P19	AgogH	P19	AgogH	P19	AgogH
PERC 13	P20	AgogL	P20	AgogL	P20	AgogL	P20	AgogL	P20	AgogL
Bass	B10	Solid	B11	Pluck	B07	Acous	B07	Acous	B01	Fing1

Preset Kit List

Kit No. Kit Name	No. P31		No. P32		No. P33		No. P34		No. P35	
	Ballad 1		Folk		Brushes1		Ballad 2		Pops 1	
	Inst. No.	Instrument	Inst. No.	Instrument	Inst. No.	Instrument	Inst. No.	Instrument	Inst. No.	Instrument
DRUM KICK	K09	26"dp	K10	Jazz	K10	Jazz	K01	Maple	K01	Maple
DRUM SNR1	S12	MdSft	S20	BrshS	S21	v BrshS	S04	v Maple	S09	v Open
DRUM SNR2	S29	Stck2	S26	Doubl	S19	BrshR	S29	Stck2	S29	Stck2
DRUM CHH	H05	16"C	H01	PureC	H03	PureP	H01	PureC	H01	PureC
DRUM OHH	H08	v 16"O	H04	v PureO	H13	BrshO	H04	v PureO	H04	v PureO
DRUM CYM1	C11	Bell1	C12	Bell2	C11	Bell1	C11	Bell1	C12	Bell2
DRUM CYM2	C09	Ride1	C14	BrshR	C14	BrshR	C09	Ride1	C10	Ride2
DRUM CYM3	C01	Crsh1	C01	Crsh1	C13	BrshC	C01	Crsh1	C01	Crsh1
DRUM TOM1	T04	AmbiH	T01	VintH	T13	BrshH	T01	VintH	T07	DbIH
DRUM TOM2	T05	AmbiM	T02	VintM	T14	BrshM	T02	VintM	T08	DbIM
DRUM TOM3	T06	AmbiL	T03	VintL	T15	BrshL	T03	VintL	T09	DbIL
DRUM CYM4	C02	Crsh2	C13	BrshC	C02	Crsh2	C02	Crsh2	C02	Crsh2
DRUM CYM5	C07	Splsh	C07	Splsh	C03	Crsh3	C07	Splsh	C07	Splsh
PERC 1	P05	CngHM	P05	CngHM	P05	CngHM	P05	CngHM	P05	CngHM
PERC 2	P06	CngHO	P06	CngHO	P06	CngHO	P06	CngHO	P06	CngHO
PERC 3	P07	CngaL	P07	CngaL	P07	CngaL	P07	CngaL	P07	CngaL
PERC 4	P03	BngoH	P03	BngoH	P03	BngoH	P03	BngoH	P03	BngoH
PERC 5	P04	BngoL	P04	BngoL	P04	BngoL	P04	BngoL	P04	BngoL
PERC 6	P29	Clap2	P28	Clap1	P28	Clap1	P29	Clap2	P29	Clap2
PERC 7	P01	Cowbl	P01	Cowbl	P01	Cowbl	P01	Cowbl	P01	Cowbl
PERC 8	P02	Tmbrn	P02	Tmbrn	P02	Tmbrn	P02	Tmbrn	P02	Tmbrn
PERC 9	P16	Cabas	P16	Cabas	P16	Cabas	P16	Cabas	P16	Cabas
PERC 10	P10	Clave	P10	Clave	P10	Clave	P10	Clave	P10	Clave
PERC 11	P14	MarcS	P14	MarcS	P14	MarcS	P14	MarcS	P14	MarcS
PERC 12	P19	AgogH	P19	AgogH	P19	AgogH	P19	AgogH	P19	AgogH
PERC 13	P20	AgogL	P20	AgogL	P20	AgogL	P20	AgogL	P20	AgogL
Bass	B04	Frtls	B03	MuteB	B07	Acous	B04	Frtls	B01	Fing1

Kit No. Kit Name	No. P36		No. P37		No. P38		No. P39		No. P40	
	Punk		Pops 2		Standrd2		Natural2		Studio 2	
	Inst. No.	Instrument	Inst. No.	Instrument	Inst. No.	Instrument	Inst. No.	Instrument	Inst. No.	Instrument
DRUM KICK	K04	Dry	K04	Dry	K01	Maple	K04	Dry	K02	Rnd1
DRUM SNR1	S15	v Rock	S07	v Beech	S04	v Maple	S14	v Natrl	S09	v Open
DRUM SNR2	S26	Doubl	S28	Stck1	S26	Doubl	S28	Stck1	S26	Doubl
DRUM CHH	H09	RealC	H01	PureC	H01	PureC	H01	PureC	H05	16"C
DRUM OHH	H11	v RealO	H04	v PureO	H02	PureO	H04	v PureO	H08	v 16"O
DRUM CYM1	C12	Bell2	C12	Bell2	C11	Bell1	C11	Bell1	C12	Bell2
DRUM CYM2	C10	Ride2	C09	Ride1	C09	Ride1	C10	Ride2	C10	Ride2
DRUM CYM3	C01	Crsh1	C02	Crsh2	C01	Crsh1	C01	Crsh1	C01	Crsh1
DRUM TOM1	T04	AmbiH	T01	VintH	T07	DbIH	T04	AmbiH	T07	DbIH
DRUM TOM2	T05	AmbiM	T02	VintM	T08	DbIM	T05	AmbiM	T08	DbIM
DRUM TOM3	T06	AmbiL	T03	VintL	T09	DbIL	T06	AmbiL	T09	DbIL
DRUM CYM4	C02	Crsh2	C07	Splsh	C02	Crsh2	C02	Crsh2	C02	Crsh2
DRUM CYM5	C08	China	C08	China	C08	China	C07	Splsh	C08	China
PERC 1	P05	CngHM	P05	CngHM	P05	CngHM	P05	CngHM	P05	CngHM
PERC 2	P06	CngHO	P06	CngHO	P06	CngHO	P06	CngHO	P06	CngHO
PERC 3	P07	CngaL	P07	CngaL	P07	CngaL	P07	CngaL	P07	CngaL
PERC 4	P03	BngoH	P03	BngoH	P03	BngoH	P03	BngoH	P03	BngoH
PERC 5	P04	BngoL	P04	BngoL	P04	BngoL	P04	BngoL	P04	BngoL
PERC 6	P29	Clap2	P29	Clap2	P29	Clap2	P29	Clap2	P29	Clap2
PERC 7	P01	Cowbl	P01	Cowbl	P01	Cowbl	P01	Cowbl	P01	Cowbl
PERC 8	P02	Tmbrn	P02	Tmbrn	P02	Tmbrn	P02	Tmbrn	P02	Tmbrn
PERC 9	P16	Cabas	P16	Cabas	P16	Cabas	P16	Cabas	P16	Cabas
PERC 10	P10	Clave	P10	Clave	P10	Clave	P10	Clave	P10	Clave
PERC 11	P14	MarcS	P14	MarcS	P14	MarcS	P14	MarcS	P14	MarcS
PERC 12	P19	AgogH	P19	AgogH	P19	AgogH	P19	AgogH	P19	AgogH
PERC 13	P20	AgogL	P20	AgogL	P20	AgogL	P20	AgogL	P20	AgogL
Bass	B01	Fing1	B01	Fing1	B01	Fing1	B01	Fing1	B01	Fing1

Preset Kit List

Kit No. Kit Name	No. P41 Power 3		No. P42 Room 3		No. P43 Brushes2		No. P44 Latin		No. P45 Samba	
	Inst. No.	Instrument	Inst. No.	Instrument	Inst. No.	Instrument	Inst. No.	Instrument	Inst. No.	Instrument
DRUM KICK	K02	Rnd1	K06	Rev1	K10	Jazz	K04	Dry	K01	Maple
DRUM SNR1	S01	v Wet	S08	Open	S21	v BrshS	S11	v Dry	S06	BchS
DRUM SNR2	S26	Doubl	S28	Stck1	S19	BrshR	S29	Stck2	S29	Stck2
DRUM CHH	H09	RealC	H09	RealC	H03	PureP	H12	BrshC	P23	SurdM
DRUM OHH	H11	v RealO	H10	RealO	H13	BrshO	H13	BrshO	P24	SurdO
DRUM CYM1	C12	Bell2	C12	Bell2	C11	Bell1	C12	Bell2	C12	Bell2
DRUM CYM2	C10	Ride2	C10	Ride2	C14	BrshR	P21	CuicH	P21	CuicH
DRUM CYM3	C01	Crsh1	C01	Crsh1	C13	BrshC	P22	CuicL	P22	CuicL
DRUM TOM1	T04	AmbiH	T04	AmbiH	T13	BrshH	P08	TmbIH	P08	TmbIH
DRUM TOM2	T05	AmbiM	T05	AmbiM	T14	BrshM	P09	TmbIL	P09	TmbIL
DRUM TOM3	T06	AmbiL	T06	AmbiL	T15	BrshL	T09	DbIL	T09	DbIL
DRUM CYM4	C02	Crsh2	C03	Crsh3	C02	Crsh2	C10	Ride2	P17	WhsLS
DRUM CYM5	C08	China	C07	Splsh	C03	Crsh3	P11	Vibra	P18	WhsLL
PERC 1	P05	CngHM	P05	CngHM	P05	CngHM	P05	CngHM	P05	CngHM
PERC 2	P06	CngHO	P06	CngHO	P06	CngHO	P06	CngHO	P06	CngHO
PERC 3	P07	CngaL	P07	CngaL	P07	CngaL	P07	CngaL	P07	CngaL
PERC 4	P03	BngoH	P03	BngoH	P03	BngoH	P03	BngoH	P03	BngoH
PERC 5	P04	BngoL	P04	BngoL	P04	BngoL	P04	BngoL	P04	BngoL
PERC 6	P29	Clap2	P29	Clap2	P28	Clap1	P28	Clap1	P28	Clap1
PERC 7	P01	Cowbl	P01	Cowbl	P01	Cowbl	P01	Cowbl	P01	Cowbl
PERC 8	P02	Tmbrn	P02	Tmbrn	P02	Tmbrn	P02	Tmbrn	P02	Tmbrn
PERC 9	P16	Cabas	P16	Cabas	P16	Cabas	P16	Cabas	P16	Cabas
PERC 10	P10	Clave	P10	Clave	P10	Clave	P10	Clave	P10	Clave
PERC 11	P14	MarcS	P14	MarcS	P14	MarcS	P14	MarcS	P14	MarcS
PERC 12	P19	AgogH	P19	AgogH	P19	AgogH	P19	AgogH	P19	AgogH
PERC 13	P20	AgogL	P20	AgogL	P20	AgogL	P20	AgogL	P20	AgogL
Bass	B01	Fing1	B01	Fing1	B04	Frtls	B01	Fing1	B04	Frtls

Kit No. Kit Name	No. P46 Salsa		No. P47 Reggae		No. P48 India		No. P49 Afro 1		No. P50 Afro 2	
	Inst. No.	Instrument	Inst. No.	Instrument	Inst. No.	Instrument	Inst. No.	Instrument	Inst. No.	Instrument
DRUM KICK	K10	Jazz	K05	Comp	K01	Maple	K01	Maple	K05	Comp
DRUM SNR1	S16	Picco	S23	Regga	S13	NatrI	S13	NatrI	P09	TmbIL
DRUM SNR2	S29	Stck2	S29	Stck2	S29	Stck2	S29	Stck2	S29	Stck2
DRUM CHH	H12	BrshC	H01	PureC	H01	PureC	H05	16"C	H01	PureC
DRUM OHH	H13	BrshO	H02	PureO	H04 v	PureO	H08 v	16"O	H02	PureO
DRUM CYM1	C12	Bell2	C12	Bell2	C12	Bell2	C12	Bell2	C12	Bell2
DRUM CYM2	C10	Ride2	C10	Ride2	C10	Ride2	C10	Ride2	C10	Ride2
DRUM CYM3	C03	Crsh3	C07	Splsh	C01	Crsh1	C07	Splsh	C07	Splsh
DRUM TOM1	P08	TmbIH	P08	TmbIH	P25	Tbla1	P08	TmbIH	T07	DbIH
DRUM TOM2	P09	TmbIL	P09	TmbIL	P26	Tbla2	P09	TmbIL	T08	DbIM
DRUM TOM3	T09	DbIL	T03	VintL	P27	Tbla3	T05	AmbiM	T09	DbIL
DRUM CYM4	P15	Shakr	C03	Crsh3	C02	Crsh2	P13	GuirL	P24	SurdO
DRUM CYM5	P11	Vibra	P11	Vibra	C07	Splsh	P21	CuicH	P11	Vibra
PERC 1	P05	CngHM	P05	CngHM	P05	CngHM	P05	CngHM	P05	CngHM
PERC 2	P06	CngHO	P06	CngHO	P06	CngHO	P06	CngHO	P06	CngHO
PERC 3	P07	CngaL	P07	CngaL	P07	CngaL	P07	CngaL	P07	CngaL
PERC 4	P03	BngoH	P03	BngoH	P03	BngoH	P03	BngoH	P03	BngoH
PERC 5	P04	BngoL	P04	BngoL	P04	BngoL	P04	BngoL	P04	BngoL
PERC 6	P28	Clap1	P28	Clap1	P29	Clap2	P29	Clap2	P28	Clap1
PERC 7	P01	Cowbl	P01	Cowbl	P01	Cowbl	P01	Cowbl	P01	Cowbl
PERC 8	P02	Tmbrn	P02	Tmbrn	P02	Tmbrn	P02	Tmbrn	P02	Tmbrn
PERC 9	P16	Cabas	P16	Cabas	P16	Cabas	P16	Cabas	P16	Cabas
PERC 10	P10	Clave	P10	Clave	P10	Clave	P10	Clave	P10	Clave
PERC 11	P14	MarcS	P14	MarcS	P14	MarcS	P14	MarcS	P14	MarcS
PERC 12	P19	AgogH	P19	AgogH	P19	AgogH	P19	AgogH	P19	AgogH
PERC 13	P20	AgogL	P20	AgogL	P20	AgogL	P20	AgogL	P20	AgogL
Bass	B07	Acous	B03	MuteB	B07	Acous	B03	MuteB	B07	Acous

Preset Style List

No.	Style Name	No.	Style Name	No.	Style Name
P001	ROCK JAM 1	P041	16TH FEEL1	P081	BIG BAND
P002	ROCK JAM 2	P042	16TH FEEL2	P082	JAZZ WALTZ
P003	SHFFL JAM	P043	16TH FEEL3	P083	JAZZ FIVE
P004	ROCK HOP	P044	SHUFFLE	P084	DRM'N'BSS1
P005	STREET HOP	P045	BALLAD 1	P085	DRM'N'BSS2
P006	MIAMI	P046	BALLAD 2	P086	TECHNO 1
P007	FUNK ROCK	P047	BALLAD 3	P087	TECHNO 2
P008	HARD ROCK1	P048	BALLAD 4	P088	HOUSE 1
P009	HARD ROCK2	P049	COUNTRY 1	P089	HOUSE 2
P010	HARD ROCK3	P050	COUNTRY 2	P090	BOSSA JAM
P011	HARD ROCK4	P051	BLUE GRASS	P091	BOSSA NOVA
P012	HARD ROCK5	P052	BLUES 1	P092	SAMBA 1
P013	HARD ROCK6	P053	BLUES 2	P093	SAMBA 2
P014	HVY ROCK 1	P054	CHICAGO	P094	SAMBA 3
P015	HVY ROCK 2	P055	ROCK BLUES	P095	SALSA 1
P016	HVY ROCK 3	P056	LATIN ROCK	P096	SALSA 2
P017	FAST ROCK1	P057	FUNK 1	P097	LATIN JAM
P018	FAST ROCK2	P058	FUNK 2	P098	LATIN POP1
P019	FAST ROCK3	P059	FUNK 3	P099	LATIN POP2
P020	ROCK SWING	P060	FUNK 4	P100	REGGAE
P021	ROCK 1	P061	FUNK 5		
P022	ROCK 2	P062	FUNK 6		
P023	ROCK 3	P063	SOUL 1		
P024	ROCK 4	P064	SOUL 2		
P025	ROCK 5	P065	NEW R&B		
P026	ROCK 6	P066	HIP HOP 1		
P027	ROCK 7	P067	HIP HOP 2		
P028	ROCK 8	P068	HIP HOP 3		
P029	TRIBE ROCK	P069	FUSION 1		
P030	JELLY JAM	P070	FUSION 2		
P031	KNCKL HEAD	P071	FUSION 3		
P032	GROOVE CUT	P072	FUSION 4		
P033	AC ROCK	P073	GROOVE SIX		
P034	ELEC ROCK1	P074	HEAVY FUNK		
P035	ELEC ROCK2	P075	GOSPEL 1		
P036	SURF ROCK	P076	GOSPEL 2		
P037	8TH FEEL 1	P077	MED BLUES		
P038	8TH FEEL 2	P078	SWING 1		
P039	8TH FEEL 3	P079	SWING 2		
P040	8TH FEEL 4	P080	BRUSH		

1. RECOGNIZED RECEIVE DATA

■ Channel Voice Message

● Note Off

Status	Second	Third
8nH	kkH	vvH
9nH	kkH	00H

n = MIDI Channel Number: 0H–FH (ch.1–ch.16)

kk = Note Number: 00H–7FH (0–127)

vv = Velocity: 00H–7FH (0–127)

* Velocity value is not recognized.

* Not recognized in case that MIDI Channel value is “OFF” for each part.

● Note On

Status	Second	Third
9nH	kkH	vvH

n = MIDI Channel Number: 0H–FH (ch.1–ch.16)

kk = Note Number: 00H–7FH (0–127)

vv = Velocity: 01H–7FH (1–127)

* Not recognized in case that MIDI Channel value is “OFF” for each part.

* For drum part, note number of recognized data is as follows:

DRUM

Pad number	Note number
Pad 1	36 (24H) (C2)
Pad 2	38 (26H) (D2)
Pad 3	37 (25H) (C#2)
Pad 4	42 (2AH) (F#2)
Pad 5	46 (2EH) (A#2)
Pad 6	53 (35H) (F3)
Pad 7	51 (33H) (D#3)
Pad 8	49 (31H) (C#3)
Pad 9	48 (30H) (C3)
Pad 10	45 (2DH) (A2)
Pad 11	41 (29H) (F2)
Pad 12	57 (39H) (A3)
Pad 13	58 (3AH) (A#3)

PERC

Pad number	Note number
Pad 1	62 (3EH) (D4)
Pad 2	63 (3FH) (D#4)
Pad 3	64 (40H) (E4)
Pad 4	60 (3CH) (C4)
Pad 5	61 (3DH) (C#4)
Pad 6	39 (27H) (D#2)
Pad 7	56 (38H) (G#3)
Pad 8	54 (36H) (F#3)
Pad 9	69 (45H) (A4)
Pad 10	75 (4BH) (D#5)
Pad 11	70 (46H) (A#4)
Pad 12	67 (43H) (G4)
Pad 13	68 (44H) (G#4)

* For the bass part, the range of note numbers are 1CH–40H (28–64, E1–E4). Though the other note numbers can be received, they are sounded converting into the range of the note numbers E1–E4.

●Program Change

<u>Status</u>	<u>Second</u>
CnH	ppH

n = MIDI Channel Number: 0H–FH (ch.1–ch.16)
pp = Program Number: 00H–63H (prog.1–prog.100)

- * MIDI Channel Number is same as drum part channel.
- * Not recognized in case that drum part channel is “OFF”.
- * Recognizing Program Change message, DR-3 switches Drum Kit of the same number as Program Number. Consequently, bass tone changes as the Drum kit including.
The prog.1–50 correspond to the P01–P50, and the prog.51–100 correspond to the U01–U50.
- * After recognizing a Program Change message, new voices will sound as a switch, but sounding voices will not change then.

■System Common Message

●Song Position Pointer

<u>Status</u>	<u>Second</u>	<u>Third</u>
F2H	llH	mmH

mm, ll = Value: 00 00H–7F 7FH (0–16383)

- * Recognized under stop state of performances in Song Play mode or Style Play mode, and located the start position to play as a Value.

●Song Select

<u>Status</u>	<u>Second</u>
F3H	ssH

ss = Song Number: 00H–63H (1–100)

- * Recognized under stop state of performances in Song Play Mode, and switched song to play.

■System Real-time Message

●Timing Clock

<u>Status</u>
F8H

- * Recognition regards Sync Mode setting as follows:
Sync Mode: AUTO
Starting by receiving Start message (FAH) or Continue message (FBH), performances are synchronized to Timing Clock message (F8H).
Sync Mode: REMOTE
Not recognized.
Sync Mode: INT
Not recognized.

●Start

<u>Status</u>
FAH

●Continue

Status
FBH

●Stop

Status
FCH

●Active Sensing

Status
FEH

- * Once receiving Active Sensing message, DR-3 begins checking intervals of receiving messages. If an interval is over 500msec, DR-3 will stop sounding tones temporarily and not check intervals after this.

2. Messages stored in patterns**■Channel Voice Message****●Note Off**

<u>Status</u>	<u>Second</u>	<u>Third</u>
9nH	kkH	00H

n = MIDI Channel Number: 0H–FH (ch.1–ch.16)
kk = Note Number: 00H–7FH (0–127)

●Note On

<u>Status</u>	<u>Second</u>	<u>Third</u>
9nH	kkH	vvH

n = MIDI Channel Number: 0H–FH (ch.1–ch.16)
kk = Note Number: 00H–7FH (0–127)
vv = Velocity: 01H–7FH (1–127)

- * For drum part, note number of stored data is as follows:

DRUM

<u>Pad number</u>	<u>Note number</u>
Pad 1	36 (24H) (C2)
Pad 2	38 (26H) (D2)
Pad 3	37 (25H) (C#2)
Pad 4	42 (2AH) (F#2)
Pad 5	46 (2EH) (A#2)
Pad 6	53 (35H) (F3)
Pad 7	51 (33H) (D#3)
Pad 8	49 (31H) (C#3)
Pad 9	48 (30H) (C3)
Pad 10	45 (2DH) (A2)
Pad 11	41 (29H) (F2)
Pad 12	57 (39H) (A3)
Pad 13	58 (3AH) (A#3)

PERC

<u>Pad number</u>	<u>Note number</u>
Pad 1	62 (3EH) (D4)
Pad 2	63 (3FH) (D#4)
Pad 3	64 (40H) (E4)
Pad 4	60 (3CH) (C4)
Pad 5	61 (3DH) (C#4)
Pad 6	39 (27H) (D#2)
Pad 7	56 (38H) (G#3)
Pad 8	54 (36H) (F#3)
Pad 9	69 (45H) (A4)
Pad 10	75 (4BH) (D#5)
Pad 11	70 (46H) (A#4)
Pad 12	67 (43H) (G4)
Pad 13	68 (44H) (G#4)

- * All note numbers are stored in bass part.

Dr. Rhythm

Date: Dec. 27, 2002

Model DR-3

MIDI Implementation Chart

Version : 1.00

Function...	Transmitted	Recognized	Remarks
Basic Channel Changed	***** *****	1-16 1-16	Storable in Memory
Mode Default Messages Altered	***** X *****	Mode 3 X	
Note Number : True Voice	***** *****	0-127 28-64	
Velocity Note On Note Off	X X	O X	9n v=1-127
After Touch Key's Channel's	X X	X X	
Pitch Bend	X	X	
Control Change	X	X	

Program Change : True Number	X *****	O		1-100	
System Exclusive	X	X			
System : Song Position	X	O			
System : Song Select	X	O		0-99	
System Common : Tune Request	X	X			
System : Clock	X	O SYNC=AUTO			
Real Time : Commands	X	O SYNC=AUTO			
Aux : Local On/Off	X	X			
Aux : All Notes Off	X	X			
Messages : Active Sensing	X	O			
Messages : Reset	X	X			
Notes	* 1 Received when Sync Mode is AUTO and unit is functioning as slave				

O : Yes
X : No

Mode 1 : OMNI ON, POLY
Mode 2 : OMNI ON, MONO
Mode 3 : OMNI OFF, POLY
Mode 4 : OMNI OFF, MONO

Specifications

Styles

User Style: 100 styles

Preset Style: 100 styles

* 11 patterns for a style

Songs

User Song: 100

Song Length: Maximum 250 patterns for a song

TSC (Total Sound Control)

Sound Shape

Preset Patch: 8 patches

User Patch: 8 patches

Ambience

Preset Patch: 8 patches

User Patch: 8 patches

Max Polyphony

12 voices

Instrument

Drum and Perc: 120

Bass: 12

Resolution

96 per quarter note

Tempo

20–260 bpm

Recording Method

Realtime / Step

Pads

13 (Velocity-sensitive)

Display

Backlit LCD (16 Characters x 2 Lines)

Connectors

Output Jack: L, R (RCA phono type),

L (PHONES), R (MONO) (1/4 inch phone type)

Foot Switch Jack (Stereo 1/4 inch phone type)

MIDI IN Connector

DC IN (AC Adaptor Jack)

Power Supply

DC 9V: Dry Battery x 6, AC Adaptor (PSA series)

Power Consumption

200 mA

* *Expected battery life under continuous use:*

Alkaline: approx. 5 hours

This figures will vary depending on the actual conditions of use.

Dimensions

213 (W) x 185 (D) x 53 (H) mm

8-7/16 (W) x 7-5/16 (D) x 2-1/8 (H) inches

Weight

710 g / 1 lb 10 oz (excluding dry batteries)

Accessories

Alkaline Dry Battery (LR6 (AA) type) x 6

Owner's Manual

Roland Service (Information Sheet)

Options

AC Adaptor: PSA Series

Foot Switch: FS-5U

Foot Switch Cable: PCS-31 (Roland)

(1/4inch Phone Plug (stereo)–1/4inch Phone Plug (mono) x 2)

* *In the interest of product improvement, the specifications and/or appearance of this unit are subject to change without prior notice.*

Index

Buttons

[AMBIENCE]	52
[AUTO]	46
[INST]	58
[KEY SHIFT]	42
[MANU]	43
[SONG]	74
[SOUND SHAPE]	51
[TEMPO]	41

A

AMBIENCE	36
Ambience	33
Copying	57
Naming	57
Parameters	56
Auto Mode	34, 46

B

Bass Part	66, 68
Bass Sounds	59
Batteries	15
Beat	62
Block Loop	86

C

Clearing	
Patterns	73
Song	85
Style	72
Compressor	54
Connection	16
Foot Switch	29
MIDI Devices	93
COPY	82
Copying	
Kit	92
Patterns	72
Song	84
Style	71

D

DELETE	81
Demo	21
Drum Part	65, 67
Drum Sounds	59

E

Edit screen	38
Editing	
Notes	78
Songs	80
ENDING	35
Equalizer	53

F

Factory Reset	18
FILL	35
Foot Switch	29, 48

H

Headphones	16
------------------	----

I

Initial tempo	75
INSERT	80
Instruments	37
INTRO	35

K

Key Shift	28, 42
Key Transpose	70
Kit	90
Copying	92
Naming	91
Style	63
Kits	36

L

Loop Play	86
LP:OFF	86
LP:BLK	86
LP:ON	86

M

Manual Mode	34
Manual mode	43
Master	93
Metronome Volume	89
MIDI	93
MIDI Channels	94
MIDI Connector	93
Mute	45, 63

N		S	
Naming		Slave	93
Kit	91	Song	34, 74
Song	84	Changing the Tempo	83
Style	71	Clearing	85
Note Messages	96	Copying	84
O		Creating	74
OUTPUT Jack	89	Edit	80
P		Naming	84
Pad	58	Performing	85
Pad Functions	37	Playing Repeatedly (Loop Play)	87
Pad Sensitivity	89	Recording	76
Pan	91	Tempo	75
Pattern	44	TSC	76
Clearing	73	Song Chain	87
Copying	72	Song Edit screen	39
Measures	64	Song Mode	37
Recording	65	Song Recording screen	39
Substituting	78	Song screen	38
Pattern pads	23, 35, 44	Sound group	58
Pattern Progression	47	SOUND SHAPE	36
Patterns	35	Sound Shape	32
Pause	40	Copying	55
Percussion Sounds	59	Naming	55
Performing		Parameters	53
Songs	85	Step Recording	61, 67, 76
Polarity switch	29	Step Recording screen	38
Power	17	Style	22, 34
POWER switch	17	Beat	62
Preset Style	43	Clearing	72
Q		Copying	71
Quantize	66	Creating	61
R		Kit	63
Realtime Recording	61, 65, 77	Mute	63
Realtime Recording screen	39	Naming	71
Recording		Selecting	26, 43
Patterns	65	Starting/Stopping	44
Song	76	Tempo	62
Reference Pitch	89	TSC	64
		Style Play Mode	34
		Style screen	38
		Sync Mode	95
		Synchronizing	93
		System	88

T

Tempo	27, 36, 41
Song	75
Style	62
TSC	32, 36, 51
Song	76
Style	64

U

User kits	90
-----------------	----

V

VARIATION	24, 45
Variation	36
VARIATION [KIT]	45, 60
VARIATION [MUTE]	45
VARIATION [PTN]	45
Velocity Edit	69
Velocity Edit screen	39
VERSE	35
Volume	
Instrument sound	91

Memo ...



This product complies with the requirements of European Directive 89/336/EEC.

For EU Countries

FEDERAL COMMUNICATIONS COMMISSION RADIO FREQUENCY INTERFERENCE STATEMENT

For the USA

This equipment has been tested and found to comply with the limits for a Class B digital device, pursuant to Part 15 of the FCC Rules. These limits are designed to provide reasonable protection against harmful interference in a residential installation. This equipment generates, uses, and can radiate radio frequency energy and, if not installed and used in accordance with the instructions, may cause harmful interference to radio communications. However, there is no guarantee that interference will not occur in a particular installation. If this equipment does cause harmful interference to radio or television reception, which can be determined by turning the equipment off and on, the user is encouraged to try to correct the interference by one or more of the following measures:

- Reorient or relocate the receiving antenna.
- Increase the separation between the equipment and receiver.
- Connect the equipment into an outlet on a circuit different from that to which the receiver is connected.
- Consult the dealer or an experienced radio/TV technician for help.

This device complies with Part 15 of the FCC Rules. Operation is subject to the following two conditions:

- (1) This device may not cause harmful interference, and
- (2) This device must accept any interference received, including interference that may cause undesired operation.

Unauthorized changes or modification to this system can void the users authority to operate this equipment.
This equipment requires shielded interface cables in order to meet FCC class B Limit.

For Canada

NOTICE

This Class B digital apparatus meets all requirements of the Canadian Interference-Causing Equipment Regulations.

AVIS

Cet appareil numérique de la classe B respecte toutes les exigences du Règlement sur le matériel brouilleur du Canada.

