

Roland®

DIGITAL STEREO MICRO MONITOR

DM-10



Owner's Manual Bedienungsanleitung Mode d'emploi Manuale d'uso Manual del usuario

Before using this unit, carefully read the sections entitled: "IMPORTANT SAFETY INSTRUCTIONS" (p. 2), "USING THE UNIT SAFELY" (pp. 3-4), and "IMPORTANT NOTES" (p. 5). These sections provide important information concerning the proper operation of the unit. Additionally, in order to feel assured that you have gained a good grasp of every feature provided by your new unit, Owner's manual should be read in its entirety. The manual should be saved and kept on hand as a convenient reference.



Copyright © 2004 ROLAND CORPORATION

All rights reserved. No part of this publication may be reproduced in any form without the written permission of ROLAND CORPORATION.

	CAUTION RISK OF ELECTRIC SHOCK DO NOT OPEN	
ATTENTION: RISQUE DE CHOC ELECTRIQUE NE PAS OUVRIR		
CAUTION: TO REDUCE THE RISK OF ELECTRIC SHOCK, DO NOT REMOVE COVER (OR BACK). NO USER-SERVICEABLE PARTS INSIDE. REFER SERVICING TO QUALIFIED SERVICE PERSONNEL.		



The lightning flash with arrowhead symbol, within an equilateral triangle, is intended to alert the user to the presence of uninsulated "dangerous voltage" within the product's enclosure that may be of sufficient magnitude to constitute a risk of electric shock to persons.



The exclamation point within an equilateral triangle is intended to alert the user to the presence of important operating and maintenance (servicing) instructions in the literature accompanying the product.

INSTRUCTIONS PERTAINING TO A RISK OF FIRE, ELECTRIC SHOCK, OR INJURY TO PERSONS.

IMPORTANT SAFETY INSTRUCTIONS SAVE THESE INSTRUCTIONS

WARNING - When using electric products, basic precautions should always be followed, including the following:

1. Read these instructions.
2. Keep these instructions.
3. Heed all warnings.
4. Follow all instructions.
5. Do not use this apparatus near water.
6. Clean only with a dry cloth.
7. Do not block any of the ventilation openings. Install in accordance with the manufacturers instructions.
8. Do not install near any heat sources such as radiators, heat registers, stoves, or other apparatus (including amplifiers) that produce heat.
9. Do not defeat the safety purpose of the polarized or grounding-type plug. A polarized plug has two blades with one wider than the other. A grounding type plug has two blades and a third grounding prong. The wide blade or the third prong are provided for your safety. When the provided plug does not fit into your outlet, consult an electrician for replacement of the obsolete outlet.
10. Protect the power cord from being walked on or pinched particularly at plugs, convenience receptacles, and the point where they exit from the apparatus.
11. Only use attachments/accessories specified by the manufacturer.
12. Never use with a cart, stand, tripod, bracket, or table except as specified by the manufacturer, or sold with the apparatus. When a cart is used, use caution when moving the cart/apparatus combination to avoid injury from tip-over.
13. Unplug this apparatus during lightning storms or when unused for long periods of time.
14. Refer all servicing to qualified service personnel. Servicing is required when the apparatus has been damaged in any way, such as power-supply cord or plug is damaged, liquid has been spilled or objects have fallen into the apparatus, the apparatus has been exposed to rain or moisture, does not operate normally, or has been dropped.



For the U.K.

IMPORTANT: THE WIRES IN THIS MAINS LEAD ARE COLOURED IN ACCORDANCE WITH THE FOLLOWING CODE.



BLUE: NEUTRAL
BROWN: LIVE

As the colours of the wires in the mains lead of this apparatus may not correspond with the coloured markings identifying the terminals in your plug, proceed as follows:
The wire which is coloured BLUE must be connected to the terminal which is marked with the letter N or coloured BLACK.
The wire which is coloured BROWN must be connected to the terminal which is marked with the letter L or coloured RED.
Under no circumstances must either of the above wires be connected to the earth terminal of a three pin plug.



USING THE UNIT SAFELY

INSTRUCTIONS FOR THE PREVENTION OF FIRE, ELECTRIC SHOCK, OR INJURY TO PERSONS

About ⚠ WARNING and ⚠ CAUTION Notices







 WARNING	Used for instructions intended to alert the user to the risk of death or severe injury should the unit be used improperly.
 CAUTION	Used for instructions intended to alert the user to the risk of injury or material damage should the unit be used improperly. * Material damage refers to damage or other adverse effects caused with respect to the home and all its furnishings, as well to domestic animals or pets.

About the Symbols







	The ⚠ symbol alerts the user to important instructions or warnings. The specific meaning of the symbol is determined by the design contained within the triangle. In the case of the symbol at left, it is used for general cautions, warnings, or alerts to danger.
	The ⊘ symbol alerts the user to items that must never be carried out (are forbidden). The specific thing that must not be done is indicated by the design contained within the circle. In the case of the symbol at left, it means that the unit must never be disassembled.
	The ● symbol alerts the user to things that must be carried out. The specific thing that must be done is indicated by the design contained within the circle. In the case of the symbol at left, it means that the power-cord plug must be unplugged from the outlet.

ALWAYS OBSERVE THE FOLLOWING

⚠ WARNING

- Before using this unit, make sure to read the instructions below, and the Owner's Manual. 
- Do not open or perform any internal modifications on the unit. 
- Do not attempt to repair the unit, or replace parts within it (except when this manual provides specific instructions directing you to do so). Refer all servicing to your retailer, the nearest Roland Service Center, or an authorized Roland distributor, as listed on the "Information" page. 
- Never use or store the unit in places that are:
 - Subject to temperature extremes (e.g., direct sunlight in an enclosed vehicle, near a heating duct, on top of heat-generating equipment); or are 
 - Damp (e.g., baths, washrooms, on wet floors); or are 
 - Humid; or are
 - Exposed to rain; or are
 - Dusty; or are
 - Subject to high levels of vibration.
- Make sure you always have the unit placed so it is level and sure to remain stable. Never place it on stands that could wobble, or on inclined surfaces. 
- The unit should be connected to a power supply only of the type described in the operating instructions, or as marked on the rear side of unit. 

⚠ WARNING

- Use only the attached power-supply cord. Also, the supplied power cord must not be used with any other device. 
- Do not excessively twist or bend the power cord, nor place heavy objects on it. Doing so can damage the cord, producing severed elements and short circuits. Damaged cords are fire and shock hazards! 
- This unit, either alone or in combination with an amplifier and headphones or speakers, may be capable of producing sound levels that could cause permanent hearing loss. Do not operate for a long period of time at a high volume level, or at a level that is uncomfortable. If you experience any hearing loss or ringing in the ears, you should immediately stop using the unit, and consult an audiologist. 
- Do not allow any objects (e.g., flammable material, coins, pins); or liquids of any kind (water, soft drinks, etc.) to penetrate the unit. 

- Immediately turn the power off, remove the power cord from the outlet, and request servicing by your retailer, the nearest Roland Service Center, or an authorized Roland distributor, as listed on the "Information" page when:
 - The power-supply cord, or the plug has been damaged; or
 - If smoke or unusual odor occurs
 - Objects have fallen into, or liquid has been spilled onto the unit; or
 - The unit has been exposed to rain (or otherwise has become wet); or
 - The unit does not appear to operate normally or exhibits a marked change in performance.

⚠ WARNING

- In households with small children, an adult should provide supervision until the child is capable of following all the rules essential for the safe operation of the unit. 

- Protect the unit from strong impact. (Do not drop it!) 

- Do not force the unit's power-supply cord to share an outlet with an unreasonable number of other devices. Be especially careful when using extension cords—the total power used by all devices you have connected to the extension cord's outlet must never exceed the power rating (watts/amperes) for the extension cord. Excessive loads can cause the insulation on the cord to heat up and eventually melt through. 

- Before using the unit in a foreign country, consult with your retailer, the nearest Roland Service Center, or an authorized Roland distributor, as listed on the "Information" page. 

- Do not put anything that contains water (e.g., flower vases) on this unit. Also, avoid the use of insecticides, perfumes, alcohol, nail polish, spray cans, etc., near the unit. Swiftly wipe away any liquid that spills on the unit using a dry, soft cloth. 

⚠ CAUTION

- The unit should be located so that its location or position does not interfere with its proper ventilation. 

- Always grasp only the plug on the power-supply cord when plugging into, or unplugging from, an outlet or this unit. 

- At regular intervals, you should unplug the power plug and clean it by using a dry cloth to wipe all dust and other accumulations away from its prongs. Also, disconnect the power plug from the power outlet whenever the unit is to remain unused for an extended period of time. Any accumulation of dust between the power plug and the power outlet can result in poor insulation and lead to fire. 

- Try to prevent cords and cables from becoming entangled. Also, all cords and cables should be placed so they are out of the reach of children. 

- Never climb on top of, nor place heavy objects on the unit. 

- Never handle the power cord or its plugs with wet hands when plugging into, or unplugging from, an outlet or this unit. 

- Before moving the unit, disconnect the power plug from the outlet, and pull out all cords from external devices. 

- Before cleaning the unit, turn off the power and unplug the power cord from the outlet. 

- Whenever you suspect the possibility of lightning in your area, pull the plug on the power cord out of the outlet. 

IMPORTANT NOTES

In addition to the items listed under “IMPORTANT SAFETY INSTRUCTIONS” and “USING THE UNIT SAFELY” on pages 2–4, please read and observe the following:

Power Supply

- Do not connect this unit to same electrical outlet that is being used by an electrical appliance that is controlled by an inverter (such as a refrigerator, washing machine, microwave oven, or air conditioner), or that contains a motor. Depending on the way in which the electrical appliance is used, power supply noise may cause this unit to malfunction or may produce audible noise. If it is not practical to use a separate electrical outlet, connect a power supply noise filter between this unit and the electrical outlet.
- Before connecting this unit to other devices, turn off the power to all units. This will help prevent malfunctions and/or damage to speakers or other devices.
- Although the LCD and LEDs are switched off when the POWER switch is switched off, this does not mean that the unit has been completely disconnected from the source of power. If you need to turn off the power completely, first turn off the POWER switch, then unplug the power cord from the power outlet. For this reason, the outlet into which you choose to connect the power cord’s plug should be one that is within easy reach.

Placement

- Using the unit near power amplifiers (or other equipment containing large power transformers) may induce hum. To alleviate the problem, change the orientation of this unit; or move it farther away from the source of interference.
- This device may interfere with radio and television reception. Do not use this device in the vicinity of such receivers.
- Noise may be produced if wireless communications devices, such as cell phones, are operated in the vicinity of this unit. Such noise could occur when receiving or initiating a call, or while conversing. Should you experience such problems, you should relocate such wireless devices so they are at a greater distance from this unit, or switch them off.
- Do not expose the unit to direct sunlight, place it near devices that radiate heat, leave it inside an enclosed vehicle, or otherwise subject it to temperature extremes. Also, do not allow lighting devices that normally are used while their light source is very close to the unit (such as a piano light), or powerful spotlights to shine upon the same area of the unit for extended periods of time. Excessive heat can deform or discolor the unit.
- When moved from one location to another where the temperature and/or humidity is very different, water droplets (condensation) may form inside the unit. Damage or malfunction may result if you attempt to use the unit in this condition. Therefore, before using the unit, you must allow it to stand for several hours, until the condensation has completely evaporated.
- Do not allow rubber, vinyl, or similar materials to remain on the unit for long periods of time. Such objects can discolor or otherwise harmfully affect the finish.
- Do not paste stickers, decals, or the like to this instrument. Peeling such matter off the instrument may damage the exterior finish.
- Do not allow objects to remain on top of the unit while it is in operation. Placing heavy objects on this unit may result in injury if it overturns or falls.

Maintenance

- To clean the unit, use a dry, soft cloth; or one that is slightly dampened. Try to wipe the entire surface using an equal amount of strength, moving the cloth along with the grain of the wood. Rubbing too hard in the same area can damage the finish.
- Never use benzine, thinners, alcohol or solvents of any kind, to avoid the possibility of discoloration and/or deformation.

Additional Precautions

- Use a reasonable amount of care when using the unit’s buttons, sliders, or other controls; and when using its jacks and connectors. Rough handling can lead to malfunctions.
- When connecting / disconnecting all cables, grasp the connector itself—never pull on the cable. This way you will avoid causing shorts, or damage to the cable’s internal elements.
- A small amount of heat will radiate from the unit during normal operation.
- To avoid disturbing your neighbors, try to keep the unit’s volume at reasonable levels. You may prefer to use headphones, so you do not need to be concerned about those around you (especially when it is late at night).
- When you need to transport the unit, package it in the box (including padding) that it came in, if possible. Otherwise, you will need to use equivalent packaging materials.
- Use a cable from Roland to make the connection. If using some other make of connection cable, please note the following precautions.
 - Some connection cables contain resistors. Do not use cables that incorporate resistors for connecting to this unit. The use of such cables can cause the sound level to be extremely low, or impossible to hear. For information on cable specifications, contact the manufacturer of the cable.
- Be sure to avoid inserting your fingers in the bass reflex ports when transporting or moving the speakers, as your fingers may become wedged and stuck in the ports.

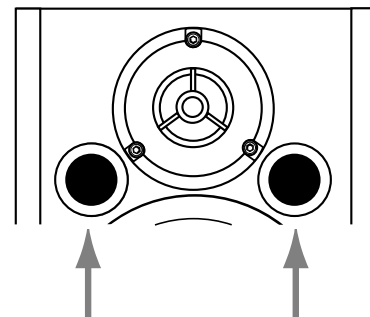

Panel Description

Left Channel

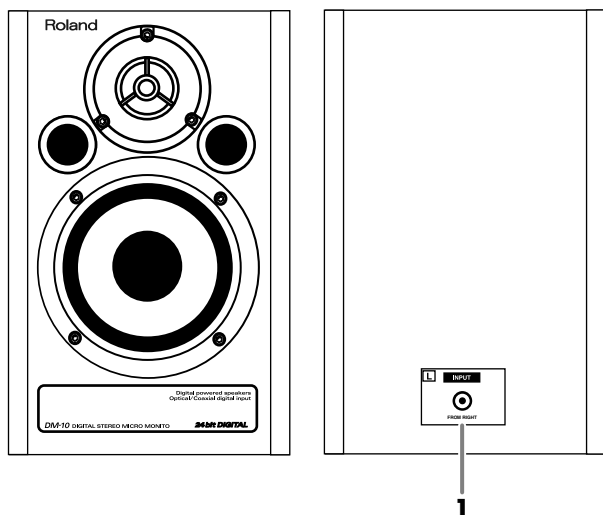

1. L Channel Input Jack

Connect this to L Channel Output Jack **14** on the right-side unit. For the connection, use the included speaker cable.

2. POWER Switch, POWER/STANDBY Indicator

The POWER/STANDBY Indicator lights up in red during standby, and lights up in green when power is on.

3. PHONES Jack

When you connect headphones to this jack, no sound will be heard from the speakers.

4. BASS Control Knob

5. TREBLE Control Knob

These adjust the tones of the bass and treble. Set to center to make the tones flat.

6. VOLUME Knob (DIGITAL/LINE 1)

This adjusts the volume of devices connected to digital input connectors **8**, **9**, **11**, and LINE 1 Input Jack **12**.

7. VOLUME Knob (LINE 2)

This adjusts the volume of the device connected to LINE 2 Input Jacks **13**.

8. Digital Input Connector (Optical)

This is the digital input connector for optic-fiber cable.

* When you connect a cable to this connector, the sound of devices connected to digital input connector **9** or **11** will not be heard.

Right Channel

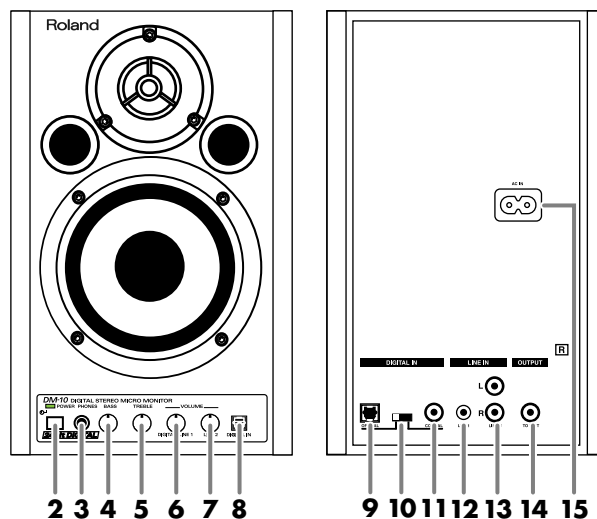

9. Digital Input Connector (Optical)

This is the digital input connector for optic-fiber cable.

10. Digital Input Select Switch

This switch selects digital input connector **9** or **11** on the rear panel. Select the connector used for the input signal.

* When you connect a cable to digital input connector **8** on the front panel, the sound of the device connected to **8** will be heard independently of this switch.

11. Digital Input Connector (Coaxial)

This is the digital input connector for coaxial cable.

12. LINE 1 Input Jack (stereo mini type)

13. LINE 2 Input Jacks (L, R) (RCA pin type)

14. L Channel Output Jack

Connect this to L Channel Input Jack **1** on the left-side unit.

15. AC Inlet

Connect the included Power cord here (p. 17). Plug it firmly in, so that the cable does not accidentally become disconnected.

Connections

Attaching the Rubber Feet (Included)

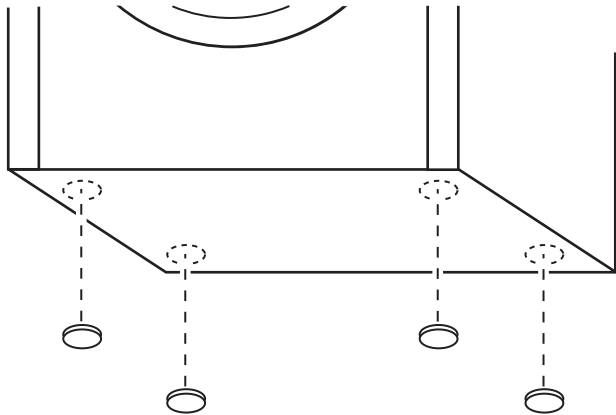

Precautions When Connecting and Turning on the Power

- To prevent malfunction and/or damage to speakers or other devices, always turn down the volume, and turn off the power on all devices before making any connections.
- When connection cables with resistors are used, the volume level of equipment connected to the inputs (Input Jacks) may be low. If this happens, use connection cables that do not contain resistors, such as those from the Roland PCS series.
- Once the connections have been completed, turn on power to your various devices in the order specified. By turning on devices in the wrong order, you risk causing malfunction and/or damage to speakers and other devices. (When turning the power off, reverse this procedure.)
< Connected devices → DM-10 >
- This unit is equipped with a protection circuit. A brief interval (a few seconds) after power up is required before the unit will operate normally.

Connection Example

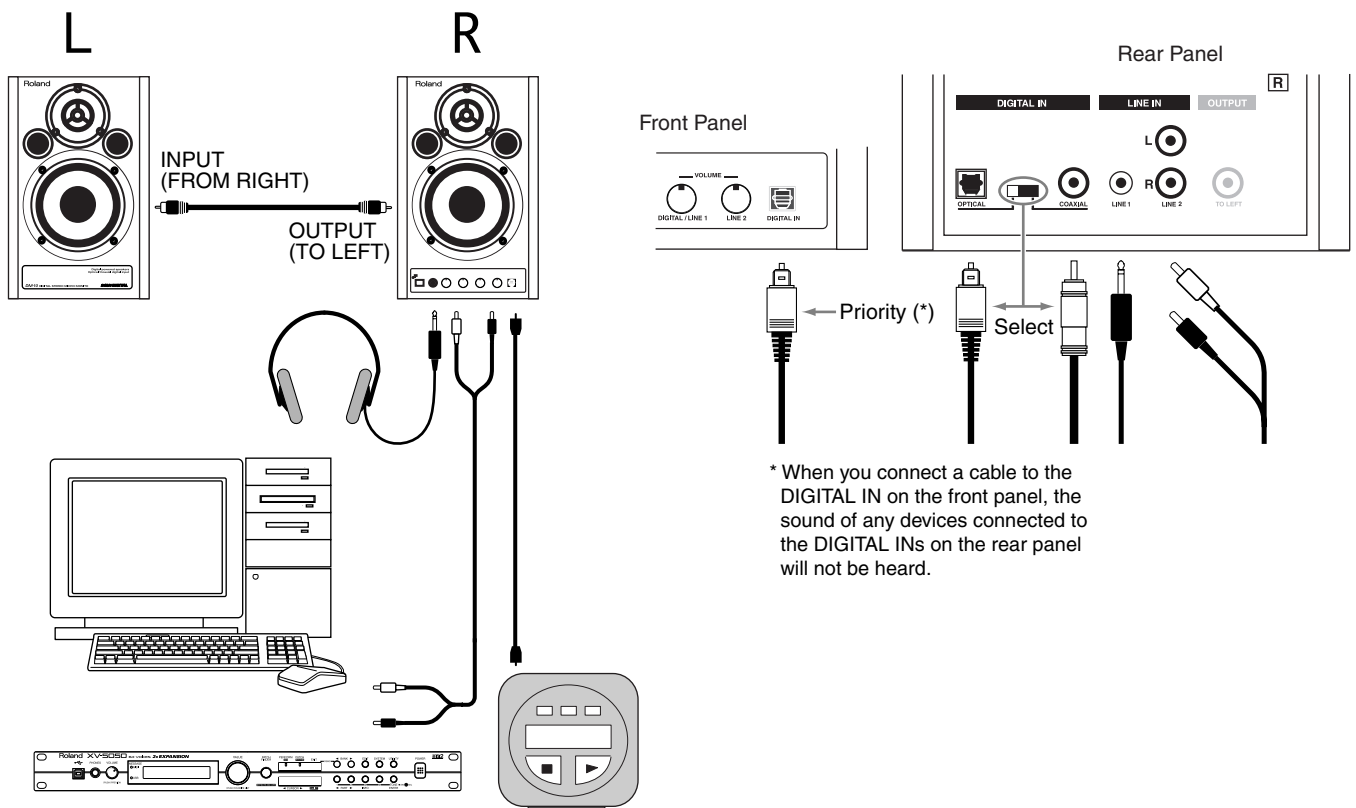

Sound Module, CD Player, MD Player, etc.

* When you connect a cable to the DIGITAL IN on the front panel, the sound of any devices connected to the DIGITAL INs on the rear panel will not be heard.

Bedienfeldbeschreibung

Linker Kanal

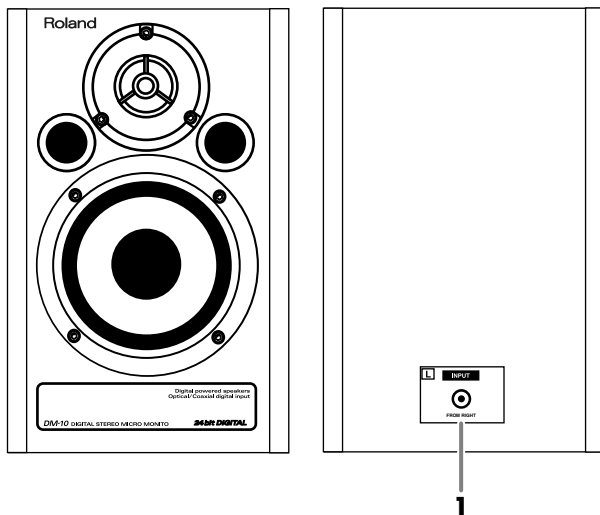

Rechter Kanal

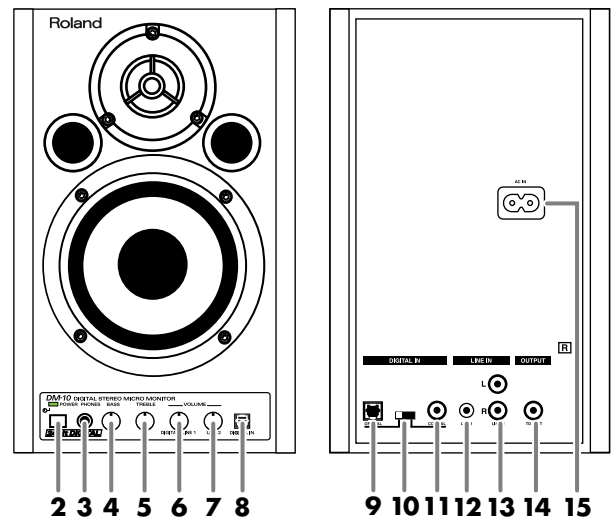

1. L-Kanal-Eingangsbuchse

Verbinden Sie diese Buchse mit der L-Kanal-Ausgangsbuchse **14** der Einheit auf der rechten Seite. Verwenden Sie für den Anschluss das beiliegende Lautsprecherkabel.

2. POWER-Schalter, POWER/STANDBY-Anzeige

Die POWER/STANDBY-Anzeige leuchtet im Standby-Betrieb rot. Im Netzbetrieb leuchtet diese Anzeige grün.

3. PHONES-Buchse

Wenn Sie an diese Buchse Kopfhörer anschließen, hören Sie keinen Sound aus den Lautsprechern.

4. BASS-Drehknopf

5. TREBLE-Drehknopf

Mit diesen Bedienelementen werden Bass und Treble reguliert. Drehen Sie die Drehknöpfe bis zur Mitte, um einen tiefen Ton zu erzeugen.

6. VOLUME-Schaltknopf (DIGITAL/LINE 1)

Dieser Schaltknopf passt die Lautstärke der Geräte an, die mit den Digitaleingabe-Anschlüssen **8, 9, 11**, sowie mit LINE 1-Eingangsbuchse **12** verbunden sind.

7. VOLUME-Schaltknopf (LINE 2)

Stellt die Lautstärke der Geräte ein, die an den LINE 2-Eingangsbuchsen **13** angeschlossen sind.

8. Anschluss Digitaleingabe (optisch)

Dies ist der Digitaleingabe-Anschluss für faseroptische Kabel.

* Wenn Sie mit diesem Anschluss ein Kabel verbinden, hören Sie aus den Geräten, die an den Digitaleingabe-Anschluss **9** oder **11** angeschlossen sind, keinen Sound.

9. Anschluss Digitaleingabe (optisch)

Dies ist der Digitaleingabe-Anschluss für faseroptische Kabel.

10. Digitaleingabe-Auswahlschalter

Dieser Schalter wählt den Digitaleingabe-Anschluss **9** oder **11** auf der Rückseite aus. Wählen Sie den Anschluss, der für das Input-Signal verwendet wird.

* Wenn Sie ein Kabel mit dem Digitaleingabe-Anschluss **8** auf der Vorderseite verbinden, hören Sie den Sound des Geräts, das mit **8** verbunden ist, unabhängig von diesem Schalter.

11. Anschluss Digitaleingabe (koaxial)

Dies ist der Digitaleingabe-Anschluss für Koaxialkabel.

12. LINE 1-Eingangsbuchse (Stereo Mini)

13. LINE 2-Eingangsbuchsen (L, R) (RCA-Stift)

14. L-Kanal-Ausgangsbuchse

Verbinden Sie diese Buchse mit der L-Kanal-Eingangsbuchse **1** der Einheit auf der linken Seite.

15. AC-Einlass

Schließen Sie hier das beiliegende Netzkabel an (s. 17). Stecken Sie das Kabel fest ein, damit es nicht versehentlich vom Anschluss getrennt werden kann.

Anschlüsse

Anschliessen der Gummibeine (in der Packung)

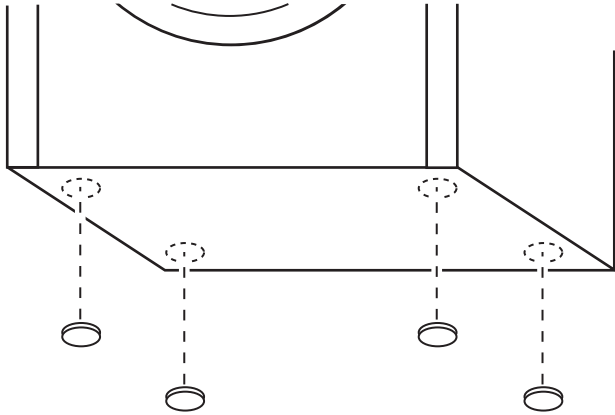

Vorsichtsmaßnahmen beim Anschließen des Netzkabels und beim Einschalten

- Um Fehlfunktionen und/oder Schäden an Lautsprechern oder anderen Geräten zu verhindern, reduzieren Sie stets die Lautstärke und schalten alle Geräte ab, bevor Sie die Verbindungen einrichten.
- Die Verwendung von Anschlusskabeln mit Widerstand kann der Grund für eine zu geringe Lautstärke sein. Verwenden Sie ein Anschlusskabel, das keinen Widerstand enthält.
- Nachdem die Anschlüsse fertig gestellt wurden, schalten Sie die verschiedenen Geräte in der angegebenen Reihenfolge ein. Wenn Sie die Geräte in der falschen Reihenfolge einschalten, besteht die Gefahr von Fehlfunktionen und/oder Schäden an Lautsprechern und anderen Geräten. (Gehen Sie beim Ausschalten der Geräte in der umgekehrten Reihenfolge vor).
< Angeschlossene Geräte → DM-10 >
- Vergewissern Sie sich stets, dass die Lautstärke reduziert wurde, bevor Sie das Gerät einschalten. Beim Einschalten wird eventuell auch dann Sound ausgegeben, wenn der Lautstärkeregler ganz zurückgestellt wurde. Das ist jedoch normal und kein Anzeichen für eine Fehlfunktion.

Anschluss-Beispiel

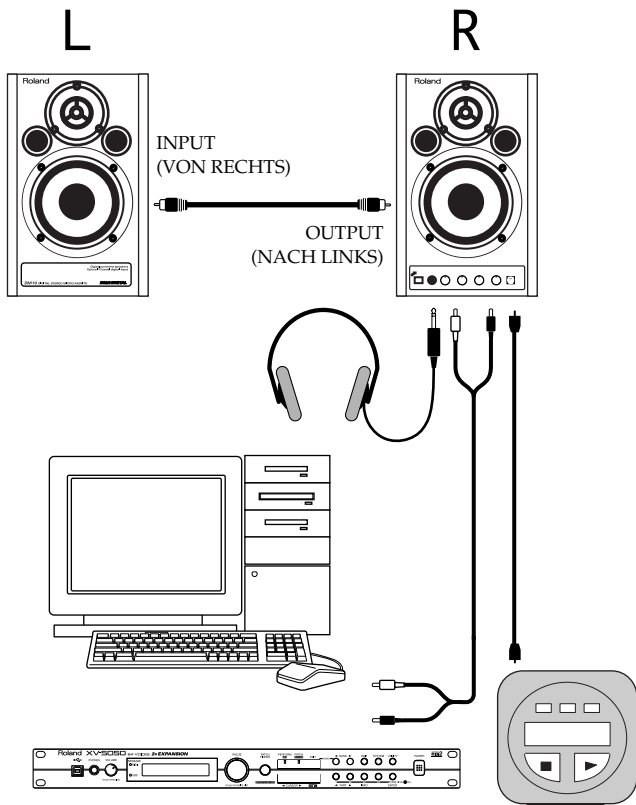

Soundmodul, CD-Player, MD-Gerät, etc.

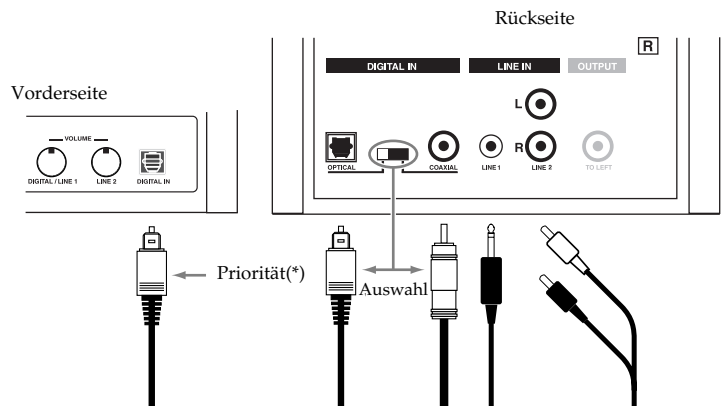

* Wenn Sie ein Kabel mit DIGITAL IN auf der Vorderseite verbinden, ist der Klang aller Geräte, die an DIGITAL IN-Anschlüsse auf der Rückseite angeschlossen sind nicht wahrnehmbar.

Description

Canal gauche

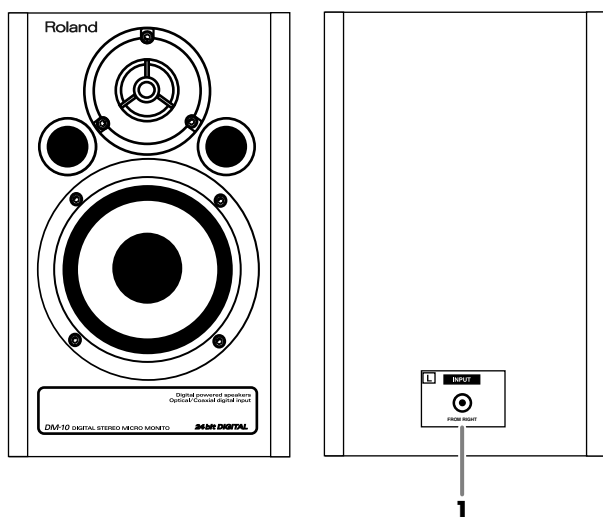

1. Prise d'entrée canal L (G)

Connectez à la prise de sortie du canal L **14** sur la droite de l'appareil. Pour la connexion, utilisez le câble pour enceintes inclus.

2. Commutateur POWER, voyant POWER/STANDBY

Le voyant POWER/STANDBY est rouge en mode veille, et vert lorsque l'appareil est alimenté.

3. Prise PHONES (casque)

Si vous reliez un casque à cette prise, le son ne passera plus sur les enceintes.

4. Bouton BASS

5. Bouton TREBLE

Ils servent à régler les basses et les aigus. Pour obtenir un réglage neutre, mettre les boutons en position médiane.

6. Bouton VOLUME (DIGITAL/LINE 1)

Il sert à régler le volume des appareils reliés aux connecteurs d'entrée numérique **8, 9, 11**, ainsi qu'à la prise d'entrée LINE 1 **12**.

7. Bouton VOLUME (LINE 2)

Ce bouton ajuste le volume de l'appareil connecté aux prises d'entrée LINE 2 **13**.

8. Connecteur d'entrée numérique (optique)

C'est le connecteur d'entrée numérique pour câble en fibre optique.

* Si vous reliez un câble à ce connecteur, le son des appareils reliés au connecteur d'entrée numérique **9** ou **11** sera désactivé.

Canal droit

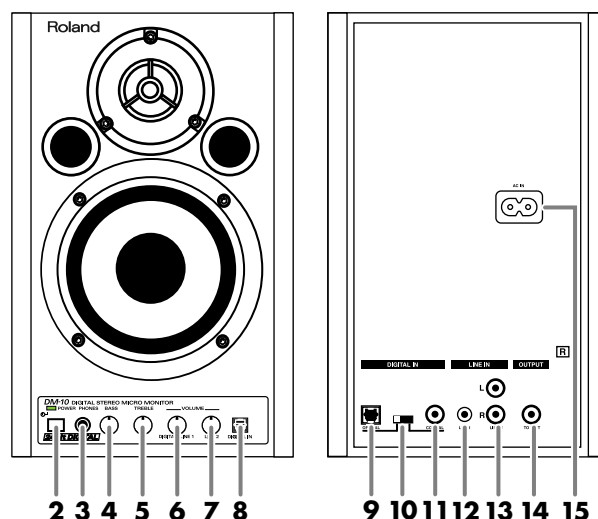

9. Connecteur d'entrée numérique (optique)

Connecteur d'entrée numérique pour câble en fibre optique.

10. Commutateur Entrée numérique

Ce commutateur sert à sélectionner le connecteur d'entrée numérique **9** ou **11** sur la face arrière. Sélectionnez le connecteur utilisé pour le signal d'entrée.

* Si vous reliez un câble au connecteur d'entrée numérique **8** sur la face avant, le son de l'appareil relié à **8** sera audible, indépendamment de ce commutateur.

11. Connecteur d'entrée numérique (coaxial)

C'est le connecteur d'entrée numérique pour câble coaxial.

12. Prise d'entrée LINE 1 (type mini-stéréo)

13. Prises d'entrée LINE 2 (L, R) (type RCA)

14. Prise de sortie canal L (G)

Connectez à la prise de sortie du canal L **1** sur la gauche de l'appareil.

15. Connecteur AC IN

Branchez ici le cordon d'alimentation (p. 17). Enfichez-le fermement, pour éviter que le cordon ne soit déconnecté par accident.

Connexions

Fixer les pieds en caoutchouc (inclus)

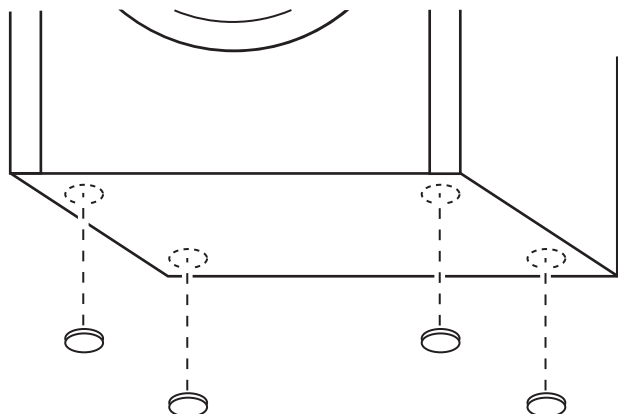

Précautions à prendre lors des connexions et de la mise sous tension

- Afin d'éviter un mauvais fonctionnement et/ou d'endommager les enceintes et autres périphériques, diminuez toujours le volume et mettez toujours les périphériques hors tension avant d'effectuer une connexion.
- L'utilisation d'un câble à résistance peut entraîner une perte de niveau sonore. Utilisez des câbles ne contenant pas de résistance.
- Quand les connexions sont effectuées, mettez sous tension les différents appareils dans l'ordre spécifié. Ne pas respecter cet ordre peut entraîner des dysfonctionnements et/ou endommager les enceintes ou tout autre appareil. (Lors de la mise hors tension, suivez la procédure inverse.) <Appareils connectés → DM-10>
- Baissez toujours le volume avant la mise sous tension. Même avec le volume à zéro, il se peut que vous entendiez des sons lors de la mise sous tension, mais cela ne signifie rien d'anormal.

Exemple de connexion

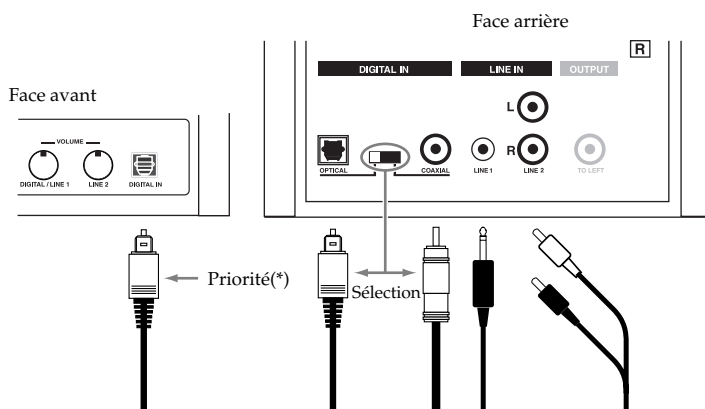
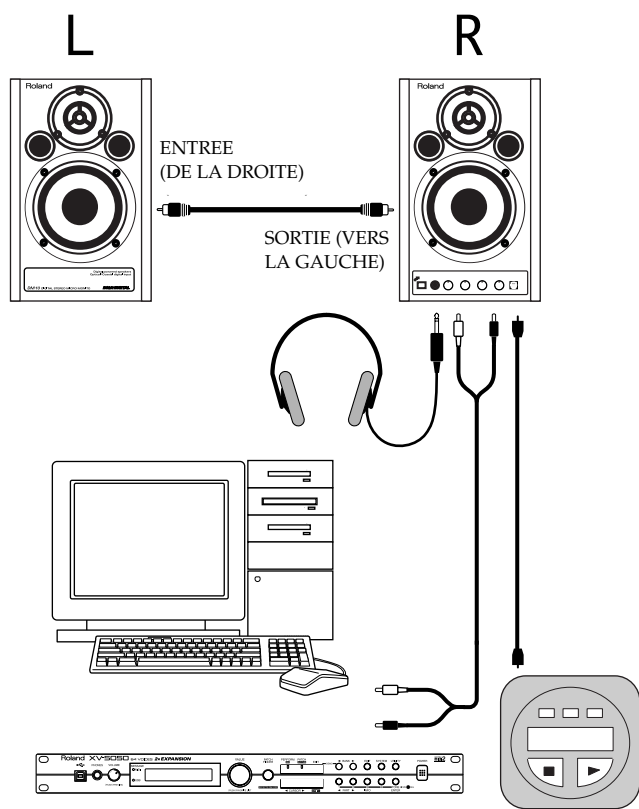

* Si vous connectez un câble sur DIGITAL IN en face avant, le son des appareils connectés sur les prises DIGITAL IN en face arrière ne sera pas audible.

Module de sons, Lecteur CD, Lecteur MD, etc.

Descrizione del pannello

Canale sinistro

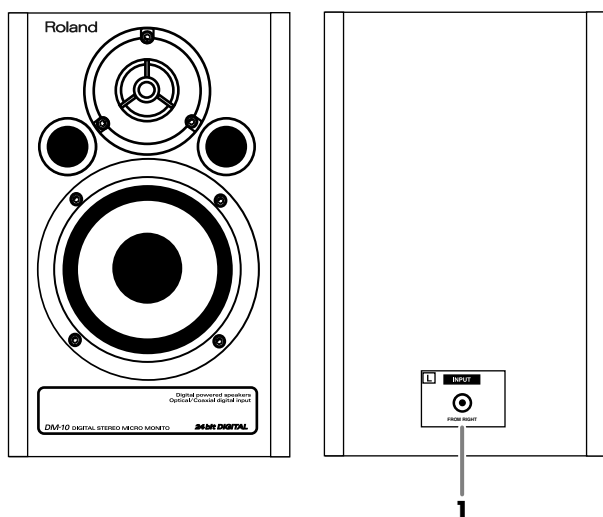

1. Presa d'ingresso canale sinistro

Collegare alla presa d'uscita del canale sinistro **14** sul lato destro dell'apparecchio. Per effettuare il collegamento, utilizzare il cavo per altoparlanti in dotazione.

2. Interruttore POWER, Indicatore POWER/STANDBY

L'indicatore POWER/STANDBY diventa rosso in standby e verde quando l'apparecchio è acceso.

3. Presa PHONES

Se si collegano le cuffie a questa presa, non verrà emesso alcun suono dagli altoparlanti.

4. Manopola BASS

Regolano i bassi e gli acuti. Regolare al centro per uniformare il suono.

6. Manopola VOLUME (DIGITAL/LINE 1)

Regola il volume dei dispositivi collegati ai connettori d'ingresso digitale **8, 9, 11** e alla presa d'ingresso LINE 1 **12**.

7. Manopola VOLUME (LINE 2)

Questo regola il volume dei sistemi collegati a prese d'ingresso LINE 2 **13**.

8. Connettore di ingresso digitale (ottico)

Connettore d'ingresso digitale per il cavo a fibre ottiche.

* Se un cavo viene collegato a questo connettore, i suoni dei dispositivi collegati al connettore d'ingresso digitale **9** o **11** non saranno udibili.

Canale destro

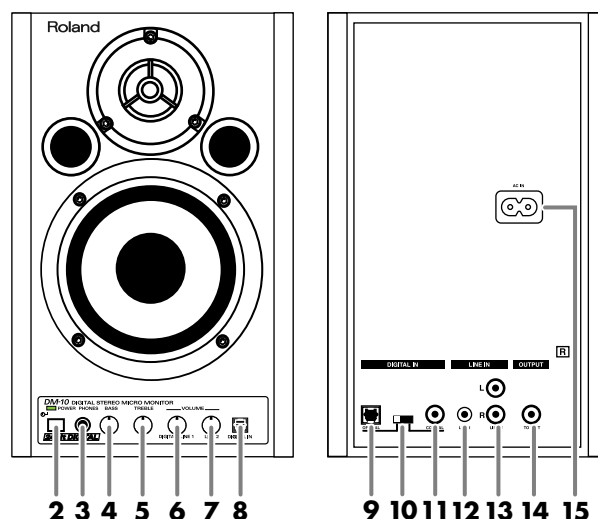

9. Connettore di ingresso digitale (ottico)

Connettore d'ingresso digitale per il cavo a fibre ottiche.

10. Interruttore di selezione ingresso digitale

Questo interruttore seleziona il connettore di ingresso digitale **9** o **11** sul pannello posteriore. Selezionare il connettore utilizzato per il segnale in entrata.

* Se si collega un cavo al connettore d'ingresso digitale **8** sul pannello frontale, i suoni del dispositivo collegato a **8** saranno udibili indipendentemente dalla posizione di questo interruttore.

11. Connettore di ingresso digitale (coassiale)

Connettore d'ingresso digitale per il cavo coassiale.

12. Presa d'ingresso LINE 1 (tipo mini stereo)

13. Prese d'ingresso LINE 2 (L, R) (pin tipo RCA)

14. Presa d'uscita canale sinistro

Collegare alla presa d'ingresso del canale sinistro **1** sul lato sinistro dell'apparecchio.

15. Presa AC

Collegare a questa presa il cavo di alimentazione in dotazione (p. 17). Inserirlo a fondo per evitare che si scollegi accidentalmente.

Collegamenti

Montare i Piedini in Gomma (Inclusi)

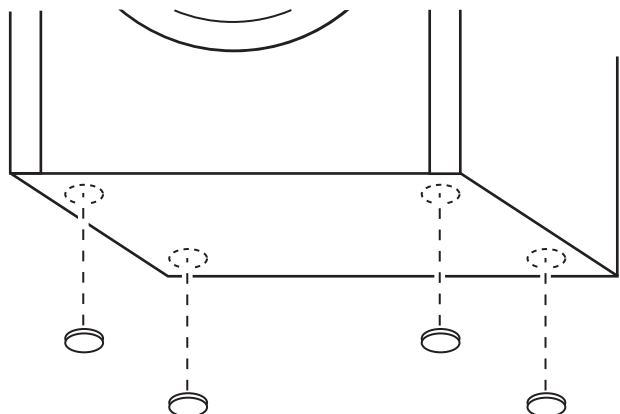

Precauzioni durante i collegamenti e l'accensione

- Per evitare malfunzionamenti e/o danni ai diffusori o ad altri dispositivi, abbassare sempre il volume e accertarsi che tutti gli apparecchi non siano alimentati prima di effettuare i collegamenti.
- L'uso di un cavo provvisto di un resistore potrebbe risultare in un livello audio basso. Utilizzare un cavo di collegamento senza resistore.
- Una volta terminati i collegamenti, accendere i vari dispositivi nell'ordine indicato. Se i dispositivi vengono accesi nell'ordine sbagliato, si rischia di provocare malfunzionamenti e/o danni ai diffusori e agli altri dispositivi. (Seguire la procedura al contrario nella fase di spegnimento.)
< Dispositivi collegati → DM-10 >
- Prima di accendere gli apparecchi, accertarsi che il livello del volume sia al minimo. Si potrebbero sentire comunque dei suoni all'accensione, anche se il volume è al minimo; è normale e non c'è motivo di preoccuparsi.

Esempio di collegamenti

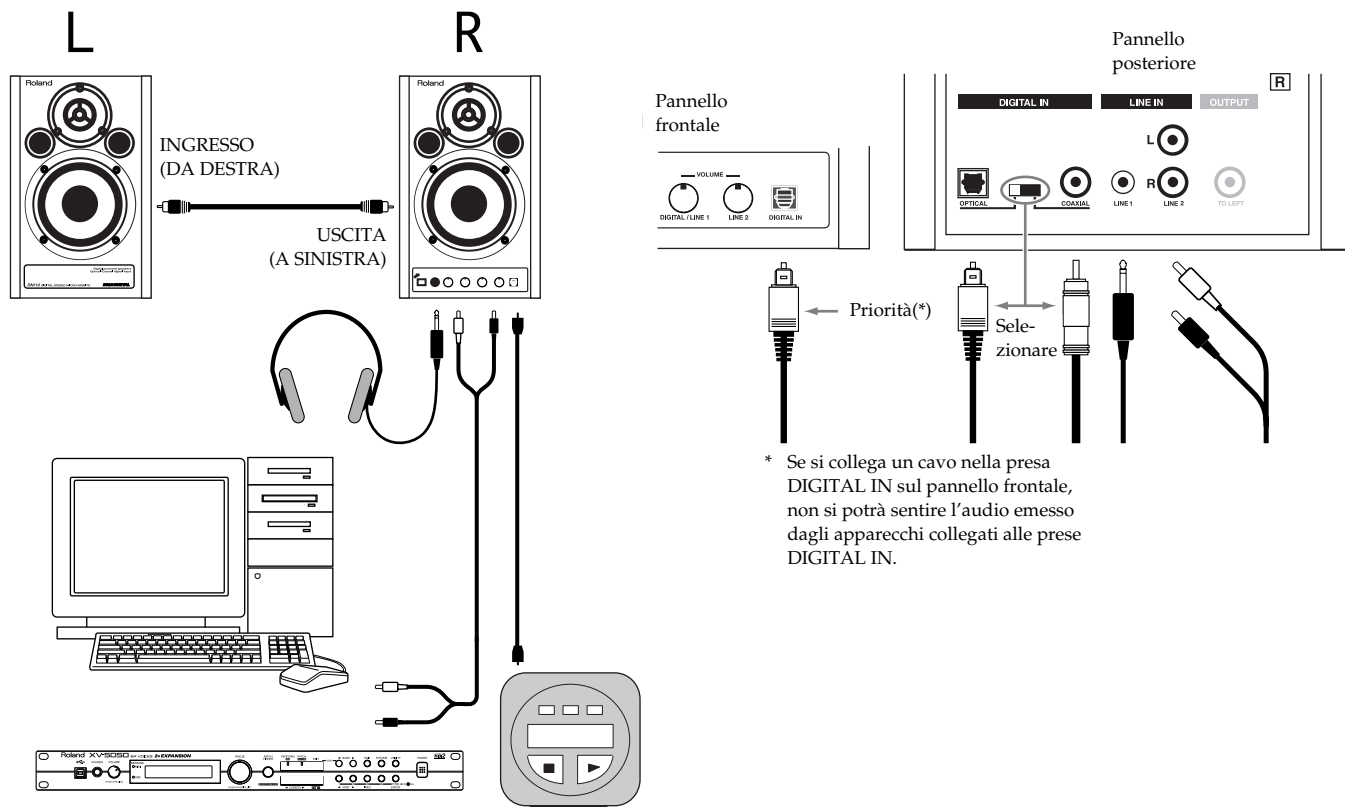

Modulo sonoro, lettore CD, lettore MD, ecc.

English

Deutsch

Français

Italiano

Español

Descripción del panel

Canal izquierdo

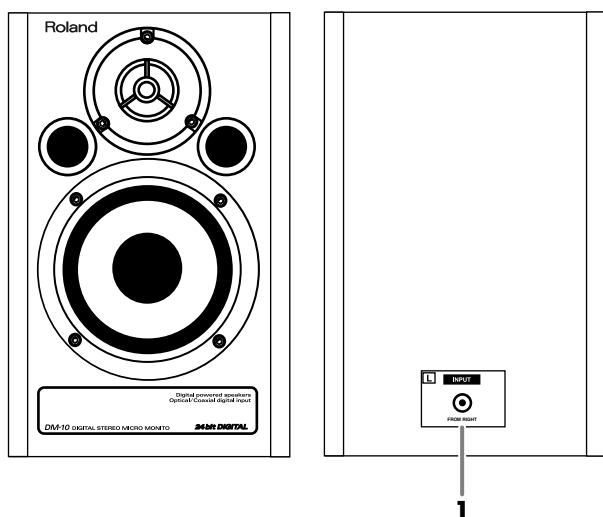

1. Jack de entrada del canal izquierdo

Conéctelo al jack de salida del canal izquierdo **14** que se encuentra en el lado derecho de la unidad. Para la conexión, utilice el cable del altavoz que viene incluido.

2. Interruptor POWER, Indicador POWER/STANDBY

El indicador POWER/STANDBY muestra una luz de color rojo cuando la unidad se encuentra en modo de espera y una luz de color verde cuando está encendida.

3. Jack de los auriculares

Cuando conecte los auriculares a este jack, los altavoces no emitirán ningún sonido.

4. Control BASS

5. Control TREBLE

Estos botones ajustan el tono de los bajos y los agudos. Cóloquelos en el centro para que los tonos queden nivelados.

6. Control VOLUME (DIGITAL/LÍNEA 1)

Ajusta el volumen de los aparatos conectados a los conectores de entrada digital **8**, **9**, **11**, y al jack de entrada de la LÍNEA 1 **12**.

7. Control VOLUME (LÍNEA 2)

Esto ajusta el volumen del dispositivo conectado a los enchufes **13** de la LÍNEA 2.

8. Conector de entrada digital (Optical)

Este es el conector de entrada digital para el cable de fibra óptica.

* Cuando conecte un cable a este conector, no se podrá oír el sonido de los aparatos conectados al conector de entrada digital **9** o **11**.

Canal derecho

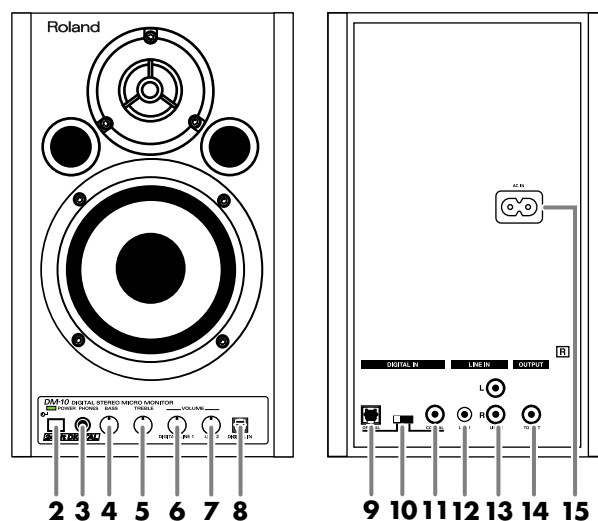

9. Conector de entrada digital (Optical)

Este es el conector de entrada digital para el cable de fibra óptica.

10. Interruptor de selección de entrada digital

Este interruptor selecciona el conector de entrada digital **9** o **11** en el panel posterior. Seleccione el conector que se utiliza para la señal de entrada.

* Cuando conecta un cable al conector de entrada digital **8** en el panel frontal, se podrá oír el sonido del aparato conectado a **8** independientemente de este interruptor.

11. Conector de entrada digital (Coaxial)

Este es el conector de entrada digital para el cable coaxial.

12. Jack de entrada de la LÍNEA 1 (stereo mini type)

13. Jacks de entrada de la LÍNEA 2 (Izquierda, Derecha) (tipo de patilla RCA)

Este es el conector de entrada digital para el cable de fibra óptica.

14. Jack de salida del canal izquierdo

Conéctelo al jack de entrada del canal izquierdo **1** que se encuentra en el lado izquierdo de la unidad.

15. Entrada CA

Conecte aquí el cable de alimentación (Paginas 17). Enchúfelo de modo que el cable no se pueda desconectar

Conexiones

Incluye los pies de goma

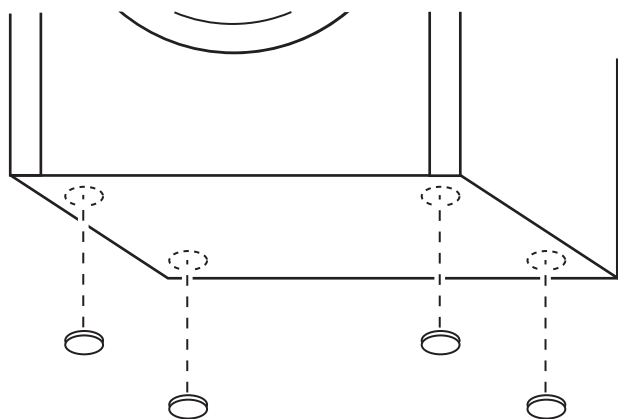

Precauciones que debe tener en cuenta cuando conecte y encienda la unidad

- Para evitar anomalías en el funcionamiento o daños en los altavoces u otros aparatos, baje siempre el volumen y apague todos los aparatos antes de realizar cualquier conexión.
- Si utiliza un cable que posea un reostato, el nivel de sonido puede bajar. Utilice un cable de conexión que no contenga un reostato.
- Una vez completadas las conexiones, encienda los diferentes aparatos en el orden especificado. Si enciende los aparatos en un orden equivocado, puede causar anomalías en el funcionamiento o daños en los altavoces y otros aparatos. (Cuando apague el sistema, siga estas instrucciones en el orden inverso)
< Aparatos conectados → DM-10 >
- Asegúrese siempre de tener bajado el volumen antes de encender la unidad. Aunque tenga el volumen completamente bajado, puede oír algún sonido al encender la unidad pero esto es algo normal y no indica un mal funcionamiento de la misma.

Ejemplo de conexión

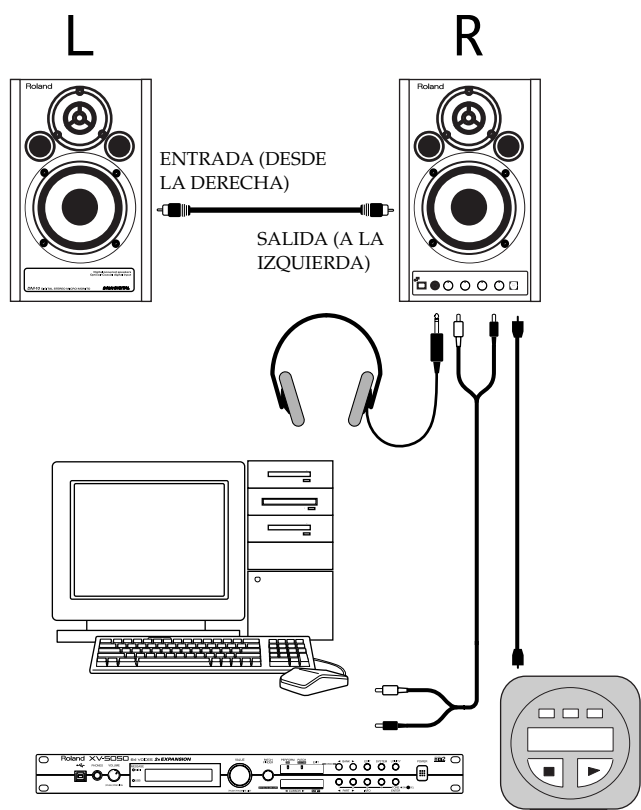

Módulo de sonido, reproductor de CD, reproductor de MD, etc.

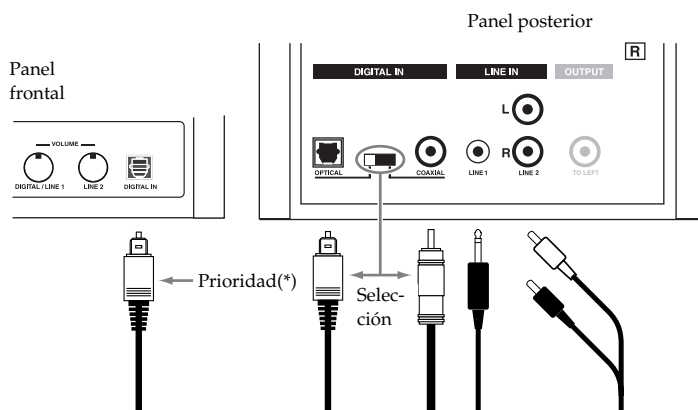

* Cuando conecta un cable a la DIGITAL IN (Entrada digital) del panel frontal, no se podrá escuchar el sonido de ningún aparato que esté conectado a la o las DIGITAL IN (Entradas digitales) del panel posterior.

Specifications

Rated Power Output

20 W (10 W + 10 W)

Speaker Unit

Woofer: 9.2 cm /
3-5/8" (Magnetically-Shielded)
Tweeter: 5 cm /
2" (Magnetically-Shielded)

Frequency Range

45 Hz to 35 kHz

Nominal Input Level

Line: -10 dBu
Stereo: -10 dBu

Input Impedance

18 k ohms

Controls

< R Channel >

BASS Control Knob

TREBLE Control Knob

VOLUME Knob x 2

- VOLUME 1 (digital inputs + stereo mini)
- VOLUME 2 (RCA phono)

POWER Switch

Digital Input Select Switch Indicator

Power/Standby Indicator

Connectors

< R Channel >

Front: PHONES Jack (stereo miniature phone type)
Optical Input Connector

Rear: LINE 1 Jack (stereo miniature phone type)
LINE 2 Jacks (L, R) (RCA phono type)
L Channel Output Jack (RCA phono type)
Optical Input Connector
Coaxial Input Connector

< L Channel >

Rear: L Channel Input Jack (RCA phono type)

Digital Input Section

Sampling Rate: 32/44.1/48/96 kHz, 24-bit

D/A Converter: 24-bit

Enclosure

2 way Bass-reflex type (Wooden Cabinet)

Power Supply

AC 117 V, AC 230 V or AC 240 V

Power Consumption

230 mA (AC 117 V)

120 mA (AC 230 V)

110 mA (AC 240 V)

Dimensions

156 (W) x 197 (D) x 238 (H) mm

6-3/16 (W) x 7-13/16 (D) x 9-3/8 (H) inches

Weight

< R Channel >

3.5 kg / 7 lbs 12 oz

< L Channel >

2.3 kg / 5 lbs 2 oz

Accessories

Owner's Manual

Conversion Cable

(stereo miniature phone type ↔ RCA phono type)

Speaker Cable (RCA phono type)

Power Cord

* 0 dBu = 0.775 V rms

* In the interest of product improvement, the specifications and/or appearance of this unit are subject to change without prior notice.

For 230 V (English)

This box contains continental and British power cables. Please select the correct type for your country.

Für 230 V (Deutsch)

Diese Packung beinhaltet europäische und britische Netzkabel. Bitte suchen Sie sich die richtige Variante für Ihr Land aus.

Pour 230 V (Français)

Cette boîte contient des alimentations anglaises ou continentales. Merci de choisir l'alimentation appropriée de votre pays.

Per 230 V (Italiano)

La confezione contiene alimentatori con spina europea e Inglese. Scegliete quella adatta alla Vostra nazione.

Para 230 V (Español)

Esta caja contiene cables de corriente continentales y británicos. Por favor seleccione el tipo correcto para su país.

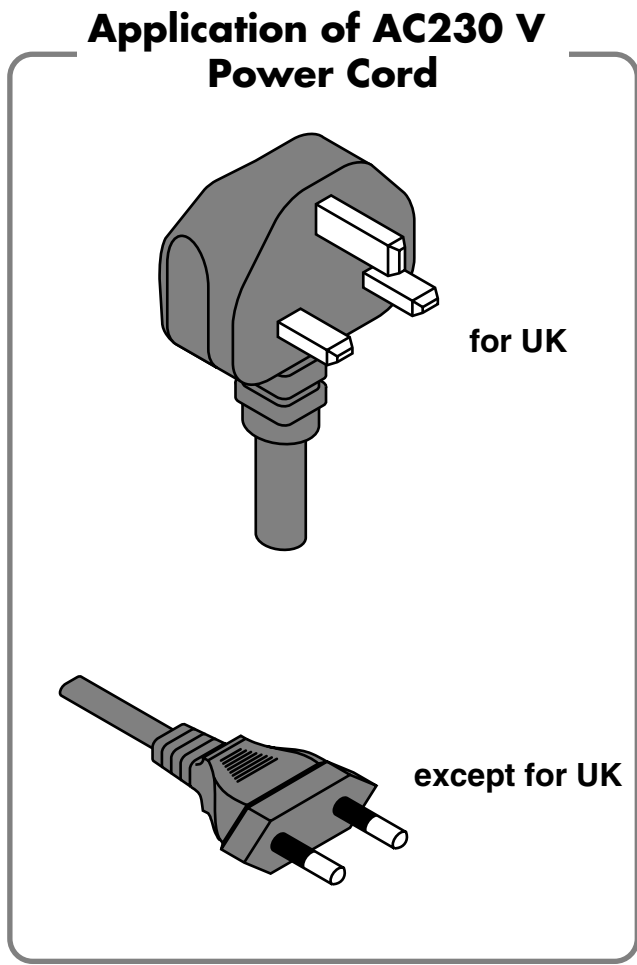



This product complies with the requirements of European Directives EMC 89/336/EEC and LVD 73/23/EEC.

For EU Countries

FEDERAL COMMUNICATIONS COMMISSION RADIO FREQUENCY INTERFERENCE STATEMENT

This equipment has been tested and found to comply with the limits for a Class B digital device, pursuant to Part 15 of the FCC Rules. These limits are designed to provide reasonable protection against harmful interference in a residential installation. This equipment generates, uses, and can radiate radio frequency energy and, if not installed and used in accordance with the instructions, may cause harmful interference to radio communications. However, there is no guarantee that interference will not occur in a particular installation. If this equipment does cause harmful interference to radio or television reception, which can be determined by turning the equipment off and on, the user is encouraged to try to correct the interference by one or more of the following measures:

- Reorient or relocate the receiving antenna.
- Increase the separation between the equipment and receiver.
- Connect the equipment into an outlet on a circuit different from that to which the receiver is connected.
- Consult the dealer or an experienced radio/TV technician for help.

This device complies with Part 15 of the FCC Rules. Operation is subject to the following two conditions:

- (1) This device may not cause harmful interference, and
- (2) This device must accept any interference received, including interference that may cause undesired operation.

Unauthorized changes or modification to this system can void the users authority to operate this equipment.
This equipment requires shielded interface cables in order to meet FCC class B Limit.

For the USA

NOTICE

This Class B digital apparatus meets all requirements of the Canadian Interference-Causing Equipment Regulations.

AVIS

Cet appareil numérique de la classe B respecte toutes les exigences du Règlement sur le matériel brouilleur du Canada.

For Canada

