

PROFESSIONAL DJ MIXER

DJ-1000



OWNER'S MANUAL

Thank you for purchasing the Roland PROFESSIONAL DJ MIXER DJ-1000. Before using this unit, carefully read the sections entitled: "IMPORTANT SAFETY INSTRUCTIONS" (p. 2), "USING THE UNIT SAFELY" (p. 3), and "IMPORTANT NOTES" (p. 5). These sections provide important information concerning the proper operation of the unit. Additionally, in order to feel assured that you have gained a good grasp of every feature provided by your new unit, this manual should be read in its entirety. The manual should be saved and kept on hand as a convenient reference.

Main Features

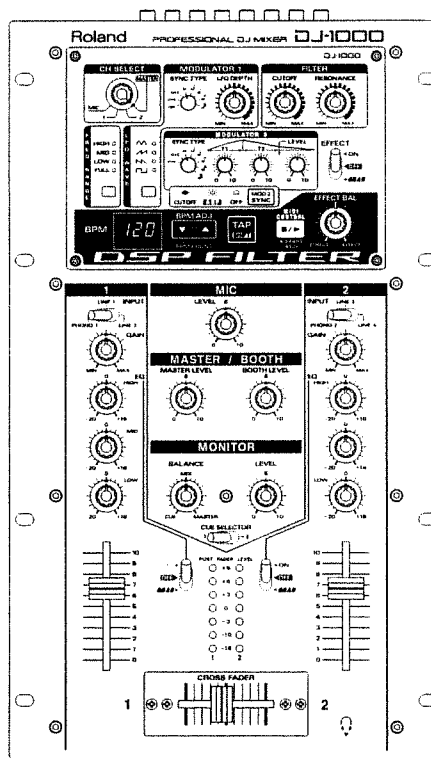
- Thanks to its **DSP filter** and **BPM control capabilities**, this DJ mixer provides you with new creative possibilities. While relying on the basic mixer functionality, your performances can also take full advantage of the versatile sound manipulation capabilities you now have at your fingertips.
- As inputs, the DJ-1000 provides two channels of stereo input (three switchable sources).
- The EQ provides ample amounts of boost and cut (-20 to +16 dB). Spring-return type **GRAB switches** are provided on each channel, so that you can rapidly switch the EQ on/off in time to the beat.
- Wide-range **GAIN** knobs allow you to make adjustments to suit a variety of sources and equipment.
- A built-in **MIDI OUT connector** allows you to perform BPM synchronization, or to control start/stop. By connecting the DJ-1000 to MIDI devices such as the Roland MC-505/303 or JX-305, you can construct a truly personalized DJ system.
- A dedicated microphone input channel is provided. You can apply the DSP filter to the microphone input and use your voice as a powerful part of your DJ performances.



	CAUTION RISK OF ELECTRIC SHOCK DO NOT OPEN	
ATTENTION: RISQUE DE CHOC ELECTRIQUE NE PAS OUVRIR		
CAUTION: TO REDUCE THE RISK OF ELECTRIC SHOCK, DO NOT REMOVE COVER (OR BACK). NO USER-SERVICEABLE PARTS INSIDE. REFER SERVICING TO QUALIFIED SERVICE PERSONNEL.		



The lightning flash with arrowhead symbol, within an equilateral triangle, is intended to alert the user to the presence of uninsulated "dangerous voltage" within the product's enclosure that may be of sufficient magnitude to constitute a risk of electric shock to persons.



The exclamation point within an equilateral triangle is intended to alert the user to the presence of important operating and maintenance (servicing) instructions in the literature accompanying the product.

INSTRUCTIONS PERTAINING TO A RISK OF FIRE, ELECTRIC SHOCK, OR INJURY TO PERSONS.

IMPORTANT SAFETY INSTRUCTIONS

SAVE THESE INSTRUCTIONS

WARNING - When using electric products, basic precautions should always be followed, including the following:

1. Read all the instructions before using the product.
2. Do not use this product near water — for example, near a bathtub, washbowl, kitchen sink, in a wet basement, or near a swimming pool, or the like.
3. This product should be used only with a cart or stand that is recommended by the manufacturer.
4. This product, either alone or in combination with an amplifier and headphones or speakers, may be capable of producing sound levels that could cause permanent hearing loss. Do not operate for a long period of time at a high volume level or at a level that is uncomfortable. If you experience any hearing loss or ringing in the ears, you should consult an audiologist.
5. The product should be located so that its location or position does not interfere with its proper ventilation.
6. The product should be located away from heat sources such as radiators, heat registers, or other products that produce heat.
7. The product should be connected to a power supply only of the type described in the operating instructions or as marked on the product.
8. The power-supply cord of the product should be unplugged from the outlet when left unused for a long period of time.
9. Care should be taken so that objects do not fall and liquids are not spilled into the enclosure through openings.
10. The product should be serviced by qualified service personnel when:
 - A. The power-supply cord or the plug has been damaged; or
 - B. Objects have fallen, or liquid has been spilled into the product; or
 - C. The product has been exposed to rain; or
 - D. The product does not appear to operate normally or exhibits a marked change in performance; or
 - E. The product has been dropped, or the enclosure damaged.
11. Do not attempt to service the product beyond that described in the user-maintenance instructions. All other servicing should be referred to qualified service personnel.

For the USA

This product may be equipped with a polarized line plug (one blade wider than the other) . This is a safety feature. If you are unable to insert the plug into the outlet, contact an electrician to replace your obsolete outlet. Do not defeat the safety purpose of the plug.

For Canada

For Polarized Line Plug

CAUTION: TO PREVENT ELECTRIC SHOCK, MATCH WIDE BLADE OF PLUG TO WIDE SLOT, FULLY INSERT.
ATTENTION: POUR ÉVITER LES CHOCs ÉLECTRIQUES, INTRODUIRE LA LAME LA PLUS LARGE DE LA FICHE DANS LA BORNE CORRESPONDANTE DE LA PRISE ET POUSSER JUSQU' AU FOND.

For the U.K.

IMPORTANT: THE WIRES IN THIS MAINS LEAD ARE COLOURED IN ACCORDANCE WITH THE FOLLOWING CODE.

BLUE: NEUTRAL
BROWN: LIVE

As the colours of the wires in the mains lead of this apparatus may not correspond with the coloured markings identifying the terminals in your plug, proceed as follows:
 The wire which is coloured BLUE must be connected to the terminal which is marked with the letter N or coloured BLACK.
 The wire which is coloured BROWN must be connected to the terminal which is marked with the letter L or coloured RED.
 Under no circumstances must either of the above wires be connected to the earth terminal of a three pin plug.

USING THE UNIT SAFELY

INSTRUCTIONS FOR THE PREVENTION OF FIRE, ELECTRIC SHOCK, OR INJURY TO PERSONS

About ⚠ WARNING and ⚠ CAUTION Notices

⚠ WARNING	Used for instructions intended to alert the user to the risk of death or severe injury should the unit be used improperly.
⚠ CAUTION	Used for instructions intended to alert the user to the risk of injury or material damage should the unit be used improperly. * Material damage refers to damage or other adverse effects caused with respect to the home and all its furnishings, as well to domestic animals or pets.

About the Symbols

	The ⚠ symbol alerts the user to important instructions or warnings. The specific meaning of the symbol is determined by the design contained within the triangle. In the case of the symbol at left, it is used for general cautions, warnings, or alerts to danger.
	The ⚡ symbol alerts the user to items that must never be carried out (are forbidden). The specific thing that must not be done is indicated by the design contained within the circle. In the case of the symbol at left, it means that the unit must never be disassembled.
	The ⏏ symbol alerts the user to things that must be carried out. The specific thing that must be done is indicated by the design contained within the circle. In the case of the symbol at left, it means that the power-cord plug must be unplugged from the outlet.

ALWAYS OBSERVE THE FOLLOWING

⚠ WARNING

- Before using this unit, make sure to read the instructions below, and the Owner's Manual.
- Do not open or perform any internal modifications on the unit. (The only exception would be where this manual provides specific instructions which should be followed in order to put in place user-installable options; see p. 24.)
- Make sure you always have the unit placed so it is level and sure to remain stable. Never place it on stands that could wobble, or on inclined surfaces.
- Avoid damaging the power cord. Do not bend it excessively, step on it, place heavy objects on it, etc. A damaged cord can easily become a shock or fire hazard. Never use a power cord after it has been damaged.
- In households with small children, an adult should provide supervision until the child is capable of following all the rules essential for the safe operation of the unit.
- Protect the unit from strong impact. (Do not drop it!)
- Do not force the unit's power-supply cord to share an outlet with an unreasonable number of other devices. Be especially careful when using extension cords—the total power used by all devices you have connected to the extension cord's outlet must never exceed the power rating (watts/ amperes) for the extension cord. Excessive loads can cause the insulation on the cord to heat up and eventually melt through.
- Always turn the unit off and unplug the power cord before attempting installation of the circuit board (model no. CFX-1; p. 24).

⚠ WARNING

- Before using the unit in a foreign country, consult with your retailer, the nearest Roland Service Center, or an authorized Roland distributor, as listed on the "Information" page.

⚠ CAUTION

- Always grasp only the plug on the power-supply cord when plugging into, or unplugging from, an outlet or this unit.
- Try to prevent cords and cables from becoming entangled. Also, all cords and cables should be placed so they are out of the reach of children.
- Never climb on top of, nor place heavy objects on the unit.
- Never handle the power cord or its plugs with wet hands when plugging into, or unplugging from, an outlet or this unit.
- Before moving the unit, disconnect the power plug from the outlet, and pull out all cords from external devices.
- Before cleaning the unit, turn off the power and unplug the power cord from the outlet (p. 9).
- Whenever you suspect the possibility of lightning in your area, pull the plug on the power cord out of the outlet.
- Install only the specified circuit board(s) (model no. CFX-1). Remove only the specified screws (p. 24).

Contents

USING THE UNIT SAFELY	3
IMPORTANT NOTES	5
Names of Things/What They Do Front and Rear panel	6
Channel/Master Sections	6
Rear Panel	9
DJ System Examples	10
Blank Chart	11
Modifying the Sound in Real Time (DSP Filter)	12
DSP Filter Section—Names of Things/What They Do	12
Operating Each Block of the DSP Filter	14
Giving Character to the Sound (FILTER Block)	14
Modulating in Sync with the BPM (MODULATOR 1 Block)	15
Applying Additional Change to the Sound (MODULATOR 2 Block)	16
Examples of Effective DSP Filter Settings	18
Blank Chart For DSP Filter	19
Synchronizing a Record or CD with a MIDI Device (BPM Control) ..	20
Setting BPM	20
1. Strike the Pad at the Desired Tempo (TAP)	20
2. Manual Settings (BPM ADJ)	20
3. Automatic Detection (BPM COUNT)	22
Playing a MIDI Device at the Specified BPM (Synchronizing BPM and a MIDI Device)	23
Replacing the Cross Fader	24
Troubleshooting	25
No Sound	25
Noise Occurs	25
Sound is distorted	25
DSP Filter Does Not Work	25
A Range Other Than the Selected Frequency Range (FREQ RANGE) Can be Heard	25
BPM Cannot be Detected Automatically	25
A Connected MIDI Instrument Does not Start	25
Specifications/Input and Output Standards	26
Specifications	26
Input and Output Standard	26
Block Diagram	27
MIDI Implementation	28
MIDI Implementation Chart	29
Index	30

IMPORTANT NOTES

In addition to the items listed under “IMPORTANT SAFETY INSTRUCTIONS” and “USING THE UNIT SAFELY” on pages 2 and 3, please read and observe the following:

Power Supply

- Do not use this unit on the same power circuit with any device that will generate line noise (such as an electric motor or variable lighting system).
- Before connecting this unit to other devices, turn off the power to all units. This will help prevent malfunctions and/or damage to speakers or other devices.
- When connecting / disconnecting all cables, grasp the connector itself—never pull on the cable. This way you will avoid causing shorts, or damage to the cable’s internal elements.
- A small amount of heat will radiate from the unit during normal operation.

Placement

- Using the unit near power amplifiers (or other equipment containing large power transformers) may induce hum. To alleviate the problem, change the orientation of this unit; or move it farther away from the source of interference.
- This device may interfere with radio and television reception. Do not use this device in the vicinity of such receivers.
- Do not expose the unit to direct sunlight, place it near devices that radiate heat, leave it inside an enclosed vehicle, or otherwise subject it to temperature extremes. Excessive heat can deform or discolor the unit.
- To avoid possible breakdown, do not use the unit in a wet area, such as an area exposed to rain or other moisture.
- To avoid disturbing your neighbors, try to keep the unit’s volume at reasonable levels. You may prefer to use headphones, so you do not need to be concerned about those around you (especially when it is late at night).
- When you need to transport the unit, package it in the box (including padding) that it came in, if possible. Otherwise, you will need to use equivalent packaging materials.

Maintenance

- For everyday cleaning wipe the unit with a soft, dry cloth or one that has been slightly dampened with water. To remove stubborn dirt, use a cloth impregnated with a mild, non-abrasive detergent. Afterwards, be sure to wipe the unit thoroughly with a soft, dry cloth.
- Never use benzine, thinners, alcohol or solvents of any kind, to avoid the possibility of discoloration and/or deformation.

Additional Precautions

- Use a reasonable amount of care when using the unit’s buttons, sliders, or other controls; and when using its jacks and connectors. Rough handling can lead to malfunctions.
- Never strike or apply strong pressure to the display.
- A small amount of noise may be heard from the display during normal operation.

Channel/Master Sections

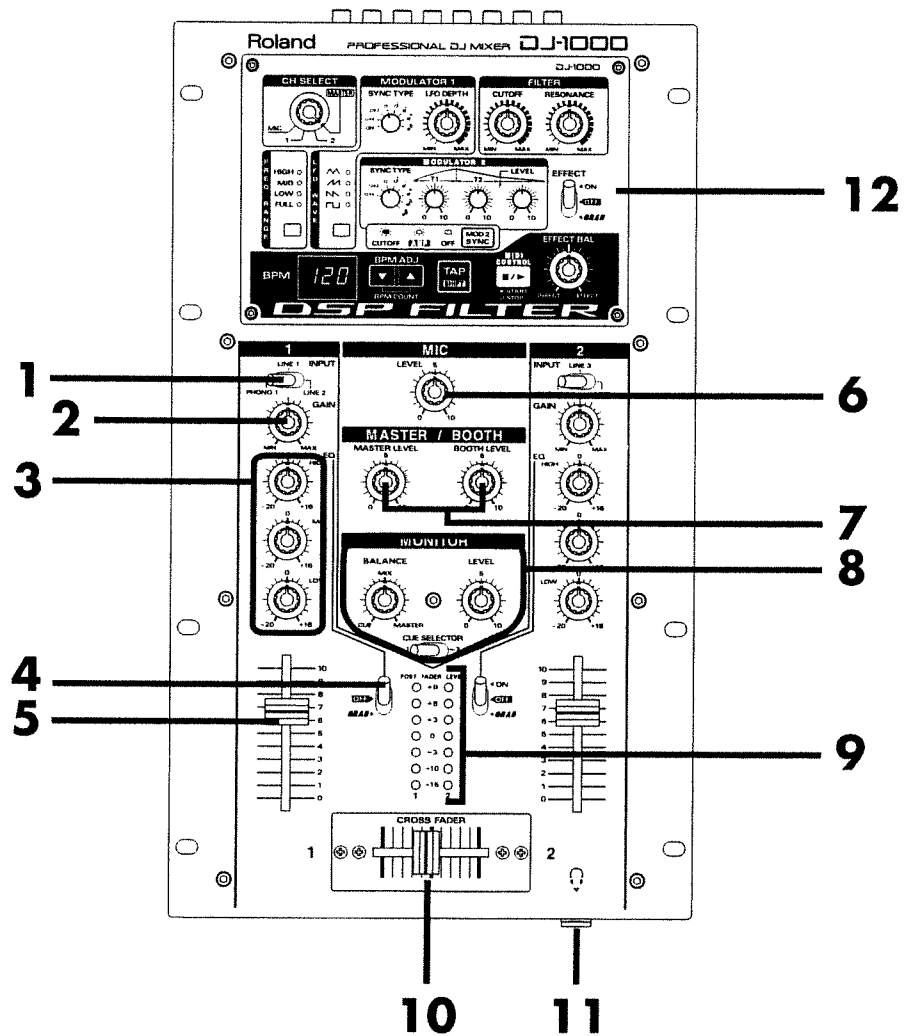

1. INPUT Select Switches

These switches select the device that will be connected to each channel.

- Channel 1: PHONO 1 ↔ LINE 1 ↔ LINE 2
- Channel 2: PHONO 2 ↔ LINE 3 ↔ LINE 4

2. GAIN Knobs

Use these knobs to adjust the level so that the input signal will be at the optimal level. Try to get it so the "0" position on the level meter just barely lights up while you have the channel fader(5) at the maximum level (at 10).

3. EQ (Equalizer Knobs)

These knobs boost/cut the level at each frequency range.

Each knob will cut its range by maximum of 20 dB when turned fully counterclockwise, and boost by a maximum of 16 dB when turned fully clockwise.

- HIGH: Adjust the level of the high frequency range. →for cymbals and high-pitched instruments
- MID: Adjust the level of the middle frequency range. →for vocals
- LOW: Adjust the level of the low frequency range. →for bass,bass drum etc.

4. GRAB Switch

This switch turns the EQ on/off. If the switch is in the ON position, the EQ will always be on. If the switch is moved to the GRAB position, the EQ will on only while the switch is in that position.



The GRAB switch lets you produce a "stepped" effect in time with the rhythm. By using the knobs in conjunction with the GRAB switch, you can put on a more dynamic DJ performance.

5. Channel Faders

These faders adjust the output level of each channel.

6. Dedicated Mic Input Channel LEVEL Knob

This knob adjusts the volume of the connected mic.



This channel is only for use with a microphone. Do not connect any device other than a microphone.

7. MASTER/BOOTH Knobs

- MASTER Knob
This knob adjusts the mix level of the signal that is output from the OUTPUT-MASTER jacks.
- BOOTH Knob
This knob adjust the mix level of the signal that is output from the OUTPUT-BOOTH jacks.



Two systems can be connected simultaneously. You can use the MASTER jacks as an output to the main PA system, and the BOOTH jacks as an output to your monitor system. Refer to "DJ System Examples" (P.10)

8. MONITOR

- BALANCE Knob
This knob adjusts the volume balance (CUE ↔ MASTER) of the headphones. When this is turned fully counterclockwise, only the CUE sound will be heard. When turned fully clockwise, only the MASTER output sound will be heard. When in the center (MIX), the CUE sound and MASTER output sound will be output at the same volume. The CUE sound is selected by the CUE SELECTOR switch.
- LEVEL Knob
This knob adjusts the volume of the headphones.
- CUE SELECTOR Switch
This switch selects the channel of the CUE sound that will be monitored in the headphones.



**The channel faders, cross-fader and MASTER/BOOTH knob do not affect the volume of the CUE sound.*

**MASTER/BOOTH knob do not affect the volume of the MASTER sound.*

→Refer to "Block diagram" (P.27)

9. Level Meters

The left indicator shows the level of channel 1, and the right indicator shows the level of channel 2.

The level is monitored after the channel fader (POST FADER).

10. Cross-Fader

When this fader is moved to the left, channel 1 will be output. When moved to the right, channel 2 will be output. When in the center, both sounds will be output.



The cross-fader is replaceable. If you begin to hear noise when moving the fader, or if the fader no longer functions properly, please replace the fader. Please use the CFX-1 replacement cross-fader which is available specially for the DJ-1000. For the replacement procedure, refer to p. 24.

11. Headphone Jack

A set of headphones can be connected here.



Headphones connected to this device are capable of producing volume levels that may produce permanent hearing loss. Do not use headphones at high volume levels or for an extended period of time. If you should experience any loss of hearing or ringing in your ears, immediate stop using this device, and consult a medical professional.

12. DSP Filter Section (p. 12)

Rear Panel

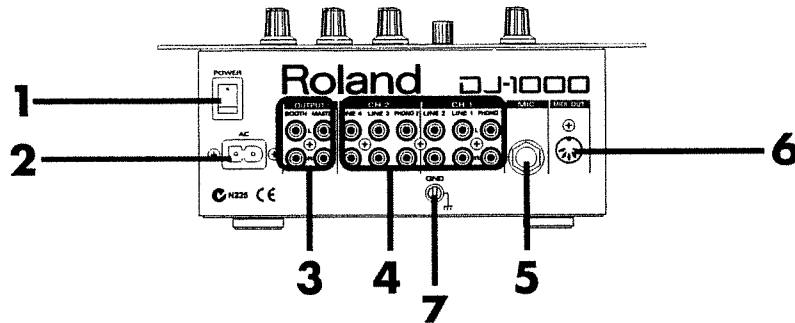

1. Power Switch



Before turning the power on or off, you must lower the faders/volume of this device and your connected amp system etc.

2. AC Inlet

Connect the included power supply cable here. Plug it firmly in, so that the cable does not accidentally become disconnected.

3. Output Jacks

- MASTER (L/R)
These are output jacks. The volume is adjusted by the MASTER knob.
- BOOTH (L/R)
These are output jacks. The volume is adjusted by the BOOTH knob.



Since both systems can be connected simultaneously, you can use the MASTER jacks as an output to the main PA system, and the BOOTH jacks as an output to your monitor system.

Refer to "DJ System Examples" (p. 10).

4. Input Jacks

- Channel 1: PHONO 1/LINE 1/LINE 2
- Channel 2: PHONO 2/LINE 3/LINE 4

5. Mic Input Jack

A mic can be connected here.

**This channel is for a microphone only. Do not connect any device other than a microphone.*

6. MIDI OUT Connector

This is an output connector for MIDI data. Connect it to the MIDI IN connector of an external MIDI device (rhythm machine or sequencer).
Refer to "DJ System Examples" (p. 10).

7. GND Terminal

Connect this to the grounding wire of your record player.

- To prevent malfunction and/or damage to speakers or other devices, always turn down the volume, and turn off the power on all devices before making any connections.
- Once the connections have been completed, turn on power to your various devices in the order specified. By turning on devices in the wrong order, you risk causing malfunction and/or damage to speakers and other devices.

Connected devices → DJ-1000 → power amp etc.
(When turning the power off, reverse this procedure.)

- This unit is equipped with a protection circuit. A brief interval (a few seconds) after power up is required before the unit will operate normally.
- Howling could be produced depending on the location of microphones relative to speakers. This can be remedied by:
 - Changing the orientation of the microphone.
 - Relocating microphone at a greater distance from speakers.
 - Lowering volume levels.

DJ System Examples

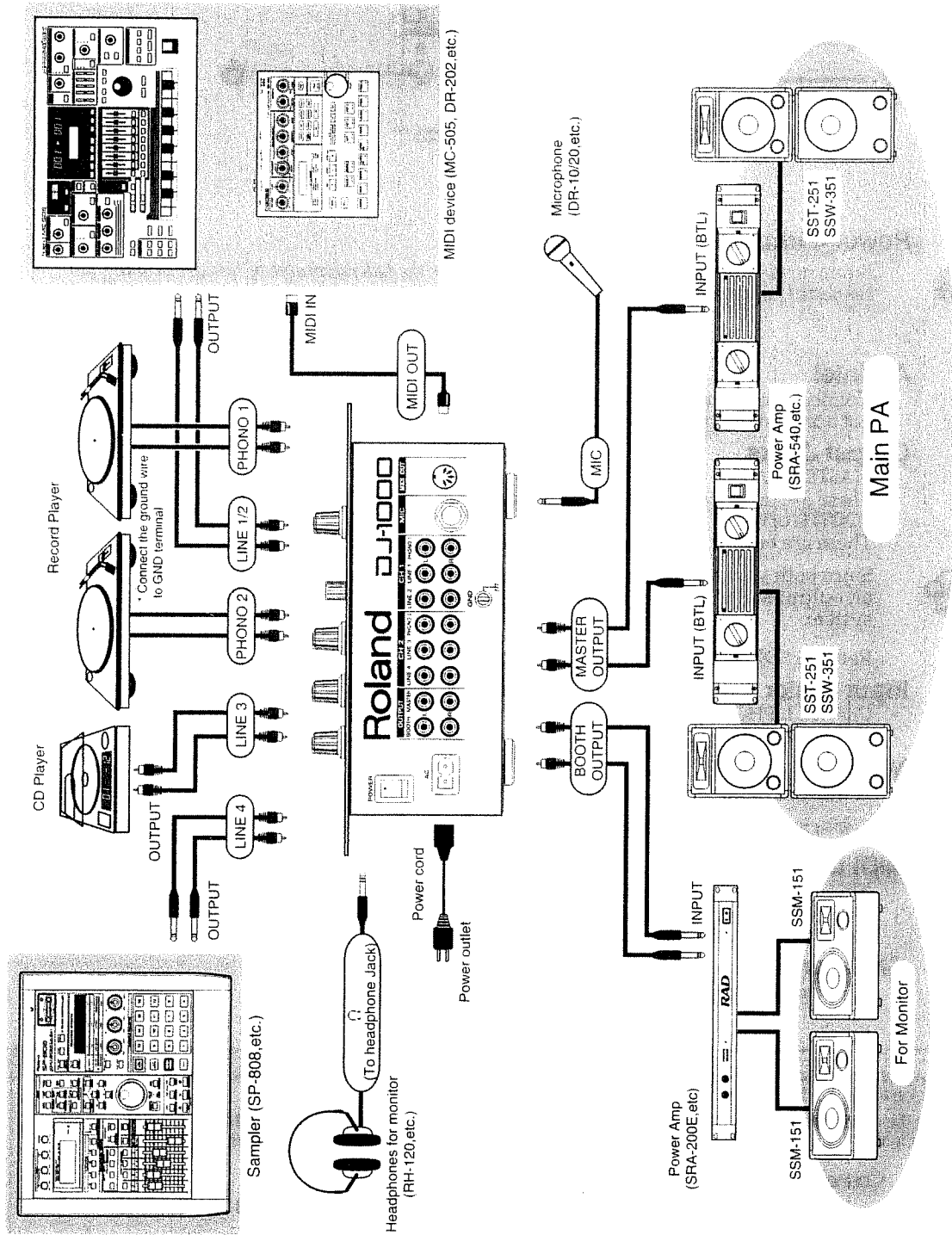

Blank Chart

You may wish to photocopy this page, then use it to jot down your settings.

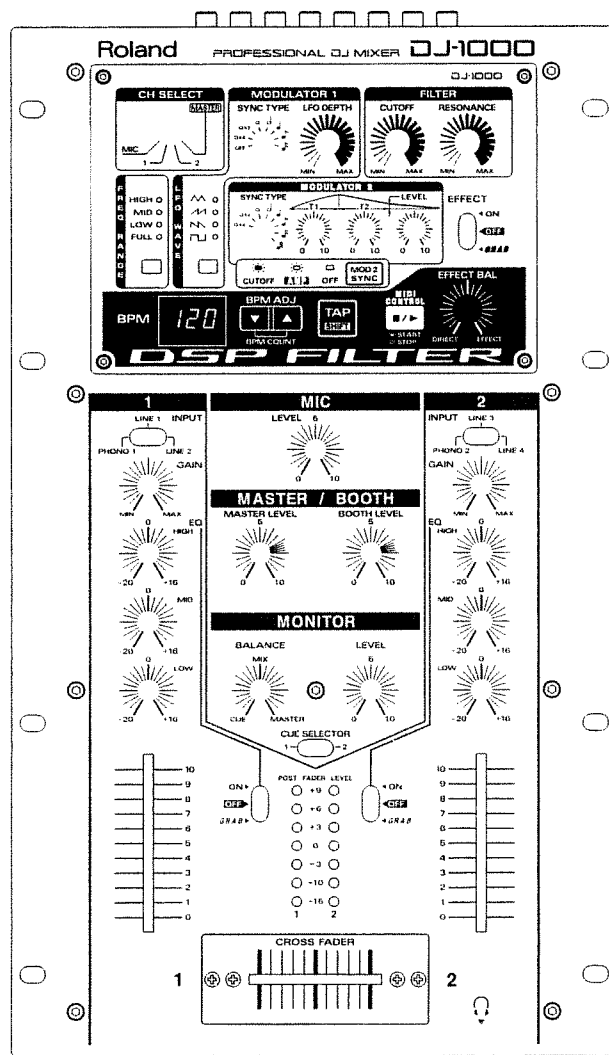
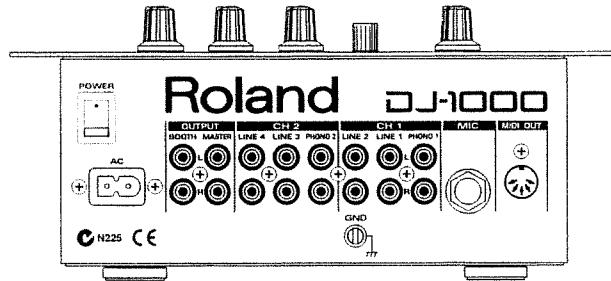

Modifying the Sound in Real Time (DSP Filter)

DSP Filter Section—Names of Things/What They Do

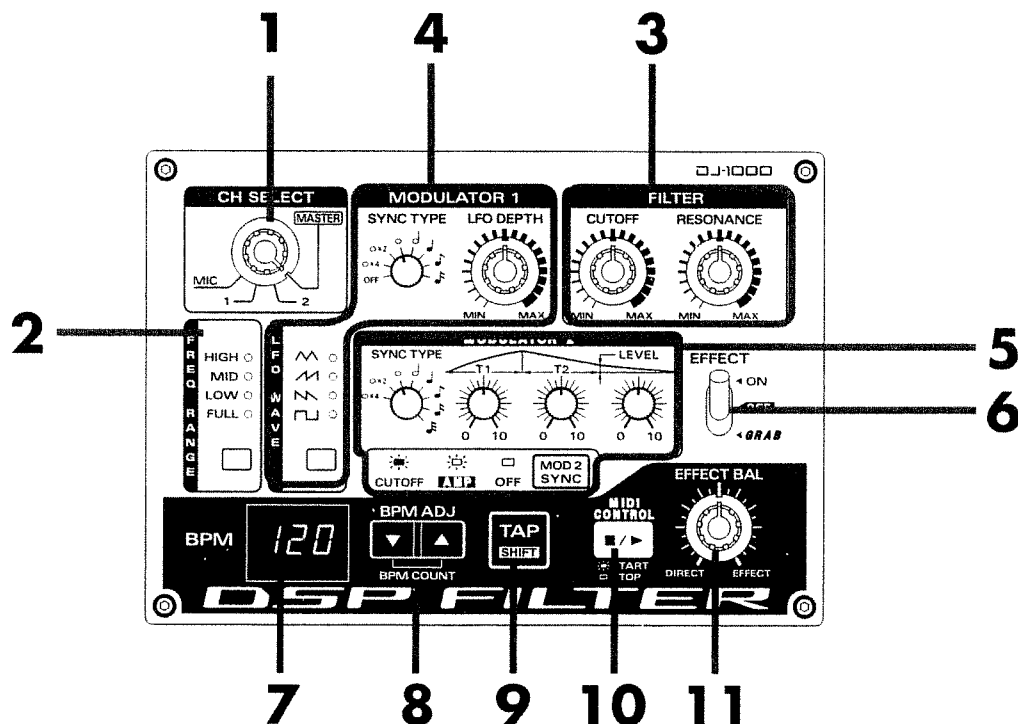

1. CH SELECT (Channel Select) Knob

This knob selects the channel to which the filter will apply.(p. 14,15,16)

2. FREQ RANGE (Frequency Range) Button

This button selects the frequency range to which the filter will be applied.(p. 14,15,16)
Press the button to cycle through the available selections for the frequency range: HIGH, MID, LOW, and FULL.
By holding down [TAP (SHIFT)] while you do this, you can cycle through the frequency range selections in reverse order.

- **HIGH (high frequency range)** --The filter will be applied only to the high-frequency range: e.g., cymbals.
- **MID (mid frequency range)** -----The filter will be applied only to the mid-frequency range: e.g., vocals.
- **LOW (low frequency range)** -----The filter will be applied only to the low-frequency range: e.g., bass, bass drum.
- **FULL (full range)** -----The filter will be applied to all frequency ranges.

3. FILTER Block

Refer to “Modifying the character of the sound (FILTER block)” (p. 14).

4. MODULATOR 1 Block

Refer to “Modulating the sound in sync with the BPM (MODULATOR 1 block)” (p. 15).

5. MODULATOR 2 Block

Refer to “Applying additional change to the sound (MODULATOR 2 block)” (p. 16).

6. GRAB Switch

This is the filter on/off switch. If this is ON, the filter will always be on. When the switch is moved to the GRAB position, the filter will be on only while the switch is held in this position.



The waveform being synchronized to BPM will start at the moment the GRAB switch is ON or moved to the GRAB position.

If you hold down [TAP(SHIFT)] and move this switch to ON or the GRAB position, you can continue without resetting the waveform.

7. BPM Display

This shows the current BPM (tempo). (p. 20)

The decimal point will blink to indicate the beat.

The fractional portion of the BPM value is not displayed. However, the setting can be made to a precision of one decimal place. For details on viewing and setting fractional values, refer to p. 21.

8. BPM ADJ ▼, ▲ Buttons

These buttons allow you to set the BPM (tempo). (p. 20,21,22)

9. TAP Pad

You can set the BPM (tempo) to the same timing you use to tap this pad. (p. 20)

This pad also functions as the SHIFT button when carrying out the following types of settings:

- Switching the [FREQ RANGE] in the reverse order (p. 12)
- Starting without resetting the waveform when turning GRAB on (See the above note.)
- Switching the [LFO WAVE] in the reverse order (p. 15)
- Setting MODULATOR 2 to AMP mode (p. 16)
- Setting the BPM in 0.1 units (p. 21)
- Fine adjusting the playback timing of a MIDI device (p. 21)
- Synchronizing the Start of a MIDI device to quarter-notes (p. 23)

10. MIDI CONTROL Button

This button is used to start/stop an external MIDI device. (p. 23)

11. EFFECT BAL (Effect Balance) Knob

This knob adjusts the balance between the direct signal (unfiltered sound) and effect signal (filtered sound) of the channel selected by CH SELECT (channel select). When it is turned fully counterclockwise, only the direct signal will be output. When it is turned fully clockwise, only the effect signal will be output.



The [FREQ RANGE] (frequency range) setting does not affect the direct signal.

Operating Each Block of the DSP Filter

A “filter” is a type of effect.

It allows you to make drastic changes in the frequency response of the input signal, making the sound brighter or darker, or giving it a distinctive character.

The DSP filter of the DJ-1000 is a low-pass filter (a type of filter that allows the frequency range below the cutoff frequency to pass).

You can make settings in the following three blocks.

FILTER Block

MODULATOR 1 Block

MODULATOR 2 Block

Giving Character to the Sound (FILTER Block)

Procedure

- 1.** Use [CH SELECT] to select the channel to which you wish to apply the effect.
- 2.** Use [FREQ RANGE] to select the frequency range that you wish to modify.
- 3.** Turn the knobs to adjust the effect.

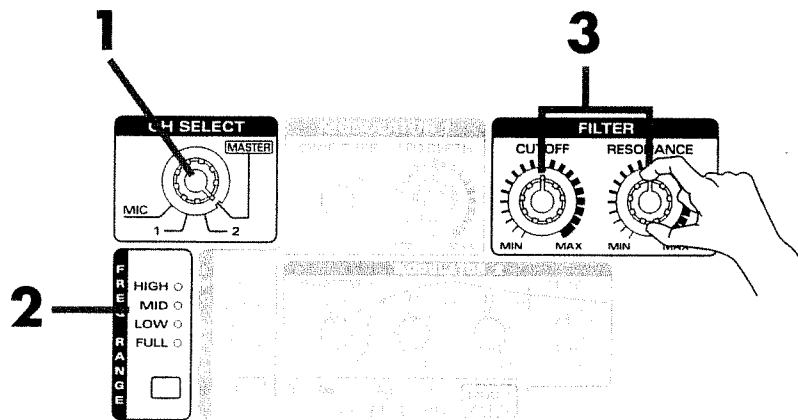

CUTOFF

This knob modifies the cutoff frequency.

The lower (further toward the left) this is set, the more the high range will be cut, producing a darker sound. The range of this knob from MIN to MAX covers 100% of the setting you specify by [FREQ RANGE].



This setting affects MODULATOR 1(P.15) and MODULATOR 2(P.16).

RESONANCE

This specifies how much the gain will be raised in the region of the cutoff frequency. Increasing this value (turning the knob clockwise) will produce a more distinctive sound.

Modulating in Sync with the BPM (MODULATOR 1 Block)

Procedure

1. Use [CH SELECT] to select the channel to which you wish to apply the effect.
2. Use [FREQ RANGE] to select the frequency range at which you wish to apply the effect.
3. Specify the FILTER Block (P.14)
4. Set [LFO WAVE] to select the waveform.
5. Set [SYNC TYPE] to select the beat (note value).
6. Turn [LFO DEPTH] to adjust the effect.

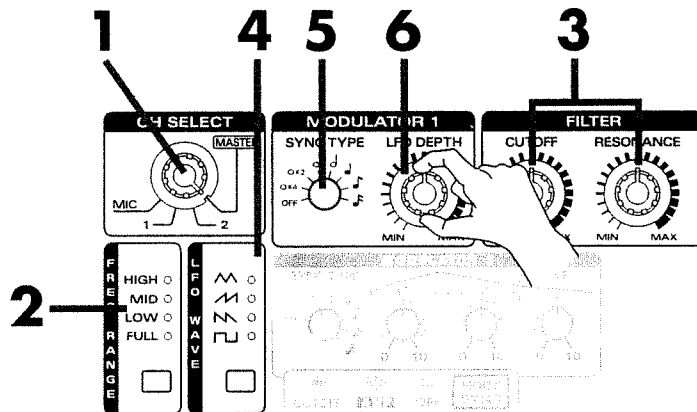

LFO WAVE

Select the shape of the wave (LFO waveform) that will modulate the sound.

Press the button to cycle through the available selections for the waveform: Triangle, Sawtooth, Reversed Sawtooth, and Square.

By holding down [TAP (SHIFT)] while you do this, you can cycle through the waveform selections in reverse order.



Triangle Wave



Sawtooth Wave



Reversed Sawtooth Wave



Square Wave

SYNC TYPE

Select the rate at which the sound will be modulated, in beats (note value). The beats are based on the BPM setting.



If [SYNC TYPE] is in the OFF position, the LFO WAVE and LFO DEPTH settings will be ignored. Use this setting when you wish to Turn [CUTOFF] manually to modify the effect.

LFO DEPTH

Specify the depth of the modulation that will be created by the waveform selected in [LFO WAVE]. Increasing this value (turning the knob clockwise) will produce deeper modulation.

Applying Additional Change to the Sound (MODULATOR 2 Block)

In the MODULATOR 2 block you can freely create a waveform, and produce even more extreme filtering that will be added to the effects of the FILTER and MODULATOR 1.

Procedure

1. Use [CH SELECT] to select the channel to which you wish to apply the effect.
2. Use [FREQ RANGE] to select the frequency range at which the effect will be applied.
3. Specify the FILTER Block (P.14)
4. Select the SYNC mode.

To select CUTOFF mode -----Press [MOD 2 SYNC] (the button will light).

To select AMP mode -----Hold down [TAP (SHIFT)], and press [MOD 2 SYNC] (the button will blink).



When SYNC mode is OFF (the button is dark), the MODULATOR 2 block itself will be off. The settings of the various knobs in the block will be ignored.

5. Set [SYNC TYPE] to select the beat (note value).
6. Turn [T1], [T2], and [LEVEL] to specify the waveform.

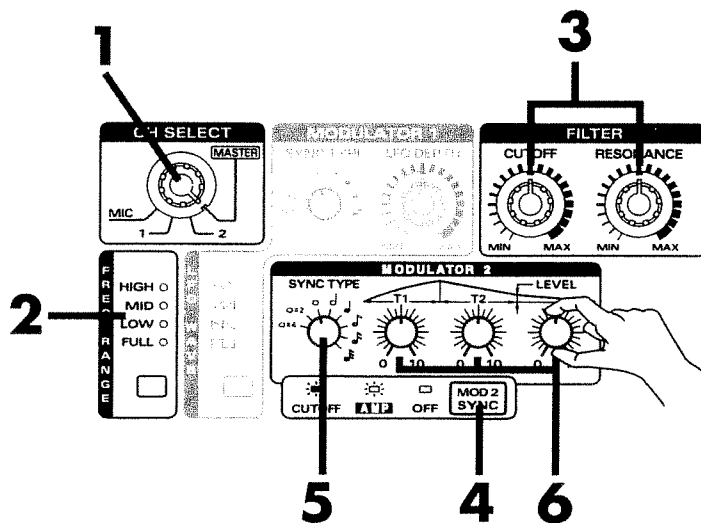

MOD 2 SYNC

This specifies the destination to which MODULATOR 2 will be applied.

CUTOFF mode (button lit) -----The cutoff frequency will be modulated.

AMP mode (button blinking) -----The volume (AMP; amplifier) will be modulated.

SYNC TYPE

Select the rate of the MODULATOR 2 waveform, in beats (note value). The beats are based on the BPM setting.

<When CUTOFF mode is selected>

<When AMP mode is selected>

T1

Specify the time from when the waveform starts until it reaches the cutoff frequency specified in the FILTER block. Turning the knob clockwise will lengthen the time.

Specify the time over which the volume increases from 0 to the maximum. Turning the knob clockwise will lengthen the time.

T2

Specify the time over which the waveform will change from the cutoff frequency to the frequency specified by [LEVEL]. Turning the knob clockwise will lengthen the time.

Specify the time over which the volume will decrease from the maximum volume until the volume specified by [LEVEL] is reached. Turning the knob clockwise will lengthen the time.

LEVEL

Specify the frequency that will be reached after T2 has elapsed.

Specify the volume that will be reached after T2 has elapsed.

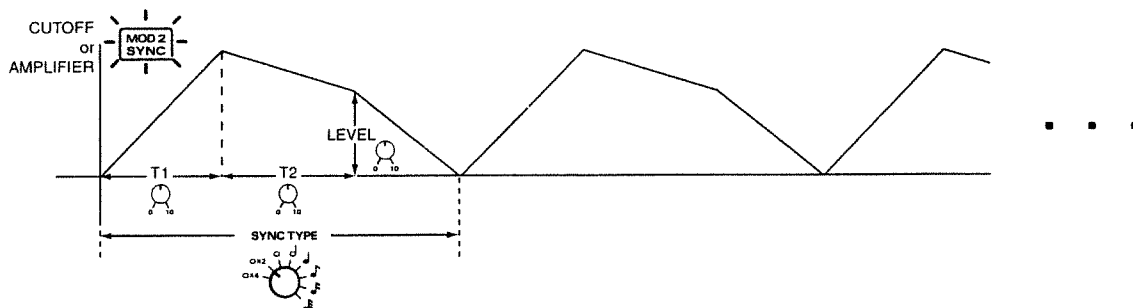

Example of Create Waveform

* * * any kind of value
(T2 and LEVEL are not controlled while T1 is Max.)

Examples of Effective DSP Filter Settings

Basic

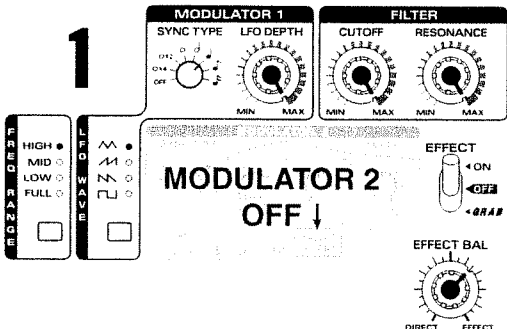

Basic

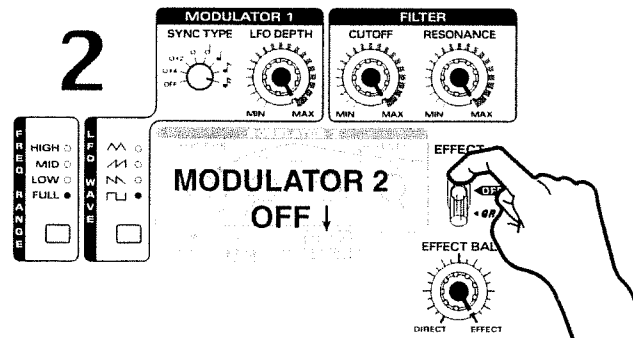

Basic

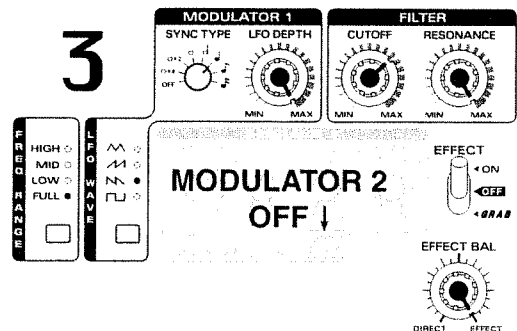

Basic

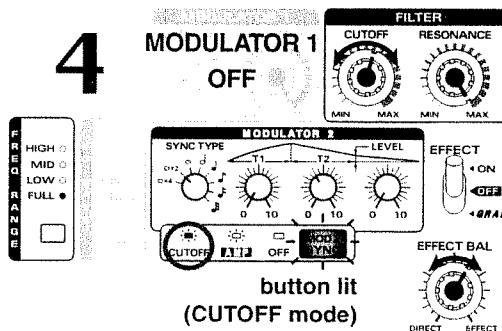

Advance

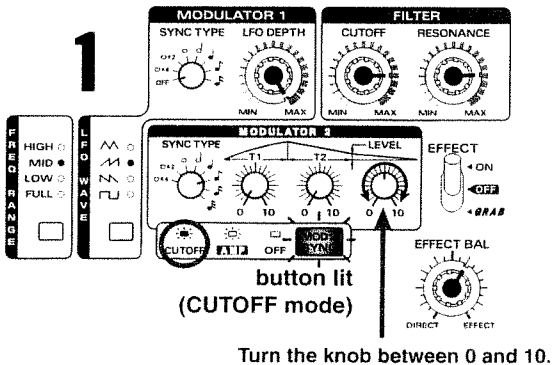

Advance

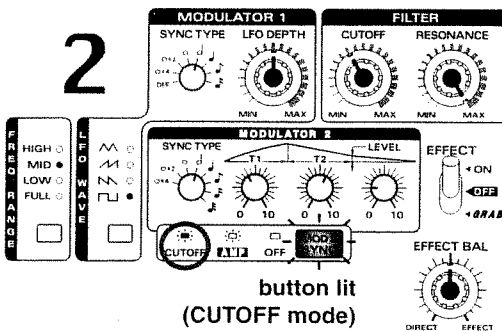

Advance 3

button blinking (AMP mode)

MODULATOR 1 MODULATOR 2

Advance 4

button lit (CUTOFF mode)

MODULATOR 1 MODULATOR 2

Blank Chart For DSP Filter

You may wish to photocopy this page, then use it to jot down your DSP Effects settings.

DJ-1000

CH SELECT MASTER
MIC 1 2

MODULATOR 1
SYNC TYPE LFO DEPTH
CUTOFF RESONANCE

MODULATOR 2
SYNC TYPE L1 L2 LEVEL
CUTOFF MOD 2 SYNC EFFECT

FREQ RANGE HIGH MID LOW FULL
LFO WAVE

EFFECT BAL ON OFF GRAB

BPM ADJ BPM COUNT TAP SHIFT
MIDI CONTROL START STOP DIRECT EFFECT

DSP FILTER

Synchronizing a Record or CD with a MIDI Device (BPM Control)

BPM stands for Beats Per Minute, and indicates the number of quarter notes in one minute. On the DJ-1000, the “BPM setting” and “Synchronization BPM and MIDI device” function allow you to set the BPM from the signal of a connected record or CD, and synchronize a connected MIDI device to this.

NOTE

When the power is turned on, the BPM value will be set to 120.0.

NOTE

The BPM value can be adjusted in the range of 40.0–240.0. (The range of automatic detection is 90.0–180.0.)

Setting BPM

BPM can be set in one of the following three ways.

1. **Strike the Pad at the Desired Tempo (TAP)**
2. **Manual Settings (BPM ADJ)**
3. **Automatic Detection (BPM COUNT)**

1. Strike the Pad at the Desired Tempo (TAP)

If you strike [TAP] four times or more at the desired tempo (quarter note base), the BPM will be calculated automatically. The value will be displayed in the BPM display.

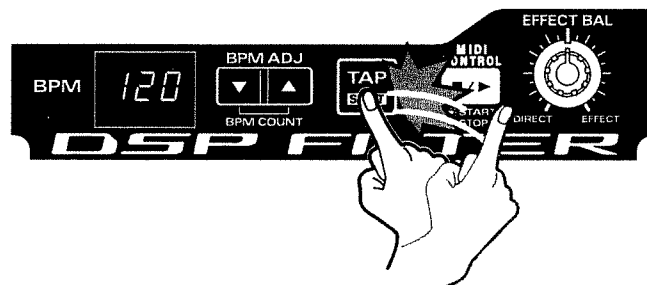

2. Manual Settings (BPM ADJ)

If you know the desired BPM value or if you wish to make a fine adjustment, you can set BPM manually. Each time you press [BPM ADJ ▼] or [BPM ADJ ▲], the value will change in units of 1 BPM.

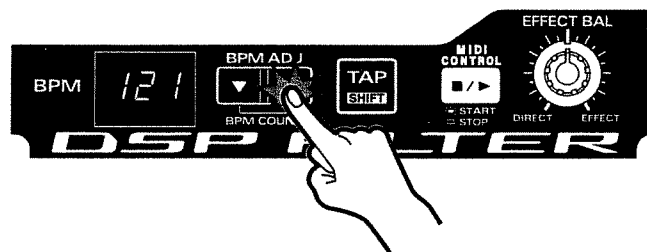

By holding down [TAP (SHIFT)] while you do this, you can view and set the BPM in units of 0.1 BPM. In this case, the BPM display will be shifted one place to the left, and the decimal point and one decimal place will be displayed.

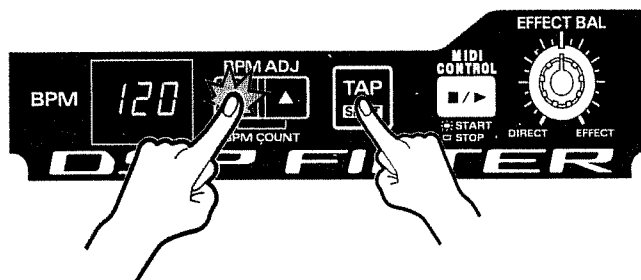

ex. BPM = 120.1



Fine adjusting the Playback Timing of the MIDI Device

When using a BPM value detected from a CD player or record player to synchronize a MIDI device for an extended period, slight discrepancies in timing may occur due to limitations in the precision of the BPM setting, or due to the “wow” or “flutter” of the record player. In such cases, you can make minute adjustments in the playback timing of the MIDI device without changing the BPM that was set.

1. While holding down [TAP (SHIFT)], simultaneously press [BPM ADJ ▼] and [BPM ADJ ▲]. (The display will indicate “P - -”)

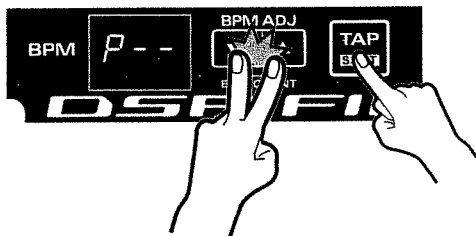

2. With [TAP (SHIFT)] held down, the following can be carried out to adjust the timing of notes played on the MIDI device.

Hold down [TAP (SHIFT)] and press [BPM ADJ ▼]: The playback timing of the MIDI device will be shifted backward. (The display will indicate “P _ _”)

Hold down [TAP (SHIFT)] and press [BPM ADJ ▲]: The playback timing of the MIDI device will be shifted forward. (The display will indicate “P - -”)

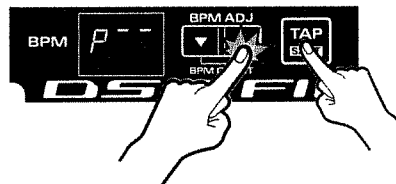
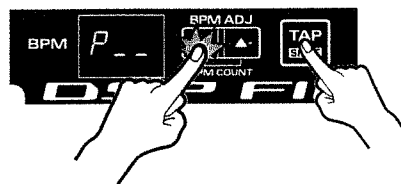

3. Automatic Detection (BPM COUNT)

The BPM can be detected automatically from the low-frequency components of a song played on an external device (record player, CD player, etc.).

1. Simultaneously press [BPM ADJ ▼] and [BPM ADJ ▲].

The BPM will be detected automatically for the signal selected by Channel Select.

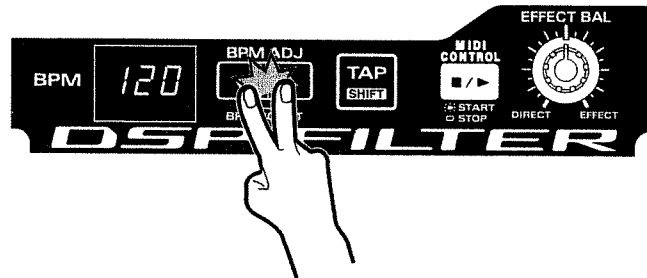

During this process, the BPM display will show the following.

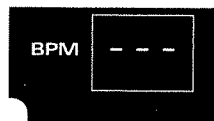

2. When the calculation has been completed, the BPM value will appear in the BPM display.

- The detection succeeded: The BPM display will show the correct value after flashing a few times.
- The detection failed: The BPM display will show the same value as before detection, without flashing.

NOTE

For accurate detection

If the input level of the selected channel is inappropriate, the following display will appear.



The input level is too high.

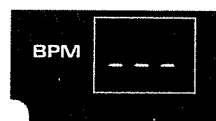

The input level is too low.

Use [GAIN] to adjust the level appropriately, and perform the automatic detection once again. Try to get it so the "0" position on the level meter just barely lights up while you have the channel fader at the maximum level (at 10).

NOTE

BPM values in the range of 90.0–180.0 can be detected automatically.

NOTE

For some types of signal or musical style, it may be impossible to accurately determine the BPM.

Playing a MIDI Device at the Specified BPM (Synchronizing BPM and a MIDI Device)

Here's how you can play a connected MIDI device at the specified BPM.

The DJ-1000 transmits timing clock messages (system realtime messages) synchronized to the BPM value via its MIDI OUT connector. In addition, you can use [MIDI CONTROL] to transmit start/stop (system realtime messages).

By connecting the MIDI OUT of the DJ-1000 to a MIDI device that is able to receive system realtime messages, the MIDI device can be synchronized to the BPM setting of the DJ-1000, and can be started and stopped remotely.

1. **Connect the MIDI OUT of the DJ-1000 to the MIDI IN of your sequencer, rhythm machine, etc.**

NOTE Set the Sync mode of the connected MIDI device to SLAVE.

NOTE A MIDI device that does not receive system realtime messages cannot be synchronized.

2. **Press [MIDI CONTROL] to start/stop the MIDI device.**

When the button is dark, pressing [MIDI CONTROL] will start the MIDI device, and the button will light. When the button is lit, pressing it will stop the MIDI device, and the button will go dark.

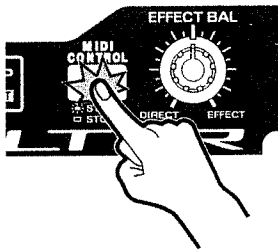

Starting the MIDI Device at Quarter-Note Timing

The MIDI device can be started at precise quarter-note timing.

1. Hold down [TAP (SHIFT)] and press [MIDI CONTROL].
2. The MIDI device will start at the next quarter note after you pressed [MIDI CONTROL].

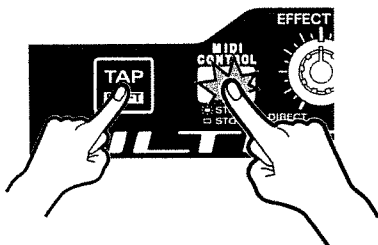

Replacing the Cross Fader

The Cross Fader is replaceable. If you begin to notice noise when the fader is moved, or if it no longer works as expected, or its action becomes unpredictable, replace with the Cross Fader for replacing the DJ-1000(CFX-1).

When replacing the Cross Fader, remove only the two outer screws holding it in place. Make sure to switch off the power, and pull the plug from the outlet before beginning.



To avoid the risk of damage to internal components that can be caused by static electricity, please carefully observe the following whenever you handle the board.

When handling the cross fader panel, grasp it only by its edges. Avoid touching any of the electronic components, the printed circuit pathways or connection terminals.



Never use excessive force when installing a connector. If it doesn't fit properly on the first attempt, remove the connector and try again.



To avoid injury, be very careful around the opening's edges and near the circuit board.

Unscrew and remove only the two outer screws.

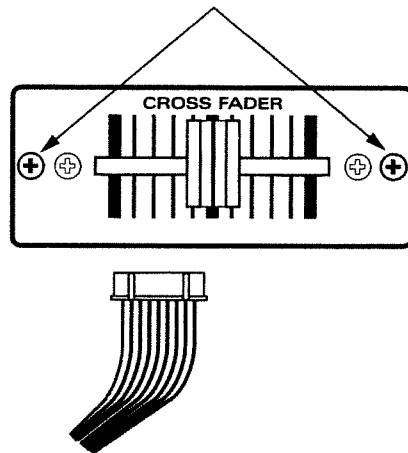

Procedure

- 1.** Switch off the power to the unit, and pull the plug from the outlet.
- 2.** Unscrew and remove only the two outer Cross Fader attachment screws.
- 3.** Unfasten the connector from the Cross Fader unit.
- 4.** Plug the connector into the new Cross Fader unit.
- 5.** Replace and fasten the unit as before.



When circuit board installation is complete, double-check your work.



When you wish to purchase the Cross Fader for replacing the DJ-1000 (CFX-1), please ask the retailer shop where you bought this unit.

Troubleshooting

If there is no sound or if the unit does not operate as you expect, please check the following points first. If this does not resolve the problem, contact the nearest Roland service center or authorized Roland distributor.

No Sound

- Check the positions of the channel faders, cross fader, and the various volume controls.
- Make sure that the INPUT select switch is selecting the device that is connected.(INPUT select switch→p. 6)
- Make sure that none of the MODULATOR 2 parameters—[T1], [T2], and [LEVEL]—is set to 0.(MODULATOR 2→p. 16)

Noise Occurs

- Noise may occur if the unit is operated immediately (within approximately ten seconds) after the power is turned on, but this is not a malfunction.

Sound is distorted

- Use [GAIN] to adjust the input level once again.Try to get it so the "0" position on the level meter just barely lights up while you have the channel fader at the maximum level (at 10). ([GAIN]→p. 6)

DSP Filter Does Not Work

- The DSP filter affects the channel that is selected by [CH SELECT]. Make sure that you have selected the channel that you wish to modify.([CH SELECT]→p. 12)
- Make sure that [EFFECT BAL] is not positioned at the far left (DIRECT: the sound unprocessed by the effects).([EFFECT BAL]→p. 13)
- Make sure that the DSP filter [GRAB] switch is ON or being held in the GRAB position.([GRAB] switch→p. 13)
- Make sure that the MODULATOR 1 parameter SYNC TYPE is not turned OFF.(MODULATOR 1 parameter SYNC TYPE→p. 15)
- Make sure that the MODULATOR 1 knob LFO DEPTH is not turned to MIN (far left).(MODULATOR 1 knob LFO DEPTH→p. 15)
- Make sure that the MODULATOR 2 mode is not turned OFF. For [MOD2 SYNC], select either CUTOFF or AMP mode. ([MOD2 SYNC]→p. 16)
- The MODULATOR 2 knob T2 and LEVEL are not controlled while T1 is Max(10). (T1,T2,LEVEL Knob→p. 17)

A Range Other Than the Selected Frequency Range (FREQ RANGE) Can be Heard

- The frequency range setting does not affect the direct signal. Even if [FREQ RANGE] is set to a range other than FULL (full range)—i.e., even if it is set to HIGH/MID/LOW—the FULL (full range) direct sound will be output if [EFFECT BAL] is turned to the left (DIRECT).

BPM Cannot be Detected Automatically

- Automatic BPM detection is performed on the channel that is selected by [CH SELECT]. Make sure that you have selected the correct channel.([CH SELECT]→p. 12)
- Detection may not be possible if the input level of the channel is set inappropriately. Use [GAIN] to adjust the input level, and try automatic detection once again.Try to get it so the "0" position on the level meter just barely lights up while you have the channel fader at the maximum level (at 10). ([GAIN]→p. 6)(For accurate detection→p. 22)
- For some types of signal or musical style, it may be impossible to accurately determine the BPM.

A Connected MIDI Instrument Does not Start

- Make sure that the MIDI OUT of the DJ-1000 is correctly connected to the MIDI IN of the other MIDI device.
- If you are using [MIDI CONTROL] to start/stop the other MIDI device, set its sync mode to Slave.
- It is not possible to synchronize a MIDI device that does not support system realtime messages.

Specifications/Input and Output Standards

Specifications

- Frequency Response
20 Hz to 20 kHz -1/+1 dB (gain: min)
- Total Harmonic Distortion
0.28 % or less
(gain: min, 20 Hz to 20 kHz at Rated output)
- S/N Ratio
73 dB (input terminated with 150 ohms, IHF-A, typ.)
- Crosstalk
-70 dB or less (1 kHz, between channels)
-64 dB or less (1 kHz, between L and R)
- Equalizer
HIGH: -20 to +16 dB (10 kHz, peaking type)
MID: -20 to +16 dB (1 kHz, peaking type)
LOW: -20 to +16 dB (25 Hz, peaking type)
- Power Supply
AC 117 V, AC 230 V or AC 240 V
- Power Consumption
25 W
- Dimensions
244.0 (W) x 436.4 (D) x 112.0 (H) mm
9-5/8 (W) x 17-3/16 (D) x 4-7/16 (H) inches
- Weight
5.3 kg/11 lbs-11oz
- Accessories
Power cord
Owner's Manual

* In the interest of product improvement, the specifications and/or appearance of this unit are subject to change without prior notice.

Input and Output Standard

Input Standard

Input Socket	Rated Input Level	Non-Clip Max, Input	Input Impedance	Type of Connectors
LINE 1 - 4	-20 dBm (77.5 mV) (GAIN = max)	0 dBm (775 mV) (GAIN = max)	33 k ohms	RCA
	+ 4 dBm (1.23 V) (GAIN = min)	+20 dBm (77.5 mV) (GAIN = min)		
PHONO 1 - 2	-55 dBm (1.38 mV) (GAIN = max)	-35 dBm (13.8 mV) (GAIN = max)	50 k ohms	RCA
	-31 dBm (22 mV) (GAIN = min)	-15 dBm (138 mV) (GAIN = min)		
MIC	-50 dBm (2.45 mV)	-10 dBm (245 mV)	2.8 k ohms	1/4" TRS PHONE (UNBAL)

Output Standard

Output Socket	Rated Output Level	Non-Clip Max, Output	Output Impedance	Type of Connectors
MASTER OUT	0 dBm (0.775 V)	+20 dBm (7.75 V)	300 ohms	RCA
BOOTH OUT	0 dBm (0.775 V)	+20 dBm (7.75 V)	300 ohms	RCA
PHONES	-----	1W + 1W *1	10 ohms	1/4" STEREO PHONE

0dBm = 0.775 Vrms

*1 : Both Channels 33 ohms Loaded

Block Diagram

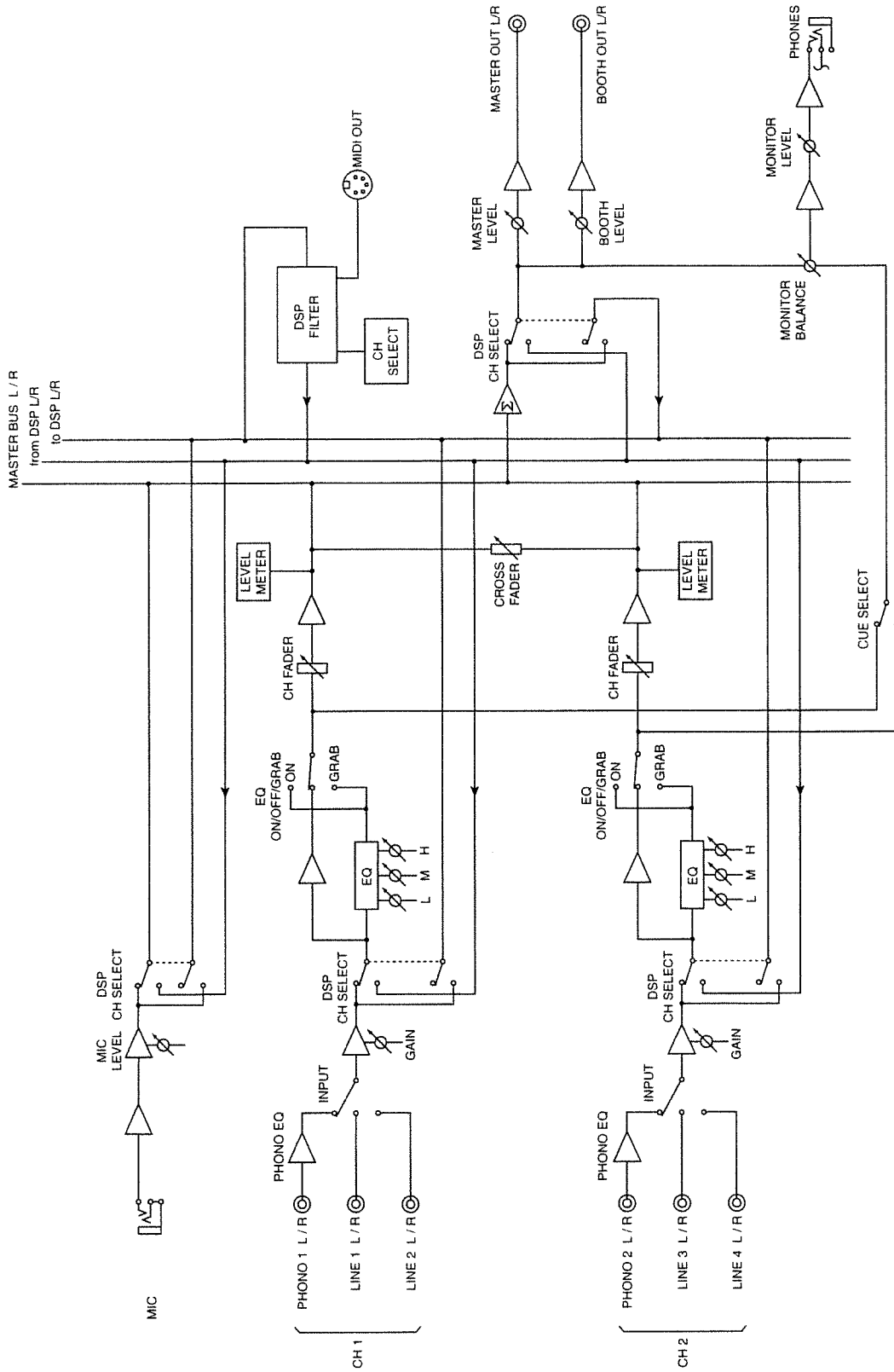

MIDI Implementation

Model: DJ-1000 (Professional DJ Mixer) Data: Dec.26.1998 Version: 1.00

1. Transmit Data

1.1 Created messages

- System Realtime messages

- Active Sensing

Status

FEH

** This will be transmitted constantly at intervals of approximately 240 ms.*

1.2 Created messages for synchronization

- System Realtime messages

- Timing Clock

Status

F8H

** This will be transmitted constantly at intervals of the specified BPM.*

- Start

Status

FAH

** Transmitted with pressing the [MIDI CONTROL] button when its light is off.*

- Stop

Status

FCH

** Transmitted with pressing the [MIDI CONTROL] button when its light is on.*

MIDI Implementation Chart

Professional DJ Mixer
Model DJ-1000

MIDI Implementation Chart

Date : Dec. 26, 1998
Version : 1.00

Function...	Transmitted	Recognized	Remarks
Basic Default Channel Changed	x x	x x	
Mode Default Messages Altered	x x *****	x x	
Note Number : True Voice	x *****	x x	
Velocity Note ON Note OFF	x x	x x	
After Key's Touch Ch's	x x	x x	
Pitch Bend	x	x	
Control Change	x	x	
Prog Change : True #	x *****	x *****	
System Exclusive	x	x	
System : Quarter Frame Common : Song Position : Song Select : Tune	x x x x	x x x x	
System : Clock Real Time : Commands	O O	x x	
Aux : All sound off Message : Reset all controllers : Local ON/OFF : All Notes OFF : Active Sense : System Reset	x x x x O x	x x x x x x	
Notes			

Mode 1 : OMNI ON, POLY
Mode 3 : OMNI OFF, POLY

Mode 2 : OMNI ON, MONO
Mode 4 : OMNI OFF, MONO

O : Yes
X : No

Index

A

AC Inlet	9
AMP mode	16
Automatic Detection (BPM COUNT)	22

B

BALANCE Knob (MONITOR)	7
Blank Chart	11
Blank Chart For DSP Effect	19
Block Diagram	27
BOOTH (L/R)	9
BOOTH Knob	7
BPM	20
BPM ADJ	20
BPM ADJ Buttons	13, 20–22
BPM Display	13

C

CH SELECT	14–16
CH SELECT (Channel Select) Knob	12
Channel Faders	7
Channel Select	12
Cross-Fader	8
CUE SELECTOR Switch (MONITOR)	7
CUTOFF	14
CUTOFF mode	16

D

Dedicated Mic Input Channel LEVEL Knob	7
DJ System Examples	10
DSP Filter Section	12

E

EFFECT BAL (Effect Balance) Knob	13
EQ (Equalizer Knobs)	6
Examples of Effective DSP Filter Settings	18

F

FILTER Block	14
FREQ RANGE	14–15
FREQ RANGE (Frequency Range) Button	12
Frequency Range	12

G

GAIN	6, 22
GND Terminal	9
GRAB Switch (DSP Filter Section)	13
GRAB Switch (EQ)	7

H

Headphone Jack	8
----------------------	---

I

Input and Output Standards	26
Input Jacks	9
INPUT Select Switches	6

L

LEVEL knob (MODULATOR 2)	17
LEVEL Knob (MONITOR)	7

Level Meters	7
LFO DEPTH	15
LFO WAVE	15

M

Manual Settings (BPM ADJ)	20
MASTER (L/R)	9
MASTER/BOOTH Knobs	7
Mic Input Jack	9
MIDI CONTROL	23
MIDI CONTROL Button	13, 23
MIDI Implementation	28
MIDI Implementation Chart	29
MIDI OUT Connector	9
MOD 2 SYNC	16
MODULATOR 1 Block	15
MODULATOR 2 Block	16

O

Output Jacks	9
--------------------	---

P

Power Switch	9
--------------------	---

R

Rear Panel	9
Replacing the Cross Fader	24
RESONANCE	14

S

Setting BPM	20
SHIFT Button	12–13, 15–16, 21, 23
Specifications	26
SYNC mode	16
SYNC TYPE	15–16
Synchronizing BPM and a MIDI Device	23
System Examples	10

T

T1 knob	17
T2 knob	17
TAP	20
TAP Pad	13
TAP Pad (SHIFT)	13

Information

When you need repair service, call your nearest Roland Service Center or authorized Roland distributor in your country as shown below.

ARGENTINA

Instrumentos Musicales S.A.
Florida 656 2nd Floor
Office Number 206A
Buenos Aires
ARGENTINA, CP1005
TEL: (54-1) 794-6057

BRAZIL

Roland Brasil Ltda.
R. Coronel Octaviano da Silveira
213 05522-010
Sao Paulo BRAZIL
TEL: (011) 843 9377

CANADA

Roland Canada Music Ltd.
(Head Office)
5480 Parkwood Way Richmond
B. C. V6V 2M4 CANADA
TEL: (604) 270 6626

Roland Canada Music Ltd.
(Toronto Office)

Unit 2, 109 Woodbine Downs
Blvd, Etobicoke, ON
M9W 6Y1 CANADA
TEL: (416) 213 9707

MEXICO

Casa Veerkamp, s.a. de c.v.
Av. Toluca No. 325 Col. Olivar de
los Padres 01780 Mexico D.F.
MEXICO
TEL: (525) 668 04 80

**La Casa Wagner de
Guadalajara s.a. de c.v.**

Av. Corona No. 202 S.J.
Guadalajara, Jalisco Mexico
C.P. 44100 MEXICO
TEL: (03) 613 1414

PANAMA

Productos Superiores, S.A.
Apartado 655 - Panama 1
REP. DE PANAMA
TEL: (507) 270-2200

U. S. A.

Roland Corporation U.S.
7200 Dominion Circle
Los Angeles, CA. 90040-3696,
U. S. A.
TEL: (0213) 685 5141

VENEZUELA

Musicland Digital C.A.
Av. Francisco de Miranda,
Centro Parque de Cristal, Nivel
C2 Local 20 Caracas
VENEZUELA
TEL: (02) 285 9218

AUSTRALIA

**Roland Corporation
Australia Pty. Ltd.**
38 Campbell Avenue
Dee Why West, NSW 2099
AUSTRALIA
TEL: (02) 9982 8266

NEW ZEALAND

Roland Corporation (NZ) Ltd.
97 Mt. Eden Road, Mt. Eden,
Auckland 3, NEW ZEALAND
TEL: (09) 3098 715

CHINA

**Beijing Xinghai Musical
Instruments Co., Ltd.**
6 Huangmichang Chao Yang
District, Beijing, CHINA
TEL: (010) 6774 7491

HONG KONG

**Tom Lee Music Co., Ltd.
Service Division**
22-32 Pun Shan Street, Tsuen
Wan, New Territories,
HONG KONG
TEL: 2415 0911

INDIA

Rivera Digitec (India) Pvt. Ltd.
409, Nirman Kendra,
off Dr. Edwin Moses Road,
Mumbai 400011, INDIA
TEL: (022) 498 3079

INDONESIA

PT Galestra Inti
Kompleks Perkantoran
Duta Merlin Blok E No.6—7
Jl. Gajah Mada No.3—5,
Jakarta 10130,
INDONESIA
TEL: (021) 6335416

KOREA

**Cosmos Corporation
Service Station**
201 2nd Floor Nak-Won Arcade
Jong-Ro ku, Seoul, KOREA
TEL: (02) 742 8844

MALAYSIA

Bentley Music SDN BHD
140 & 142, Jalan Bukit Bintang
55100 Kuala Lumpur, MALAYSIA
TEL: (03) 2443333

PHILIPPINES

G.A. Yupangco & Co. Inc.
339 Gil I. Puyat Avenue
Makati, Metro Manila 1200,
PHILIPPINES
TEL: (02) 899 9801

SINGAPORE

Swee Lee Company
150 Sims Drive,
Singapore 387381
TEL: 784-1669

CRISTOFORI MUSIC PTE LTD

Blk 3014, Bedok Industrial Park E,
#02-2148, SINGAPORE 489980
TEL: 243 9555

TAIWAN

**ROLAND TAIWAN
ENTERPRISE CO., LTD.**
Room 5, 9th, No. 112 Chung Shan
N.Road Sec.2, Taipei, TAIWAN,
R.O.C.
TEL: (02) 2561 3339

THAILAND

Theera Music Co., Ltd.
330 Veng Nakorn Kasem, Soi 2,
Bangkok 10100, THAILAND
TEL: (02) 2248821

VIETNAM

**Saigon Music Distributor
(Tan Dinh Music)**
306 Hai Ba Trung, District 1
Ho chi minh City
VIETNAM
TEL: (8) 829-9372

BAHRAIN

Moon Stores
Bab Al Bahrain Road,
P.O.Box 20077
State of BAHRAIN
TEL: 211 005

ISRAEL

**Halilit P. Greenspoon &
Sons Ltd.**
8 Retzif Fa'aliya Hashnya St
Tel-Aviv-Yahio ISRAEL
TEL: (03) 682366

JORDAN

AMMAN Trading Agency
Prince Mohammed St. P. O. Box
825 Amman 11118 JORDAN
TEL: (06) 4641200

KUWAIT

Easa Husain Al-Yousifi
P.O. Box 126 Safat 13002
KUWAIT
TEL: 5719499

LEBANON

A. Chahine & Fils
P.O. Box 16-5857 Gergi Zeidan St.
Chahine Building, Achrafieh
Beirut, LEBANON
TEL: (01) 335799

OMAN

**OHI Electronics & Trading
Co. LLC**
P. O. Box 889 Muscat
Sultanate of OMAN
TEL: 959085

QATAR

Badie Studio & Stores
P.O.Box 62,
DOHA QATAR
TEL: 423554

SAUDI ARABIA

**Abdul Latif S. Al-Ghamdi
Trading Establishment**
Middle East Commercial Center
Al-Khobar Dharan Highway
P.O. Box 3631 Al-Khobar
31952 SAUDI ARABIA
TEL: (03) 898 2332

**aDawlah Universal
Electronics APL**

P.O.Box 2154 ALKHOBAR 31952,
SAUDI ARABIA
TEL: (03) 898 2081

SYRIA

**Technical Light & Sound
Center**
Khaled Ibn Al Walid St.
P.O.Box 13520
Damascus - SYRIA
TEL: (011) 2235 384

TURKEY

**Barkat Muzik aletleri ithalat
ve ihracat limited ireketi**
Siraselvler Cad. Guney Ishani No.
86/6 Taksim, Istanbul TURKEY
TEL: (0212) 2499324

U.A.E

**Zak Electronics & Musical
Instruments Co.**
Zabeel Road, Al Sherouq Bldg.,
No. 14, Grand Floor DUBAI
U.A.E.
P.O. Box 8050 DUBAI, U.A.E
TEL: (04) 360715

EGYPT

Al Fanny Trading Office
P.O.Box 2904,
El Horrieh Heliopolis, Cairo,
EGYPT
TEL: (02) 4171828
(02) 4185531

KENYA

Musik Land Limited
P.O.Box 12183 Moi Avenue
Nairobi Republic of KENYA
TEL: (2) 338 346

REUNION

Maison FO - YAM Marcel
25 Rue Jules Mermet
Chaudron - BP79 97491
Ste Clotilde REUNION
TEL: 28 29 16

SOUTH AFRICA

**That Other Music Shop
(PTY) Ltd.**
11 Melle Street (Cnr Melle and
Juta Street)
Braamfontein 2001
Republic of SOUTH AFRICA
TEL: (011) 403 4105

Paul Bothner (PTY) Ltd.
17 Werdmuller Centre Claremont
7700
Republic of SOUTH AFRICA
TEL: (021) 64 4030

AUSTRIA

E. Dematte & Co.
Neu-Rum Siemens-Strasse 4
6063 Innsbruck AUSTRIA
TEL: (0512) 26 44 260

BELGIUM/HOLLAND/ LUXEMBOURG

Roland Benelux N. V.
Houtstraat 3 B-2260 Oevel
(Westerlo) BELGIUM
TEL: (014) 575811

BELORUSSIA TUSHE

U.L. Rabkorovskaya 17
220001 MINSK
TEL: (0172) 764-911

CYPRUS

Radex Sound Equipment Ltd.
17 Diagorou St., P.O.Box 2046,
Nicosia CYPRUS
TEL: (02) 453 426

DENMARK

Roland Scandinavia A/S
Langebrogade 6 Post Box 1937
DK-1023 Copenhagen K,
DENMARK
TEL: 32 95 3111

FRANCE

Roland France SA
4, Rue Paul Henri SPAAK
Parc de l'Esplanade F 77 462 St.
Thibault Lagny Cedex FRANCE
TEL: 01 600 73 500

FINLAND

**Roland Scandinavia As,
Filial Finland**
Lauttasaarentie 54 B
Fin-00201 Helsinki, FINLAND
TEL: (9) 682 4020

GERMANY

**Roland Elektronische
Musikinstrumente
Handelsgesellschaft mbH.**
Oststrasse 96, 22844 Norderstedt,
GERMANY
TEL: (040) 52 60090

GREECE

V. Dimitriadis & Co. Ltd.
20, Alexandras St. & Bouboulinas
54 St. 106 82 Athens, GREECE
TEL: (01) 8232415

HUNGARY

Intermusica Ltd.
Warehouse Area DEPO Pf.83
H-2046 Torokbalint, HUNGARY
TEL: (23) 511011

IRELAND

**The Dublin Service Centre
Audio Maintenance Limited**
11 Brunswick Place Dublin 2
Republic of IRELAND
TEL: (01) 677322

ITALY

Roland Italy S. p. A.
Viale delle Industrie, 8
20020 Arese Milano, ITALY
TEL: (02) 937-78300

NORWAY

**Roland Scandinavia Avd.
Kontor Norge**
Lilleakerveien 2 Postboks 95
Lilleaker N-0216 Oslo
NORWAY
TEL: 273 0074

POLAND

P. P. H. Brzostowicz Marian
U.L. Blokowa 32, 03624 Warszawa
POLAND
TEL: (022) 679 44 19

PORTUGAL

**Tecnologias Musica e Audio,
Roland Portugal, S.A.**
RUA SANTA CATARINA
131 - 4000 Porto -PORTUGAL
TEL: (02) 208 44 56

RUSSIA

Slami Music Company
Sadajava-Triumfalnaja St., 16
103006 Moscow, RUSSIA
TEL: 095 209 2193

SPAIN

**Roland Electronics
de España, S. A.**
Calle Bolivia 239 08020 Barcelona,
SPAIN
TEL: (93) 308 1000

SWEDEN

**Roland Scandinavia A/S
SWEDISH SALES OFFICE**
Danvik Center 28, 2 tr
S-131 30 Nacka SWEDEN
TEL: (08) 702 0020

SWITZERLAND

**Roland (Switzerland) AG
Musitronic AG**
Gerberstrasse 5, CH-4410 Liestal,
SWITZERLAND
TEL: (061) 921 1615

UKRAINE

TIC-TAC
Mira Str. 19/108
P.O.Box 180
295400 Munkachevo, UKRAINE
TEL: (03131) 414-40

UNITED KINGDOM

Roland (U.K.) Ltd.
Atlantic Close, Swansea
Enterprise Park SWANSEA
West Glamorgan SA7 9FL,
UNITED KINGDOM
TEL: (01792) 700139

UPC 71238989



18981



For EU Countries

This product complies with the requirements of European Directives EMC 89/336/EEC and LVD 73/23/EEC.

For the USA

FEDERAL COMMUNICATIONS COMMISSION RADIO FREQUENCY INTERFERENCE STATEMENT

This equipment has been tested and found to comply with the limits for a Class B digital device, pursuant to Part 15 of the FCC Rules. These limits are designed to provide reasonable protection against harmful interference in a residential installation. This equipment generates, uses, and can radiate radio frequency energy and, if not installed and used in accordance with the instructions, may cause harmful interference to radio communications. However, there is no guarantee that interference will not occur in a particular installation. If this equipment does cause harmful interference to radio or television reception, which can be determined by turning the equipment off and on, the user is encouraged to try to correct the interference by one or more of the following measures:

- Reorient or relocate the receiving antenna.
- Increase the separation between the equipment and receiver.
- Connect the equipment into an outlet on a circuit different from that to which the receiver is connected.
- Consult the dealer or an experienced radio/TV technician for help.

Unauthorized changes or modification to this system can void the users authority to operate this equipment.
This equipment requires shielded interface cables in order to meet FCC class B Limit.

For Canada

NOTICE

This Class B digital apparatus meets all requirements of the Canadian Interference-Causing Equipment Regulations.

AVIS

Cet appareil numérique de la classe B respecte toutes les exigences du Règlement sur le matériel brouilleur du Canada.