

# DB-88

# Dr. Beat

Owner's Manual

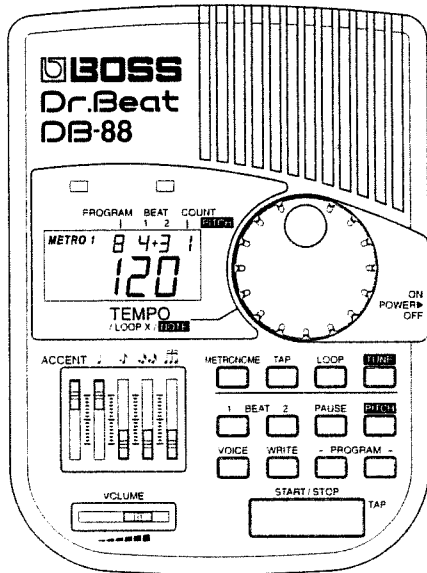

Thank you for purchasing the BOSS DB-88 Dr. Beat.

Before using this unit, carefully read the sections entitled: "USING THE UNIT SAFELY" and "IMPORTANT NOTES" (p. 30; p. 3). These sections provide important information concerning the proper operation of the unit. Additionally, in order to feel assured that you have gained a good grasp of every feature provided by your new unit, this manual should be read in its entirety. The manual should be saved and kept on hand as a convenient reference.

Copyright © 1997 BOSS CORPORATION  
All rights reserved. No part of this publication may be reproduced in any form without the written permission of BOSS CORPORATION.

2

## IMPORTANT NOTES

In addition to the items listed under "USING THE UNIT SAFELY" on page 30, please read and observe the following:

### Power Supply: Use of Batteries

- Do not use this unit on the same power circuit with any device that will generate line noise (such as an electric motor or variable lighting system).
- The AC adaptor will begin to generate heat after long hours of consecutive use. This is normal, and is not a cause for concern.
- The use of an AC adaptor is recommended as the unit's power consumption is relatively high. Should you prefer to use batteries, please use the alkaline type.
- When installing or replacing batteries, always turn off the power on this unit and disconnect any other devices you may have connected. This way, you can prevent malfunction and/or damage to speakers or other devices.
- Before connecting this unit to other devices, turn off the power to all units. This will help prevent malfunctions and/or damage to speakers or other devices.

## Contents

IMPORTANT NOTES .....	3
FEATURES .....	5
PANEL DESCRIPTIONS .....	6
CONNECTIONS .....	10
OPERATION .....	11
Using the Unit as a Metronome .....	11
Tempo Setting in the Tap Mode .....	14
Playback in the Loop Mode .....	16
Tune Mode .....	18
Back Up Function .....	20
Battery Replacement .....	20
Stand Installation .....	21
Attaching the Drum Set .....	22
Initialization (Restoring the data preprogrammed at the factory) .....	22
Setting Samples and Preset Memories .....	23
Specifications .....	26
USING THE UNIT SAFELY .....	30

### Placement

- This device may interfere with radio and television reception. Do not use this device in the vicinity of such receivers.
- Do not expose the unit to direct sunlight, place it near devices that radiate heat, leave it inside an enclosed vehicle, or otherwise subject it to temperature extremes. Excessive heat can deform or discolor the unit.

### Maintenance

- For everyday cleaning wipe the unit with a soft, dry cloth or one that has been slightly dampened with water. To remove stubborn dirt, use a cloth impregnated with a mild, non-abrasive detergent. Afterwards, be sure to wipe the unit thoroughly with a soft, dry cloth.
- Never use benzene, thinners, alcohol or solvents of any kind, to avoid the possibility of discoloration and/or deformation.

## Repairs and Data

- Please be aware that all data contained in the unit's memory may be lost when the unit is sent for repairs. Important data should always be written down on paper (when possible). During repairs, due care is taken to avoid the loss of data. However, in certain cases (such as when circuitry related to memory itself is out of order), we regret that it may not be possible to restore the data, and Roland assumes no liability concerning such loss of data.
- Unfortunately, it may be impossible to restore the contents of data that was stored in the unit's memory once it has been lost. Roland Corporation assumes no liability concerning such loss of data.

## Memory Backup

- Even while the unit's power is switched off, the battery serves in maintaining the contents of memory. When the battery becomes weak, there is a risk of losing the contents of memory. To avoid this, replace the battery as soon as you notice it has weakened.

## Additional Precautions

- Please be aware that the contents of memory can be irretrievably lost as a result of a malfunction, or the improper operation of the unit. To protect yourself against the risk of losing important data, we recommend that you periodically save a backup copy of important data you have stored in the unit's memory Setting Memo.
- Use a reasonable amount of care when using the unit's buttons, sliders, or other controls; and when using its jacks and connectors. Rough handling can lead to malfunctions.
- Never strike or apply strong pressure to the display.
- When connecting / disconnecting all cables, grasp the connector itself—never pull on the cable. This way you will avoid causing shorts, or damage to the cable's internal elements.
- To avoid disturbing your neighbors, try to keep the unit's volume at reasonable levels. You may prefer to use headphones, so you do not need to be concerned about those around you (especially when it is late at night).
- When you need to transport the unit, package it in the box (including padding) that it came in, if possible. Otherwise, you will need to use equivalent packaging materials.

4

## FEATURES

- The DB-88 is a high-quality rhythm training machine equipped with quartz-precision timing. It readily accommodates a wide range of musical genres—from jazz or rock to classical.
- It digitally indicates the tempo, which can be quickly and accurately changed with the dial.
- You can adjust the volume of each rhythm ( ♩ , ♪ , ♫ or ♬ ) independently and add accents freely.
- It allows you to use voice as well as two types of click sounds for training.
- You can set a complex beat (as well as a simple beat) by combining 1–8 beats.
- It allows you to write eight different Metronome settings (Tempo, Beat, Tone and Level) and eight different reference notes into memory.
- It features a Loop function, which can automatically play back a series of settings you have set up, allowing you to practice irregular rhythms or tempo changes in a song.
- It detects and indicates the tempo through Tap Input, which allows you to see the tempo easily—simply by pressing the Tap button.
- Since reference notes can be played chromatically, the unit can also be used for practicing wind instruments.
- Features an input jack that allows for connecting a guitar or bass. It can be used as a headphones amplifier, so you can practice during the night time.

**Please note that although a battery was installed in your DB-88 when it was shipped from the factory, it has not been connected. You will need to refer to the section "Battery Replacement," for instructions on connecting the battery.**

5

# PANEL DESCRIPTIONS

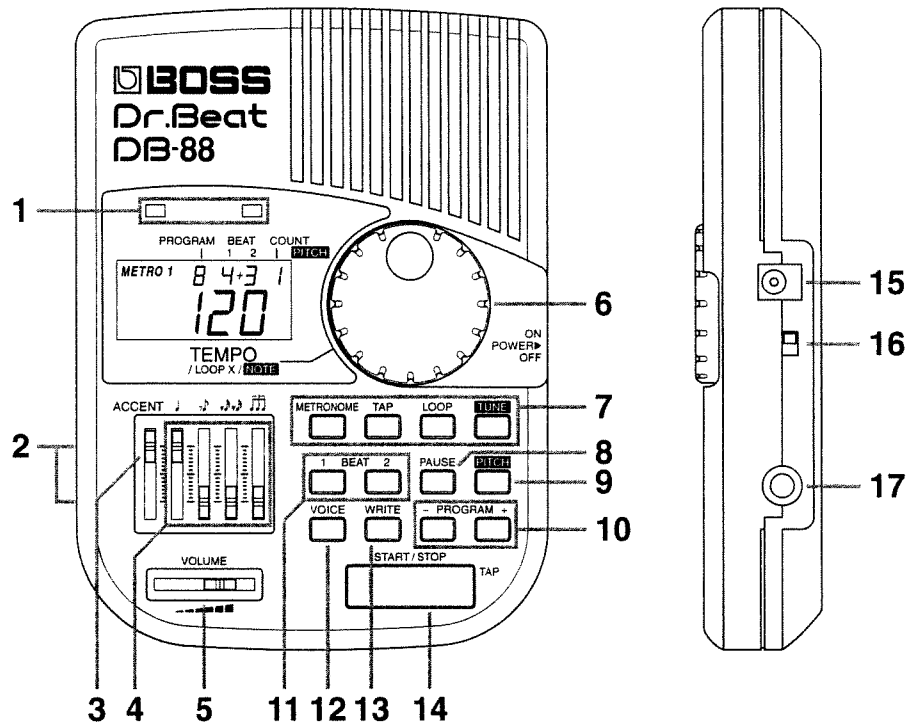

6

## 1. Tempo Indicators

These LED's indicate the current tempo. The left LED flashes at the first beat and the right LED flashes at other beats.

## 2. Headphones Jacks

Connect headphones to these jacks (stereo mini or stereo phone type).

*\* Connecting headphones will automatically mute the internal speaker.*

## 3. Accent Level Slider

This slider controls the volume of the sound that is heard on every first beat.

## 4. Rhythm Level Sliders

The level of each Rhythm can be adjusted with these sliders.

## 5. Total Volume Slider

This adjusts the overall volume.

## 6. Dial

In the Metronome or Tap mode, use this to set the tempo. In the Loop mode, the same dial can be used for setting the number of times the Program is to be played. In the Tune mode, use it for setting the note name of the reference note.

## 7. Mode Buttons

Press one of these buttons to select among the Metronome, Tap, Loop, and Tune modes.

## 8. Pause Button

**(available in the Loop mode)**

Use this button to pause the Rhythm being played. Press it to stop playing, and press it again to continue.

## 9. Pitch Button

**(available in the Tune mode)**

Use this button to change the reference pitch. Pressing the button will change the pitch in 1 Hz steps, which is shown in the display. It is variable from A4 = 438–445 Hz.

7

## 10. Program +/- Buttons

Use these buttons to edit the Program Number. In the Metronome or Tap mode, eight different numbers are available; and in the Tune mode, another eight numbers are available. In the Loop mode, you can select the Program Number to start with. By pressing the - button and + button at the same time, Program Number 1 is automatically selected, which may be useful for starting the rhythm in the Loop mode.

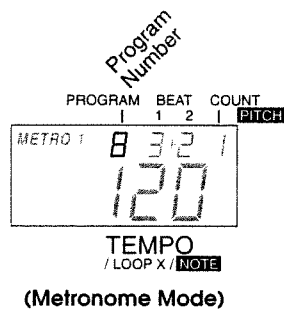

## 11. Beat Buttons 1/2

(available in the Metronome or Tap Mode)

This sets the beat, given that J is one beat. Each press of the button changes the beat like this: 1, 2, ... 8, which is shown in the display.

Normally, you do not use Beat 2 so it can be switched off. However, it can be effectively used to create a complex beat by combining Beat 1 and Beat 2.

\* *Beat 2 can be turned off (the indicator goes out). If you wish to use only Beat 1, turn Beat 2 off.*

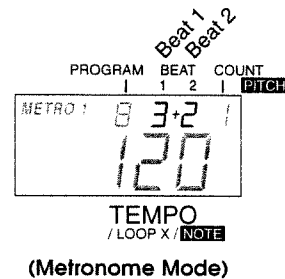

8

## 12. Voice Button

(available in the Metronome and Tap modes)

Use this button to change Metronome Tones. Pressing the button switches the unit through these choices: 1 (Click 1), 2 (Click 2) and 3 (Voice), which is shown in the display.

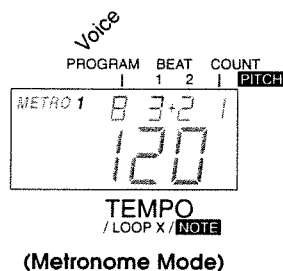

## 13. Write Button

Use this button to write the data into Program Numbers (1–8).

## 14. Start/Stop, Tap Button

In the Metronome or Loop mode, this button can start/stop the rhythm. In the Tap mode, the same

button can be used for entering the rhythm by tapping it at each beat. In the Tune mode, it can be used for playing and muting the reference note.

## 15. AC Adaptor Jack

Connect an AC Adaptor (BOSS PSA-Series; optional) to this jack.

## 16. Power Switch

Turns the unit on or off.

## 17. Input Jack

Connect an electric guitar or bass guitar to this jack. This is provided for listening the rhythm and the instrument sound at the same time through headphones during the night time. Adjust the volume of the instrument sound with the volume control knob on the instrument.

\* *When using the DB-88's speaker, inputting a high level sound will distort the speaker sound causing damage to the speaker. So, be sure that the volume is turned down.*

9

# CONNECTIONS

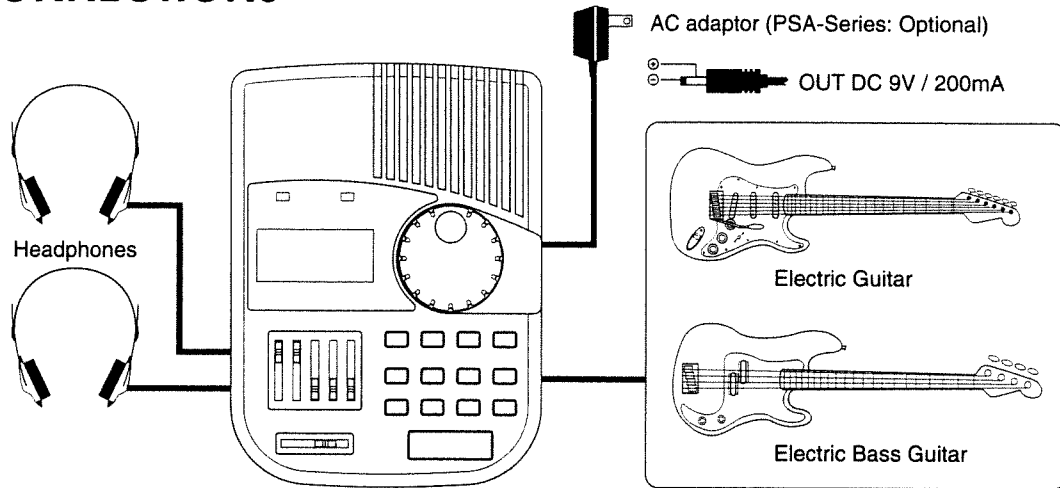

\* To prevent malfunction and/or damage to speakers or other devices, always turn down the volume, and turn off the power on all devices before making any connections.

\* If there are batteries in the unit while an AC adaptor is being used, normal operation will continue should the line voltage be interrupted (power blackout or power cord disconnection).

\* Always make sure to have the volume level turned down before switching on power. Even with the volume all the way down, you may still hear some sound when the power is switched on, but this is normal, and does not indicate a malfunction.

10

# OPERATION

## Using the Unit as a Metronome

The following explains how to use the unit as a metronome. Setting changes you make can be stored at a Program Number (1-8).

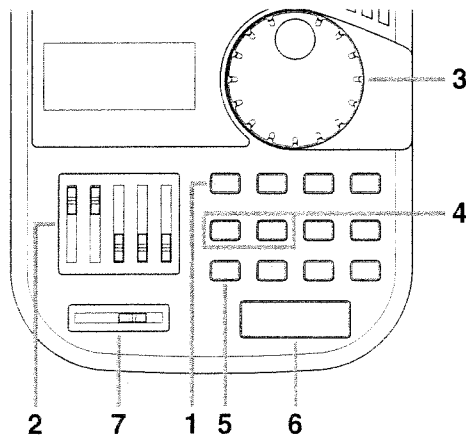

1. Make sure that the unit is switched on, then press the Metronome Mode button to get into the Metronome mode.

To use the Rhythm preprogrammed at a Program Number, call up the relevant Program Number using the Program +/- buttons, then go to step 6.

2. Set the Accent Level slider and Rhythm Level sliders as shown in the picture.

If it happens to be a different setting from the data previously programmed, the display shows "ED" mark showing that it is now being edited.

3. Set the tempo with the Dial.

\* If you rotate the Dial while holding the Metronome Mode button down, the tempo will be automatically set to "120." This can be used for resetting or changing the tempo rapidly.

**4. Set the beat with the Beat 1 and 2 buttons.**

*\* Normally, if you wish to set the simple beat, use only the Beat 1 button and turn off the Beat 2 button (it stays dark). To make a complex beat, combine Beat 1 and Beat 2. For instance, if a 5 beat consists of 3 and 2 beats, set Beat 1 to "3" and Beat 2 to "2."*

**5. Select the tone you like with the Voice button.**

"1" is a common click sound.

"2" is a click sound ideal for drum training. If you strike out an accurate rhythm, the sound will synchronize, and the click will no longer be heard.

"3" is a female voice. A number is spoken, so you can clearly determine the current beat.

**6. Press the Start/Stop button to start the rhythm. Press it again to stop the rhythm.**

**7. Adjust the volume with the Total Volume slider.**

By using the Rhythm Level sliders at the same time, you can create 16 beat or syncopation.

12

## **Writing Programs in the Metronome Mode**

You can write the data you have set in the Metronome mode into the Program Numbers (1–8).

1. Set the tempo, beat, rhythm level, and voice you wish to have stored.
2. Press the Write button, and the Program Number will flash.
3. Select the destination Program Number using the Program +/- buttons.
4. Press the Write button. The "ED" mark will disappear, showing that the data was written in the Program Number you specified in step 3.

*\* If you press the Write button without editing the data, the data contained in the Program Number selected at that time can be copied to a different Program Number.*

*\* If you wish to cancel the Writing procedure, press the Metronome Mode button or other mode button.*

13

## Tempo Setting in the Tap Mode

Press the Tap button to the tempo of the current song, and the tempo will be shown in the display.

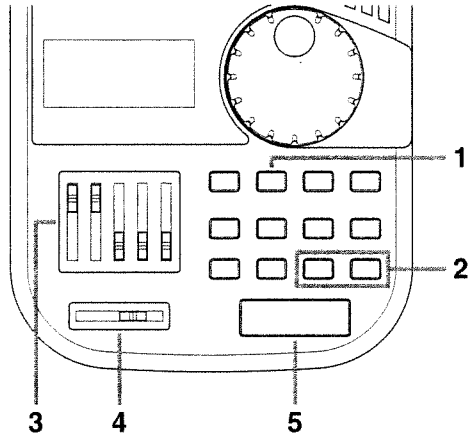

1. Make sure that the unit is switched on, then press the Tap Mode button to get into the Tap mode.

2. Call the desired Program with the Program +/- buttons or set the beat you want with the Beat buttons.

3. Set the Accent Level slider and Rhythm Level sliders as shown in the picture.

\* In the Tap mode, ♩, ♪, ♫ or ♬ sound is not played.

4. Adjust the volume with the Total Volume slider.

5. Press the Tap button to the beat, and the tempo is shown in the display.

\* If you set the tempo in the Tap mode then switch to the Metronome mode by pressing the Metronome Mode button, the last tempo shown in the display can be used in the Metronome mode.

14

### \* ERROR MESSAGES

In the Tap mode, the display shows the following error messages.

When the tempo is quicker than 250:

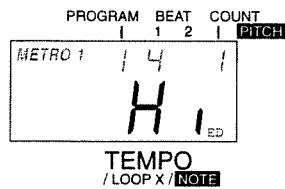

When the tempo is 30-34:

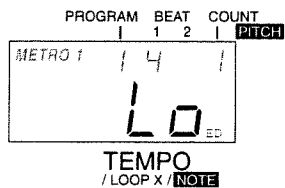

When the tempo is slower than 30, the last tempo will remain.

15



## Playback in the Loop Mode

You can play back the data you have written in Program Numbers (1–8) in sequence.

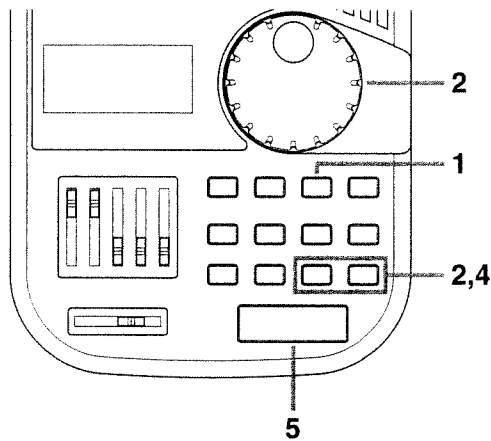

1. Make sure that the unit is switched on, then press the Loop Mode button to get into the Loop mode.

2. Select the Program Number with the Program +/- buttons, then set the number of playbacks (LOOP X) with the Dial.

Any number of playbacks from 1–255 times can be selected. If there is any Program Number you do not want to play back, set it to "OFF." If you rotate the Dial counterclockwise while holding the Loop Mode button down, it will be set to 4 times. If you rotate the Dial clockwise in the same way, it will be set to 100 times. As you can see, this method is useful for making quick settings.

3. Repeat step 2 for each Program Number.

4. Select the first Program Number to be played using the Program +/- buttons.

Pressing the - and + buttons at the same time will automatically select Program Number 1.

16

5. Press the Start/Stop button to start playing. The display shows the counter for playback.

If you wish to pause playback, press the Pause button. The Program Number currently selected will stop playing and the playback counter will return to 001.

*\* In the Loop mode, you cannot change the Rhythm Level, Tempo, Beat, and Voice.*

## Tune Mode

Allows a broad range (C2–B6) to be used for the reference note. Since this mode allows you to specify the reference pitch and the note name, it can be used for practicing wind instruments as well as for tuning.

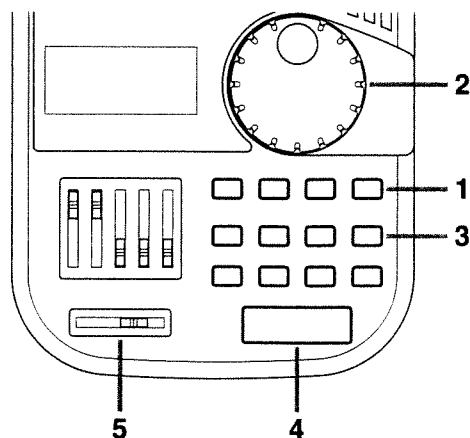

1. **Make sure that the unit is switched on, then press the Tune Mode button to get into the Tune mode.**

If you wish to use the note name previously written in a Program Number, call the relevant Program Number with the Program +/- buttons, and go to step 4.

2. **Set the note name (NOTE) of the reference note with the Dial.**

The note name can be set in the range of C2–B6.

*\* If you rotate the Dial while holding the Tune Mode button down, the note name "C4" will be automatically selected. This function may be effectively used for resetting or quick change of the note name.*

*\* If the setting is different from the preprogrammed data, the "ED" mark will appear in the display showing that it is being edited.*

18

3. **Press the Pitch button to set the reference pitch.**

The reference pitch can be set anywhere between 438 to 445 Hz (1 Hz increment) for note A4.

4. **Press the Start/Stop button to play the data. Pressing the Start/Stop again will mute the sound.**

5. **Adjust the volume with the Total Volume slider.**

## Writing into Memory in the Tune Mode

You can write the data you have set in the Tune mode into Program Numbers (1–8).

1. Set the note name and the reference pitch.
2. Press the Write button, and the Program Number flashes.
3. Specify the destination Program Number using the Program +/- buttons.
4. Press the Write button again. "ED" mark will disappear and the data is written in the Program Number you have selected in step 3.

*\* If you press the Write button without editing the note name of reference pitch, the data of the Program Number selected at that time will be copied into a different Program Number.*

*\* If you wish to cancel writing, press the Tune Mode button or other mode button.*

19

## Back Up Function

When the battery or AC Adaptor is connected to the unit, the data written in the Program Numbers will be retained even after it is switched off.

## Battery Replacement

When the battery is getting exhausted, the display will become dimmer, and no sound will be heard from the unit. If this happens, replace the battery with a new one. The power consumption of this unit is large, so please use alkaline battery.

*\* If you wish to replace battery without losing the data stored in the Program Numbers, do it while the AC Adaptor is connected; or complete the battery replacement procedure in less than 5 minutes—before the battery has completely worn out.*

*\* To protect the contents of memory, make sure to switch off the unit before replacing its battery.*

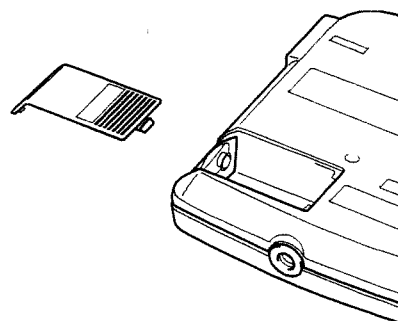

20

1. **Switch off the unit.**
2. **While applying slight pressure to it, slide off the battery cover from the bottom of the unit.**
3. **Take out the old battery and disconnect it from the snap cord.**
4. **Connect the new battery to the snap cord.**
5. **Place the battery then close the cover by sliding it.**

## Stand Installation

If you wish to stand the DB-88, install the supplied stand as follows:

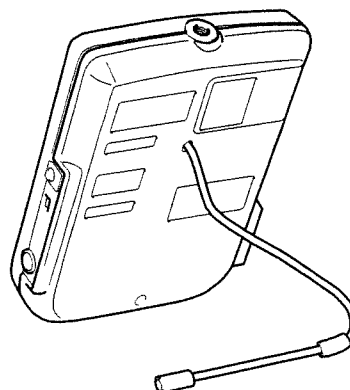

21

## Attaching the Drum Set

Using the optional MDY-7 Cymbal Holder Set, do as follows:

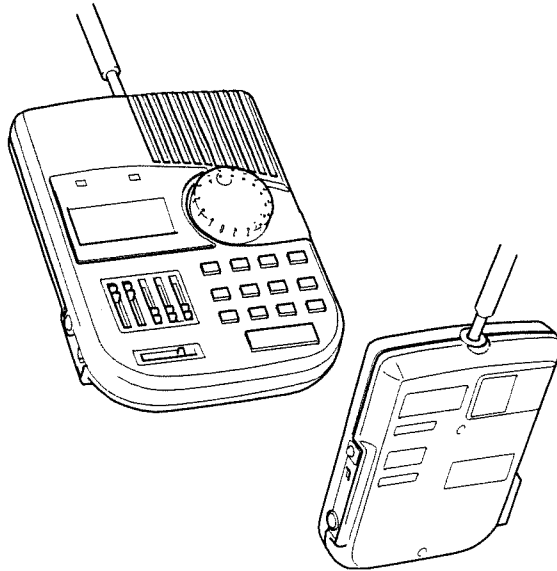

## Initialization

(Restoring the data preprogrammed at the factory)

Follow these instructions:

1. Switch off the unit.
2. Switch on the unit while you have both the Metronome Mode and Loop Mode buttons held down.
3. When the display responds as follows, press the Write button. All data will be initialized, then the unit will go into the same state as it normally does when it is switched on.

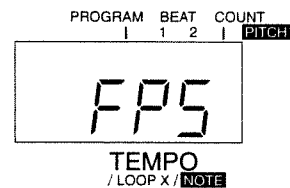

\* If you wish to cancel the initialization, switch off the unit.

22

## Setting Samples and Preset Memories

Program 1: 4 Beat

Program 2: 3 Beat

Program 3: 3 + 2 Beat  
(5 Beat)

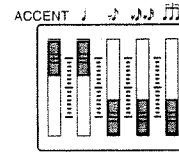
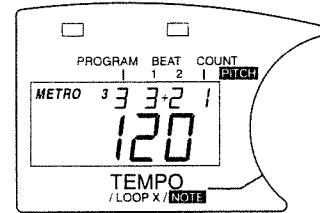
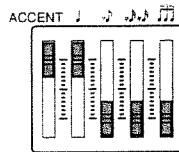
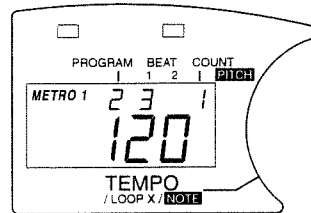
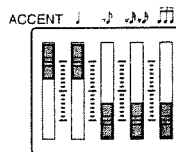
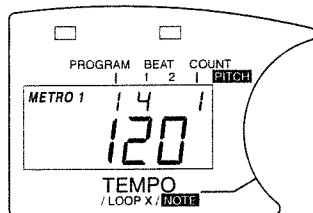

23

### Program 4: 16 Beat

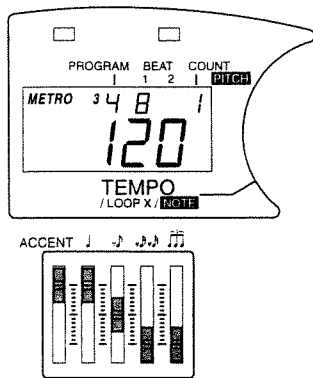

### Program 5: 16 Beat

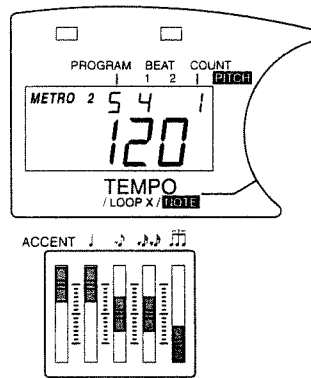

### Program 6: 12 Beat

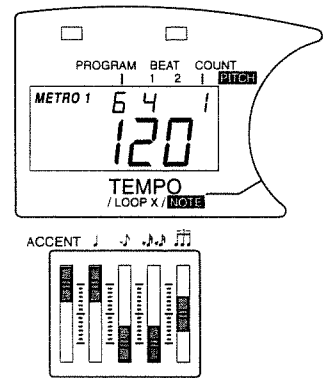

To set to 8 Beat, set ♪ to 0.

24

### Program 7: Syncopation

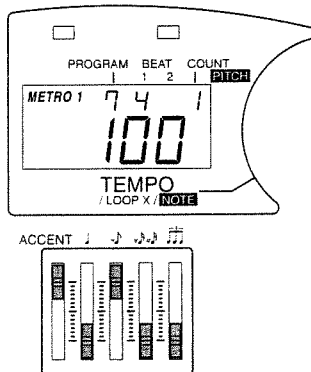

### Program 8: Complex rhythm of ♪ and ♪♪

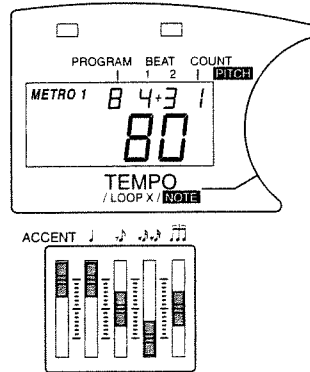

# Specifications

DB-88: Dr. Beat

## Power Supply

DC 9 V: Dry Battery 6LR61/9V, 6AM6/9V (Alkaline)  
AC Adaptor (PSA-Series: Optional)

## Current Draw

No Sound: 20 mA  
1 (Click 1), 2 (Click 2), Tune Mode: 55 mA (Max)  
3 (Voice): 85 mA (Max)

*\* Expected battery life under continuous use:*

### **Alkaline Battery: 24 hours**

*(Tempo: 120, Total Volume: Max,  
Accent Level: Max, ♩ : Max, 1 (Click 1))*

### **Alkaline Battery: 15 hours**

*(Tempo: 120, Total Volume: Max,  
Accent Level: Max, ♩ : Max, 3 (Voice))*

*These figures will vary depending on the actual conditions of use.*

26

## Speaker

50 mm x 1

## Controls

Total VOLUME Slider  
ACCENT Level Slider  
Rhythm Level Sliders x 4  
Dial  
Mode Buttons x 4  
BEAT Buttons x 2  
VOICE Button  
PAUSE Button  
PITCH Button  
WRITE Button  
PROGRAM +/- Buttons  
START/STOP, TAP Button  
POWER Switch

## Connectors

Headphones Jacks x 2  
(Stereo 1/4 inch Phone Type, Stereo Miniature Phone Type)  
INPUT Jack  
AC Adaptor Jack

## Tempo Range

M. M. ♩ = 35 to 250

## Tempo Accuracy

+/- 0.2 %

## Beat

Beat 1: 1, 2, 3, 4, 5, 6, 7, 8  
Beat 2: OFF, 1, 2, 3, 4, 5, 6, 7, 8

## Reference Pitch

438 to 445 Hz, in 1 Hz steps

## Sound Generating

C2 to B6 +/- 1 cent

## Memories

Metronome Mode: 8  
Tune Mode: 8

## Display

Custom LCD Display

## Indicators

Tempo Indicators x 2

## Dimensions

120 (W) x 163 (D) x 33 (H) mm  
4-3/4 (W) x 6-7/16 (D) x 1-5/16 (H) inches

## Weight

350 g (including battery)  
13 oz

## Cymbal Stand Hole

M 6, Pitch: 1.0 mm

## Accessories

Soft Case  
Stand  
Dry Battery 6LR61/9V, 6AM6/9V (Alkaline)  
Owner's Manual

## Options

AC Adaptor PSA-Series  
Cymbal Holder Set MDY-7

*\* In the interest of product improvement, the specifications and/or appearance of this unit are subject to change without prior notice.*

27

# Setting Memo

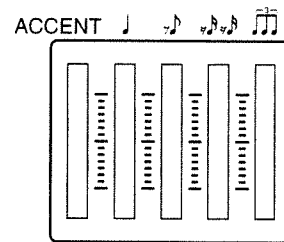
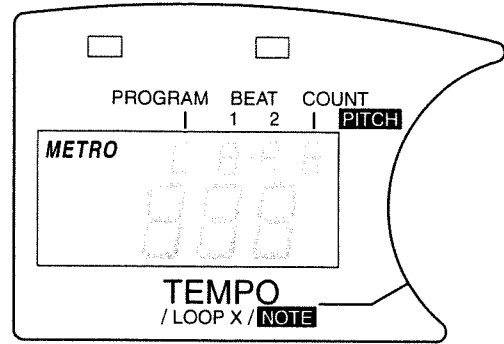
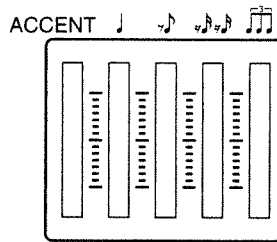
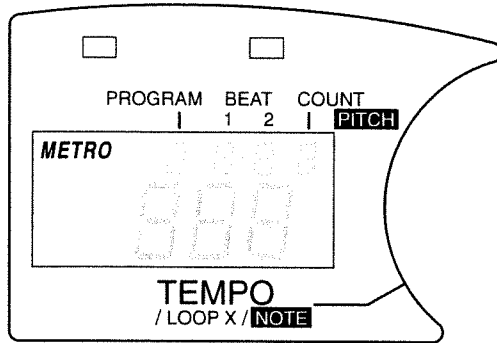

28

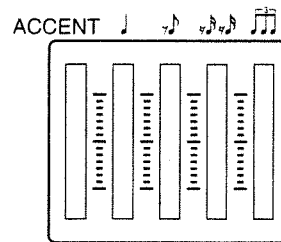
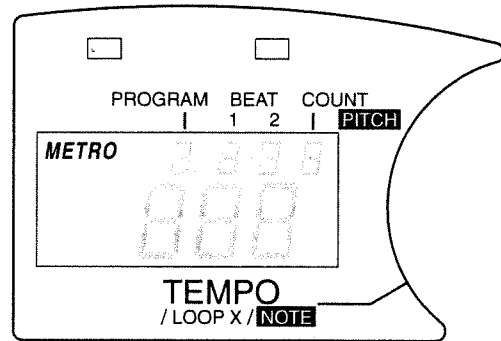
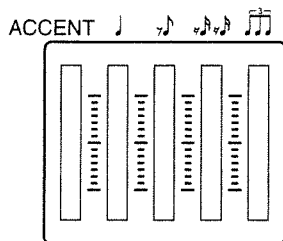
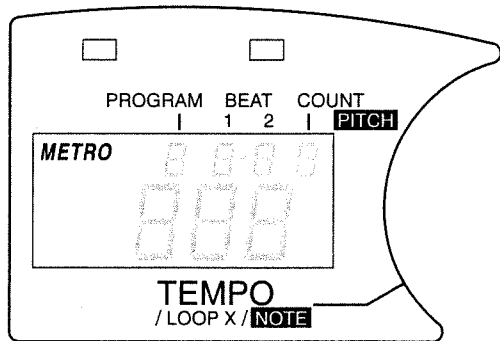

29

# USING THE UNIT SAFELY

## INSTRUCTIONS FOR THE PREVENTION OF FIRE, ELECTRIC SHOCK, OR INJURY TO PERSONS

### About WARNING and CAUTION Notices

<b>WARNING</b>	Used for instructions intended to alert the user to the risk of death or severe injury should the unit be used improperly.
<b>CAUTION</b>	Used for instructions intended to alert the user to the risk of injury or material damage should the unit be used improperly.  * Material damage refers to damage or other adverse effects caused with respect to the home and all its furnishings, as well to domestic animals or pets.

### About the Symbols

	The  symbol alerts the user to important instructions or warnings. The specific meaning of the symbol is determined by the design contained within the triangle. In the case of the symbol at left, it is used for general cautions, warnings, or alerts to danger.
	The  symbol alerts the user to items that must never be carried out (are forbidden). The specific thing that must not be done is indicated by the design contained within the circle. In the case of the symbol at left, it means that the unit must never be disassembled.
	The  symbol alerts the user to things that must be carried out. The specific thing that must be done is indicated by the design contained within the circle. In the case of the symbol at left, it means that the power-cord plug must be unplugged from the outlet.

### ----- ALWAYS OBSERVE THE FOLLOWING -----

30

### **WARNING**

- Before using this unit, make sure to read the instructions below, and the Owner's Manual.

---

- Do not open (or modify in any way) the unit or its AC adaptor.

---

- Do not attempt to repair the unit, or replace parts within it (except when this manual provides specific instructions directing you to do so). Refer all servicing to your dealer, or qualified Roland service personnel.

---

- Never use or store the unit in places that are:
  - Subject to temperature extremes (e.g., direct sunlight in an enclosed vehicle, near a heating duct, on top of heat-generating equipment); or are
  - Damp (e.g., baths, washrooms, on wet floors); or are
  - Humid; or are
  - Dusty; or are
  - Subject to high levels of vibration.

---

- This unit should be used only with a rack or stand that is recommended by Roland.

---

- Make sure you always have the unit placed so it is level and sure to remain stable. Never place it on stands that could wobble, or on inclined surfaces.

---

- Use only the specified AC adaptor (PSA-Series), and make sure the line voltage at the installation matches the input voltage specified on the AC adaptor's body. Other AC adaptors may use a different polarity, or be designed for a different voltage, so their use could result in damage, malfunction, or electric shock.

---

- Avoid damaging the power cord. Do not bend it excessively, step on it, place heavy objects on it, etc. A damaged cord can easily become a shock or fire hazard. Never use a power cord after it has been damaged.

---

31





- This unit, either alone or in combination with an amplifier and headphones or speakers, may be capable of producing sound levels that could cause permanent hearing loss. Do not operate for a long period of time at a high volume level, or at a level that is uncomfortable. If you experience any hearing loss or ringing in the ears, you should immediately stop using the unit, and consult an audiologist. 

---

- Do not allow any objects (e.g., flammable material, coins, pins); or liquids of any kind (water, soft drinks, etc.) to penetrate the unit. 

---

- Immediately turn the power off, remove the AC adaptor from the outlet, and request servicing by your dealer or qualified Roland service personnel when: 
  - The AC adaptor or the power-supply cord has been damaged; or
  - Objects have fallen into, or liquid has been spilled onto the unit; or
  - The unit has been exposed to rain (or otherwise has become wet); or
  - The unit does not appear to operate normally or exhibits a marked change in performance.

- In households with small children, an adult should provide supervision until the child is capable of following all the rules essential for the safe operation of the unit. 

---

- Protect the unit from strong impact. (Do not drop it!) 

---

- Do not force the unit's power-supply cord to share an outlet with an unreasonable number of other devices. Be especially careful when using extension cords—the total power used by all devices you have connected to the extension cord's outlet must never exceed the power rating (watts/amperes) for the extension cord. Excessive loads can cause the insulation on the cord to heat up and eventually melt through. 

---

- Before using the unit in a foreign country, consult with your dealer, or qualified Roland service personnel. 

---

- Batteries must never be recharged, heated, taken apart, or thrown into fire or water. 

32

 **CAUTION**

- The unit and the AC adaptor should be located so their location or position does not interfere with their proper ventilation. 

---

- Always grasp only the plug or the body of the AC adaptor when plugging into, or unplugging from, an outlet or this unit. 

---

- Whenever the unit is to remain unused for an extended period of time, disconnect the AC adaptor. 

---

- Try to prevent cords and cables from becoming entangled. Also, all cords and cables should be placed so they are out of the reach of children. 

---

- Never climb on top of, nor place heavy objects on the unit. 

---

- Never handle the AC adaptor body, or its plugs, with wet hands when plugging into, or unplugging from, an outlet or this unit. 

- Before moving the unit, disconnect the AC adaptor and all cords coming from external devices. 

---

- Whenever you suspect the possibility of lightning in your area, disconnect the AC adaptor from the outlet. 

33

- If used improperly, batteries may explode or leak and cause damage or injury. In the interest of safety, please read and observe the following precautions (p. 20).
- Carefully follow the installation instructions for batteries, and make sure you observe the correct polarity.
- Remove the batteries whenever the unit is to remain unused for an extended period of time.
- If a battery has leaked, use a soft piece of cloth or paper towel to wipe all remnants of the discharge from the battery compartment. Then install new batteries. If any of the discharge from the battery has gotten onto your hands or skin, make sure to wash the area thoroughly with water.
- Never keep batteries together with metallic objects such as ballpoint pens, necklaces, hairpins, etc.



- Used batteries must be disposed of in compliance with whatever regulations for their safe disposal that may be observed in the region in which you live.



34



This product complies with the requirements of European Directives EMC 89/336/EEC and LVD 73/23/EEC.

For Europe

### FEDERAL COMMUNICATIONS COMMISSION RADIO FREQUENCY INTERFERENCE STATEMENT

This equipment has been tested and found to comply with the limits for a Class B digital device, pursuant to Part 15 of the FCC Rules. These limits are designed to provide reasonable protection against harmful interference in a residential installation. This equipment generates, uses, and can radiate radio frequency energy and, if not installed and used in accordance with the instructions, may cause harmful interference to radio communications. However, there is no guarantee that interference will not occur in a particular installation. If this equipment does cause harmful interference to radio or television reception, which can be determined by turning the equipment off and on, the user is encouraged to try to correct the interference by one or more of the following measures:

- Reorient or relocate the receiving antenna.
- Increase the separation between the equipment and receiver.
- Connect the equipment into an outlet on a circuit different from that to which the receiver is connected.
- Consult the dealer or an experienced radio/TV technician for help.

Unauthorized changes or modification to this system can void the users authority to operate this equipment. This equipment requires shielded interface cables in order to meet FCC class B Limit.

For the USA

### CLASS B

### NOTICE

This digital apparatus does not exceed the Class B limits for radio noise emissions set out in the Radio Interference Regulations of the Canadian Department of Communications.

### CLASSE B

### AVIS

Cet appareil numérique ne dépasse pas les limites de la classe B au niveau des émissions de bruits radioélectriques fixés dans le Règlement des signaux parasites par le ministère canadien des Communications.

For Canada



 Roland®

**SE000038**

UPC

SE000038



18981

 **BOSS**