

 **Roland**

MICRO COMPUTER CONTROLLED RHYTHM MACHINE

CompuRhythm
CR-8000 OWNER'S MANUAL

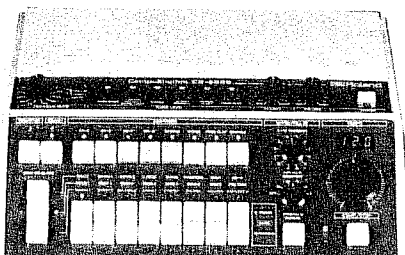

Features

- Here is the most convenient rhythm machine, the new CR-8000 Compu-Rhythm Unit from Roland, with new design and circuit.
- This unit has twenty-four kinds of Basic Rhythm Patterns and eight presets of Intro/Fill-In Rhythm Pattern as presets.
- In addition, CR-8000 has eight kinds of Programmable sections for Basic Rhythm and four kinds of Programmable sections for Intro/Fill-In Rhythm where you can write your own rhythm pattern at will.
- Moreover, this unit has the following attractive features.

① More Rhythm Patterns

This unit has twenty-four kinds of Basic Rhythm Patterns and 8 preset rhythm patterns for Cymbal/Hi-Hat/Conga. A wide range of rhythm variations can be produced by combining these rhythm patterns.

② Crash and Shuffle functions

Equipped with Shuffle and Crash switch on the front panel. Shuffle function shuffles entire rhythms, while the Crash function can be used to insert the crash sound of Cymbal when the rhythm is changed from Intro/Fill-In to Basic.

③ Level Control for both channels

All sound sources can be controlled by the Level Controls, so you can set the balance as desired.

④ External In/Out Jack

The CR-8000 has Trigger Out to control external sequencer or synthesizer. In addition, The Sync. In/Out section of CR-8000 allows it to be synchronized perfectly with units such as the Roland CSQ-600 Digital Sequencer or MC-4 Micro Composer.

⑤ Precise Tempo Display

The CR-8000, equipped with Digital LED Display of Tempo, can set the Tempo at any desired position with quick operation.

- Slanted control panel assures easy operation.
- The Accent can give emphasis to any other voices programmed on the same step. The Level control adjusts the amount of emphasis.

Precautions

- Do not open this unit.
- Unplug this unit when it is not to be used for long periods of time. Unplug by grasping the plug rather than pulling on the cord.
- Be careful not to place heavy objects on the power cord.
- Avoid using this unit in very high or low temperature locations. Also keep away from heaters and air-conditioners since this type of equipment will affect circuit and pitch stability.
- Avoid using this unit in very dusty or humid places.
- If it is necessary to use this unit in an area with neon or fluorescent lights, keep it as far away from these lights as possible since they will induce high levels of noise. Sometimes changing the angle of this unit in relation to the lights will help reduce noise.

Before Using CR-8000

- For the ultimate protection to the digital circuitry of your CR-8000 make all connections to other equipment with both units power switched "OFF".
Once all connections are made, switch "ON" the power of the other unit first, the CR-8000 last. If error occurs, once switch "OFF" the power, then switch "ON" the power after about 5 seconds.
- It is to be desired that Program Mode Switch is set to Play mode unless "writing" is required. This protection must be taken to make sure that the rhythms memorized into the CR-8000 are not erased or distorted.
- Remember that the SYNC. In/Out Select switch must be in the OUTPUT position for the CR-8000 to operate by itself.

Table of Contents

Features	1	Applications	10
Basic Connection	3	1. Substitute for a Metronome	
Front Panel	4	2. Odd Rhythm	
OPERATION	5	3. Delicate difference of rhythm variation by Register	
1. Preset Rhythm Operation	5	4. Register's special effect	
2. Intro/Fill In Operation	6	5. To use the Crash sound at the ending	
■ To start from Intro rhythm pattern		6. The rhythm with 32 or 24 steps	
• Auto Fill In		Others	10
• Manual Fill In		■ About Tempo Display	
3. How to use the Arranger	7	■ Memory Back-up	
■ Cymbal and Hi-Hat arrangement		■ To replace the three 1.5-Volt dry cell batteries	
■ Conga and Hand Clap arrangement		■ SYNC. IN/OUT	11
■ Shuffle arrangement		1. Operating CR-8000 by itself	
4. How to use the Crash Button	7	2. CR-8000 + CSQ-600	
5. How to use the Register	8	3. CR-8000 + MC-4	
■ How to set		• Controlling CR-8000 by MC-4	
■ How to play		• Controlling MC-4 by CR-8000	
6. How to write the rhythm pattern	8	CR-8000 PRE-SET RHYTHM	12
6-1 How to write Basic rhythm pattern		SAMPLE RHYTHM	17
▶ How to erase the programmed rhythm pattern		SPECIFICATIONS	19
6-2 How to write Intro/Fill In rhythm pattern	9		

Basic Connection

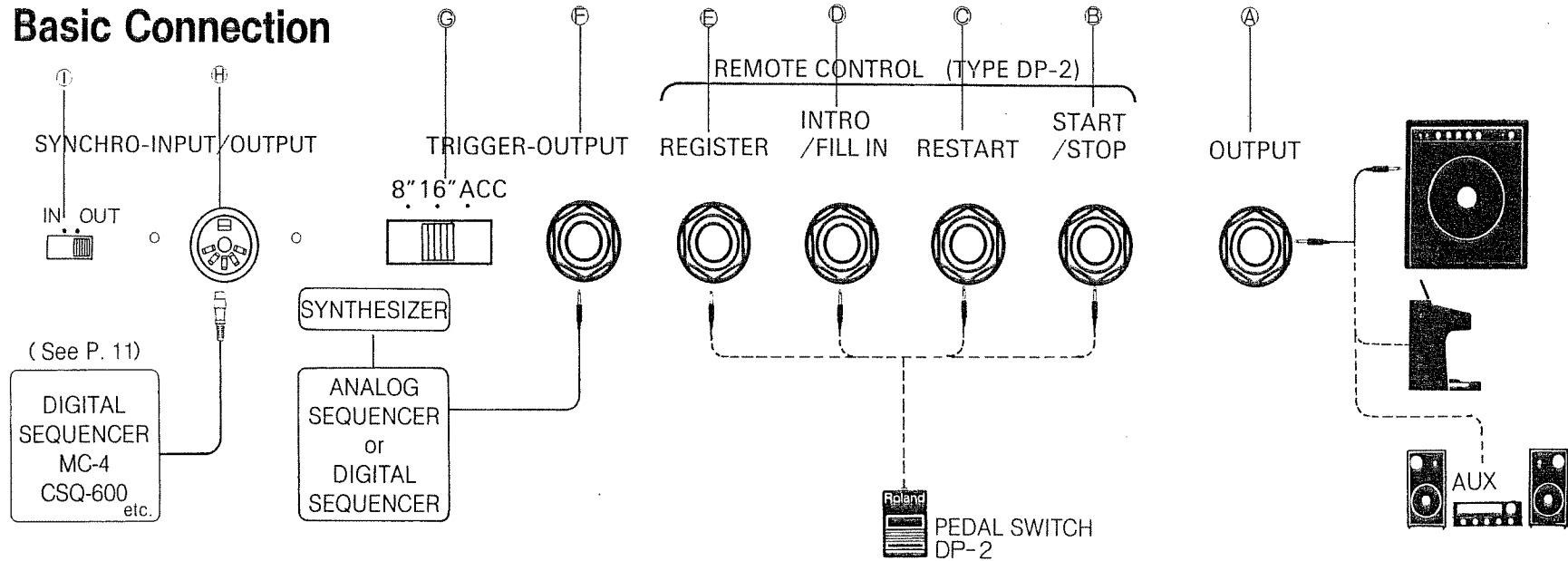

Ⓐ OUTPUT

Ⓒ START/STOP

Ⓓ RE-START

Connect a Pedal Switch such as Roland DP-2 to this jack. By depressing the pedal switch, the rhythm being played can be immediately returned to the beginning of the bar, which is available for adjustment of a beat that gets out of tempo during a performance, or to create an odd rhythm.

Ⓔ INTRO/FILL-IN

This jack is used for remote control options for the Intro or Fill-in function (without defeating those functions at the front panel Manual button).

Ⓔ REGISTER

This jack provides remote control options for performing alternately two rhythm patterns without defeating this function at the front panel Register button.

Ⓕ TRIGGER OUTPUT

CR-8000 has Trigger Out for Control other Sequencer or Synthesizer.

Ⓖ TRIGGER OUT 8"-16"-ACC SWITCHABLE

CR-8000 provides Trigger Output to allow interfacing with synthesizer or sequencer. This Trigger signal is a positive 5V, 10ms pulse suitable for activating either the Trigger or Gate inputs of most major brands of equipments.

Ⓗ SYNC. IN/OUT

(5 pin DIN connector)

Ⓘ SYNC. IN/OUT SELECT SWITCH

The SYNC. IN/OUT section of CR-8000 allows itself to be synchronized perfectly with units such as the Roland CSQ-600 Digital Sequencer, allowing each unit total rhythmic freedom with remaining in perfect tempo, starting and stopping of both units from the CSQ-600. CR-8000 can also be synchronized to the Arpeggio section of Roland JP-8 Polyphonic Synthesizer. To synchronize two units, connect a five pin DIN cord to the SYNC. jack on each unit and move the CR-8000 SYNC. switch to the INPUT position for connection to the CSQ-600, or to the OUTPUT position for connection to the JP-8. Remember that the SYNC. switch must be in the OUTPUT position for the CR-8000 to operate by itself.

Front Panel

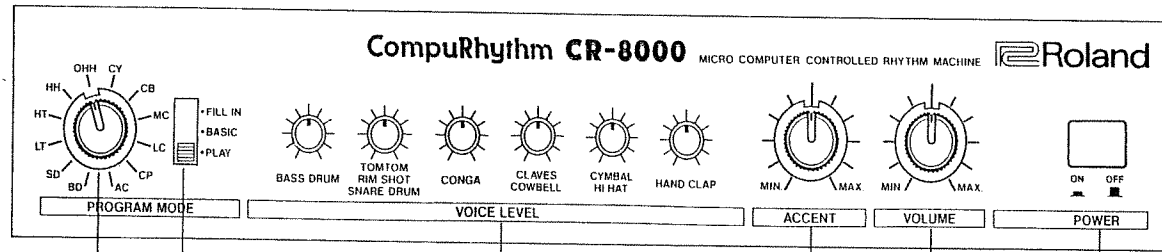

- ① PROGRAM MODE SELECTOR
- ② PROGRAM INSTRUMENT SELECTOR
- ③ VOICE LEVEL
- ④ ACCENT
- ⑤ VOLUME
- ⑥ POWER

- ⑦ REGISTER (writing switch)
- ⑧ CRASH (writing switch)
- ⑨ ARRANGER
- ⑩ INTRO/FILL IN
- ⑪ TEMPO
- ⑫ TEMPO DISPLAY

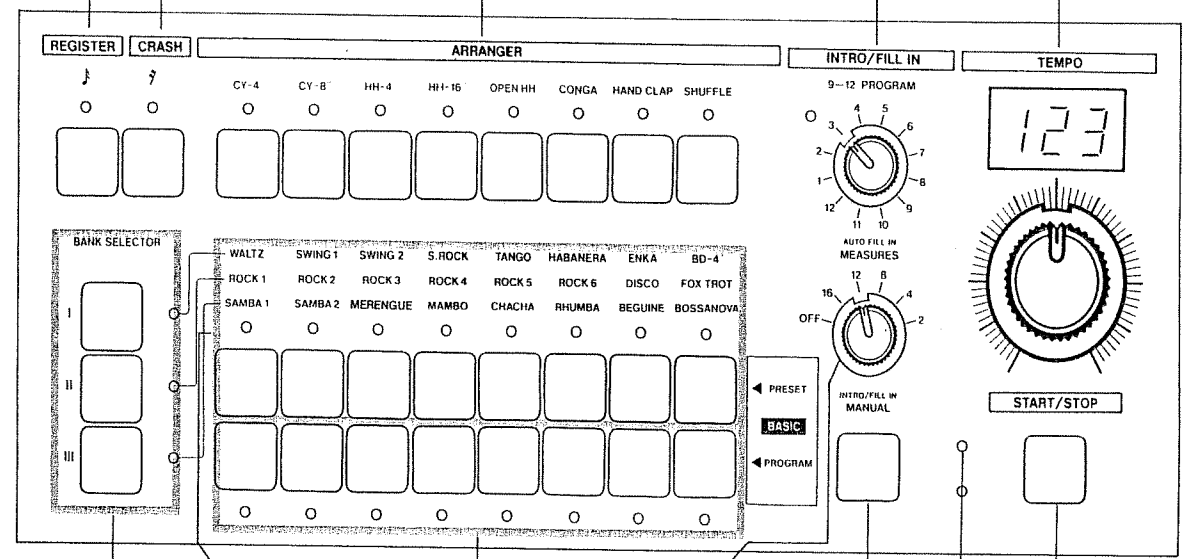

- ⑬ BANK SELECTOR
- ⑭ PRE-SET RHYTHM SELECTOR
- ⑮ PROGRAM RHYTHM SELECTOR
- ⑯ AUTO FILL IN MEASURES
- ⑰ INTRO/FILL IN MANUAL
- ⑱ TEMPO LED BEAT LED
- ⑲ START/STOP

OPERATION

1. Preset Rhythm Operation

- ① Check that power cable is correctly and firmly connected.
Push the Power switch to "ON" position.

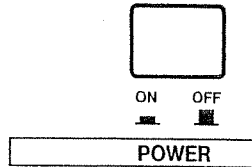

- ② Select the desired rhythm pattern from 24 Basic Rhythm Patterns of preset by depressing the corresponding Bank Selector ⑤ and Preset Rhythm Selector ⑥.

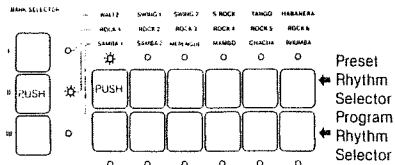

Note: When the desired rhythm is selected the LED display illuminates.

- Also, you can combine two preset rhythm patterns by depressing two selectors simultaneously. However, if three or more selectors are pressed simultaneously, the two nearest to the left hand side will be selected.
If WALTZ, SWING 1, SWING 2, SLOW ROCK and similar 3-beat rhythms or SHUFFLE TYPE rhythms are combined with another 4-beat type rhythms, the 4-beat type rhythm will be arranged with the particular 3-beat or shuffle-type rhythm.

- ④ Press the Start/Stop button to start rhythm.

START/STOP

- (Red)
- (Green)



Note: When the rhythm starts, Red Tempo LED will illuminate for each bar of the rhythm and Green Tempo LED will illuminate every one-beat.

- ⑤ The Volume of each sound source can be adjusted by the Voice Level Control ④, and the overall volume by the Level Control ⑥.

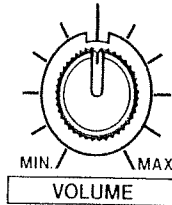
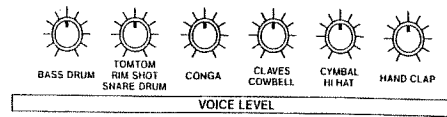

- ⑥ Determine the Tempo of the rhythm accompaniment by turning the Tempo Control ⑦.

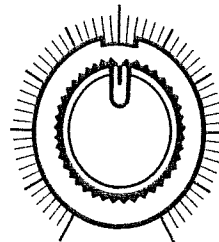
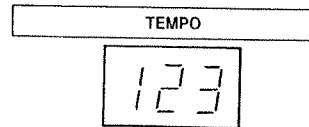

- ⑦ Accent Control ⑧ is used to give dynamic emphasis to any other rhythm source on the same step. This level control adjust the amount of emphasis.

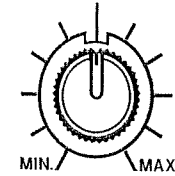

ACCENT

- You can change the rhythm pattern without stopping playing. Try changing the bank selector and the rhythm selector at will. The rhythm pattern will change the instant the button is pressed. For example, if the rhythm is changed exactly on the beat at the end of a bar, the new rhythm will begin from the beginning of the next bar. And if while using a 4/4 time you change rhythm at the 4th beat of the bar, the new rhythm will begin from that same 4th beat. (Even if the rhythm is changed, the overall beat will not be changed)

- ⑧ The running rhythm will be stopped by depressing again the "Start/Stop" button ④.

START/STOP



2. Intro/Fill-In Operation

To start from Intro rhythm pattern.

- ① Select the desired rhythm pattern for Intro rhythm with Intro/Fill-In selector ⑩.

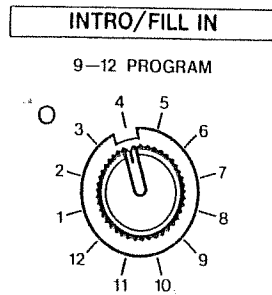

- ② Select the desired Basic Rhythm pattern to be performed after Intro rhythm by depressing the Bank Selector ⑤ and Preset Rhythm Selector ⑥.

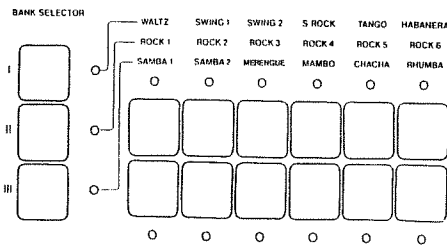

- ③ Press the Manual button ⑪.

Basic rhythm will start after one bar of Intro rhythm.

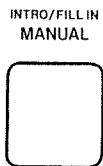

Note: Do not depress Start/Stop button ⑦ to start the rhythm.

Auto Fill-In

To insert Fill-In rhythm pattern.

- ① Select the Fill-In cycle with the Measure Selector ⑩. Automatic insertion of Fill-In rhythm is accomplished in any of the positions marked 16, 12, 8, 4 and 2. When set at these positions the Fill-In rhythm selected will play every 16th measure, every 12th measure, and so on.

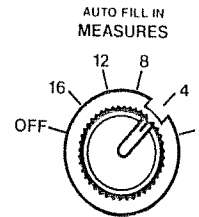

- ② Select the desired rhythm with the Intro/Fill-In Selector ⑩.

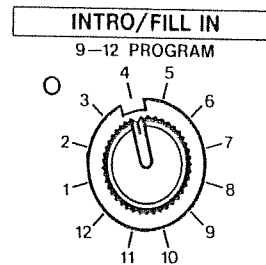

- ③ Select the Basic Rhythm Pattern with the Bank Selector ⑤ and Preset Rhythm Selector ⑥.

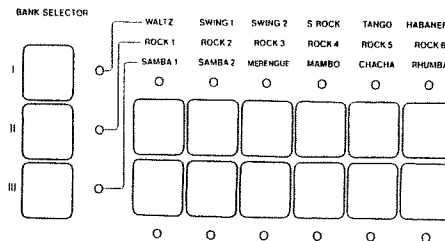

- ④ Push Start/Stop button ⑦ to start the rhythm.

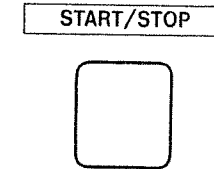

Note: When the rhythm start from Intro Rhythm Pattern, the Fill-In rhythm will be inserted in one bar early, since the Intro rhythm is counted as the first bar. (From the second entry on, it will return to the selected cycle)

Manual Fill-In

When the Measure Selector ⑩ is in the "OFF" position, Fill-In rhythm is inserted manually by depressing the Manual button ⑪. If you depress it exactly at the bar division, the Fill-In rhythm will be one bar beginning from the next bar. If you depress it at the 4th beat of a 4/4 time, the Fill-In rhythm will be for one beat (the 4th beat of the Fill-In rhythm). By keeping on pressing the Manual button ⑪ the Fill-In rhythm can be inserted continuously for several bars.

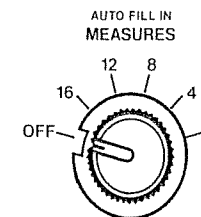

3. How to use the Arranger

- By depressing the Arranger button you can change preset Cymbal or Hi-Hat rhythm pattern, add Cymbal, Hi-Hat or Conga rhythm as ADD VOICE, or change the whole rhythm over to a shuffle beat. If you push this button again, the LED indicator goes out and the effect will be cancelled.

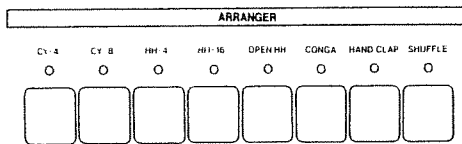

All of the buttons can be used in free combination with one another.

■ Cymbal and Hi-Hat arrangement

- CY-4" 4-beat Cymbal
- CY-8" 8-beat Cymbal
- HH-4" 4-beat Hi-Hat
- HH-16" 16-beat Hi-Hat
- Open HH 8-beat after-beat
Open Hi-Hat

If there is Cymbal type sound source among the preset rhythm patterns, the Cymbal type rhythm will change over to the selected rhythm when this button is pressed. If there is no Cymbal type sound source among the preset rhythms, you can add the rhythm of the ADD VOICE you have selected.

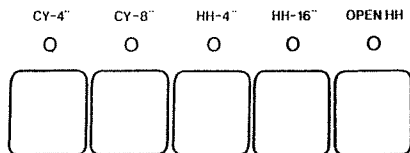

■ Conga and Hand Clap arrangement

Conga... A combination of Hi-Conga, Mid-Conga and Lo-Conga
Hand Clap... 4-beat Hand Clap (after beat)
When you press one of these buttons, you can add a Conga or Hand Clap rhythm as an ADD VOICE to any rhythm pattern.

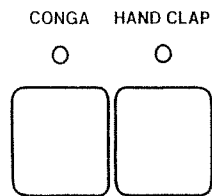

■ Shuffle arrangement

When you press this button, you can change all rhythms except for WALTZ, SWING-1, SWING-2, SLOW ROCK and Basic Rhythm which was programmed with 12-beat to a Shuffle beat.

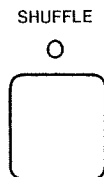

4. How to use the Crash Button

- By pushing this button, the crash sound of Cymbal can be inserted on the first beat when the rhythm is changed from Intro or Fill-In rhythm to Basic rhythm pattern. If you push this button again, the LED indicator goes out and the effect will be cancelled.

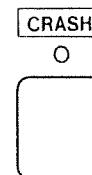

5. How to use the Register

- By pressing the Register button, two kinds of preset rhythm patterns can be played alternately.

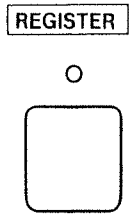

How to set

- ①Set the first rhythm pattern on the Bank Selector, Preset Rhythm Selector or Arranger.

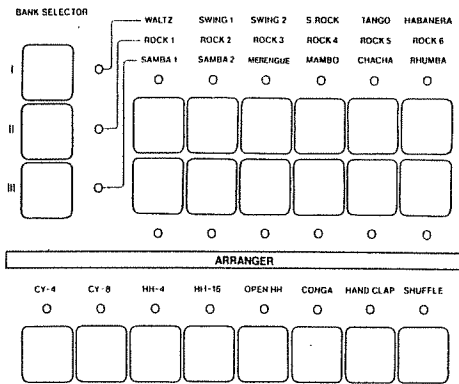

- ②Push the Register Button. The LED indicator will flash indicating that the second rhythm pattern can now be set.

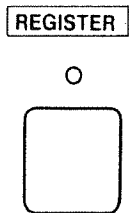

- ③Set the second rhythm pattern.

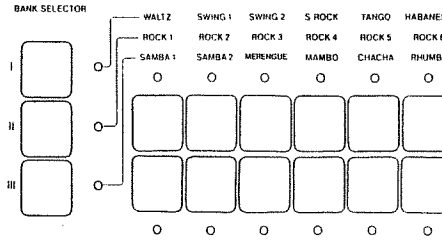

How to play

While a rhythm is being played, press the Register button when you want to change the rhythm, and the two rhythm patterns will play alternately. You can also change the set rhythm patterns any number of times.

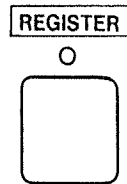

6. How to write the rhythm pattern

6-1 How to write Basic rhythm pattern

■To write any desired rhythm pattern into Program Rhythm Selector.

- ① Set the Program Mode Selector to "Basic" position.

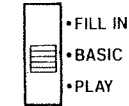

- ② Choose the one of Program Rhythm Selectors.

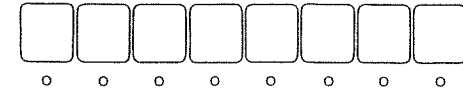

- ③ Stop the rhythm if it is running. (In this condition, the RED and GREEN LED will light.)

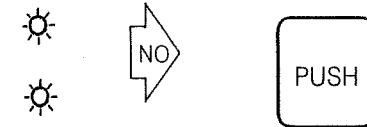
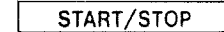

- ④ As written in fig. press the and buttons simultaneously for about 3 seconds. When these buttons are pressed there are instances when the LED for Basic Program Rhythm flash on and off. This will erase the previous programmed rhythm.

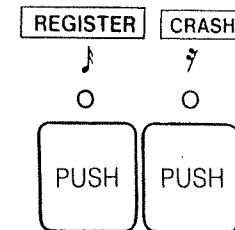

Applications

1. Substitute for a Metronome

Bass Drum 4" in Basic Rhythm Bank I can be used for a Metronome.

2. Odd Rhythm

You can produce an odd rhythm by using Pedal switch DP-2 which is connected with RE-START jack on the rear panel.

3. Delicate difference of rhythm variations by Register

Set two rhythms of the same type into Register.

First, select ROCK-5, HH-16" and OPEN HH. Then press the Register button. Select ROCK-3. Press the "Start/Stop" button to start rhythm. Change over these rhythms at will by pressing the Register button. So you will find a delicate nuance of rhythm variation.

4. Register's special effect

By connecting Trigger out of CR-8000 to Register jack on the rear panel, you can produce a different rhythm pattern. For example,

1. Set the Trigger out to 16".
2. Stop the rhythm if it is running.
3. Select "RHUMBA" of Basic Rhythm Bank.
4. Press the Register button.
5. Select "ROCK-3".
6. Start the rhythm by pushing Start/Stop button.

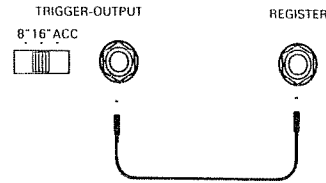

*So you can find a different beat of Hi-Hat of ROCK-3. Try to produce your own rhythm by changing a beat of Trigger Out combining any rhythm pattern.

5. To use Crash sound at the ending

Keep the Crash Switch on. Get Fill-in rhythm in pre-bar of last one. And stop rhythm soon after the Crash sound is given at the last bar so that you can get a feeling of natural ending.

6. The rhythm with 32 or 24 steps

By using the adjacent two bars as one bar, one bar can be divided into 32 or 24 steps. So you can write more complex rhythm pattern.

ex: Writing the rhythm pattern

● "TANGO" 32 steps per measure

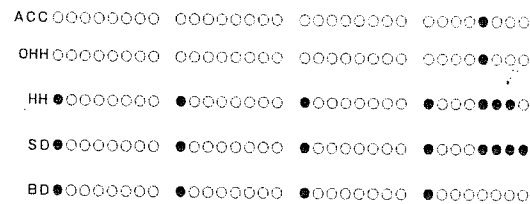

● "Bolero" 24 steps per measure

If you are using Shuffle function, writing mode is 24 steps per measure.

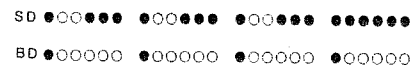

Others

■ About Tempo Display

- If you are programming the 4-beat rhythm with 12 or 16 step per measure, Tempo Display will display a precise tempo.
- If you are programming the adjacent two rhythm patterns as one measure, Tempo Display will display a double value of actual tempo.
- If you are programming the 3-beat rhythm with 12 (or 24) steps, actual tempo is 3/4 (or 3/8) values of displayed tempo.

■ Memory Back-up

The CR-8000 features a non-volatile memory which will retain rhythm programs after switched off or disconnected. The CR-8000 relies on batteries as a back-up circuit to protect these memories.

The CR-8000 batteries must be replaced once a year to ensure proper operation.

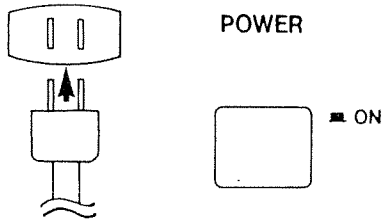

● To replace the three 1.5-Volt dry cell batteries;

- 1 Connect the CR-8000 to socket and switch is "ON" to protect its memories while replacing the batteries.
- 2 Open the battery cover on the bottom of the CR-8000 body using a coin or screwdriver.
- 3 Remove old batteries from the battery case. Always replace the entire set of batteries.
- 4 Insert new batteries, making sure that their polarities are correct as indicated in the battery case.
- 5 Close the cover, insert and tighten the retaining screw.

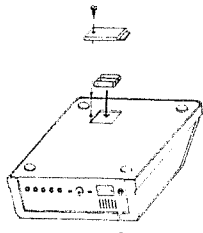

■ SYNCHRO INPUT/OUTPUT

Remember that the SYNC. In/Out Select switch must be in the OUTPUT position for the CR-8000 to operate by itself.

1. In case of operating CR-8000 by itself.

When CR-8000 operates by itself and Sync. In/Out switch is in the INPUT position, the CR-8000 can not function. So be sure to set to the OUTPUT position to operate by itself.

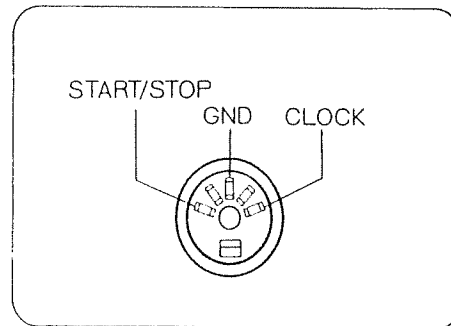
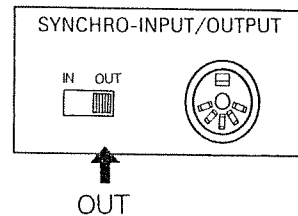

2. CR-8000 + other unit

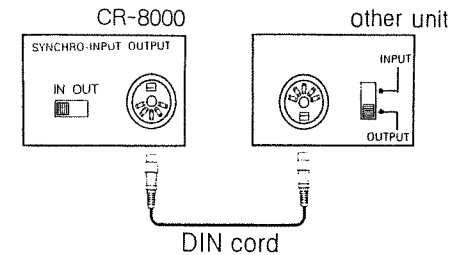

● In case of controlling CR-8000 by other unit

The Tempo of other unit is displayed in the LED display window of the CR-8000.

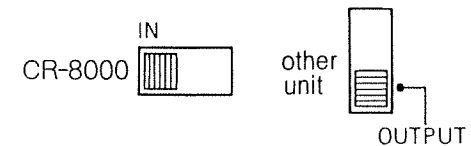

● In case of controlling other unit by CR-8000

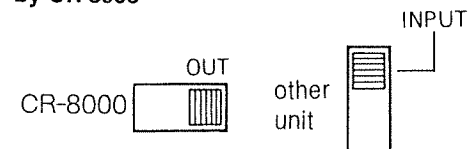

➔ If the connected unit provides either only SYNC OUT or IN, either of those examples shown above applies to the case.

CR-8000 PRE-SET RHYTHM PATTERN (● = ♩, No Mark = ♪)

WALTZ

CY
SD
BD

Step No → 1 2 3 4 5 6 7 8 9 10 11 12

ACC	●											
CY	●											
SD				●						●		
BD	●											

TANGO

OHH
SD
BD

Step No → 1 2 3 4 5 6 7 8 9 10 11 12 13 14 15 16

ACC																	
OHH																	
SD	●				●				●				●				
BD	●				●				●				●				

ROCK1

HH
SD
BD

Step No → 1 2 3 4 5 6 7 8 9 10 11 12 13 14 15 16

ACC	●				●				●				●				
HH																	
SD																	
BD	●								●				●				

SWING1

HH
OHH
BD

Step No → 1 2 3 4 5 6 7 8 9 10 11 12

ACC												
HH												
OHH	●				●				●			
BD	●				●				●			

HABANERA

HH
SD
BD

Step No → 1 2 3 4 5 6 7 8 9 10 11 12 13 14 15 16

ACC																	
HH																	
SD	●				●				●				●				
BD	●				●				●				●				

ROCK2

HH
SD
BD

Step No → 1 2 3 4 5 6 7 8 9 10 11 12 13 14 15 16

ACC	●				●				●				●				
HH																	
SD																	
BD	●								●				●				

SWING2

CY
BD

Step No → 1 2 3 4 5 6 7 8 9 10 11 12

ACC												
CY												
BD	●				●				●			

ENKA

HH
SD
BD

Step No → 1 2 3 4 5 6 7 8 9 10 11 12 13 14 15 16

ACC																	
HH	●				●				●				●				
SD	●				●				●				●				
BD	●				●				●				●				

ROCK3

HH
SD
BD

Step No → 1 2 3 4 5 6 7 8 9 10 11 12 13 14 15 16

ACC	●				●				●				●				
HH																	
SD																	
BD	●								●				●				

SLOW ROCK

CY
SD
BD

Step No → 1 2 3 4 5 6 7 8 9 10 11 12

ACC	●				●				●			
CY	●				●				●			
SD	●				●				●			
BD	●				●				●			

BD-4"

BD

Step No → 1 2 3 4 5 6 7 8 9 10 11 12 13 14 15 16

BD	●				●				●				●				
----	---	--	--	--	---	--	--	--	---	--	--	--	---	--	--	--	--

ROCK 4

[A] **[B]**

HH
SD
BD

[A] **[B]**

Step No → 1 2 3 4 5 6 7 8 9 10 11 12 13 14 15 16

ACC
HH
SD
BD

ROCK 5

[A] **[B]**

HH
SD
BD

[A] **[B]**

Step No → 1 2 3 4 5 6 7 8 9 10 11 12 13 14 15 16

ACC
HH
SD
BD

ROCK 6

HH
OHH
SD
BD

Step No → 1 2 3 4 5 6 7 8 9 10 11 12 13 14 15 16

ACC
HH
OHH
SD
BD

DISCO

OHH
SD
BD

Step No → 1 2 3 4 5 6 7 8 9 10 11 12 13 14 15 16

ACC
OHH
SD
BD

FOX TROT

HH
OHH
SD
BD

Step No → 1 2 3 4 5 6 7 8 9 10 11 12 13 14 15 16

ACC
HH
OHH
SD
BD

SAMBA 1

HH
CB
HC
MC
LC
BD

Step No → 1 2 3 4 5 6 7 8 9 10 11 12 13 14 15 16

ACC
HH
CB
HC
MC
LC
BD

SAMBA2

Musical notation for SAMBA2, featuring six staves: HH, CB, HC, MC, LC, SD, and BD. The notation includes rhythmic patterns with eighth and sixteenth notes, and accents.

Step No → 1 2 3 4 5 6 7 8 9 10 11 12 13 14 15 16

ACC	●	●	●	●	●	●	●	●	●	●	●	●	●	●	●
HH	●	●	●	●	●	●	●	●	●	●	●	●	●	●	●
CB	●	●	●	●	●	●	●	●	●	●	●	●	●	●	●
HC	●	●	●	●	●	●	●	●	●	●	●	●	●	●	●
MC	●	●	●	●	●	●	●	●	●	●	●	●	●	●	●
LC	●	●	●	●	●	●	●	●	●	●	●	●	●	●	●
SD	●	●	●	●	●	●	●	●	●	●	●	●	●	●	●
BD	●	●	●	●	●	●	●	●	●	●	●	●	●	●	●

MERE-NGUE

Musical notation for MERE-NGUE, featuring four staves: HH, CB, MC, LC, and BD. The notation includes rhythmic patterns with eighth and sixteenth notes, and accents.

Step No → 1 2 3 4 5 6 7 8 9 10 11 12 13 14 15 16

ACC	●	●	●	●	●	●	●	●	●	●	●	●	●	●	●
HH	●	●	●	●	●	●	●	●	●	●	●	●	●	●	●
CB	●	●	●	●	●	●	●	●	●	●	●	●	●	●	●
MC	●	●	●	●	●	●	●	●	●	●	●	●	●	●	●
LC	●	●	●	●	●	●	●	●	●	●	●	●	●	●	●
BD	●	●	●	●	●	●	●	●	●	●	●	●	●	●	●

MAMBO

Musical notation for MAMBO, featuring six staves: HH, CB, HC, MC, LC, and BD. The notation includes rhythmic patterns with eighth and sixteenth notes, and accents. It is divided into two sections, A and B.

Step No → 1 2 3 4 5 6 7 8 9 10 11 12 13 14 15 16

ACC	●	●	●	●	●	●	●	●	●	●	●	●	●	●	●
HH	●	●	●	●	●	●	●	●	●	●	●	●	●	●	●
CB	●	●	●	●	●	●	●	●	●	●	●	●	●	●	●
HC	●	●	●	●	●	●	●	●	●	●	●	●	●	●	●
MC	●	●	●	●	●	●	●	●	●	●	●	●	●	●	●
LC	●	●	●	●	●	●	●	●	●	●	●	●	●	●	●
BD	●	●	●	●	●	●	●	●	●	●	●	●	●	●	●

CHA
CHA

Musical notation for CHA CHA, featuring four staves: HH, CB, LC, and BD. The notation includes rhythmic patterns with eighth and sixteenth notes, and accents.

Step No → 1 2 3 4 5 6 7 8 9 10 11 12 13 14 15 16

ACC	●	●	●	●	●	●	●	●	●	●	●	●	●	●	●
HH	●	●	●	●	●	●	●	●	●	●	●	●	●	●	●
CB	●	●	●	●	●	●	●	●	●	●	●	●	●	●	●
LC	●	●	●	●	●	●	●	●	●	●	●	●	●	●	●
BD	●	●	●	●	●	●	●	●	●	●	●	●	●	●	●

RHUMBA	
BEGUINE	
BOSSA NOVA	

ARRANGER

CY-4"	
CY-8"	
HH-4"	
HH-16"	
OHH	

INTRO/FILL IN

CONGA

HC
MC
LC

Step No → 1 2 3 4 5 6 7 8 9 10 11 12 13 14 15 16

HC
MC
LC

HAND CLAP

Step No → 1 2 3 4 5 6 7 8 9 10 11 12 13 14 15 16

1

CY
SD
BD

Step No → 1 2 3 4 5 6 7 8 9 10 11 12

ACC
CY
SD
BD

2

OHH
SD
BD

Step No → 1 2 3 4 5 6 7 8 9 10 11 12 13 14 15 16

ACC
OHH
SD
BD

3

CY
HH
OHH
SD
HT
LT
BD

Step No → 1 2 3 4 5 6 7 8 9 10 11 12 13 14 15 16

ACC
CY
HH
OHH
SD
HT
LT
BD

4

SD
BD

Step No → 1 2 3 4 5 6 7 8 9 10 11 12 13 14 15 16

ACC
SD
BD

5

SD
HT
LC
BD

Step No → 1 2 3 4 5 6 7 8 9 10 11 12 13 14 15 16

ACC
SD
HT
LC
BD

6

SD
HT
LT
BD

Step No → 1 2 3 4 5 6 7 8 9 10 11 12 13 14 15 16

ACC
SD
HT
LT
BD

SAMPLE RHYTHM

7	<p>CY </p> <p>HH </p> <p>OHH </p> <p>SD </p> <p>HT </p> <p>LT </p> <p>BD </p>
	<p>Step No → 1 2 3 4 5 6 7 8 9 10 11 12 13 14 15 16</p> <p>ACC </p> <p>CY </p> <p>HH </p> <p>OHH </p> <p>SD </p> <p>HT </p> <p>LT </p> <p>BD </p>
8 (BREAK)	

1 ROCK	<p>[A] </p> <p>[B] </p> <p>HH </p> <p>OHH </p> <p>SD </p> <p>BD </p>
	<p>[A] </p> <p>[B] </p> <p>Step No → 1 2 3 4 5 6 7 8 9 10 11 12 13 14 15 16</p> <p>ACC </p> <p>HH </p> <p>OHH </p> <p>SD </p> <p>BD </p>
2 BOSSA NOVA	<p>[A] </p> <p>[B] </p> <p>HH </p> <p>OHH </p> <p>RS </p> <p>BD </p>
	<p>[A] </p> <p>[B] </p> <p>Step No → 1 2 3 4 5 6 7 8 9 10 11 12 13 14 15 16</p> <p>ACC </p> <p>HH </p> <p>OHH </p> <p>RS </p> <p>BD </p>

32BEAT

A **B**

HH
OHH
LT
SD
BD

Step No → 1 2 3 4 5 6 7 8 9 10 11 12 13 14 15 16

ACC
HH
OHH
LT
SD
BD

ROCK II

A **B**

HH
OHH
SD
BD

Step No → 1 2 3 4 5 6 7 8 9 10 11 12

ACC
HH
OHH
SD
BD

ROCK I

A **B**

HH
OHH
SD
BD

Step No → 1 2 3 4 5 6 7 8 9 10 11 12

ACC
HH
OHH
SD
BD

INTRO/FILL IN

A **B**

HT
LT
SD
BD

Step No → 1 2 3 4 5 6 7 8 9 10 11 12 13 14 15 16

ACC
HT
LT
SD
BD

SPECIFICATIONS

● BASIC			
■ PRESET RHYTHM SELECT BUTTONS	:8		
■ RHYTHM BANK SELECT BUTTONS :3			
BANK 1 WALTZ, SWING 1, SWING 2, TANGO, HABANERA, ENKA, BD-4"			
BANK 2 ROCK 1~6, DISCO, FOX TROT			
BANK 3 SAMBA 1, SAMBA 2, MERENGUE, MAMBO, CHACHA, RHUMBA, BEGUINE, BOSSANOVA			
■ PROGRAM RHYTHM SELECT BUTTONS	:8		
● SOUND SOURCES			
BASS DRUM, SNARE DRUM, LOW TOM, HI TOM, HI-HAT, OPEN HI- HAT, CYMBAL, RIM SHOT, LOW CONGA, MIDDLE CONGA, HI CONGA, COWBELL, CLAVES, HAND CLAP			
● INTRO/FILL-IN			
■ INTRO/FILL-IN SELECTOR	:1		
PRESET 1~8 PROGRAM 9~12			
■ INTRO/FILL-IN MEASURES SELECTOR	:1		
OFF, 16, 12, 8, 4, 2			
● ARRANGERS			
■ ARRANGER SELECT BUTTON	:8		
CY-4", CY-8", HH-4", HH-16", OPEN HH, CONGA, HAND CLAP, SHUFFLE			
● CONTROL BUTTONS	:4		
INTRO/FILL-IN MANUAL, START/ STOP, REGISTER, CRASH			
● VOICE LEVELS	:8		
■ BASS DRUM			
■ SNARE DRUM/RIM SHOT/TOM TOM			
■ CONGA			
■ COWBELL/CLAVES			
■ CYMBAL/HI HAT/OPEN HI-HAT			
■ HAND CLAP			
● ACCENT VOLUME			
● LEVEL CONTROL			
● TEMPO CONTROL			
● PROGRAM MODE SWITCH			
■ MODE SELECTOR	:1		
FILL-IN, BASIC, PLAY			
■ INSTRUMENT SELECTOR	:1		
BASS DRUM, SNARE DRUM, LOW TOM, HI TOM, HI-HAT, OPEN HI-HAT, CYMBAL, COWBELL, MIDDLE CONGA, LOW CONGA, HAND CLAP, ACCENT			
● INDICATORS			
■ TEMPO DISPLAY	:1		
■ TEMPO LED	:1		
■ BEAT LED	:1		
● REAR PANEL			
■ OUTPUT JACK			
OUTPUT IMPEDANCE Less than 6kΩ OUTPUT LEVEL 4Vp-p (10kΩ)			
■ CONTROL JACKS	:4		
START/STOP RESTART INTRO/FILL-IN REGISTER			
■ TRIGGER OUTPUT JACK	:1		
(f + 5V, 10ms Pulse)			
■ TRIGGER PULSE SELECT SWITCH	:1		
(8", 16", ACC)			
● SYNC. IN/OUT			
DIN CONNECTOR (for CSQ-600, MC-4)	:1		
INPUT OUTPUT SELECTOR	:1		
● POWER CONSUMPTION	:12W		
● DIMENSIONS			
:13 (W) × 10 ¹⁵ / ₁₆ (D) × 4 ¹ / ₄ (H) ins.			
:331 (W) × 278 (D) × 108 (H) mm			
● WEIGHT	:3.7 kg		
:8 lb.2 oz.			
● ACCESSORY	: 2.5m connection cord × 1		

*Specifications are subject to change without notice.

OPTION



PEDAL SWITCH DP-2

Roland®

RUS10075

UPC

RUS10075

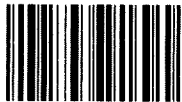

18981

Roland®