

Roland

PITCH TO MIDI CONVERTER

CP-40

OWNER'S MANUAL

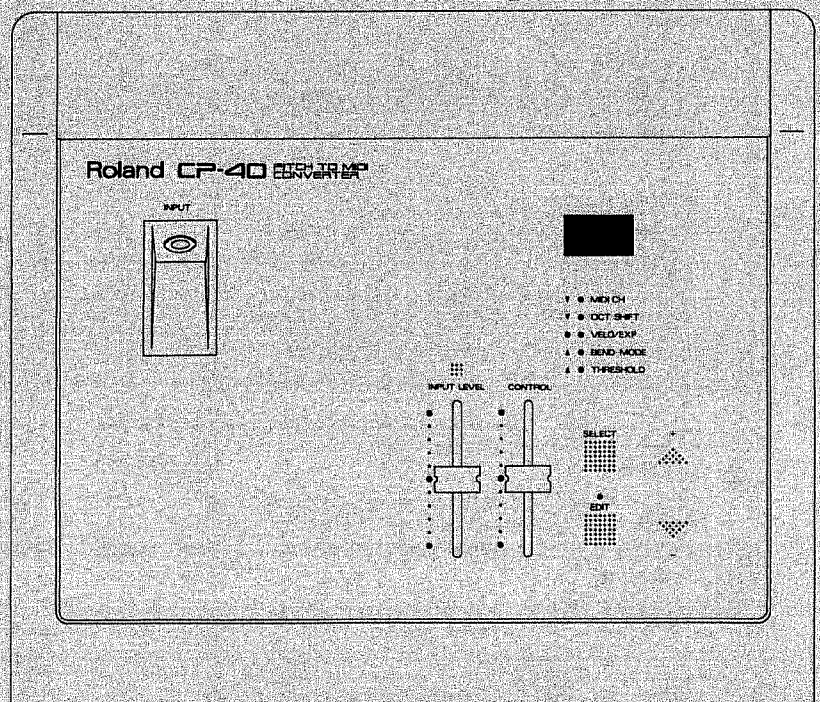

For the U.K.

IMPORTANT: THE WIRES IN THIS MAINS LEAD ARE COLOURED IN ACCORDANCE WITH THE FOLLOWING CODE.

BLUE : NEUTRAL
BROWN : LIVE

As the colours of the wires in the mains lead of this apparatus may not correspond with the coloured markings identifying the terminals in your plug proceed as follows:

The wire which is coloured BLUE must be connected to the terminal which is marked with the letter N or coloured BLACK.
The wire which is coloured BROWN must be connected to the terminal which is marked with the letter L or coloured RED.

For West Germany

Bescheinigung des Herstellers/Importeurs

Hiermit wird bescheinigt, daß der/die/das
PITCH TO MIDI CONVERTER CP-40
.....
(Gerät, Typ, Bezeichnung)

in Übereinstimmung mit den Bestimmungen der
Amtsbl. Vfg 1046/1984
.....
(Amtsblattverfügung)

funk-entstört ist.

Der Deutschen Bundespost wurde das Inverkehrbringen dieses Gerätes angezeigt und die Berechtigung zur Überprüfung der Serie auf Einhaltung der Bestimmungen eingeräumt.

Roland Corporation Osaka/Japan
.....

Name des Herstellers/Importeurs

For the USA

RADIO AND TELEVISION INTERFERENCE

WARNING — This equipment has been verified to comply with the limits for a Class B computing device, pursuant to Subpart J, of Part 15, of FCC rules. Operation with non-certified or non-verified equipment is likely to result in interference to radio and TV reception.

The equipment described in this manual generates and uses radio frequency energy. If it is not installed and used properly, that is, in strict accordance with our instructions, it may cause interference with radio and television reception. This equipment has been tested and found to comply with the limits for a Class B computing device in accordance with the specifications in Subpart J, of Part 15, of FCC Rules. These rules are designed to provide reasonable protection against such a interference in a residential installation. However, there is no guarantee that the interference will not occur in a particular installation. If this equipment does cause interference to radio or television reception, which can be determined by turning the equipment on and off, the user is encouraged to try to correct the interference by the following measure:

- Disconnect other devices and their input/output cables one at a time. If the interference stops, it is caused by either the other device or its I/O cable.
- These devices usually require Roland designated shielded I/O cables. For Roland devices, you can obtain the proper shielded cable from your dealer. For non Roland devices, contact the manufacturer or dealer for assistance.
- If your equipment does cause interference to radio or television reception, you can try to correct the interference by using one or more of the following measures:
 - Turn the TV or radio antenna until the interference stops.
 - Move the equipment to one side or the other of the TV or radio.
 - Move the equipment farther away from the TV or radio.
 - Plug the equipment into an outlet that is on a different circuit than the TV or radio. (That is, make certain the equipment and the radio or television set are on circuits controlled by different circuit breakers or fuses.)
 - Consider installing a rooftop television antenna with coaxial cable lead-in between the antenna and TV. If necessary, you should consult your dealer or an experienced radio/television technician for additional suggestions. You may find helpful the following booklet prepared by the Federal Communications Commission: "How to Identify and Resolve Radio — TV Interference Problems"

This booklet is available from the U.S. Government Printing Office, Washington, D.C., 20402, Stock No. 004-000-00345-4.

For Canada

CLASS B

NOTICE

This digital apparatus does not exceed the Class B limits for radio noise emissions set out in the Radio Interference Regulations of the Canadian Department of Communications.

CLASSE B

AVIS

Cet appareil numérique ne dépasse pas les limites de la classe B au niveau des émissions de bruits radioélectriques fixés dans le Règlement des signaux parasites par le ministère canadien des Communications.

Thank you, and congratulations on your choice of the CP-40 Pitch-to-MIDI Converter.

To take full advantage of the superb features offered by the CP-40, and to ensure satisfaction for years to come, please read this Owner's Manual in its entirety before starting out.

■ CONTENTS

■ FEATURES OF THE CP-40	2
■ IMPORTANT NOTES	3
1. PANEL DESCRIPTIONS	6
(1) Front Panel	6
(2) Rear Panel	7
2. GETTING STARTED	8
(1) MIDI Data Transmitted by the CP-40	8
(2) Making Connections	9
(3) Powering Up	11
3. THE TWO MODES	12
(1) Normal Mode	12
(2) Edit Mode	13
4. ADJUSTING INPUT LEVEL	14
5. CONFIGURING MIDI DATA	16
(1) MIDI Channel	17
(2) Octave Shift	17
(3) Velocity/Expression	17
(4) Bend Mode	18
(5) Threshold	18
6. EXAMPLE SETUPS	19
(1) Use with a Desktop Music System	19
(2) Use with a MIDI Sequencer	20
7. COMMON PROBLEMS AND SOLUTIONS	21
■ MIDI IMPLEMENTATION	22
■ SPECIFICATIONS	24

Copyright © 1990 by ROLAND CORPORATION

All rights reserved. No part of this publication may be reproduced in any form without the permission of ROLAND CORPORATION.

■ *Features of the CP-40*

● **The CP-40 converts audio signals from microphone or line-level input sources into MIDI signals in real time**

Audio information, whether from someone singing or playing an electric guitar, is instantaneously converted into MIDI signals. This conveniently allows you to gain control over other MIDI devices — without requiring a MIDI equipped keyboard, or guitar controller.

● **Volume and Pitch Changes are also Controllable**

The volume level of input audio signals can be output as either Velocity or Expression messages. Moreover, since even small shifts in pitch (those less than a semi-tone) can be transmitted as Pitch Bend messages, every nuance of your music is captured.

● **Convenient for input into a Desktop Music System**

The MIDI data generated by the CP-40 can be used as an input source for real-time recording in Desktop Music Systems (such as Roland's "TENTRAX") or MIDI sequencers (such as the MC-500mk II).

■ **IMPORTANT NOTES**

When using an AC adaptor, be sure that it is one supplied by the manufacturer. Use of any other power adaptor could result in damage, malfunction, or electric shock.

[Power Supply]

- When making any connections with other devices, always turn off the power to all equipment first; this will help prevent damage or malfunction.
- Do not use this unit on the same power circuit with any device that will generate line noise, such as a motor or variable lighting system.
- The power supply required for this unit is shown on its nameplate. Ensure that the line voltage of your installation meets this requirement.
- Avoid damaging the power cord; do not step on it, place heavy objects on it etc.
- When disconnecting the AC adaptor from the outlet, grasp the plug itself ; never pull on the cord.
- If the unit is to remain unused for a long period of time, unplug the power cord.

[Placement]

- Do not subject the unit to temperature extremes (eg. direct sunlight in an enclosed vehicle). Avoid using or string the unit in dusty or humid areas or areas that are subject to high vibration levels.
- Using the unit near power amplifiers (or other equipment containing large transformers) may induce hum.
- This unit may interfere with radio and television reception. Do not use this unit in the vicinity of such receivers.
- Do not expose this unit to temperature extremes (eg. direct sunlight in an enclosed vehicle can deform or discolor the unit) or install it near devices that radiate heat.

[Maintenance]

- For everyday cleaning wipe the unit with a soft, dry cloth (or one that has been slightly dampened with water). To remove stubborn dirt, use a mild neutral detergent. Afterwards, be sure to wipe the unit thoroughly with a soft, dry cloth.
- Never use benzene, alcohol or solvents of any kind, to avoid the risk of discoloration and/or deformation.

[Additional Precautions]

- Protect the unit from strong impact.
- Do not allow objects or liquids of any kind to penetrate the unit. In the event of such an occurrence, discontinue use immediately. Contact qualified service personnel as soon as possible.
- Should a malfunction occur (or if you suspect there is a problem) discontinue use immediately. Contact qualified service personnel as soon as possible.

[About the Supplied Microphone]

- Before using the supplied microphone you need to install a battery. (Dry battery:R03(AAA)type)
- The microphone is provided with its own power switch (turns current from battery on and off). Always make sure to slide it to the "OFF" position when the microphone is not being used.

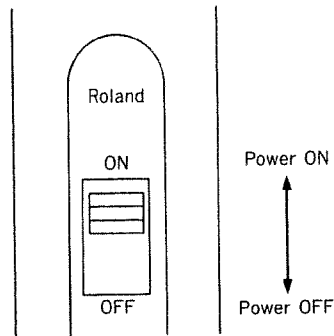

- On average, the battery should last for about 5,000 hours. However, anytime you notice that the microphone has decreased in sensitivity, or that the sounds picked up are not converted to MIDI correctly, replace the battery with a new one.
- If you do not intend to use the microphone for an extended period of time, remove the battery as a precaution against leakage and possible damage.

◆How to Replace the Battery◆

- ① Remove off the windscreen covering the tip of the microphone.

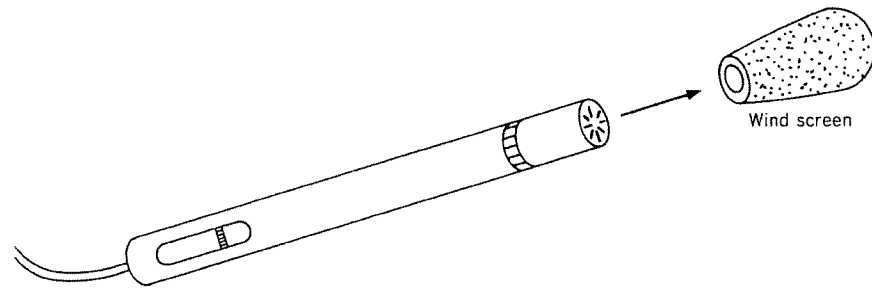

- ② Screw off the microphone's cap by turning it counterclockwise.

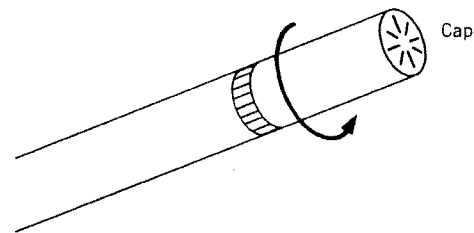

- ③ Remove the battery, and while carefully observing the polarity ("+" versus "-"), replace it with a new one.

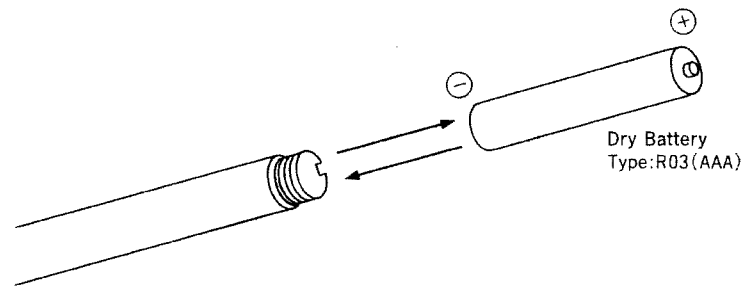

- ④ Once the new battery is in place, reverse steps ① and ② to screw on the cap and replace the windscreen.

1. PANEL DESCRIPTIONS

(1) Front Panel

● Input Jack

This jack accepts input of the audio signal. Connect the supplied microphone (or one of your own) or the patch cord from an electric instrument (guitar, etc.) to this jack.

● Parameter Indicators

These LEDs indicate the parameters selected in the Edit mode. They also indicate the degree to which the input signal has drifted from a known reference pitch.

● Display

The Display indicates the current mode status, the note name of the pitch being input, the MIDI parameter settings.

● Select Button

This button allows selection of the parameters that are set in the Edit mode.

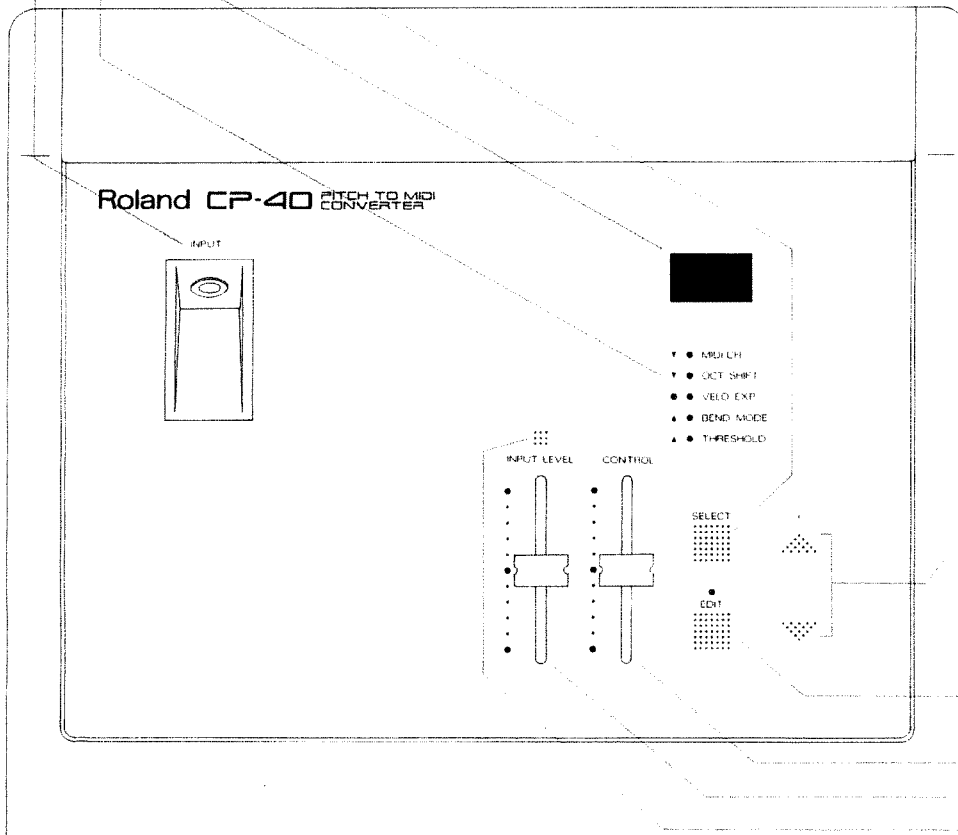

● **Value Buttons**

These buttons are used to alter the values of the parameters in the Edit mode.

● **Edit Button**

This button switches the unit between the Edit mode and the Normal mode.

● **Control Slider**

This slider is used to send MIDI data — Control Change No. 16. When connected to the Tentrax Desktop Music System, the Control Slider can be used to select note or rest durations in step time recording.

● **Input Level Slider**

This slider adjusts the input level.

● **Input Level Indicator**

When the indicator is green, the input signal is at an appropriate level. When the indicator is red, the input level is excessive.

(2) Rear Panel

● **DC IN Jack**

Accepts connection of the supplied AC adaptor.

● **MIDI Connectors**

Connectors for transmitting and receiving MIDI messages.

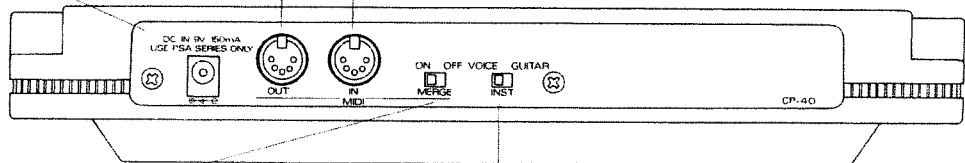

● **INST Switch**

This switch is provided to accommodate different input sources*. When a microphone is connected to the Input jack, the switch should be set to VOICE. When using an electronic instrument, set it to GUITAR.

* Please note that this switch is not a sensitivity selector. It is designed to accommodate a particular envelope characteristic of the input signal.

● **Merge Switch**

This switch determines whether or not data received at MIDI IN will be sent from MIDI OUT. When set to ON, data received at MIDI IN will be sent from MIDI OUT.

2. GETTING STARTED

(1) MIDI Data Transmitted by the CP-40

The types of MIDI data capable of being transmitted by the CP-40 are explained in the following.

● MIDI Data Output As a Representation of Source Signals Being Input

Audio signals entering the CP-40 are converted, then output as the following types of MIDI data :

- **Note Messages** : Note On, Note Off, Velocity
- **Control Change Messages** : Expression (Control No. 11)
- **Pitch Bend Messages**

*When Velocity/Expression (VELO/EXP) is set at E1/E2, EXPRESSION messages will be generated in a form reflecting the amplitude of the sound. However, when VELO/EXP is set at V1/V2, no EXPRESSION messages will be generated. Instead, the sound's amplitude will be output in terms of VELOCITY. (see page 17, "Velocity/Expression")

● Control Slider

By moving the Control Slider, the following MIDI data is transmitted:

Control Change Messages : General-Purpose Controller No. 1 (Control No. 16).

○ About the MIDI Implementation Chart

MIDI is able to transmit and receive data between various types of devices, but not all devices are able to transmit and receive the same types of data. The owner's manual of each MIDI device has a "MIDI Implementation Chart" which shows the types of data that the device is able to transmit and receive. (see page 23.)

All Implementation Charts are a standard size, so that you can place two charts side by side to see how two devices will be able to communicate with each other.

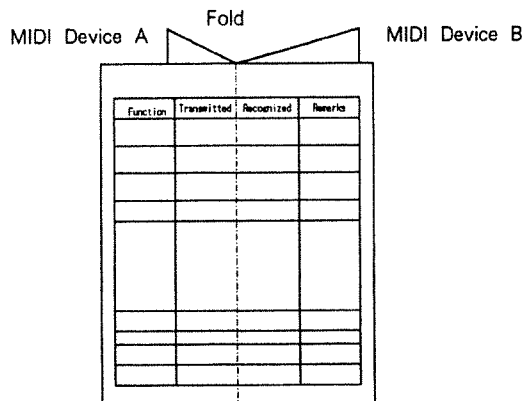

(2) Making Connections

While referring to the diagrams below, make the proper connections for the setup you have in mind.

● Setup which uses a desktop music system, such as Tentrax

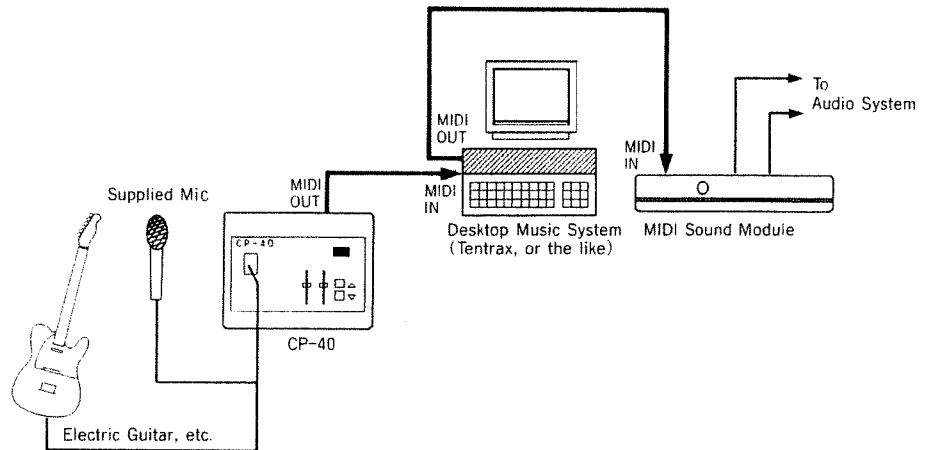

● Setup using a MIDI sequencer

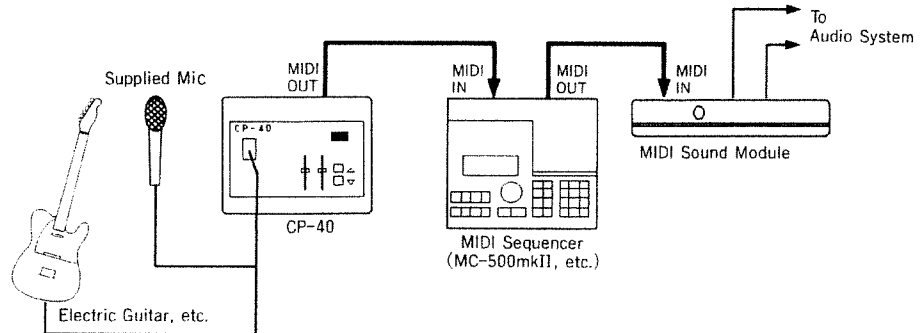

● Settings for the INST switch

The INST switch on the rear of the unit should be set to the proper position; the one which is suitable for the type of device you have connected to the Input jack.

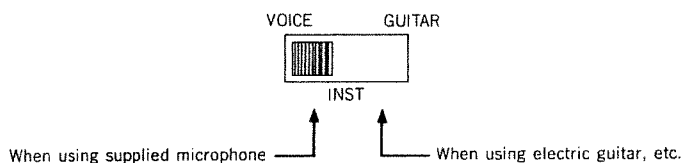

VOICE: Position to use when you have the supplied microphone connected. (Sustained signal device.)

GUITAR: Use this position for guitars and like instruments. (Devices with decaying signal.)

● Merge Switch

With the Merge switch on the unit's rear panel put at the "ON" position, all MIDI data that arrives at the unit's MIDI IN will be mixed with the data it generates internally, and the resulting merged data is output from MIDI OUT. The setup below shows the connections you would make if you want to send to a MIDI sequencer, or similar device, all the performance information generated by the CP-40, in combination with data from another MIDI device (such as a MIDI equipped keyboard).

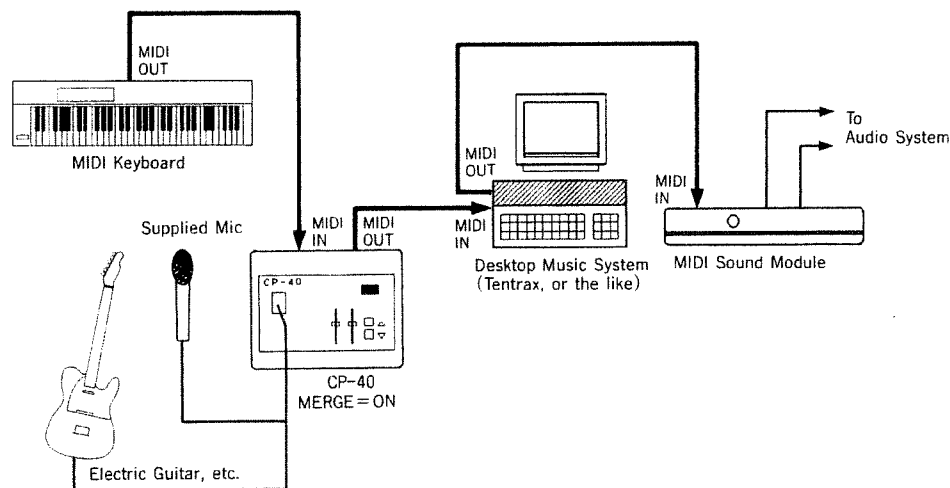

(3) Powering Up

After making sure all MIDI cables are connected properly, turn on the power for any MIDI devices you have connected. Then, turn on power to the CP-40.

① **Insert the plug on the power cord into an outlet.**

② **Connect the AC adaptor to the DC IN jack.**

The display, as well as the parameter indicators will light.

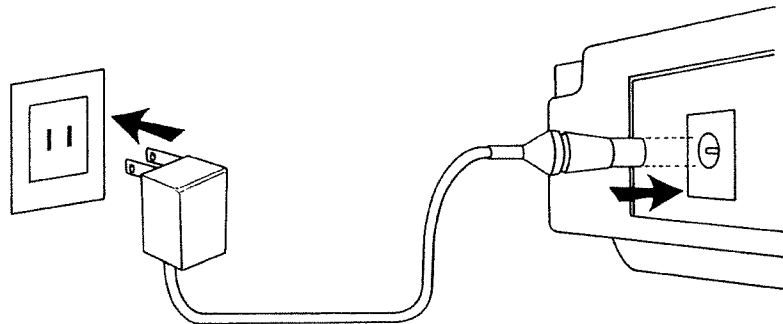

* This unit requires a few moments after it is turned on before it is ready for operation, due to its circuitry protection feature.

3. THE TWO MODES

The CP-40 has two modes of operation — Normal and Edit. In the Normal mode, audio signals arriving from a source, either voice or guitar, are converted in real-time into MIDI data. In the Edit mode, a variety of settings are made, including those determining the types of MIDI data to be generated.

To switch between the two modes, press the EDIT button.

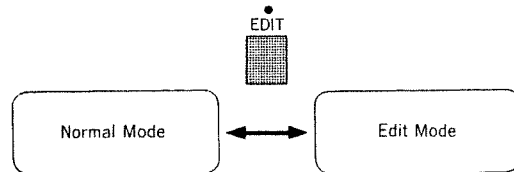

(1) Normal Mode

The main work of the unit, the conversion to MIDI data of audio signals that are input from either voice or guitar, is accomplished while in this mode. While in this mode you can also monitor the notes composing the music being input.

● When No Sound Is Being Input

If no sound has yet been input to the unit, or if more than 3 seconds has passed since the last signals were received, the display will show you the setting that is in effect for the INST switch.

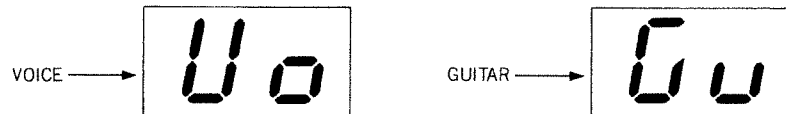

* When the supplied microphone is connected to the Input jack, the INST switch needs to be put at VOICE. When using an electric guitar or similar instrument, put it at GUITAR. If you should have the INST switch set incorrectly, you will not be able to obtain a reliable conversion to MIDI data.

● While Sound Is Being Input

While sound arrives at the unit's input jack, the display provides you with a readout of the notes.

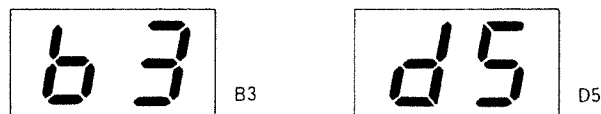

* The dot appearing between the letter and the number stands for a "#"

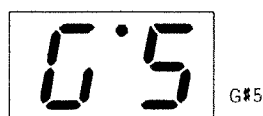

Note that with respect to a note shown in the display, you can also refer to the five parameter indicators to check if the note strays from the normal pitch, and if so by how much.

Normal Pitch	Pitch Is High	Pitch Is Low
▼ ○ MIDI CH	▼ ○ MIDI CH	▼ ○ MIDI CH
▼ ○ OCT. SHIFT	▼ ☀ OCT. SHIFT	▼ ○ OCT. SHIFT
● ☀ VELO/EXP	● ○ VELO/EXP	● ○ VELO/EXP
▲ ○ BEND MODE	▲ ○ BEND MODE	▲ ○ BEND MODE
▲ ○ THRESHOLD	▲ ○ THRESHOLD	▲ ☀ THRESHOLD

(2) Edit Mode

The Edit mode is where you make the settings selecting how you want the audio signals that are input to be converted to MIDI data.

Two separate sets of settings need to be made for the Edit mode. One is for the times the INST switch is set to VOICE, and another for the times it is set to GUITAR.

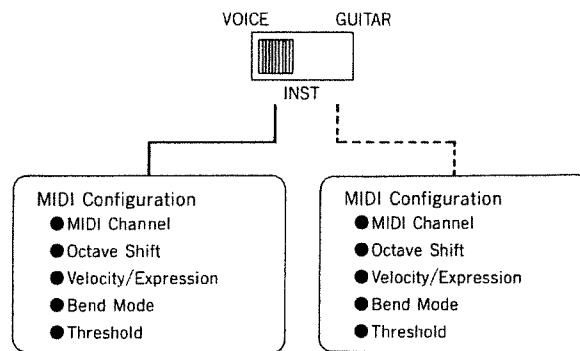

For details on how to make the settings determining how MIDI data will be transmitted, refer to “5. CONFIGURING MIDI DATA.” (see page 16)

* Any settings you make for the Edit mode are not retained once power is turned off, they always revert to their default values.

* MIDI data can also be transmitted while in the Edit mode.

4. ADJUSTING INPUT LEVEL

In order to obtain the most reliable conversion into MIDI data, it is important that you adjust the unit so the Input Level is at the most appropriate level for the particular audio signal you intend to use.

- ① **Make sure you have the INST switch set to the position that is best for the type of device you have connected.**

When the supplied microphone, or any other microphone is connected to the Input Jack, the switch should be put at VOICE. When using an electric guitar, or other electronic musical instrument, put it at GUITAR.

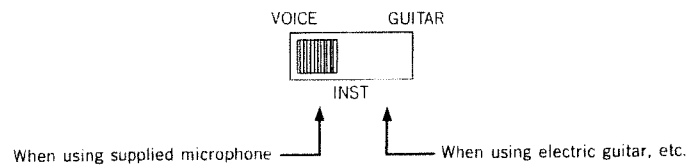

- ② **Move the Input Slider to adjust the level of the input signal while you input sound coming from the microphone or guitar.**

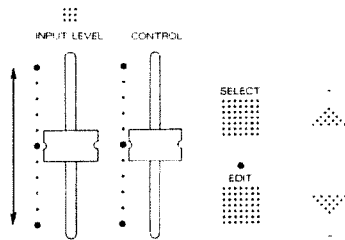

The input level is monitored by viewing the Input Level Indicator.

Green : Means a signal of a level greater than the threshold level (the level at which conversion to MIDI starts) is being input.

Red : Indicates that the signal is of an excessive level.

To adjust the level: While watching the Input Level Indicator, move the Input Level Slider until you find the position where the indicator lights in red only every now and then.

* Whenever the input signals are below the threshold level, the CP-40 does not attempt to make any conversion of those signals to MIDI data.

Note also that the environment in which the unit is used can influence how it responds. Errors can be produced due to surrounding noise, and the resulting MIDI conversion may not be as expected. If such problems are experienced, try adjusting the Threshold Level. (see page 18)

[Getting the Best Input]

● Using a Microphone

Have the mouth fairly close to the microphone, and try to produce sounds with a strong attack. It also helps to clearly separate each tone produced.

* If lyrics are simply sung in a consecutive, normal fashion, the conversion to MIDI may not always be correct.

● Using an Electric Guitar

Try to avoid having multiple notes played by muting individual notes one by one.

* As long as individual notes are sounded, many devices other than a microphone or guitar could be used. However, you may not always be able to obtain a satisfactory conversion to MIDI.

5. CONFIGURING MIDI DATA

The available range of settings, accessed through the Edit mode, allow you to control how the audio signals you input will be converted to MIDI data.

● Using the Edit Mode

- ① From the Normal mode, press the EDIT button. This puts you in the Edit mode.
- ② Select the parameter for which you wish to change settings by pressing the Select button.

The parameter indicator corresponding to the currently selected parameter will be lit.

In the display you see the value that is currently active for the selected parameter.

- ③ Using the Value buttons (+ / -), make any desired changes in the value.
- ④ When finished, once again press the Edit button. This takes you out of the Edit mode.

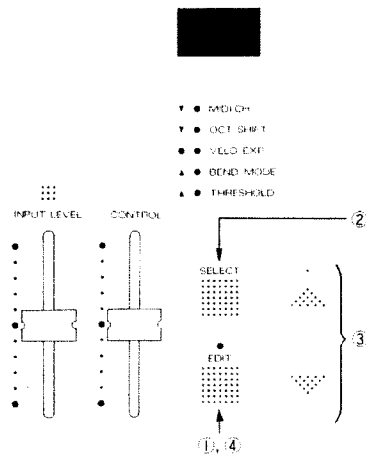

* Changes in a number of parameters can be made simply by repeating steps ② and ③ before leaving the Edit mode.

* Once you have finished making setting changes, you should always press the EDIT button and return to the Normal mode. That way you avoid accidentally altering settings while using the unit.

* Information about the settings for all the Edit mode parameters is stored in two separate sets, one for the VOICE and one for the GUITAR positions on the INST switch.

* All setting changes for the Edit mode parameters are no longer remembered once power is turned off; they revert to their default values.

(1) MIDI Channel (MIDI CH)

This setting determines the channel on which the MIDI data will be sent out.

Any number from 1 through 16 can be selected.

(2) Octave Shift (OCT. SHIFT)

Amount (in octaves) by which transmitted note messages will be shifted either upwards or downwards in pitch.

The amount of shift ranges from -2 to $+2$.

(3) Velocity/Expression (VELO/EXP)

The fluctuations in sound volume occurring in the input audio signals can be converted to either Velocity or Expression MIDI messages. The choice between them is made using this setting. In addition, each type of message generation has other options which select how fluctuations in the input level will be interpreted during the conversion process.

The various settings available for Velocity/Expression, and how each works is outlined below :

V0 : Velocity is transmitted and always remains at a value of 96, regardless of the input level. In other words, the MIDI data does not reflect volume changes in the original.

V1 : Note messages with a Velocity of 64-127, the value being in direct correspondence with the input level, are transmitted.

V2 : Note messages with a Velocity of 1-127, the value being in direct correspondence with the input level, are transmitted.

E1 : MIDI messages with an Expression value of 64-127, representing the input level, are transmitted. The Velocity of the note messages is fixed at 127.

E2 : MIDI messages with an Expression value of 1-127, representing the input level, are transmitted. The Velocity of the note messages is fixed at 127.

*Note that when V0, V1, or V2 are selected, no Expression messages will be generated.

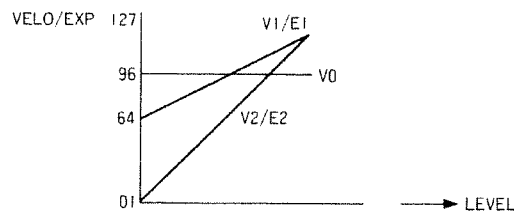

*Velocity and Expression changes cannot be obtained at the same time.

(4) Bend Mode (BEND MODE)

This setting determines how the MIDI data that is generated translates the fluctuations in pitch occurring in the original input.

The following settings are available:

- 1:** Only Note messages are transmitted; in half-tone steps.
At this setting no pitch bend information is generated.
- 2:** Note messages are transmitted in half-tone steps. In between, Pitch Bend messages are sent.
If the pitch of the input sound changes consecutively, retriggering takes place at half-tone steps.
- 3:** Pitch Bend messages are generated. They can fluctuate within a range of 1 octave above or below the base.

(5) Threshold (THRESHOLD)

This setting determines the level at which Note messages (Note On, Note Off) will start being generated.

It is set as a number from 1 through 3. The higher the number, the greater the level needs to be for Note messages to be transmitted.

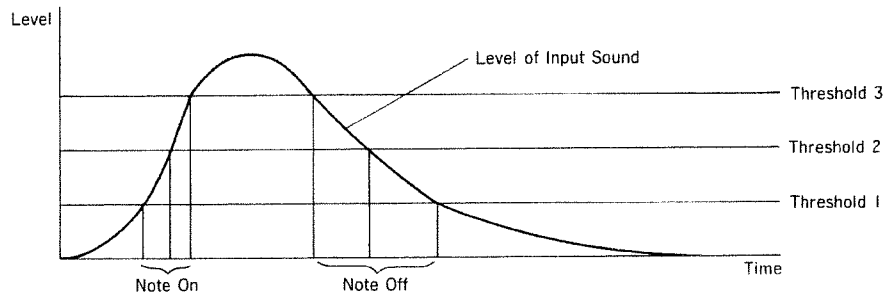

* When the way MIDI messages are being sent out seems inappropriate, perhaps because of surrounding noise, try setting the Threshold to a higher number.

● Default Settings

Each time the power on the CP-40 is turned on, the settings for all the Edit mode parameters will default to the settings shown below :

	Voice	Guitar
MIDI Channel	4	5
Octave Shift	0	0
Velocity/Expression	V2	V2
Bend Mode	3	3
Threshold	2	3

6. EXAMPLE SETUPS

(1) Use With a Desktop Music System

By adding the CP-40 to a desktop music system, such as “Tentrax,” you gain a convenient way of entering performance information in real-time, using voice, guitar or whatever.

It can also be conveniently used in combination with a MIDI keyboard — the keyboard is useful for entering chords for piano or string parts, while the CP-40 is good for melodies or wind instrument parts composed of single notes.

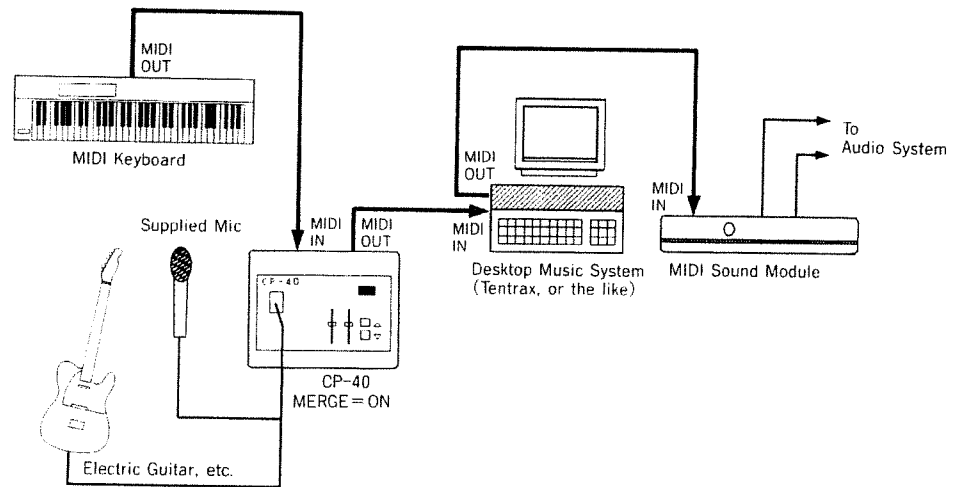

If Tentrax is used as your desktop music system, the Control Slider can be used to select note or rest durations in step time recording.

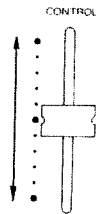

(2) Use With a MIDI Sequencer

When used with a MIDI sequencer, the CP-40 can be used for input in the same way as the examples for a desktop music system above.

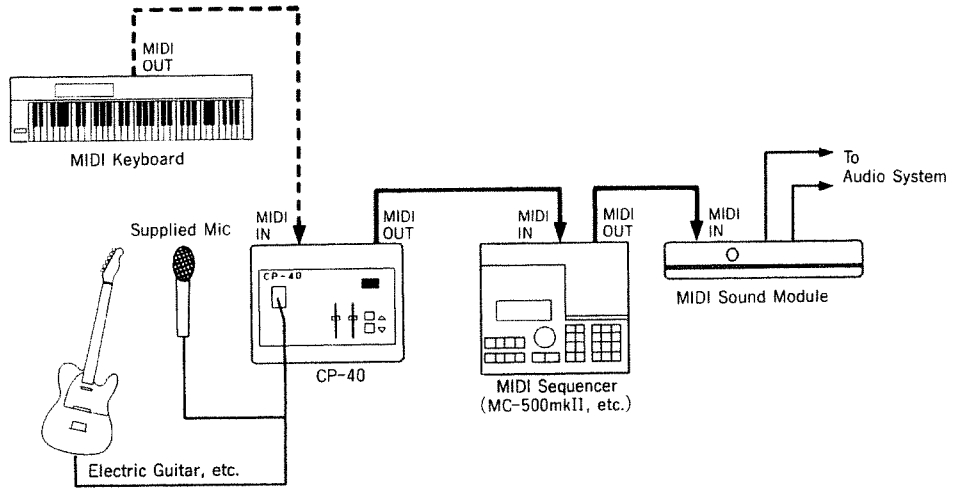

7. COMMON PROBLEMS AND SOLUTIONS

● Sound isn't produced

- ① Check once again to make sure that MIDI cables, and audio cable coming from the source are connected properly.
- ② Check to make sure the MIDI channel set for the CP-40 matches the channel being used for reception on the device you want to generate sound.
(see page 17, "MIDI Channel")
- ③ Readjust the Input Level.
Adjust it so the Input Level Indicator lights while you input audio signal.
(see page 14, "4. ADJUSTING INPUT LEVEL")

● Conversion is unsatisfactory

- ① Make sure the INST switch is at the appropriate position. Whenever a microphone is connected, the switch should be put at VOICE. When using an electric guitar, put it at GUITAR.
- ② Readjust the Input Level.
Adjust it so the Input Level Indicator lights while you input audio signal.
(see page 14, "4. ADJUSTING INPUT LEVEL")
- ③ Try changing the Threshold level.
If the unit tends to be triggered by extraneous sounds, set the Threshold higher.

1. Transmitted Data

1.1 Bypassed message

All received messages except ALL NOTES OFF and ACTIVE SENSING are sent out from MIDI OUT while MERGE SW is on.

1.2 Message which is created and sent out from MIDI OUT.

CP-40 has 2 modes of VOICE and GUITAR. MIDI channel for each mode can be set independently. When the power is first applied, the channel for each mode is as follows.

Mode	Channel
VOICE	4
GUITAR	5

Channel voice message

● Note off

Status	Second	Third
9nH	kkH	00H

n = MIDI Channel : 0H - FH (0 - 15) 0 = ch.1 15 = ch.16
 kk = Note number : 07H - 77H (7 - 119)

● Note on

Status	Second	Third
9nH	kkH	vvH

n = MIDI Channel : 0H - FH (0 - 15) 0 = ch.1 15 = ch.16
 kk = Note number : 07H - 77H (7 - 119)
 vv = Velocity : 01H - 7FH (1 - 127)

- * If VELO/EXP is V0, Velocity is always 60H (96).
- * If VELO/EXP is E1 or E2, Velocity is always 7FH (127).
- * The range may be changed by OCT.SHIFT.
- * The OCT.SHIFT value can be set within the range of -2 to +2 by panel operation.

The following chart shows the relation between the transmitted note range and OCT.SHIFT value.

OCT.SHIFT Value	Transmitted note range
-2	7 - 71
-1	19 - 83
0	31 - 95
+1	43 - 107
+2	55 - 119

● Control change

○ Expression

Status	Second	Third
BnH	0BH	vvH

n = MIDI Channel : 0H - FH (0 - 15) 0 = ch.1 15 = ch.16
 vv = Control Value : 00H - 7FH (0 - 127)

* If VELO/EXP is V0 or V1 or V2, this message is not transmitted.

○ Control

Status	Second	Third
BnH	10H	vvH

n = MIDI Channel : 0H - FH (0 - 15) 0 = ch.1 15 = ch.16
 vv = Control Value : 00H - 7FH (0 - 127)

● Pitch Bender change

Status	Second	Third
EnH	11H	mmH

n = MIDI Channel : 0H - FH (0 - 15) 0 = ch.1 15 = ch.16
 11H = Pitch Bender change value (Lower byte) 00H - 7FH (0 - 127)
 mmH = Pitch Bender change value (Upper byte) 00H - 7FH (0 - 127)

* If BEND MODE is 1, this message is not transmitted.

■ System common message

● Active sensing

Status

FEH

* Active sensing transmits within the interval of 300 msec.

MIDI Implementation Chart

Function ...		Transmitted	Recognized	Remarks
Basic Channel	Default Changed	4 (5) 1 - 16	x x	* 1
Mode	Default Messages Altered	4 x *****	x x	
Note Number	True Voice	7 - 119 *****	x x	
Velocity	Note ON Note OFF	* 2 x 9n v = 0	x x	
After Touch	Key's Ch's	x x	x x	
Pitch Bender		* 3	x	
Control Change	11 16	* 2 ○	x x	Expression Control
Prog Change	True #	x *****	x x	
System Exclusive		x	x	
System Common	Song Pos Song Sel Tune	x x x	x x x	
System Real Time	Clock Commands	x x	x x	
Aux Message	Local ON/OFF All Notes OFF Active Sense Reset	x x ○ x	x x x x	
Notes		* 1 Channel 4 in VOICE mode, 5 in GUITAR mode. It can be changed individually for each mode. * 2 Depends on VELO/EXP setup. * 3 Depends on BEND MODE setup.		

Mode 1 : OMNI ON, POLY
 Mode 3 : OMNI OFF, POLY

Mode 2 : OMNI ON, MONO
 Mode 4 : OMNI OFF MONO

○ : Yes
 x : No **23**

■ SPECIFICATIONS

CP-40:Pitch-to-MIDI Converter

Indicators:

Pitch Name (7-seg)
Input level
Mode indicators

Parameters:

MIDI ch (1-16)
OCT.Shift (2 - -2)
VELO/EXP (V2-E2)
Bend Mode (1-3)
Threshold (1-3)

Jacks:

MIDI IN/OUT
Audio in (-60dBm - -35dBm)

Power Supply:

9V DC (Supplied AC Adaptor: PSA series)

Current Draw:

100mA

Dimensions:

284(W)×239(D)×50(H)mm
11-3/16"×9-7/16"×2"

Weight:

1 kg/2.2 lb 35 oz

Accessories:

AC Adaptor (PSA series)<PSA-120(120V)/PSA-220(220V)/PSA-240(240V-A)>
Microphone(CP-40M)
Dry Battery R03(AAA)type
MIDI Cable(1.5m)
Owner's Manual

* In the interest of product improvement, the specifications of this unit are subject to change without prior notice.

Information

- Please use this AC Adaptor only with the specified device.
- Please use the AC Adaptor of appropriate voltage (120, 220 or 240) depending on the voltage system in your country.
- When the device is not used for a long period, be sure to disconnect the AC Adaptor (Power Supply Unit) from the wall outlet.
- When you need repair service, call your local Roland Service Station or the authorized Roland distributor in your country as shown below.

U. S. A.

Roland Corp US
7200 Dominion Circle
Los Angeles, CA. 90040 - 3647
U. S. A.
☎ (213)685 - 5141

CANADA

Roland Canada Music Ltd.
(Head Office)
13880 Mayfield Place
Richmond B. C., V6V 2E4
CANADA
☎ (604)270 - 6626

Roland Canada Music Ltd.
9425 Trans - Canada,
St Laurent, Quebec H4S 1V3
CANADA
☎ (514)335 - 2009

Roland Canada Music Ltd.
346 Watline Avenue
Mississauga, Ontario L4Z 1X2
CANADA
☎ (416)625 - 4880

AUSTRALIA

Roland Corporation
(Australia) Pty. Ltd.
(Head Office)
38 Campbell Avenue
Dee Why West, NSW 2099
AUSTRALIA
☎ (02)982 - 8266

Roland Corporation
(Australia) Pty. Ltd.
(Melbourne Office)
50 Garden Street
South Yarra, Victoria 3141
AUSTRALIA
☎ (03)241 - 1254

NEW ZEALAND

Roland Corporation (NZ) Ltd.
97 Mt. Eden Road, Mt. Eden,
Auckland 3
NEW ZEALAND
☎ (09)398 - 715

UNITED KINGDOM

Roland(UK)Ltd.
Amalgamated Drive
West Cross Centre, Brentford,
Middlesex TW8 9EZ,
UNITED KINGDOM
☎ (01)568 - 4578

WEST GERMANY

Roland Elektronische
Musikinstrumente
Handelsgesellschaft mbH.
Oststrasse 96,
2000 Norderstedt
WEST GERMANY
☎ 040/52 60 09 25

BELGIUM/HOLLAND/ LUXEMBOURG

Roland Benelux N. V.
Houtstraat 1
B - 2431 Oevel - Westerlo
BELGIUM
☎ 014 - 58 45 35

DENMARK

Roland Scandinavia A/S
Langebrogade 6
Box 1937
DK - 1023 Copenhagen K.
DENMARK
☎ 31 - 95 31 11

SWEDEN

Roland Scandinavia A/S
DanvikCenter 28 A, 2 tr.
S - 131.30 Nacka,
SWEDEN
☎ 08 - 702 00 20

NORWAY

Roland Scandinavia
Avd. Norge
Lilleakerveien 2
Postboks 95 Lilleaker
N - 0216 Oslo 2
NORWAY
☎ 02 - 73 00 74

FINLAND

Fazer Musik Inc.
Länsituulentie
POB 169
SF - 02101 Espoo
FINLAND
☎ 0 - 43 50 11

ITALY

Roland Italy S. P. A.
Viale delle Industrie 8
20020 ARESE MILANO
ITALY
☎ (02) 93581311

SWITZERLAND

Musitronic AG
Gerberstrasse 5, CH - 4410
Liestal
SWITZERLAND
☎ 061/921 16 15

FRANCE

Musikengro
102, Avenue Jean - Jaures
69367 Lyon Cedex 07
FRANCE
☎ (7)858 - 54 60

Musikengro
(Paris Office)
Centre Region Parisienne
41 rue Charles - Fourier,
94400 Vitry s/Seinc
FRANCE
☎ (1)4680 86 62

SPAIN

Roland Electronics de España S. A.
Bolivia 239
08020 Barcelona
SPAIN
☎ 93 - 308 - 1000

AUSTRIA

E. Dematte & Co.
Neu - Rum Siemens - Strasse 4
A - 6021 Innsbruck Box 591
AUSTRIA
☎ 43(05222)63 451

GREECE

A. Andreas/V. Dimitriadis & Co. Ltd.
2 Fidiou Str., 106 78
Athens
GREECE
☎ 3620130

PORTUGAL

Casa Caius Instrumentos Musicais Lda.
Rua de Santa Catarina 131
Porto
PORTUGAL
☎ 2 - 38 44 56

HUNGARY

Intermusica Ltd.
Warehouse Area 'DEPO'
Budapest, P.O. Box 3,
2045 Torokbalimt
Budapest
HUNGARY
☎ (1) - 1868905

 Roland®

RUS10092

UPC

RUS10092



10991

CP-40

Roland Corporation

2604012100 90-8-BA2-12SE(SY)