

Compu Music CMU-800R

OPERATION MANUAL



 Roland

SOFTWARE PACKAGE

CM-APLD OWNER'S MANUAL

Connecting the CMU-800 and the APPLE II

- 1) Make sure that the both CMU 800 and the APPLE II are turned off.
- 2) Then connect the flat cable of the CMU-800 to the Interface Board (IF-APL). In this case be sure to place \triangle mark on the colored lead of the flat cord and \triangle on the Interface Board in the same directions as illustrated in Fig. A.
- 3) Now insert the Interface Board connected to the CMU-800 to the 5th slot in the APPLE II. In this case, be sure to set the \rightarrow on the interface Board and \rightarrow on the APPLE II's connector in the same directions as shown in Fig. B. If the 5th slot is engaged, other slot will do.

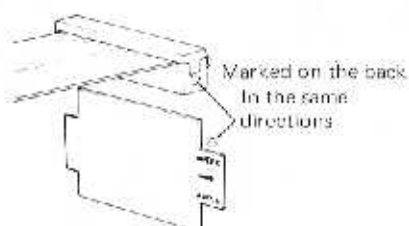

Fig. A

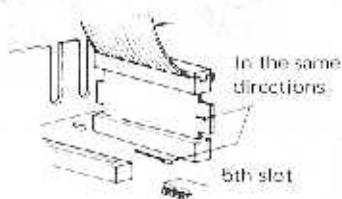

Fig. B

Loading the Software

With the CMU 800's software package, is the disk that holds the program. It has been designed to start automatically when the computer is turned on.

Now turn the CMU-800 on. Carefully insert the disk into the drive slot with the computer turned off. Now turn it on.

It will whirl and click for several seconds with the screen blank. If this does not happen, or if it spins for what seems like a long time and nothing happens, check the manual with the computer to insure proper starting procedures.

Assuming all has gone well so far, you should now have the COMPU-MUSIC system logo on the screen. The cursor (that small blinking square or line) is now in the middle of the screen over a number in the phrase:

SLOT NUMBER: (a number)

This number corresponds with the slot number that the program is expecting the COMPU-MUSIC adaptor to be in. If it is not the same, merely type in the correct number. To save time in the future, it might be wise to change the cable to the slot number on the screen (check the installation guide). Now that the correct number is on the screen, hit the return key <cr>. What appears on the screen now is the main command menu. It allows the user to perform the different COMPU-MUSIC functions by typing in the letter of the command desired.

*Make sure that the connector and the Interface Board are connected correctly as instructed above. Also, check if the APPLE II's monitor is turned on and the connections have been made properly.

*The program of this COMPU-MUSIC can be driven only by the APPLE II 48k system. If your computer does not include this, please add it in this occasion.

Compu Music

CMU-800R

OPERATION MANUAL

 Roland

CONTENTS

BEGINNING LEVEL

COMPU-MUSIC: computer music system	3
Loading the software	6
Playing some music	6
Main command menu	11
Note translation	13
Command exercises	16
Editor	19
Entering music	19
Mistyping a number	24
Changing data	24
Insert and screen edit mode	25
Leaving the editor	25

INTERMEDIATE LEVEL

Editing commands	28
Insert and screen edit	30
Editor commands	31
Using point edit	35
Creating drum patterns	36

ADVANCED LEVEL

Saving files	41
Articulation	41
Rhythms	42
Chords	43
Trills	43
Glissando	44
Grace notes	45
External effects	46
External synthesizers	47

APPENDIX

A-Menu commands	51
B-Editing commands	52
C-CV & Time base charts	53
D-Sample drum rhythms	55
E-Glossary of musical terms	57
E-Glossary of computer terms	59
G-Technical specifications	60

INTRODUCTION

We no longer need to think of the computer as the future, it is here now! It is in nearly every facet of our lives to help us, teach us, and entertain us.

The idea of using computer for making music is not a new one. Scientists and artistic collaborators have been working on this problem for some time and with a variety of approaches. We are now ready to reap the benefits of their labors.

The computer is an organizer and a controller. It does not care if it is processing algebraic equations, bank statements, or information for chords and melodies. It can operate with equal ability in each field because it can not distinguish between them it is all just data to the computer. For music, what is needed is some way of connecting the computer to the "real world", that is, a link between its brain and our ears.

That link is the **COMPU-MUSIC CMU-800**. It is an elegantly simple, yet sophisticated synthesizer for computer linkage. It comes with "software" which is the program to connect the synthesizer to your computer. It lets you enter, change, and store the music you write, and then play it back through the CMU-800 "hardware".

Unlike anything available before, the **COMPU-MUSIC** is an openended system. Other electronic instruments (sequencers, synthesizers, etc.) can not be changed or enhanced without expensive electrical modification or replacement with a newer version. With **COMPU-MUSIC**, the hardware is just the beginning. It is only half the system. New software can be created for various applications to allow the system to continually grow and expand without replacing anything.

It is among the finest controllers for electronic music available today. Not only is it a polyphonic computer instrument, it also is the heart of an expandable digital-analogue interface for those interested in advanced applications of computer control with other synthesizers in both commercial and experimental electronic music. It is simple to use and highly versatile at the same time.

There is no need to say welcome to the future. It is in your hands now.

CHAPTER 1
COMPU-MUSIC COMPUTER MUSIC SYSTEM

1 COMPU-MUSIC COMPUTER MUSIC SYSTEM

The **COMPU-MUSIC** system comes in two separate parts; "hardware" and "software". The **CMU-800** is the hardware. It contains the electronics for sound production. It must have the corresponding "software" to link the synthesizer to a personal computer. On the disk is the software; the program that allows the user to create music, change it, store it, and finally play it back. The software that comes with the **COMPU-MUSIC** has several music examples already on it making it ready to use and enjoy right away. Also available are album disks of music for the CMU-800. In this manual, references to the **CMU-800** refer to the hardware, the box that hooks up to the computer. **COMPU-MUSIC** refers to the entire hardware/software package.

Be sure that the software you have purchased is correct for your computer. Different computers will accept only the software that is right for them. **COMPU-MUSIC** has been created for several brands of home computer, with versions of the program to fit each one. There is no difference in the software for the user, it will look the same for any computer.

With each software package, there will be instructions for hooking up the CMU-800 to that computer. **READ THE INSTRUCTIONS CAREFULLY.** It is easy to damage both the synthesizer and your computer if the hook up is done incorrectly.

In addition to a computer, you will need some way of listening to the music. The CMU-800 has outputs in the back to plug it in to any amplifier, stereo, or tape recorder. It is now ready to use. Optional additions to this basic set-up would be a mixer, equalizer, effects (echo, reverb, phaser, etc.), and an external synthesizer. These are not necessities, but will greatly add to the abilities of the system. See **figure 1**.

Fig. 1. Diagram of basic COMPU-MUSIC setup

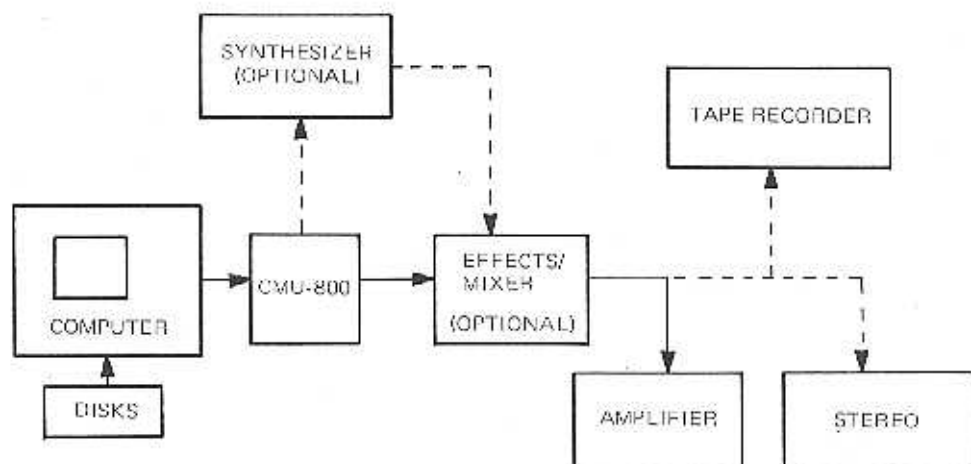

The CMU-800 consists of several parts:

- 1) A six voice synthesizer.
- 2) A seven voice drum synthesizer.
- 3) A clock for controlling tempo.
- 4) A mixer for combining the different sounds
- 5) Eight control outputs for external synthesis.
- 6) Audio outputs for listening to the sound.

Fig. 2. Front panel of CMU-800

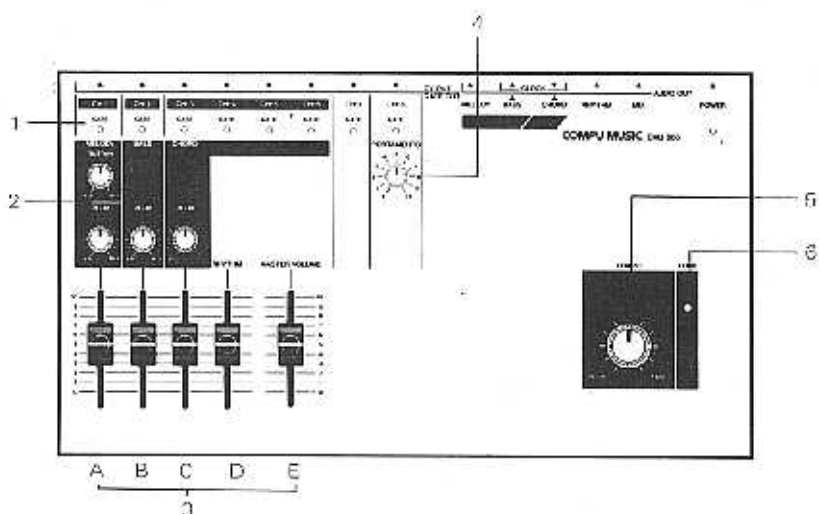

Figure 2 shows the front panel of the CMU-800. The knobs and sliders on the front panel only function while music is playing.

- 1) Along the top of the unit there are eight LED indicators. They correspond to the eight channels of music the instrument can create. They will light up when the gate of that channel is on.
- 2) There are separate decay (*) controls for the melody, bass, and chord channels. These control the amount of time it takes for a note to fade away after it has begun. It is like holding down a key on a piano after a note has been struck. It continues to ring for some time after the note has started. In addition, the melody channel has a sustain control that allows for a slightly longer held, "organ-like" sound.
- 3) The sliders along the bottom are for controlling the volume and mix of the audio output.
 - A) Slider 1 controls the volume of channel 1 (also called the melody channel).
 - B) Slider 2 controls the volume of channel 2 (also called the bass channel).

(*) See Glossary

C) Slider 3 controls the volume of channels 3, 4, 5, and 6.

They are programmed individually, but their audio outputs are mixed together.

**** NOTE** – Channels 7 and 8 have no sound sources. They are used for external control of synthesizers and effects.

D) Slider 4 controls the volume of the drum synthesizer.

E) Slider 5 is the master volume. It controls the overall volume of the output. When this control is all the way down, nothing is heard.

4) Channel 8 has a portamento knob. This controls the amount of "smoothing out" of the output. This allows using the channel for gradual changes in tempo or volume. See Chapter 5 for more on this.

5) This knob controls the tempo (speed) of the piece as it is played. The tempo can be set any way for any piece, and can be changed while the music is playing.

6) Under this small plug is the tuner for the internal synthesizer. A small screwdriver is needed to make any adjustments. It has been tuned at the factory.

Fig. 3. Rear Panel of CMU-800

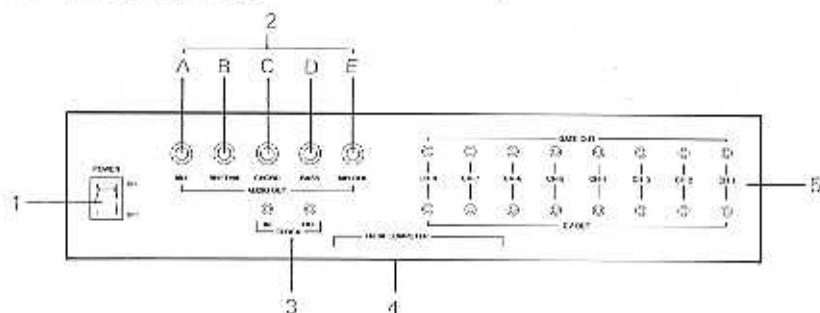

Figure 3 shows the back panel of the CMU-800. The jacks are for both audio and control outputs.

1) **Power on/off.** This turns the power to the unit on. There is an LED on the front panel indicating when it is on.

2) AUDIO OUT

A) **MIX**--This is the audio output for all channels. It is controlled by the sliders on the front panel. Use this jack to plug into the amplifier.

B) **RHYTHM**--This is the output for the drum synthesizer alone. It is not affected by the sliders on the front.

C) **CHORD**--This is the combined output of channels 3, 4, 5 and 6. It is not affected by the sliders on the front.

D) **BASS**--This is the output for channel 2. It is not affected by the sliders on the front.

E) **MELODY**--This is the output for channel 1. It is not affected by the sliders on the front.

3) CLOCK -IN OUT-

The pulse signal from the clock oscillator comes from the output jack. It is useful for synchronizing the CMU-800 with other equipment.

- 4) At the bottom of the rear panel there is a wide, flat ribbon which is the cable to connect to the computer. At the end of the cable is the adapter for the slot (or bus) to plug into the inside of the computer.
- 5) To control external synthesizers, a gate pulse and control voltage (CV) are needed. These are the outputs from all eight channels to do that. The outputs would be connected to the gate and control voltage inputs of the external synthesizer, or synthesizers (up to eight). Channels 1 through 6 also have the internal sound generators.

2 LOADING THE SOFTWARE

Refer to the instructions included in the Software Package

3 PLAYING SOME MUSIC

We'll try one of the commands right now to see if everything is working. To play a piece of music with the COMPU-MUSIC, it must be loaded into the computer from the disk (which takes just a few seconds) and then played.

Type:

```
[L]          to Load (no return is needed here)
```

The computer responds with a list of all the programs on the disk. All the names ending in ".CMU" are music. Now type the name of a piece to hear:

Type:

```
TUNE 1      which is an example music program
```

```
[CR]        and hit return
```

Type only the name. The ".CMU" is added automatically by the computer to distinguish music files from non-music files. COMPU-MUSIC is now loading the music into the computer. When it is finished, the disk will stop spinning and the main command menu will return. This means it is ready to go. Set the controls on the front panel as indicated in **figure 4**.

Fig. 4. Front panel setting for TUNE 1

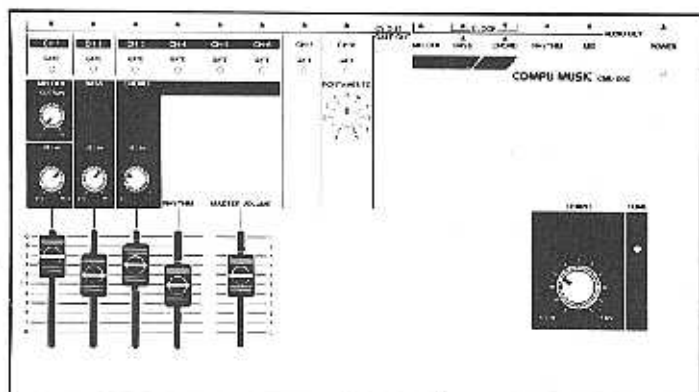

Tune 1

Type:

[P]

to play the music

You should be hearing music now. If not, check that the power is on and the volume sliders on the **CMU-800** are up as shown. See that the amplifier is on and connected properly. If the LEDs on the CMU are flashing then you should be hearing something. If they are not, then something went wrong in the set up. Turn the computer and the **CMU-800** off and follow the instructions again.

While the music is playing, experiment with the volume sliders, and the decay knobs to get an understanding of what they do and how they work. Change the tempo with the tempo knob. The piece can be stopped at any time by hitting the [esc] key. To start it again from the beginning type [P] again. Typing [Q] instead of [P] will cause the piece to repeat over and over until the [esc] is hit.

Try loading and playing other examples on the disk.

Fig. 5. Front panel setting for BACH and THE ENTERTAINER

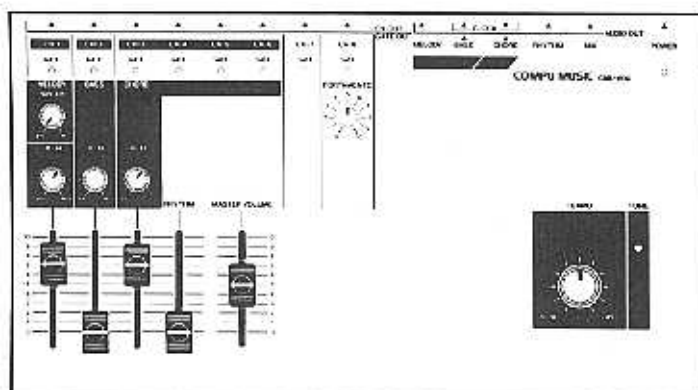

BACH

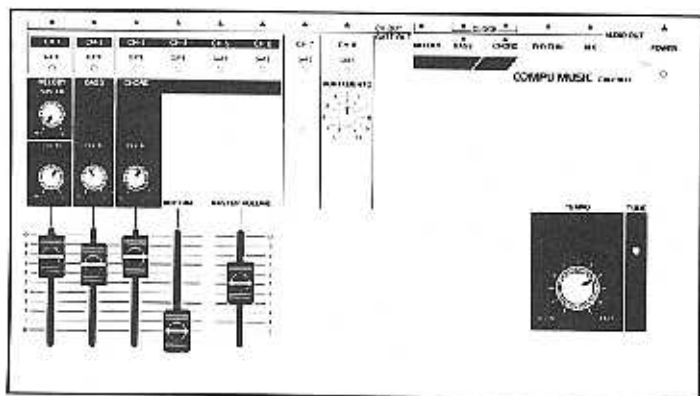

THE ENTERTAINER

CHAPTER 2

COMMANDS AND NOTE TRANSLATION

1 MAIN COMMAND MENU

When the music is not playing, the main command menu should be on the screen. If not, hitting `[esc]` will display it. Each command in the COMPU-MUSIC system is executed by typing a single letter. These commands will only work if the main command menu is on the screen. You loaded and played some music by using two of the commands, `[L]` and `[P]`. The music was stopped with the `[esc]` command. Here is a listing of all the commands in the main menu. Read through them carefully, then try the exercises at the end of the chapter.

`[0]` - `[9]` EDITOR

There are eight voice channels and two rhythm channels. Music is entered into these with the COMPU-MUSIC editor. The editor is entered by typing the number of the channel desired.

`[E]` POINT EDIT

It is possible to stop a piece while it is being played and go directly in and edit the last note heard. By typing `[I]` at any point while the music is playing, the piece will stop and the screen will respond with the question:

EDIT CHANNEL?

By typing the channel number desired, the editor will be directly on the last note played in the channel requested. Moving to any other channel will still have the editor in the same position. This is especially useful for fixing errors in longer scores. The editor is fully explained in the next chapter.

`[P]` PLAY

This command plays the music that is currently in memory, which is either the last piece loaded or the piece currently being edited. The play command is cancelled by typing `[esc]`. Typing `[P]` again starts the piece from the beginning.

`[Q]` LOOP PLAY

The `[Q]` command works the same as `[P]` except that it continues to play the music again and again until the `[esc]` command is given.

`[T]` TUNE

Typing `[T]` causes all the channels to sustain a middle `[C]` until the `[esc]` command is given. This is for using the CMU 800 with external synthesizers or with instrumentalists (write a concerto for yourself!).

[B] BIAS CHANGE

It is possible to change the pitch (or key) of a piece at the time it is played. After loading a piece, type [B]. The computer will respond with

```
OLD BIAS=0      INPUT NEW BIAS:
```

By entering [1] followed by a return [cr], the music will be raised one semi-tone (a half-step) up when it is played again. 12 will transpose it an octave. Positive and negative numbers up to 24 are legal. Type a minus sign (-) before the number for lowering the bias (pitch). Entering any number larger than 24 will set the bias at 24. Bias is set at 0 when the music is loaded.

[C] CV BIAS CHANGE

The CV (control voltage) outputs for the external synthesizers can be adjusted independent of the internal sound sources. The [C] command works in the same manner as the [B] command except that with [C], only the pitch of the CV outputs from the rear panel are changed. The pitch of the CMU 800 will remain the same.

[L] LOAD

This command is for retrieving music files that have been stored on disk. Music files are distinguished from other by the ".CMU" ending. The ending never needs to be typed, it is taken care of by the program automatically. Typing [L] displays a catalog of all the files on the disk. The name of the piece desired is entered followed by a return [cr]. The music program is now in the computer memory where it can be played or edited. The [L] command can be aborted by hitting the reset button. The screen will return to the main command menu and the last piece loaded will still be in memory. If the name of the piece is mistyped or is not on the disk, the screen will respond with

```
FILE NOT FOUND
```

and return to the main menu. If there is a problem loading the music, the screen will show:

```
**LOAD ERROR**
```

Try the load again if this happens.

[S] SAVE

Save stores the music currently in memory to the disk. After typing **[S]**, the computer responds by asking

FILE NAME:

This allows the piece in memory to be given a name so it can be called later. A name can have up to 26 letters and numbers. After a piece has been saved, the main command menu will return. When a piece that has already been saved is reloaded, any changes that are made to it must also be saved. After the changes are made, do a Save in the same way as with a new piece, and use the same name when the screen asks. The old version of the file will be replaced with the new one.

[V] VERIFY

After a new piece has been saved, it is sometimes wise to double check, to make sure that it was saved properly. Typing **[V]** checks the contents of the last program saved with the contents of memory. It will register if there is an error, and a save can be performed again.

[A] ALL CLEAR

The All Clear command erases any music that is currently in memory. This is useful for when you want to enter a new piece after listening to an old one. After typing **[A]** the screen will respond with:

ALL CLEAR (Y/N)?

This gives a second chance to change your mind if you wish to keep whatever is in the memory.

[Q] QUIT

When finished with a COMPU-MUSIC session, typing **[Q]** leaves the program and goes back to the normal computer operating system.

2 NOTE TRANSLATION

Music is entered to the COMPU MUSIC through the editor. Before it can be put in, it must go through a simple translation to make it understandable by the computer. In principle the music remains the same; pitches and rhythms organized in measures. In the past, creating music with a computer involved intricate mathematical knowledge. But the COMPU-MUSIC does much of the work for you, making the task quite simple.

CHANNELS

If music consisted of just a solo melody, then only one voice or channel of synthesis would be needed. But this usually is not the case. Most music we hear has melody, harmony, counter melody and rhythm. This makes it important to have several channels available. A piano piece that needs eight fingers at a time (for a big chord) would need eight channels to recreate. The CMU-800 has outputs for eight voices plus drums for nine altogether. Without any outside help, it has six internal sound generators for a total of seven channels (with drums) available. This will be more than enough for the majority of musical needs.

STEPS

Each note entered will automatically be given a number by the computer. This is called its **STEP NUMBER**. As in traditional music notation, the music put in to the **COMPU-MUSIC** will be divided into **MEASURES**. A measure of music is like a stanza of a poem. It is a "measured" number of beats. While it is not essential for the computer to know the measures, it will be of great importance to you to help everything organized. As the end of each measure is put in, the computer automatically numbers it and goes on to the next measure. Again, this will make it very easy to go back and correct any problems later on.

CV DATA

For pitches to be entered into the CMU-800, they must first be translated into numbers the computer will understand. These numbers are called the CV data, and they are very easy to do. Anyone who has used the Roland MC-4 or MC 8 has already done it.

Each note of the scale is represented with a number. Starting with the lowest C which is 0 and going up; C# is 1, D is 2 and so on. There are 12 notes in an octave, so it is easy to see that the C above the first C (0) will be 12, and the C above that (middle C) 24. It is a good idea to just memorize the CV values. Even knowing just a few, it is easy to figure out the ones inbetween. The more that are memorized, the faster the process goes. See appendix C for a chart of all the CV numbers.

The synthesizer in the CMU 800 has a nine octave range which means that numbers between 0 and 112 are legal. The CV outputs in the back have a five octave range which use numbers from 0 to 60. This is only important if you will be interfacing it with other synthesizers. If numbers higher than the top limit are used, the computer will subtract 12 from it, lowering it an octave. If it still lies outside the limits it will subtract 12 again and again until the number falls within the proper range.

A little practice will make the transition from notes to numbers fast and painless.

STEP TIME

Note durations are also represented by numbers in the COMPU-MUSIC. The larger the number, the longer the note. Doubling the number will double the length of the note. The numbers range from 1 to 255. The number that is chosen to represent a quarter note is called the TIME BASE. It is like the time signature in standard music notation. The time base can be any number, but the best ones are those that base can be any number, but the best ones are those that divide evenly by 2s and 3s several times. A time base of 24 is often used for several reasons. It can be divided evenly by 2 (eighth note = 12), 4 (sixteenth note = 6), and 8 (thirtysecond note = 3). It divides by 3 (eighth note triplet = 8), 6 (sixteenth note triplet = 4), and 12 (thirty second note triplet = 2).

Though the tempo control on the CMU-800 has a very wide range, smaller time bases can be used for especially fast music. For finer gradations of rhythm and articulation a larger time base could be used. As a general rule though, 24 will fit most music applications. (See appendix C for a time base chart).

GATE TIME

In electronic music, and in the computer, the articulation of the note is called the **GATE TIME**. It basically corresponds to "how long the key is held down" to a pianist. Each note entered has its own gate time. It is a number between 0 and 255. It functions relative to the step time. It can never be higher than the step time of the same note. If the gate time is the same as the step time, the note is held until the next note, which is the same as a slur in music. If it is a number just below the step time, the note will be legato, if it is a very small number, the note will be staccato. IF THE GATE TIME IS 0 THE NOTE WILL BE A REST (NO SOUND). Gate time allows the computer to have a sense of "human expression" which would be sorely missed if it were not available.

3 COMMAND EXERCISE

TYPE:

[L] To load a music file

TUNE 1

Enter the name of a music file and hit **[cr]**

[cr]

[P] Plays the music

[esc] Stops the music and brings back the command menu

[O] Plays the music over and over again

[esc] Stops the music again

[T] Makes every channel play a middle C

[esc] Stops the tuning

[B] Is to change the key of the music. The screen responds with:

[7] Type a 7 OLD BIAS=0 INPUT NEW BIAS:

[cr] Followed by a return to transpose the music up 7 semitones, which is a fifth in music.

[P] Plays the music in its new key.

[esc] Stops the music again.

[B] Returns to the bias command. The screen responds with:

 OLD BIAS=7 INPUT NEW BIAS:

[0] Type a 0

[cr] followed by a return

[P] Plays the music back in its original key.

[esc] Stops the music again.

If we had made any changes to this score, or if it were a new piece, we would want to Save it.

S Performs a Save to put the new version of the score back on the disk. The screen shows the names of all the files on the disk and asks -

FILENAME:

TUNE 1

Replaces the old file "TUNE 1" with whatever is in the memory. Any changes we would have made would be saved on the disk.

V Will check to be sure that the file just saved has been saved correctly.

**Even though the memory has been saved, its music is still in the memory. It can be removed with the All Clear command.

A Clears any music in the memory out. New music can be entered if desired. However, to play a different music file from the disk. Loading it clears the old piece and puts in the new one.

CHAPTER 3

COMPU-MUSIC EDITOR

1 EDITOR

The COMPU-MUSIC editor allows for entering and revising data (music) from the computer keyboard. If the main command menu is on the screen, typing any number from 0 to 9 will start the editor. If the command menu is not showing, type (esc) to display it, followed by the number for the editor. The numbers refer to the channel number to be edited.

THE CHANNELS

- CH. 0** Is for creating drum patterns. It has no output of its own, but will be used as a "library" of patterns to be called by ch. 9.
- CH. 1-6** Are for both the CV outputs and control of the internal sound generators. Ch. 1 is best used for lead line melodies since it has an additional sustain control and its own volume level. Ch. 2 is best for the bass line since it also has a separate volume control.
- CH. 7, 8** Have CV outputs like ch. 1-6, but no internal sound sources. They are used for controlling external synthesizers and effects. Ch. 8 also has the additional portamento feature for sliding between voltage changes.
- CH. 9** Is for playing the drum patterns which are set up in ch. 0. This is the channel that controls the drum synthesizer.

2 ENTERING MUSIC

Let's use the editor to enter a simple, one voice piece into the computer. We'll use the following phrase as an example:

Fig. 3-1.

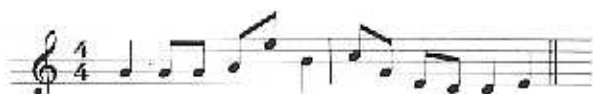

Type:

- 1** Enters the editor in channel 1. The channel number is displayed in the upper right hand corner of the screen.

- 1** **cr** Tells the computer we are starting at measure 1.

```

      XX STEPS USED          COMPU-MUSIC
      XXXX STEPS FREE       CHANNEL: 1

MEASURE:  1 STEP:  █

```

1) `[cr]` Tells the computer we will start with step 1 in measure 1

```

      XX STEPS USED          COMPU-MUSIC
      XXXX STEPS FREE       CHANNEL: 1

MEASURE:  1 STEP:  ███

```

The editor is now ready to accept the notes into the first measure.

4) 3) `[space bar]` Enters the first CV (pitch) as 43 which is a G. Hitting the space bar moves the cursor to the column for entering the STEP TIME.

```

      **      INSERT MODE      **
MEAS  STEP      CV      ST      GT
  1    1 :      43      2█      5

```

The computer has jumped ahead and entered in a STEP TIME and GATE TIME for you. These are called "defaults". They merely insure that something gets put in. Typing the next numbers will erase these. You will soon see that there are some advantages to having this.

2) 4) `[space bar]` Puts 24 (a quarter note) in for the STEP TIME. In this case even just hitting the space bar would have been sufficient since the default value was the same as the value of the first note, but the practice is good for you.

MEAS	STEP	CV	ST	GT
1	1 :	43	24	■

[2] [0] space bar Makes the GATE TIME 20, which is fairly long. The space bar advances the cursor to the next step. Hitting or can also be used to move down to the next step.

MEAS	STEP	CV	ST	GT
1	1 :	43	24	20
	2 :	■		

The next note has the same pitch but a different STEP TIME. We can save some time since we don't need to retype the CV.

space bar Inserts the same CV number as in the previous step and moves the cursor over. The ST and GT from the previous step also are inserted, but the cursor is ready to change them.

MEAS	STEP	CV	ST	GT
1	1 :	43	24	20
	2 :	43	2■	20

[1] [2] space bar Makes the ST of the note 12 which is the value of an eighth note. The cursor is moved to the next column.

MEAS	STEP	**	INSERT MODE			**
			CV	BT	GT	
1	1 :		43	24	20	
	2 :		43	12	20	

4 [space bar]

Gives the second note a GT of 4 and moves the cursor to the next note.

MEAS	STEP	**	INSERT MODE			**
			CV	BT	GT	
1	1 :		43	24	20	
	2 :		43	12	4	
	3 :		■			

Now for a little magic. Step 3 is the same as step 2. It does not need to be retyped.

Type:

[cr]

Typing a return creates a duplicate of the previous step.

MEAS	STEP	**	INSERT MODE			**
			CV	BT	GT	
1	1 :		43	24	20	
	2 :		43	12	4	
	3 :		43	12	4	
	4 :		■			

**** RULE **** Once a number is typed in, it becomes the "default". That is, it will appear everytime the cursor is moved to a new note until a new value is typed in. This allows information to be typed in at a very fast rate since any number that is to be left alone can just be skipped.

4 5 [cr]

The ST and GT remain unchanged in the next note (A). Hitting the return causes the cursor to move down to the next note leaving in the ST and GT that you last entered.

MEAS	STEP	**	INSERT MODE			**
			CV	ST	GT	
1	1 :		43	24	20	
	2 :		43	12	4	
	3 :		43	12	4	
	4 :		45	12	4	
	5 :		■			

[5] [2] [cr]

Enters the D (52) and moves to the next line (ST and GT are default).

MEAS	STEP	**	INSERT MODE			**
			CV	ST	GT	
1	1 :		43	24	20	
	2 :		43	12	4	
	3 :		43	12	4	
	4 :		45	12	4	
	5 :		52	12	4	
	6 :		■			

[4] [7] [space bar] [2] [4] [space bar] [1] [2] [space bar]

Enters the last note of the measure.

MEAS	STEP	**	INSERT MODE			**
			CV	ST	GT	
1	1 :		43	24	20	
	2 :		43	12	4	
	3 :		43	12	4	
	4 :		45	12	4	
	5 :		52	12	4	
	6 :		47	24	12	
	7 :		■			

[*] (asterisk)

Ends the measure.

MEAS	STEP	**	INSERT	MODE	**
1	1	#	CV	ST	GT
	2	#	43	24	20
	3	:	43	12	4
	4	:	43	12	4
	5	:	45	12	4
	6	:	52	12	4
	7	:	47	24	12
2	1	:	* TOTAL ST=		96
		:	#		

The next measure can now be entered. The computer shows the TOTAL ST at the end of the measure and begins the next one. A standard piece will have the same ST number for all measures. If the number is different, check the measure for a left out note, an added note, or a wrong ST.

GO through and complete the above example.

3 MISTYPING A NUMBER

If a number is mistyped, use the left arrow key  to go over the old number and replace it. The next section will deal with making changes on a larger scale.

4 CHANGING DATA

After the music has been entered, it can still be changed and modified easily. Four keys on the typewriter allow the cursor to be moved around the screen at will. After that, any wrong data can just be typed over. The keys are:

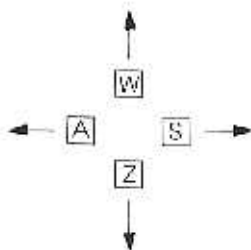

They are clustered at the left side of the keyboard.

`esc` Moves the cursor to the top of the screen and allows you to move to a different channel of the score for editing or input.

`esc` Leaves the editor and returns the screen back to the main command menu.

By typing `P` the music can be played. Listen to it with the tempo knob at different settings.

Don't save it yet. In the next chapter we will learn how to change the score in bigger ways by deleting notes, adding notes, and changing whole sections of the music.

CHAPTER 4
EDITING COMMANDS AND RHYTHM PATTERNS

1 EDITING COMMANDS

There are a few simple commands to help revise scores once they have been typed in. Once the technique of data entry has been learned, these commands will make music making on the COMPU-MUSIC fun, quick, and simple. The commands will be presented in short form and then explained in more detail later in the chapter. All of the editing commands are executed by a single character while in the editor.

1. By typing the MEASURE and STEP number, the cursor can be moved to any point in the score.
2. **I** -- **INSERT** -- Allows for inserting and adding data anywhere in the music.
3. **D** -- **DELETE** -- Allows for deleting any amount of data.
4. **C** or **X** -- **COPY** -- Data already entered can be copied and used anywhere in the piece without being retyped.
5. **M** -- **MEASURE PLAY** -- Plays only the measure the cursor is in. Allows for rapid error checks.
6. **P** -- **POINT PLAY** -- Plays the entire piece starting at the cursor point.
7. **=** -- **SOUND EDIT** -- Plays the pitches as they are entered.
8. **?** -- **HELP** -- Displays all the edit commands on the screen.
9. **F** -- **FORWARD PAGE** -- Moves the editor ahead one page.
10. **B** -- **BACK PAGE** -- Moves the editor backward one page.
11. **T** -- **TRANPOSE** -- Allows for changing of CV bias (key) in any section of the music.
12. **esc** -- **QUIT** -- Leaves the section of the editor being used. Hitting the **esc** key also stops music if it is playing.
13. **<** **>** -- **REPEAT** -- Lets any block of notes be repeated multiple times.

14. `[z] --MEASURE END--` Marks the completion of each measure.

After typing a number from the main command menu to select a channel to edit, the top of the screen will display:

```
XX STEPS USED
XXXX STEPS FREE
```

“Steps” refers to notes, not bytes. The number will be influenced by the memory capacity of the computer used. This will indicate when a piece may be getting too large to fit in memory.

2 INSERT AND SCREEN EDIT

The differences between insert and screen edit modes was explained in the last chapter. If the channel being edited already has data in it, then the editor will come on in screen edit mode. When the cursor is moved down past the data it will jump into insert mode.

We have entered music up to measure 2, step 5. To get back into insert mode to continue the piece is quite easy. From the main command menu:

Type:

```
[1] Return to channel 1 from the main command menu.
```

The computer now asks for the measure and step number to start the edit. We can do one of two things.

Type:

```
[2] [cr] [6] [cr] By typing the next higher step number the editor will jump into insert mode and we can continue entering new music.
```

Another way to get to the end of the music is:

Type:

```
[1] [0] [0] [cr] [1] [0] [0] [cr] The editor can't go farther than just after the last note. It will still enter insert mode, but it will still be at measure 2, step 6. Typing any measure and step that's
```

larger than the last one will enter insert mode on the next step. If you can't remember the last step number, use this technique to move the correct step.

3 EDITOR COMMANDS

1. --[I]--

INSERT. This command allows new material to be entered anywhere in a piece, even between two notes already entered. Position the cursor to the step just after the desired insert point.

Type:

[I] Causes all the notes from the cursor on to disappear from the screen. The editor will be in **insert mode**. New data can now be entered. To end the insert:

[esc] The editor will return to screen edit mode and the notes after insert will return to the screen renumbered.

2. --[D]--

DELETE. The command is for deleting data while in screen edit mode. Position the cursor on the first (or only) note to be deleted.

Type:

[D] The screen will respond with:

```
-----  
DELETED ...  
MEASURE:   
-----  
  
-----  
DELETED ...  
MEASURE: X STEP: ■  
-----
```

Enter the measure and step number — each followed by a [cr] — of the **last note** to be deleted. All the notes from under the cursor to the the note entered will be deleted.

If an error is made in typing the measure or step numbers, the cursor can be moved back with the [←] or backspace key. If an error is made in the measure number but the step number is alright, type [esc] to move back to the measure column and retype it. Then hit [cr].

The command can be cancelled by hitting `[esc]` twice.

To delete a single note:

Type:

`[D]` `[cr]` `[cr]` Only the note directly under the cursor will be deleted.

3. `-[C]` - OR - `-[.]` -

COPY. Any data that has been entered can be used again without retyping by using the copy command. Notes can also be changed after they have been entered with the `[.]` copy. Typing `[.]` changes a note already entered into a copy of the note just above it.

Type:

`[.]` This copies a single step. If the cursor is in the CV column the CV, ST, and GT of the previous note will be copied. If the cursor is in the ST column only the ST and GT will be copied, leaving the pitch alone. With the cursor in the GT column only the GT will be carried down, leaving both pitch and duration unchanged.

To copy blocks of notes, position the cursor on the note to follow where the copy will be inserted.

Type:

`[C]` The screen will respond with:

```
-----
: COPY ...      TIMES:  X      BIAS      #
: SOURCE CH: X  TOP MEAS:  X    END MEAS:  X
:-----
```

SOURCE CH. Refers to the channel the data will be taken from. It can be the channel the editor is currently in or any other channel with data in it.

TOP MEAS. Is the starting point of the copy. Data starting from the beginning of the specified measure will be copied.

END MEAS. Is the last of the data to be copied. Data to the end of the last measure will be copied.

- TIMES** Allows the copy to be done multiple times. If the copy is to be done Three times, enter 3. To make just one copy type nothing and hit **[cr]**.
- BIAS** Allows for the CV bias of the data being copied to be changed. This works the same as the Bias command. The limit is -24 to +24. A 0 (or just hitting **[cr]**) will leave the copy alone.

Typing **[esc]** will cancel the command if it has already been started.

To try the copy command, we will insert the entire first measure into the end of the second measure. Position the cursor after the last note of the second measure.

Type:

- [1]** **[cr]** Sets the source channel to 1. That is, the information to be copied will be taken from channel 1.
- [1]** **[cr]** Sets the first measure to be copied as measure 1.
- [1]** **[cr]** Sets the end of the copy at measure 1 also.
- [cr]** Makes the copy only once.
- [cr]** Leaves the CV Bias in its original key.

The first measure is now copied into the spot the cursor was in when the command was executed.

*This copy function does not work in CH-9.

4. -- **[M]** --

MEASURE PLAY. After a measure of data has been fully entered, the Measure play command allows it to be played immediately. Put the editor into screen edit mode, then:

Type:

- [M]** Plays the one measure the cursor is in currently. It will play the channel being edited. Measure play works in all channels including 0 and 9.

5. -- **[P]** --

POINT PLAY. This is similar to Measure play except that it plays all the channels from the cursor position to the end of the score. This command will not work in channels 0 or 9.

6. --[=]--

SOUND EDIT. In the Sound edit mode, notes are heard as they are entered. To enter sound edit mode

Type:

[=] The screen will change from:

```
-----  
** INSERT MODE **  
-----
```

to:

```
-----  
== INSERT MODE ==  
-----
```

Type [=] again to leave Sound edit mode.

7. --[?]--

HELP. Typing a question mark at any time in the editor will display a menu of all the editing commands. To return to the editor, hit any key on the keyboard (except reset).

8. --[F]--

FORWARD PAGE. The editor can display data one page at a time. A page is all the data the screen can hold. Typing F moves the editor ahead to the next page. This allows for quick moving through long scores.

9. --[B]--

BACK PAGE. Moves the editor back a page at a time.

10. --[T]--

TRANSPOSE. This command changes the CV bias of any block of data. To do the transpose, place the cursor on the first note to be changed, then

Type:

I The screen will respond with:

```
-----  
:  TRANSPOSE ...          BIAS: X  
:  MEASURE:  XX  STEP:   XX  
:  -----
```

Enter the measure and step number of the **last note** to be transposed — each followed by a **cr**. The transpose will begin at the cursor and go to the note entered. The BIAS will control the interval of the transposition as it did in the COPY and BIAS commands. Entering a 0 will cause nothing to happen. The limits for the bias are -24 to +24 (two octaves down to two octaves up).

11. -- **<** **>** --

REPEAT. The brackets are used to indicate sections of music to be repeated. They are given their own step numbers before the first note and after the last of the repeat. The number of times the section is to be played is entered after the closing bracket. It is possible to insert a repeat with the I command.

12. -- ***** --

MEASURE END. An asterisk should be entered at the end of each measure. The computer automatically calculates the total ST of the measure and begins the next one. This is extremely useful for editing and error checking.

4 USING POINT EDIT

The Point Edit command lets you move to any point in the music and edit it by listening. It is carried out from the main command menu.

Type

esc Hitting **esc** three times will return the screen to the main command menu.

esc

esc

P Play the music

** Then at the point in the music to be edited type:

E Type **E** for the Point Edit command

The screen will respond with:

EDIT CHANNEL?

I Enter 1 since it is the only channel used in this example

The cursor is now directly over the last note played before the music stopped. It can be edited, deleted, or used as an insertion point.

5 CREATING DRUM PATTERNS

The CMU-800 has a seven voice drum synthesizer built into it. Rhythm patterns of nearly any style or complexity can be entered and used in a score. The voices available are:

- B** Bass drum
- S** Snare drum
- L** High tom
- H** Low tom
- Y** Cymbal
- O** Open hi-hat
- C** Closed hi-hat

Rhythm patterns are set up in channel 0 and are then called into the score in channel 9. A pattern has one measure of music in it. The format for entering them looks like this:

PATTERN	STEP	B	S	L	H	Y	O	C	ST
X	1	:	6
	2	:	6
	3	:	6
	4	:	6
	5	:	6
	6	:	6
	7	:	6
	8	:	6
	9	:	6
	10	:	6
	11	:	6
	12	:	6
	13	:	6
	14	:	6
	15	:	6
	16	:	6
									* TOTAL ST= 96

The measure is broken down into sixteen parts, each row with an initial step time of 6, which just happens to be the step time for a sixteenth note. The step times can be changed if the need arises (see chapter five).

Each column is an instrument. To "hit a drum", an X is placed on the spot under the desired drum, in the row desired. For example, to play quarter notes (ST 24) on the Bass drum, the following would be entered:

PATTERN	STEP	B	S	L	H	Y	O	C	ST
1	1	X	6
	2	6
	3	6
	4	6
	5	X	6
	6	6
	7	6
	8	6
	9	X	6
	10	6
	11	6
	12	6
	13	X	6
	14	6
	15	6
	16	6
		* TOTAL ST= 96							

This plays a Bass drum note on each beat (a beat is four sixteenths, a quarter note). The cursor diamond (A W S Z) is used to move around the grid to type the Xs. Moving the cursor below the last row (16) will revolve it back to the top. Countless rhythms can be done in this format. Typing a period (.) will erase an X and cancel the "hit".

In addition, the step times in the right column can be changed to accommodate different meters, special rhythms, synchopation, or drum effects such as rolls, flams, etc. A simple waltz might look like this:

PATTERN	STEP	B	S	L	H	Y	O	C	ST
2	1	X	24
	2	.	X	24
	3	.	.	X	24
	4	0
	5	0
	6	0
	7	0
	8	0
	9	0
	10	0
	11	0
	12	0
	13	0
	14	0
	15	0
	16	0
		* TOTAL ST= 72							

The rows with ST set at 0 will be skipped. The first three rows were changed to 24 to make them each one beat.

To enter drum rhythms with the editor,

TYPE:

0 Enters the editor into channel 0.
The screen responds with "PATTERNS:"

1 Tells the computer that we will begin by entering pattern number 1.

(CREATE PATTERN) On the grid. It will be one measure in length. Patterns that are longer will use more than one pattern grid. When it is finished, type:

M (Measure Play) plays the pattern. Use this to check and revise the material as it is entered.

esc Takes the cursor out of the grid. The screen asks "PATTERNS" again. At this point it is possible to create a second pattern by typing:

2 to get a fresh grid and start the pattern. By typing:

C a pattern already entered can be copied and revised into a variation.

esc Leaves the channel when all the patterns are completed. It is of course possible to come back at any time to enter new patterns or to revise old ones.

Channel 9 is now used to call the patterns into the music. This is done simply by typing the number of the pattern. From the main command menu:

TYPE:

9 Enters the editor into channel 9. The screen responds with:

MEASURE NUMBER:

1 Starts off with measure 1.

Enter the number of the pattern desired for the first measure. Hit return or . The cursor will move down and the second measure can be entered. If only a single pattern was entered into channel 0, type the pattern number for as many times as there are measures in the piece.

Rests are accomplished by using empty grid numbers (ones not yet written in). Inserts and deletes can be done just as they were in the pitch channels. Copy will not work here.

`esc` Leaves the data field and makes it possible to move

`esc` Leaves the data field and makes it possible to move to any other measure already typed.

`esc` Makes it possible to move to another channel (while staying at the same measure number in the piece).

`esc` Leaves the editor and returns to the main command menu.

See **Appendix D** for sample rhythms

CHAPTER 5

ADVANCED PROGRAMMING

1 SAVING FILES

While working on a score, especially a long piece, it is a good idea to do a Save every so often to protect the work so far. When the S command is executed, whatever is in the computer memory is saved onto the disk. The contents of memory are not altered at all. It can be done at any time during an editing session.

1. Return to the main command menu.
2. Type [S].
3. When the screen asks for a filename, give the title of the score. If the piece has been saved before use the EXACT SAME FILENAME. The old version will be replaced with the newer one.
4. If additions or changes are being made to a piece, be sure to save the changes.

Performing Saves often can prevent a great deal of tragedy, heartache, and needless work in typing in a piece twice.

2 ARTICULATION

Articulation can be the breath of life to a phrase of music. It is important not to let music become static in quality by ignoring this important parameter.

As has been pointed out earlier, if the GT is the same number as the ST the note will be tied, which means it will be joined to the next note with no space inbetween. Normally, there is some amount of silence between notes. Changing the amount of space between notes will create very different effects musically.

Don't be afraid to use extremes in GT numbers. Instrumentalists are much more likely to either make a note very long (legato) or very short (staccato) than to just leave it somewhere in the middle.

The [M] (Measure play) command can be very helpful in creating well articulated scores.

1. Go through and put the score in to the computer. Don't be overly concerned with the GT yet. Get the pitches and rhythms correct and the way you want them.
2. Go back over the channels one at a time. Use Measure play to listen to the music a measure at a time while changing the GT to more suitable numbers. Be especially expressive in the melody channels.
3. Be consistent with any unison rhythms such as chords in channels 3-6. Make sure that whatever the articulation is in one channel, it is used in all of them (see "CHORDS").

3 RHYTHMS

Generally, rhythmic notation is fairly straight forward, and hopefully no problems have occurred in transcribing them into Step Times. Most durations are just double or half another duration. Triplets are also a simple division (see ST chart in appendix C).

Some more complex rhythms may not be so easy to figure out. For example, using a time base of 24, a quintuplet (five notes in a beat) will be difficult since 24 does not divide evenly by 5. However, this can be overcome with a little bit of cheating. Even a very good instrumentalist will not really play a complex rhythm like a quintuplet or septuplet (7 notes in a beat) perfectly even. Usually the last note of the beat will be slightly shorter than the rest, yet the figure will still sound fine. In COMPU-MUSIC terms this would appear like this:

STEP	CV	ST	BT
1 :	24	5	2
2 :	24	5	2
3 :	24	5	2
4 :	24	5	2
5 :	24	4	2
		↑ TOTAL ST=	24

Apply this concept to other "odd" rhythms when they occur.

4 MORE RHYTHM

Synchopation, or "jazz rhythm" is another special rhythmic situation. Though most jazz music is written as straight eighth notes in 4/4 time, it is rarely played this way. Instead, it is "swung" by playing the eighths as (fig. 5-1). The same holds true when it is noted as (fig. 5-2). A measure of "straight" eighths might look like this:

Fig. 5-1.

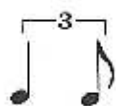

Fig. 5-2.



STEP	CV	ST	BT
1 :	24	16	15
2 :	27	8	7
3 :	28	16	15
4 :	24	8	7
5 :	19	16	15
6 :	22	8	7
7 :	18	16	15
8 :	17	8	2
		* TOTAL ST=	96

Most jazz lines are played very legato as in the example above. Some notes may be clipped short for emphasis as was step 8. Those notes will almost always be off the beat (the second half of the beat), another characteristic of synchopated music.

5 CHORDS

Chords are often employed in the middle voices of a piece. A chord will consist of two or more notes in a unison rhythm throughout most of a score. Channels 3-6 are usually reserved for chords. Here is a technique for quick and accurate chord entry:

1. Enter the editor into the first channel for the chord (usually channel 3) and type the top (or "lead") line of the chord. Make a mental note of the first and last measure numbers used.
2. When the first line is completely entered, go back and check it for note and rhythmic accuracy with the Measure play and Point play commands.
3. Go through the line once again and get the articulations (GT) the way they should be. This is the time to make the line expressive. Think about how the chord line will fit into the rest of the piece; should it be smooth, punchy, fast, slow, etc.
4. Move the editor to the second channel for the chords. Using the measure numbers of the lead channel, make a copy of it. It is now easy to go through and change only the pitches (VC) while leaving the rhythms and articulations alone. Position the cursor over the first CV to be changed. By merely typing the number of the new note and hitting the return key, the note will be changed and the cursor will move down to the next note. A great deal of time has been saved by not needing to retype any of the durations or articulations.
5. Repeat step 4 for any other channels of the chord. Use the Point play command at any point in the piece to check accuracy of the notes in the chords.

6 TRILLS

Trills are the rapid alternating between a note and the note one step above it (sometimes a half step, sometimes a whole step depending on the key). It is an ornament found often in classical music, and occasionally in jazz and popular. It is abbreviated like this:

Fig. 5-3.



And is played like this:

Fig. 5-4.



With a time base of 24, that makes the notes of the trill each have a ST of 3. In order to make this a less tedious chore to enter, repeats can be used to speed things up:

STEP	CV	ST	GT
1 :	<		
2 :	48	3	3
3 :	50	3	2
4 :	>	9	

The example above shows a half note (two beat) trill. The two notes of the trill (C and D in this case) make up a sixteenth note put together, so repeating them 4 times makes a quarter note trill and eight repeats makes the full half note.

Notice that the GT of the first note is a tie and the second note is just less than a tie. In normal circumstances, a trill should be completely tied. But when the gates inside the CMU-800 are not re-triggered (as with a tied note), the trill would just fade away after a few seconds (which can be a nice effect if you want that). So the gate is re-triggered after every other note. The difference in the overall sound is almost nothing, but the trill will play for as long as desired. If a trill goes for longer than a measure it is a good idea to break it up for ease of editing later on if it is needed.

7 GLISSANDO

A glissando, or "gliss" is a rapid scale up or down to give a sense of "sliding" from one note to another. It is used often in all types of music and can be very expressive. Like the trill, if the time base is 24 the duration for each note in the gliss is about 3. There can't be any rigid definition of duration since it depends on the number of notes in the gliss which in turn depends on how big an interval is being covered. For example, if we are glissing between:

Fig. 5-5.



the notes of the gliss will look like this:

Fig. 5-6.



which will be notated like this:

STEP	CV	ST	BT
1 :	43	24	22
2 :	45	24	22
3 :	43	15	15
4 :	45	3	3
5 :	47	3	3
6 :	48	3	3
7 :	* TOTAL ST=	72	
1 :	50	72	24
2 :	* TOTAL ST=	72	

Even though a gliss is between two notes, the time is taken away from the first note so the second one may fall on the beat.

8 GRACE NOTES

Another frequently seen musical ornament is the grace note. Again, it is found in almost any style of music. It is a quickly played note (or two) that is not counted in the rhythm of the measure and is subtracted from a note as the gliss was. Grace notes look like this:

Fig. 5-7.



The above figure would be scored like this:

STEP	CV	ST	BT
1 :	48	12	3
2 :	50	12	3
3 :	48	21	19
4 :	53	3	3
5 :	55	21	17
6 :	59	3	3
7 :	60	24	18
8 :	* TOTAL ST=	96	

Usually the grace note is tied to the note it precedes, but this can be varied for a different effect.

Grace notes can be used to produce the "blue notes" in jazz. They can be used like bending the strings on a guitar or sliding a vocal note. Experiment with different duration values for the grace notes.

9 EXTERNAL EFFECTS

The COMPU-MUSIC can be used with any external signal processors to enhance its sound. The sound can be modified with equalizers, flangers, phasers, echos, reverbs, filters, wah-wahs, choruses, delays, etc. The signal from the CMU-800 can be processed as a whole, or individual channels can be routed to effect machines. With limited amounts of devices, it might be wise to enhance the lead line alone so it will stand out more. Channel 1 has its own output in the back.

Certain effects can also be tied together with the score itself allowing you to control external parameters with the computer. Channels 7 and 8 are provided for this.

For example, an external VCA (Voltage Controlled Amplifier) can be used to control the overall loudness (dynamics) of the internal synthesizer.

1. Route channel 8's output to the control input of the VCA.
2. Run the MIX output of the CMU-800 to the signal input of the VCA.
3. Feed the signal output of the VCA to the amplifier or recorder.
4. Channel 8's CV column can now be used to control dynamics of the music. The higher the number the louder the output. 0 will be silent and 60 will be the loudest. Specific notes can even be accented.
5. The portamento control on channel 8 can be used to smooth out the transition from one dynamic to another or to make crescendos and decrescendos (gradual changes in volume).

An external VCF (Voltage Controlled Filter) can be used in a similar way as the VCA above. Instruments such as the piano have very different sound properties at the bottom of their range from the top. A filter to enhance the lead line can be controlled by the CV output of channel 1 to change the filter with each note.

Fig. 5-8. Diagram of external VCA or VCF to control dynamics or timbra.

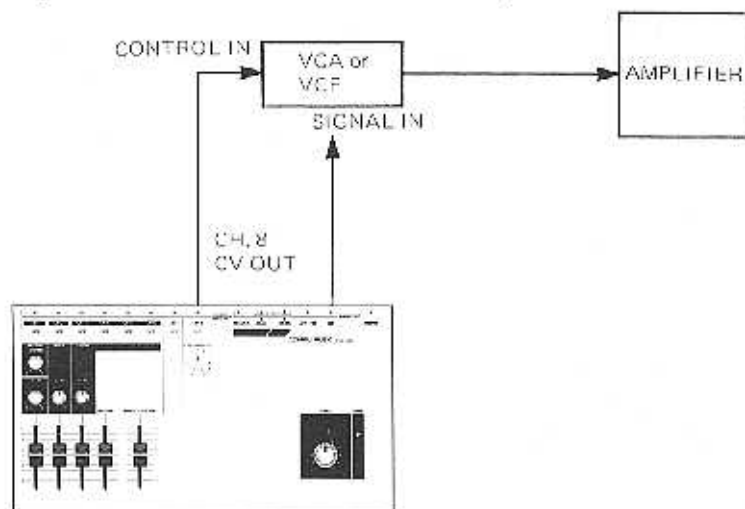

10 EXTERNAL SYNTHESIZERS

The COMPU-MUSIC has the ability to control up to eight voices of external synthesis through the outputs of its back panel. This opens up whole new worlds of sound possibilities with your computer. The CMU-800 now functions as an interface between the computer and any synthesizers. The only requirement of the synthesizer is that it accept control voltage inputs and be set at 1 volt per octave, which is standard. It would also be possible to combine the internal synthesizer with any externals for a much "fatter" sound.

1. Monophonic Synthesizers

If you are working with just a single, one voice synthesizer, it can be used to play or double the lead line in channel 1. Any additional monophonic synthesizers can be hooked up to other channels to enhance the bass line or other counter lines. The hook up is illustrated below:

Fig. 5-9. Diagram of using external lead synthesizer.

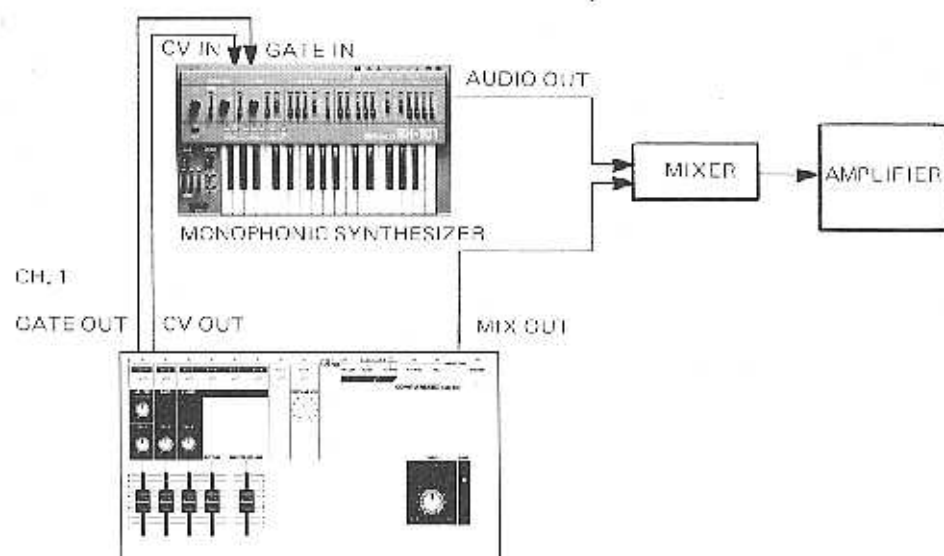

2. Polyphonic Synthesizers

Since COMPU-MUSIC handles up to eight independent voices, it is perfect for interfacing with almost any polyphonic synthesizer. Again, it must be able to accept a control voltage input at 1 volt per octave. Several synthesizers fit this description including the Roland JP-8 with its OC-8 interface and several other Roland keyboards. The basic set up for polyphonic interface is diagrammed on the next page.

Fig. 5-10. Diagram of interface with polyphonic synthesizer.

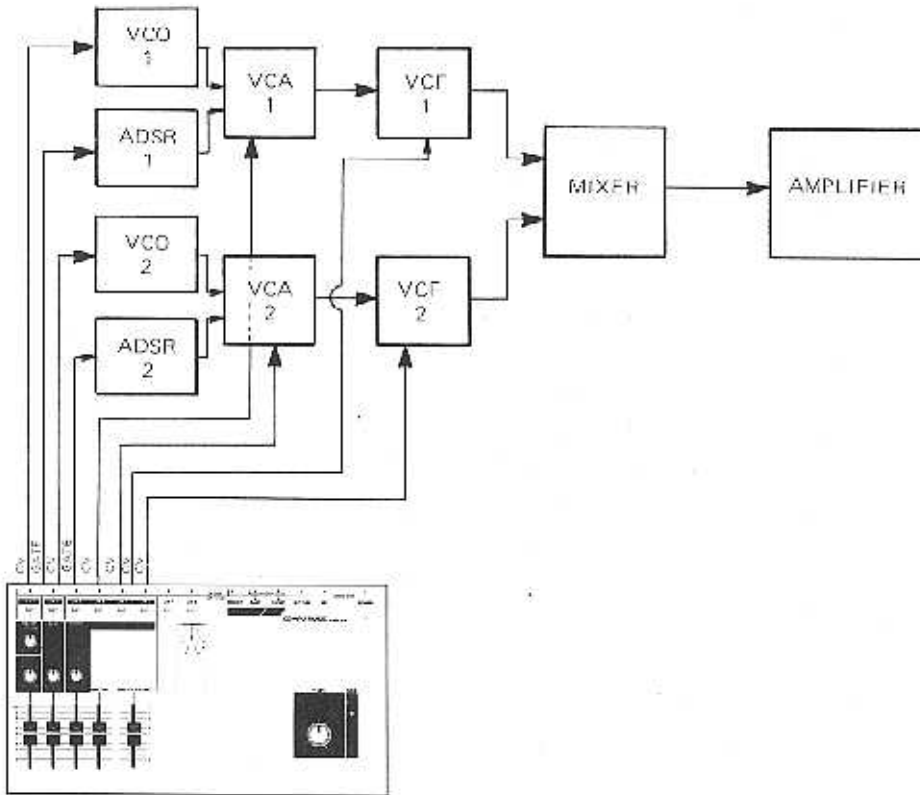

3. Modular Synthesis

Anyone who has dealt with modular, or patchable synthesizers knows the many possibilities of sound giving sufficient control over the parameters. The output of the COMPU-MUSIC can be thought of as abstract control voltages which can be used any way desired. Eight triggers are of course available making possible control over up to eight envelopes. Voltages can be then used to control:

1. Pitches (VCO)
2. Dynamics (VCA)
3. Filtering (VCF, q and resonance if controllable)
4. Envelope triggering
5. LFO rate
6. FM ratio
7. Effects and effect loops (with VCAs)
8. Sequencers
9. S/H rate
10. Pulse width
11. Any additional voltage controlled module

It is beyond the scope of this manual to attempt any thorough description of the possibilities with the COMPU-MUSIC system and modular synthesis. The list above should give a few ideas to help get started. A new level of voltage control not possible before is now available with a certain amount of imagination and equipment.

APPENDIX

A MENU COMMANDS

- 0-9 Channel numbers for entering the editor.
- E** **Point Edit.** Allows editor to be entered on the last note played.
- P** **Play.** Plays the music currently in the memory.
- O** **Loop Play.** Same as Play, except the music will repeat over and over until stopped.
- T** **Tune.** Causes all channels to sustain a middle C until stopped.
- B** **Bias Change.** Changes the key of the music to be played. Music can be transposed up or down 2 octaves (24 CV).
- C** **CV Bias Change.** Changes only the key of the CV outputs on the rear panel. Operates indentially to B.
- A** **All Clear.** Clears the music file out of memory. Used when entering a new file after loading an old one.
- L** **Load.** Loads music files from the disk to memory.
- esc** Interrupts the play command, stopping the music.
- S** **Save.** Stores whatever music is in memory to the disk.
- V** **Verify.** Checks that the save was done properly.
- Q** **Quit.** Leaves COMPU-MUSIC.

B EDITING COMMANDS





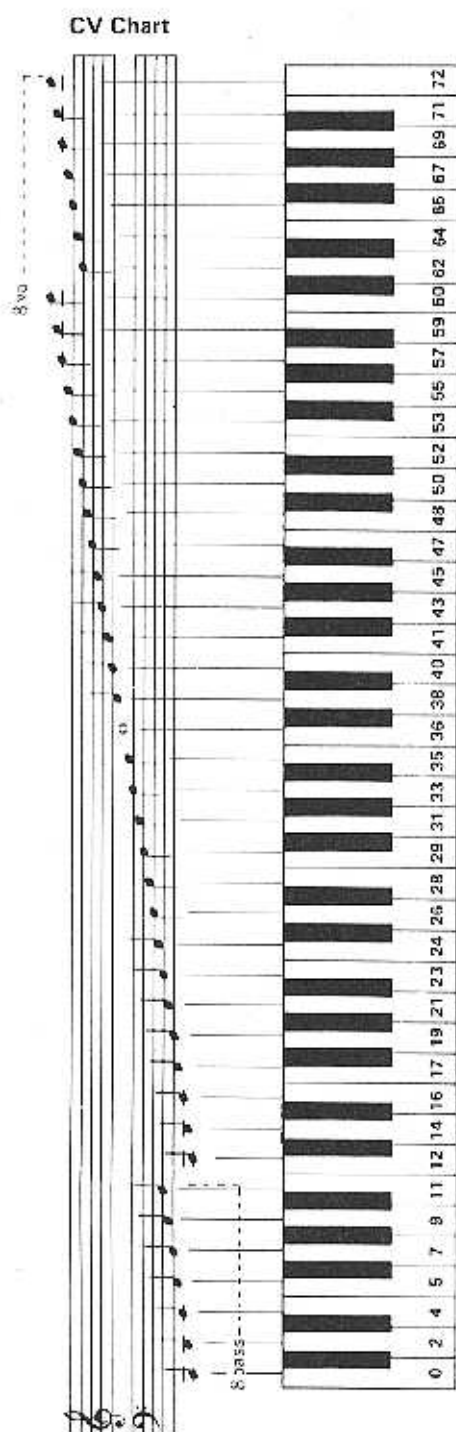











1. By typing the MEASURE and STEP number, the cursor can be moved to any point in the score.
2. **[I]** --INSERT--Allows for inserting and adding data anywhere in the music.
3. **[D]** --DELETE--Allows for deleting any amount of data.
4. **[C]** or **[.]** --COPY--Data already entered can be copied and used anywhere in the piece without being retyped.
5. **[M]** --MEASURE PLAY--Plays only the measure the cursor is in. Allows for rapid error checks.
6. **[P]** --POINT PLAY--Plays the entire piece starting at the cursor point.
7. **[=]** --SOUND EDIT --Plays the pitches as they are entered.
8. **[?]** --HELP--Displays all the edit commands on the screen.
9. **[F]** --FORWARD PAGE--Moves the editor ahead one page.
10. **[B]** --BACK PAGE--Moves the editor backward one page.
11. **[T]** --TRANPOSE--Allows for changing of CV bias (key) in any section of the music.
12. **[esc]** --QUIT--Leaves the section of the editor being used.
13. **[<]** **[>]** --REPEAT--Lets any block of notes be repeated multiple times.
14. **[*]** --MEASURE END--Is used to indicate the completion of each measure.

C CV AND TIME BASE CHARTS



Example Time Base Chart

1/4 note = 1 beat

<u>Time value</u>	<u>As Written</u>	<u>24</u>	<u>32</u>	<u>60</u>
Whole note		96	128	240
Dotted Half		72	96	180
Half Note		48	64	120
Dotted 1/4		36	48	90
1/2 Note Triplet		32	ND	80
1/4 Note (TB)		24	32	60
Dotted 1/8		18	24	45
1/4 Triplet		16	ND	40
1/8 Note		12	16	30
1/8 Triplet		8	ND	20
1/16 Note		6	8	15
1/16 Triplet		4	ND	12
1/16 Quintuplet		ND	ND	10
1/32 Note		3	4	ND
1/32 Quint		ND	ND	6
1/32 Triplet		2	ND	5
1/64 Note		ND	2	ND

D SAMPLE DRAM RHYTHMS

(1) Simple Rock (4/4)

STEP	D	S	L	H	Y	D	C	ST
1	X	X	6
2	6
3	X	6
4	6
5	.	X	X	.	.	.	X	6
6	6
7	X	6
8	6
9	X	X	6
10	6
11	X	6
12	6
13	.	X	X	.	.	.	X	6
14	6
15	X	6
16	6
* TOTAL ST=								96

(2) Slow Funk

BSTEP	B	S	L	H	Y	D	C	ST
1	X	X	6
2	6
3	X	X	6
4	X	6
5	.	X	X	6
6	X	6
7	X	6
8	X	6
9	X	X	6
10	6
11	.	.	X	.	.	.	X	6
12	X	6
13	.	X	X	6
14	.	.	X	6
15	X	6
16	X	X	6
* TOTAL ST=								96

(3) Rock (4/4)

STEP	D	S	L	H	Y	D	C	ST
1	X	X	6
2	6
3	X	.	6
4	X	6
5	.	X	X	6
6	6
7	X	.	6
8	6
9	X	6
10	X	6
11	X	.	.	6
12	6
13	.	X	X	6
14	6
15	X	.	6
16	6
* TOTAL ST=								96

(4) Jazz

STEP	B	S	L	H	Y	D	C	ST
1	X	.	6
2	6
3	6
4	6
5	X	6
6	6
7	5
8	X	7
9	X	.	6
10	6
11	6
12	6
13	X	.	6
14	6
15	6
16	X	.	7
* TOTAL ST=								96

(5) Bossanova

STEP	D	S	L	H	Y	O	C	ST
1	X	X	.	X	.	.	X	6
2	X	6
3	X	.	.	6
4	X	X	.	X	.	.	X	6
5	X	.	X	.	.	.	X	6
6	.	.	.	X	.	.	X	6
7	.	X	.	.	X	.	.	6
8	X	.	.	X	.	.	X	6
9	X	X	6
10	.	.	.	X	.	.	X	6
11	.	X	.	.	X	.	.	6
12	X	.	.	X	.	.	X	6
13	X	.	X	.	.	.	X	6
14	.	X	X	6
15	.	.	.	X	X	.	X	6
16	X	X	6
* TOTAL ST=								96

(6) Intro/Fill

STEP	B	S	L	H	Y	O	C	ST
1	X	X	X	6
2	.	X	6
3	X	6
4	.	X	6
5	X	.	.	X	.	.	X	6
6	.	.	.	X	.	.	.	6
7	.	.	.	X	.	.	X	6
8	.	.	.	X	.	.	.	6
9	X	X	X	6
10	.	X	6
11	.	.	.	X	.	.	X	6
12	.	.	.	X	.	.	.	6
13	X	.	X	.	.	.	X	6
14	.	.	X	X	.	.	.	6
15	X	.	X	.	.	.	X	6
16	X	.	X	6
* TDTAL ST=								96

E GLOSSARY OF MUSICAL TERMS

ACCENT--Emphasis given to a certain note or notes making it louder.

DECAY--The amount of time it takes for a note to fade away. A piano note decays much more slowly than a drum note. Instruments such as an organ do not have a decay.

ENVELOPE--A term used in electronic music to define the loudness contour of a note. It is usually broken down into ATTACH, DECAY, SUSTAIN, and RELEASE.

GATE--An electronic switch will trigger the ENVELOPE to begin.

KEY--The tonal center of any certain scale. The KEY of C major is the tonality in the C scale. Most all popular and classical music is in a KEY.

LEGATO--A note that is held for its full length.

MEASURE--A group of beats (units of musical time) notated between two bars (vertical lines). Each measure of a piece will most always have the same number of beats, usually two, three or four.

METER--A rhythmic structure that organizes music into equally sized MEASURES, each containing the same number of counts.

PITCH--The relative "highness" or "lowness" of a note. PITCH is determined by the number of cycles (or waves) per second.

RHYTHM--A basis of regularity in musical timing. Breathing, heartbeat, and tides are example of RHYTHMS lends to the overall feeling of a piece of music.

SLUR--When a note is held over to the next with no break between.

STACCATO--A note which is played very short, with much silent space before the next note. It is the opposite of LEGATO.

STAFF--The five lines which music is written on to indicate their pitch.

TEMPO--The speed of a piece of music. Some common TEMPO markings are:

LENTO-very slow

ADAGIO slow, at ease

ANDANTE-walking speed

MODERATO-moderately

ALLEGRO-quick, cheerful

PRESTO-very fast

ACCELERANDO-pick up speed

RITARDANDO-slow down

TIE—A note which is held over from one measure to another.

TIMBRE—The tone color of an instrument distinguishing it from other instruments.

VCA—Voltage Controlled Amplifier. Device which controls the loudness of sound in an electronic synthesizer.

VCF—Voltage Controlled Filter. Device which controls the sound quality of the VCOs in a synthesizer.

VCO—Voltage Controlled Oscillator. The actual tone producer in a synthesizer.

F GLOSSARY OF COMPUTER TERMS

BIT--A single piece of binary (0 or 1) information inside the computer.

BYTE--A group of eight bits, also called a word.

CPU--Central Processing Unit. The part of the computer that performs the actual calculating; the "brain" of the computer.

CURSOR--The mark on the console screen which shows the current position of the computer monitor, or the EMU editor. It is usually indicated with a flashing square or underline.

DAC--Digital to Analogue Converter. A device which convert digital information in the computer into a corresponding scale of electrical voltages that can then be used for a variety of applications.

DATA--Information being entered into or processed by the computer.

DISK DRIVE--The device used to handle magnetic disks for mass storage of information.

FLOPPY DISKETTE--Inexpensive storage media for keeping large amounts of information. It is a "nonvolatile" form of information storage meaning the data is not lost when the computer is shut off.

HARDWARE--The physical parts of a computer system; the CPU, disk drives, disks, and any other peripheral devices.

LOAD--Moving data from the disk into the computer memory.

MEMORY--The portion of the computer which stores data either permanently or non permanently.

OPERATING SYSTEM--The program which allows the computer, disk drives, monitor, and printer to function together efficiently. Some common operating systems are CP/M, DOS, MS-DOS and UNIX.

RAM--Random Access Memory. The area of the computers memory where programs and data are kept when in use. The data in RAM is lost when the machine is turned off.

SAVE--The process of putting information on disk (or other mass storage systems) for later retrieval.

SOFTWARE--The non-physical parts of a computer; the programs, operating system, and data.

G TECHNICAL SPECIFICATIONS

TONE GENERATORS	DCOs (Digitally Controlled Oscillators) 1. MELODY 2. BASS 3-8. CHORD 9. DRUMS (7 Voices, Analogue)
RHYTHM	BASS DRUM SNARE DRUM LOW TOM HIGH TOM CYMBAL OPEN HI-HAT CLOSED HI-HAT
OUTPUT JACKS	CV CHANNELS 0-5.25V (1V/OCTAVE) GATE CHANNELS 0-12V <i>470 Ω in series f. 5V</i> AUDIO MIX OUT MELODY OUT BASS OUT CHORD OUT RHYTHM OUT CLOCK IN/OUT (5V, 96 pulses per measure, positive trigger) COMPUTER BUS CABLE
CONTROL SLIDERS	MELODY (DECAY, SUSTAIN, VOLUME) BASS (DECAY, VOLUME) CHORD (DECAY, VOLUME) RHYTHM (VOLUME) MASTER (VOLUME) TEMPO (CONTROL) PORTAMENTO (CHANNEL 8 ONLY)
INDICATORS (LEDs)	POWER 8 GATE DISPLAYS
POWER SUPPLY	AC 120/220/240V, 50/60 Hz, 20W
DIMENSIONS	333mm W x 108mm H x 193mm D
WEIGHT	3 kg