

MUSIC ATELIER

AT90S / AT80S / AT60S

Owner's Manual

Copyright © 2001 ROLAND CORPORATION
All rights reserved. No part of this publication may be reproduced in any
form without the written permission of ROLAND CORPORATION.

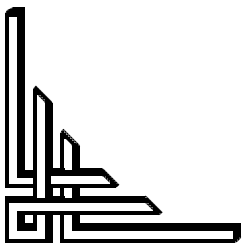

Roland®

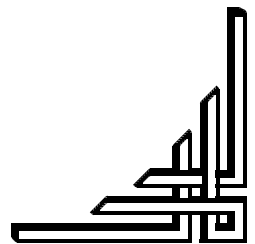

MUSIC ATELIER



AT90s / AT80s / AT60s

Owner's Manual

Before using this unit, carefully read the sections entitled: "IMPORTANT SAFETY INSTRUCTIONS" (Owner's manual p. 2), "USING THE UNIT SAFELY" (Owner's manual p. 3), and "IMPORTANT NOTES" (Owner's manual p. 5). These sections provide important information concerning the proper operation of the unit. Additionally, in order to feel assured that you have gained a good grasp of every feature provided by your new unit, Owner's manual should be read in its entirety. The manual should be saved and kept on hand as a convenient reference.

Copyright © 2001 ROLAND CORPORATION

All rights reserved. No part of this publication may be reproduced in any form without the written permission of ROLAND CORPORATION.

 CAUTION RISK OF ELECTRIC SHOCK DO NOT OPEN	
ATTENTION: RISQUE DE CHOC ELECTRIQUE NE PAS OUVRIR	
CAUTION: TO REDUCE THE RISK OF ELECTRIC SHOCK, DO NOT REMOVE COVER (OR BACK). NO USER-SERVICEABLE PARTS INSIDE. REFER SERVICING TO QUALIFIED SERVICE PERSONNEL.	



The lightning flash with arrowhead symbol, within an equilateral triangle, is intended to alert the user to the presence of uninsulated "dangerous voltage" within the product's enclosure that may be of sufficient magnitude to constitute a risk of electric shock to persons.



The exclamation point within an equilateral triangle is intended to alert the user to the presence of important operating and maintenance (servicing) instructions in the literature accompanying the product.

INSTRUCTIONS PERTAINING TO A RISK OF FIRE, ELECTRIC SHOCK, OR INJURY TO PERSONS.

IMPORTANT SAFETY INSTRUCTIONS SAVE THESE INSTRUCTIONS

WARNING - When using electric products, basic precautions should always be followed, including the following:

1. Read these instructions.
2. Keep these instructions.
3. Heed all warnings.
4. Follow all instructions.
5. Do not use this apparatus near water.
6. Clean only with a dry cloth.
7. Do not block any of the ventilation openings. Install in accordance with the manufacturers instructions.
8. Do not install near any heat sources such as radiators, heat registers, stoves, or other apparatus (including amplifiers) that produce heat.
9. Do not defeat the safety purpose of the polarized or grounding-type plug. A polarized plug has two blades with one wider than the other. A grounding type plug has two blades and a third grounding prong. The wide blade or the third prong are provided for your safety. When the provided plug does not fit into your outlet, consult an electrician for replacement of the obsolete outlet.
10. Protect the power cord from being walked on or pinched particularly at plugs, convenience receptacles, and the point where they exit from the apparatus.
11. Only use attachments/accessories specified by the manufacturer.
12. Never use with a cart, stand, tripod, bracket, or table except as specified by the manufacturer, or sold with the apparatus. When a cart is used, use caution when moving the cart/apparatus combination to avoid injury from tip-over.
13. Unplug this apparatus during lightning storms or when unused for long periods of time.
14. Refer all servicing to qualified service personnel. Servicing is required when the apparatus has been damaged in any way, such as power-supply cord or plug is damaged, liquid has been spilled or objects have fallen into the apparatus, the apparatus has been exposed to rain or moisture, does not operate normally, or has been dropped.



For the U.K.



IMPORTANT: THE WIRES IN THIS MAINS LEAD ARE COLOURED IN ACCORDANCE WITH THE FOLLOWING CODE.



BLUE: NEUTRAL
BROWN: LIVE

As the colours of the wires in the mains lead of this apparatus may not correspond with the coloured markings identifying the terminals in your plug, proceed as follows:
 The wire which is coloured BLUE must be connected to the terminal which is marked with the letter N or coloured BLACK.
 The wire which is coloured BROWN must be connected to the terminal which is marked with the letter L or coloured RED.
 Under no circumstances must either of the above wires be connected to the earth terminal of a three pin plug.







USING THE UNIT SAFELY

INSTRUCTIONS FOR THE PREVENTION OF FIRE, ELECTRIC SHOCK, OR INJURY TO PERSONS

About  WARNING and  CAUTION Notices

 WARNING	Used for instructions intended to alert the user to the risk of death or severe injury should the unit be used improperly.
 CAUTION	Used for instructions intended to alert the user to the risk of injury or material damage should the unit be used improperly. * Material damage refers to damage or other adverse effects caused with respect to the home and all its furnishings, as well to domestic animals or pets.

About the Symbols

	The  symbol alerts the user to important instructions or warnings. The specific meaning of the symbol is determined by the design contained within the triangle. In the case of the symbol at left, it is used for general cautions, warnings, or alerts to danger.
	The  symbol alerts the user to items that must never be carried out (are forbidden). The specific thing that must not be done is indicated by the design contained within the circle. In the case of the symbol at left, it means that the unit must never be disassembled.
	The  symbol alerts the user to things that must be carried out. The specific thing that must be done is indicated by the design contained within the circle. In the case of the symbol at left, it means that the power-cord plug must be unplugged from the outlet.

ALWAYS OBSERVE THE FOLLOWING

WARNING

- Before using this unit, make sure to read the instructions below, and the Owner's Manual. 



For AT-60S

- Do not open or perform any internal modifications on the unit. 

For AT-90S/80S

- Do not open or perform any internal modifications on the unit. (The only exception would be where this manual provides specific instructions which should be followed in order to put in place user-installable options; see p. 214.) 

- Do not attempt to repair the unit, or replace parts within it (except when this manual provides specific instructions directing you to do so). Refer all servicing to your retailer, the nearest Roland Service Center, or an authorized Roland distributor, as listed on the "Information" page. 

- Never use or store the unit in places that are:
 - Subject to temperature extremes (e.g., direct sunlight in an enclosed vehicle, near a heating duct, on top of heat-generating equipment); or are 
 - Damp (e.g., baths, washrooms, on wet floors); or are 
 - Humid; or are
 - Exposed to rain; or are
 - Dusty; or are
 - Subject to high levels of vibration.

- Make sure you always have the unit placed so it is level and sure to remain stable. Never place it on stands that could wobble, or on inclined surfaces. 

WARNING

- Use only the attached power-supply cord. 

- The unit should be connected to a power supply only of the type described in the operating instructions, or as marked on the unit. 

- Do not excessively twist or bend the power cord, nor place heavy objects on it. Doing so can damage the cord, producing severed elements and short circuits. Damaged cords are fire and shock hazards! 

- This unit, either alone or in combination with an amplifier and headphones or speakers, may be capable of producing sound levels that could cause permanent hearing loss. Do not operate for a long period of time at a high volume level, or at a level that is uncomfortable. If you experience any hearing loss or ringing in the ears, you should immediately stop using the unit, and consult an audiologist. 

- Do not allow any objects (e.g., flammable material, coins, pins); or liquids of any kind (water, soft drinks, etc.) to penetrate the unit. 

- In households with small children, an adult should provide supervision until the child is capable of following all the rules essential for the safe operation of the unit. 

- Protect the unit from strong impact. (Do not drop it!) 

⚠ WARNING

- Do not force the unit's power-supply cord to share an outlet with an unreasonable number of other devices. Be especially careful when using extension cords—the total power used by all devices you have connected to the extension cord's outlet must never exceed the power rating (watts/amperes) for the extension cord. Excessive loads can cause the insulation on the cord to heat up and eventually melt through. 

- Before using the unit in a foreign country, consult with your retailer, the nearest Roland Service Center, or an authorized Roland distributor, as listed on the "Information" page. 

For AT-90S/80S

- Always turn the unit off and unplug the power cord before attempting installation of the light bulbs (p. 214). 

⚠ CAUTION

- The unit should be located so that its location or position does not interfere with its proper ventilation. 

- Always grasp only the plug on the power-supply cord when plugging into, or unplugging from, an outlet or this unit. 

- Try to prevent cords and cables from becoming entangled. Also, all cords and cables should be placed so they are out of the reach of children. 

- Never climb on top of, nor place heavy objects on the unit. 

- Never handle the power cord or its plugs with wet hands when plugging into, or unplugging from, an outlet or this unit. 

- If you need to move the instrument, take note of the precautions listed below. At least two persons are required to safely lift and move the unit. It should be handled carefully, all the while keeping it level. Make sure to have a firm grip, to protect yourself from injury and the instrument from damage. 

- Check to make sure the bolt securing the unit to the stand have not become loose. Fasten them again securely whenever you notice any loosening.
- Disconnect the power cord.
- Disconnect all cords coming from external devices.
- Close the lid.
- Fold down the music stand.

⚠ CAUTION

- Before cleaning the unit, turn off the power and unplug the power cord from the outlet (p. 19). 

- Install only the specified light bulb(s). Remove only the specified screws (p. 214). 

- Be careful when opening/closing the lid so you do not get your fingers pinched (p. 18). Adult supervision is recommended whenever small children use the unit. 

- When using the bench, please observe the following points: 

- Do not use the bench as a toy, or as a stepping stool. 

- Do not allow two or more persons to sit on the bench.

- Do not sit on the bench if the bolts holding the bench legs are loose. (If the bolts are loose, immediately re-tighten them using the supplied wrench.)

- When opening or closing the seat lid, be careful not to pinch your fingers. In particular, be careful not to pinch your fingers in the folding metal supports (p. 22).

For AT-90S/80S

- Should you remove screws and light bulbs, make sure to put them in a safe place out of children's reach, so there is no chance of them being swallowed accidentally. 

Important Notes

In addition to the items listed under “IMPORTANT SAFETY INSTRUCTIONS” and “USING THE UNIT SAFELY” on pages 2 and 3, please read and observe the following:

Power Supply

- Do not use this unit on the same power circuit with any device that will generate line noise (such as an electric motor or variable lighting system).
- Before connecting this unit to other devices, turn off the power to all units. This will help prevent malfunctions and/or damage to speakers or other devices.

Placement

- Using the unit near power amplifiers (or other equipment containing large power transformers) may induce hum. To alleviate the problem, change the orientation of this unit; or move it farther away from the source of interference.
- This device may interfere with radio and television reception. Do not use this device in the vicinity of such receivers.
- Observe the following when using the unit's floppy disk drive. For further details, refer to “Before Using Floppy Disks” (p. 6).
 - Do not place the unit near devices that produce a strong magnetic field (e.g., loudspeakers).
 - Install the unit on a solid, level surface.
 - Do not move the unit or subject it to vibration while the drive is operating.
- Do not expose the unit to direct sunlight, place it near devices that radiate heat, leave it inside an enclosed vehicle, or otherwise subject it to temperature extremes. Also, do not allow lighting devices that normally are used while their light source is very close to the unit (such as a piano light), or powerful spotlights to shine upon the same area of the unit for extended periods of time. Excessive heat can deform or discolor the unit.
- To avoid possible breakdown, do not use the unit in a wet area, such as an area exposed to rain or other moisture.
- Do not allow rubber, vinyl, or similar materials to remain on the piano for long periods of time. Such objects can discolor or otherwise harmfully affect the finish.
- Do not put anything that contains water (e.g., flower vases) on the piano. Also, avoid the use of insecticides, perfumes, alcohol, nail polish, spray cans, etc., near the unit. Swiftly wipe away any liquid that spills on the unit using a dry, soft cloth.
- Do not allow objects to remain on top of the keyboard or pedalboard. This can be the cause of malfunction, such as keys ceasing to produce sound.
- Do not paste stickers, decals, or the like to this instrument. Peeling such matter off the instrument may damage the exterior finish.

Maintenance

- To clean the unit, use a dry, soft cloth; or one that is slightly dampened. Try to wipe the entire surface using an equal amount of strength, moving the cloth along with the grain of the wood. Rubbing too hard in the same area can damage the finish.
- Never use benzine, thinners, alcohol or solvents of any kind, to avoid the possibility of discoloration and/or deformation.

Repairs and Data

- Please be aware that all data contained in the unit's memory may be lost when the unit is sent for repairs. Important data should always be backed up on a floppy disk, or written down on paper (when possible). During repairs, due care is taken to avoid the loss of data. However, in certain cases (such as when circuitry related to memory itself is out of order), we regret that it may not be possible to restore the data, and Roland assumes no liability concerning such loss of data.

Additional Precautions

- Please be aware that the contents of memory can be irretrievably lost as a result of a malfunction, or the improper operation of the unit. To protect yourself against the risk of losing important data, we recommend that you periodically save a backup copy of important data you have stored in the unit's memory on a floppy disk.
- Unfortunately, it may be impossible to restore the contents of data that was stored on a floppy disk once it has been lost. Roland Corporation assumes no liability concerning such loss of data.
- Use a reasonable amount of care when using the unit's buttons, sliders, or other controls; and when using its jacks and connectors. Rough handling can lead to malfunctions.
- Never strike or apply strong pressure to the display.
- When connecting / disconnecting all cables, grasp the connector itself—never pull on the cable. This way you will avoid causing shorts or damage to the cable's internal elements.
- A small amount of heat will radiate from the unit during normal operation.
- To avoid disturbing your neighbors, try to keep the unit's volume at reasonable levels. You may prefer to use headphones, so you do not need to be concerned about those around you (especially when it is late at night).
- When you need to transport the unit, pack it in shock-absorbent material. Transporting the unit without doing so can cause it to become scratched or damaged, and could lead to malfunction.

Important Notes

- Do not pull the music stand too far forward when setting/releasing its latches.
- Use a cable from Roland to make the connection. If using some other make of connection cable, please note the following precautions.
 - Some connection cables contain resistors. Do not use cables that incorporate resistors for connecting to this unit. The use of such cables can cause the sound level to be extremely low, or impossible to hear. For information on cable specifications, contact the manufacturer of the cable.

Before Using Floppy Disks

Handling the Floppy Disk Drive

- Install the unit on a solid, level surface in an area free from vibration.
- Avoid using the unit immediately after it has been moved to a location with a level of humidity that is greatly different than its former location. Rapid changes in the environment can cause condensation to form inside the drive, which will adversely affect the operation of the drive and/or damage floppy disks. When the unit has been moved, allow it to become accustomed to the new environment (allow a few hours) before operating it.
- To insert a disk, push it gently but firmly into the drive—it will click into place. To remove a disk, press the EJECT button firmly. Do not use excessive force to remove a disk which is lodged in the drive.
- Never eject a disk while reading or writing is in progress, since that can damage the magnetic surface of the disk, rendering it unusable. (The disk drive's indicator will light up at full brightness when the drive is busy reading or writing data. Ordinarily, the indicator will be less brightly lit, or be extinguished.)
- Remove any disk from the drive before powering up or down.
- To prevent damage to the disk drive's heads, always try to hold the floppy disk in a level position (not tilted in any direction) while inserting it into the drive. Push it in firmly, but gently. Never use excessive force.
- To avoid the risk of malfunction and/or damage, insert only floppy disks into the disk drive. Never insert any other type of disk. Avoid getting paper clips, coins, or any other foreign objects inside the drive.

Handling Floppy Disks

- Floppy disks contain a plastic disk with a thin coating of magnetic storage medium. Microscopic precision is required to enable storage of large amounts of data on such a small surface area. To preserve their integrity, please observe the following when handling floppy disks:
 - Never touch the magnetic medium inside the disk.
 - Do not use or store floppy disks in dirty or dusty areas.

- Do not subject floppy disks to temperature extremes (e.g., direct sunlight in an enclosed vehicle). Recommended temperature range: 10 to 50° C (50 to 122° F).
- Do not expose floppy disks to strong magnetic fields, such as those generated by loudspeakers.
- Floppy disks have a “write protect” tab which can protect the disk from accidental erasure. It is recommended that the tab be kept in the PROTECT position, and moved to the WRITE position only when you wish to write new data onto the disk.

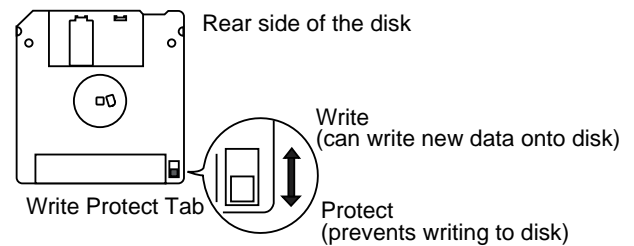

- The identification label should be firmly affixed to the disk. Should the label come loose while the disk is in the drive, it may be difficult to remove the disk.
- Store all disks in a safe place to avoid damaging them, and to protect them from dust, dirt, and other hazards. By using a dirty or dust-ridden disk, you risk damaging the disk, as well as causing the disk drive to malfunction.
- Disks containing performance data for this unit should always be locked (have their write protect tab slid to the “Protect” position) before you insert them into the drive on some other unit (except the PR-300, or a product in the HP-G, MT, KR, or Atelier families), or into a computer's drive. Otherwise (if the write protect tab remains in the “Write” position), when you perform any disk operations using the other device's disk drive (such as checking the contents of the disk, or loading data), you risk rendering the disk unreadable by this unit's disk drive.

- * GS () is a registered trademark of Roland Corporation.
- * Microsoft and MS-DOS are registered trademarks of Microsoft Corporation.
- * Apple and Macintosh are registered trademark of Apple Computer, Inc.
- * IBM and IBM PC are registered trademark of International Business Machines Corporation.
- * All product names mentioned in this document are trademarks or registered trademarks of their respective owners.

Main Features

Basic concepts of the ATELIER series

A full complement of organ sounds

A wide range of basic organ sounds, ranging from jazz organ and pipe organ to theatre organ, are onboard so you are sure to enjoy having access to all the sounds you expect from an organ.

Panel layout based on a tradition of emphasis on realtime operation

Based on the idea that you should be able to sit down and begin playing immediately, the operation buttons of the panel are arranged by function as dictated by classic organ traditions, ensuring easy and intuitive operation. All models of the ATELIER series feature the same operability, allowing you to start playing immediately even if you switch models.

High-quality sounds that you can use without editing

In addition to a full range of organ sounds, high-quality sounds such as strings and brass are also included onboard. You can simply select sounds and enjoy playing the organ—no need to perform complicated editing operations.

Expansive lower keyboard with damper pedal for piano-like expressiveness

Piano is indispensable to the performance of contemporary music. On the ATELIER series, the lower keyboard features an expanded range that gives you the expressive power of a piano. The keyboard also features half-damper pedal capability and initial touch sensitivity, both indispensable for piano performance.

All models provide high-quality grand piano sounds.

Design utilizes your existing music data

The ATELIER series is designed so that even on new models, you will feel right at home and can begin playing immediately. Data compatibility has also been carefully taken into account, and song data or registration data from earlier models can be used without change.

Music styles from around the world

Many of the best-loved musical styles from around the world (rhythm and automatic accompaniment patterns) are built in, allowing you to enjoy an international range of performances.

Utilizes SMF music files

Since a floppy disk drive is built in, you can use the wide array of commercially available SMF music files to enjoy ensemble performances or automatic playback.

Features

RSS reverb technology is used to create a high-quality ambience that surrounds the listener

The AT-90S/80S provides an AUX OUT for RSS Ambience, allowing you to enjoy very high quality RSS reverb sound. In addition, a speaker is built into the panel, ensuring that the performer will also enjoy the exceptional sound quality.

Featuring the newly developed V-Arranger with sophisticated rhythm sounds and realistic automatic accompaniment

You will enjoy rhythm and automatic accompaniment so realistic that it sounds like your own backup band is right there!

Newly developed Active Expression sounds

For some of the sounds, moving the expression pedal will vary not only the volume but also the tone, or add other sounds. From pianissimo to fortissimo, the tonal character of the sound itself will change as you perform a crescendo, or strings may appear behind the piano, creating dynamic changes in tonality.

Main Features

“Music Assistant” and “Quick Registration” functions

The “Music Assistant” function makes it easy to recall appropriate rhythm and sound settings simply by selecting a desired atmosphere for your song. The “Quick Registration” function lets you use keywords to select wonderful registrations created by top-ranking organists such as Hector Olivera.

Human voices and phrases

In addition to a full array of organ sounds, the ATELIER-S series provides human voices such as “Jazz Scat,” and human voice phrases such as “Amen.”

Harmony Intelligence

The Harmony Intelligence function automatically adds harmony to the upper keyboard sound according to the chord you play in the lower keyboard. This gives you greater tonal depth and a more powerful performance.

Store disk styles in internal memory

Although the Rhythm [Disk] button already contains various rhythms, these can be replaced by rhythms from a music style disk. Rhythms that are loaded from a music style disk into internal memory will not be lost even when the power is turned off, so you will find it convenient to load frequently used rhythms into internal memory.

76-note lower keyboard for plenty of range

The 76-note range can be split into zones, allowing a solo voice, pedal bass voice, percussion, etc., to be played independently for an even wider range of performance possibilities. Since the lower keyboard can be divided into a maximum of four parts, you have at your command expressive power that rivals that of a three-manual organ. In addition, you can use the Drums/SFX function to play drum sounds or sound effects from the entire lower keyboard.

Newly developed jazz organ style footage sound generator

The ATELIER features a new “digital harmonic bar” function that lets you adjust the volume of each footage of flute-type voices. In addition to the rich sounds of the ATELIER series, you can enjoy the versatile tonal expressions of a jazz organ.

Music score display in the LCD screen

The large LCD screen allows recorded data or loaded music data to be displayed as a musical score. You can enjoy the convenience of playing from a score, or checking the score of a song you recorded.

Video output of lyrics (AT-90S/80S)

You can connect a television to view the lyrics from SMF music files.

Index

USING THE UNIT SAFELY.....	3
Important Notes.....	5
Main Features.....	7
Panel Descriptions.....	14
Before You Start Playing.....	18
Attaching the Pedalboard (AT-90S).....	18
Opening/Closing the Lid.....	18
Setting Up the Music Stand.....	18
Connecting the Power Cord.....	19
Turning the Power On and Off	19
Turning On the Power.....	19
Turning Off the Power	19
Using Headphones.....	20
Using a Microphone.....	20
Turning On the Lights (AT-90S/80S)	21
About the Bench	22
Restoring All the Factory Default Settings	22
About the Display	24
Understanding the Main and Related Screens	24
About the Quick Guide function	27
Music Assistant Function	30
Chapter 1 Selecting and Playing Sounds	32
Listening to the Demo Songs.....	32
Selecting Voices	34
About the Voices and Parts	34
Functions of the Upper/Lower/Pedal Bass Sound Select Buttons	36
Selecting the Upper and Lower Voices.....	37
Selecting Pedal Bass Voice.....	38
Selecting Solo Voice	39
Selecting a Voice Using the [Others] Button.....	40
Performing with a Human Voice.....	42
Performing with an Active Expression Voice.....	44
Footage (AT-90S)	45
Adjust the Volume Balance.....	48
Transpose the Pitch in Octave Units (Octave Shift)	50
Playing Drum Sounds or Sound Effects from the Entire Lower Keyboard (Drums/SFX)	52
Changing Drums/SFX Sets	53
Simultaneously Playing a Lower Voice with Percussion Instrument Sounds and a Voice Phrase (Manual Percussion)	54
Changing the Manual Percussion Sets.....	55
Sustaining Notes Played on the Lower Keyboard (Lower Hold)	56

Chapter 2 Using Rhythm Performance	57
Selecting a Rhythm.....	57
Playing Rhythm	58
Starting at the Press of a Button	58
Starting the Rhythm Automatically When You Play the Lower Keyboard or Pedalboard (Sync Start)	59
Stopping the Rhythm.....	60
Changing a Rhythm's Tempo.....	60
Playing the Count Sound at the End of the Intro	61
Playing Rhythm and Automatic Accompaniment	61
Adding Variety to the Rhythm or Automatic Accompaniment.....	62
Changing the Arrangement of the Accompaniment (Style Orchestrator).....	62
Playing Chords with Simple Fingering.....	63
Leading Bass Function.....	64
A Simple Way to Make Automatic Accompaniment Settings (One Touch Program)	66
Using a Rhythm from a Disk	68
Inserting and Ejecting a Floppy Disk	68
Reviewing the Styles on a Music Style Disk	69
Loading Disk Rhythms Into Internal Memory	70
Restoring the Rhythm Stored in the [Disk] Button to the Factory Settings.....	72
Loading Rhythms from World Style Setup Disk Into Internal Memory	73
Restoring the Rhythm Stored in the [World] Button to the Factory Settings.....	75
 Chapter 3 Using the Registration Buttons	 76
Storing Registrations.....	76
Recalling a Registration	77
How to Recall a Registration (DELAYED)	77
How to Recall a Registration (INSTANT)	77
Changing the Timing of Recalling Registrations.....	78
Automatically Registering When You Switch Panel Settings.....	79
Assigning a Name to a Registration Set.....	80
Formatting Disks	82
Saving Registration Sets to a Floppy Disk	84
Loading Previously Saved Registration Sets Into the AT-90S/80S/60S	87
Loading a Set of Registrations.....	87
Loading an Individual Registration	89
Recalling the Order that the Registrations are Saved on the Floppy Disk (Load Next)	92
Deleting a Set of Registrations from a Floppy Disk	94
Changing the Order of Registration on Floppy Disk	96
Using Registrations Created on an Earlier Model	97
Choose a Keyword for Quick Registration Selection	100
 Chapter 4 Using the Performance Functions	 102
Transposing to a Different Key (Key Transpose)	102
Adjusting the Overall Volume Using an Expression Pedal	103
Adding Decay to the Sound (Damper Pedal).....	103
Pitch Bend and Vibrato Effects.....	104
Adjusting the Brightness of the Sound.....	104
Using the Foot Switches	105

Chapter 5 Applying Various Effects to the Sound	106
Adding Harmony to a Melody (Harmony Intelligence) (AT-90S).....	106
Harmony Intelligence [Others] button (AT-90S).....	107
Adding Harmony to a Melody (Harmony Intelligence) (AT-80S/60S).....	109
Changing the Type of Harmony Intelligence (AT-80S/60S).....	109
Adding Modulation to the Sound (Rotary Effect).....	111
Chorus Effect.....	112
Sustain Effect.....	113
Reverb Effect.....	114
Changing the Reverb Type.....	115
Changing the Wall Type.....	116
Changing the Depth of the Reverb.....	117
Rotary Speed.....	119
Rotary Color.....	120
Changing the Sustain Length.....	121
Chapter 6 Using the Lower Keyboard Effectively	122
Making Effective Use of the Lower Keyboard.....	122
Playing the Solo Voice on the Lower Keyboard (Solo [To Lower] Button).....	124
Using the Lower Keyboard to Play the Bass Voice ([Bass Split] Button).....	125
Using the Lower Keyboard to Play the Bass Voice ([To Lower] Button).....	126
Changing the Split Point.....	127
Solo Split Point.....	127
Bass Split Point.....	128
Chapter 7 Recording/Playing Back What You Play	129
Before Recording/Playing Back What You Play.....	129
What is a Track Button?.....	129
Displaying the Track Buttons.....	130
Playing Back Performance Songs Stored on Floppy Disk.....	130
Recording a Performance.....	132
Playing Back a Performance Song.....	133
Silencing a Specific Track (Track Mute).....	134
Track Assignments When Playing Commercial SMF Data.....	134
Recording Each Part Separately.....	135
Re-Recording.....	136
Erasing a Performance Song (Song Clear).....	137
Changing the Name of a Performance Song (Rename).....	137
Saving Performance Songs Onto Floppy Disk.....	139
Loading Performance Songs Into the AT-90S/80S/60S.....	140
Layering a New Recording onto SMF Format Music Files.....	141
Deleting Performance Songs Stored on Disk.....	142
Re-Recording Part of Your Performance (Punch-in Recording).....	143
Recording and Layering Drum Parts (Loop Recording).....	144
Count-In Recording.....	145
Viewing a Musical Score.....	145
Changing the Score Settings.....	146

Chapter 8 Editing Your Musical Performance Data	149
Deleting a Specific Measure (Delete Measure).....	149
Delete the Recording from a Track (Delete Track)	150
Erase Recording (Erase Event)	152
Copying Measures (Copy)	154
Correct Timing Inaccuracies (Quantize)	155
Chapter 9 Various Other Settings	157
Adjusting How the Instrument Responds.....	157
Turning Aftertouch On/Off.....	157
Adjusting the Depth of Aftertouch.....	157
Turning Initial Touch On/Off.....	158
Changing the Pedalboard Polyphony.....	158
Changing How the Solo Voice Responds.....	159
Layering the Solo Voice and Lower Voice	159
Performance Function Settings.....	160
Changing the Function of the Foot Switch.....	160
Using the Foot Switch to Switch Registrations.....	161
Selecting the Range of Keys to Which the Damper Pedal will Apply.....	161
Changing the Function of the Expression Pedal	162
Adjusting the Depth of the Expression Pedal.....	163
Selecting the Range of Keys to Which the Pitch Bend/Vibrato Lever will Apply	163
Changing the Pitch Bend Range	164
Rhythm Settings.....	164
Turning Chord Intelligence On/off	164
Turning Chord Hold On/Off.....	165
Using the Leading Bass Function	165
Count Down Sound	166
Registration Settings	166
Changing the Timing at Which Arranger Settings are Recalled.....	166
Changing the Timing at Which Transposition Settings are Recalled.....	167
Composer settings.....	167
Switching the Display of Lyrics On or Off.....	167
Changing the Key When Playing Back Songs (Playback Transpose).....	168
Changing the Metronome Setting.....	168
Adjusting the Metronome Volume.....	169
Changing the Sound of the Metronome	169
Setting the Beat	170
Muting Individual Channels of Performance Data.....	170
Other Settings.....	171
Adjust the Standard Pitch (Master Tune).....	171
Mic Echo	172
Enabling Transmission of PC Numbers.....	172
Setting the PC Number.....	173
MIDI IN Mode	173
Selecting the MIDI Transmit Channel.....	174
Repositioning the Touch Screen.....	175
Displaying a Graphic at Power-up.....	175
Deleting an Image Stored in Internal Memory	177

Chapter 10 Connecting with External Device.....178

Name and Functions of Jack and Connectors (AT-90S/80S)	178
Name and Functions of Jack and Connectors (AT-60S).....	179
Connecting to Audio Equipment	180
Connecting a Computer	181
Connecting MIDI Devices	183
Connecting a Television to View the Lyrics (AT-90S/80S only)	184
Switching the TV Format	184
Connecting ExternalSpeakers or an External Reverb Unit to Broaden the Reverb (RSS Reverb)	185
Switching the Aux Out Mode.....	185
Switching the Aux Out On/OFF	185

Appendix

Troubleshooting.....	186
Error Message	191
Voice List (AT-90S/80S)	193
Voice List (AT-60S).....	196
Drums/SFX Set List	198
Manual Percussion List (AT-90S/80S)	202
Manual Percussion List (AT-60S).....	203
Rhythm List (AT-90S)	204
Rhythm List (AT-80S)	206
Rhythm List (AT-60S)	208
Music Style Disk List (AT-90S/80S/60S).....	209
Chord List.....	210
Glossary	212
About ATELIER Series Sound Generator.....	213
Replacing the Illumination Bulbs.....	214
Remplacement des ampoules	218
Settings That Are Stored After the Power Is Turned Off.....	222
MIDI Imprementation Chart	223
Demo Song List.....	224
Main Specifications (AT-90S).....	226
Index.....	229

Panel Descriptions

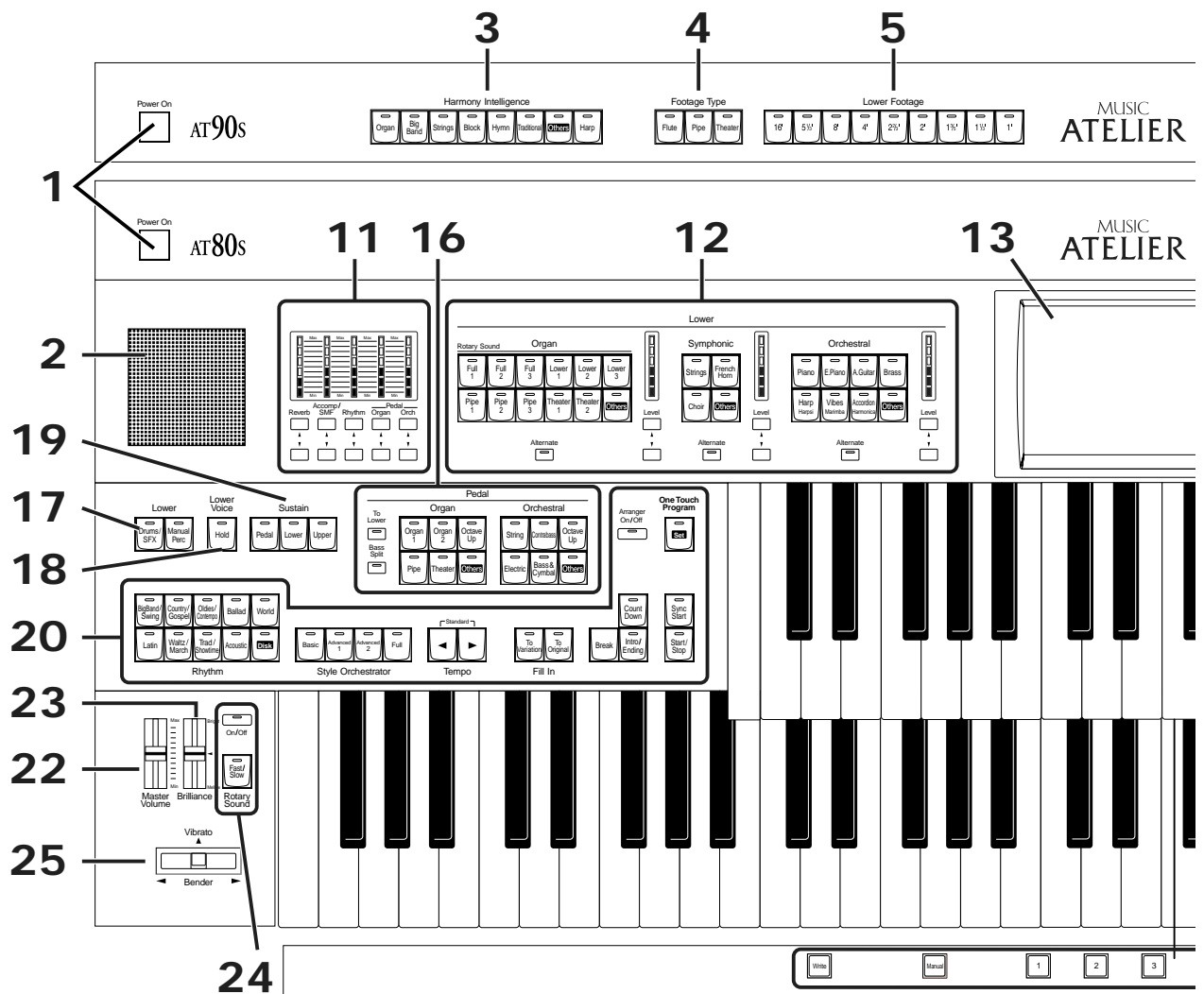

1. [Power On] switch → p. 19
2. Panel Speaker
3. Harmony Intelligence button → p. 106–p. 109
4. Footage Type buttons (AT-90S only) → p. 45
5. Lower Footage buttons (AT-90S only) → p. 45
6. Upper Footage buttons (AT-90S only) → p. 45
7. Percussion buttons (AT-90S only) → p. 45
8. Transpose [-] [+] buttons → p. 102
9. Composer → p. 129
[Reset] button
[Play/Stop] button
[Rec] button
[Song] button
[Registration] button → p. 87
[Demo] button → p. 32, p. 130
10. Floppy Disk Drive → p. 68, p. 82, p. 139
11. Part Balance [▲] [▼] buttons → p. 48
Part Balance Indicator
12. Lower Voice select buttons → p. 37
Lower Organ Part
Lower Symphonic Part
Lower Orchestral Part
[Alternate] button
13. Touch Screen → p. 24
14. Upper Voice select buttons → p. 37
Upper Organ Part
Upper Symphonic Part
Upper Orchestral Part
[Alternate] button
15. Solo Voice select buttons → p. 39
Solo Part
[Alternate] button
[To Lower] button → p. 124

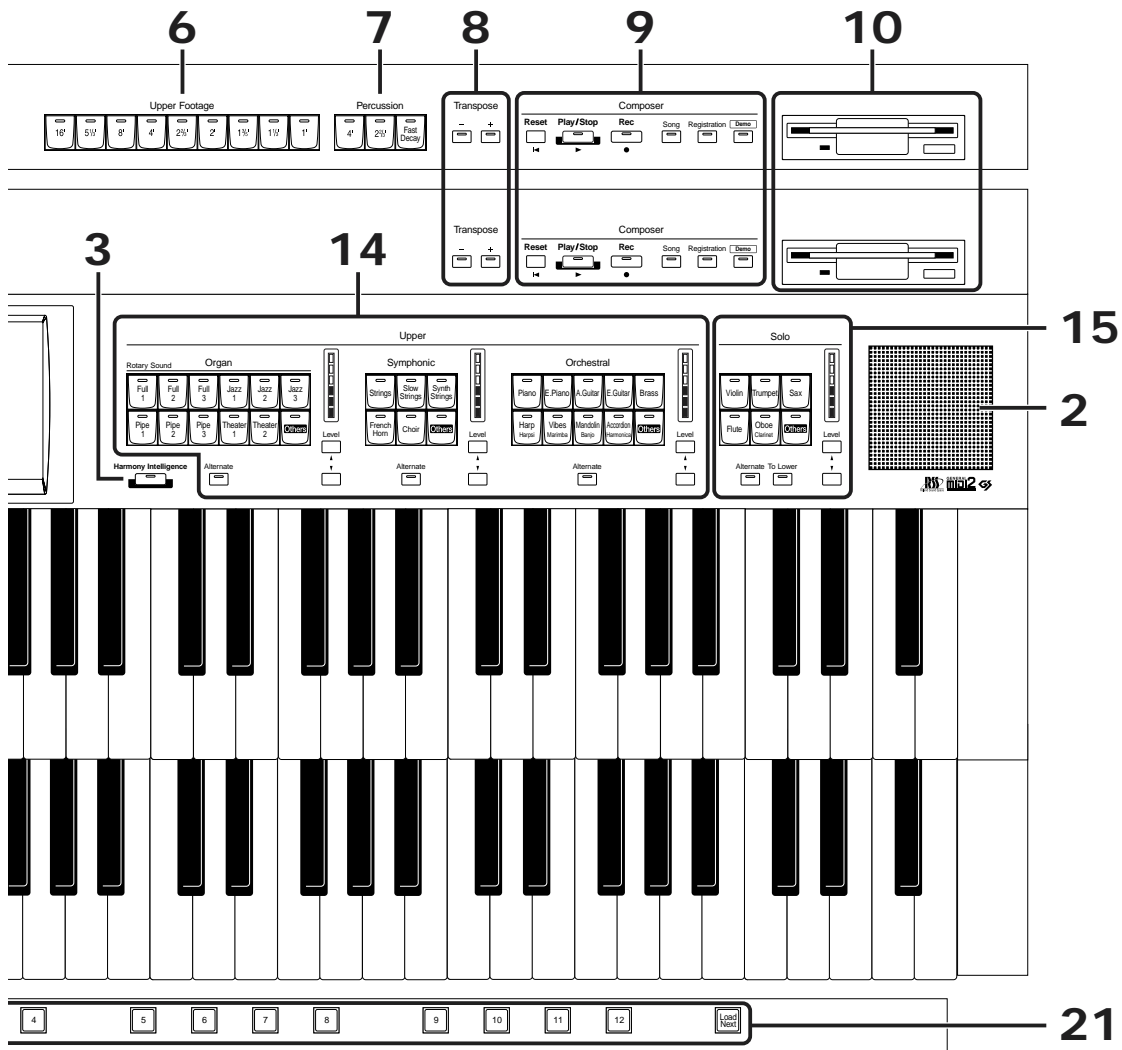

16. Pedal Bass Voice select buttons → p. 38

- Pedal Organ Part
- Pedal Orchestral Part
- [To Lower] button → p. 126
- [Bass Split] button → p. 125

17. Lower

- [Drums/SFX] button → p. 52
- [Manual Perc] button → p. 54

18. Lower Voice [Hold] button → p. 56

19. Sustain → p. 113

- [Pedal] button
- [Lower] button
- [Upper] button

20. Rhythm select buttons → p. 57

- Style Orchestrator buttons → p. 62
- Tempo [◀] [▶] buttons → p. 60
- Fill In [To Variation] button → p. 62
- Fill In [To Original] button → p. 62

[Break] button → p. 62

[Intro/Ending] button → p. 58, p. 59

[Count Down] button → p. 61

[Sync Start] button → p. 59

[Start/Stop] button → p. 58, p. 60

Arranger [On/Off] button → p. 61

[One Touch Program] button → p. 66

21. Registration buttons

- [Write] button → p. 76
- [Manual] button → p. 79
- Registration [1] - [12] buttons → p. 76
- [Load Next] button → p. 92

22. [Master Volume] slider → p. 19

23. [Brilliance] slider → p. 104

24. Rotary Sound → p. 111

- [On/Off] button
- [Fast/Slow] button

25. [Bender/Vibrato] lever → p. 104

Panel Descriptions

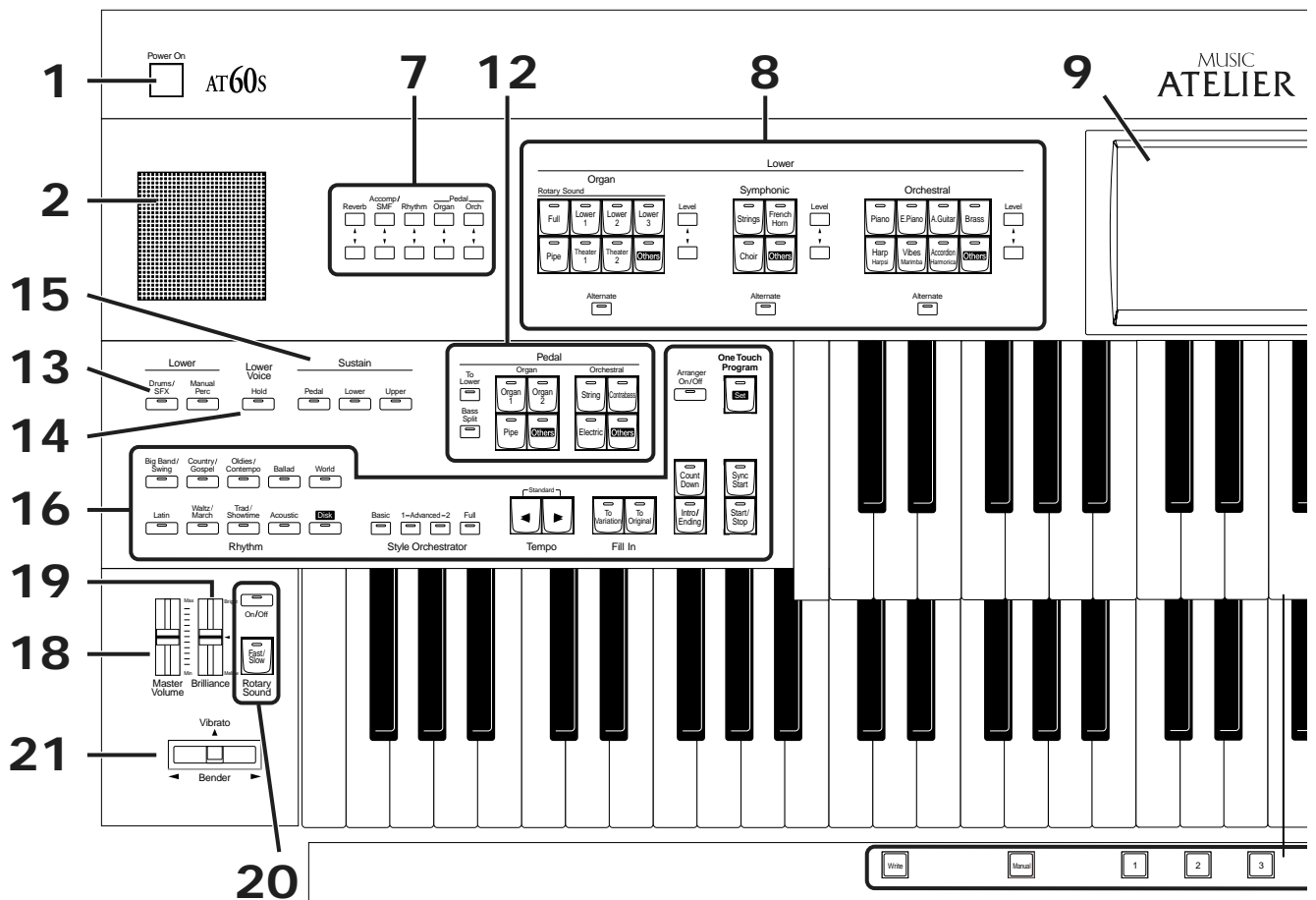

1. [Power On] switch → p. 19
2. Panel Speaker
3. [Harmony Intelligence] button → p. 109
4. Transpose [-] [+] buttons → p. 102
5. Composer → p. 129
[Reset] button
[Play/Stop] button
[Rec] button
[Song] button
[Registration] button → p. 87
[Demo] button → p. 32, p. 130
6. Floppy Disk Drive → p. 68, p. 82, p. 139
7. Part Balance [▲] [▼] buttons → p. 48
8. Lower Voice select buttons → p. 37
Lower Organ Part
Lower Symphonic Part
Lower Orchestral Part
[Alternate] button
9. Touch Screen → p. 24
10. Upper Voice select buttons → p. 37
Upper Organ Part
Upper Symphonic Part
Upper Orchestral Part
[Alternate] button
11. Solo Voice select buttons → p. 39
Solo Part
[Alternate] button
[To Lower] button → p. 124
12. Pedal Bass Voice select buttons → p. 38
Pedal Organ Part
Pedal Orchestral Part
[To Lower] button → p. 126
[Bass Split] button → p. 125
13. Lower
[Drums/SFX] button → p. 52
[Manual Perc] button → p. 54

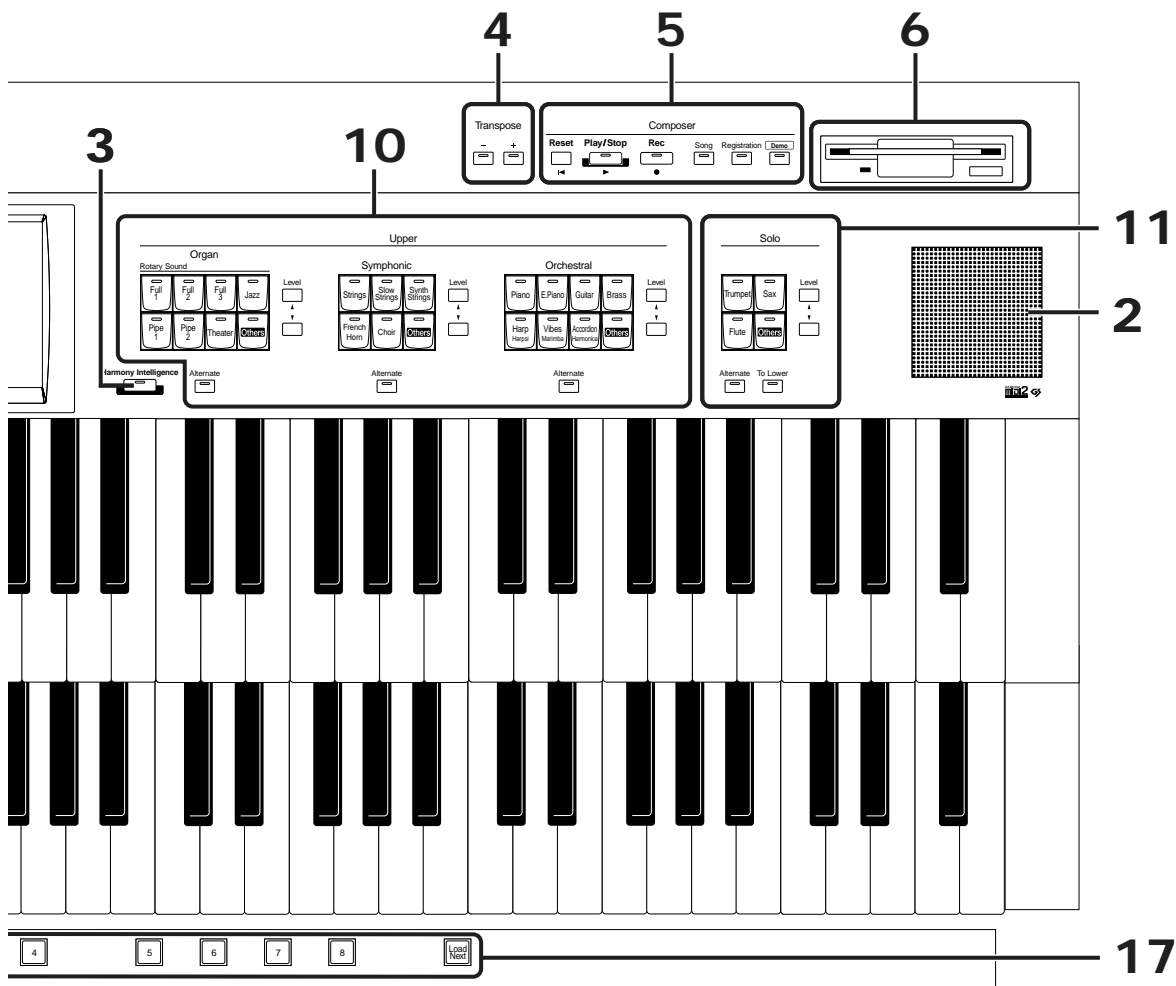

14. Lower Voice [Hold] button → p. 56

15. Sustain → p. 113

[Pedal] button

[Lower] button

[Upper] button

16. Rhythm select buttons → p. 57

Style Orchestrator buttons → p. 62

Tempo [◀] [▶] buttons → p. 60

Fill In [To Variation] button → p. 62

Fill In [To Original] button → p. 62

[Intro/Ending] button → p. 58, p. 59

[Count Down] button → p. 61

[Sync Start] button → p. 59

[Start/Stop] button → p. 58, p. 60

Arranger [On/Off] button → p. 61

[One Touch Program] button → p. 66

17. Registration buttons

[Write] button → p. 76

[Manual] button → p. 79

Registration [1] - [8] buttons → p. 76

[Load Next] button → p. 92

18. [Master Volume] slider → p. 19

19. [Brilliance] slider → p. 104

20. Rotary Sound → p. 111

[On/Off] button

[Fast/Slow] button

21. [Bender/Vibrato] lever → p. 104

Before You Start Playing

Attaching the Pedalboard (AT-90S)

1. Detach the pedal cable that is temporarily fastened to the board on the upper part of the Expression Pedal.
2. Connect the pedal cable to the connector located at the right side of the Pedalboard.
3. Slide the Pedalboard firmly all the way back so that it is secure and unable to move.

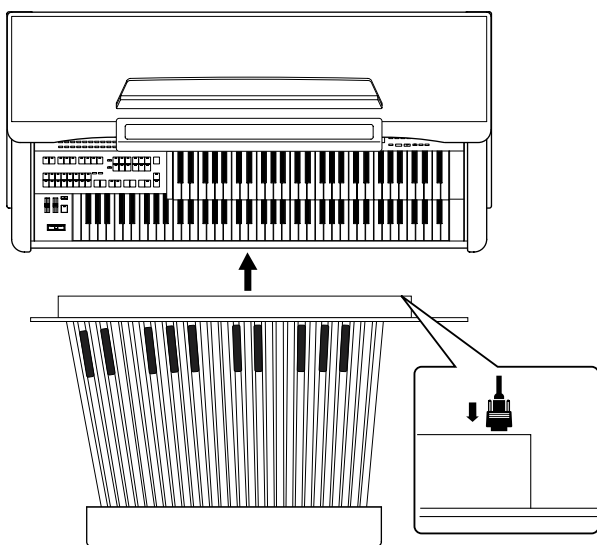

NOTE

Do not remove the fastener located near the Expression Pedal. Before transporting the AT-90S, be sure to wind up the pedal cable so that there is no slack, and attach it to the fastener.

Opening/Closing the Lid

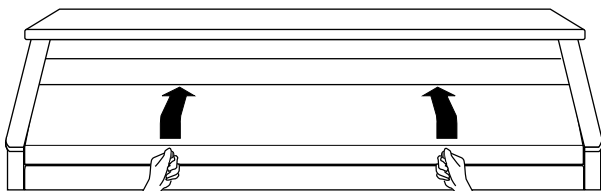

1. To open the lid, hold it with both hands and lift it straight up. Then, slide it to the rear.
2. To close the lid, slowly pull it forward until it stops. Then, gently lower it into place.

NOTE

Be careful not to get your fingers caught when opening or closing the lid. Adult supervision is recommended when small children are going to be using the instrument.

NOTE

To prevent accidents, be sure to close the lid before moving the organ.

NOTE

Make sure you don't have anything (such as sheet music) on the keyboard when you close the lid.

Setting Up the Music Stand

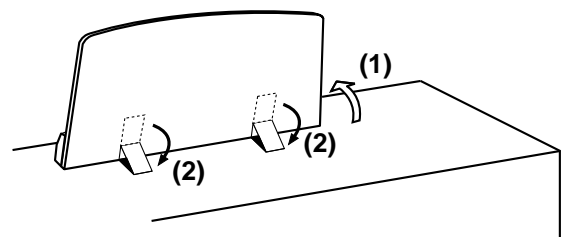

1. Lift the music stand gently.
2. Adjust the metal latches as shown in the illustration above.

(AT-90S only)

3. To set up the music stand, always use both hands to lift the base, and pull it gently toward yourself.

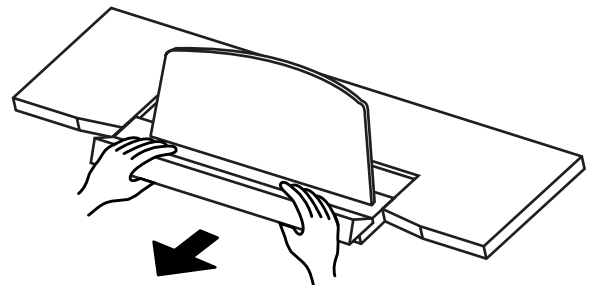

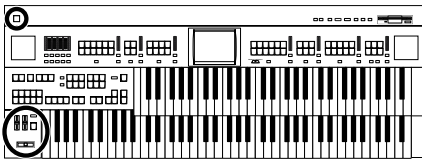

Before You Start Playing

Connecting the Power Cord

1. First, make sure that the [Power On] switch at the panel's left side is OFF (not pushed in).
2. Connect the supplied power cord to the AC Inlet connector, then plug the other end into an AC outlet.

NOTE

Only use the power cord supplied with this instrument.

NOTE

Whenever you do not intend to use the instrument for extended periods of time, pull out the power cord from the AC outlet.

Turning the Power On and Off

NOTE

Once the connections have been completed, turn on or off power to your various devices in the order specified. By turning on or off devices in the wrong order, you risk causing malfunction and/or damage to speakers and other devices.

■ Turning On the Power

1. Make sure of the following before the power is turned on.
 - Is the power cable correctly connected to the AC inlet?
 - Is the power cable correctly connected to the AC outlet?
 - Is the [Master Volume] slider (located at the left of the Lower Keyboard) set to the Min (minimum) position?

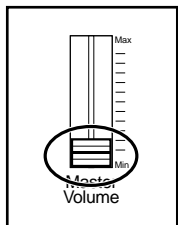

2. Press the [Power On] button to turn on the power.

The Power indicator lights in red.

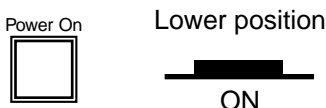

NOTE

This unit is equipped with a protection circuit. A brief interval (a few seconds) after power up is required before the unit will operate normally.

3. The [Master Volume] slider located on the left of the Lower Keyboard panel is an overall control for adjusting the volume of the entire instrument.

Now adjust the [Master Volume] slider to a suitable level. The volume will be increased when the Expression Pedal is pressed down, and decreased when the pedal is returned.

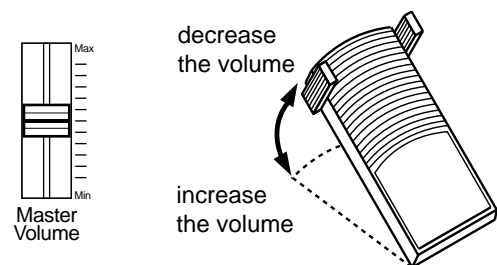

■ Turning Off the Power

1. Before switching the power off, set the [Master Volume] slider to the Min (minimum) position.
2. Press the [Power On] button to turn off the power.



Before You Start Playing

Using Headphones

The AT-90S/80S/60S features a Phones jack. This allows you to play without having to worry about bothering others around you, even at night.

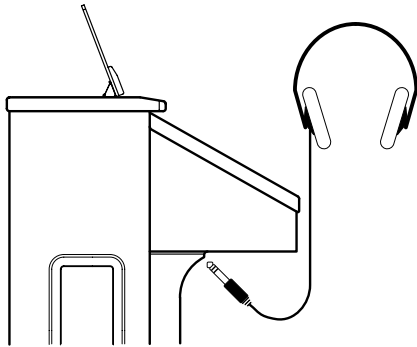

1. **Connect the headphones to the Phones jack on the underside of the unit.**

The sound from the built-in speakers stops.

Now, sound is heard only through the headphones.



Phones

2. **Adjust the headphones volume with the [Master Volume] slider and Expression pedal.**



Accepts connection of Stereo headphones.

Some Notes on Using Headphones

CAUTION

- To prevent damage to the cord, handle the headphones only by the headset or the plug.
- Headphones may be damaged if the volume is too high when they are plugged in. Lower the volume on the AT-90S/80S/60S before plugging in headphones.
- To prevent possible auditory damage, loss of hearing, or damage to the headphones, the headphones should not be used at an excessively high volume. Use the headphones at a moderate volume level.

Using a Microphone

The AT-90S/80S/60S is equipped with a Mic jack. Since this instrument has a Mic In jack, you can use a microphone to enjoy a variety of possibilities such as singing along with your performance, or singing along with SMF music files (sold separately).

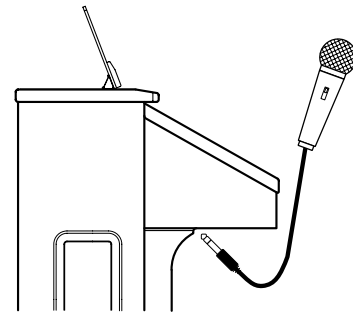

1. **Connect the microphone to the Mic In jack on the underside of the unit.**
2. **Use the [Mic Volume] knob to adjust the volume level for the microphone.**



You can adjust the depth of the echo applied to sound from the microphone (p. 172).



The microphone must be purchased separately. When purchasing a microphone, please consult the vender where you bought the AT-90S/80S/60S.



If the Input switch is set to "RSS," RSS reverb will be applied to the sound from the microphone. You can use the [Master Volume] knob to adjust the microphone volume (p. 185).

Some Notes on Using a Microphone

CAUTION

- To avoid disturbing others, be careful of the volume level when playing late at night or very early in the morning.
- When connecting a microphone to the AT-90S/80S/60S, be sure to lower the volume. If the volume control is too high when the microphone is plugged in, noise may be produced by the speakers.
- Howling could be produced depending on the location of microphones relative to speakers. This can be remedied by:
 - Changing the orientation of the microphone.
 - Relocating the microphone so it is farther from the speakers.
 - Lowering volume levels.

Turning On the Lights (AT-90S/80S)

After turning on the power, turn on the [Illumination] switch (located underneath the left-hand side of the keyboard).



On
Illumination

AT-90S	The illumination for the AT-90S's music stand, front panel, and pedalboard (below the keyboard) will light.
AT-80S	The panel illumination of the instrument will light.

Cautions When Using Illumination

CAUTION

When the illumination is used for an extended period, the light bulbs and the metal parts near the light bulb (see diagram below) will become hot. Be careful not to touch these areas. In particular, be careful of the following locations.

- 1. Panel illumination light bulb (AT-90S, AT-80S)**
Do not touch the light bulb or nearby parts. When closing the lid, be sure to hold the handles.
- 2. Metal fittings of the cover (AT-90S, AT-80S)**
After closing the lid, do not touch this area.
- 3. Music stand (AT-90S only)**
Do not touch the light bulb cover.
- 4. Light bulb cover for foot area (below keyboard) (AT-90S only)**
The entire cover will become hot. Be careful not to touch your leg to this area.



The bulbs used for illumination can be replaced. For details on replacing a bulb, refer to “Replacing the Illumination Bulbs” (p. 214).

AT-90S

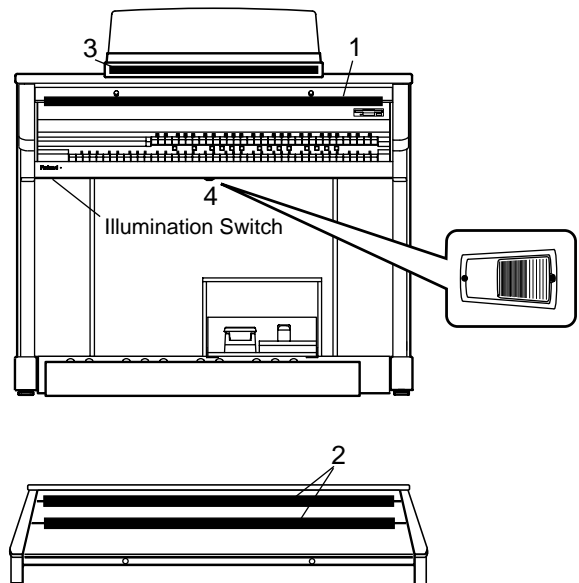

AT-80S

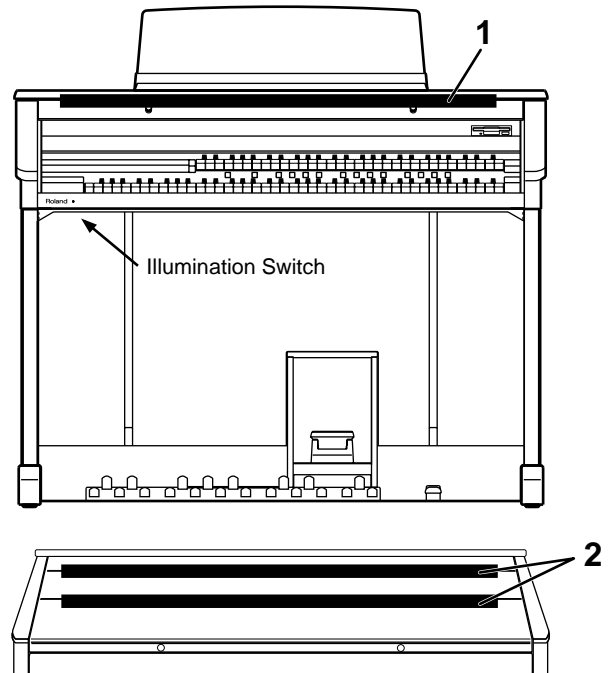

Before You Start Playing

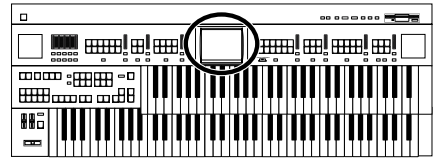

About the Bench

The bench seat can be opened, and sheet music and other items can be stored inside.

Caution When Using the Bench

 **CAUTION**

When opening/closing the seat, be careful not to pinch your fingers.

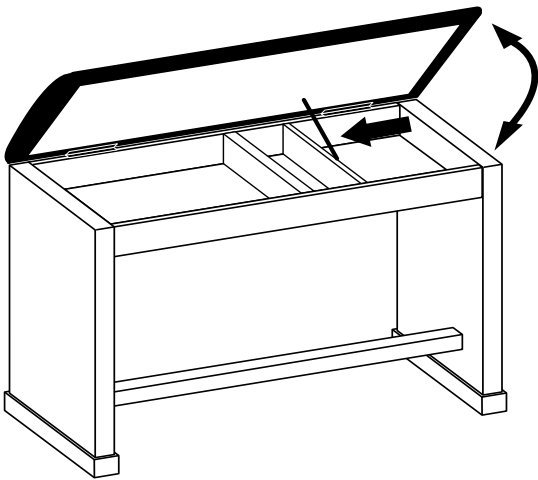

Restoring All the Factory Default Settings

The settings stored in the AT-90S/80S/60S can be returned to their factory settings. This function is called "Factory Reset."

1. Make sure there is no floppy disk in the disk drive before carrying out the procedure.
2. Touch <System> on the Main screen.

The System screen appears.

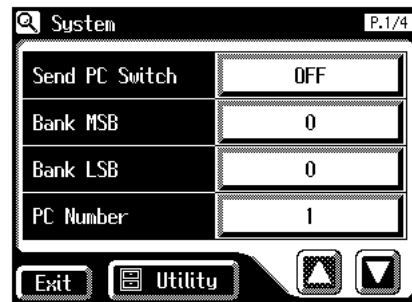

3. In the System screen, touch <Utility> to open the Utility screen.

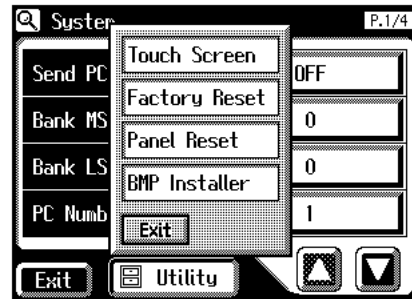

4. In the Utility screen, touch <Factory Reset>.

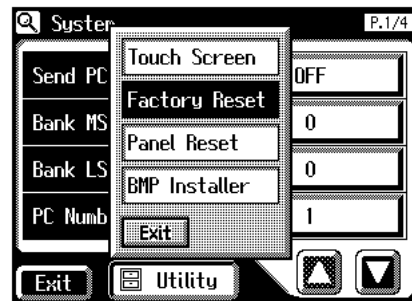

MEMO

To restore all of the factory settings other than those for the Rhythm [Disk] button and [World] button settings, touch <Panel Reset>.

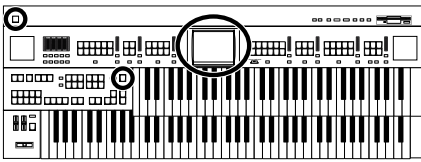

Before You Start Playing

The confirmation message appears on screen.



If you touch <Cancel>, the Factory Reset will not be performed, and you will return to the System screen.

5. When you touch <OK>, the Factory Reset operation will begin, and the settings will return to the factory-set condition.

NOTE

Never switch off the power while this operation is in progress!

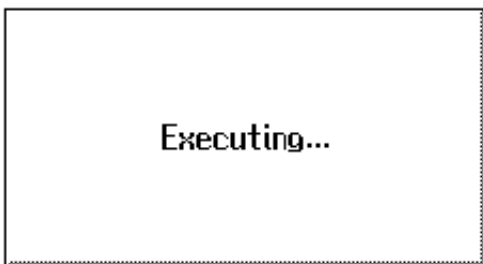

NOTE

Loading factory default settings will erase any Registrations currently in the memory of the AT-90S/80S/60S. To save the registrations you are currently using, refer to “**Saving Registration Sets to a Floppy Disk**” (p. 84).

NOTE

If you want to restore the factory settings for only the Rhythm [Disk] button and [World] button, refer to p. 70, 73.

You can also use the following method to return to the factory-set condition.

1. Make sure there is no floppy disk in the disk drive before carrying out the procedure.
2. Turn off the power.
3. While holding down the [One Touch Program] button, press the [Power On] switch to turn the power on.



Hold down the [One Touch Program] button until the following is displayed.



NOTE

Never switch off the power while this operation is in progress!

About the Display

The AT-90S/80S/60S makes use of a Touch Screen. This lets you carry out a wide variety of actions just by touching the screen lightly.

■ Understanding the Main and Related Screens

Main Screen

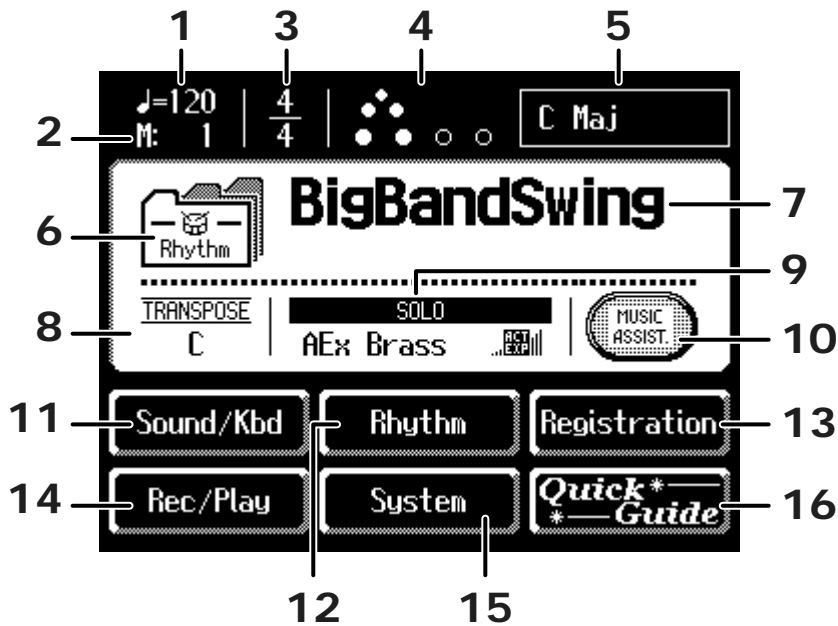

Number	Explanations
1	Tempo
2	Measure
3	Beat
4	Bouncing Ball A ball will bounce in time with the rhythm or song.
5	Chord Name Displays the name of the chord that is played in the lower keyboard.
6	Indication button Pressed to choose which name to have indicated; either the Rhythm Name, Song Name, or Registration Name.
7	Rhythm Name/Song Name/Registration Name
8	Transpose Displays the transpose setting.
9	Voice Name Displays the name of the upper keyboard voice.

NOTE

The explanations in this manual include illustrations that depict what should typically be shown by the display. Note, however, that your unit may incorporate a newer, enhanced version of the system (e.g., includes newer sounds), so what you actually see in the display may not always match what appears in the manual.

NOTE

The Touch Screen is operated by touching it lightly with your finger. Pressing hard, or using a hard object can damage the Touch Screen. Be careful not to press too hard, and be sure to use only your fingers to operate the Touch Screen.

NOTE

The positioning of the Touch Screen may become displaced due to changes in the surrounding environment and over time. If this happens, follow the steps in “**Repositioning the Touch Screen**” (p. 175) to correct the pointer position.

NOTE

Do not place items on the touch screen.

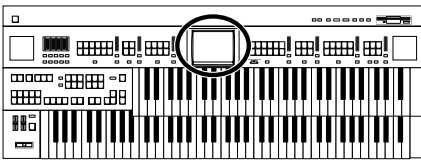

About the Display

Number	Explanations
10	Music Assist Press this when you want to use the Music Assistant function (p. 30).
11	Sound/Kbd Select a voice (tone), or make settings for the effect depth, keyboard, etc.
12	Rhythm Play the internal rhythms, and play disk rhythms or store them in internal memory. Rhythm-related settings can also be made here.
13	Registration Load registrations from disk into internal memory, or save registrations to disk. Registration-related settings can also be made here.
14	Rec/Play Play back or record a song. You can also view a score display while a song plays.
15	System Make various settings.
16	Quick Guide Use the Quick Guide function (p. 27).

NOTE

You can adjust the LCD contrast (p. 178).

About the principal icons and the Utility screen

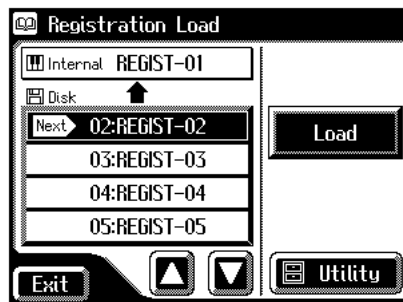
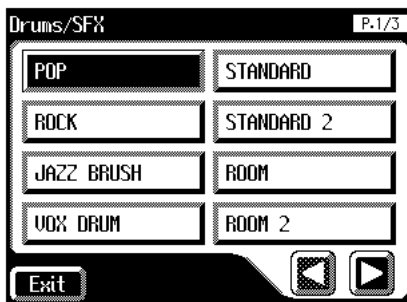

Button	Meaning
	<p>Depending on the function, some screens are spread over multiple pages.</p> <p>You can touch < > < > < > < > to display the next or previous page of the screen.</p>
	<p>Touch this when you want to exit (close) the currently displayed screen. Normally, touching < > several times takes you back to the Main screen.</p>

About the Display

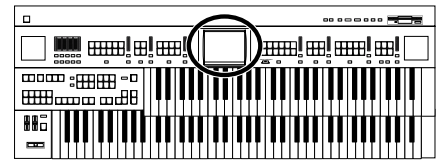

Sub-windows

You can touch <Sound/Kbd> or <Registration> in the Main screen or <Utility> in other screens to access a screen like the following.

This type of screen is called a “sub-window.”

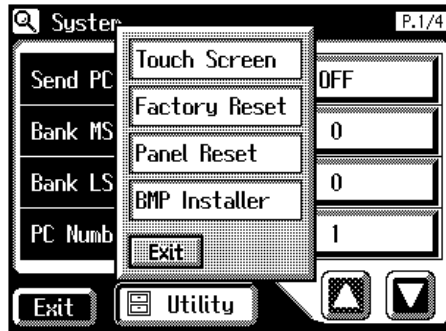
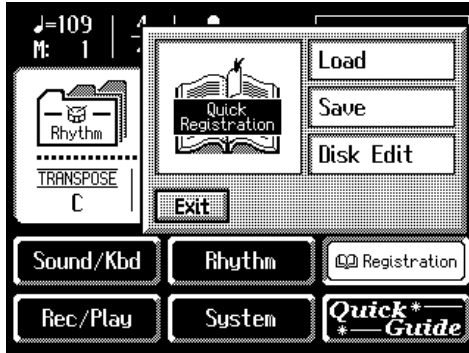

MEMO

When you touch a menu in the sub-window, the sub-window will close, and the selected menu screen will appear.

MEMO

In a sub-window, touch <Exit> to exit the sub-window.

Sub-windows for setting values

When you are making settings in the System screen, the following type of screen appears.

Factory	Return to the factory settings.
- +	Modify the value.

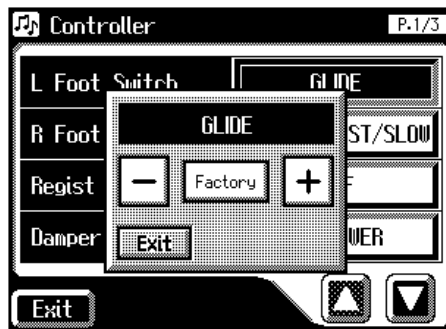

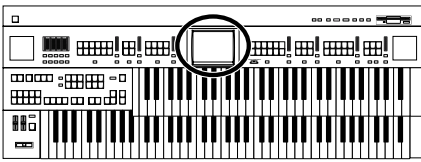

■ About the Quick Guide function

The AT-90S/80S/60S offers a Quick Guide function, which makes it easy for you to access various functions. While the Quick Guide screen is displayed, you can press the keyboard, a button, or a foot switch to jump to the related setting screen.

1. Display the Main screen.

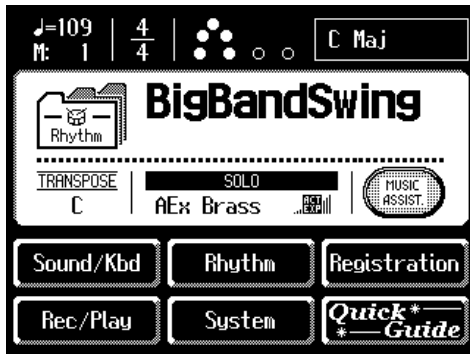

2. Touch <Quick Guide> on the Main screen.

The following Quick Guide screen appears for several seconds.



3. While the Quick Guide screen is displayed, press a button, keyboard, pedal, or foot switch.

You will be taken to the screen that contains settings related to the button, keyboard, pedal, or foot switch that you pressed.

4. Make settings in the screen to which you jumped.

5. When you are finished making settings, touch <Exit> to close the screen.

The Main screen appears.



If some other screen is displayed, touch <Exit> to close the currently open screen.

About the Display

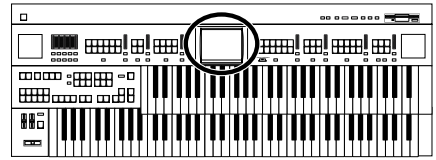

About the Index menu

In the Quick Guide screen, you can touch <index> to access the Index Menu.

In the Index Menu screen, you can touch a keyword to jump to the setting screen for that keyword.

1. Touch <Quick Guide> on the Main screen.

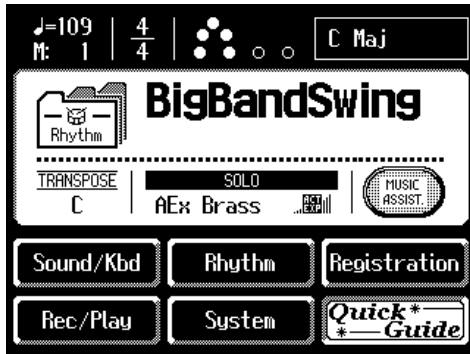

The following Quick Guide screen appears for several seconds.



2. While the Quick Guide screen is displayed, touch <index>.

The following screen appears.

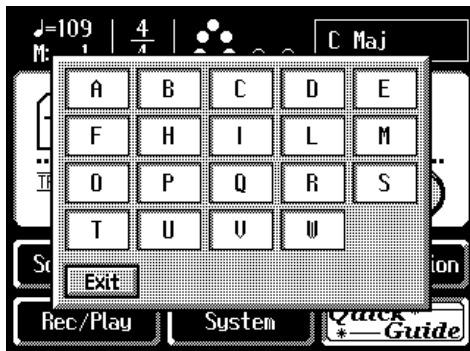

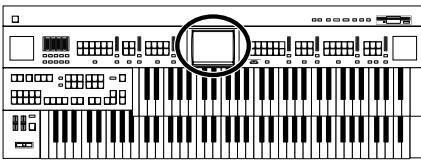

- 3. Touch a letter of the alphabet A–W to select the first letter of the desired keyword.**

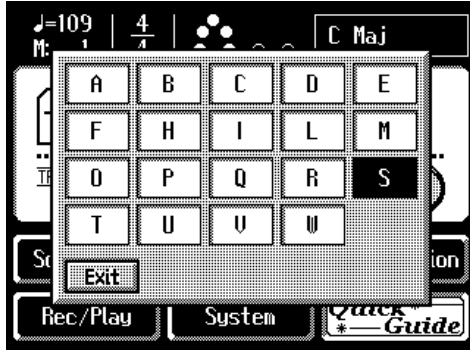

The Quick Guide Index screen appears, and the keywords will be displayed.

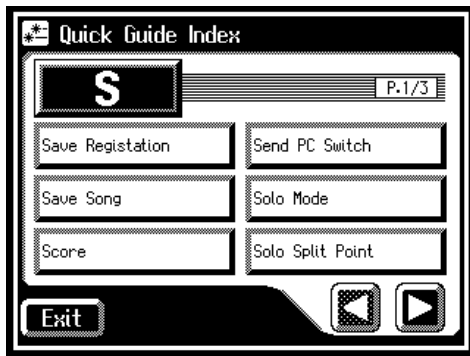

- 4. Touch the desired keyword.**
The setting screen for the specified keyword appears.
- 5. Make settings in the setting screen that appeared.**
- 6. Touch <Exit>.**

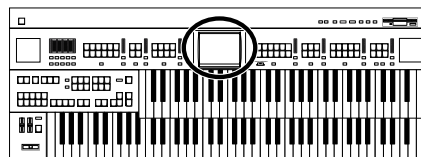

Music Assistant Function

A collection of the world's best, most well-known songs were carefully selected, then the optimum panel settings for each of them were determined, and the resulting data was stored inside the instrument.

Simply select the keyword that most closely suggests the character of the song you have in mind, and a rhythm performance, a sound for the melody, and other selections will be made for you. Once you've selected a keyword, all you have to do is play the keyboard to start performing.

1. Display the Main screen.

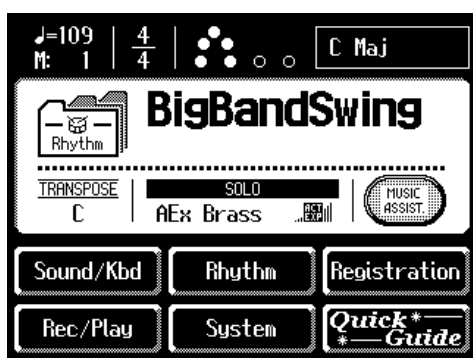

2. Touch <Music Assist.> on the Main screen.

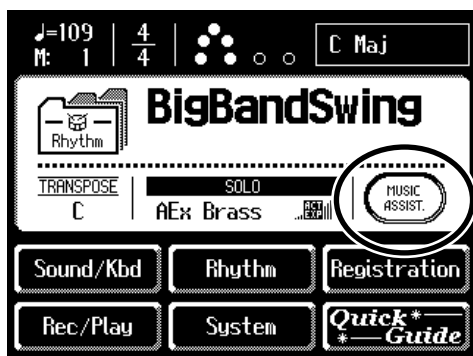

The Music Assistant screen appears.



If some other screen is displayed, touch <Exit> to close the currently open screen.

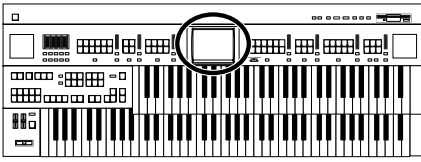

3. Touch a keyword appropriate for the character of the song.

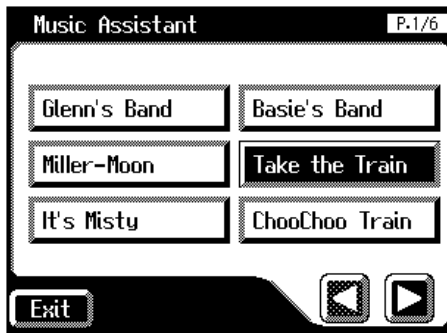

Panel settings appropriate for the keyword will automatically be called up for the Registration [1]–[4] buttons.

4. Touch <Exit> to close the Music Assistant screen.

The Main screen appears.

5. On the Lower keyboard, play a chord.

At the moment you play the keyboard, the Intro will begin, and then the Rhythm and Automatic Accompaniment will play.

6. Press a Registration button from [1] through [4] to switch the panel settings.

7. To end the Music Assistant function, press the [One Touch Program] button, extinguishing its indicator.



To redisplay the Music Assistant screen, touch <Music Assist> on the Main screen again.

Chapter 1 Selecting and Playing Sounds

Listening to the Demo Songs

The AT-90S/80S/60S provides demo songs. Here's how to play the Demo songs, and fully appreciate the sounds, Rhythms, and Automatic Accompaniment that are available with the AT-90S/80S/60S.

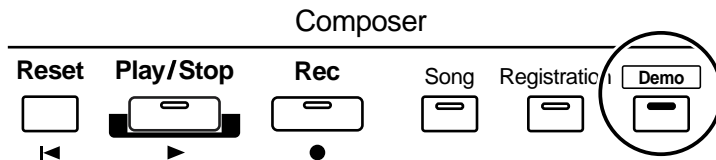

MEMO

For details on the composer of each demo song and their profiles, refer to “Demo Song List” (p. 224).

1. **Make sure that a floppy disk is not inserted in the disk drive.**

If a floppy disk is in the disk drive, press the Eject button and remove the floppy disk.

2. **Press the [Demo] button to make the indicator light.**

The Demo Screen appears.

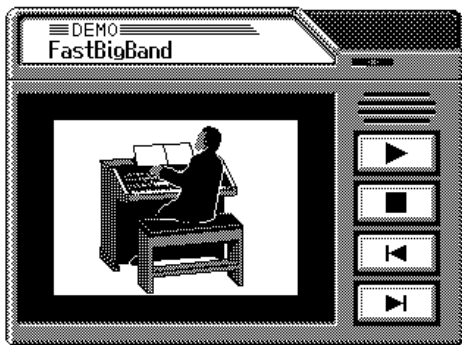

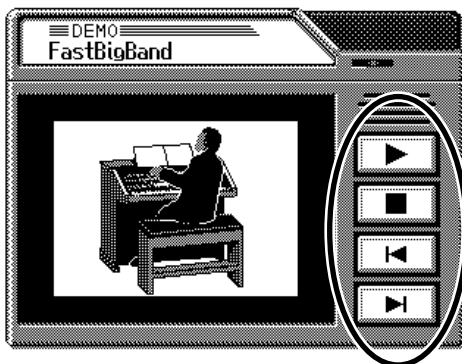

3. **Touch < [Previous] > or < [Next] > on screen to select the demo song.**

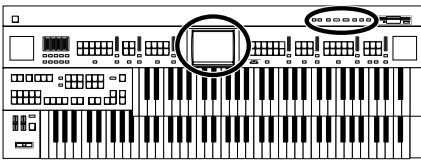

4. **Touch < [Next] > to start playback of the demo song.**

When the selected demo song ends, the next demo song will begin playing.



5. Touch  to stop playback of the demo song.
6. Press the [Demo] button to exit the demonstration screen.

If the following screen appears

If the performance song in the unit has not been saved to floppy disk, the following message appears, and it will not be possible to play the Demo songs.

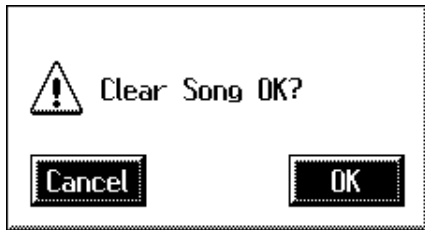

1. If you want to delete the performance data, touch <OK>. If you do not want to delete the performance data, touch <Cancel>.

MEMO

You can also play/stop the demo song by pressing the Composer [Play/Stop] button.

MEMO

The performance data can be saved on a floppy disk. If you wish to save the musical data to a floppy disk, refer to “**Saving Performance Songs Onto Floppy Disk**” (p. 139).

NOTE

All rights reserved. Unauthorized use of this material for purposes other than private, personal enjoyment is a violation of applicable laws.

NOTE

The data for the Demo song that is being played is not available at the MIDI Out connector.

Selecting Voices

You can play the sounds of various instruments on the AT-90S/80S/60S. These sounds are called “Voices.”

■ About the Voices and Parts

The AT-90S/80S/60S has two manual keyboards and a pedalboard. From top to bottom these are called the “Upper Keyboard,” “Lower Keyboard,” and “Pedalboard.”

AT-90S

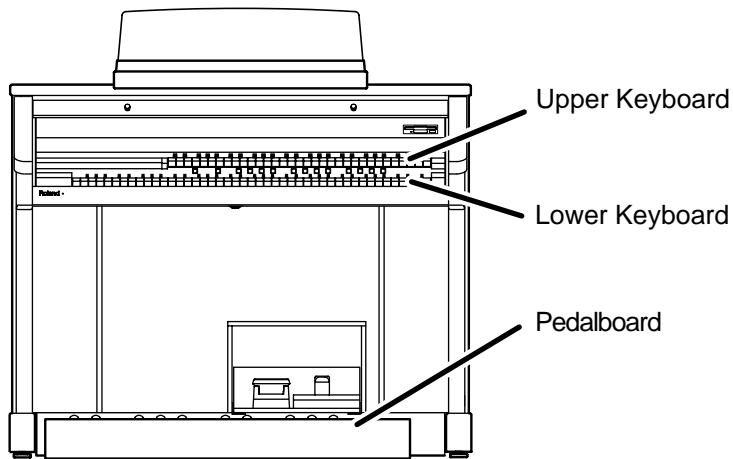

AT-80S/60S

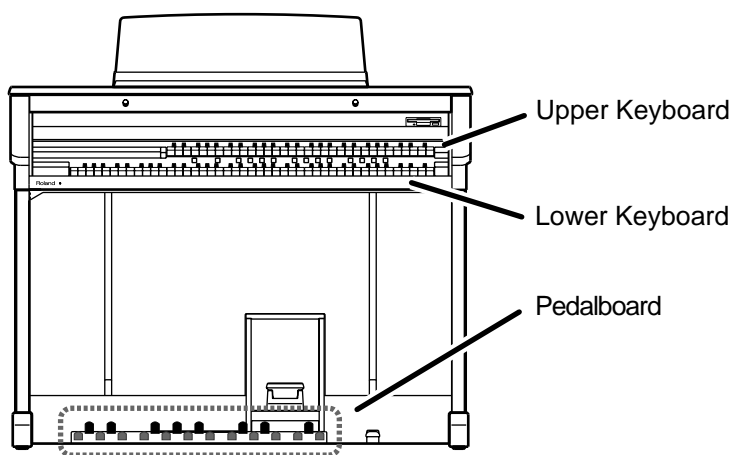

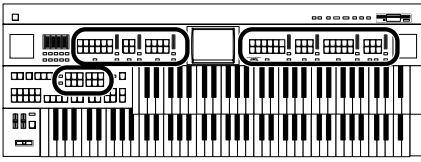

AT-90S

The Upper Keyboard and Lower Keyboard each have four parts: “Organ,” “Symphonic,” “Orchestral,” and “Footage.” You can select one voice for each part, meaning that it is possible to layer up to four voices on each keyboard and play them simultaneously. The voice of the “Solo” part can be layered on the Upper keyboard.

The Pedalboard has two parts: “Pedal Organ” and “Pedal Orchestral.” You can select one voice for each part, meaning that it is possible to play up to two voices simultaneously.

AT-80S/60S

The Upper Keyboard and Lower Keyboard each have three parts: “Organ,” “Symphonic,” and “Orchestral.” You can select one voice for each part, meaning that it is possible to layer up to three voices on each keyboard and play them simultaneously. The voice of the “Solo” part can be layered on the Upper keyboard.

The Pedalboard has two parts: “Pedal Organ” and “Pedal Orchestral.” You can select one voice for each part, meaning that it is possible to play up to two voices simultaneously.

Keyboard	Type of voices	Parts
Upper Keyboard	Upper	Upper Organ
		Upper Symphonic
		Upper Orchestral
		Upper Footage (AT-90S only)
	Solo	Solo
Lower Keyboard	Lower	Lower Organ
		Lower Symphonic
		Lower Orchestral
		Lower Footage (AT-90S only)
	Solo (This voice is sounded only when Solo [To Lower] button lights up)	Solo
Pedalboard	Pedal Bass	Pedal Organ
		Pedal Orchestral



To play a Solo voice on the Lower keyboard, select the Solo voice and press the Solo [To Lower] button (p. 124).

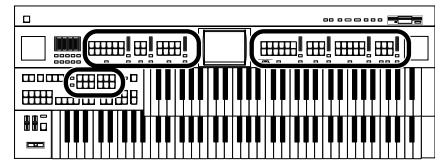

■ Functions of the Upper/Lower/Pedal Bass Sound Select Buttons



Each time you press a voice button, its indicator will switch between being lit and being turned off. Voices that have their button indicator lit can be played.

Two voices of the same family are assigned to each voice button. Buttons with voices from two different families have the names of both voices printed on them.

The [Alternate] button switches between these two voices.

The [Alternate] button	Voice that will be selected
The [Alternate] button is not lit.	The voice indicated on the button is selected.
The [Alternate] button is lit.	Another voice of the same family or the voice indicated on the bottom half of the button is selected.

NOTE

If none of the voice buttons are lit, playing the keyboard will not produce a sound.

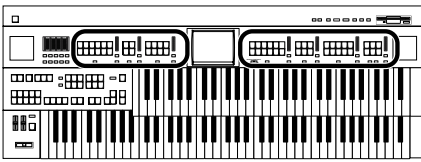

■ Selecting the Upper and Lower Voices

Press the “Organ,” “Symphonic,” or “Orchestral” buttons for each Keyboard (Upper/Lower) to select the desired voice.

When the power is turned on, the Upper keyboard will play “Full Organ1” and the Lower keyboard will play “Lower Organ1.”

Example: Selecting “Full Organ 5” for the Upper Organ, “Strings 5” for the Upper Symphonic, and Upper Orchestral “Grand Piano” for the Upper Orchestral.

1. Press the Upper Organ [Full 2] button (indicator lights).

The name of the selected voice appears in the display for several seconds.

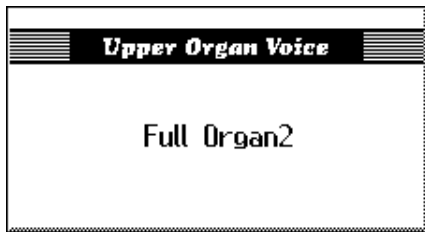

Now when you play the Upper keyboard, the “Full Organ 2” will sound.

2. Press the Upper Organ [Alternate] button (the indicator lights).

When you play the Upper keyboard, the “Full Organ 5” will sound.

Each time you press the [Alternate] button you will switch between the two voices which are assigned the button.

3. Press the Upper Symphonic [Strings] button (the indicator lights).

Now when you play the Upper keyboard, the two voices “Full Organ 5” and “Strings 5” will sound simultaneously (mixed together).

4. Press the Upper Orchestral [Piano] button (the indicator lights).

When you play the Upper keyboard, “Grand Piano” will be added, producing a mixture of three different voices.



The lower voice can be selected in the same way as the upper voice.

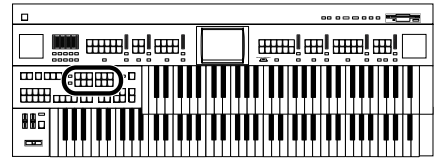

■ Selecting Pedal Bass Voice

Immediately after the power is turned on, the Pedal Bass voice will sound single notes using the “Organ Bass1” voice.

Press the buttons of the various parts of “Pedal Organ” and “Pedal Orchestral” to select voices.

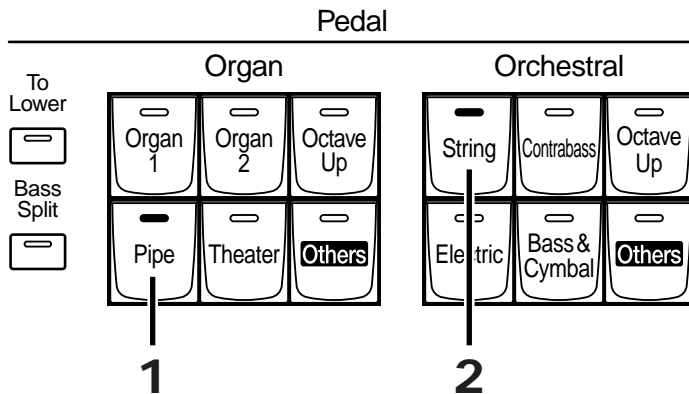

Example: Select “Pipe Org. Bs” for the Pedal Organ part , and select “String Bass” for the Pedal Orchestral part

1. Press the Pedal Organ [Pipe] button (indicator lights).

The name of the selected voice appears in the display for several seconds.

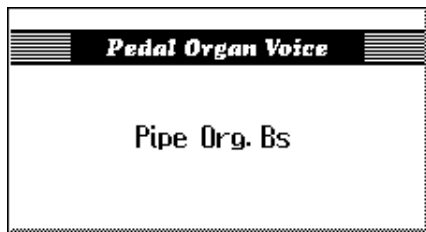

Now when you play the Pedalboard, “Pipe Org. Bs” (Pipe Organ Bass) will be heard.

2. Press the Pedal Orchestral [String] button (indicator lights).

Now when you play the Pedalboard, the two voices Pipe Organ Bass and String Bass will sound simultaneously (mixed together).



Normally, playing the pedalboard will sound one note at a time. Settings can be adjusted to allow multiple notes to be played on the Pedalboard (p. 158).



If you press the Pedal [To Lower] button (indicator lights → p. 126) or [Bass Split] button (indicator lights → p. 125), the Pedal Bass voice can now be played by the Lower keyboard, not by the Pedalboard.



AT-90S/80S have the [Octave Up] button. Play the Pedalboard once more. Notice that when the [Octave Up] button is on, the selected Pedal Bass voice will sound an octave higher.

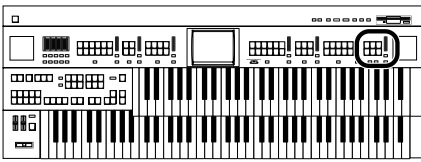

■ Selecting Solo Voice

The Solo section of the Upper keyboard is monophonic, that is, the Solo voice will only sound for the highest note played on the Upper keyboard. This allows you to play full chords and have the selected Solo voice playing the highest (solo) note.

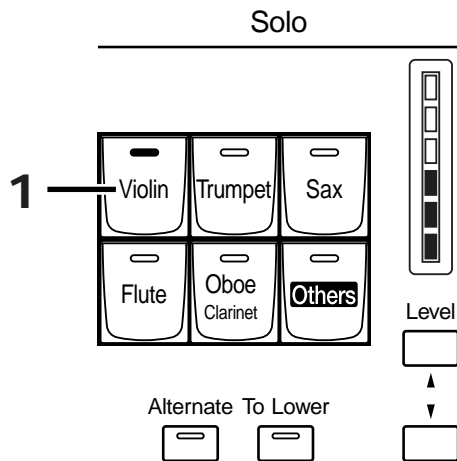

Example: Selecting “Trumpet” for the Solo part

1. Press the Solo [Trumpet] button (indicator lights).

The name of the selected voice appears in the display for several seconds.



Play the Upper keyboard. The selected voice will sound by the highest note played.

When you press the [Alternate] button, the two voices assigned to the button will alternate.

MEMO

By pressing the Solo [To Lower] button, you can play the Solo voice from the Lower keyboard. For details refer to “Playing the Solo Voice on the Lower Keyboard (Solo [To Lower] Button)” (p. 124).

MEMO

It is possible to change how a Solo voice will sound. Normally, the Solo voice will be sounded by the highest note you play on the Upper keyboard, but you can make settings so that the last-played note will sound the Solo voice. For details, refer to “Changing How the Solo Voice Responds” (p. 159).

MEMO

When you play a keyboard range to which a Solo voice is assigned, the Solo voice will normally sound only one note at a time. By changing the way that the Solo voice is sounded, you can play two or more notes at a time. For details refer to “Layering the Solo Voice and Lower Voice” (p. 159).

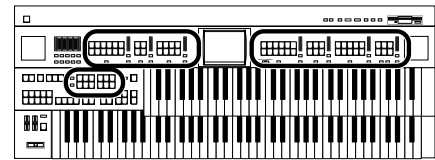

■ Selecting a Voice Using the [Others] Button

Notice that there is an [Others] button for each of the “Organ,” “Symphonic,” “Orchestral” sections of the upper and lower voices, and “Solo” voices, and for the “Organ” and “Orchestral” sections of the Pedal bass voice. By using the [Others] button, you can select all the other voices, the ones that can’t be selected directly by pressing voice buttons.

As with the other voice buttons, the [Others] button can be assigned two voices (one voice for “Pedal Organ” and one for “Pedal Orchestral”). You can use the [Alternate] button to switch between these two voices.

NOTE

You cannot assign the same voice to the two available locations under each [Others] button. Please select and assign two different voices.

MEMO

Step 1 is unnecessary in the case of Pedal Bass Part.

1. Press the [Alternate] button for the Part for which you wish to specify a voice to select ON (lit) or OFF (dark).

The setting of the [Alternate] button: ON (lit) or OFF (dark), determines to which of the two available locations a newly selected voice will be assigned.

2. Press the [Others] button for the Part for which you wish to specify a voice.

The Others Voice screen appears for several seconds.

NOTE

When you press the [Others] button, the Others Voice screen appears in the display screen, but the basic screen will reappear if you wait several seconds without touching the screen.

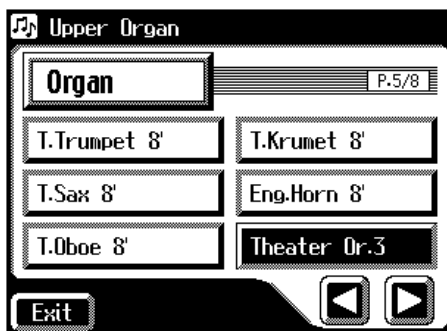

3. Touch a button that shows a sound group.

A sub-window appears, allowing you to select a sound group.

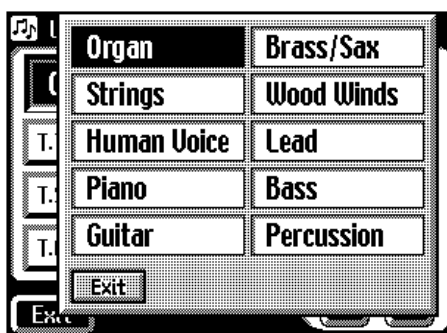

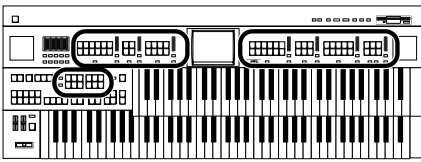

- 4. In the sub-window, touch a sound group name to select the desired sound group.**

The indicator of the selected [Others] button will blink.

The Others Voice screen appears, showing the sounds of the specified sound group.

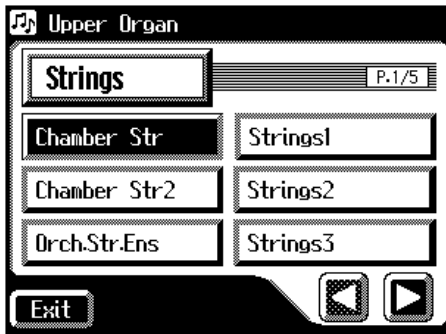

- 5. Touch <◀><▶> to switch screens, and touch a voice name to select a voice.**
- 6. Once again, press the blinking [Others] button to confirm the voice.**

The indicator of the [Others] button will change from blinking to lit.



You can also confirm the voice by touching <Exit> in the Others Voice (Other Voice select) screen. You can also press the key for the part containing a changed voice to confirm the voice setting.



For more information about the voices that can be assigned to an [Others] button, please refer to "Voice List" (p. 193).

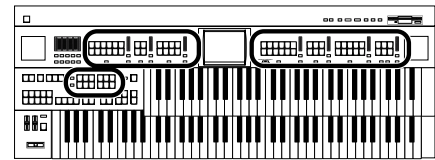

■ Performing with a Human Voice

In addition to sounds such as organ and piano, you can also play “human voice,” which produces a vocal-like sound.

1. Press the [Alternate] button to select ON (lit) or OFF (dark).

The setting of the [Alternate] button: ON (lit) or OFF (dark), determines to which of the two available locations a newly selected voice will be assigned.

2. Press the [Others] button for the Part for which you wish to specify a voice.

The Others Voice screen appears for several seconds.

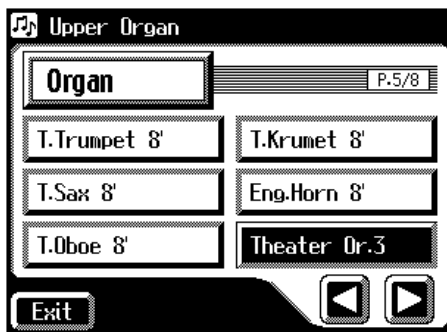

3. Touch a button that shows a sound group.

A sub-window appears, allowing you to select a sound group.

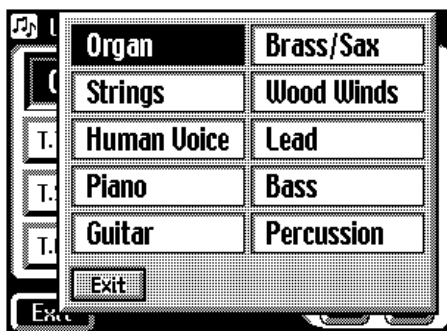

For more information about the voices that can be assigned to an [Others] button, please refer to “Voice List” (p. 193).



Step 1 is unnecessary in the case of Pedal Bass Part.



When you press the [Others] button, the Others Voice screen appears in the display screen, but the Main screen will reappear if you wait several seconds without touching the screen.

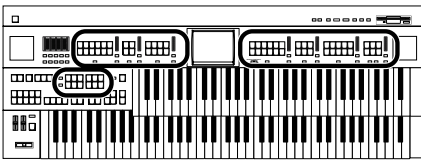

4. In the sub-window, touch <Human Voice>.

The indicator of the selected [Others] button will blink.

The Others Voice screen appears, showing the sounds of the Human Voice group.

The Others Voice screen will appear, and the sounds of the Human Voice group will appear.

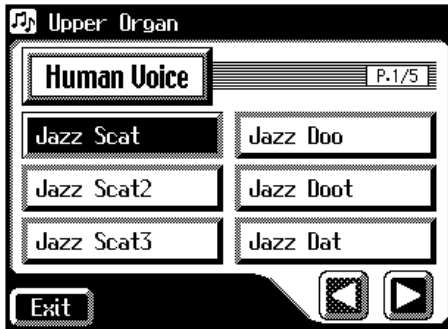

5. Touch <◀><▶> to switch the screen, and touch a voice name to select the desired voice.

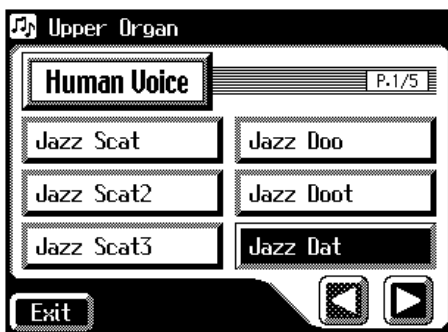

6. Once again, press the [Others] button for the part whose sound you wish to set to confirm the voice.

The indicator of the [Others] button will change from blinking to lit.

MEMO

For some human voices, such as “Jazz Scat,” the sound will change depending on the strength at which you play the keyboard. If the Utility menu setting “Initial Touch” (p. 158) is “OFF,” the sound will not change in response to the dynamics of your keyboard playing.

MEMO

You can also confirm the voice by touching <Exit> in the Others Voice (Other Voice select) screen. You can also press the key for the part containing a changed voice to confirm the voice setting.

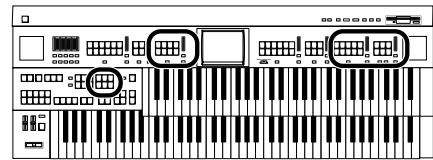

■ Performing with an Active Expression Voice

Some voices are “Active Expression voices,” for which advancing the expression pedal will not only vary the volume, but will also add other voices.

“Active Expression voices” can be assigned to the [Others] buttons of the Upper Orchestral part, Lower Orchestral part, Pedal Orchestral part, and Solo.



For details on the active expression voices that are available, refer to “Voice list” (p. 193).

1. Press the [Others] button of the Upper Orchestral part, Lower Orchestral part, Pedal Orchestral part, or Solo.

The Others Voice screens appears.



2. Touch a button that shows a sound group.

A sub-window appears, allowing you to select a sound group.



3. In the sub-window, touch a sound group name to select the desired sound group.

The indicator of the selected [Others] button will blink.

The Others Voice screen appears, showing the sounds of the specified sound group.



Sounds marked by “” support the Active Expression function.

4. Touch  <  to change screens, and touch a voice name marked by the “” icon.

5. Once again, press the [Others] button for the part whose sound you wish to set to confirm the voice.

The indicator of the [Others] button will change from blinking to lit.

An active expression voice will be selected.



You can also confirm the voice by touching <Exit> in the Others Voice (Other Voice select) screen. You can also press the key for the part containing a changed voice to confirm the voice setting.

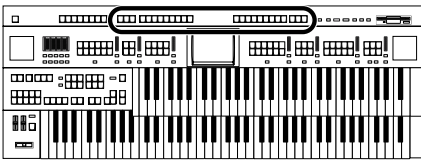

Footage (AT-90S)

The Upper and Lower keyboards provide Footage Tablets that allow you to create a wide variety of organ sounds by combining voices of different pitches. Here's how to use the Footage Tablets to create a voice, so that you can play sounds that are not provided by the three sections discussed earlier. To more easily hear the characteristics of the Footage Tablets, turn off the voices of the three (four) parts "Organ," "Symphonic" and "Orchestral" (& Solo).

The Footage Tablets are organized as follows.

Type of Footage Voice

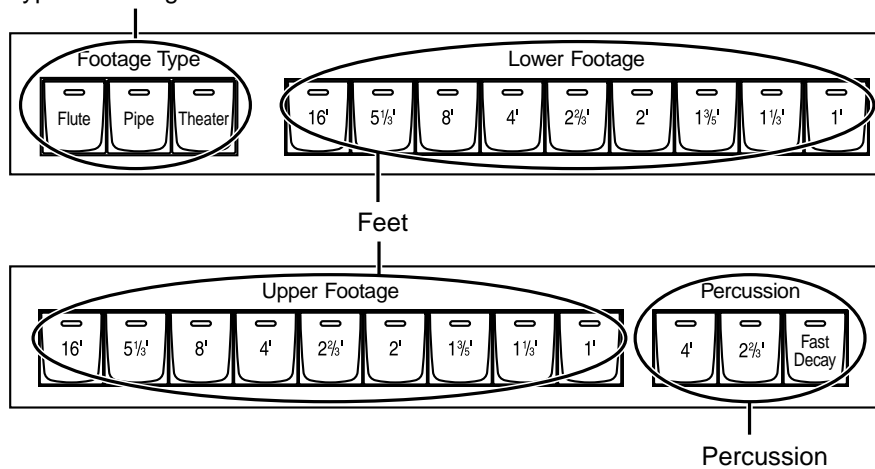

Types of Footage Voice (Footage Type)

Flute: Full Organ

Pipe: Pipe Organ

Theater: Theater Organ

Footage Voices of Differing Pitch (Upper Footage, Lower Footage)

As the number decreases, the pitch will become correspondingly higher (see next page).

Percussion Voice (Voices which Add Crispness)

These add a crisp sound with an attack to the Footage voices of the Upper part.

Button	Explanation
Percussion [4'] button	Percussion one octave above
Percussion [2 2/3'] button	Percussion one octave and a fifth above
[Fast Decay] button	Shortens the decay time of the percussion (short percussion)



Percussion is often used with Flute. It can also be used with Pipe or Theater, but if you have selected percussion for Flute, switching to Pipe or Theater will cause percussion to be cancelled automatically.

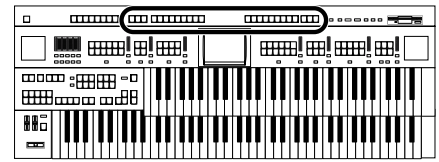

1. Press the Footage Type button (indicator lights).

Each time you press the button, the indicator will alternate between ON (lit) and OFF.

There are a total of three types of Footage voices.

2. Press the Upper Footage button (indicator lights).

Each time you press the button, the indicator will alternate between ON (lit) and OFF.

Try combining various pitches and play the Upper keyboard.

Various pitches can be combined for the Lower keyboard in the same way as for the Upper keyboard.

Footage tablets and pitch correspond as follows.

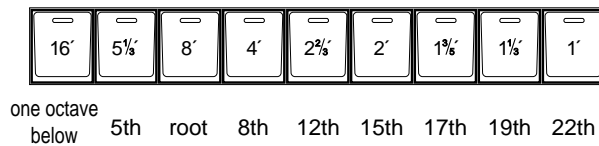

3. Press the Percussion [4'] button or [2 2/3'] button (indicator lit).

Play the Upper keyboard and notice that an attack has been added.

4. Press the [Fast Decay] button (indicator lit).

The percussive sound will decay more quickly.

NOTE

Percussion [4'] and [2 2/3'] buttons cannot be used simultaneously.

NOTE

The Percussion effect is only available when a voice is selected in the Upper Organ Type section.

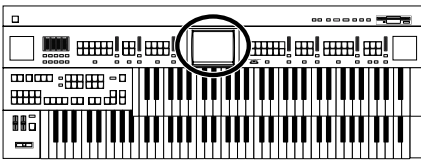

If you press the Footage Type button, Lower Footage button, or Upper Footage button to turn it on (button's indicator lit), a footage screen like the following appears.

Footage Screen

When the Footage Type is “Flute”

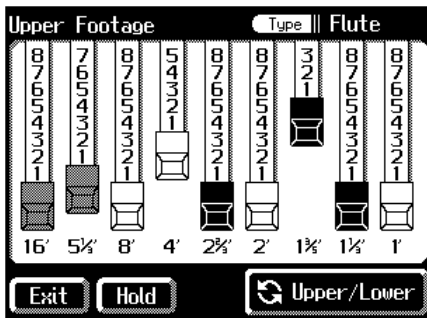

The sliders displayed in the screen are called “harmonic bars.”

By touching the harmonic bars and sliding them, you can adjust the volume of each footage.

The volume can be adjusted over nine steps (0–8).

When a harmonic bar is pulled out all the way (8), the volume is loudest.

When it is pushed in all the way (0), there will be no sound.

When the Footage Type is “Pipe” or “Theater”

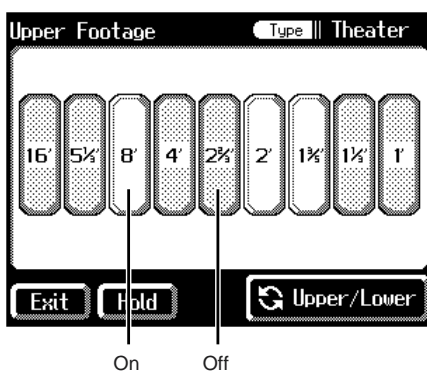

The buttons displayed in the screen are called “tablets.”

You can press each tablet to turn it on/off.



The Footage screen will be displayed for several seconds, then it will close automatically.

When you touch the Footage screen and then change the settings, the screen is held in that condition.



You can touch

<  > to switch between the Upper Footage screen and Lower Footage screen.

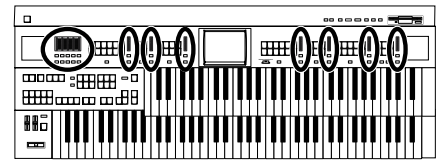

Adjust the Volume Balance

The AT-90S/80S/60S allows you to adjust the volume balance individually for each Part.

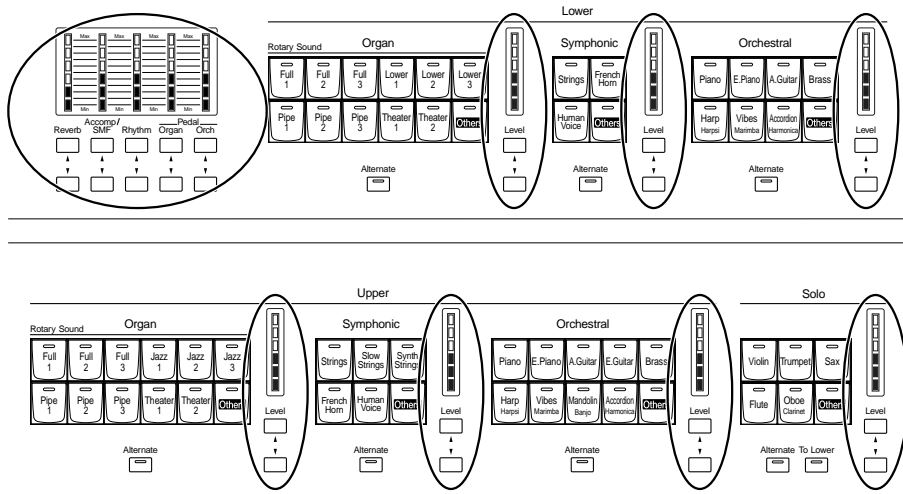

The following buttons are used to adjust the volume of a multiple number of Parts.

Button	Part
Accomp/SMF button	Automatic Accompaniment (except Bass)
	Playback of performance songs from something other than the Atelier performance songs (for example: SMF music files)
Rhythm button (When [Manual Perc] is ON)	Manual percussion
Rhythm button (When [Manual Perc] is OFF)	Rhythm performance
	Drums/SFX
Pedal Organ button	Pedal Organ voice
	Bass note of automatic accompaniment

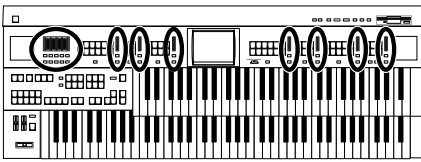

1. The volume levels of each part are adjusted using the corresponding [▲] and [▼] buttons.

Pressing the upper button ([▲] button) will increase the volume.

Pressing the lower button ([▼] button) will decrease the volume.

The volume can be set to any value from 0 to 12.

When the volume value shown in the display is 0, that part will produce no sound.

You can also press the [▲] button and [▼] button of the part whose volume you wish to adjust, so that the “Part Balance Monitor screen” is displayed for several seconds, allowing you to check the volume balance.

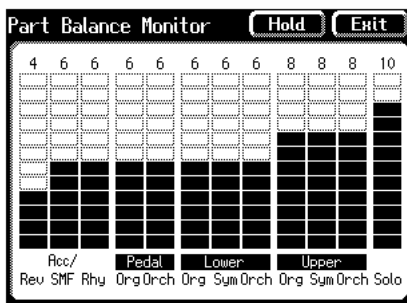

The Part Balance Monitor screen is displayed for several seconds and then closes automatically. If you touch <Hold>, the screen continues to be displayed until you touch <Hold> again.

You can check the volume by viewing the Level Balance indicators of each part on AT-90S/80S.

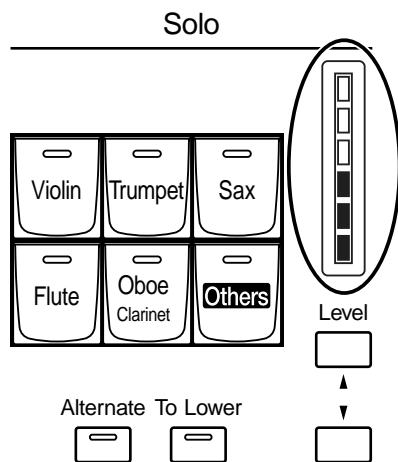

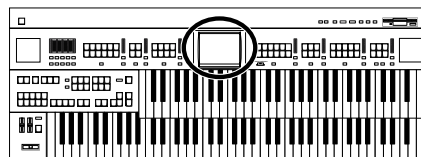

Transpose the Pitch in Octave Units (Octave Shift)

The pitch of the sound played by the keyboard can be adjusted in one-octave steps. This function is called “Octave Shift.” You can apply an Octave shift to the following nine Parts:

All of the Upper and Lower Parts (Organ/Symphonic/Orchestral)

Both the Pedal Parts (Organ/Orchestral)

The Solo Part

1. Touch <Sound/Kbd> on the Main screen.

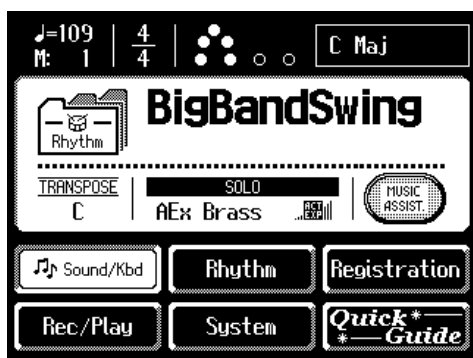

The sub-window appears.



2. In the sub-window, touch either <Upper Kbd>, <Lower Kbd>, or <Pedalboard>.

Menu	Part whose pitch will change
Upper Kbd	To change the pitch of the Upper and Solo part
Lower Kbd	To change the pitch of the Lower part
Pedalboard	To change the pitch of the Pedal part

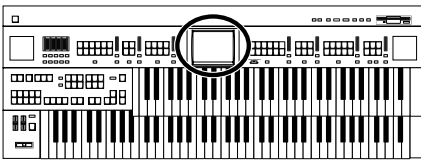

3. Touch the part display of the part whose Octave Shift settings you wish to change.

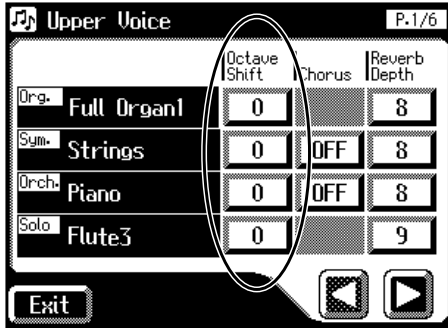

4. Touch <[-]> <[+]> to adjust the settings.
The value can be set to a range of +/- 3 octaves.

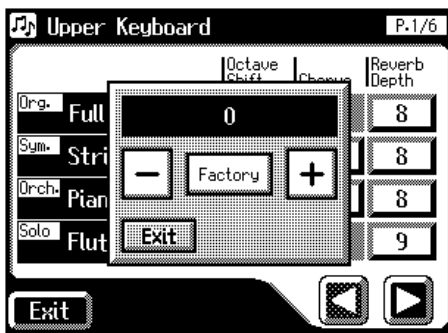

5. Touch <Exit>.
You will return to the Upper Kbd (Upper keyboard)/Lower Kbd (Lower keyboard)/Pedalboard screen.

MEMO

When the power is turned on, the Octave Shift setting for each part of the Pedal Bass will be set to -1 (1 octave down). If you turn on the [Octave Up] button, the Octave Shift will be automatically set to "0" regardless of the previous setting. When you turn off the [Octave Up] button, the Octave Shift will always return to "-1" regardless of the previous setting.

NOTE

Please note that when you apply the Octave Shift function to certain voices, their pitch could be stretched beyond their recommended note ranges, and they may not sound as expected. Care should be taken when using Octave Shift.

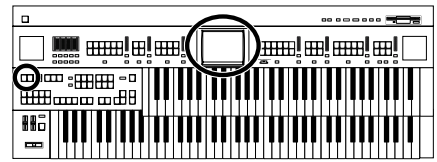

Playing Drum Sounds or Sound Effects from the Entire Lower Keyboard (Drums/SFX)

You can use the Lower keyboard to play various drum sounds (drum set). In this case, the Lower voices will no longer sound.

AT-90S/80S

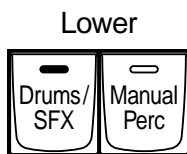

AT-60S

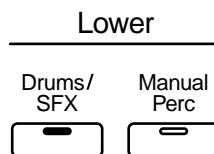

1. Press the [Drums/SFX] button, getting its indicator to light up.

The [Drums/SFX] button indicator will alternate between on (lit) and off each time it is pressed.

The Drums/SFX (drums/sound effects) screen will be displayed for several seconds.



2. Play the Lower keyboard and listen to the various drum sounds on each key.

MEMO

Refer to “Drum Set List” (p. 198) for details on which drum sound or Sound Effect will be played by each note.

NOTE

It is not possible to select and play both [Drums/SFX] and [Manual Perc] buttons simultaneously.

NOTE

For some drum sets, there will be keys that do not sound.

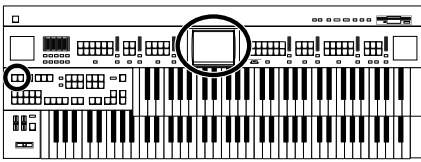

■ Changing Drums/SFX Sets

Immediately after the power is turned on, the POP drum set will sound.

As the drum set, you can choose from 16 types of drum set and one type of sound effect. When you change the drum set, the sound produced by each note will change.

1. Press the [Drums/SFX] button, getting its indicator to light up.

The Drums/SFX screen will be displayed for several seconds.

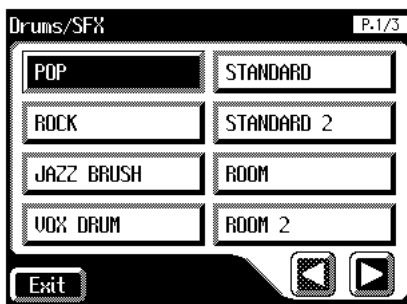

2. While the Drums/SFX screen is displayed, touch a Drum/SFX set name in the screen.

The [Drums/SFX] button indicator will begin to blink.

You can select from 16 different Drum Sets and one set of Sound Effects as follows:

POP, ROCK, JAZZ BRUSH, VOX DRUM, STANDARD, STANDARD2, ROOM, ROOM2, POWER, ELECTRONIC, TR-808, DANCE, JAZZ, BRUSH, BRUSH2, ORCHESTRA, SOUND EFFECTS

3. Press the [Drums/SFX] button once again.

The [Drums/SFX] button indicator will be lit constantly, and the selected Drum Set Type will be applied.



For the types of manual drum set and the drum sounds played by each key, refer to “Drum/sound effect set list” (p. 198).



After the Drums/SFX (drums/sound effects) screen is displayed, it will close automatically after several seconds unless you touch the screen to select a drums/sound effects set. If you wish to switch drums/sound effect sets, quickly select the desired drums/sound effect set while the Drums/SFX (drums/sound effects) screen is displayed.



You can also confirm the Drums/SFX set by touching <Exit> in the Drums/SFX screen. You can also play the lower manual to confirm the drum set.

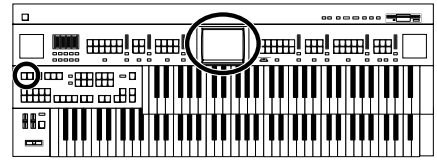

Simultaneously Playing a Lower Voice with Percussion Instrument Sounds and a Voice Phrase (Manual Percussion)

You can play various drum sounds and Sound Effects using the bottom 15 keys of the Lower keyboard. This is convenient when you wish to play the Lower voice together with drum sounds or Sound Effects.

○AT-90S/80S

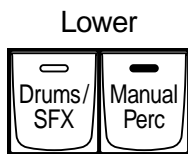

○AT-60S

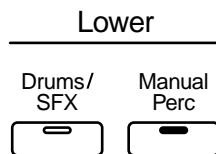

the keys for Drum sounds
or Sound Effects

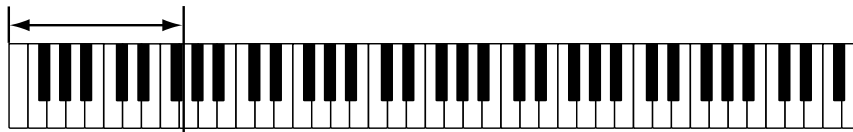

Lower Keyboard

1. Press the [Manual Perc] button (indicator lights).

The button will alternate between ON (lit) and OFF each time it is pressed. The Manual Percussion screen will be displayed for several seconds.

AT-90S/80S



AT-60S



2. When you play the bottom 15 keys of the Lower keyboard the chosen drum sound is played on each key.

NOTE

It is not possible to select and play both [Drums/SFX] and [Manual Perc] buttons simultaneously. (p. 52).

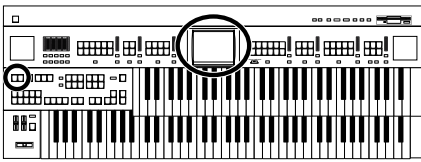

■ Changing the Manual Percussion Sets

Immediately after the power is turned on, the PERC SET1 drum set will sound.

You can choose the type of Manual Percussion Set. When you change the Manual Percussion Set, the sound played by each of the 15 lowest notes of the Lower keyboard will change.

1. Press the [Manual Perc] button (indicator lights).

The Manual Percussion screen will be displayed for several seconds.

AT-90S/80S



AT-60S



2. While the Manual Percussion screen is displayed, touch a manual percussion set name in the screen.

The [Manual Perc] button indicator will begin to flash.

AT-90S/80S

You can select from 11 different Manual Percussion Sets;

PERC SET1, PERC SET2, PERC SET3, ORCHESTRA SET, LATIN SET, VOICE PHRASE, VOICE PHRASE 2, VOICE PHRASE 3, SFX SET, JAPANESE SET, JAPANESE SET 2

AT-90S/80S

You can select from 5 different Manual Percussion Sets;

PERC SET1, PERC SET2, LATIN SET, VOICE PHRASE, VOICE PHRASE2

3. Press the [Manual Perc] button once again.

The [Manual Perc] button indicator will be lit constantly, and the selected Manual Percussion Set will be applied.



Refer to “Drum Set List” (p. 198) for details on which percussion sound will be played by each note.



The Manual Percussion screen will automatically close after several seconds if you do not touch the screen to select a manual percussion set. If you wish to change the manual percussion set, you must select a manual percussion set quickly while the manual percussion screen is displayed.



You can also confirm the Manual Percussion set by touching <Exit> in the Manual Percussion screen. You can also play the lower manual to confirm the manual percussion set.

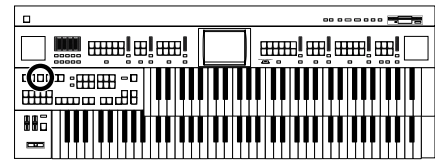

Sustaining Notes Played on the Lower Keyboard (Lower Hold)

When the Lower Voice [Hold] button is ON (Lower Voice [Hold] button's indicator is lit), the note(s) played on the Lower keyboard will continue to sound until you play the next note(s)—even if you release the keys you have played.

AT-90S/80S

Lower
Voice



AT-60S

Lower
Voice

Hold



- 1. Press the Lower Voice [Hold] button (confirm that the indicator is lit).**

The notes played on the lower keyboard will continue sounding.

While the Lower Voice [Hold] button is lit, pressing a key will cause the note to continue sounding.

- 2. When you press the Lower Voice [Hold] button to make the indicator go dark, the notes which had continued to sound will stop.**

Chapter 2 Using Rhythm Performance

The AT-90S/80S/60S lets you enjoy playing along with a rhythmic accompaniment.

Selecting a Rhythm

The AT-90S/80S/60S provides various Rhythms and Automatic Accompaniments (Music Styles). These are organized into 10 groups.

○ AT-90S/80S



Rhythm

○ AT-60S

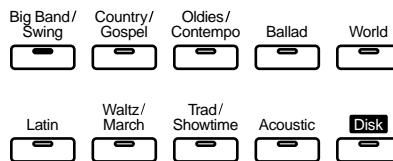

Rhythm

1. Press a Rhythm button to select a Rhythm group.

The indicator will light.

A Rhythm screen like the following appears.



The rhythms in the selected rhythm group appears in the display.

2. Touch <◀><▶> to switch screens, and touch a rhythm name to select the desired rhythm.

The indicator of Rhythm button will blink.

3. Press the Rhythm button once again (indicator lights constantly).

The Rhythm button's indicator will change from blinking to light. The Rhythm has now been applied.

Using the Rhythms of the [Disk] Button

The [Disk] button contains preset Rhythms. These Rhythms can be rewritten by loading disk Rhythms into the AT-90S/80S/60S. Rhythms that are already written in the [Disk] button memory can be selected in the same way as when selecting Rhythms of another Rhythm group.



You can also open the Rhythm screen by touching <Rhythm> in the Main screen.



You can also confirm the rhythm by touching <Exit> in the Rhythm screen.



If you wish to store a disk Rhythm in the [Disk] button, refer to “Loading Disk Rhythms Into Internal Memory” (p. 70).

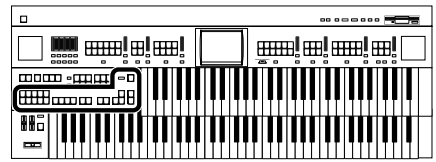

Playing Rhythm

There are two ways to start the Rhythm:

- Manually by pressing the [Start] button,
- Automatically by playing a note on the Lower keyboard or Pedalboard (Sync Start).

You can press (Sync Start) or the [Intro/Ending] button to start the rhythm from the intro, or stop the rhythm at the ending.

○AT-90S/80S

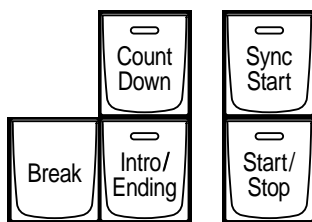

○AT-60S

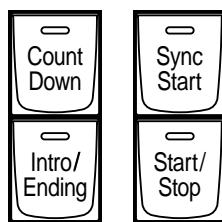

■ Starting at the Press of a Button

Starting with an Added Intro

1. Press the [Intro/Ending] button.

The Intro is played and the Rhythm starts.

While the Intro is playing, the [Intro/Ending] button indicator will light, until the Intro ends then the button indicator will go dark.

Making the Intro Short and Simple

1. Press the [To Variation] or [To Original] button.
2. Press the [Start/Stop] button.

A short Intro is played and the Rhythm starts.

Starting Without an Intro

1. Press the [Start/Stop] button.

The Rhythm starts without an Intro being played.

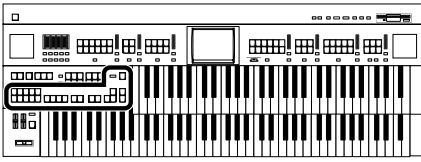

■ Starting the Rhythm Automatically When You Play the Lower Keyboard or Pedalboard (Sync Start)

Starting with an Added Intro

1. Press the [Sync Start] button to make the indicator light up.

2. Press the [Intro/Ending] button.

The [Intro/Ending] button's indicator will blink.

3. Play either the Lower keyboard or the Pedalboard.

The Intro is played and the Rhythm starts.

While the Intro is playing, the [Intro/Ending] button indicator will light, until the Intro ends then the button indicator will go dark.

Making the Intro Short and Simple

1. Press the [Sync Start] button to make the indicator light up.

2. Press the [To Variation] or [To Original] button.

[Start/Stop] button indicator will blink.

Pressing the [To Variation] or [To Original] button makes the Rhythm pattern change as well.

3. Play either the Lower keyboard or the Pedalboard.

A short Intro is played and the Rhythm starts.

Starting Without an Intro

1. Press the [Sync Start] button to make the indicator light up.

2. Play either the Lower keyboard or the pedalboard.

The Rhythm starts without an Intro being played.

NOTE

If the Arranger function is ON (the Arranger [On/Off] button indicator is lit), it is not be able to start the Rhythm by playing the Pedalboard (p. 61).

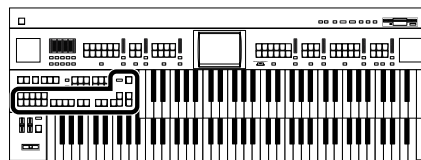

■ Stopping the Rhythm

Stopping with an Ending

1. Press the [Intro/Ending] button.

An Ending is played, then the Rhythm stops.

While the Ending is playing, the [Intro/Ending] button indicator will light, until the Ending finishes the button indicator will be turned off.

Making the Ending Short and Simple

1. Press the [To Variation] or [To Original] button, and then press the [Start/Stop] button.

A short Ending is played, then the Rhythm stops.

Stopping without an Ending

1. Press the [Start/Stop] button.

The Rhythm stops without an Ending being played.

Changing a Rhythm's Tempo

You can change the tempo of the Rhythm or Automatic Accompaniment (p. 61).

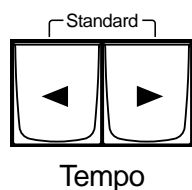

1. Press the Tempo [◀] and [▶] buttons to change the tempo (speed) of the Rhythm or Automatic Accompaniment.

Tempo [◀] button	The tempo becomes slower
Tempo [▶] button	The tempo becomes faster

By pressing the Tempo [◀] and [▶] buttons simultaneously, the tempo is returned to the standard (preset) tempo for the selected Rhythm.

The value of the tempo currently set (20–250 beats per minute) can be checked in the Main screen.



The tempo and time signature are also indicated by the “bouncing ball” in the Main screen (p. 24).

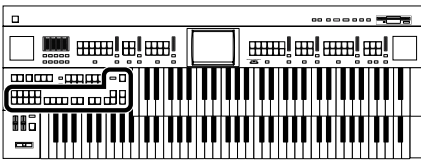

Playing the Count Sound at the End of the Intro

If an intro is played before your performance, you can have a countdown played to the end of the intro, allowing you to understand easily where you are to start playing.

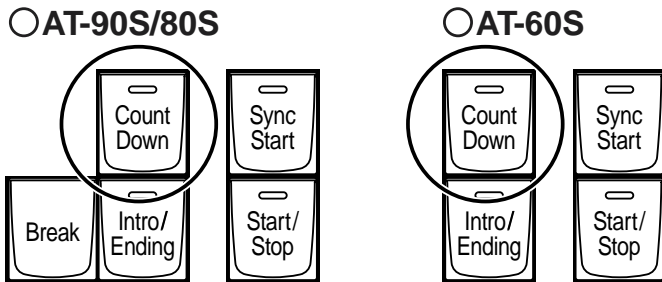

1. Press the [Count Down] button, getting the indicator to light.
2. Press the [Intro/Ending] button.
The intro plays, and a countdown plays to the end of the intro.
When the [Sync Start] button is lit, specifying the chord on the Lower keyboard starts the intro, and again, a countdown is given.
3. To stop the countdown, press the [Count Down] button, turning off the indicator light.

Playing Rhythm and Automatic Accompaniment

The Arranger function of the AT-90S/80S/60S can add an Automatic Accompaniment to each Rhythm. Based on the selected Rhythm, the Arranger function automatically adds an accompaniment that is suitable for the chord being pressed on the Lower keyboard.



1. Press the Arranger [On/Off] button (indicator lights.)

Indicator is lit (On)	Rhythm and Automatic Accompaniment
Indicator is not lit (Off)	Rhythm (Drums only)

2. Start the rhythm (p. 58).

The rhythm and the automatic accompaniment will play together.
If the Arranger [On/Off] button is ON and no Pedal Bass voice is selected, the Automatic Accompaniment will play the bass sound.

MEMO

You can change the countdown sound (p. 166).

NOTE

When the Arranger [On/Off] button is on, Sync Start (p. 59) on the pedalboard cannot be used.

NOTE

During the intro or ending, playing the lower keyboard will not produce sound.

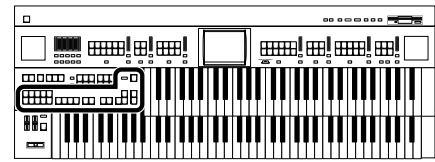

Adding Variety to the Rhythm or Automatic Accompaniment

You can add variety to the rhythm or automatic accompaniment by changing the rhythm pattern of the rhythm or the arrangement of the automatic accompaniment, or by inserting a break (i.e., stopping the rhythm for one measure).

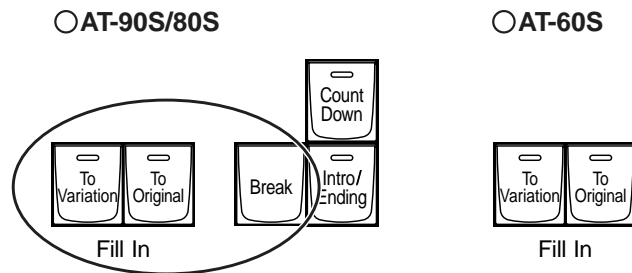

Button name	Function
Fill In [To Variation] button	After the Fill-In has played, play the Variation Rhythm pattern.
Fill In [To Original] button	After the Fill-In has played, play the Original Rhythm pattern.
[Break] button <AT-90S/80S only>	Stop the rhythm at the end of that measure (Break).

What's a fill-in?

A Fill In is a short phrase that is inserted at a break in the melody or at a point where the character of the song changes (between Chorus's or Verses).

Changing the Arrangement of the Accompaniment (Style Orchestrator)

You can change the arrangement of the accompaniment while the rhythm is playing or stopped. This function is called "Style Orchestrator." For each rhythm, there are four types of arrangement for the accompaniment. The following buttons are called Style Orchestrator buttons.

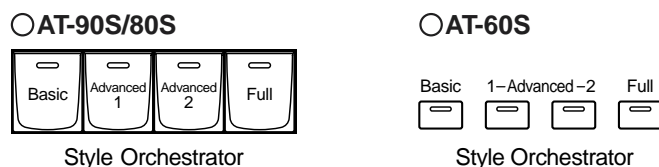

1. Press the Style Orchestrator buttons to change the arrangement of the accompaniment.

The indicator of the button you pressed will light. The [Basic] button produces the simplest arrangement, and the [Full] button produces the most florid.

NOTE

AT-60S has no [Break] button.

MEMO

The functions of the [Start/Stop] button, the [To Variation] button, the [To Original] button, and [Break] button can be assigned to the foot switches located on each side of the Expression Pedal. Please refer to "Changing the Function of the Foot Switch" (p. 160).

NOTE

Some Rhythms don't change the arrangement of the accompaniment.

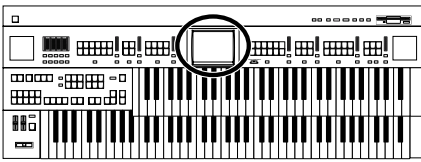

Playing Chords with Simple Fingering

“Chord Intelligence” is a feature that intelligently plays the correct accompaniment chords the moment you play a key specifying a chord on the Lower keyboard during Automatic Accompaniment.

For example, in order to make the instrument detect a “C Major” chord, you must normally play the three keys “C,” “E,” and “G.” If you use the Chord Intelligence function, you can simply press a single “C” key in the lower keyboard to sound a C Major chord with the voice selected for the Lower part



For more information about chord fingering, refer to the “Chord List” (p. 210).



You can also open the rhythm screen by pressing a Rhythm button.



If you press the root note of the chord (p. 212) in the lower keyboard when the Chord Intelligence function is off, all notes in that chord will sound.

For example, if you press the root “C” of the C major chord in the lower keyboard, the notes of the C major chord “C,” “E,” and “G” will be sounded by the voice selected for the lower part.

1. Touch <Rhythm> on the Main screen.

The Rhythm screen appears.



2. Touch <Utility> on the Rhythm screen.

The Utility screen appears.

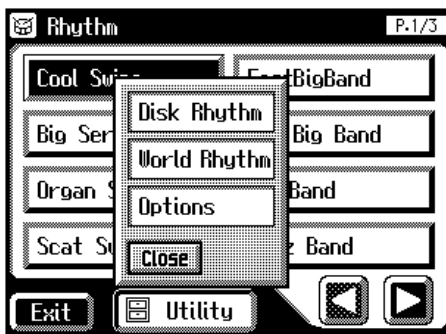

3. Touch <Options>.

The Rhythm Options screen appears.



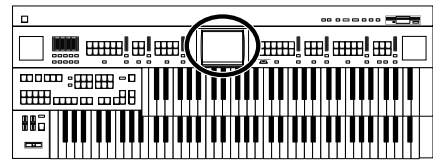

4. Touch the Chord Intelligence setting to turn it “ON.”

The Chord Intelligence function can now be used.

Each time you touch the Chord Intelligence setting, it will be switched ON/OFF.

5. If you wish to turn off the Chord Intelligence function, switch it “OFF.”



When you touch the [One Touch Program] button, the Chord Intelligence setting will automatically be turned ON.

Leading Bass Function

When Automatic Accompaniment is used, and the Pedal [To Lower] button is ON, the Pedal Bass voice will normally play the root note (p. 212) of the chord you play on the Lower keyboard.

If the Leading Bass function is enabled, the lowest note of the chord you play on the Lower keyboard will then be used as the bass note (the bottom note of the chord). This allows the bass to be a note other than the root of the chord you play and the bass note will change when inverted chords are played (p. 212).

1. Touch <Rhythm> on the Main screen.

The Rhythm screen appears.



You can also open the Rhythm screen by pressing the Rhythm buttons.

2. Touch <Utility> on the Rhythm screen.

The Utility screen appears.



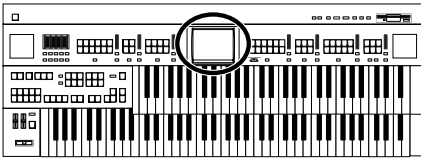

3. Touch <Options>.

The Rhythm Options screen appears.

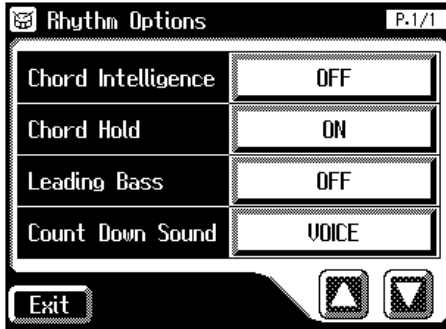

4. Touch the Leading Bass setting to turn it “ON.”

Each time you touch the Leading Bass setting, it will be switched ON/OFF. The lowest note of the chord you play on the Lower keyboard will be used as the Bass note.

5. To turn off the Leading Bass function, set the Leading Bass setting to “OFF.”

MEMO

You can assign the Leading Bass functions to either of the foot switches located on each side of the Expression Pedal. Please refer to “Changing the Function of the Foot Switch” (p. 160).

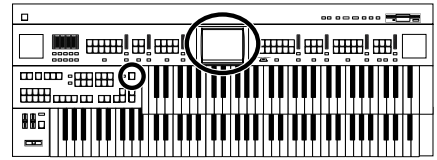

A Simple Way to Make Automatic Accompaniment Settings (One Touch Program)

The AT-90S/80S/60S provides a very convenient [One Touch Program] button. By simply pressing this button once, the Arranger function will be turned ON, and keyboard voices that are most appropriate for playing with the currently selected Rhythm/Automatic Accompaniment are selected.

By pressing the [One Touch Program] button, you can make the following settings.

- Panel settings (e.g., sounds and volume) suitable for the rhythm
- Arranger [On/Off] button lit (Automatic Accompaniment playing)
- [Sync Start] button lit, [Intro/Ending] button blinking (Waiting for Sync Start)
- Chord Intelligence function is ON

What is Sync Start?

Sync Start is a function that starts the rhythm at the moment that you play the lower keyboard.

What is Chord Intelligence?

“Chord Intelligence” is a feature that intelligently decides on accompaniment chords the moment you play some keys specifying a chord during automatic accompaniment.

The panel settings specified by the One Touch Program function are as follows.

16 panel settings for each rhythm (4 panel settings x 4 groups)

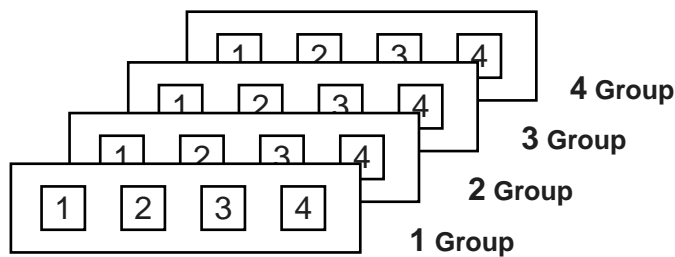

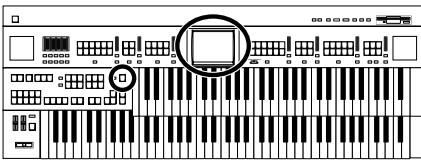

One Touch Program



- 1. Select a Rhythm (p. 58).**
- 2. Press the [One Touch Program] button.**

The [One Touch Program] button's indicator will light.

An OTP Group (One Touch Program Group select) screen like the one shown below will be displayed for several seconds.



- 3. While the OTP Group screen is displayed, touch the screen to select a One Touch Program group.**

If you fail to select a One Touch Program group while the OTP Group screen is displayed, "Group 1" will be selected automatically.

Panel settings appropriate for the rhythm and automatic accompaniment will automatically be called up for Registration [1]-[4] buttons.

- 4. Press the Registration [1] - [4] button to select panel settings.**
- 5. On the Lower keyboard, play a chord.**

At the moment you play the keyboard, the Intro will begin, and then the Rhythm and Automatic Accompaniment will play.

- 6. Press the [One Touch Program] button, extinguishing its indicator.**

You will return to the panel settings that were in effect prior to pressing the [One Touch Program].



To redisplay the OTP Group screen, while holding down the Registration [Write] button, press the [One Touch Program] button.



When you press the [One Touch Program] button, the "Arranger Update" setting will automatically change to "INSTANT."

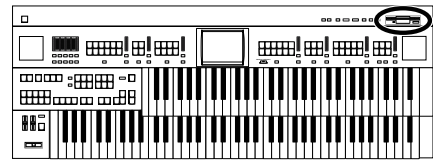

Using a Rhythm from a Disk

The AT-90S/80S/60S contains built-in Rhythms (Music Styles). Additional Rhythms (Music Styles) are available on the Music Style disk included are available. Here's how to select a Rhythm (Music Style) from a Music Style disk.

■ Inserting and Ejecting a Floppy Disk

- 1. Hold the floppy disk face up, and push it into the disk drive until it clicks into place.**

The disk drive is on the right side of the unit, above the keyboard.

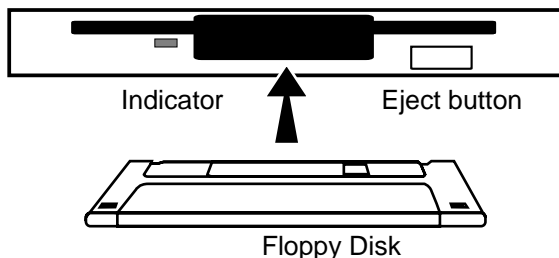

- 2. Press the Eject button.**

The end of the floppy disk comes out of the slot. Gently grasp the end of the floppy disk and pull it out.

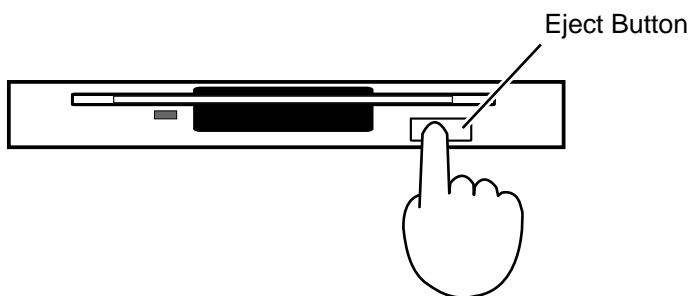

NOTE

If you're using the disk drive for the first time, be sure to read the important notes on p. 6.

NOTE

Never eject a disk while reading or writing is in progress, since that can damage the magnetic surface of the disk, rendering it unusable. (The disk drive's indicator will light up at full brightness when the drive is busy reading or writing data. Ordinarily, the indicator will be less brightly lit, or be extinguished.)

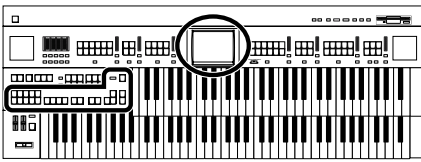

■ Reviewing the Styles on a Music Style Disk

1. Press the Rhythm [Disk] button (confirm that its indicator is lit).

The Rhythm screen appears.

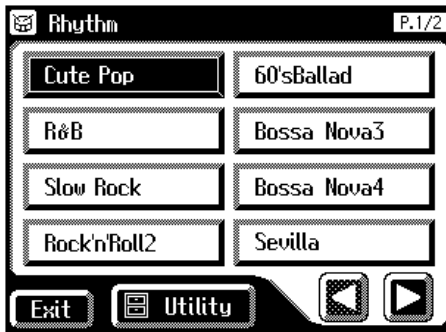

2. Insert the Music Style disk into the disk drive.

The Rhythm screen will show the Rhythms on the music style disk.

Rhythms from the music style disk are indicated by an “” icon.



3. Touch the Rhythm screen to select a Rhythm on the Music Style disk.

The [Start/Stop] button indicator will blink while the Rhythms are being loaded into internal memory.

When loading is finished, you will be able to play the selected rhythm.

4. Press the [Start/Stop] button or the [Intro/Ending] button.

The selected Rhythm is played.

MEMO

If rhythms from a music style disk are stored in internal memory, you can recall the Rhythms simply by pressing the [Disk] button (p. 70).

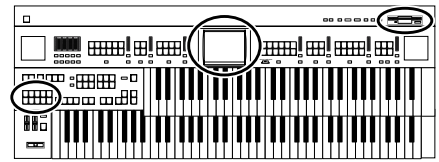

■ Loading Disk Rhythms Into Internal Memory

The [Disk] button already contains various Rhythms, but these can be rewritten by Rhythms from a Music Style disk. Rhythms loaded from the disk into internal memory will not be lost even if the power is turned off. It is convenient to load frequently-used disk Rhythms into internal memory.

1. **Insert the Music Style disk into the disk drive.**
2. **Touch <Rhythm> on the Main screen.**

The Rhythm screen appears.

The rhythm screen will show the rhythms of the music style disk.

Rhythms from a music style disk are indicated by a “” icon.



3. **Touch <Utility> on the Rhythm screen.**

The Utility screen appears.



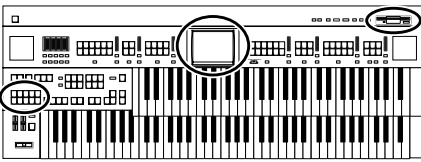

4. Touch <Disk Rhythm>.

The Loading Disk Rhythm screen appears.



5. Touch <▲><▼> to switch screens, and select the Music Style Disk rhythm that you wish to store in internal memory.
Rhythm [Disk] button indicator will blink.

6. After selecting the Music Style Disk Rhythm, touch <Next>.

The following screen appears.



Touch <Back> to go back to the previous screen.

7. Touch the screen to switch screens, and touch the save-destination rhythm.

The following screen appears.



To cancel operation, touch <Cancel>.

MEMO

At this time, you can press <▶▶> or the [Start/Stop] button to play the rhythm to make sure of your choice.

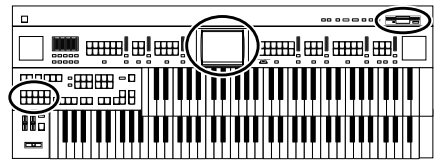

8. To store the Rhythm in internal memory, touch <OK>.

The saving of the rhythm to internal memory begins.

Once the Rhythm has been accommodated in memory, the Rhythm screen will reappear.

NOTE

Never remove the disk or turn off the power while the Rhythm data is being loaded from disk into the AT-90S/80S/60S. If you do so, the Rhythm data will not be loaded into the AT-90S/80S/60S, and malfunctions could result. After returning the Rhythm stored in the [Disk] button to the factory settings (see following section), re-load the Rhythm from disk.

Restoring the Rhythm Stored in the [Disk] Button to the Factory Settings

Use the following procedure to restore only the drum sets stored with the [Disk] button to their factory settings.

- 1. Press the [Power On] button to turn off the power.**
- 2. Hold down the Rhythm [Disk] button, and press the [Power On] button.**

Never turn off the power while the following screen is displayed.

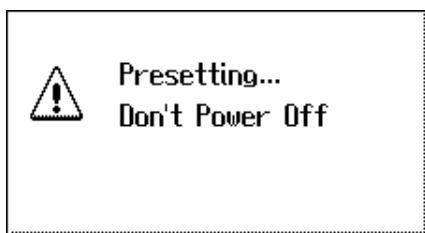

The Rhythm that had been stored in the Rhythm [Disk] button will return to the factory settings.

MEMO

To return settings other than those of the [Disk] button to the factory settings, use the Factory Reset operation (p. 22).

MEMO

You can restore the [Disk] button to the factory settings in the screen.

- 1. Touch <Rhythm> on the Main screen.**
- 2. Touch <Utility> on the Rhythm screen.**
- 3. Touch <Reset (Disk)> on the Sub-window.**

The confirmation message appears on the screen.

- 4. Touch <OK>.**

The Rhythm that had been stored in the Rhythm [Disk] button will return to the factory settings.

MEMO

Hold down the Rhythm [World] button, and press the [Power] button. The Rhythm that had been stored in the Rhythm [World] button will return to the factory settings.

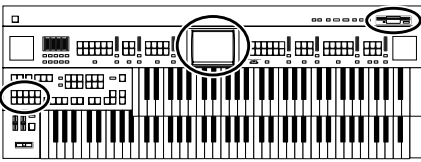

■ Loading Rhythms from World Style Setup Disk Into Internal Memory

The Rhythm [World] button contains some preset Rhythms, but by using the included World Style Setup Disk, you can rewrite these to the Rhythms of the desired country.

1. Insert the World Style Setup disk into the disk drive.
2. Touch <Rhythm> on the Main screen.

The Rhythm screen appears.



3. Touch <Utility> on the Rhythm screen.

The Utility screen appears.



4. Touch <World Rhythm>.

The World Rhythm screen appears.

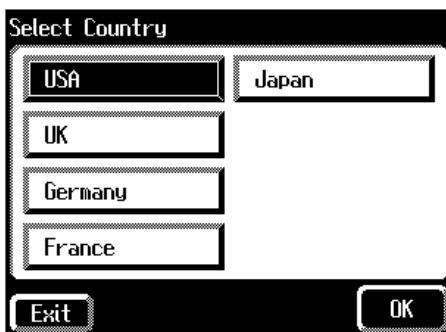

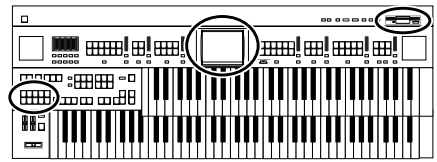

5. Touch the screen to select the country of the Rhythms that you wish to store in the [World] button.

The following countries can be selected:

USA, UK, Germany, France, Japan

The following screen appears.



Touch <Cancel> to go back to the Rhythm screen.

6. Touch <OK>.

The following screen appears.

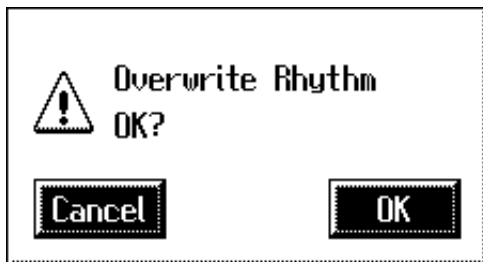

7. Touch <OK> to start loading the Rhythm into the internal memory.

The saving of the rhythm to internal memory begins.

Once the Rhythm has been accommodated in memory, the Rhythm screen will reappear.

NOTE

Never remove the disk or turn off the power while the Rhythm data is being loaded from disk into the AT-90S/80S/60S. If you do so, the Rhythm data will not be loaded into the AT-90S/80S/60S, and malfunctions could result. After returning the Rhythm stored in the [World] button to the factory settings (see following section), re-load the Rhythm from disk.

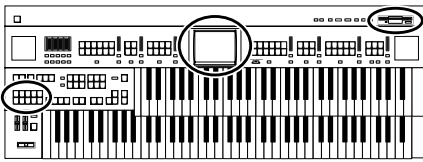

Restoring the Rhythm Stored in the [World] Button to the Factory Settings

Use the following procedure to restore only the drum sets stored with the [World] button to their factory settings.

1. Press the [Power On] button to turn off the power.
2. Hold down the Rhythm [Disk] button, and press the [Power On] button.

Never turn off the power while the following screen is displayed.

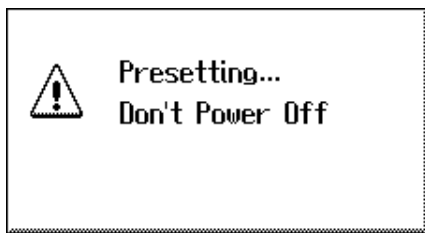

The Rhythm that had been stored in the Rhythm [World] button will return to the factory settings.

World Rhythm List

AT-90S/80S

USA	UK	Germany	Paris	Japan
On The Town	Scotland 6/8	German Waltz	Paris Waltz	Mood Kayou
Tejano	British Pop	Deutsch-Pop	Paris March	TasogareTown
Country Folk	Disco People	Polonaise	ChansonTango	Enka 1
Country Rock	70's 8beat	Ballade 6/8	Java	Enka 2
CountryBlues	House Pop	Disco-Beat	French Pop 1	16Beat Pop
Rock'n'Night	Fast Waltz	Party-Beat	French Pop 2	Power 8Beat
StridePiano	12/8 Ballad	Dt'Halfbeat	French Pop 3	AshitaNoHero
PianoBallad	Easy Swing	Evergreen	Paso Doble	Group Sounds

AT-60S

USA	UK	Germany	Paris	Japan
On The Town	Scotland 6/8	German Waltz	Paris Waltz	Mood Kayou
Tejano	British Pop	Deutsch-Pop	Paris March	TasogareTown
Country Folk	Disco People	Polonaise	ChansonTango	Enka 1
Country Rock	70's 8beat	Ballade 6/8	Java	Enka 2
CountryBlues	House Pop	Disco-Beat	French Pop 1	16Beat Pop
PianoBallad	Fast Waltz	Party-Beat	French Pop 2	Power 8Beat



To return settings other than those of the [World] button to the factory settings, use the Factory Reset operation (p. 22).



You can restore the [World] button to the factory settings in the screen.

1. Touch <Rhythm> on the Main screen.
2. Touch <Utility> on the Rhythm screen.
3. Touch <Reset (World)> on the Sub-window.
The confirmation message appears on the screen.

4. Touch <OK>.
The Rhythm that had been stored in the Rhythm [World] button will return to the factory settings.



Hold down the Rhythm [Disk] button, and press the [Power] button. The Rhythm that had been stored in the Rhythm [Disk] button will return to the factory settings.



For some of the World rhythms, the drum sounds may not play correctly on the ATELIER-R series. Please be aware of this when using World rhythms to create a registration.

Chapter 3 Using the Registration Buttons

The AT-90S/80S/60S allows you to store sound settings and panel settings in the Registration buttons. The AT-90S/80S has a total of twelve registration buttons (the AT-60S has eight), and one set of panel settings can be registered to each button, for a total of twelve types (eight types on the AT-60S) of panel settings. Each set of panel settings that has been stored in a Registration button is called a “Registration.”

This provides a convenient way to change large numbers of panel settings during a performance, or to recall a complex panel setting.

AT-90S/80S

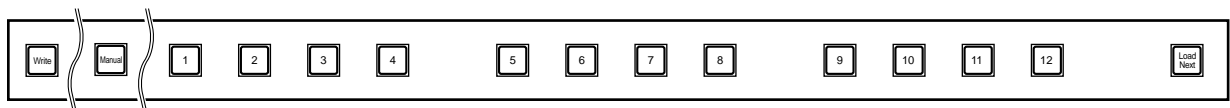

AT-60S

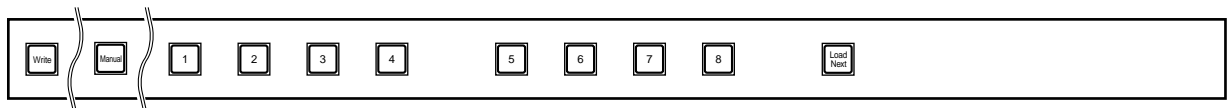

MEMO

Settings that have been stored to Registration buttons [1]–[12] (on the AT-60S, Registration buttons [1]–[8]) are remembered even if the power is turned off. If you wish to restore the settings stored in the Registration buttons to their factory settings, use the “Factory Reset” operation (p. 22).

Storing Registrations

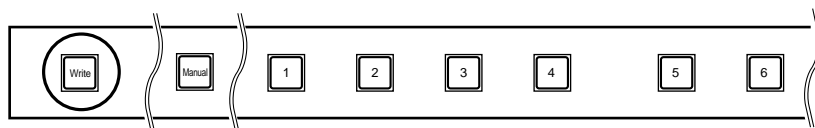

1. Make all the panel settings that you wish to store.
2. While holding down the [Write] button, press one of the Registration buttons [1]–[12] (on the AT-60S, Registration buttons [1]–[8]).

The panel settings will be stored in the selected Registration button.

MEMO

With the settings of Registration buttons [1]–[12] (on the AT-60S, Registration buttons [1]–[8]) considered as one set, a single floppy disk (2HD) can store up to 99 sets of data (p. 84).

MEMO

For details on the settings that are stored in a Registration, refer to (p. 222).

Recalling a Registration

Settings that have been registered to Registration buttons [1]–[12] (on the AT-60S, Registration buttons [1]–[8]) can be recalled in two ways:

“INSTANT” and “DELAYED.”

At the factory this is set to “DELAYED.”

■ How to Recall a Registration (DELAYED)

Recalling voices and other panel settings

1. Press a Registration button [1]–[12] (on the AT-60S, Registration buttons [1]–[8]).

Recalling settings for Rhythm and Automatic Accompaniment in addition to the panel settings

1. Press and hold a Registration button [1]–[12] (on the AT-60S, Registration buttons [1]–[8]) for several seconds.

The indicator of the rhythm select button will blink, and the panel settings and settings related to rhythm performance and automatic accompaniment will be recalled.

■ How to Recall a Registration (INSTANT)

Recalling panel settings of a voice, or when recalling settings for rhythm performance and Automatic Accompaniment in addition to panel settings

1. Press a Registration button [1]–[12] (on the AT-60S, Registration buttons [1]–[8]).

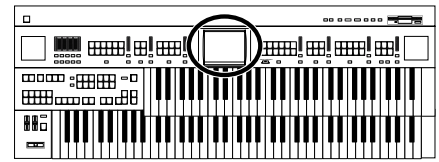

■ Changing the Timing of Recalling Registrations

Settings for Rhythm play and Automatic Accompaniment are recalled when you continue holding a Registration button [1]–[12] (on the AT-60S, Registration buttons [1]–[8]) for several seconds, but you can change this so that the settings are recalled the instant you press the button.

1. Touch <Registration> on the Main screen.

The sub-window appears.

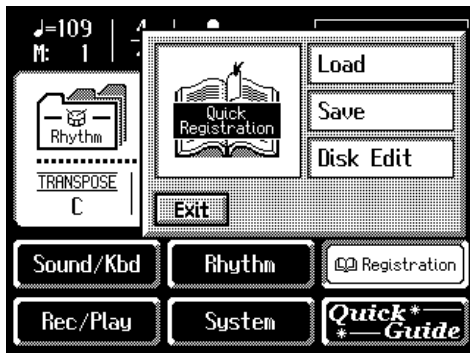

2. Touch <Load>.

The Registration Load screen appears.

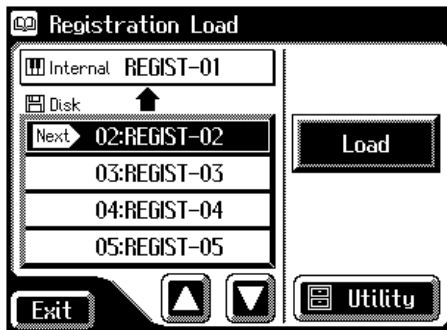

3. Touch <Utility>.

The Utility screen appears.

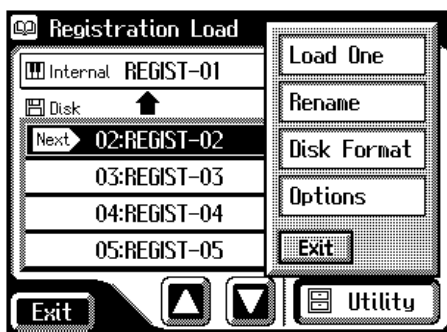

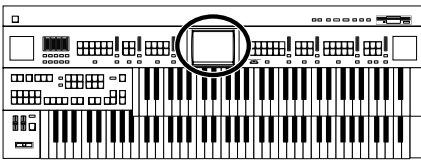

4. Touch <Options>.

The Registration Options screen appears.

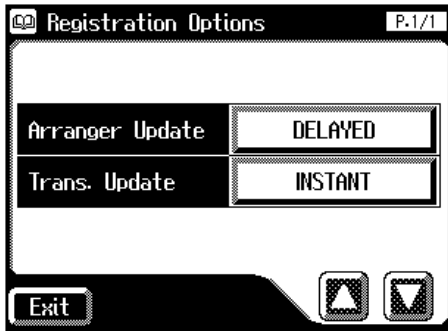

5. Touch the Arranger Update setting to switch between “DELAYED” and “INSTANT.”

Each time you touch the Arranger Update setting, it will alternate between “DELAYED” and “INSTANT.”

Setting	Descriptions
DELAYED	When you press and hold a Registration button for several seconds, the settings for Rhythm and Automatic Accompaniment will be recalled in addition to the panel settings. If you press and immediately release a Registration button, only the settings that are not related to Rhythm or Automatic Accompaniment will be recalled.
INSTANT	Settings for Rhythm and Automatic Accompaniment will be recalled the instant that you press a Registration button [1]–[12] (on the AT-60S, Registration buttons [1]–[8]).

6. Touch <Exit>.

Automatically Registering When You Switch Panel Settings

When the [Manual] button is ON (lit), all panel settings you make will be stored automatically in the [Manual] button as they are made, thus updating the Registration that had been previously saved.

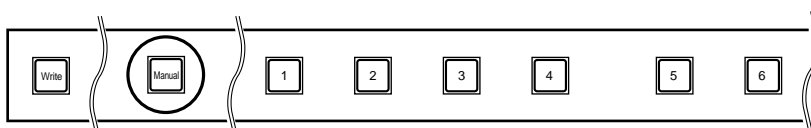

MEMO

You can change the timing of recalling the transpose setting when you press a Registration button. For details refer to “Changing the Timing at Which Transposition Settings are Recalled” (p. 167).

NOTE

The settings stored in the [Manual] button will return to their default values when the power is turned off.

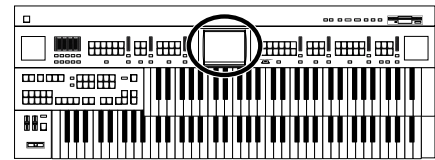

Assigning a Name to a Registration Set

When saving Registration sets, names like “REGIST-01-99” will be assigned by default, but you can assign a name that will help you later to identify the contents of the Registration set.

1. Touch <Registration> on the Main screen.

The sub-window appears.

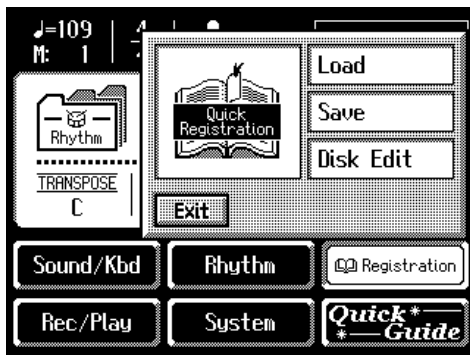

2. Touch <Save>.

The Registration Save screen appears.



3. Touch <Utility> to open the Utility screen.



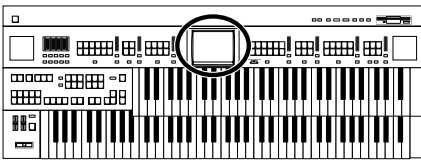

4. Touch <Rename>.

The Rename screen appears.

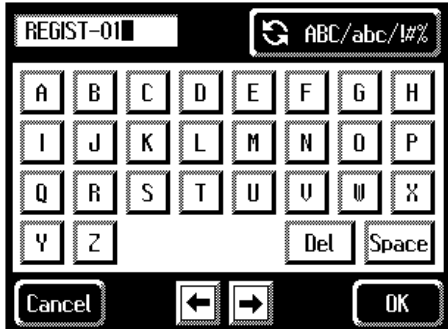

5. Touch < ABC/abc/!#% > to change among uppercase/ lowercase/symbols.

Each touch of the character switch button takes you to the next available choice, like this: uppercase → lowercase → symbols → uppercase ...

6. Touch the screen to specify the desired character.

The following characters can be selected.

Uppercase	A B C D E F G H I J K L M N O P Q R S T U V W X Y Z
Lowercase	a b c d e f g h i j k l m n o p q r s t u v w x y z
Symbols	! " # % & ' () * + , - . / : ; = ? ^ _ 0 1 2 3 4 5 6 7 8 9
	Delete a character.
	Insert a space.
	Move the cursor (the symbol that indicates the location at which characters will be input) to left or right.

To cancel the operation, touch <Cancel>.

7. When you're done making the settings, touch <OK>.

The Registration set in the AT-90S/80S/60S's internal memory has now been named.



MEMO

The Rename screen can also be opened in the following ways.

Main screen
 <Registration> → <Regist Load> → Registration Load screen
 <Utility> → Utility screen
 <Rename>

Main screen <Registration> → <Regist Filer> → Regist Filer screen
 <Rename>

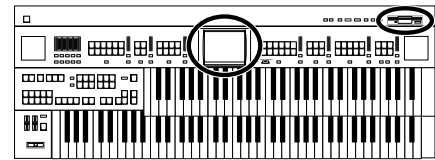

Formatting Disks

Before any floppy disk (new or used) can be used with the AT-90S/80S/60S it must first be formatted (prepared).

Formatting a floppy disk erases all information stored on the disk, and puts it in a format that is acceptable for the device in which it will be used. If a floppy disk is in a format that doesn't match the format of this unit, you won't be able to use that floppy disk.

NOTE

Formatting a disk destroys all data previously stored on the disk. If you're formatting a used floppy disk for reuse, be sure to check first to make sure the disk doesn't contain any data you don't want to lose.

- 1. Make sure that the write protect tab of the floppy disk is in the "Write" (permit) position.**

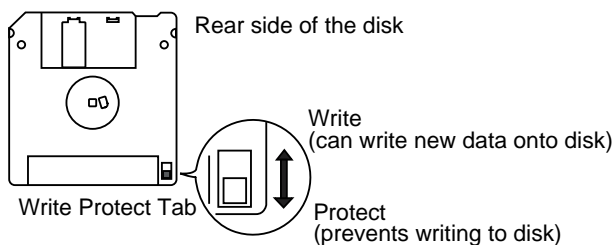

- 2. With the label of the floppy disk facing upward, insert it into the disk drive until it clicks into position.**

The disk drive is located to the upper right of the AT-90S/80S/60S's keyboard.

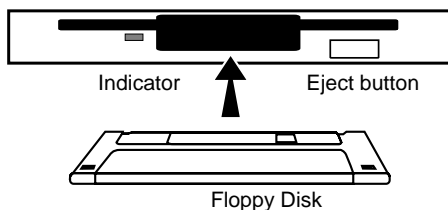

- 3. Touch <Registration> on the Main screen.**

The sub-window appears.

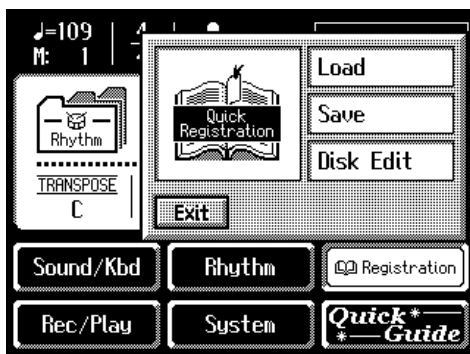

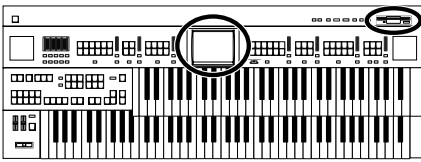

4. Touch <Save>.

The Registration Save screen appears.



5. Touch <Utility>.

The Utility screen appears.

6. Touch <Format Disk>.

The Format Disk screen appears.



If you touch <Cancel>, you will return to the Registration Save screen without formatting.

7. Touch <OK> to start formatting.

While formatting is in progress, the following display appears.



When the format is finished, the Registration Save screen returns.

NOTE

Never attempt to remove the floppy disk until formatting is complete.

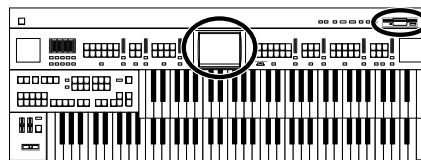

Saving Registration Sets to a Floppy Disk

With the settings of Registration buttons [1]–[12] (on the AT-60S, Registration buttons [1]–[8]) considered as one set, a single floppy disk can store up to 99 sets of data. We recommend that complex panel settings or Registrations you wish to keep be saved on disk. If AT-90S/80S/60S Registrations that you create are saved on a floppy disk, they can then be recalled later or recalled for use on another AT-90S/80S/60S.

1. **Make sure that the disk drive contains a disk that was formatted (p. 82) by the AT-90S/80S/60S.**
2. **Touch <Registration> on the Main screen.**

The sub-window appears.

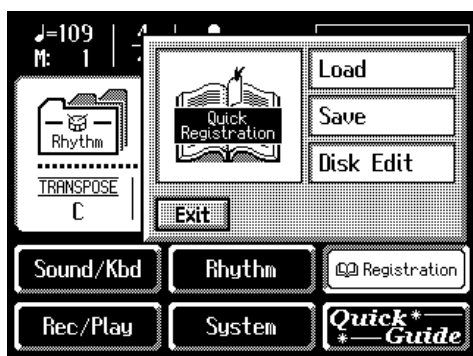

3. **Touch <Save>.**

The Registration Save screen appears.

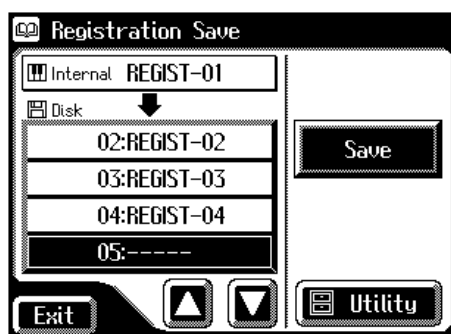

4. **Touch <▲> <▼> in the screen to select the save-destination number.**

MEMO

If you wish to assign a name before you save, refer to “Assigning a Name to a Registration Set” (p. 80)

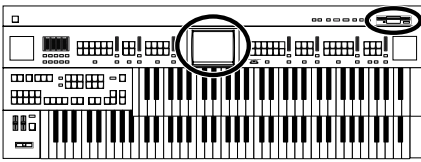

Numbers which have not been used in the saving operation will be displayed as “-----.”



To cancel the Save operation, touch the <Exit> button to close the Registration Save screen.

5. Touch <Save>.

The Save Format screen appears.



6. Touch <Original> or <R-Series>.

Settings	Description
Original	A format that can be used only by models of the AT-S series.
R-Series	A format that can be used by models of the AT-R series.

7. Touch <OK>.

Saving of the registration data will begin.

When saving ends, the “-----” in the screen will change to the registration name that you saved.

If you have assigned a name, the Registration set will be saved to floppy disk with that name.

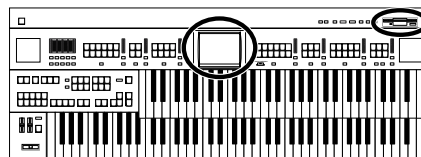

If the following screen appears

If you select a number at which a registration has already been saved and touch <Save>, the following screen appears.

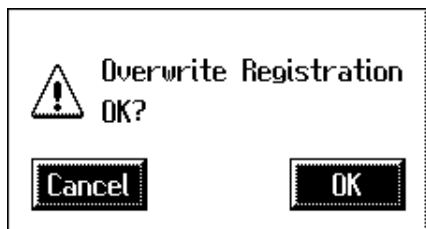

If you wish to update the contents of the Registration data

1. Touch <OK>.

The Registration will be rewritten.

If you wish to save new data instead of updating the registration

1. Touch <Cancel>.

Rewriting of the Registration will be canceled.

2. In the Registration Save screen, select the number that is displayed as “-----” (a number that currently does not contain registration data).

3. Save the Registration (p. 84).

When saving is complete, the saved registration name will be displayed.

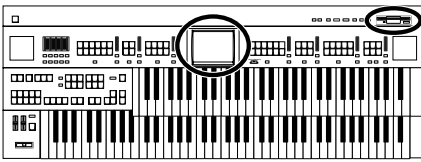

Loading Previously Saved Registration Sets Into the AT-90S/80S/60S

Here's how to recall a previously saved Registration set from the floppy disk into the memory of the AT90S/80S/60S. Registrations can be selected in the following three ways.

Loading a Set of Registrations (Load) → (p. 87)

You can load a "set" (a collection of settings for Registration buttons [1]–[12] on the AT-90S/80S, Registration buttons [1]–[8] on the AT-60S) from floppy disk.

Loading an Individual Registration (Load One) → (p. 89)

Recall the settings of one of the Registration [1]–[12] buttons (on the AT-60S, Registration buttons [1]–[8]).

Recalling the Order that the Registrations are Saved on the Floppy Disk (Load Next) → (p. 92)

Press the [Load Next] button to recall registration sets in the order in which they are saved on the floppy disk.

NOTE

Be aware that when you load Registrations from a disk, the Registrations that were previously in internal memory will be lost. It is a good idea to save important Registrations to floppy disk (p. 84).

■ Loading a Set of Registrations

1. Insert the floppy disk containing the Registration into the disk drive.
2. Touch <Registration> on the Main screen.

The sub-window appears.

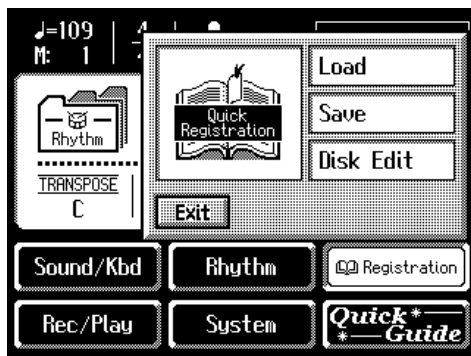

MEMO

You can also open the Registration Load screen by pressing the [Registration] button, instead of performing steps 2 and 3.

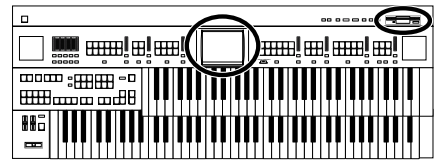

3. Touch <Load>.

The Registration Load screen appears.

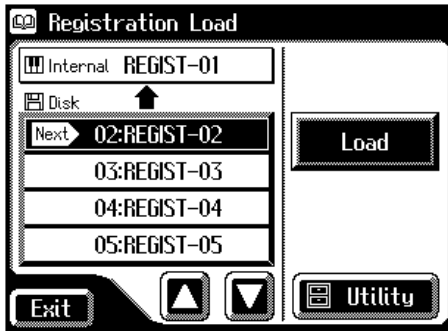

4. In the screen, touch <▲><▼> to select the Registration that you wish to load into internal memory.

To cancel operation, touch <Exit>.

5. Touch <Load>.

The registration data will start being read.

While registrations saved on the AT-90/AT-80/AT-30 are being loaded into this instrument, the following screen appears.

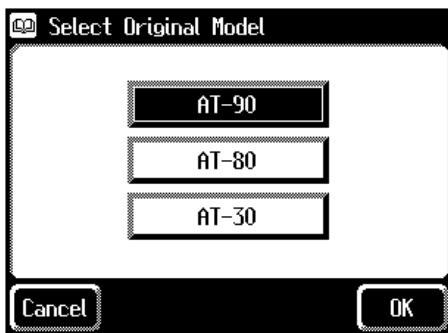

MEMO

When you use the Registrations saved on the AT-90/AT-80/AT-30, refer to “Using Registrations Created on an Earlier Model” (p. 97)

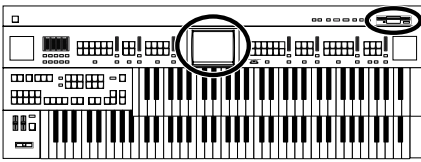

■ Loading an Individual Registration

1. Insert the floppy disk containing the Registration into the disk drive.
2. Touch <Registration> on the Main screen.

The sub-window appears.

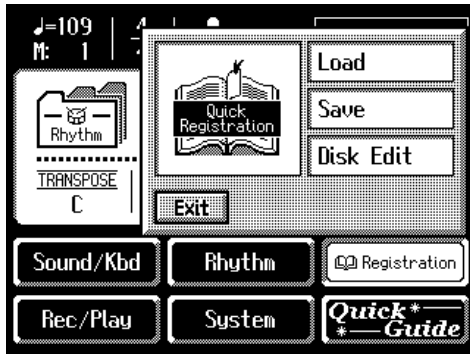

3. Touch <Load>.

The Registration Load screen appears.

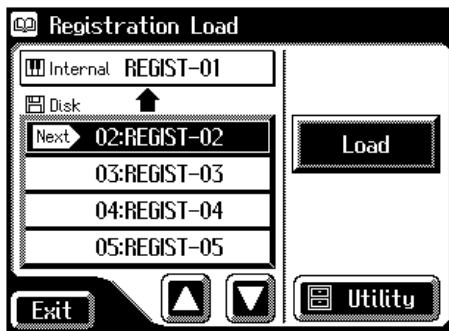

4. In the screen, touch <▲><▼> to select the registration that you wish to load into internal memory.
5. Touch <Utility> to open the Utility screen.

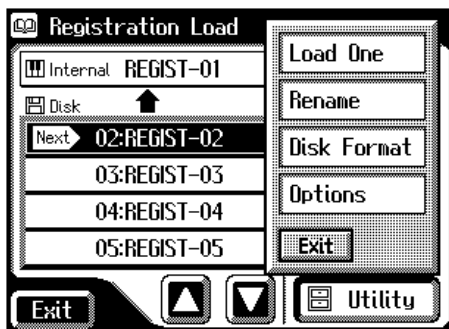

MEMO

You can also open the Registration Load screen by pressing the [Registration] button, instead of performing steps 2 and 3.

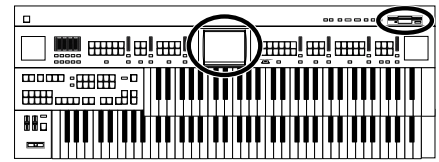

6. Touch <Load One>.

The Load One Registration screen appears.

AT-90S/80S

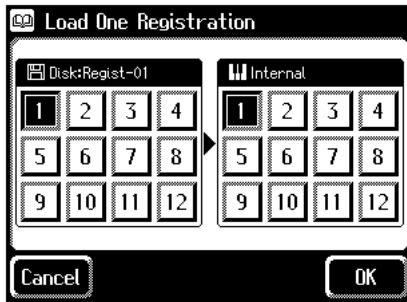

AT-60S

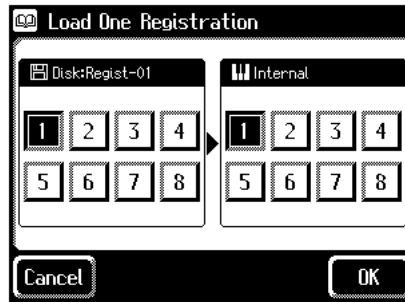

7. In the screen, touch Disk <1>--<12> (on the AT-60S, Disk <1>--<8>) to select the number of the registration button that you wish to load from disk into internal memory.

AT-90S/80S

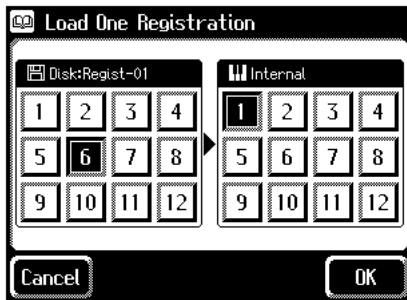

AT-60S

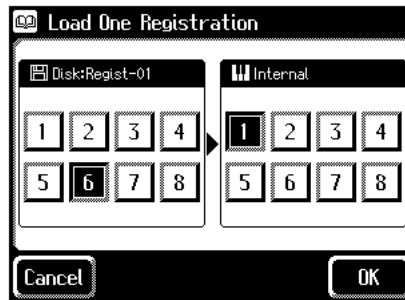

8. In the screen, touch Internal <1>--<12> (on the AT-60S, Internal <1>--<8>) to select the number of the storage-destination button.

AT-90S/80S

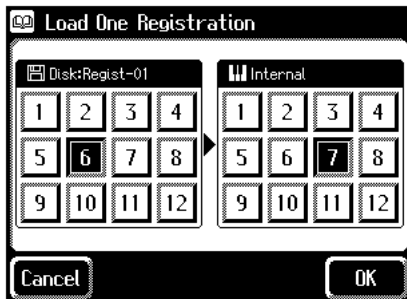

AT-60S

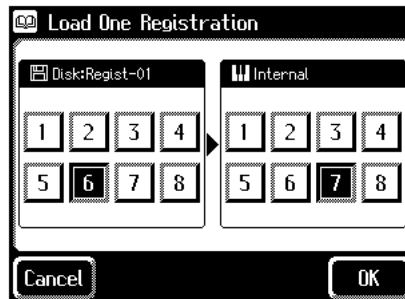

To cancel this operation, touch <Cancel>.

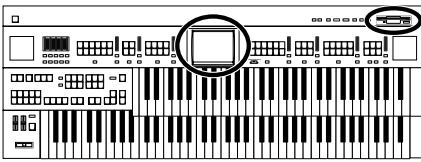

9. When you're done making the settings, touch <OK>.

The following display appears.



When the Registration has been loaded, the basic screen will reappear.

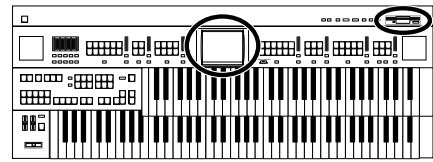

■ Recalling the Order that the Registrations are Saved on the Floppy Disk (Load Next)

On the AT-90S/80S/60S, you can simply press the [Load Next] button to successively recall registrations in the order in which they were saved on the floppy disk. This function is called “Load Next.”

When you will be performing live, you can save registration sets to floppy disk in the order in which you will be performing. Then while you perform, you can recall the next registration set easily and smoothly.

1. Insert the floppy disk on which the registrations are saved into the floppy disk drive.

2. Press the [Load Next] button.

The first registration saved on the floppy disk will be recalled into the AT-90S/80S/60S.

The following screen appears.



3. Press one of the registration [1]–[12] buttons (on the AT-60S, registration [1]–[8] buttons).

The registration will be loaded (recalled into internal memory).

4. Repeat steps 2 and 3 to successively recall the registration sets.

MEMO

By using the “Disk Edit” function, you can modify the order or the name of the registrations saved on disk, or delete an unwanted registration (p. 96).

Button	Description
Undo	Return to the registration that had been selected before you pressed the [Load Next] button.
OK	Finalize the registration. It will not be possible to return to the previous registration.

MEMO

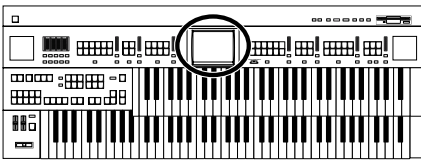

Instead of performing step 3, you can also load the registration by touching <OK> in the screen.

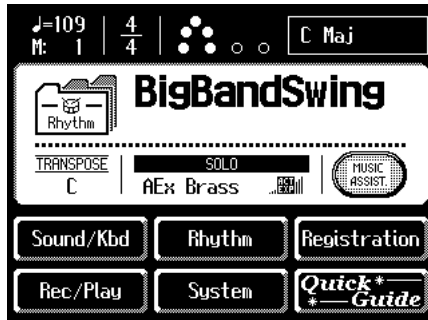

Checking the next registration set

1. Access the Main screen.



2. Touch the <  > icon several times to switch to <  >.

The Main screen display will switch to the registration.

If the next registration set is loaded



“Next” will indicate the name of the next registration set.

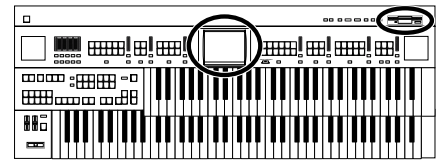

Deleting a Set of Registrations from a Floppy Disk

Here's how to delete a Registration set that was saved to a floppy disk.

1. Insert the floppy disk containing the Registration into the disk drive.
2. Touch <Registration> on the Main screen.

The sub-window appears.

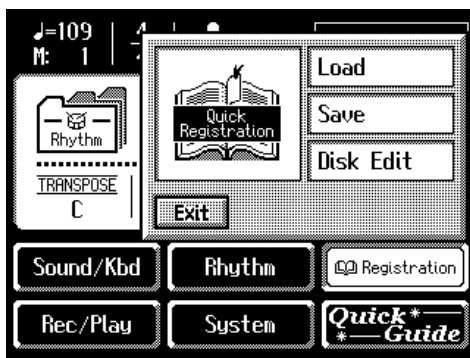



3. Touch <Disk Edit>.

The Disk Edit screen appears.

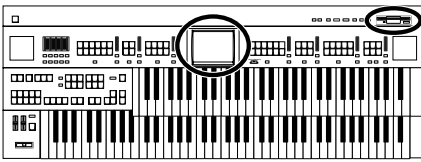

Button	Mean	Description
Rename	Modify the name	The Rename screen appears. You can touch the screen and rename the selected registration.
Up	Change the order (upward)	The selected registration will be moved earlier in the order.
Down	Change the order (downward)	The selected registration will be moved later in the order.
Delete	Delete the Registration	The selected registration will be deleted.



4. In the screen, touch  < &img alt="down arrow button" data-bbox="396 121 431 148"/> > to select the registration that you wish to delete.

5. Touch <Delete>.

The following display appears.



To cancel operation, touch <Cancel>.

6. If you are sure that you wish to delete the registration, touch <OK>.

When the Registration has been deleted, the Disk Edit screen will reappear.

When a registration is deleted, the deleted registration name will change to "-----".



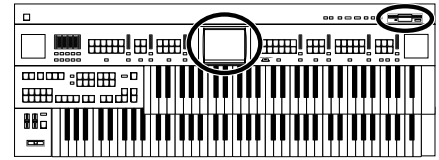

Changing the Order of Registration on Floppy Disk

After saving registrations on floppy disk, you can change the order or name of the registrations (p. 80), or delete a registration (p. 94). This is very convenient when you are preparing to use the [Load Next] button (Load Next function → p. 92) to recall successive registrations while you play.

1. Insert the floppy disk containing the Registration into the disk drive.

2. Touch <Registration> on the Main screen.

The sub-window appears.

3. Touch <Disk Edit>.

The Disk Edit screen appears.



4. Touch <▲> <▼> in the screen to select a registration.

5. Touch <Up> or <Down> to move the registration.

Button	Mean	Description
Rename	Modify the name	The Rename screen appears. You can touch the screen and rename the selected registration.
Up	Change the order (upward)	The selected registration will be moved earlier in the order.
Down	Change the order (downward)	The selected registration will be moved later in the order.
Delete	Delete the Registration	The selected registration will be deleted.

6. Touch <Exit>.

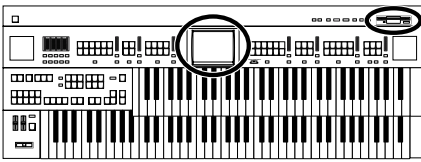

Using Registrations Created on an Earlier Model

Registrations that were created on the ATELIER series (AT-90/80/30) or ATELIER-R series (AT-90R/80R/60R/30R/20R) can be used on the AT-90S/80S/60S.

When using a set of registrations that was created on the AT-90/80/60 models, your registrations will be converted to work in the AT-90S/80S/60S models and loaded into internal memory. When loading these registrations the music style that was originally used can also be loaded into the [Disk] button to complete the accurate reproduction of the original registration.



This operation is not necessary when recalling a registration that was created on a model in the AT-R series.

Recalling a registration that was created on the “AT-90/80/30”

1. Insert the floppy disk that contains Registrations created on an earlier model of the ATELIER series.
2. Touch <Registration> on the Main screen.

The sub-window appears.

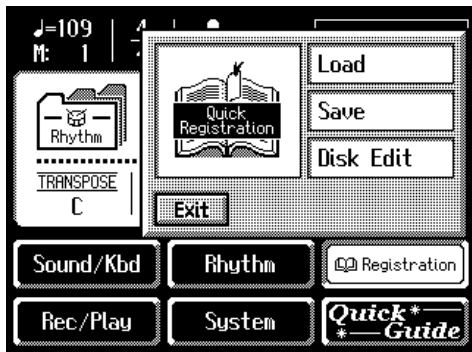



You can also open the Registration Load screen by pressing the [Registration] button, without performing steps 2 and 3.

3. Touch <Load>.

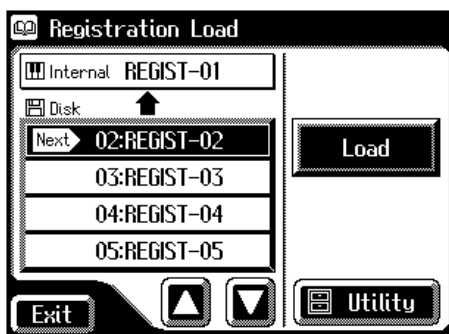
The Registration Load screen appears.

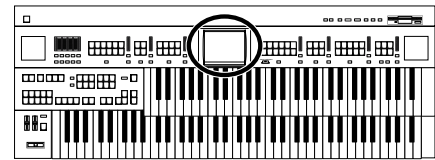



4. Touch  <  to select the registration that you wish to load into internal memory.

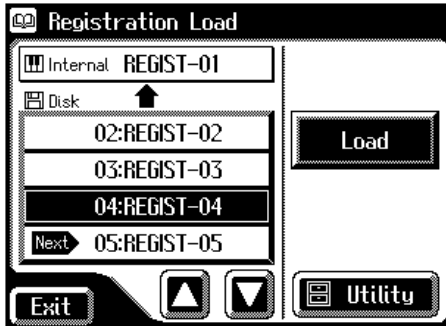

To cancel operation, touch <Exit>.

5. Touch <Load>.

The following screen appears.

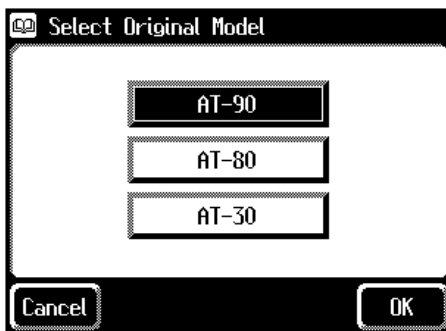

To cancel operation, touch <Cancel>.

6. Touch the screen to select the model on which the Registration was created.
7. Touch <OK> to confirm the model on which the Registration was created.

If the Rhythm used by the Registration is found in the internal memory of the AT-90S/80S/60S, the Registration will be loaded into internal memory. When loading is complete, the Registration Load screen will reappear.

NOTE

If the Rhythms of the [Disk] button or the [World] button have been rewritten, there may be cases in which the Registration cannot be loaded correctly.

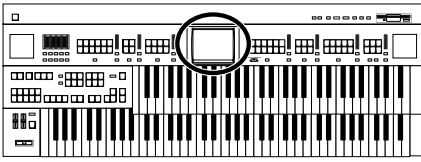

If internal memory does not contain a rhythm specified by the registration

The number of the included music style disk that contains that rhythm will be displayed.

AT-90S/80S

AT-60S

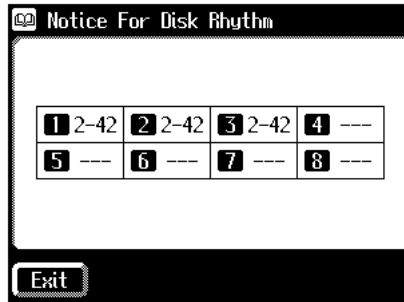
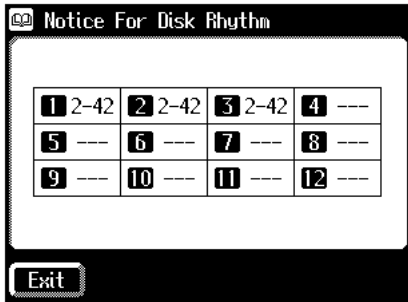

- 8. Make a note of the number of the music style disk, and touch <Exit>.**

A similar rhythm that does exist in internal memory will be substituted for the rhythm that does not exist, and the registration will be loaded.

Loading a AT-90/80/30 rhythm into the [Disk] button

If you wish to use a Rhythm used by an earlier model of the ATELIER series with a Registration that you loaded, load the Rhythm from the Music Style disk into the [Disk] button.

- 9. Remove the Registrations floppy disk from the disk drive, and insert the Music Style disk.**
- 10. Load the Rhythm whose number you noted in step 8 into the [Disk] button (p. 70).**

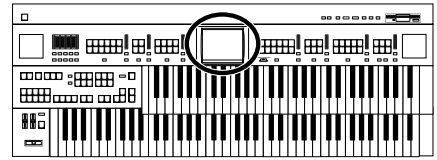

Choose a Keyword for Quick Registration Selection

You can select a voice appropriate for your performance by selecting from keywords representing your situation, location, musical genre, etc. You can call up registrations created by top-level organists, and refer to them for hints on how to select and layer sounds when creating your own registrations.

1. Touch <Registration> on the Main screen.

The sub-window appears.

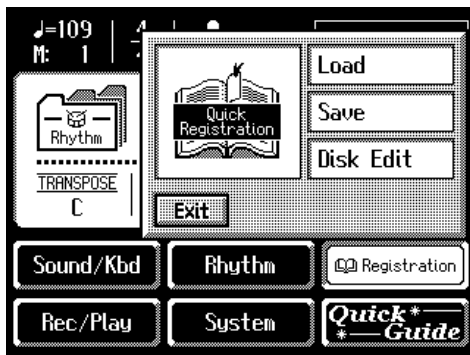

2. Touch <Quick Registration>.

The Quick Registration screen appears.

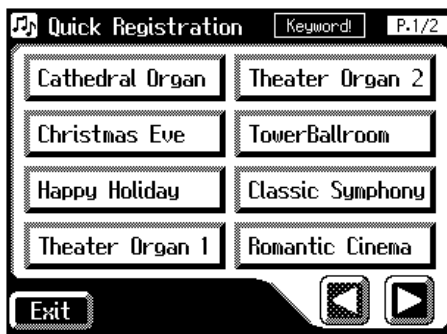

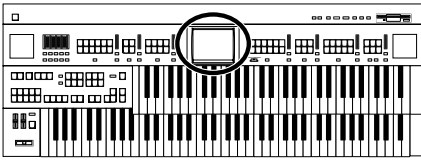

- 3. Touch <◀><▶> to switch pages, and touch the desired keyword.**

Voice selections appropriate for that keyword appears in the display.

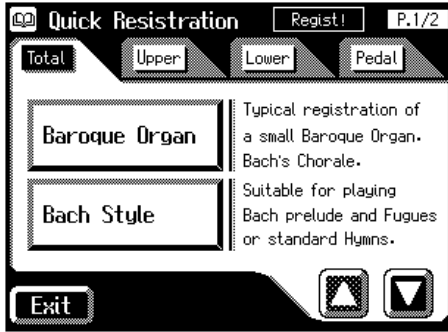

- 4. Touch either <Total>, <Upper>, <Lower>, or <Pedal> to select the keyboard for which you want to select a voice.**

Setting	Keyboard for which you select a voice
Total	Upper keyboard, Lower keyboard, and pedalboard
Upper	Upper keyboard
Lower	Lower keyboard
Pedal	Pedalboard

- 5. Touch <▲><▼> to switch pages, and touch the desired voice.**

The voice will be assigned to the selected keyboard.

Chapter 4 Using the Performance Functions

Transposing to a Different Key (Key Transpose)

You can transpose the key of a performance without having to shift the position of your fingers on the keyboard. This feature is called “Key Transpose.”

For example: you may play in the familiar C major scale while your music will sound in any key of your choice.

Transpose

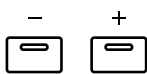

1. Set the value for the transposition with the Transpose [-] and [+] buttons.

Each time you press a Transpose [-] [+] button, the pitch will be transposed by a semitone.

Acceptable values range from A_b to G (in semitone steps).

The specified value will be displayed in the Main screen.

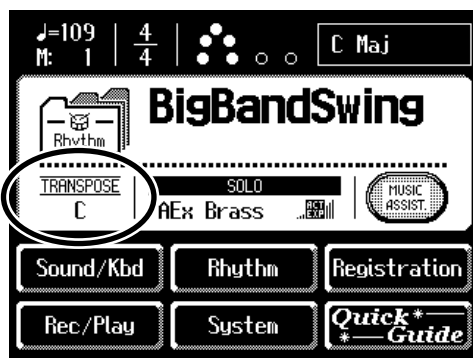

State of the Transpose [-] [+] buttons

If transposed (non-C)	One of the Transpose [-] [+] button indicators is lit.
If not transposed (C)	The Transpose [-] [+] button indicators are extinguished.

2. By pressing the Transpose [-] [+] buttons simultaneously, you can restore the default setting C.



The transposition setting is stored in the Registration. For details on the settings that are stored in the Registration, refer to “Settings That Are Stored After the Power Is Turned Off” (p. 222).



You can change the timing at which the transposition settings saved in a Registration will be recalled. For details refer to “Changing the Timing at Which Transposition Settings are Recalled” (p. 167).

Adjusting the Overall Volume Using an Expression Pedal

You can use the expression pedal to adjust the overall volume. When you depress the Expression Pedal, the volume increases. The volume decreases as you tilt the pedal back.

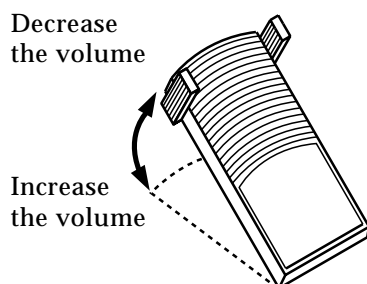

Adding Decay to the Sound (Damper Pedal)

When you depress the Damper (Sustain) pedal, a decay effect will be added to the voices.

While you continue depressing the damper pedal, notes will be sustained even if you release the keys.

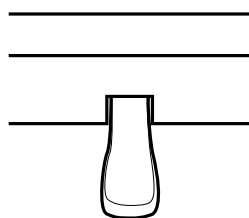

By default the decay effect will be applied to the voices played on the Lower keyboard.

MEMO

You can specify how the Expression Pedal will affect the sound when it is pressed (p. 163).

MEMO

You can also specify whether the Expression Pedal will or will not control the volume during the recording of your performance (p. 162).

MEMO

Likewise you can specify whether the Expression Pedal will or will not control the volume during the playback of recorded performance (p. 162).

MEMO

You can modify the setting so that decay is only applied to notes played on the Upper keyboard (p. 163).

NOTE

Decay cannot be added to the Solo voices.

MEMO

Decay can be applied to Pedal Bass voices played on the Lower keyboard (when the [To Lower] or [Bass Split] button indicators are lit). In this case, a decay will not be applied to the pedal bass voice.

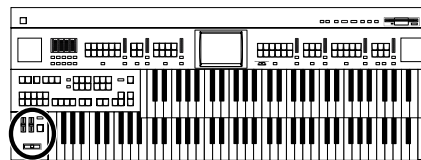

Pitch Bend and Vibrato Effects

When you move the Pitch Bend/Vibrato lever to the left or right, you can obtain a smooth change in the pitch of the notes being played (Pitch Bend effect). Move the lever to the right to raise the pitch, and to the left to lower it. Also, when you push the lever away from you, a vibrato effect can be obtained.

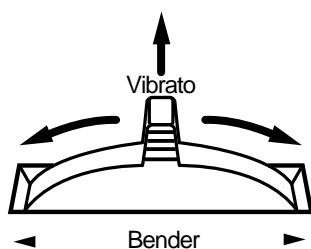

By default (immediately after the power is turned on) the Pitch Bend effect is added to the voices of all the sections being played on the Upper keyboard.

MEMO

You can change the settings so that both the Pitch Bend and Vibrato effects are applied to the Lower keyboard voice or the voices on the Pedalboard. Please refer to **“Selecting the Range of Keys to Which the Pitch Bend/Vibrato Lever will Apply”** (p. 163).

MEMO

You can also adjust the range of the pitch which is shifted by the Pitch Bend lever. For details, refer to **“Changing the Pitch Bend Range”** (p. 164).

NOTE

Please note that only the appropriate voices will allow vibrato to be added (p. 193).

Adjusting the Brightness of the Sound

Using the Brilliance slider, you can adjust the brightness of the sound.

1. For a brighter sound, push the slider away from you. For a mellow sound, pull the slider toward you.

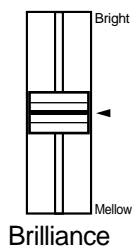

NOTE

This setting is not stored in the Registration.

Using the Foot Switches

On either side of the expression pedal are two Foot Switches. Different functions are assigned to each of these two foot switches.

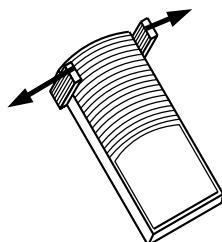

With the factory settings, the following functions are assigned to the left and right Foot Switches.

Right Foot Switch	Switch the Rotary effect between Fast/Slow.
Left Foot Switch	Glide (an effect by which the pitch is lowered by a semi-tone while the foot switch is pressed, and is returned to what is originally was when you release your foot).

1. Press the right Foot Switch toward the right.

If Rotary is turned on, the Rotary effect will switch between “Fast” and “Slow” each time you press the Foot Switch.

2. Press the left Foot Switch toward the left.

While you are pressing the Foot Switch, the pitch will be temporarily lowered. When you release the Foot Switch, the pitch will return to normal.

MEMO

You can also change the functions assigned to the left and right Foot Switches. Please refer to “Changing the Function of the Foot Switch” (p. 160).

MEMO

The Glide effect will only be applied to the keyboard section that has been specified as being the destination for the Pitch bend/Vibrato lever. Please refer to “Selecting the Range of Keys to Which the Pitch Bend/Vibrato Lever will Apply” (p. 163).

NOTE

If “Regist Shift” is turned “RIGHT” or “LEFT,” the foot switch will function only to switch registrations (p. 161).

Chapter 5 Applying Various Effects to the Sound

The AT-90S/80S/60S allows you to apply various effects to the sounds you play from the keyboard.

Adding Harmony to a Melody (Harmony Intelligence) (AT-90S)

Harmony appropriate for the chord you play in the lower keyboard can be added to the highest note played in the upper keyboard. This function is called “Harmony Intelligence.”

When you press any of the Harmony Intelligence buttons, the voice most suitable for the selected harmony intelligence will be selected automatically.

Harmony Intelligence

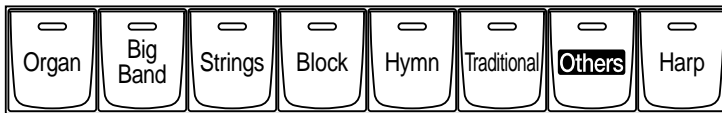

- 1. Press one of the Harmony Intelligence buttons (indicator lights).**

Each time you press the button, the indicator will alternate between ON (lit) and OFF.

The name of the selected Harmony Intelligence will be displayed for several seconds in the screen.

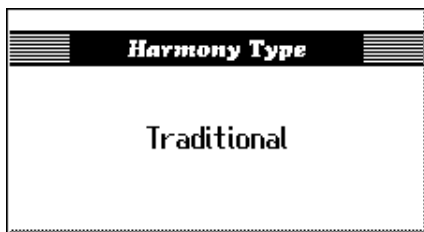

There are 24 different Harmony types. The manner in which notes will sound also depends on the Harmony type.

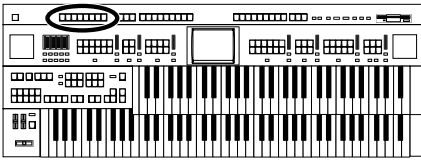

■ Harmony Intelligence [Others] button (AT-90S)

The Harmony Intelligence [Others] button contains various types of Harmony Intelligence. To select Harmony Intelligence settings from the Harmony Intelligence [Others] button, use the following procedure.

1. Press the Harmony Intelligence [Others] button.

The Harmony Intelligence screen appears for several seconds.



2. Touch < > to switch the screen, and touch the screen to select the desired harmony intelligence.

The indicator of the Harmony Intelligence [Others] button will blink.

3. Press the Harmony Intelligence [Others] button once again.

The Harmony Intelligence [Others] button indicator will light, indicating that the selected harmony intelligence has been confirmed.

MEMO

You can also confirm the Harmony Intelligence settings by touching <Exit> on the Harmony Intelligence screen. You can also play the upper manual to confirm the type of the Harmony Intelligence.

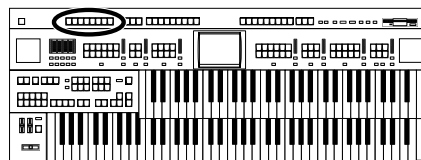

Type	How notes pressed are sounded	Harmony
[Organ]	Upper Voice	Upper Voice
[Big Band]	Solo Voice	Upper Voice
[Strings]	Solo Voice & Upper Voice	Upper Voice
[Block]	Solo Voice & Upper Voice	Upper Voice
[Hymn]	Solo & Upper Voice	Upper Voice
[Traditional]	Solo Voice & Upper Voice	Upper Voice
[Harp]	not sounded	Upper Voice
[Others]		
DUET	Solo Voice	Upper Voice
COMBO	Solo Voice	Upper Voice
JAZZ SCAT	Solo Voice	Upper Voice
COUNTRY	Solo Voice & Upper Voice	Upper Voice
BROADWAY	Solo Voice & Upper Voice	Upper Voice
BRASS	Solo Voice	Upper Voice
FLUTE	Solo Voice	Upper Voice
DIXIELAND	Solo Voice	Upper Voice
HYMN2	Solo Voice & Upper Voice	Upper Voice
GOSPEL	Solo Voice & Upper Voice	Upper Voice
SYNTH	Solo Voice & Upper Voice	Upper Voice
OCTAVE 1	Solo Voice & Upper Voice	Upper Voice
OCTAVE 2	Solo Voice & Upper Voice	Upper Voice
1 NOTE	Solo Voice & Upper Voice	Upper Voice
2 NOTES	Solo Voice & Upper Voice	Upper Voice
3 NOTES	Solo Voice & Upper Voice	Upper Voice
4 NOTES	Solo Voice & Upper Voice	Upper Voice

NOTE

The number of notes of the harmony will depend on the Harmony Intelligence type.

MEMO

Harp-type harmony intelligence will not sound the keys you play. Use your left hand to play a chord in the lower keyboard and use your right hand to play a glissando on the upper keyboard, and a beautiful harp glissando will be produced.

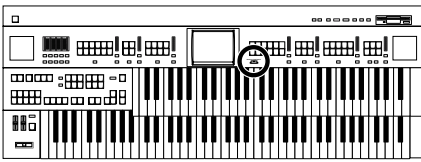

Adding Harmony to a Melody (Harmony Intelligence) (AT-80S/60S)

1. Press the [Harmony Intelligence] button, getting its indicator to light up.

Each time you press the button, the indicator will alternate between ON (lit) and OFF.

The Harmony Intelligence screen appears for several seconds.

Harmony Intelligence



■ Changing the Type of Harmony Intelligence (AT-80S/60S)

There are 18 different Harmony types (AT-80S).

There are 12 different Harmony types (AT-60S).

When you press the [Harmony Intelligence] button to turn it on (lit), a voice most suitable for the selected harmony intelligence will be selected automatically. The manner in which notes will sound also depends on the Harmony type.

1. Press the [Harmony Intelligence] button, getting its indicator to light up.

The Harmony Intelligence screen appears for several seconds.

AT-80S

AT-60S



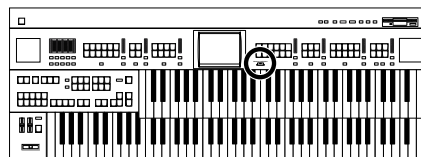

- 2. Touch <◀▶> to switch screens, and touch the screen to select the desired harmony intelligence.**

The [Harmony Intelligence] button's indicator will blink.

Model	Harmony Intelligence Type
AT-80S	DUET, ORGAN, COMBO, STRINGS, HYMN, BLOCK, HARP, JAZZ SCAT, BIG BAND, COUNTRY, BROADWAY, TRADITIONAL, OCTAVE 1, OCTAVE 2, 1 NOTE, 2 NOTES, 3 NOTES, 4 NOTES
AT-60S	ORGAN, COMBO, STRINGS, HYMN, BLOCK, HARP, JAZZ SCAT, BIG BAND, BROADWAY, TRADITIONAL, OCTAVE 1, OCTAVE 2

- 3. Press the [Harmony Intelligence] button once again.**

The [Harmony Intelligence] button indicator will light, indicating that the selected harmony intelligence has been confirmed.

The way in which the keys you press are sounded by each type of harmony intelligence is described below.

Type	How notes pressed are sounded	Harmony
DUET	Solo Voice	Upper Voice
ORGAN	Upper Voice	Upper Voice
COMBO	Solo Voice	Upper Voice
STRINGS	Solo Voice & Upper Voice	Upper Voice
HYMN	Solo Voice & Upper Voice	Upper Voice
BLOCK	Solo Voice & Upper Voice	Upper Voice
HARP	not sounded	Upper Voice
JAZZ SCAT	Solo Voice	Upper Voice
BIG BAND	Solo Voice	Upper Voice
COUNTRY	Solo Voice & Upper Voice	Upper Voice
BROADWAY	Solo Voice & Upper Voice	Upper Voice
TRADITIONAL	Solo Voice & Upper Voice	Upper Voice
OCTAVE 1	Solo Voice & Upper Voice	Upper Voice
OCTAVE 2	Solo Voice & Upper Voice	Upper Voice
1 NOTE	Solo Voice & Upper Voice	Upper Voice
2 NOTES	Solo Voice & Upper Voice	Upper Voice
3 NOTES	Solo Voice & Upper Voice	Upper Voice
4 NOTES	Solo Voice & Upper Voice	Upper Voice

MEMO

You can also confirm the Harmony Intelligence settings by touching <Exit> on the Harmony Intelligence screen. You can also play the upper manual to confirm the type of the Harmony Intelligence.

NOTE

The number of notes of the harmony will depend on the Harmony Intelligence type.

MEMO

Harp-type harmony intelligence does not sound the keys you play. Use your left hand to play a chord in the lower keyboard and use your right hand to play a glissando in the upper keyboard, and a beautiful harp glissando will be produced.

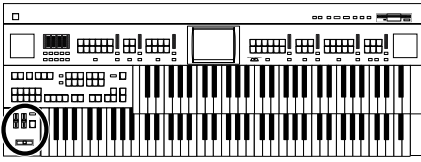

Adding Modulation to the Sound (Rotary Effect)

Rotary is an effect which simulates the sound of rotating speakers. There is a choice of two settings: Fast and Slow.



- 1. Select the voice to which you wish to apply the Rotary effect.**
- 2. Press the Rotary Sound [On/Off] button (confirm that its indicator is lit).**
The Rotary effect will be applied to the voice.
- 3. Press the Rotary Sound [Fast/Slow] button to switch between Rotary Fast (LED lit) and Rotary Slow (LED turned off).**

Rotary [Fast/Slow] button	Effect
LED lit (Fast)	The effect obtained is equivalent to speakers being rapidly rotated.
LED turned off (Slow)	Effect simulating the slow rotation of speakers.

NOTE

Some voices do not allow the Rotary effect to be applied. For details refer to “Voice List” (p. 193).

MEMO

You can assign the Rotary Sound [Fast/Slow] button function to the foot switches located on each side of the Expression Pedal (p. 160)

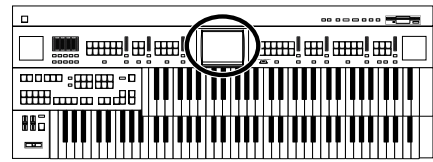

Chorus Effect

Chorus is an effect that adds expansiveness to a sound, making one instrument sound like several.

You can apply a chorus effect for the “Upper Symphonic,” “Upper Orchestral,” “Lower Symphonic,” and “Lower Orchestral” voices.



For some of the voices, Chorus may already be turned ON.

1. Touch <Sound/Kbd> on the Main screen.

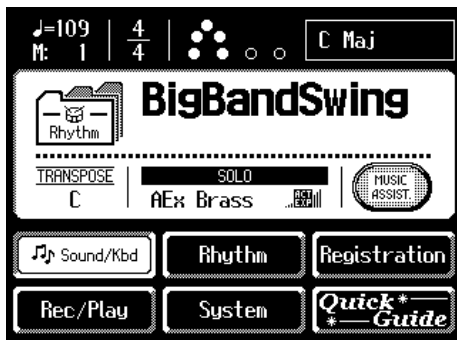

The sub-window appears.

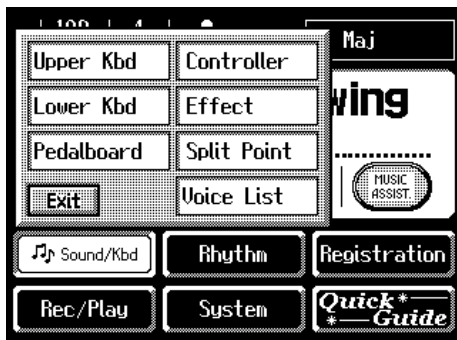

2. In the sub-window, touch either <Upper Kbd> or <Lower Kbd>.

Menu	Part to apply Chorus effect
Upper Kbd	To apply chorus to the Upper part
Lower Kbd	To apply chorus to the Lower part

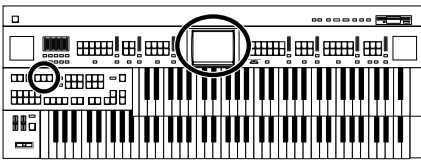

- For the part to which you wish to apply the chorus effect, touch the Chorus “ON/OFF” display to change the setting.

Each time you touch the Chorus setting, it will alternate ON/OFF.

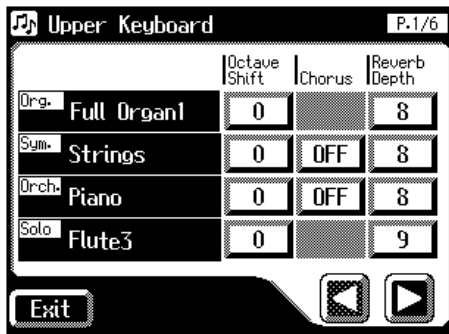

Indication	Description
ON	The Chorus effect will be applied to the voice.
OFF	The Chorus effect will not be applied to the voice.

- Touch <Exit>.

Sustain Effect

Sustain allows you to add a sustain effect or decay to each voice after the keys are released.

The Sustain effect can be added to the Upper (except the Solo part), Lower, and Pedal voices.

○AT-90S/80S

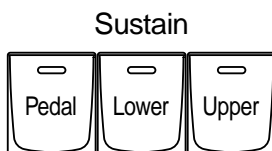

○AT-60S

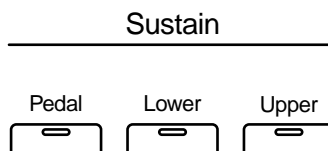

- Press the Sustain [Pedal] [Lower] [Upper] button for the keyboard to which you wish to apply Sustain (indicator lights).

The Sustain effect can be applied simultaneously to the voices of the Upper part (except the Solo part), Lower part, and Pedal Bass part.

NOTE

Some voices do not allow the Chorus effect to be applied. For details refer to “Voice List” (p. 193).

NOTE

The Sustain effect will not be applied to the Solo part voice.

MEMO

The length of Sustain can be modified independently for each keyboard (p. 121).

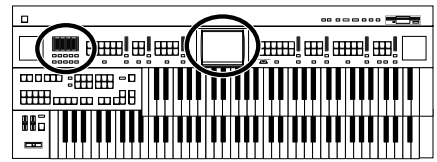

Reverb Effect

Reverb is an effect that adds a sense of spaciousness to the sound, creating the illusion of playing in a large or small concert hall, a large or small room, a small club, etc.

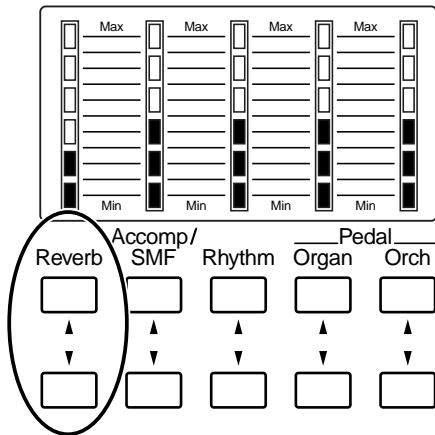

1. Press the Reverb [▲] or [▼] buttons to adjust the overall Reverb amount.

When you press the up button [▲], additional Reverb is applied. Pressing the down button [▼] decreases the Reverb level. If none of the Reverb indicators are lit, the Reverb effect will not be heard.

When you press the Reverb [▲][▼] buttons, the Part Balance Monitor screen appears. In the Part Balance Monitor screen you can check the reverb depth.

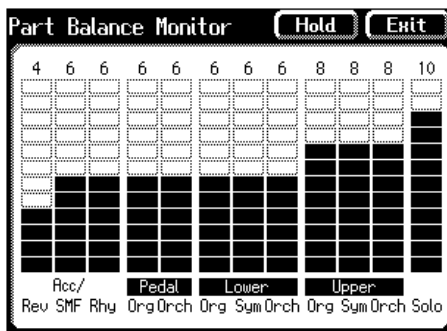

MEMO

You can change the type of reverb, the reverb depth for each part, and the wall type. For details refer to **Changing the Reverb Type** (p. 115), **Changing the Depth of the Reverb** (p. 117), and **Changing the Wall Type** (p. 116).

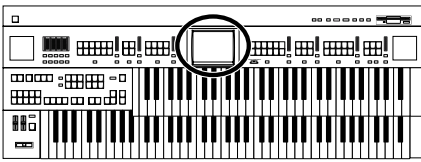

■ Changing the Reverb Type

By changing the reverberations of the notes, you can enjoy the atmosphere of performance in a wide variety of different locations. You can select from the following 11 types of Reverb.



Reverb (p. 114)

1. Touch <Sound/Kbd> on the Main screen.

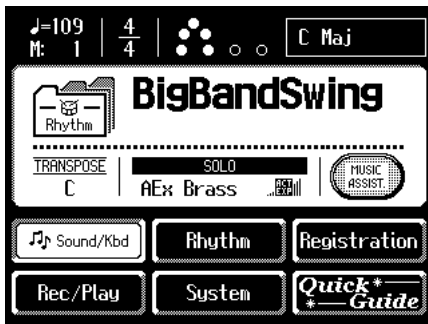

The sub-window appears.

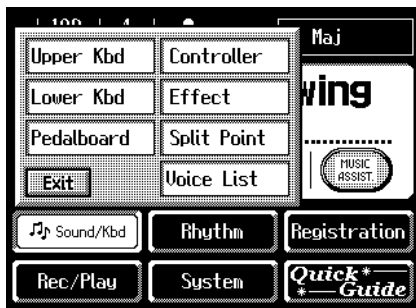

2. In the sub-window, touch <Effect>.

The Effect screen appears.

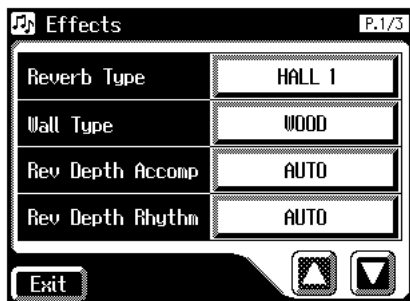

3. Touch <▲><▼> to display the Reverb Type.

4. Touch the value setting buttons for Reverb Type to adjust the setting.

The following screen appears.

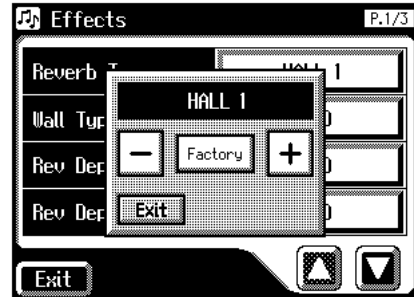

5. Touch <-><+> to edit the setting.

Display	Description
ROOM 1	Simulates the reverb of a conference room
ROOM 2	Simulates the reverb of a performance lounge
ROOM 3	Simulates the reverb of a large, open room
HALL 1	Simulates the reverb of a large concert hall
HALL 2	Simulates the reverb of a small concert hall
SMALL CHURCH	The reverberation of a small church
LARGE CHURCH	The reverberation of a large church
CATHEDRAL	The reverberation of a cathedral
PLATE	Applies a bright, metallic reverb
DELAY	An echo-like sound repeated several times
PAN DELAY	Similarly to the above but where the sound is panned between the left and right speakers

NOTE

It is not possible to modify the delay time (delay interval) when "DELAY" or "PAN DELAY" is selected.

6. Touch <Exit>.

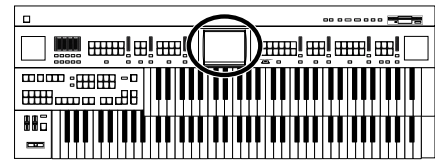

■ Changing the Wall Type

By changing the type of reverb (p. 115) you can experience the feeling of performing in various different locations, and by changing the Wall Type (wall material) you can make further adjustments to the way in which reverberation occurs.



Reverb (p. 114)

1. Touch <Sound/Kbd> on the Main screen.

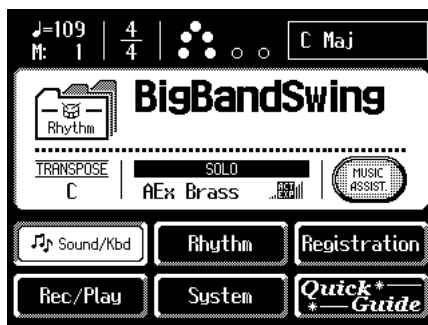

The sub-window appears.

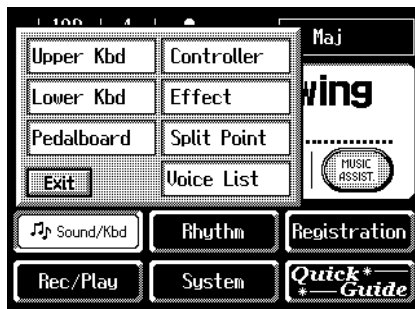

2. In the sub-window, touch <Effect>.

The Effect screen appears.

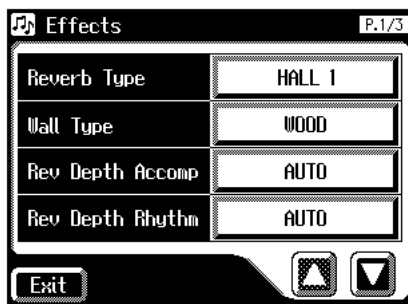

3. Touch <▲><▼> to display the Wall Type.

4. Touch the value setting buttons for Wall Type to adjust the setting.

The following screen appears.

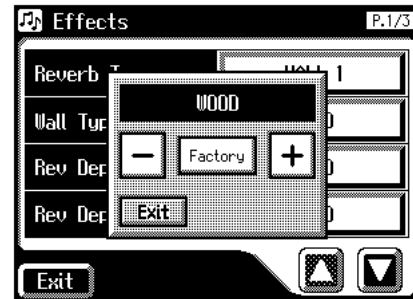

5. Touch <-><+> to change the setting.

Display	Description
DRAPERY	Pleated curtain
CARPET	Carpet
ACOUSTIC TILE	Acoustical tile, sound-absorptive tile
WOOD	Wood
BRICK	Brick
PLASTER	Plaster
CONCRETE BLOCK	Concrete block
MARBLE	Marble

6. Touch <Exit>.

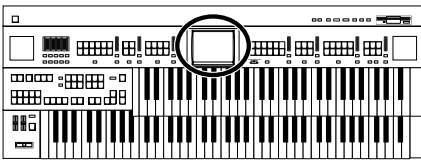

■ Changing the Depth of the Reverb

The depth of the Reverb can be set (0–10).



Reverb (p. 114)

To adjust the reverb depth for Upper/Lower/Pedal/Solo

1. Touch <Sound/Kbd> on the Main screen.



The sub-window appears.

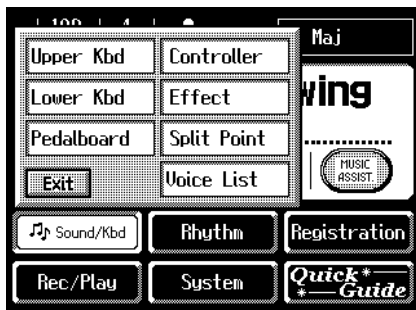

2. In the sub-window, touch <Upper Kbd>, <Lower Kbd>, or <Pedalboard>.

The Upper Keyboard screen, Lower Keyboard screen, or Pedalboard screen will be displayed.

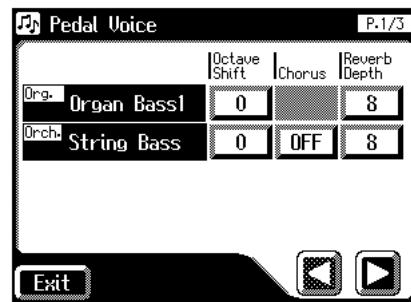
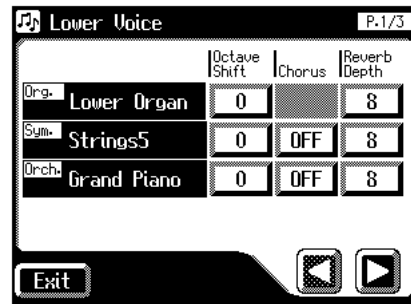
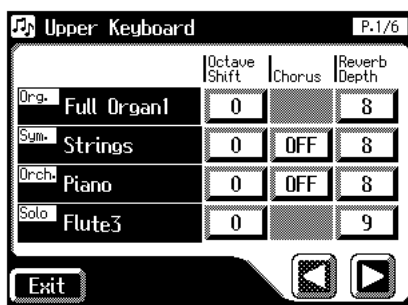

3. Touch <Left Arrow><Right Arrow> to display the Reverb Depth

4. Touch the part whose reverb depth you wish to adjust.

The following screen appears.

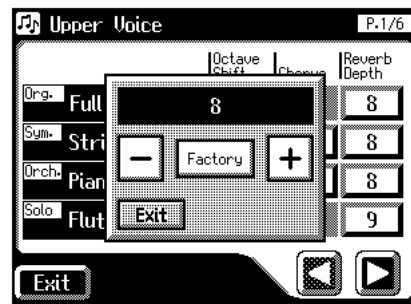

5. Touch <Minus><Plus> to adjust the setting.
Settings 0–10

6. Touch <Exit>.

Chapter 5 Applying Various Effects to the Sound

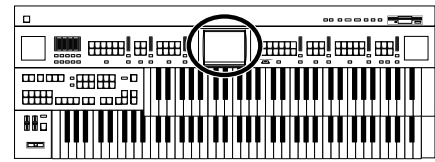

To adjust the reverb depth for something other than Upper/Lower/Pedal/Solo

1. Touch <Sound/Kbd> on the Main screen.

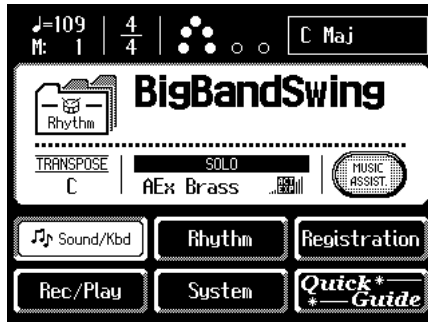

The sub-window appears.

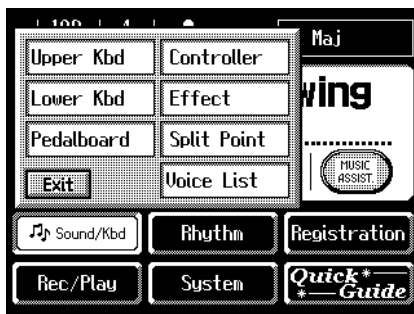

2. In the sub-window, touch <Effect>.

The Effect screen appears.

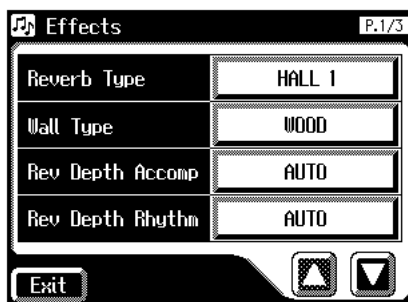

3. Touch <▲><▼> to display the Reverb Depth

4. Touch the part whose reverb depth you wish to adjust.

The following screen appears.

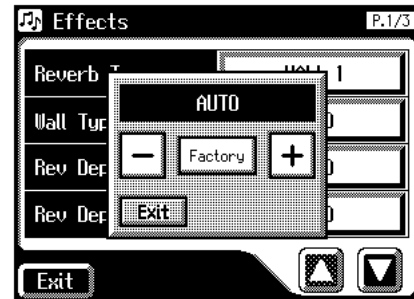

5. Touch <-><+> to adjust the setting.

Settings 0–10, AUTO (Accomp, Rhythm, A.Bass)

For the three Parts of the Accomp, Rhythm and Accompaniment Bass, you have the option of selecting the “AUTO” setting. Parts for which “AUTO” is selected will be set to the Reverb Depth that is most suitable for the Rhythm currently selected.

6. Touch <Exit>.

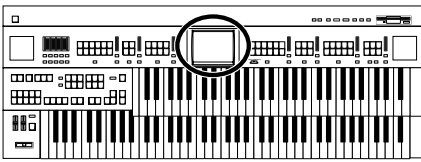

■ Rotary Speed

You can make fine adjustments to the speaker rotation speed of the rotary effect (p. 111).

1. Touch <Sound/Kbd> on the Main screen.

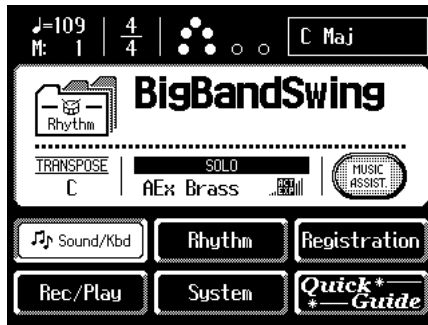

The sub-window appears.

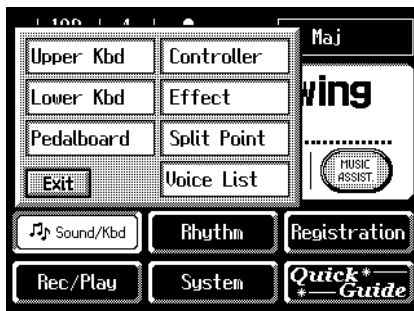

2. In the sub-window, touch <Effect>.

The Effect screen appears.

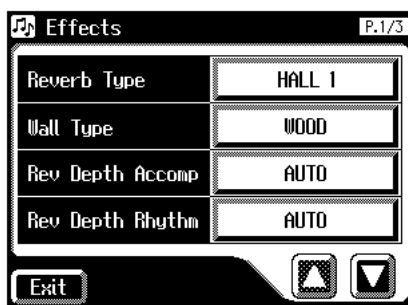

3. Touch <▲><▼> to display the Rotary Speed.

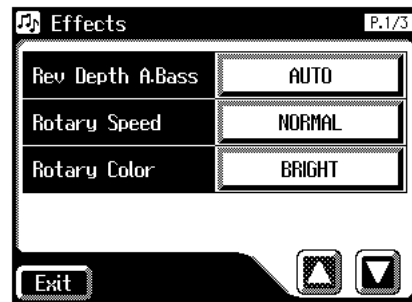

4. Touch the value setting buttons for Rotary Speed to adjust the setting.

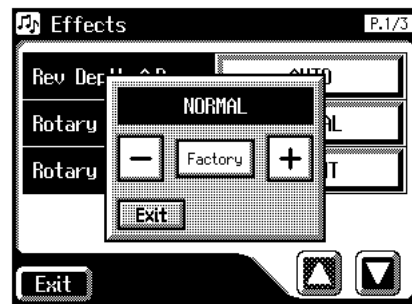

5. Touch <-><+> to edit the value.

Settings SLOW, NORMAL, FAST

6. Touch <Exit>.

MEMO

These settings remain stored in memory even while the power is off.

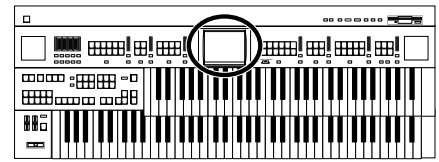

■ Rotary Color

This setting allows you to choose the brightness of the Rotary sound obtained when using the Rotary effect (p. 111).

1. Touch <Sound/Kbd> on the Main screen.

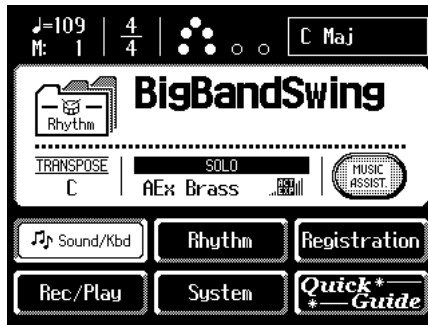

The sub-window appears.

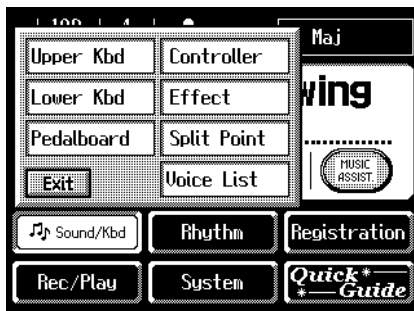

2. In the sub-window, touch <Effect>.

The Effect screen appears.

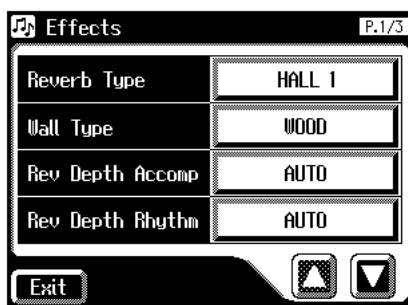

3. Touch <▲><▼> to display the Rotary Color.

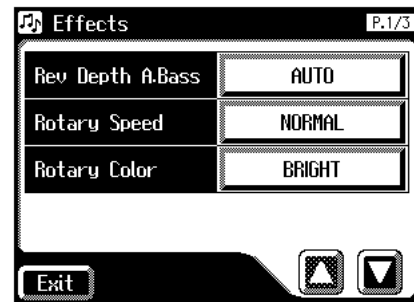

4. Touch the value setting buttons for Rotary Color to adjust the setting.

Each time you touch the Rotary Color setting, it will switch between “BRIGHT” and “MELOW.”

Settings **BRIGHT, MELOW**

5. Touch <Exit>.

MEMO

These settings remain stored in memory even while the power is off.

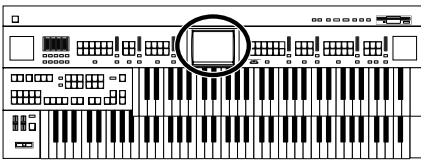

■ Changing the Sustain Length

The sustain length can be set independently (SHORT, MIDDLE (Medium) or LONG) for the Upper and Lower keyboards and Pedalboard. You can make a separate setting for each keyboard.



Sustain (p. 113)

1. Touch <Sound/Kbd> on the Main screen.

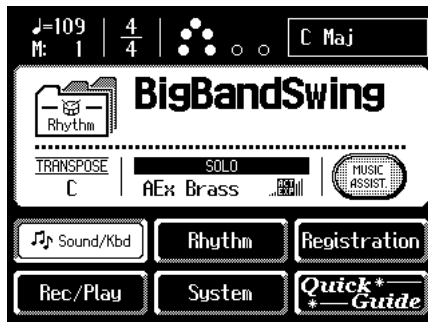

The sub-window appears.

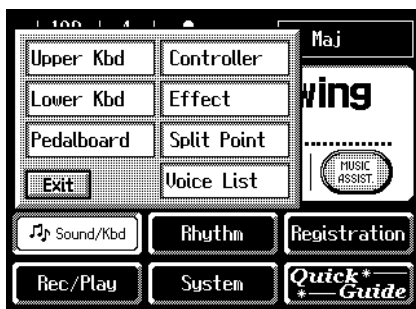

2. In the sub-window, touch either <Upper Kbd>, <Lower Kbd>, or <Pedalboard>.

Menu	Part whose sustain length you wish to change
Upper Kbd	To change the length of the Upper part.
Lower Kbd	To change the length of the Lower part.
Pedalboard	To change the length of the Pedal part.

3. Touch <Left Arrow><Right Arrow> to display the Sustain Length.

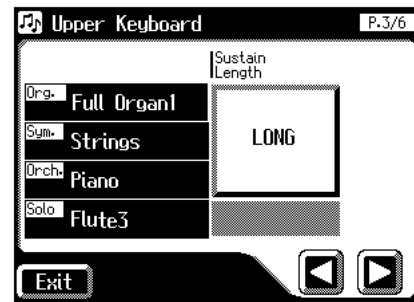

4. For the part whose sustain length you wish to adjust, touch the Sustain "SHORT/MIDDLE/ LONG" display.

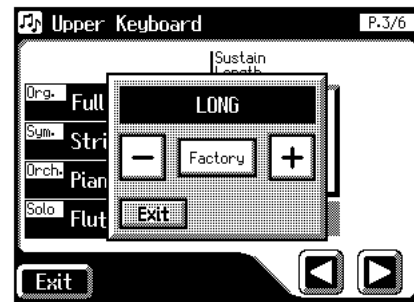

5. Touch <Left Arrow><Right Arrow> to change the value.
Settings SHORT, MIDDLE, LONG
6. Touch <Exit>.

Chapter 6 Using the Lower Keyboard Effectively

Making Effective Use of the Lower Keyboard

Since the lower keyboard of the AT-90S/80S/60S provides a generous 76 notes, you can use it to play piano pieces with ease. In addition, you can divide the keyboard into two or more sections and play solo voices, play the pedal bass voice, or combine a variety of uses for even more versatility.

For example, the following applications are possible.

Using the Lower Keyboard to Play the Solo Voice

- Press the Solo [To Lower] button in the Upper Solo section to Play the Solo voice to the Lower keyboard (p. 124).

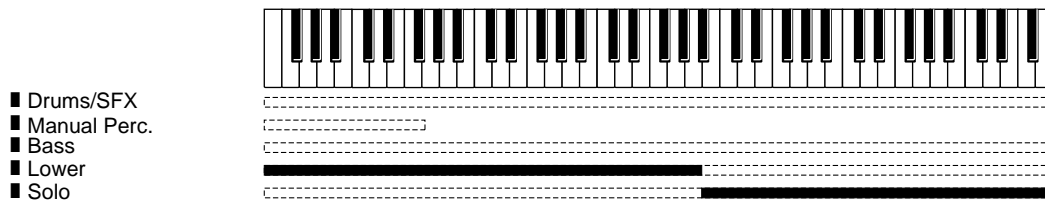

Using the Lower Keyboard to Play the Bass Part by Hand

- Press the [Bass Split] button in the Pedal section to play the Pedal Bass voice from the Lower keyboard (p. 125).

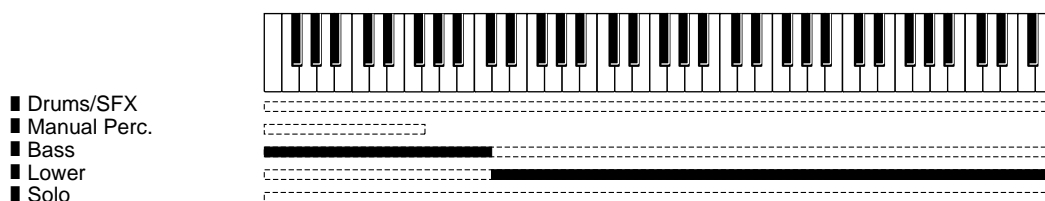

Using the Lower Keyboard to Play Drum Sounds or Sound Effects

- Press the [Manual Perc] button to play drum sounds or sound effects with the Lower voice on the lower keyboard (p. 126).

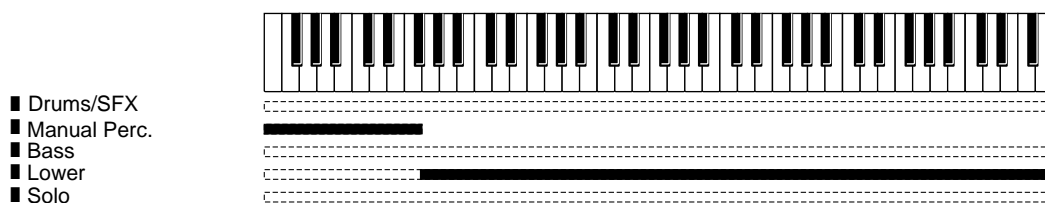

Playing Drum Sounds from the Entire Lower Keyboard

- Press the [Drums/SFX] button (p. 52).

- Drums/SFX
- Manual Perc.
- Bass
- Lower
- Solo

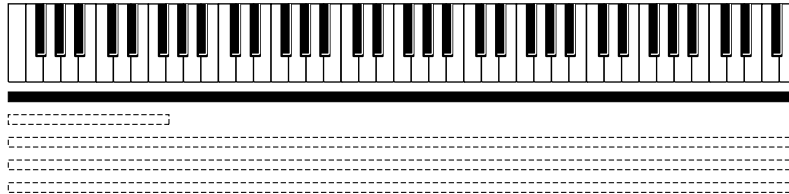

By changing the combination of voices that are played on the Lower keyboard, and by changing the Solo Split Point (p. 127) and Bass Split Point (p. 128), you can create the following types of setup.

- Drums/SFX
- Manual Perc.
- Bass
- Lower
- Solo

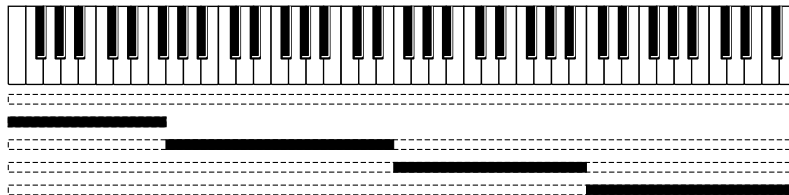

- Drums/SFX
- Manual Perc.
- Bass
- Lower
- Solo

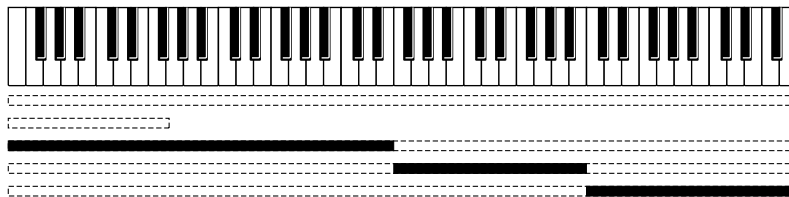

- Drums/SFX
- Manual Perc.
- Bass
- Lower
- Solo

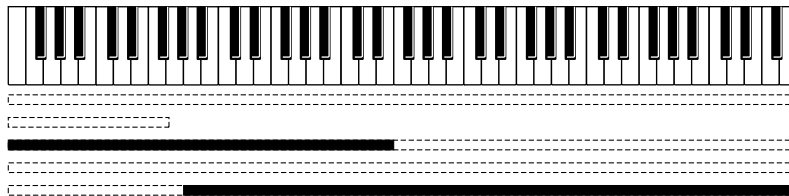

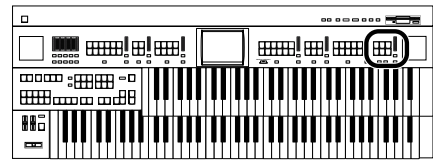

Playing the Solo Voice on the Lower Keyboard (Solo [To Lower] Button)

Normally, the solo voice will sound on the upper keyboard.

By using the Solo [To Lower] button, you can play the solo voice in the right-hand side of the lower keyboard that includes the B4 key. The state in which the keyboard is divided in this way is called “split,” and the location at which the keyboard is divided to play the solo voice in the lower keyboard is called the “Solo Split Point.”

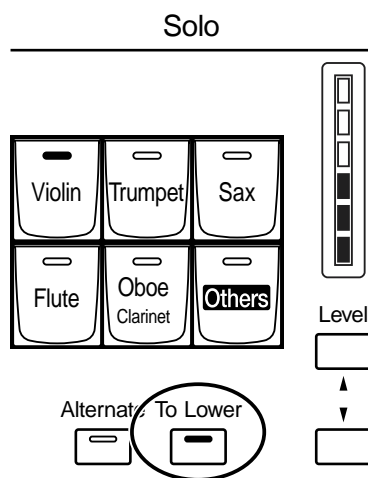

1. Select a Solo voice (p. 39).

2. Press the Solo [To Lower] button (indicator lights).

When you play the Lower keyboard, the Solo voice will sound in the range to the right of the Solo Split Point.

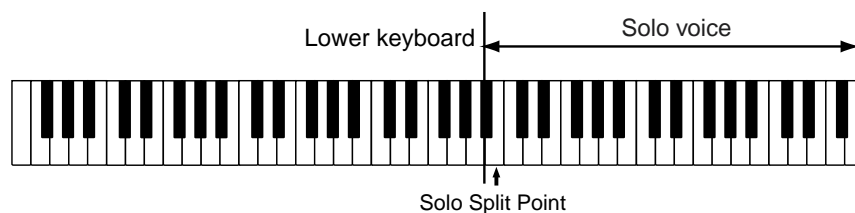

3. To turn off the Solo split, press the Solo [To Lower] button (indicator turns off).

The Solo voice will no longer sound in the Lower keyboard; the Solo voice will now be played in the Upper keyboard.



The solo split point is included in the right-hand zone.



You can adjust the Solo Split Point (p. 127).



You can change how the Solo voice will sound (p. 159).



You can layer the Solo voice with the Lower voice so that they will sound together (p. 159).

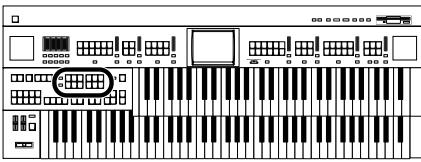

Using the Lower Keyboard to Play the Bass Voice ([Bass Split] Button)

By using the [Bass Split] button you can play the bass voice in the left-hand side (including C3) of the lower keyboard. The location at which the lower keyboard is divided in this way, to play the pedal bass voice, is called the “Bass Split Point.”

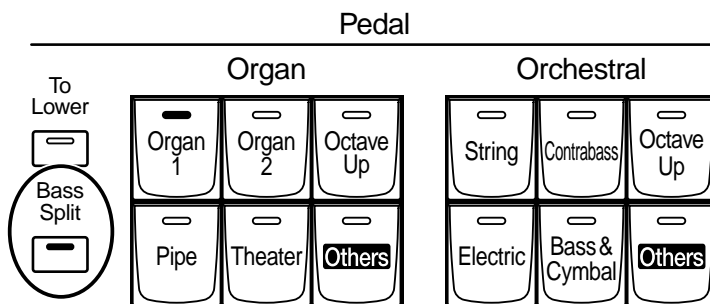

1. Select a Pedal Bass voice (p. 38).
2. Press the Pedal [Bass Split] button (indicator lights).

When you play the Lower keyboard, the Pedal Bass voice will sound in the range to the left of (and including) the C3 note.

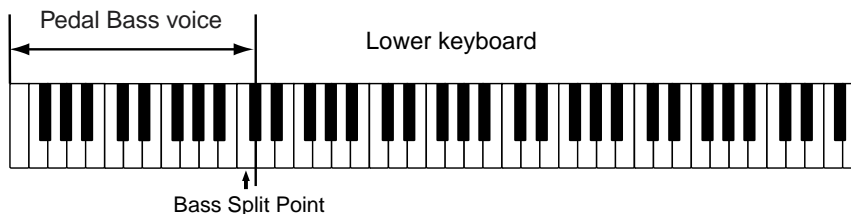

MEMO

The bass split point is included in the left-hand area of the keyboard.

MEMO

You can adjust the Bass Split Point (p. 128).

NOTE

It is not possible to select and play both [Bass Split] and Pedal [To Lower] buttons simultaneously.

NOTE

If the [Bass Split] is ON, the Pedal Bass voice will not be heard from the Pedalboard. The Pedal Bass voice will sound from the Lower keyboard.

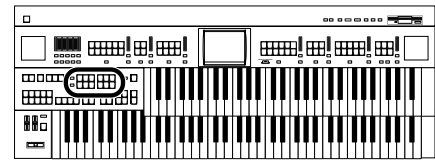

Using the Lower Keyboard to Play the Bass Voice ([To Lower] Button)

By using the Pedal [To Lower] button, you can sound the Pedal Bass voice by playing the root note (see p. 212) of a chord on the Lower keyboard in the area that is playing the Lower voice.

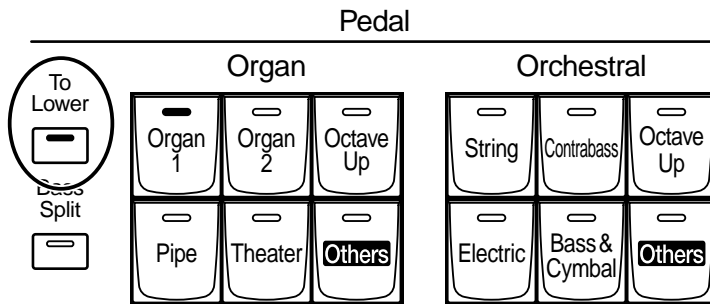

1. Select a Pedal Bass voice (p. 38).
2. Press the Pedal [To Lower] button (indicator lights).

When you play a chord in the area of the Lower keyboard that sounds the Lower voice, the Pedal Bass voice will also be heard and will play the root note.

If the “Leading Bass” function is on (p. 64), the lowest note played in the lower keyboard will sound the pedal bass voice.

NOTE

If no portion of the Lower keyboard is sounding the Lower voice (the [Drums/SFX] button is ON), the Pedal Bass voice will not sound.

NOTE

It is not possible to select and play both [Bass Split] and Pedal [To Lower] buttons simultaneously.

NOTE

If the Pedal [To Lower] is ON, the Pedal Bass voice will not be heard from the Pedalboard.

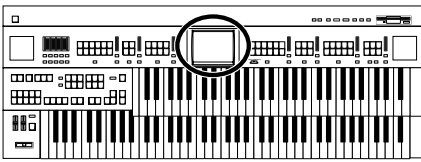

Changing the Split Point

■ Solo Split Point

This setting is used to determine the Solo Split Point (lower limit of the playable range of the Solo voice) on the Lower keyboard to any desired position.

1. Touch <Sound/Kbd> on the Main screen.

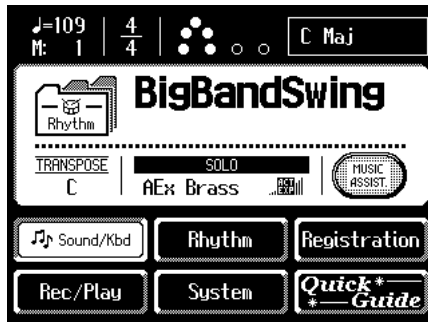

The sub-window appears.

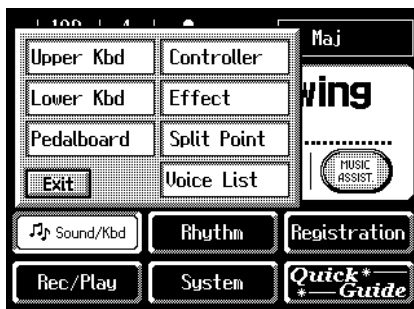

2. In the sub-window, touch <Split Point>.

The Split Point screen appears.

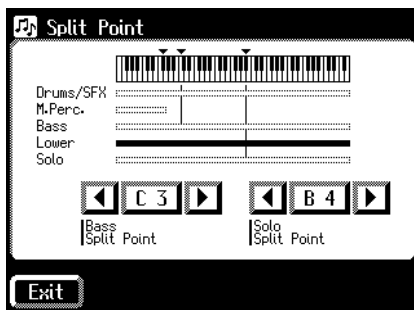

3. Touch <◀▶> to change the Solo Split Point.

Settings E1 to G7

4. Touch <Exit>.



You can also set the split point by pressing the key of the lower keyboard that you want to be the Solo Split Point.

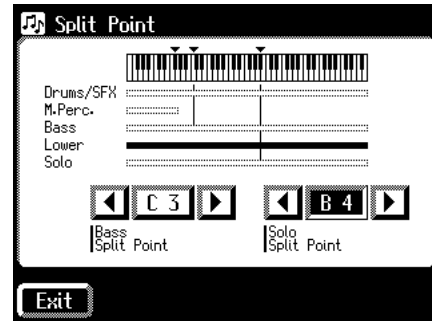

1. While touching the Solo Split Point value (E1–G7 indication) in the Split Point screen, press the key in the Lower keyboard that you want to specify as the Solo Split Point.

The Solo Split Point will be set in the Split Point screen.

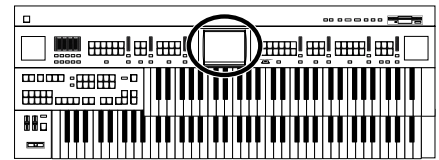

■ Bass Split Point

You can assign the Bass Split Point (the highest key up to which the Pedal Bass voice will sound), to any key of the Lower keyboard.

1. Touch <Sound/Kbd> on the Main screen.

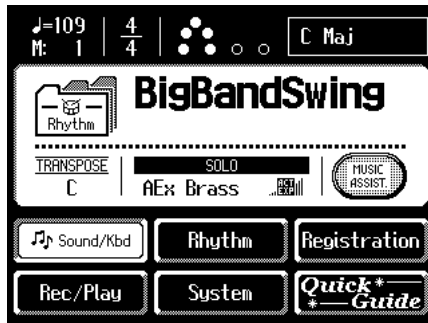

The sub-window appears.

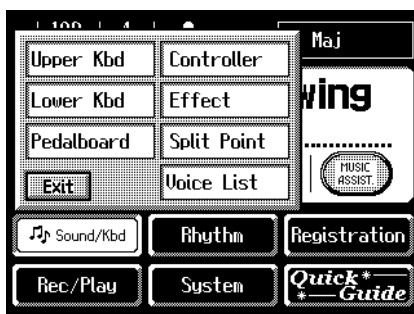

2. In the sub-window, touch <Split Point>.

The Split Point screen appears.

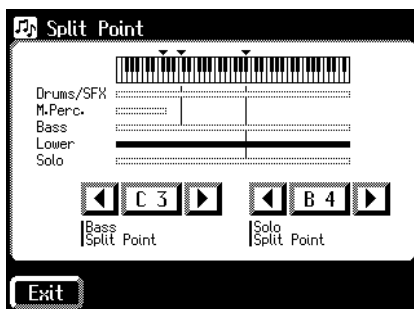

3. Touch <Left Arrow> <Right Arrow> to modify the Bass Split Point.

Settings **E1 to G7**

4. Touch <Exit>.



You can also set the bass split point by playing the desired key of the lower keyboard.

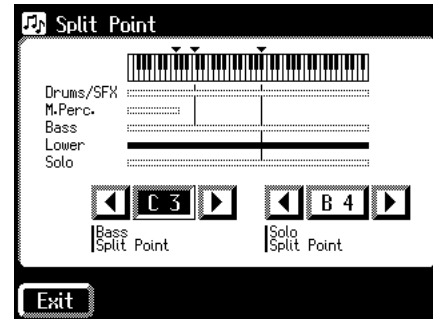

1. While touching the Bass Split Point value (E1–G7 indication) in the Split Point screen, press the key in the Lower keyboard that you want to specify as the Bass Split Point.

The bass split point will be set in the Split Point screen.

Chapter 7 Recording/Playing Back What You Play

The AT-90S/80S/60S's Composer allows you to record what you played on the instrument.

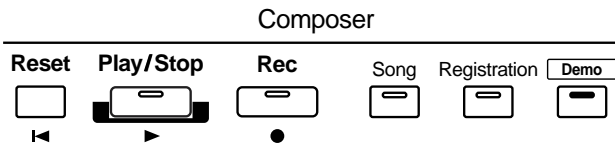

Before Recording/Playing Back What You Play

■ What is a Track Button?

The recorded performance will be automatically assigned to the seven Track buttons according to the recorded part. You can record or play back independently by specifying the desired Track button; for example, when you wish to re-record a track.

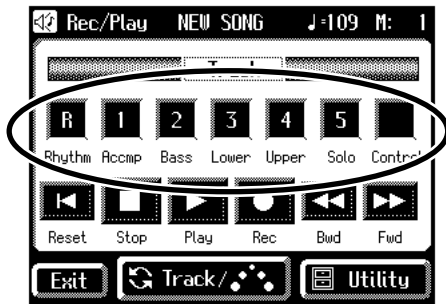

You can record different kinds of performance data into each track:

Track	Recorded performance
Rhythm	Rhythm performance, Drums/SFX, manual percussion
Accomp	Automatic Accompaniment (except Bass)
Bass	Pedal Bass Voice, Bass part of the Automatic Accompaniment
Lower	Lower Voice
Upper	Upper Voice
Solo	Solo Voice
Control	Panel operations, Expression Pedal operations



More information about the track assignments when playing commercial SMF music files, please refer to page 134.

During recording, the control track will store the operations as follows.

Recording panel operations (Voice selections, Tempo changes, Rotary fast/slow etc.)

Newly recorded performance data will be added without erasing the previously recorded data.



If you wish to erase all the recorded data and record new performance data, use the editing function "Erase" (erase performance data) to erase the data (p. 152).

Recording expression pedal operations

This will depend on the function of the expression pedal. Recording of expression operations will differ depending on the setting for "Exp. Src (Rec)."

Setting	Description
PEDAL	Expression pedal operations will be recorded. If expression data has already been recorded, the previously recorded data will be erased as the new data is recorded.
COMPOSER	Expression pedal operations will not be recorded. If expression data has already been recorded, the previously recorded data will remain without being erased.



For details refer to "Changing the Function of the Expression Pedal" (p. 162).

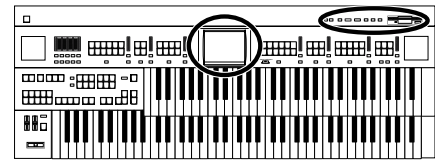

■ Displaying the Track Buttons

The track buttons will be displayed in the screen when you record or play back a performance.

1. Touch <Rec/Play> on the Main screen.

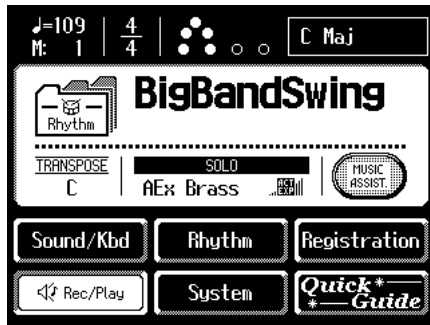

The Rec/Play screen appears.



In this screen you can record and play back your performance.

The following buttons are referred to as the track buttons.

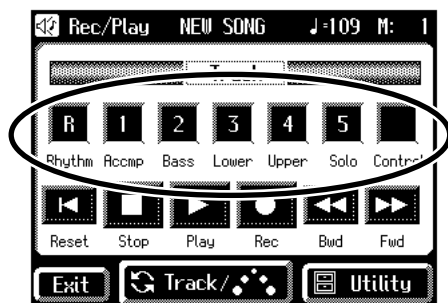

Playing Back Performance Songs Stored on Floppy Disk

In addition to playing back the music you recorded on the instrument and saved to a floppy disk, AT-90S/80S/60S also lets you enjoy a wide variety of commercially available song files, such as defined below.

SMF Music Files

The Standard MIDI File (SMF) format was designed to provide a means for exchanging performance data among a wide variety of devices. In addition to the song files described earlier, the AT-90S/80S/60S is also capable of playing back any Standard MIDI File compatible with the General MIDI 2 or GS formats.

Playing back all performance data

1. Hold the floppy disk with the label facing upwards, and push it into the disk drive until it clicks into place.



The disk drive is on the right side of the unit, above the keyboard.

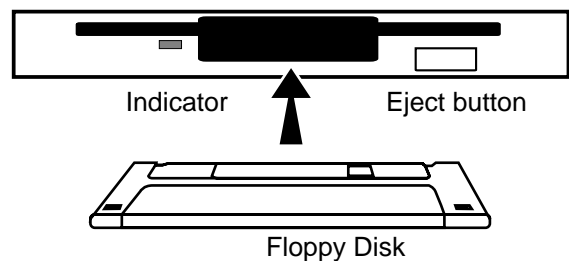

NOTE

Never eject a disk while reading or writing is in progress, since that can damage the magnetic surface of the disk, rendering it unusable. (The disk drive's indicator will light up at full brightness when the drive is busy reading or writing data. Ordinarily, the indicator will be less brightly lit, or be extinguished.)

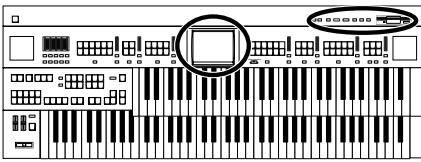

Chapter 7 Recording/Playing Back What You Play

When the performance song loaded from a disk is a Standard MIDI File, “SMF” will be displayed on the Main screen.

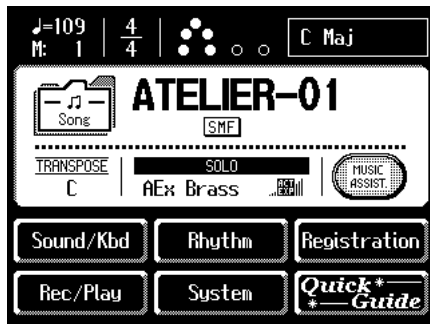

2. Press the [Demo] button.

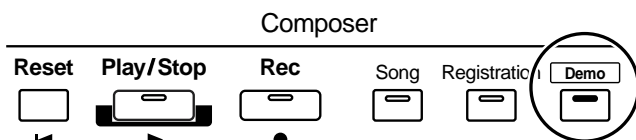

All performance data saved on the floppy disk will be played consecutively.

3. To stop playback, press the [Play/Stop] button.

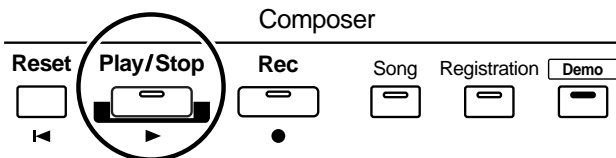

4. Press the Eject button.

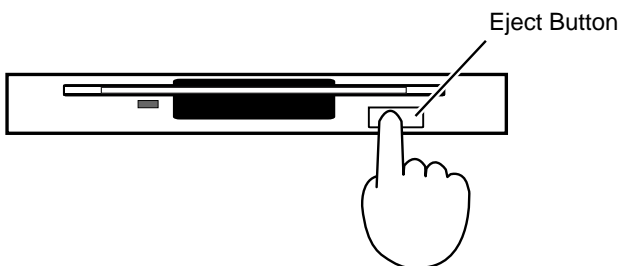

The floppy disk is ejected a little out of the slot. Gently grasp the end of the floppy disk and pull it out.

To play back only one song

1. Hold the floppy disk with the label facing upwards, and push it into the disk drive until it clicks into place.



The disk drive is on the right side of the unit, above the keyboard.

2. Press the [Song] button.

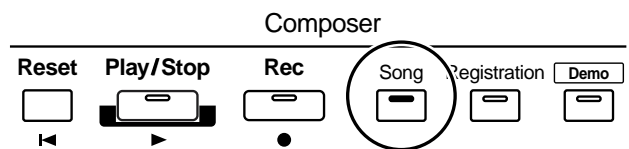

The Song Select screen appears.

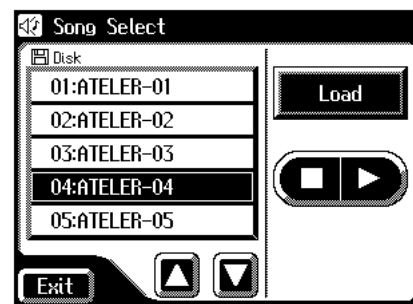

3. In the screen, touch <▲><▼> to select the song that you wish to play back.

4. Touch <▶> to play back the song.

5. Touch <■▶> to stop the song.



You can also play back or stop the music data by touching <Play> or <Stop> in the Rec/Play screen. By touching <Bwd> or <Fwd> you can rewind or fast-forward the performance.

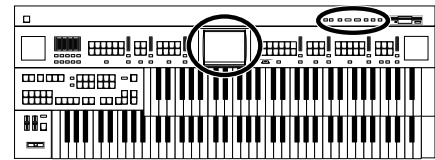

Recording a Performance

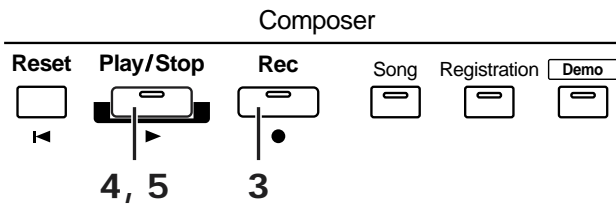

1. Select the panel settings needed for recording the performance.

2. Make sure that a floppy disk is not inserted in the disk drive.

If a floppy disk is in the disk drive, press the Eject button and remove the floppy disk.

3. Enter the recording standby mode by pressing the [Rec] button.

The [Rec] button indicator will light, and the [Play/Stop] button will blink.

4. Press the [Play/Stop] button to start recording.

When you press the [Play/Stop] button, the metronome will play two measures (bars) of count-in before recording begins.



If you wish to use Rhythm and Automatic Accompaniment as you record, press the [Start/Stop] button instead of the [Play/Stop] button to begin recording. Also, if the [Sync] button is lit (i.e., if Sync Start is ON), recording will begin the instant you play the Lower keyboard.

5. Press the [Play/Stop] button when you have completed your recording.

The Track indicator where a performance song is recorded will change from a flashing to a constant light.

When you press the [Intro/Ending] button (or [Start/Stop] button) while recording a Rhythm performance or Automatic Accompaniment, the Rhythm performance and Automatic Accompaniment will stop. However, the recording itself will continue. Press the [Play/Stop] button to stop recording.



You can also stop recording by pressing the Composer [Play/Stop] button.



The Play and Stop functions can both be assigned to one of the foot switches located on each side of the Expression Pedal (p. 145).



You can also choose to cancel the metronome count-in before recording starts (p. 145).

Caution

If you press the [Rec] button when a song has been selected from the floppy disk, the selected song will be completely loaded into the AT-90S/80S/60S and the Composer will enter into the recording standby mode. To record a new song, use the following procedure.

1. Press the [Rec] button to cancel recording standby.
2. Take the floppy disk out of the disk drive.
3. Delete the performance data.
4. Press the [Rec] button.

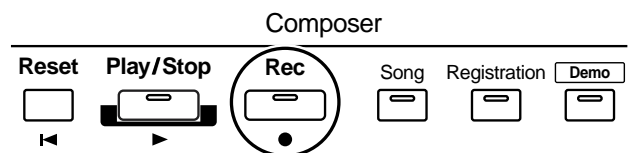

The following screen appears



When the instrument's memory is nearing capacity.



When recording was automatically canceled because the memory limit was reached.

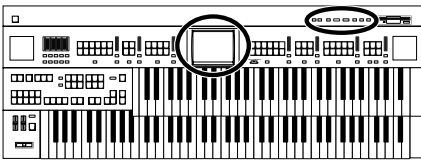

Playing Back a Performance Song

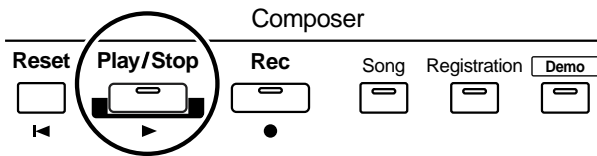

1. Touch <Rec/Play> on the Main screen.

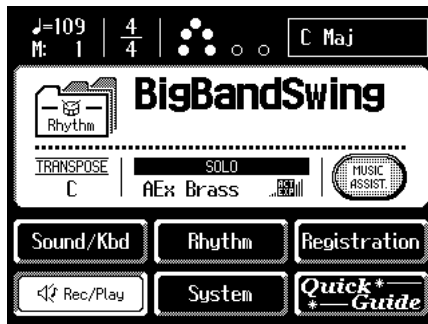

The Rec/Play screen appears.



2. Touch <Reset>.

The location at which playback will start will return to the beginning of measure 1.

If you wish to begin playback from the middle of the song, touch <Bwd> <Fwd> to move to the measure from which you wish to begin playback.

3. Touch <Play> to begin playback.

After playback reaches the end of the performance, it will stop automatically.



You can also begin playback by pressing the Composer [Play/Stop] button.

4. To stop playback at any point, touch the <Stop> button.



You can also stop playback by pressing the Composer [Play/Stop] button.



The Play and Stop functions can both be assigned to one of the foot switches located on each side of the Expression Pedal. (p. 160).



You can specify whether or not the Expression Pedal will affect the playback and what you play while Atelier music file is being played back (p. 162).

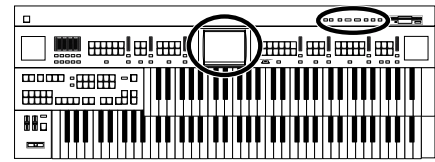

Silencing a Specific Track (Track Mute)

When the Rec/Play screen is displayed, the track button will light to indicate a track in which a performance has been recorded. By turning off these track buttons, you can temporarily silence the sound. This is referred to as “Track Mute.”

1. Touch <Song Select>.

The Song Select screen appears.

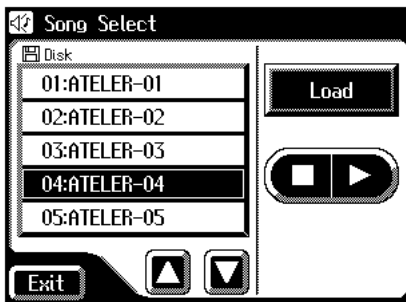

2. In the screen, touch <▲><▼> to select the song that you wish to play back.

NOTE

Do not touch <Load> at this time.

3. Touch <Exit> to display the Rec/Play Screen.



4. Press a track button that is lit, extinguishing the button.

When you play back the performance, track buttons that are not lighted will be muted (silenced).



5. Press the track button once again (button lights).

The part that had been muted will return to normal and will be heard.

Track Assignments When Playing Commercial SMF Music Files

When you playback without loading (p. 140) the SMF music files.

Track button	Channel
Rhythm [R]	10
Accomp [1]	1
Bass [2]	2
Lower [3]	3
Upper [4]	4
Solo [5]	5, 6, 7, 8, 9, 11, 12, 13, 14, 15, 16

When you first load and then playback the SMF music files.

Track button	Channel
Rhythm [R]	10
Accomp [1]	Performance data other than 2 and 10
Bass [2]	2
Lower [3]	Nothing (Performance data from the ATELIER series can be recorded)
Upper [4]	Nothing (Performance data from the ATELIER series can be recorded)
Solo [5]	Nothing (Performance data from the ATELIER series can be recorded)

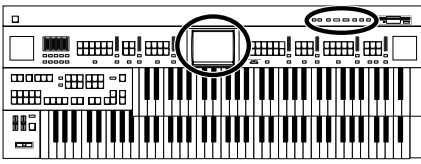

Recording Each Part Separately

In this method, each part (track button) is recorded one after another: first the Rhythm part, then the bass part, etc. If there are any previously recorded performances, you can listen to them as you record additional parts.

1. Select the panel settings needed for recording the performance.
2. Touch <Rec/Play> on the Main screen.

The Rec/Play screen appears.



3. Touch the <Bwd> and <Fwd> buttons to select the desired measure (bar) when you start recording.

If you wish to start recording from the beginning of the song, touch the <Reset> button.

4. In the Rec/Play screen, touch <Rec> to enter recording-standby mode.

<Play> and the unrecorded track buttons in the screen will blink. The track buttons that are already recorded will light.



Also, the panel Composer [Rec] button indicator will light, and [Play/Stop] button will blink.



You can also enter recording-standby mode by pressing the Composer [Rec] button.

5. In the Rec/Play screen, touch <Play> to begin recording.

When you touch <Play> in the Rec/Play screen, the metronome will sound a two-measure count, and then recording will begin.

As you listen to the performance song previously recorded, record the Part into a new Track.



You can also start recording by pressing the Composer [Play/Stop] button.

6. In the Rec/Play screen, touch <Stop> to stop recording.

The track button for which performance data has been recorded will be lit.



You can also stop recording by pressing the Composer [Play/Stop] button.

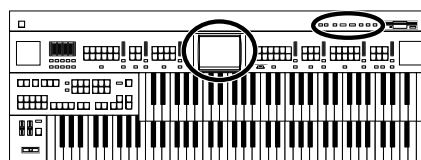

Re-Recording

If you made a mistake in your performance during recording etc., you can re-record just a portion of the musical data in the track.

NOTE

If you wish to re-record with different settings for voices, tempo, part balance, erase the recorded song (p. 137) and re-record again. If the Control track still contains data from before you re-recorded, the volume or sounds may change during playback.

1. Touch <Rec/Play> on the Main screen.

The Rec/Play screen appears.



2. Touch the <Bwd> and <Fwd> buttons to select the desired measure (bar) when you start recording.

If you wish to start recording from the beginning of the song, touch the <Reset> button.

3. In the Rec/Play screen, touch <Rec> to enter recording-standby mode.

<Play> and the unrecorded track buttons in the screen will blink. The button indicators of tracks that are already recorded will light.



Also, the panel Composer [Rec] button indicator will light, and [Play/Stop] button will blink.

MEMO

You can also enter recording-standby mode by pressing the Composer [Rec] button.

4. Touch the Track button which you wish to re-recording (button flashes).

The song data of the specified Track (with the exception of the Control Track) will be erased as new song data is recorded.

MEMO

When the Track button is lit constantly, no song data has been recorded on that Track.

5. In the Rec/Play screen, touch <Play> to begin recording.

The metronome will sound a two-measure count, and then recording will begin.

MEMO

You can also start recording by pressing the Composer [Play/Stop] button.

6. In the Rec/Play screen, touch <Stop> to stop recording.

The buttons of tracks which were re-recorded will change from flashing to being constantly lit.

MEMO

You can also stop playback by pressing the Composer [Play/Stop] button.

NOTE

If you wish to keep the existing Expression Pedal data, and record only the panel operations, you can make settings to prevent the operation of the Expression Pedal from being recorded (p. 162).

MEMO

You can use punch-in recording (p. 144) to re-record only the area that you specify.

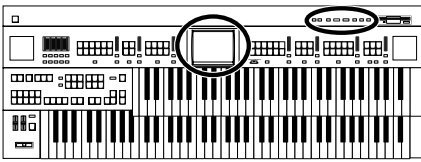

Erasing a Performance Song (Song Clear)

If you wish to discard your recording and re-record from the beginning, or if you wish to record a new performance, you must erase the previously-recorded data.

1. Touch <Rec/Play> on the Main screen.

The Rec/Play screen appears.



2. Touch <Utility>.

The Utility screen appears.

3. Touch <Song Clear>.

The following message, asking you to confirm your choice, will be displayed.

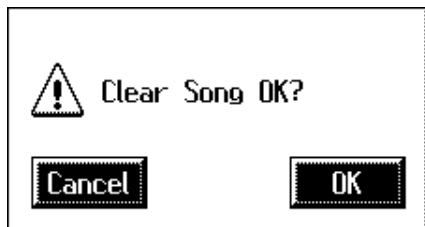

If you touch <Cancel>, the performance data will not be erased, and you will return to the Rec/Play screen.

4. If you touch <OK>, the performance data will be erased.

Changing the Name of a Performance Song (Rename)

A name is automatically assigned to a performance song that you record. However, at some point you may wish to change the name to something more meaningful.

1. Touch <Rec/Play> on the Main screen.

The Rec/Play screen appears.



2. Touch <Utility>.

The Utility screen appears.

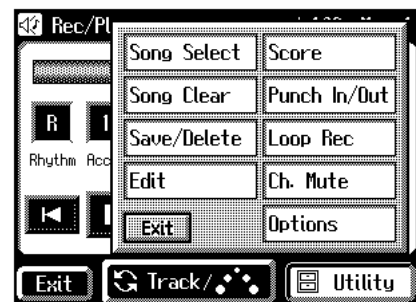

3. Touch <Save>.

The Song Save/Song Delete screen appears.



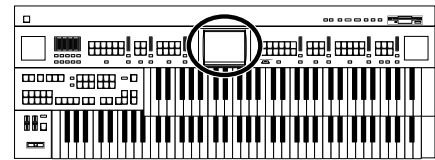

4. Touch <Utility> to open the Utility screen.

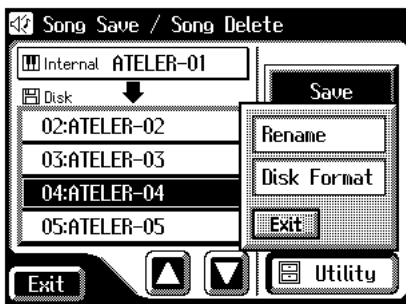

5. Touch <Rename>.

The Rename screen appears.

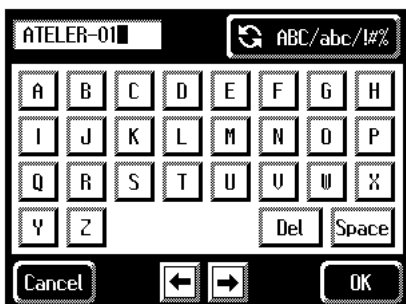

You can also access the Rename screen as follows.





1. Touch <Utility> on the Rec/Play screen.
The Utility screen appears.
2. In the Utility screen, touch <Edit>.
The Edit Menu screen appears.
3. Touch <Rename> on the Edit Menu screen.
The Rename screen appears.

6. Touch the character select button () to switch among uppercase/lowercase/symbols.

Touch the character select button repeatedly to cycle through the available choices, like this: uppercase → lowercase → symbols → uppercase...

7. Touch the screen to specify the desired character.

The following characters can be selected.

A B C D E F G H I J K L M N O P Q R S T U V W X Y Z	
a b c d e f g h i j k l m n o p q r s t u v w x y z	
! " # % & ' () * + , - . / : ; = ? ^ _ 0 1 2 3 4 5 6 7 8 9	
	Deletes a character.
	Inserts a space (blank).
 	Move the cursor (the symbol that indicates the location at which characters will be input) to left or right.

To cancel operation, touch <Cancel>.

8. When you're done making the settings, touch <OK>.

The new name is now inserted.



NOTE

You cannot directly change or edit the name of a performance song stored on a disk. The song must first be loaded (p. 140) into the instrument, edited, and then saved to disk again.

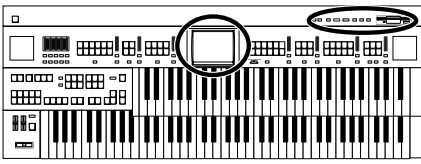

Saving Performance Songs Onto Floppy Disk

The performance data that you recorded will disappear when the power of the AT-90S/80S/60S is turned off. If you wish to keep the performance data, you can save it on a floppy disk.

If the performance data has never been saved to a floppy disk, a “**EDITED**” symbol appears on the Main screen. When the performance data is saved to a floppy disk, this symbol will no longer be displayed.

1. Make sure that the disk drive contains a disk that was formatted by the AT-90S/80S/60S.

2. Touch <Rec/Play> on the Main screen.
The Rec/Play screen appears.



3. Touch <Utility>.
The Utility screen appears.

4. Touch <Save/Delete>.
The Song Save/Song Delete screen appears.



5. Touch <▲><▼> to select the number of the save destination.

Numbers which have not been used in the saving operation will be displayed as “-----.”

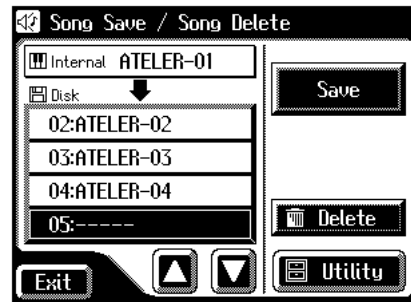

To cancel the Save operation, touch the <Exit> button to close the Song Save/Song Delete screen.

6. Touch <Save>.
The Save Format screen appears.

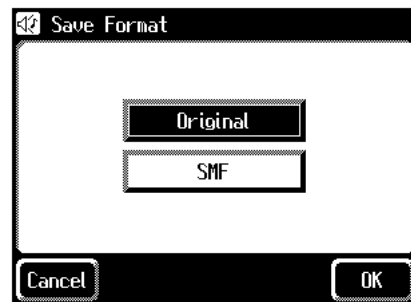

7. Touch the screen to select the format in which the data will be saved.

You can select either “ORIGINAL” or “SMF” format.

Display	Description
ORIGINAL	Save data in Atelier format
SMF	Save data in SMF format

8. Touch <OK> to finalize the save format.
Saving of the performance data will begin.

NOTE

Music files that was saved in Atelier format cannot be played back correctly on instruments other than the Atelier series.

NOTE

SMF data saved by the Atelier is saved in Format 1 for use with Atelier sound generators. For this reason, such data cannot be played back properly by the sound generator of an instrument that is not a member of the Atelier series.

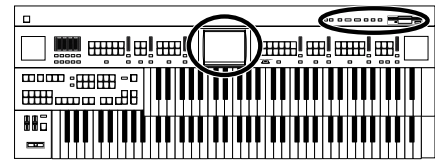

If the following screen appears

If you select a number at which performance data has already been saved and touch <Save>, the following screen appears.

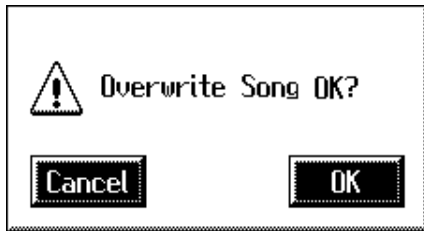

If you wish to update the contents of the performance data

1. Touch <OK>.

If you wish to save the data without erasing the performance data already on disk you must rename the song

1. Touch <Cancel> to stop the Save operation.
2. In the Song Save/Song Delete screen, select the number that is displayed as "-----" (a number that currently does not contain performance data).
3. Save the performance data.

When saving is complete, the saved performance name will be displayed.

What is the SMF Format?

SMF (Standard MIDI File) is a data format that was created to provide music files compatibility between manufacturers.

Loading Performance Songs Into the AT-90S/80S/60S

To edit (p. 149) or re-record a performance song that is stored on a floppy disk, you must first load that song into the instrument.

1. Insert the floppy disk into the disk drive.
2. Touch <Rec/Play> on the Main screen.
The Rec/Play screen appears.
3. Touch <Utility>.
The Utility screen appears.
4. Touch <Song Select>.
The Song Select screen appears.

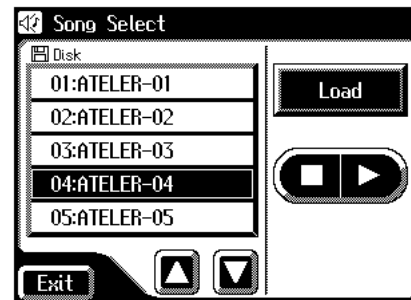

5. Touch <▲><▼> to select the performance data that you wish to load into internal memory.
6. Touch <Load>.

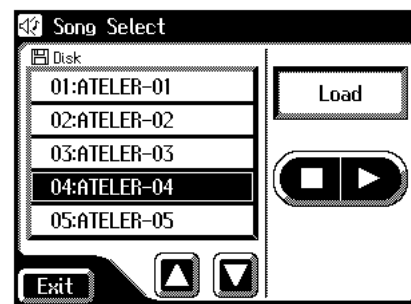

The selected performance data will be loaded into internal memory.

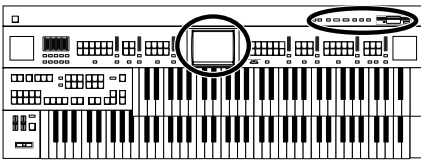

If the following screen appears

The message below is shown when the performance song in the unit has not been saved to disk.

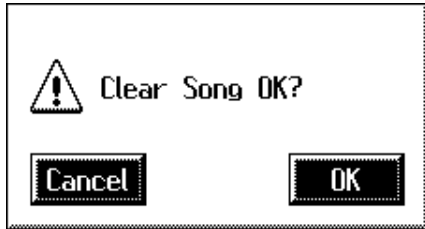

If you wish to erase the performance song

1. Touch the <OK> button.

If you wish to save the performance song on a floppy disk

1. Touch the <Cancel> button.

Save the song on a floppy disk (p. 139).

MEMO

If you load a song other than Atelier performance songs (SMF music files, etc.), the Rhythm (drum) Part will automatically be loaded into the Rhythm track, and the other Parts loaded into the Accompany and Bass tracks (p. 134).

If loading is canceled because the memory limit has been reached, the following message will be displayed:

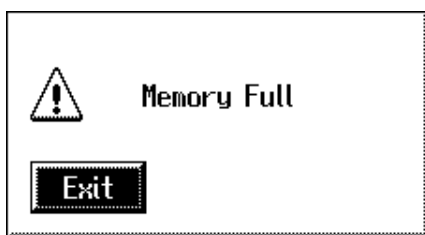

Layering a New Recording onto SMF Music Files

You can load commercially available SMF music files into the AT-90S/80S/60S, and record your own performance on top of it. During recording, the data you've loaded will be played back, while you record your performance.

1. Insert a floppy disk containing commercially available SMF music files into the floppy disk drive.
2. Touch <Rec/Play> on the Main screen.
The Rec/Play screen appears.
3. Touch <Utility>.
The Utility screen appears.
4. Touch <Song Select>.
The Song Select screen appears.

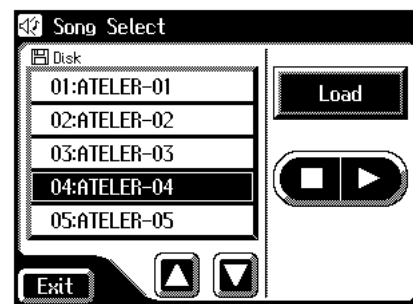

5. Touch <▲><▼> to select the performance data that you wish to load into internal memory.
6. Touch <Load> (load performance data).

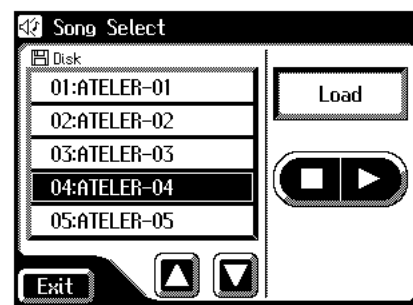

The selected performance data will be loaded into internal memory.

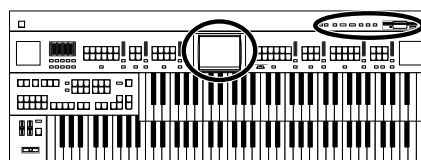

When SMF music file is loaded into the AT-90S/80S/60S, it will be stored in the following tracks.

Rhythm	The Rhythm performance (channel 10)
Bass	The Bass performance (channel 2)
Accomp	Performance data other than the Rhythm and Bass (except channels 2 and 10)

7. Select the panel settings needed for recording the performance.
8. Touch the <Bwd> button and <Fwd> button to move to the measure at which you wish to begin recording.
9. In the Rec/Play screen, touch <Rec> to enter recording-standby mode.

<Play> and unrecorded track buttons in the screen will blink. The button indicators of tracks that are already recorded will light.

Also, the panel Composer [Rec] button indicator will light, and the [Play/Stop] button will blink.

MEMO

You can also enter recording-standby mode by pressing the Composer [Rec] button.

10. In the Rec/Play screen, touch <Play> to begin recording.

As you record, the music file that was loaded into the AT-90S/80S/60S will play back.

11. In the Rec/Play screen, touch <Stop> to stop recording.

The track button for which performance data has been recorded will be lit.

MEMO

You can also start and stop recording by pressing the Composer [Play/Stop] button.

MEMO

The performance data you recorded can be saved on a floppy disk (p. 139).

NOTE

Commercially sold music files can also be loaded into the AT-90S/80S/60S, but for reasons of copyright protection, cannot be saved in SMF format.

Deleting Performance Songs Stored on Disk

You can delete a performance song that was saved onto a floppy disk.

1. Insert the floppy disk containing the performance data into the disk drive.
2. Touch <Rec/Play> on the Main screen.
The Rec/Play screen appears.
3. In the lower right of the screen, touch <Utility>.
The Utility screen appears.
4. Touch <Save/Delete>.
The Song Save/Song Delete screen appears.



5. Touch <▲><▼> to select the performance data that you wish to delete.
6. Touch <Delete>.
The confirmation message appears.



If you touch <Cancel> the performance data will not be deleted.

7. When you touch <OK> the performance data will be deleted.

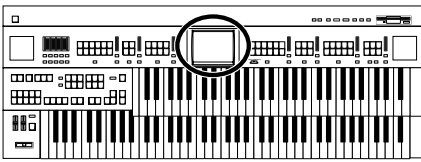

Re-Recording Part of Your Performance (Punch-in Recording)

After you have recorded a performance, you can re-record a specified portion of the performance.

With this method, you listen to the recorded performance, and re-record just the desired area. This recording method is called “Punch-in Recording.”

1. Touch <Rec/Play> on the Main screen.

The Rec/Play screen appears.

2. Touch <Utility>.

The Utility screen appears.

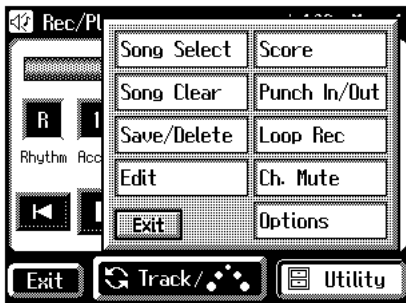

3. Touch <Punch In/Out>.

The Punch In/Out screen appears.

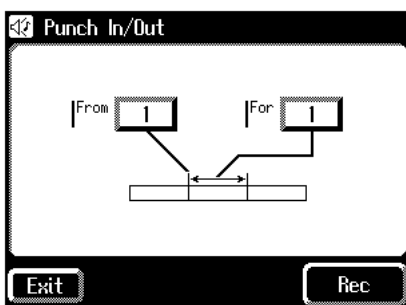

4. Touch the “From” value (the measure at which recording will begin).

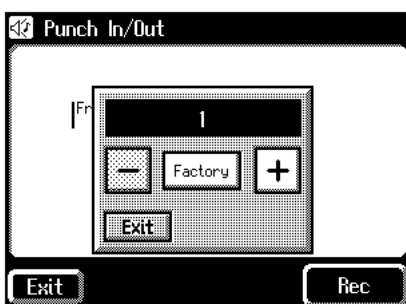

5. Touch <-><+> to specify “From” (the measure at which recording will begin).

6. Touch the “For” value (the number of measures that will be re-recorded).

7. Touch <-><+> to set “For” (the number of measures that will be re-recorded).

8. Touch <Rec>.

The Rec/Play screen appears, and the unit is placed in recording standby.

9. Press the Track button which you wish to re-record (indicator flashes).

10. Touch <Play> to begin recording.

When you touch the <Play> button, the metronome will play two measures (bars) of count-in before recording begins.

When you reach the first measure of the specified area, recording will begin. When the specified area ends, recording will end, and playback will resume.

While the song is playing back or recording, the Composer [Rec] button’s indicator will be lit as follows.

While the performance is playing back	The Composer [Rec] button’s indicator will flash
While you are re-recording	The Composer [Rec] button’s indicator will light constantly

When recording has ended for the specified area and the data is once again playing back, the [Rec] button’s indicator will resume flashing.

11. Touch <Stop> to stop the recording.

The indicator of the track button which recorded the performance will light.

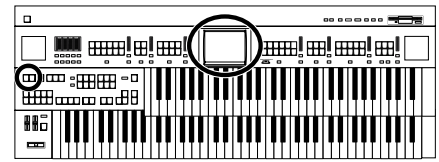

Recording and Layering Drum Parts (Loop Recording)

You can repeatedly record over a specified region of the rhythm part, adding additional notes at each pass. This type of recording is called “Loop Recording.”

This recording method is convenient when you wish to layer drum sounds individually for the Rhythm part.

NOTE

“Loop Recording” can be used only when recording the Rhythm part.

1. Press the [Drums/SFX] button or the [Manual Perc] button to select a Drum Set or Sound Effect Set (p. 52–p. 55).
2. Touch <Rec/Play> on the Main screen.
The Rec/Play screen appears.
3. Touch the <Bwd> and <Fwd> on the Rec/Play screen, move to the measure where you wish to start Loop Recording.
4. Touch <Utility>.
The Utility screen appears.

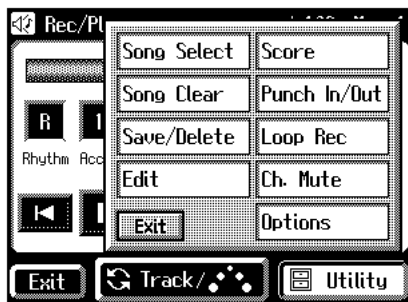

5. Touch <Loop Rec>.

The Loop Rec screen appears.

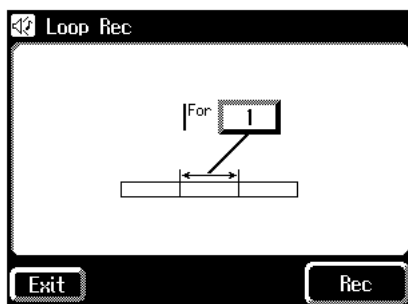

6. Touch the “For” value (the number of measures that will be recorded repeatedly).

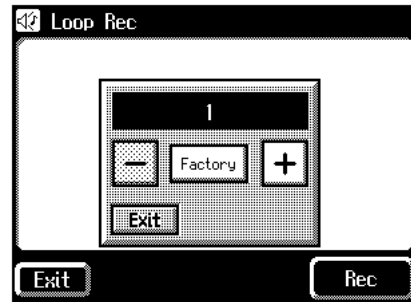

7. Touch <-> <+> to specify the “For” value (the number of measures that will be recorded repeatedly).
8. Touch <Rec>.
The Rec/Play screen appears, and the unit is placed in recording standby.
9. Touch <Play> to begin recording.
When you touch the <Play> button, the metronome will play two measures (bars) of count-in before recording begins.
You can record repeatedly over the specified range of measures, adding additional notes at each pass.
10. Touch <Stop> to stop playback.
The indicator of the Rhythm track button which recorded the performance will light.

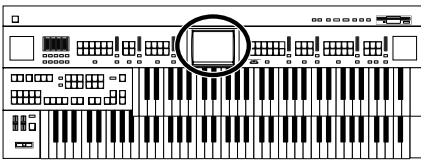

Count-In Recording

This setting (ON/OFF) determines whether or not a metronome count-in (2 measures) will be heard after pressing the [Play/Stop] button on recording.

1. Touch <Rec/Play> on the Main screen.

The Rec/Play screen appears.



2. Touch <Utility>.

The Utility screen appears.

3. Touch <Options>.

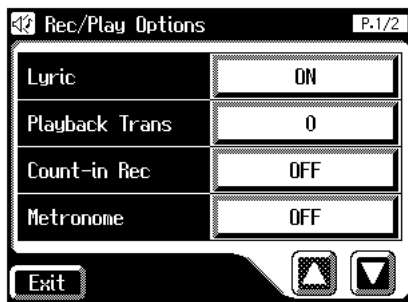

4. Touch the Count-In Rec setting (ON/OFF) to switch it between “ON/OFF.”

Each time you touch the Count-In Rec setting, it will alternate between ON/OFF.

Setting	Description
ON	A two-measure count will sound before recording
OFF	No count will sound before recording

5. Touch <Exit>.

Viewing a Musical Score

1. Touch <Rec/Play> on the Main Screen

The Rec/Play screen appears.



2. Touch <Utility>.

The Utility screen appears.

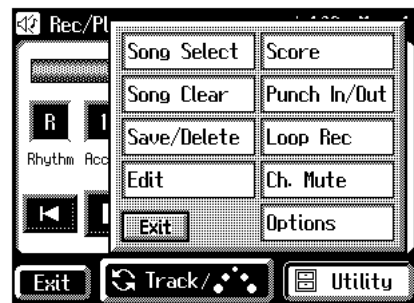

3. Touch <Song Select>.

The Song Select screen appears.

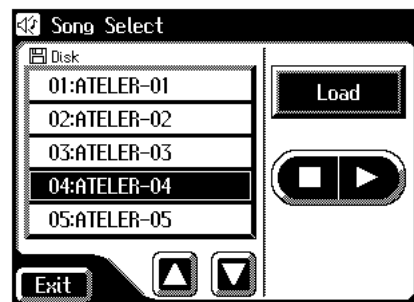

4. Touch <▲><▼> to select the song that you want to play back.

5. Touch <Load>.

6. Touch <Exit>.

7. Touch <Utility> in the Rec/Play screen.

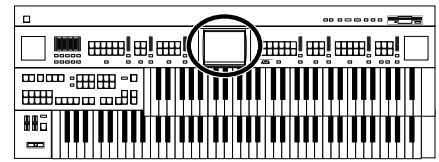

8. Touch <Score>.

The Score screen appears.

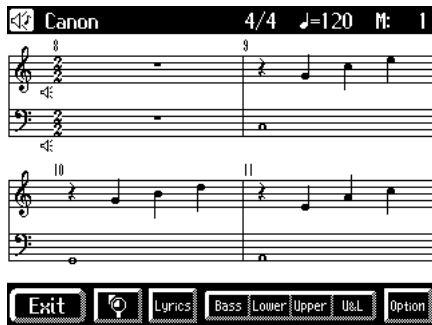

Display	Explanation
	Enlarge the score display
	Display lyrics in the score.
	Display the Pedal part score.
	Display the Lower part score.
	Display the Upper part score.
	Display the Upper part and Lower part scores.
	You can change the part that is displayed, and change the way in which the score is displayed (p. 146).

MEMO

Touching the illustration of speaker on screen, you can mute the part.

■ Changing the Score Settings

1. Touch <Rec/Play> on the Main Screen

The Rec/Play screen appears.

2. Touch <Utility>.

The Utility screen appears.

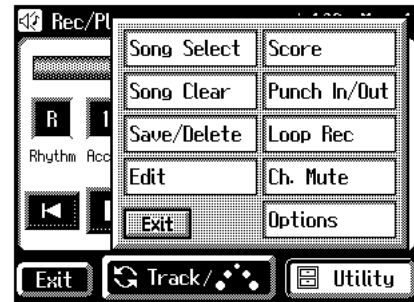

3. Touch <Score>.

The Score screen appears.

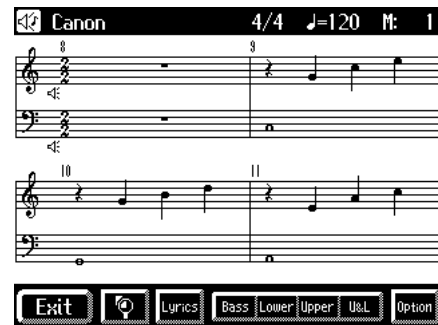

4. Touch <Options>.

The Score Options screen appears.

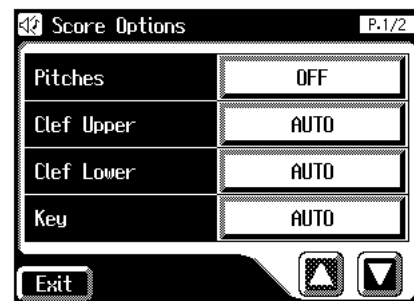

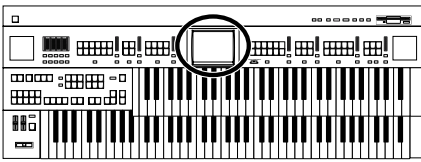

Chapter 7 Recording/Playing Back What You Play

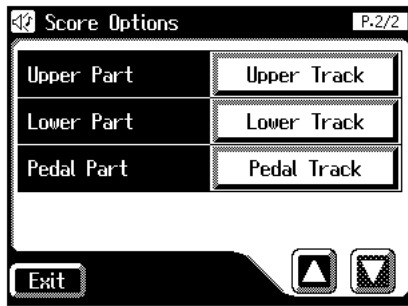

5. Touch the button for the item whose setting you want to change.

Menu	Setting	Explanation
Pitch	C,D,E	Letter names (fixed do) are display in the detailed score.
	Do,Re,Mi	Solmization syllables (movable do) are displayed in the detailed score.
	OFF	Not displayed
Clef Lower	AUTO	Changes automatically.
	G Clef	Displayed the G-clef staff of the lower part.
	F Clef	Displayed the F-clef staff of the lower part.
Clef Upper	AUTO	Changes automatically.
	G Clef	Displayed the G-clef staff of the upper part.
	F Clef	Displayed the F-clef staff of the upper part.
Key	AUTO	Display automatically.
	Db, Ab, Eb, Bb, F, C, G, D, A, E, B, F#, Bbm, Fm, Cm, Gm, Dm, Am, Em, Bm, F#m, C#m, G#, D#m	Display the score in the selected key.
Lower	Lower Track	Select the part to be displayed as the lower part. The power-up default is "Lower Track."
	1-16	

Menu	Setting	Explanation
Upper	Upper Track	Select the part to be displayed as the upper part. The power-up default is "Upper Track."
	1-16	
Pedal	Pedal Track	Select the part to be displayed as the pedal part. The power-up default is "Pedal Track."
	1-16	

6. Touch <[-]><[+]> to change the setting.



When you touch <Key>, the following screen appears.

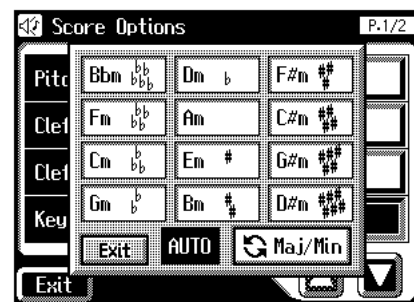
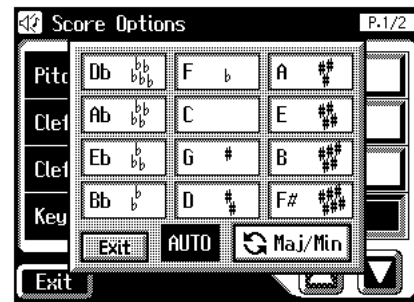

7. Touch <Exit>.

Chapter 7 Recording/Playing Back What You Play

Some notes on a Score screen

- When you start playback of music files, the marks  appears. While this appears on the score, the AT-90S/80S/60S is reading data from the floppy disk and making the score. Please wait until reading of the data is complete.
- In the Score screen, some lyrics or notes could extend beyond the edges of the screen, and not be displayed.
- The scores that are presented by the display are produced based on the music files. Viewing ease is given priority over precise expression when dealing with complex, high-level music. Because of this, you may find that the score shown in the display does not match what is provided on commercially available sheet music. The score display feature is particularly unsuitable for the display of difficult, complex musical works that demand accurate notation. In addition, the display cannot show notes that are briefer than a sixteenth note.
- If you select a part that does not contain performance data, notes will not be displayed in the score. Use <Options> to change the part that is displayed.
- If you use the buttons located below the display to change the displayed part while the song is playing, the song may be played back from the beginning.
- If you are playing data that contains lyrics data and the lyrics are not displayed even though you press <Lyric>, the lyrics display setting is turned "OFF" (p. 167).

Chapter 8 Editing Your Musical Performance Data

Song files that you record can be edited using five different functions.

The following editing functions are provided.

Menu	Descriptions
Delete Measure	Deleting a Specific Measure (p. 149).
Delete Track	Delete the Recording from a Track (p. 150).
Erase Event	Erase Recording (p. 152).
Copy	Copying Measures (p. 154).
Quantize	Correct Timing Inaccuracies (p. 155).
Rename	Change the name of the performance data (p. 137).

NOTE

Once you edit data, it cannot be restored to its original condition. As a precaution against accidents, we recommend that you save your song to a floppy disk before you edit it (p. 139).

Deleting a Specific Measure (Delete Measure)

You can delete a portion of the performance data. This function lets you delete specified measures (bars) of the song from all tracks. When any part of the song file is deleted, subsequent recording will be moved forward to fill the gap.

Example: To delete measures (bars) 5–8

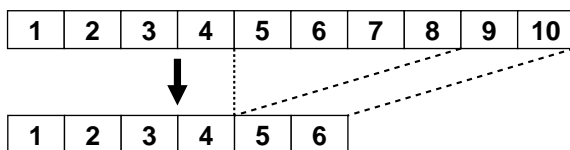

1. Touch <Rec/Play> on the Main screen.

The Rec/Play screen appears.

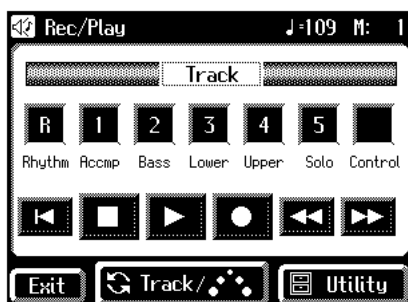

2. In the Rec/Play screen, touch <Utility> to open the Utility screen.

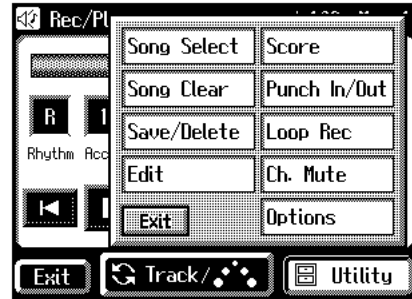

3. In the Utility screen, touch <Edit>.

The Edit Menu screen appears.

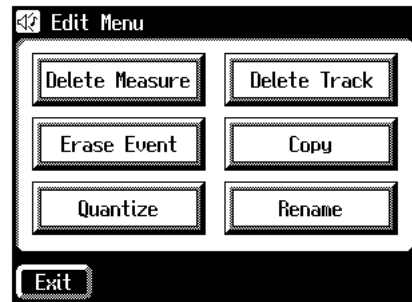

4. Touch <Delete Measure>.

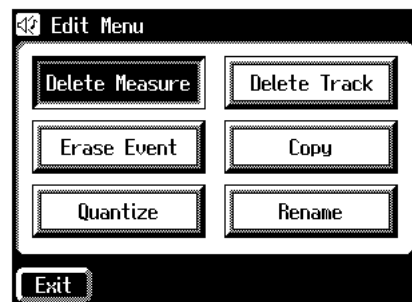

The Delete Measure screen appears.

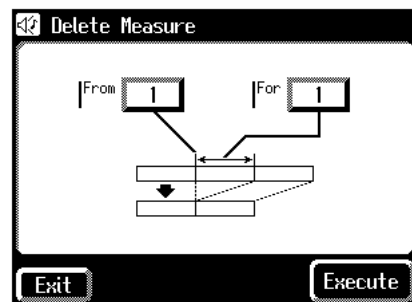

5. Touch the "From" value (the first measure that you wish to delete).

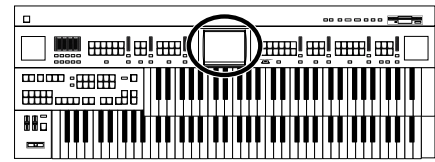

6. Touch **<->** **<+>** to set “From” (the first measure that you wish to delete).

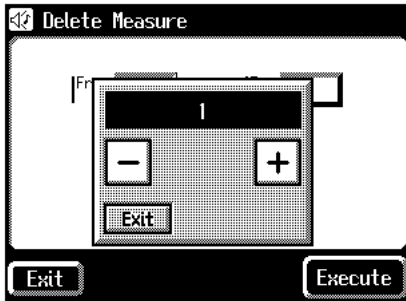

7. When you’re done making the settings, touch **<Exit>**.
8. Touch the “For” value (the number of measures that you wish to delete).
9. Touch **<->** **<+>** to set “For” (the number of measures that you wish to delete).
To delete to the last measure, select “ALL.”
10. When you’re done making the settings, touch **<Exit>**.
11. Touch **<Execute>**.

The following display appears.

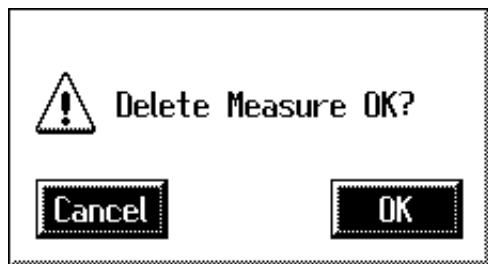

To cancel operation, touch **<Cancel>**.

12. Touch **<OK>** to delete the measures.
When deletion has been completed, you are returned to the Edit Menu screen.

Delete the Recording from a Track (Delete Track)

This function lets you delete the recording from a track that you specify.

What is a track?

The AT-90S/80S/60S has seven tracks. These tracks record the following performance data.



About tracks and track buttons (p. 129)

Track	Recorded performance
Rhythm	Rhythm performance, Drum/SFX, Manual percussion
Accomp	Automatic Accompaniment (except Bass and Rhythm performance), SMF music files (except Bass and Rhythm performance)
Bass	Pedal Bass voice, Bass part of the Automatic Accompaniment, Bass part of the SMF music files
Lower	Lower Voice
Upper	Upper Voice
Solo	Solo Voice
Control	Panel operations (ex.: switching the buttons), Expression pedal operations, Part Balance Volume

SMF music files (except for data that was saved by the ATELIER series) stores the Rhythm track in channel 10, and the remaining musical data in the Accomp and Bass tracks.

1. Touch **<Rec/Play>** on the Main screen.

The Rec/Play screen appears.

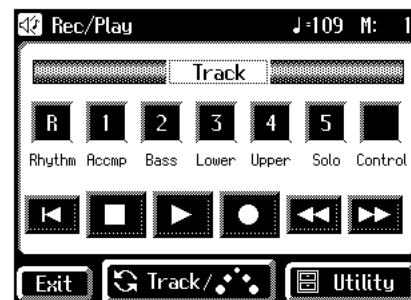

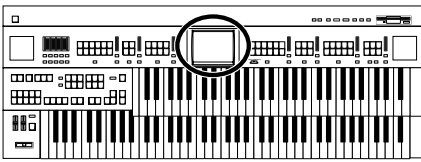

Chapter 8 Editing Your Musical Performance Data

- In the Rec/Play screen, touch <Utility> to open the Utility screen.

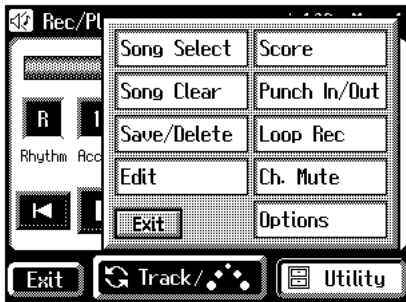

- In the Utility screen, touch <Edit>. The Edit Menu screen appears.

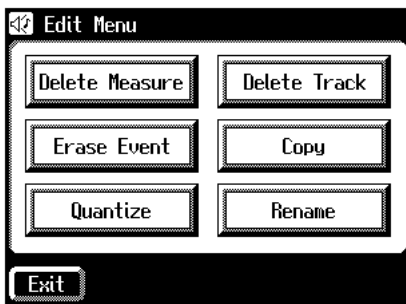

- Touch <Delete Track>.

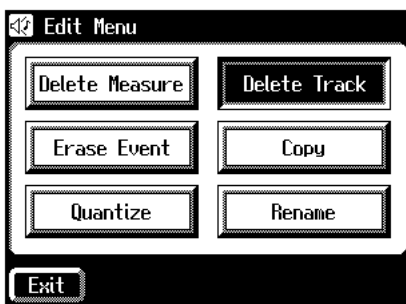

The Delete Track (delete the performance data of a track) screen appears.

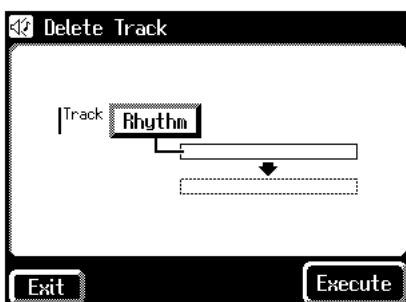

- Touch the “Track” value (the track whose performance data you wish to delete).
- Touch <-><+> to select the “Track” (the track whose performance data you wish to delete).

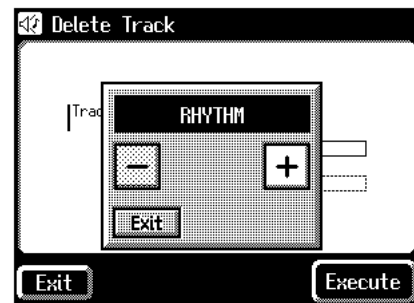

Settings: RHYTHM, ACCOMP, BASS, LOWER, UPPER, SOLO, CONTROL

- When you’re done making the settings, touch <Exit>.
- Touch <Execute>.

The following display appears.



To cancel operation, touch <Cancel>.

- Touch <OK> to delete the performance data. When the recording has been deleted, the Edit Menu screen will reappear.

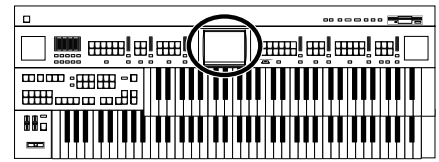

Erase Recording (Erase Event)

You can erase a specified portion of the performance in a specified area without making the song shorter. This is called the “Erase” function.

As an alternative to the method of erasing all performance data in a specified area, you can erase the following contents of the performance.

ALL	All recording
NOTE	Notes played on the keyboard
CONTROL	Panel operations, Part Balance Volume
EXPRESSION	Expression pedal recording
VOICE	Voice settings
TEMPO	Tempo setting

Example: Erasing measures (bars) 5–8

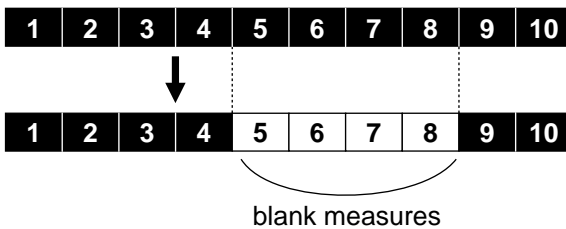

1. Touch <Rec/Play> on the Main screen.

The Rec/Play screen appears.

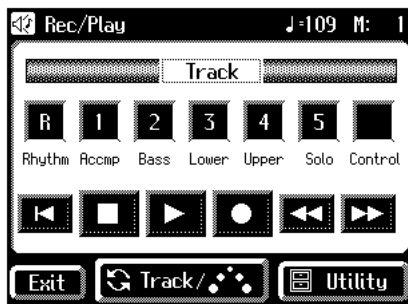

2. In the Rec/Play screen, touch <Utility> to open the Utility screen.

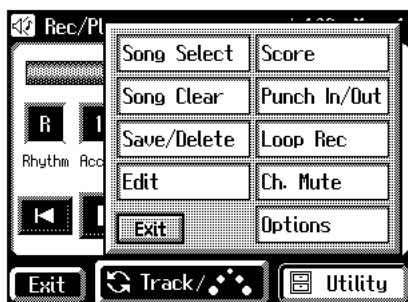

3. In the Utility screen, touch <Edit>.

The Edit Menu screen appears.

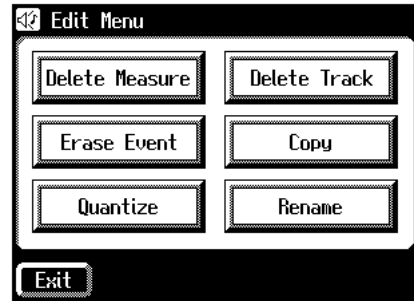

4. Touch <Erase Event>.

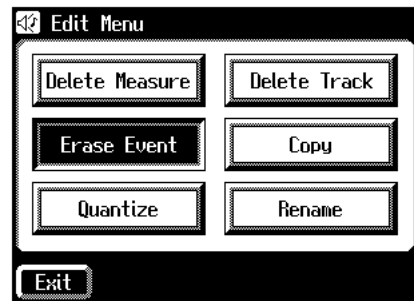

The Erase Event screen appears.

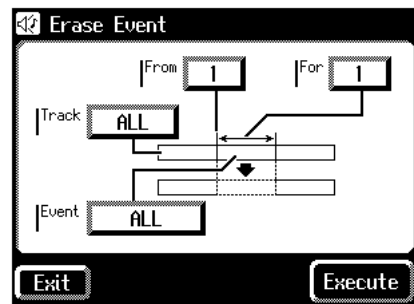

5. Touch the “Event” value (the type of performance data that you wish to erase).

6. Touch <-><+> to specify the “Event” (the type of performance data that you wish to erase).

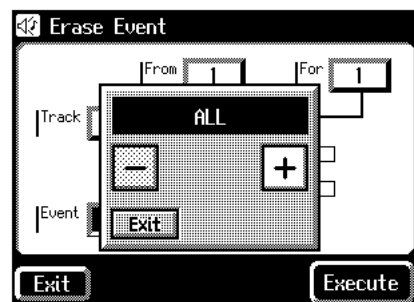

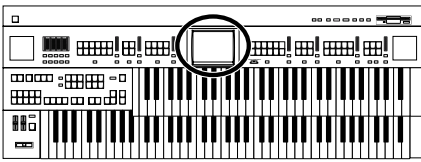

Chapter 8 Editing Your Musical Performance Data

Setting	Descriptions
ALL	All performance data
NOTE	Keyboard performance data
CONTROL	Panel operations, part balance volume
EXPRESSION	Expression pedal operations
VOICE	Sound selection data
TEMPO	Tempo data

7. When you're done making the settings, touch **<Exit>**.
8. Touch the "Track" value (the track from which data will be erased).
9. Touch **<->** **<+>** to specify the "Track" (the track from which data will be erased).
If you have selected EXPRESSION and TEMPO as the type of recording to be erased, the Part selection will not be available because the expression control recording is common to all parts.

Settings **ALL, RHYTHM, ACCOMP, BASS, LOWER, UPPER, SOLO**

If you select "ALL," the recording will be erased from all parts.
10. When you're done making the settings, touch **<Exit>**.
11. Touch the "From" value (the measure at which erasure will begin).
12. Touch **<->** **<+>** to set "From" (the measure at which erasure will begin).
13. When you're done making the settings, touch **<Exit>**.
14. Touch the "For" value (the number of measures from which the data will be erased).
15. Touch **<->** **<+>** to set "For" (the number of measures from which the data will be erased).
If you wish to erase to the last measure (bar), set "for: ALL."
16. When you're done making the settings, touch **<Exit>**.

17. Touch **<Execute>**.

The following display appears.



To cancel operation, touch **<Cancel>**.

18. Touch **<OK>** to erase the performance data.

Once the performance data has been erased, you are returned to the Edit Menu screen.

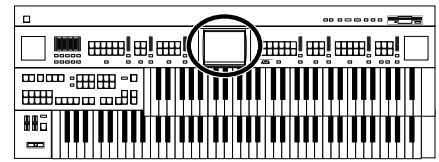

Copying Measures (Copy)

This function lets you copy a portion of recorded song to a different measure (bar) location in the same track.

If a recording already exists at the copy destination, it will be erased.

Example: To copy measures (bars) 5–7 to measure (bar) 8

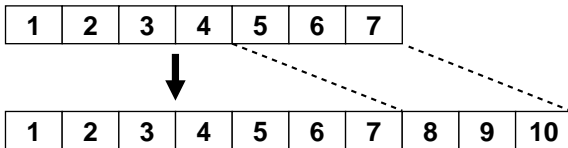

1. Touch <Rec/Play> on the Main screen.

The Rec/Play screen appears.

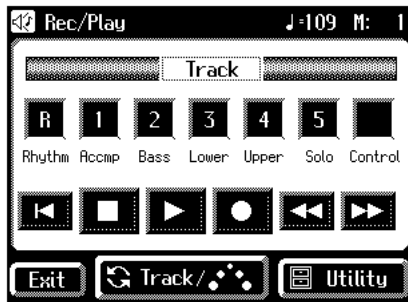

2. In the Rec/Play screen, touch <Utility> to open the Utility screen.

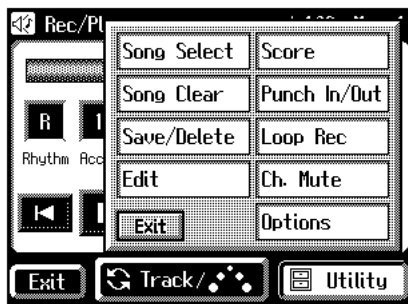

3. In the Utility screen, touch <Edit>.

The Edit Menu screen appears.

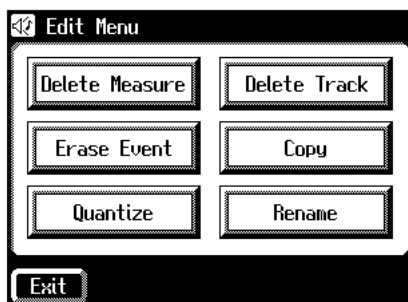

4. Touch <Copy>.

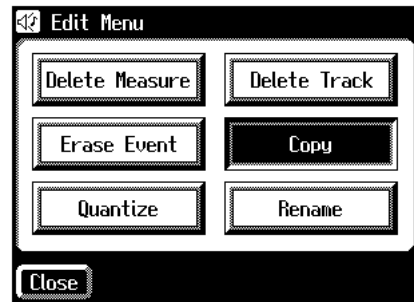

The Copy screen appears.

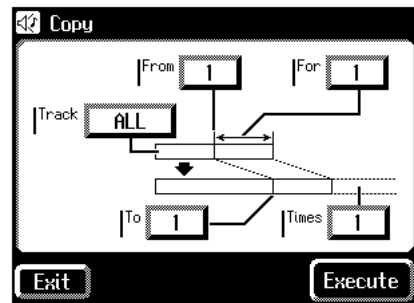

5. Touch the “Track” value (the track to be copied).
6. Touch <-> <+> to set “Track” (the track to be copied).

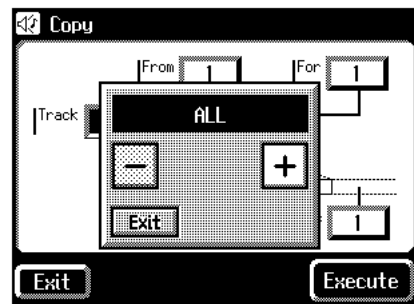

Settings: ALL, RHYTHM, ACCOMP, BASS, LOWER, UPPER, SOLO, CONTROL

If you select “ALL,” the recording in all the tracks will be copied.

7. When you’re done making the settings, touch <Exit>.
8. Touch the “From” value (the measure at which copying will begin).

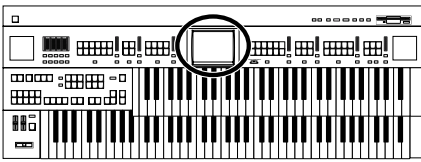

9. Touch **<->** **<+>** to set “From” (the measure at which copying will begin).
10. When you’re done making the settings, touch **<Exit>**.
11. Touch the “For” value (the number of measures to be copied).
12. Touch **<->** **<+>** to set “For” (the number of measures to be copied).
If you wish to erase to the last measure (bar), set “for: ALL.”
13. When you’re done making the settings, touch **<Exit>**.
14. Touch the “To” value (the copy-destination measure number).
15. Touch **<->** **<+>** to set “To” (the copy-destination measure number).
If you select “END,” the data will be copied following the end of the last measure.
16. When you’re done making the settings, touch **<Exit>**.
17. Touch the “Time” value (the number of times that the data will be copied).
18. Touch **<->** **<+>** to set “Time” (the number of times that the data will be copied).
19. When you’re done making the settings, touch **<Exit>**.
20. Touch **<Execute>**.

The following display appears.



To cancel operation, touch **<Cancel>**.

21. Touch **<OK>** to copy the measures.

Once the measures have been copied, you are returned to the Edit Menu screen.

Correct Timing Inaccuracies (Quantize)

You can correct for timing discrepancies in a recorded performance by having the music be aligned with a timing you specify. This is called “Quantizing.”

For example even if you intend to play at quarter-note timing, the notes may be slightly earlier or later than precise quarter-note intervals. In this case, if you quantize at quarter-note (1/4) timing, you can correctly match the rhythms.

1. Touch **<Rec/Play>** on the Main screen.

The Rec/Play screen appears.

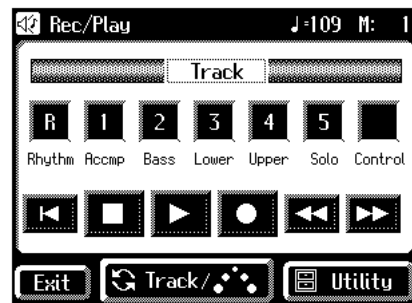

2. In the Rec/Play screen, touch **<Utility>** to open the Utility screen.

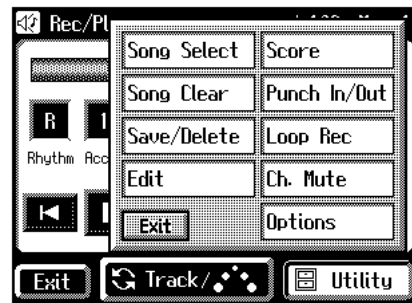

3. In the Utility screen, touch **<Edit>**.

The Edit Menu screen appears.

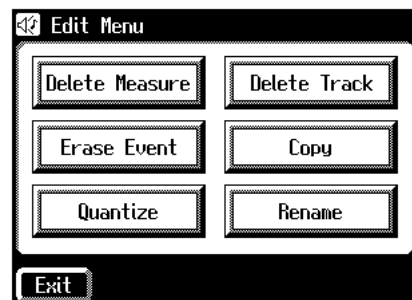

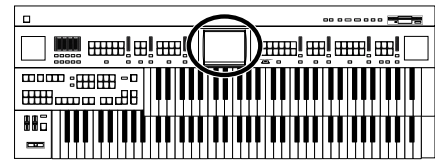

4. Touch <Quantize>.

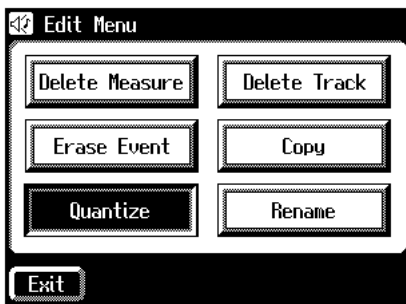

The Quantize screen appears.

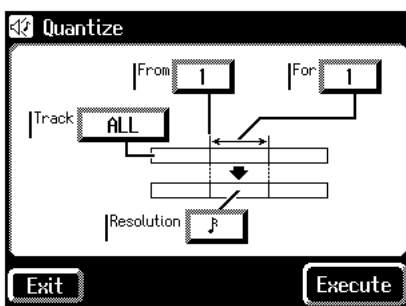

5. Touch the “Track” value (the track that will be quantized).

6. Touch <-><+> to specify the “Track” (the track that will be quantized).

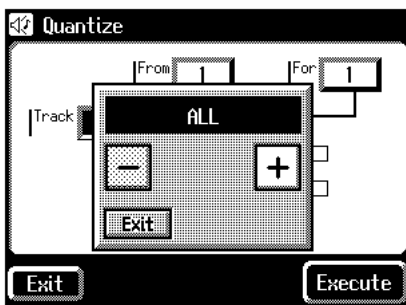

Settings ALL, RHYTHM, ACCOMP, BASS, LOWER, UPPER, SOLO

If you select “ALL,” the recording in all the tracks will be quantized.

7. When you’re done making the settings, touch <Exit>.

8. Touch the “From” value (the measure at which quantization will begin).

9. Touch <-><+> to set “From” (the measure at which quantization will begin).

10. When you’re done making the settings, touch <Exit>.

11. Touch the “For” value (the number of measures that will be quantized).

12. Touch <-><+> to set “For” (the number of measures that will be quantized).

If you wish to erase to the last measure (bar), set “for: ALL.”

13. When you’re done making the settings, touch <Exit>.

14. Touch the “Resolution” value (the resolution at which notes will be aligned).

15. Touch <-><+> to set “Resolution” (the resolution at which notes will be aligned).

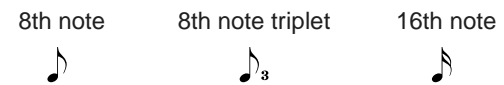
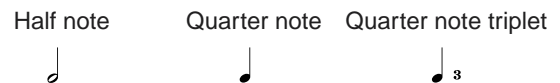

16. When you’re done making the settings, touch <Exit>.

17. Touch <Execute>.

The following display appears.

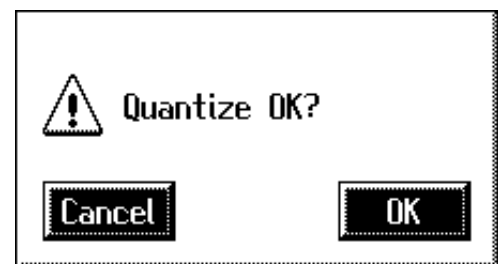

To cancel operation, touch <Cancel>.

18. Touch <OK> to have the quantization carried out.

When the quantizing is finished, you are returned to the Edit Menu screen.

Chapter 9 Various Other Settings

Adjusting How the Instrument Responds

■ Turning Aftertouch On/Off

This setting is used to turn ON/OFF the Aftertouch feature. Aftertouch applies vibrato when additional pressure is placed on the keys that are being played.

1. Touch <Sound/Kbd> on the Main screen.
The sub-window appears.
2. In the sub-window, touch <Upper Kbd>.
The Upper Keyboard screen appears.
3. Touch <◀><▶> to display the After Touch.

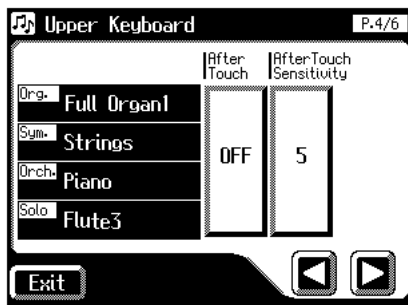

4. Touch the After Touch setting to switch between "ON" and "OFF."

Each time you touch the After Touch setting, it will alternate between "ON" and "OFF."

Settings ON, OFF

5. Touch <Exit>.

NOTE

Please note that not all the voices on the Upper keyboard are responsive to Aftertouch, even if the feature is set to ON (p. 193).

■ Adjusting the Depth of Aftertouch

This adjusts the depth of the Aftertouch effect.

1. Touch <Sound/Kbd> on the Main screen.
The sub-window appears.
2. In the sub-window, touch <Upper Kbd>.
The Upper Keyboard screen appears.
3. Touch <◀><▶> to display the After Touch Sensitivity.

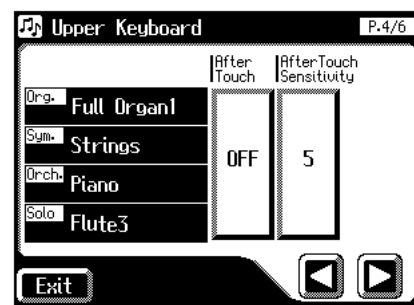

4. Touch the After Touch Sensitivity value (1-10).

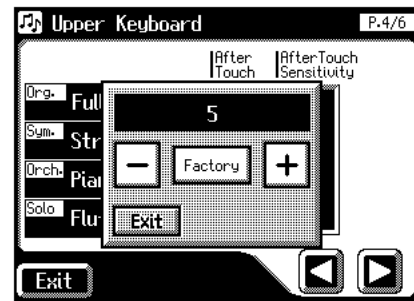

5. Touch <-><+> to edit the value.

Setting 1-10

Higher settings of this value will allow deeper vibrato to be applied when you apply pressure to the keyboard.

6. Touch <Exit>.

NOTE

Aftertouch can only be enabled for the Upper keyboard.

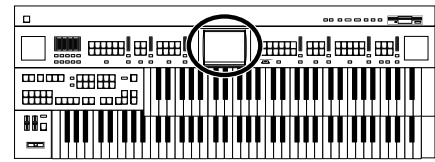

■ Turning Initial Touch On/Off

Initial Touch is a function that translates the force used in playing the keys into a directly proportional amount of volume. It can be switched ON/OFF independently for the Upper and Lower keyboards.

1. Touch <Sound/Kbd> on the Main screen.
The sub-window appears.
2. In the sub-window, touch either <Upper Kbd>, or <Lower Kbd>.

Upper Kbd	To change the initial touch setting of the Upper part
Lower Kbd	To change the initial touch setting of the Lower part

3. Touch <Left><Right> to display the Initial Touch.

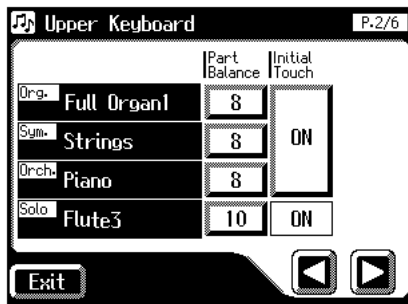

4. Touch the displayed Initial Touch setting (ON, OFF) to switch it ON/OFF.

Each time you touch the value, it will alternately turn ON/OFF.

Setting	Descriptions
ON	The harder you play the key, the higher the volume.
OFF	Volume remains constant regardless of how hard you play.

5. Touch <Exit>.

■ Changing the Pedalboard Polyphony

You can set the Bass Pedalboard to play simultaneous multiple notes or single notes only.

1. Touch <Sound/Kbd> on the Main screen.
The sub-window appears.
2. In the sub-window, touch <Pedalboard>.
The Pedalboard screen appears.
3. Touch <Left><Right> to display the PedalBass Mode.

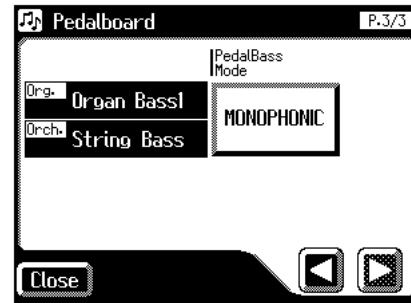

4. Touch the PedalBass Mode setting to switch between “MONOPHONIC” and “POLYPHONIC.”

Each time you touch the PedalBass Mode setting, it will alternate between “MONOPHONIC” and “POLYPHONIC.”

Setting	Descriptions
MONOPHONIC	Only single notes can be played.
POLYPHONIC	Multiple notes can be played.

5. Touch <Exit>.

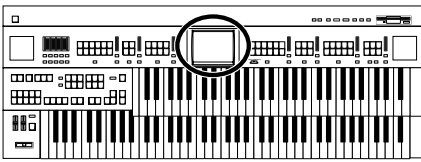

■ Changing How the Solo Voice Responds

When the Solo voice is assigned to the Upper keyboard or the Lower keyboard, you can specify how the Solo voice will respond when more than one key is pressed.

1. Touch <Sound/Kbd> on the Main screen.
The sub-window appears.
2. In the sub-window, touch <Upper Kbd>.
The Upper Keyboard screen appears.
3. Touch <◀><▶> to display the Solo Mode.

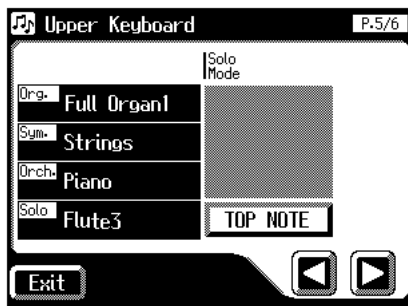

4. Touch the Solo Mode setting (the TOP NOTE, LAST NOTE, or POLYPHONIC indication).

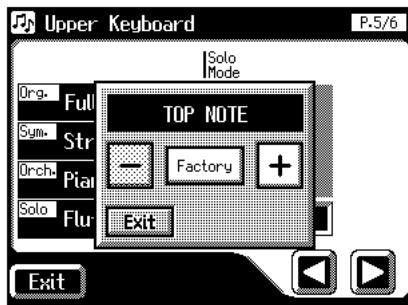

5. Touch <-><+> to change the setting.

Setting	Descriptions
TOP NOTE	The Solo voice will sound the highest note that is played for the Solo part.
LAST NOTE	The Solo voice will sound the note that was most recently played for the Solo part.
POLYPHONIC	The Solo voice will sound all notes that are played for the Solo part.

6. Touch <Exit>.

■ Layering the Solo Voice and Lower Voice

When the Solo voice is being played by the Lower keyboard (i.e., when the Solo [To Lower] button is ON), you can specify whether the Lower voice and the Solo voice will sound together (layered), or will sound separately (split).

1. Touch <Sound/Kbd> on the Main screen.
The sub-window appears.
2. In the sub-window, touch <Upper Kbd>.
The Upper Keyboard screen appears.
3. Touch <◀><▶> to display the Solo To Lower Mode.

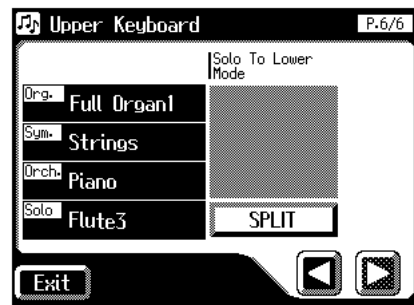

4. Touch the Solo To Lower Mode setting to switch between "SPLIT" and "LAYER."

Each time you touch the Solo To Lower Mode setting, it will alternate between "SPLIT" and "LAYER."

Setting	Descriptions
SPLIT	The parts will sound separately.
LAYER	The Lower voice and Solo voice will sound together.

5. Touch <Exit>.

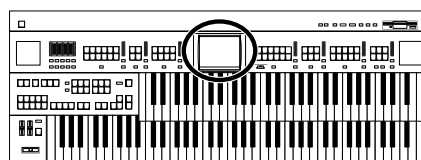

Performance Function Settings

■ Changing the Function of the Foot Switch

You can select any of the following functions and assign them to either Foot Switch on the right or left side of the Expression Pedal.

1. Touch <Sound/Kbd> on the Main screen.
The sub-window appears.
2. In the sub-window, touch <Controller>.
The Controller screen appears.
3. Touch <▲><▼> to display the L Foot Switch or R Foot Switch.

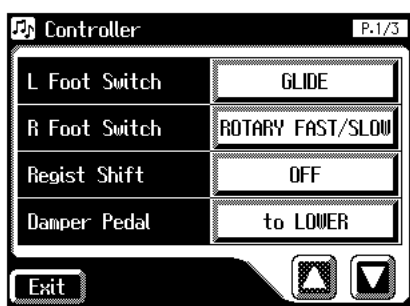

4. Touch <L Foot Switch> or <R Foot Switch> setting.

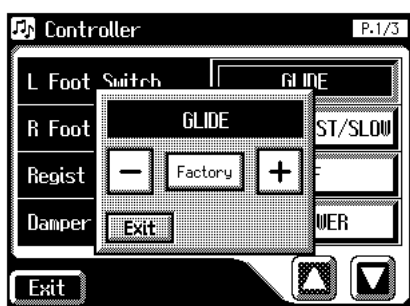

5. Touch <-><+> to change the setting.
6. Touch <Exit>.

Available functions	Description
ROTARY FAST/SLOW	Switch the Rotary speed between “FAST” and “SLOW.”
GLIDE	While the Foot Switch is pressed, the pitch will temporarily be lowered, and will gradually return to normal when you release the Foot Switch. When the power is turned on, Glide effect is added to the voice of all the sections being played on Upper keyboard.
LEADING BASS	The Leading Bass function (p. 43) will operate only while you continue pressing the Foot Switch.
RHYTHM START/STOP	Start/Stop the Rhythm.
COMPOSER PLAY/STOP	The same function as the Composer [Play/Stop] button. Each time you press the Foot Switch, the performance data will play back or stop.
INTRO/ENDING	Play an Intro or Ending.
FILL IN TO VARIATION	After inserting a Fill-In, playback will switch to the variation pattern.
FILL IN TO ORIGINAL	After inserting a Fill-In, playback will switch to the original pattern.
ORCHESTRATOR	Switch the Style Orchestrator button.If the Style Orchestrator [Basic] button or [Advanced2] button is selected, the [Basic] and [Advanced2] buttons will be switched.If the [Advanced1] button or [Full] button is selected, the [Advanced1] button and [Full] button will be switched.
BREAK	Stop the rhythm at the end of that measure.
DAMPER OF UPPER	Notes played on the Upper keyboard will be sustained only while you continue pressing the Foot Switch.
DAMPER OF LOWER	Notes played on the Lower keyboard will be sustained only while you continue pressing the Foot Switch.

NOTE

If the “Regist Shift (Registration Shift)” setting (p. 161) is “RIGHT” or “LEFT”, the Foot Switch will be dedicated to switching through the Registrations, and the “R Foot Switch” or “L Foot Switch” setting will be ignored.

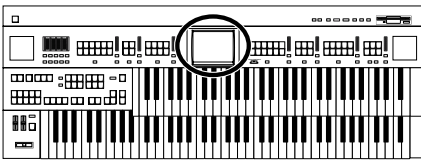

■ Using the Foot Switch to Switch Registrations

You can use the Foot Switch as a dedicated switch for selecting Registrations in order.

1. Touch <Sound/Kbd> on the Main screen.
The sub-window appears.
2. In the sub-window, touch <Controller>.
The Controller screen appears.
3. Touch to display the Regist Shift.

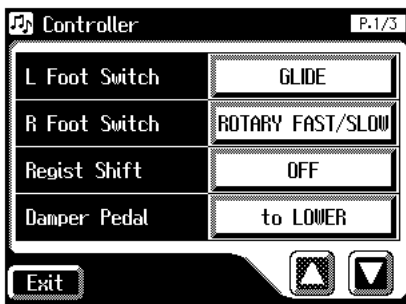

4. Touch the Regist Shift setting.
5. Touch to change the setting.

Setting	Descriptions
OFF	You can use a function assigned to the foot switch.
RIGHT	The right foot switch is dedicated to switching registrations. The function assigned to the right foot switch cannot be used.
LEFT	The left foot switch is dedicated to switching registrations. The function assigned to the left foot switch cannot be used.

6. Touch <Exit>.
If Regist Shift is turned RIGHT or LEFT, each time you press the Foot Switch, the Registrations will be selected in the following order: 1 → 2 → 3 → ... 12 → 1.. etc.



This setting remains stored in memory even while the power is turned off.

■ Selecting the Range of Keys to Which the Damper Pedal will Apply

You can specify which keyboard will be affected when you press the Damper (Sustain) pedal.

1. Touch <Sound/Kbd> on the Main screen.
The sub-window appears.
2. In the sub-window, touch <Controller>.
The Controller screen appears.
3. Touch to display the Damper Pedal.

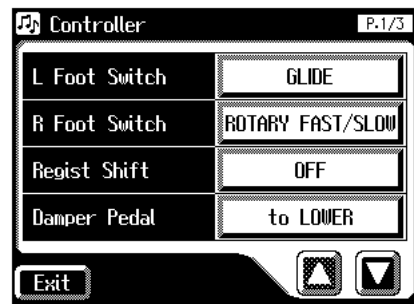

4. Touch the Damper Pedal setting to switch between “to UPPER” and “to LOWER.”

Each time you touch the Damper Pedal setting, it will alternate between “UPPER” and “LOWER.”

Setting	Descriptions
to UPPER	The effect is applied to the voices played on the Upper keyboard.
to LOWER	The effect is applied to the voices played on the Lower keyboard.

5. Touch <Exit>.

NOTE

If the voice is a percussive voice (such as a Piano voice), the tone will be sustained, but fade away just like an acoustic piano. Is the voice is a non-percussive instrument (such as a String voice), the tone will be sustained as long as the pedal is depressed.

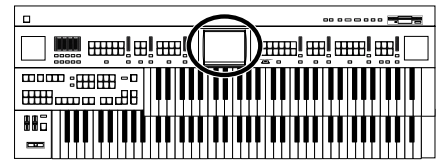

■ Changing the Function of the Expression Pedal

Specify how the Expression Pedal will function when your performance is being recorded and when ATELIER song files are being played back.

Function During Recording

Specify whether Expression Pedal operations will be recorded or not while your performance is being recorded.

1. Touch <Sound/Kbd> on the Main screen.

The sub-window appears.

2. In the sub-window, touch <Controller>.

The Controller screen appears.

3. Touch <▲><▼> to display the EXP. Src (Rec).



4. Touch the EXP. Src (Rec) setting to switch between “PEDAL” and “COMPOSER.”

Each time you touch the Chord Intelligence setting, it will alternate between “PEDAL” and “COMPOSER.”

Setting	Descriptions
PEDAL	Expression Pedal movements will be recorded. The previous recording will be erased as new songs are recorded.
COMPOSER	Expression Pedal movements will not be recorded. The previous data will remain without being erased.

5. Touch <Exit>.

Function During Playback

You can specify whether or not the Expression Pedal will function while ATELIER song files are being played back.

1. Touch <Sound/Kbd> on the Main screen.

The sub-window appears.

2. In the sub-window, touch <Controller>.

The Controller screen appears.

3. Touch <▲><▼> to display the EXP. Src (Play).

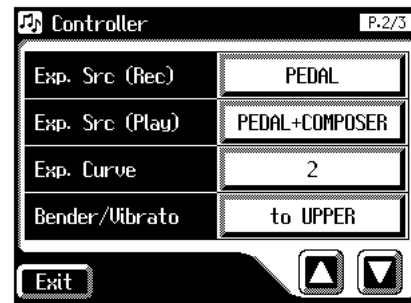

4. Touch <EXP. Src (Play)> setting.

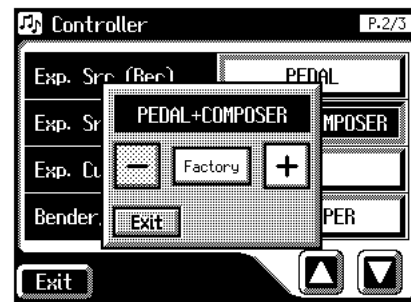

5. Touch <-><+> to change the setting.

Setting	Descriptions
PEDAL	The Expression Pedal will function. The Expression Pedal recording within the song file will be ignored.
COMPOSER	The Expression Pedal will not function. The Expression Pedal recording within the song file will be effective.
PEDAL +COMP	The Expression Pedal will function. Expression Pedal recording within the song file will also be effective.

6. Touch <Exit>.

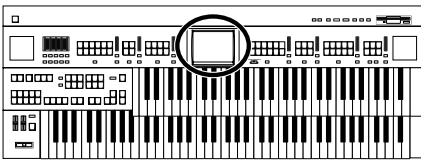

■ Adjusting the Depth of the Expression Pedal

1. Touch <Sound/Kbd> on the Main screen.
The sub-window appears.
2. In the sub-window, touch <Controller>.
The Controller screen appears.
3. Touch <▲><▼> to display the Damper Pedal.
4. Touch <Exp. Curve> setting.

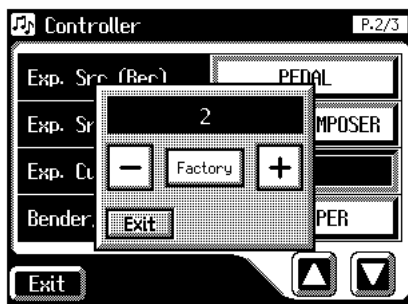

5. Touch <-><+> to change the setting.

Setting	Descriptions
1	The Expression pedal will change the volume of the Rhythm and Automatic Accompaniment playback to a lesser degree than the volume of the keyboard voices.
2, 3	The Expression pedal will change the volume of the Rhythm and Automatic Accompaniment playback and the keyboard voices to the same degree.

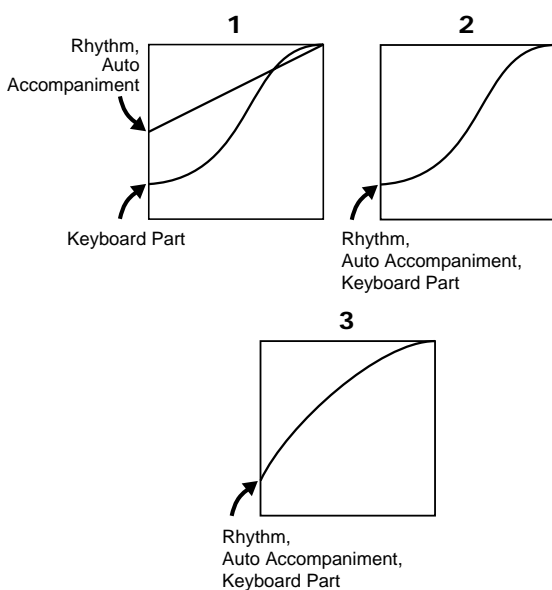

6. Touch <Exit>.



This setting remains stored in memory even while power is turned off.

■ Selecting the Range of Keys to Which the Pitch Bend/Vibrato Lever will Apply

This setting determines which keyboard will be controlled by the Pitch Bend/Vibrato lever.

1. Touch <Sound/Kbd> on the Main screen.
The sub-window appears.
2. In the sub-window, touch <Controller>.
The Controller screen appears.
3. Touch <▲><▼> to display the Bender/Vibrato.

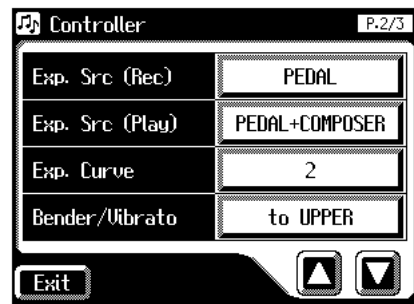

4. Touch <Bender/Vibrato> setting.

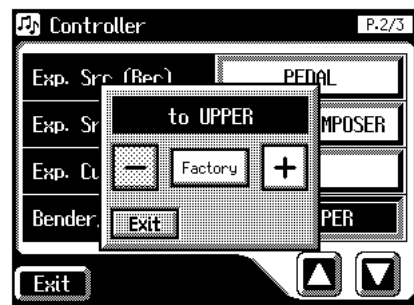

5. Touch <-><+> to change the setting.

Setting	Descriptions
to UPPER	The effect is applied to the voices played on the Upper keyboard.
to LOWER	The effect is applied to the voices played on the Lower keyboard.
to PEDAL	The effect is applied to the voices played on the Pedalboard.

6. Touch <Exit>.

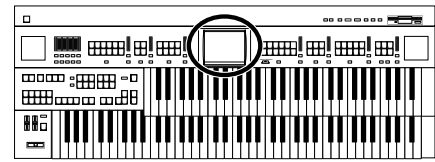

■ Changing the Pitch Bend Range

This setting allows you to choose the maximum amount of Pitch change (range) permissible when using Pitch Bend. The range can be set anywhere between 1-12 (in semitone units; with a maximum of one octave).

1. Touch <Sound/Kbd> on the Main screen.
The sub-window appears.
2. In the sub-window, touch <Controller>.
The Controller screen appears.
3. Touch <▲><▼> to display the Pitch Bend Range.

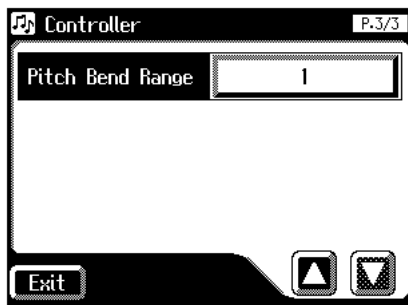

4. Touch <Pitch Bend Range> setting.

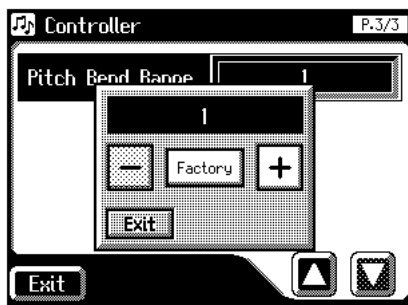

5. Touch <-><+> to change the setting.
Settings 1-12 (semitone steps)
6. Touch <Exit>.

NOTE

Drums/SFX is fixed at one octave range, regardless of this setting.

Rhythm Settings

■ Turning Chord Intelligence On/off

“Chord Intelligence” is a feature that intelligently plays the correct accompaniment chords the moment you play a key specifying a chord on the Lower keyboard during Automatic Accompaniment.

To play a C chord on the Lower keyboard, for example, you usually have to press down the three keys C, E, and G; but with Chord Intelligence, you only have to press the C Key to initiate a C chord accompaniment.

1. Touch <Rhythm> on the Main screen.
The Rhythm screen appears.
2. In the Rhythm screen, touch <Utility>.
The Utility screen appears.
3. Touch <Options>.
The Rhythm Option screen appears.



4. Touch the Chord Intelligence setting to switch between “ON” and “OFF.”
Each time you touch the Chord Intelligence setting, it will alternate between “ON” and “OFF.”
Settings ON, OFF
5. Touch <Exit>.

MEMO

If you press the root note of the chord in the lower keyboard when the Chord Intelligence function is off, all notes in that chord will sound.

For example, if you press the root “C” of the C major chord in the lower keyboard, the notes of the C major chord “C,” “E,” and “G” will be sounded by the voice selected for the lower part.

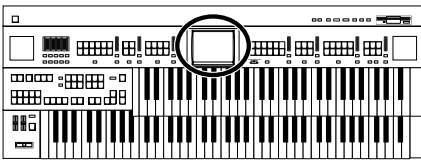

■ Turning Chord Hold On/Off

The Chord Hold function can be switched ON/OFF. When Chord Hold is ON, the Automatic Accompaniment will continue playing even when you lift your hand from the keyboard to play a new chord.

1. Touch <Rhythm> on the Main screen.

The Rhythm screen appears.

2. In the Rhythm screen, touch <Utility>.

The Utility screen appears.

3. Touch <Options>.

The Rhythm Option screen appears.



4. Touch the Chord Hold setting to switch between "ON" and "OFF."

Each time you touch the Chord Hold setting, it will alternate between "ON" and "OFF."

Setting	Descriptions
ON	The Automatic Accompaniment determined by the chord played on the Lower keyboard is held (even if you release the keys).
OFF	When you release the keys that you played in the Lower keyboard, the Automatic Accompaniment will stop (be muted). Only the Rhythm (drum) performance will continue.

5. Touch <Exit>.

■ Using the Leading Bass Function

When Automatic Accompaniment is used, and the Pedal [To Lower] button is ON, the Pedal Bass voice will normally play the root note (p. 212) of the chord you play on the Lower keyboard. If the Leading Bass function is enabled, the lowest note of the chord you play on the Lower keyboard will then be used as the bass note (the bottom note of the chord). For this reason, the bass note will be sounded differently than normal when you play an inverted chord (p. 212).

1. Touch <Rhythm> on the Main screen.

The Rhythm screen appears.

2. In the Rhythm screen, touch <Utility>.

The Utility screen appears.

3. Touch <Options>.

The Rhythm Option screen appears.

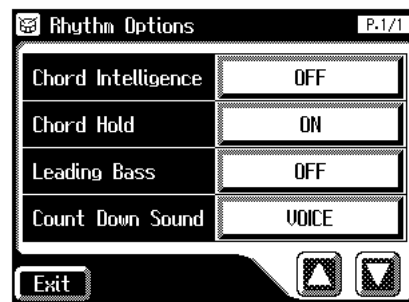

4. Touch the Leading Bass setting to switch between "ON" and "OFF."

Each time you touch the Leading Bass setting, it will alternate between "ON" and "OFF."

Setting	Descriptions
ON	The Leading Bass function is on. The pedal bass tone will sound the lowest note of the chord you play in the lower keyboard.
OFF	The Leading Bass function is off.

5. Touch <Exit>.



You can assign the Leading Bass functions to either of the foot switches located on each side of the Expression Pedal (p. 108).



While the intro or ending are playing, playing the lower keyboard will not produce sound.

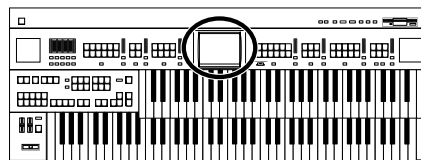

Count Down Sound

You can change the sound that is used for the count played at the end of the intro with the Intro Countdown function (p. 61).

1. Touch <Rhythm> on the Main screen.

The Rhythm screen appears.

2. In the Rhythm screen, touch <Utility>.

The Utility screen appears.

3. Touch <Options>.

The Rhythm Option screen appears.

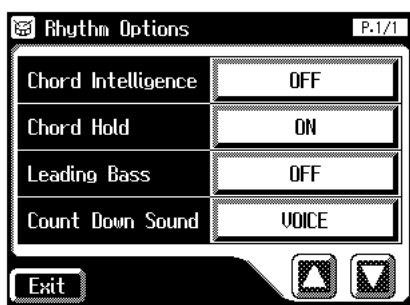

4. Touch the Count Down Sound setting to switch between “VOICE” and “STICK.”

Each time you touch the Chord Hold setting, it will alternate between “VOICE” and “STICK.”

Setting	Descriptions
VOICE	Human voice count (One, two, three...)
STICK	Stick sound count

5. Touch <Exit>.

Registration Settings

Changing the Timing at Which Arranger Settings are Recalled

You can specify how the settings related to Rhythm performances and Automatic Accompaniment will be recalled when you press a Registration button.

1. Touch <Registration> on the Main screen.

The sub-window appears.

2. Touch <Load>.

The Registration Load screen appears.

3. Touch <Utility>.

The Utility screen appears.

4. Touch <Options>.

The Registration Options screen appears.

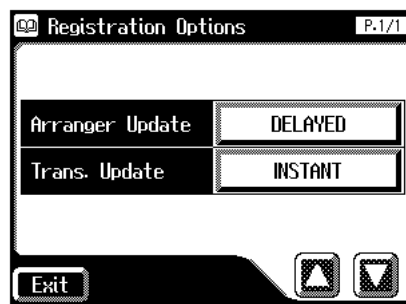

5. Touch the Arranger Update setting to switch between “DELAYED” and “INSTANT.”

Each time you touch the Arranger Update setting, it will alternate between “DELAYED” and “INSTANT.”

Setting	Descriptions
DELAYED	Settings related to Rhythm performances and Automatic Accompaniment will be recalled when you hold a Registration button for several seconds. If you quickly press the Registration button, only the panel settings (voice, etc.) that are not related to Rhythm and Automatic Accompaniment will be updated.
INSTANT	Settings related to Rhythm performances and Automatic Accompaniment will be recalled the instant you press a button along with all other panel settings.

6. Touch <Exit>.



This setting remains stored in memory even while power is turned off.

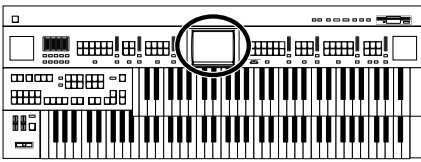

■ Changing the Timing at Which Transposition Settings are Recalled

You can specify how the transpose setting will be recalled when you press a Registration button.

1. Touch <Registration> on the Main screen.

The sub-window appears.

2. Touch <Load>.

The Registration Load screen appears.

3. Touch <Utility>.

The Utility screen appears.

4. Touch <Options>.

The Registration Options screen appears.



5. Touch the Trans. Update setting to switch between “DELAYED” and “INSTANT.”

Each time you touch the Trans. Update setting, it will alternate between “DELAYED” and “INSTANT.”

Setting	Descriptions
DELAYED	Transpose settings will be recalled when you hold a Registration button for several seconds.
INSTANT	Transpose setting will be recalled the instant you press a button along with all other panel settings.

6. Touch <Exit>.



This setting remains stored in memory even while power is turned off.

Composer settings

■ Switching the Display of Lyrics On or Off

Some music files have Lyrics included and these Lyrics can be displayed on the screen. You can turn on or off the lyrics display of such music files.

1. Touch <Rec/Play> on the Main screen.

The Rec/Play screen appears.

2. Touch <Utility>.

The Utility screen appears.

3. Touch <Options>.

The Rec/Play Options screen appears.

4. Touch <▲><▼> to display the Lyric.

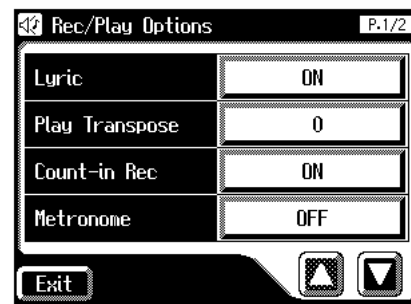

5. Touch the Lyric setting to switch between “ON” and “OFF.”

Each time you touch the Lyric setting, it will alternate between “ON” and “OFF.”

Setting	Descriptions
ON	Lyrics will be displayed
OFF	Lyrics will not be displayed

6. Touch <Exit>.

NOTE

If you press a voice select button while playing back music files that contains lyrics, the display screen will switch, and the lyrics will no longer be displayed. To re-display the lyrics, press the [Play/Stop] button once again.



This setting remains stored in memory even while power is turned off.

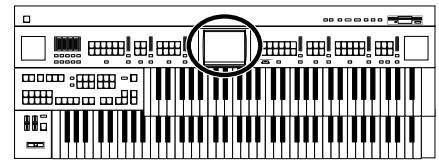

■ Changing the Key When Playing Back Songs (Playback Transpose)

SMF music files or a performance that you yourself recorded can be transposed for playback.

1. Touch <Rec/Play> on the Main screen.
The Rec/Play screen appears.
2. Touch <Utility>.
The Utility screen appears.
3. Touch <Options>.
The Rec/Play Options screen appears.
4. Touch < to display the Play Transpose.

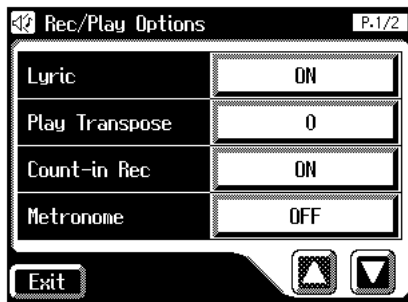

5. Touch the <Play Transpose> setting.

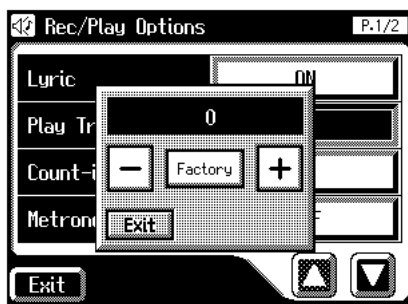

6. Touch < to change the setting.
Settings -24 – +24 (semitone steps)
7. Touch <Exit>.

■ Changing the Metronome Setting

1. Touch <Rec/Play> on the Main screen.
The Rec/Play screen appears.
2. Touch <Utility>.
The Utility screen appears.
3. Touch <Options>.
The Rec/Play Options screen appears.
4. Touch < to display the Metronome.

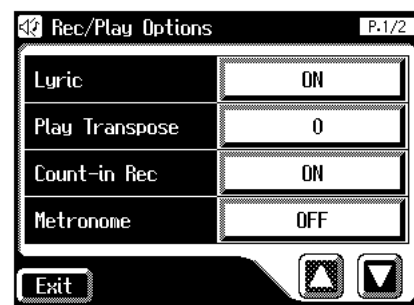

5. Touch the <Metronome> setting.

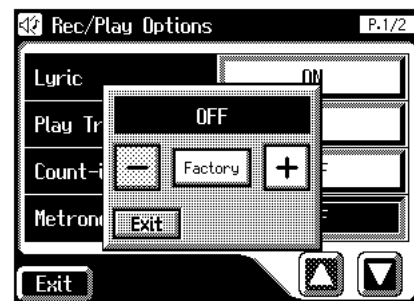

6. Touch < to change the setting.

Setting	Descriptions
OFF	Not heard at all
REC	Heard only while recording
ON	Heard constantly

7. Touch <Exit>.

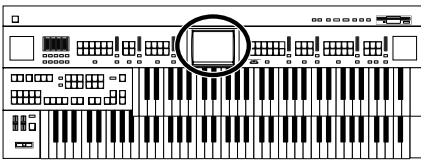

■ Adjusting the Metronome Volume

You can adjust the volume of the metronome.

1. Touch <Rec/Play> on the Main screen.
The Rec/Play screen appears.
2. Touch <Utility>.
The Utility screen appears.
3. Touch <Options>.
The Rec/Play Options screen appears.
4. Touch <▲><▼> to display the Metronome Vol.



5. Touch <Metronome Vol.> setting.

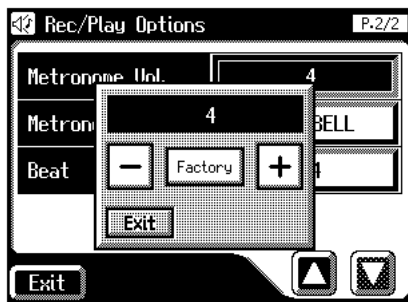

6. Touch <-><+> to change the setting.
Settings 1-10
Increasing the value will raise the volume of the metronome.
7. Touch <Exit>.

■ Changing the Sound of the Metronome

You can choose one of 4 different sounds for the metronome.

1. Touch <Rec/Play> on the Main screen.
The Rec/Play screen appears.
2. Touch <Utility>.
The Utility screen appears.
3. Touch <Options>.
The Rec/Play Options screen appears.
4. Touch <▲><▼> to display the Metronome Sound.



5. Touch <Metronome Sound> setting.

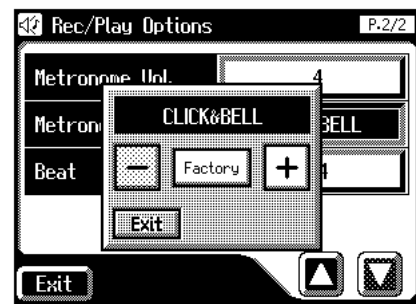

6. Touch <-><+> to change the setting.

Setting	Descriptions
CLICK&BELL	Conventional metronome sound
ELECTRONIC	Electronic metronome sound
VOICE ENG.	Human voice (English)
VOICE JPN.	Human voice (Japanese)

7. Touch <Exit>.



This setting remains stored in memory even while power is turned off.

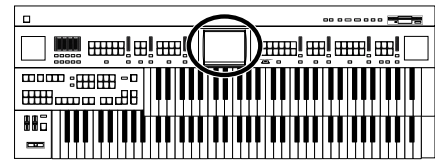

■ Setting the Beat

This setting determines the beat to be used when recording performance songs.

1. Touch <Rec/Play> on the Main screen.

The Rec/Play screen appears.

2. Touch <Utility>.

The Utility screen appears.

3. Touch <Options>.

The Rec/Play Options screen appears.

4. Touch <▲><▼> to display the Beat.



5. Touch <Beat> setting.

The time signature setting screen appears.

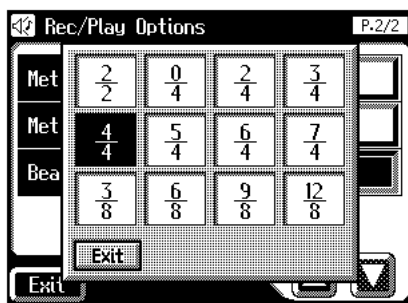

6. Touch the time signature that you wish to set.

7. Touch <Exit>.

MEMO

When recording Rhythm performances or Automatic Accompaniment, the beat is set automatically.

NOTE

You cannot change the beat of previously recorded songs.

■ Muting Individual Channels of Performance Data

You can mute (silence) individual channels of performance data of SMF music files.

NOTE

It is not possible to mute the performance that you play on the AT-90S/80S/60S (except for the Rhythm and Automatic Accompaniment).

1. Touch <Rec/Play> on the Main screen.

The Rec/Play screen appears.

2. Touch <Utility>.

The Utility screen appears.

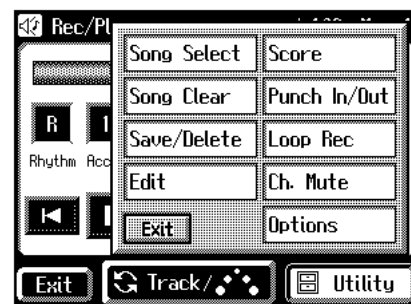

3. Touch <Ch. Mute> setting.

The Ch. Mute (channel mute) screen appears.

From the left, these are "1 Ch. (channel 1), 2 Ch. ... 15 Ch., and 16 Ch."

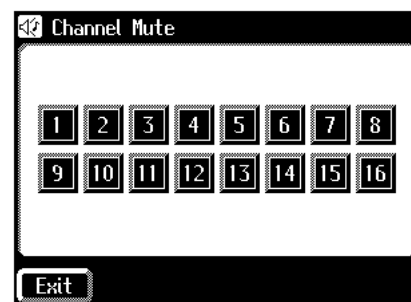

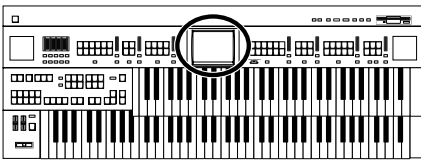

4. Touch the screen to select the channel that you wish to mute.

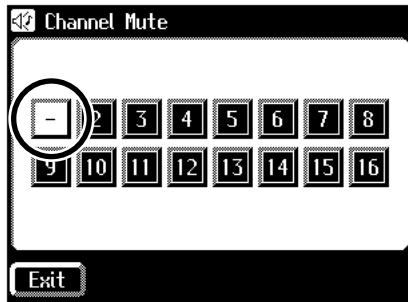

The number will change to “-,” indicating that it has been muted.

5. If you once again touch a channel that is displayed as “-,” the channel number will appear and channel mute will be defeated.
6. Touch <Exit>.

NOTE

Channel mute will be defeated when you perform the following operations.

- Select different performance data.
- Press the [Demo] button to play performance data.

Other Settings

■ Adjust the Standard Pitch (Master Tune)

The basic pitch of an instrument is generally considered as the pitch of the middle A note. The “Master Tune” parameter lets you adjust this basic pitch to match the pitch of any other instruments that are playing together with the AT-90S/80S/60S.

1. Touch <System> on the Main screen.

The System screen appears.

2. Touch <▲><▼> to display the Master Tune.



3. Touch <Master Tune> setting.



4. Touch <-><+> to change the setting.

Settings 415.3Hz - 466.2Hz (0.1 Hz units)

5. Touch <Exit>.

MEMO

By touching < Factory >, you can restore the default setting (440.0 Hz).

MEMO

This setting remains stored in memory even while power is turned off.

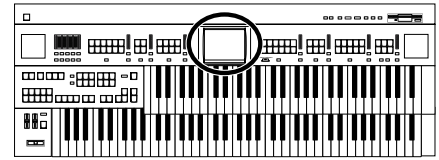

■ Mic Echo

You can adjust the Mic echo.



Connecting the Microphone (p. 20)

1. Touch <System> on the Main screen.
The System screen appears.
2. Touch to display the Mic Echo.

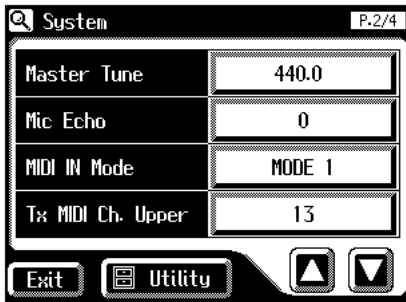

3. Touch <Mic Echo> setting.

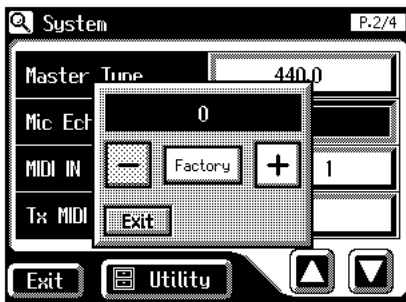

4. Touch to change the setting.
Settings 1–12
5. Touch <Exit>.



By touching , you can restore the default setting (4).



This setting remains stored in memory even while power is turned off.

■ Enabling Transmission of PC Numbers

Transmission of PC (Program Change) numbers can be switched ON/OFF when a Registration is selected.

1. Touch <System> on the Main screen.
The System screen appears.
2. Touch to display the Send PC Switch.

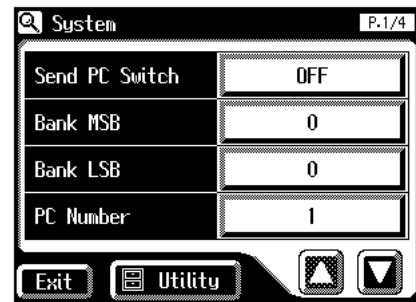

3. Touch the Send PC Switch setting to switch between “ON” and “OFF.”

Each time you touch the Send PC Switch setting, it will alternate between “ON” and “OFF.”

Setting	Descriptions
ON	PC numbers are transmitted
OFF	PC numbers are not transmitted

4. Touch <Exit>.



This setting remains stored in memory even while power is turned off.

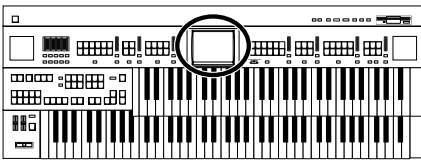

■ Setting the PC Number

You can specify the Program Change number that will be transmitted from MIDI Out when a Registration is selected.

1. Touch <System> on the Main screen.

The System screen appears.

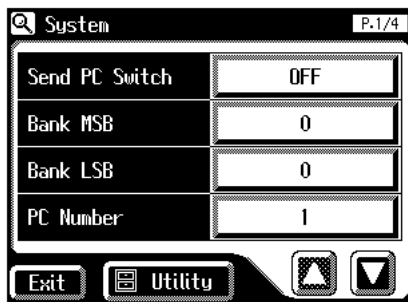

2. Touch either <Bank MSB>, <Bank LSB>, or <PC Number> setting.

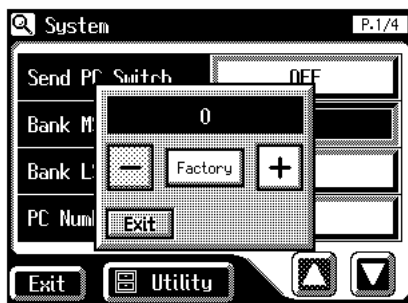

3. Touch <-> <+> to change the setting.

Menu	Setting
Bank MSB	0-127
Bank LSB	0-127
PC Number	1-128

4. Touch <Exit>.

■ MIDI IN Mode

This instrument contains two sound generators: one for SMF data playback and one for keyboard performance.

Normally, data received at the MIDI In connector will control only the sound generator for SMF data playback. However by changing the MIDI IN Mode setting, you can also control the keyboard sound generator from MIDI In.

1. Touch <System> on the Main screen.

The System screen appears.

2. Touch <▲> <▼> to display the MIDI IN Mode.



3. Touch the MIDI IN Mode setting to switch between “MODE 1” and “MODE 2.”

MODE 1	Control the instrument as a GS sound generator
MODE 2	Channels 1-8 and channel 10 will be sent to the GS sound generator, and channel 9 and channels 11-16 will be sent to the keyboard sound generator.

Chapter 9 Various Other Settings

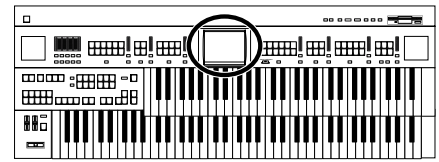

Channel	MODE 1	MODE 2
1-8	GS	GS
9	GS	Drums/SFX
10	GS	GS
11	GS	Manual Percussion
12	GS	Lower
13	GS	Upper
14	GS	Pedal Bass
15	GS	Nothing
16	GS	Solo, Control

4. Touch <Exit>.

MEMO

There are limitations on the types of MIDI messages that can be received by the keyboard sound source. For details refer to the “MIDI IMPLEMENTATION” (sold separately).

MEMO

This setting remains stored in memory even while power is turned off.

■ Selecting the MIDI Transmit Channel

When you use the MIDI connectors or the computer connector of the AT-90S/80S/60S to transmit musical data to external devices, for each keyboard (Upper, Lower, and Pedal) you can specify the channel on which your playing will be transmitted as MIDI messages.

MEMO

For details refer to p. 183.

1. Touch <System> on the Main screen.

The System screen appears.

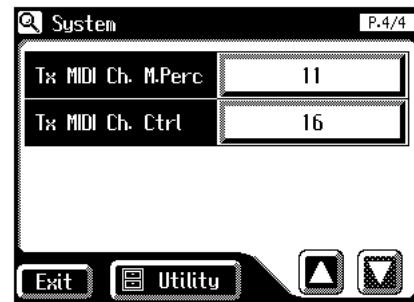

2. Touch <Tx MIDI Ch. Upper>, <Tx MIDI Ch. Lower>, <Tx MIDI Ch. Pedal>, <Tx MIDI Ch. Solo> or <Tx MIDI Ch. Cntrl>.

The Control part transmits Expression pedal data and PC numbers.

3. Touch <-> <+> to change the setting.

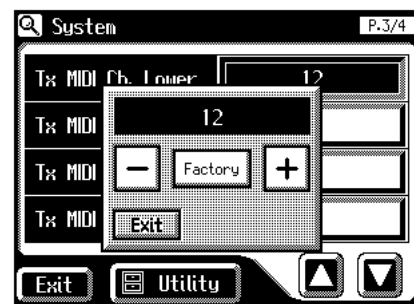

Channel 1-16

4. Touch <Exit>.

NOTE

MIDI messages for the Solo part will be transmitted only when the Solo [To Lower] button is ON.

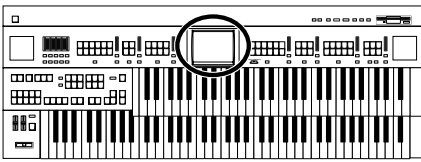

■ Repositioning the Touch Screen

If you've been using the Touch Screen for some time, the pointer may be shifted, making the AT-90S/80S/60S react incorrectly. You should correct this displacement when necessary by performing calibration (repositioning).

1. Touch <System> on the Main screen.

The System screen appears.

2. In the System screen, touch <Utility>.

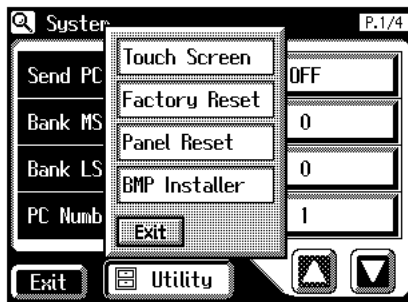

3. Touch <Touch Screen>.

A display will ask for confirmation.

To cancel the operation, touch <Cancel>.

4. Touch <OK> on the screen.

5. Touch the points indicated on the touch screen.

NOTE

Do this carefully, because touching a location that's different from the one indicated for the pointer may make the displacement even worse. Be sure to touch the pointer accurately.

If the following display appears, perform the touch panel position adjustment once again.

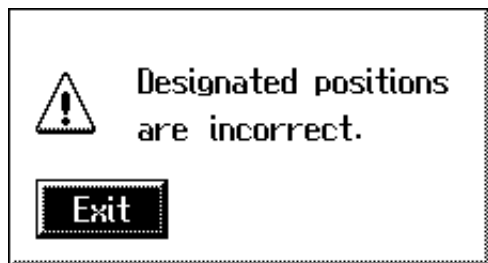

Displaying a Graphic at Power-up

The AT-90S/80S allows you to load a favorite graphic into internal memory, and have it be displayed when the power is turned on.

1. Use your computer to create a graphic image file that meets the following criteria:

Size	320 x 240 pixels
Color	8 bit (256 colors)
Format	image saved in BMP format
Name	1-8 characters in length (lowercase is ok). A filename extension of ".BMP" (uppercase characters) must be added after the name. The following characters can be used to name an image. A B C D E F G H I J K L M N O P Q R S T U V W X Y Z a b c d e f g h i j k l m n o p q r s t u v w x y z 0 1 2 3 4 5 6 7 8 9 # \$ % & ' () - @ ~ { } ^ _ ! NOTE If you use a character that cannot be used in a name, it will be replaced by another character when displayed.

2. Use your computer to save the graphic image file on a DOS format floppy disk.

3. Insert the floppy disk containing the graphic image file into the floppy disk drive of the AT-90S/80S.

4. Touch <System> on the Main screen.

The System screen appears.

5. In the System screen, touch <Utility>.

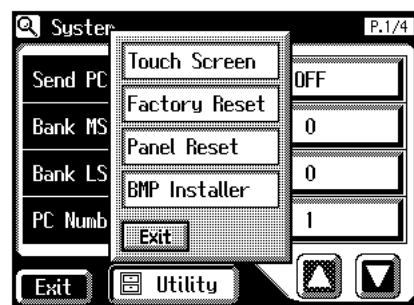

Chapter 9 Various Other Settings

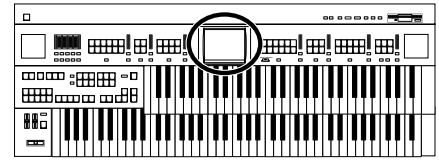

6. Touch <BMP Installer>.

The BMP Installer screen appears.

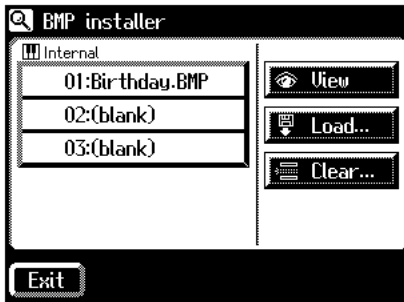

Display	Explanation
01-03	Images stored in internal memory
View	View an image stored in internal memory.
Load...	Load an image from floppy disk into internal memory.
Clear...	Delete an image from internal memory.

MEMO

The AT-90S/80S can store up to three images. If two or more images are stored in internal memory, those images will be displayed consecutively after the power is turned on.

7. In the screen, touch <01>-<03> to select the destination at which the image is to be saved.



8. Touch <Load...>.

The BMP Load screen appears.



The name of images saved on the floppy disk will be displayed.

9. Touch <▲>-<▼> to select the image that you want to load into internal memory.

MEMO

You can touch <View> to verify the image.

10. Touch <OK>.

The image will be loaded.

NOTE

If an image is already stored at the load destination, the following screen will appear.

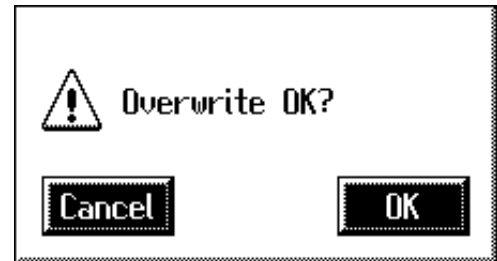

To erase the currently loaded image, and load the new image

1. Touch <OK>.

To cancel image loading

1. Touch <Cancel>.

NOTE

If the image cannot be loaded, the following screen will appear.

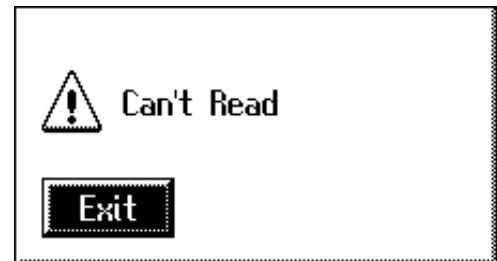

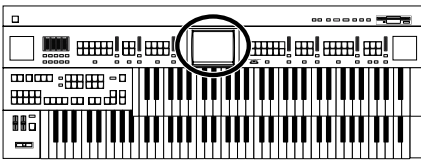

■ Deleting an Image Stored in Internal Memory

1. Touch <System> on the Main screen.
The System screen appears.
2. In the System screen, touch <Utility>.

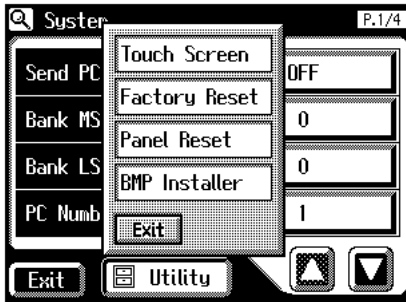

3. Touch <BMP Installer>.

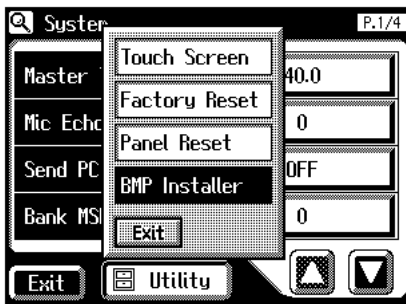

The BMP Installer screen appears.

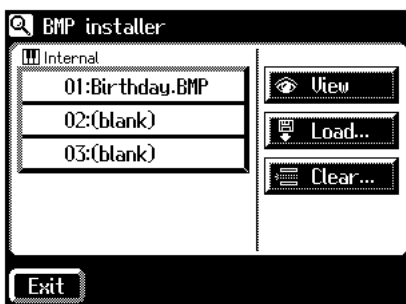

4. In the screen, touch <01>--<03> to select the destination at which the image is to be saved.



You can touch <View> to verify the image.

5. Touch <Clear...>.

The following screen appears.

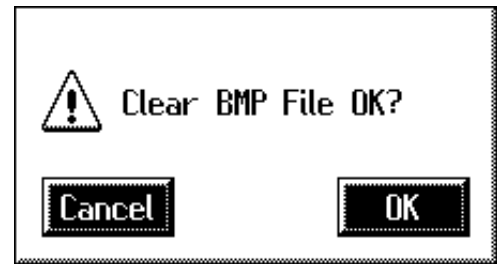

To cancel without deleting the image, touch <Cancel>.

6. Touch <OK>.

The image will be deleted.

Chapter 10 Connecting with External Device

Name and Functions of Jack and Connectors (AT-90S/80S)

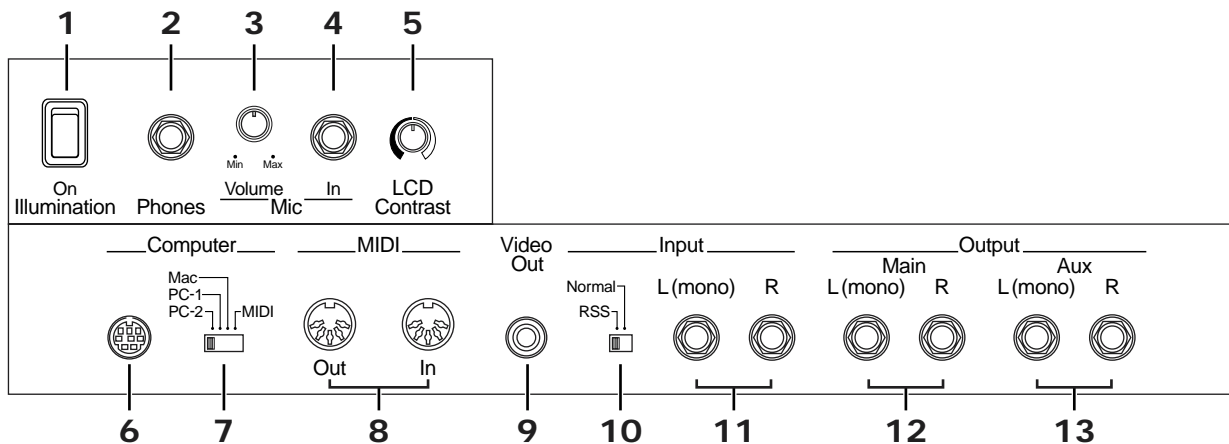

The functions of the jacks on the bottom of the keyboard are described below.

1. Illumination Switch → p. 21

2. Phones Jack → p. 20

3. Mic Volume Knob → p. 20

4. Mic In Jack → p. 20

5. LCD Contrast Knob

Adjust the brightness of the touch panel.

6. Computer Connector

You can connect a computer to the AT-90S/80S and exchange performance data between the two.

7. Computer Switch

Set this switch to Mac, PC-1, or PC-2 according to the type computer that's connected. Additionally, this switches between MIDI In connector and the Computer connector.

8. MIDI In/Out Connectors

You can connect external MIDI devices to the AT-90S/80S and exchange performance data between them.

9. Video Out Jack

You can connect a TV to display lyrics.

10. Input switch → (p. 180)

11. Input L(mono)/R Jacks

Using this jack, you can connect other sound generating devices or audio equipment and play sounds from other devices through the AT-90S/80S's speaker.

12. Output L(mono)/R Jacks

You can some sounds if you connect speakers or other audio equipment to these jacks. You can also hook up a cassette recorder to record your performances.

13. Aux Out L(mono)/R

You can connect an external speaker or a reverb unit to obtain a more spacious reverb.

Name and Functions of Jack and Connectors (AT-60S)

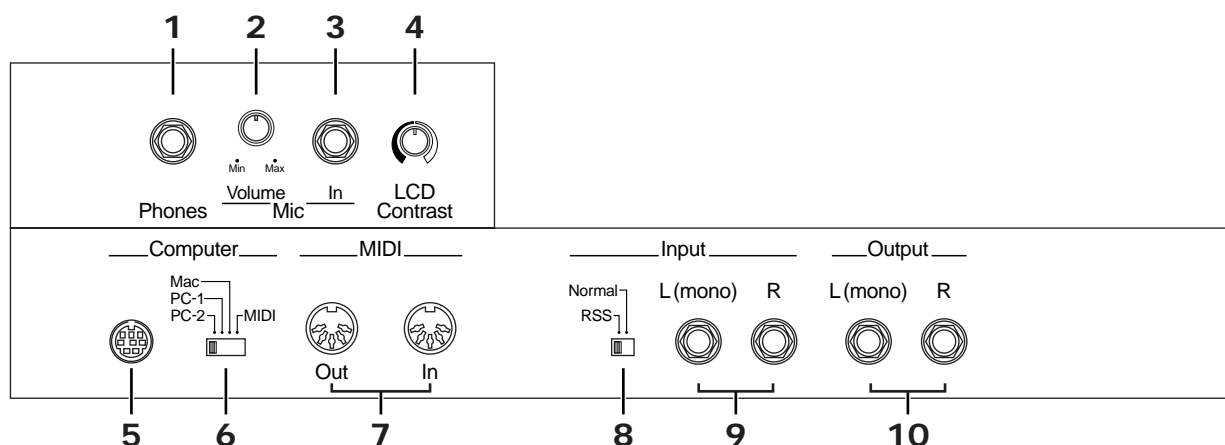

The functions of the jacks on the bottom of the keyboard are described below.

1. Phones Jack → p. 20

2. Mic Volume Knob → p. 20

3. Mic In Jack → p. 20

4. LCD Contrast Knob

Adjust the brightness of the touch panel.

5. Computer Connector

You can connect a computer to the AT-60S and exchange performance data between the two.

6. Computer Switch

Set this switch to Mac, PC-1, or PC-2 according to the type computer that's connected. Additionally, this switches between MIDI In connector and the Computer connector.

7. MIDI In/Out Connectors

You can connect external MIDI devices to the AT-60S and exchange performance data between them.

8. Input switch → (p. 180)

9. Input L(mono)/R Jacks

Using this jack, you can connect other sound generating devices or audio equipment and play sounds from other devices through the AT-60S's speaker.

10. Output L(mono)/R Jacks

You can some sounds if you connect speakers or other audio equipment to these jacks. You can also hook up a cassette recorder to record your performances.

Connecting to Audio Equipment

When you connect the AT-90S/80S/60S to audio equipment, you can play the sounds from the AT-90S/80S/60S through the speakers on the audio equipment or record your performances on a tape recorder or other recording device.



When connecting, please use an audio cable with a standard phone plug, such as the PCS-100PW (sold separately). When purchasing an audio cable, please consult the vendor where you bought the AT-90S/80S/60S.

Connectors

Output Jacks

You can connect audio equipment using audio cables (sold separately) and play the sounds from the AT-90S/80S/60S through the speakers on the connected equipment or record your performances on a tape recorder or other recording device.

If the input of the connected device is monaural, you must use the L (Mono) jack.

AT-90S/80S

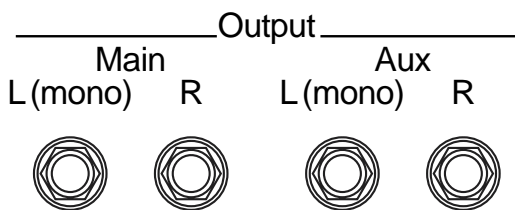

AT-60S

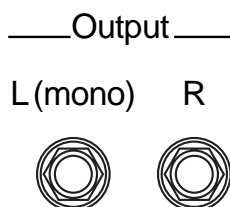

Input Jacks

You can connect another sound module, such as audio equipment or an electronic instrument using audio cables (sold separately) and play the sounds from the connected device through the speakers on the AT-90S/80S/60S.

If the input of the connected device is monaural, you must use the L (Mono) jack.

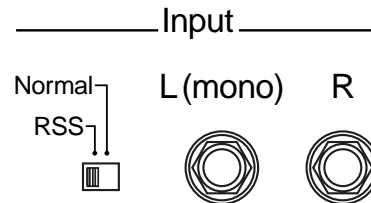

When using the Input jacks to play the sound from an external device through the speakers of the AT-90S/80S/60S, you can apply the internal RSS reverb of the AT-90S/80S/60S (p. 185).

Input switch position	Effect
Normal	The sound of the external device will be heard without modification.
RSS	The RSS reverb of the AT-90S/80S will be applied to the external device.



If the Input switch is set to “RSS,” you can use the AT-90S/80S/60S’s [Master Volume] knob to adjust the volume of the external device.



If the Input switch is set to “RSS,” RSS reverb will also be applied to the sound of the microphone. In this case, use the [Master Volume] knob to adjust the microphone volume.

Making the Connections



When connecting, turn on power to your various devices in the order specified. Failure to follow these steps in the order given could cause a malfunction and/or damage to speakers or other equipment.

Playing Sounds from the AT-90S/80S/60S Through the Speakers on Audio Equipment or Recording Your Performances on a Recording Device

1. Turn the volume all the way down on the AT-90S/80S/60S and on the device you’re about to connect.

2. Turn off the power to the AT-90S/80S/60S and other connected equipment.
3. Use audio cables (sold separately) to make the connection.
4. Switch on the AT-90S/80S/60S.
5. Switch on the connected device.
6. Adjust the volume level on the AT-90S/80S/60S and the connected device.

Recording AT-90S/80S/60S Performances on a Recording Device

7. Start recording with the connected device.
8. Play the keyboard.
9. When the performance ends, stop recording on the connected equipment.

Playing Audio Equipment Sounds Through the Speakers on the AT-90S/80S/60S

1. Turn the volume all the way down on the AT-90S/80S/60S and on the device you're about to connect.
2. Turn off the power to the AT-90S/80S/60S and other connected equipment.
3. Use audio cables (sold separately) to make the connection.
4. Turn on the connected equipment.
5. Turn on the AT-90S/80S/60S.
6. Adjust the volume level on the AT-90S/80S/60S and the connected device.

After use, turn off the power using the following procedure.

1. Turn the volume all the way down on the AT-90S/80S/60S and on the device you're about to connect.
2. Turn off the connected equipment.
3. Turn off the AT-90S/80S/60S.

Connecting a Computer

By connecting this to the serial port of your computer, you can transmit and receive musical data.

Connectors

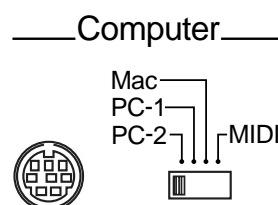

Computer Connector

You can connect a computer to this connector to exchange performance data.

Use a computer cable (sold separately) to make the connection.

The type of cable required will depend on your computer.

Computer Switch

The setting for this switch is made depending on the computer connected- Mac/PC-1/PC-2.

When this switch is set to MIDI, this connector cannot be used.

Making the Connections

NOTE

When connecting, turn on power to your various devices in the order specified. Failure to follow these steps in the order given could cause a malfunction and/or damage to speakers or other equipment.

1. Turn off the AT-90S/80S/60S and the computer.
2. Using a compatible computer cable (sold separately), connect the Computer connector on the bottom of the keyboard with the computer's serial port.
3. Set the computer switch on the underside of the keyboard to match the type of computer connected.

Please refer to the connection examples below.

NOTE

Change the setting of the Computer switch only after the power to the unit is off.

Chapter 10 Connecting with External Device

4. Turn on the computer.
5. Turn on the AT-90S/80S/60S.
6. Make the settings for baud rate (transmission speed) for the computer and the software.



For more information on this procedure, please refer to the owner's manual for your computer.

7. You should also make the settings for the MIDI send channel as needed (p. 174).

Connection Examples:

Connection with an Apple Macintosh computer

Use a computer cable (sold separately) to connect the Computer connector on the AT-90S/80S/60S to the modem port (or printer port) on the Apple Macintosh. Set the Computer switch to "Mac."

When using the Macintosh "Patch Bay" utility, specify 1 MHz as the Interface Type (MIDI Interface Clock).

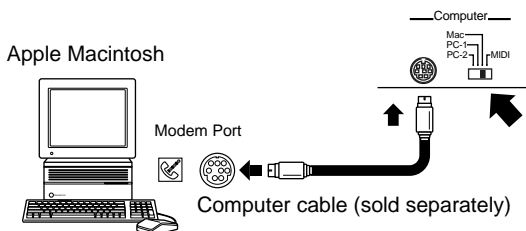

Connection with an IBM PC

Use a computer cable (sold separately) to connect the Computer connector on the AT-90S/80S/60S to the COM1 or COM2 serial port on the IBM PC. Set the Computer switch to "PC-2."

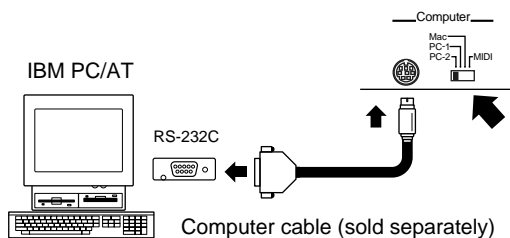

Connecting MIDI Devices

By connecting an external MIDI device and exchanging performance data, you can control the performances on one device from the other. For instance, you can output sound from the other instrument or switch Tones on the other instrument.

What's MIDI?

MIDI, short for "Musical Instrument Digital Interface," was developed as a standard for the exchange of performance data between electronic instruments and computers.

The AT-90S/80S/60S is equipped with MIDI connectors and a Computer connector to let it exchange performance data with external devices. These connectors can be used to connect the AT-90S/80S/60S to an external device for even greater versatility.

About MIDI Connectors

The AT-90S/80S/60S has two kinds of MIDI connectors.

Connecting these to the MIDI connectors on a MIDI instrument makes it possible for the two instruments to control each other.

For instance, you can output sound from the other instrument or switch tones on the other instrument.

You should also set the MIDI send channel as needed.

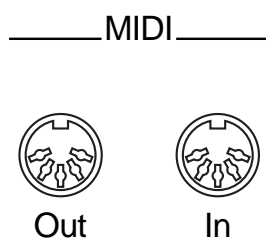

MIDI Out Connector

Only the notes played on the keyboard, movements of the Damper pedal, Expression data, and data indicating that a Registration button [1]-[12] (on AT-60S, Registration [1]-[8]) was pressed will be transmitted to the external MIDI connector. The Solo voice will be transmitted only if the Solo [To Lower] button is ON.

MIDI In Connector

Performance messages from an external MIDI device are received here.

These incoming messages may instruct the receiving MIDI instrument to play sounds or switch tones.

The AT-90S/80S/60S contains two sound generators: one sound generator for its own keyboards and one GS sound generator (p. 213). Normally, musical data transmitted from an external device to the MIDI In connector is sent to the GS sound generator, but you can also set the "MIDI IN Mode" parameter (p. 173) so that the keyboard sound generator is controlled.

Making the Connections

NOTE

When connecting, turn on power to your various devices in the order specified. Failure to follow these steps in the order given could cause a malfunction and/or damage to speakers or other equipment.

- 1. Turn the volume all the way down on the AT-90S/80S/60S and on the device you're about to connect.**
- 2. Switch off the power to the AT-90S/80S/60S and the device you're about to connect.**
- 3. Set the Computer switch on the bottom of the unit to "MIDI."**
- 4. Use a MIDI cable (sold separately) to connect the MIDI connectors to each other.**
- 5. Switch on the power to the AT-90S/80S/60S and the connected device.**
- 6. Adjust the volume level on the AT-90S/80S/60S and the connected device.**
- 7. You should also set the MIDI send channel as needed.**

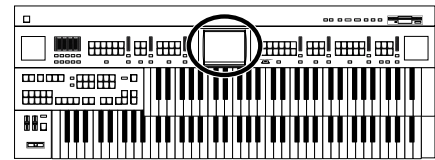

Connecting a Television to View the Lyrics (AT-90S/80S only)

You can connect a television to view the lyrics from SMF music files.

Making the Connections

NOTE

When connecting, turn on power to your various devices in the order specified. Failure to follow these steps in the order given could cause a malfunction and/or damage to speakers or other equipment.

1. Switch off the power to the AT-90S/80S and television.
2. Use video cables (sold separately) to make the connection.
3. Switch on the television.
4. Turn on the AT-90S/80S.
5. Touch <System> on the Main screen.

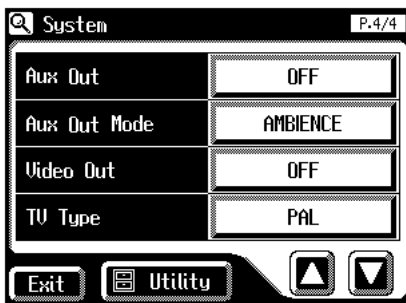

6. Touch the Video Out setting to select "ON."

Each time you touch the Video Out setting, it will alternate between "ON" and "OFF."

7. Touch <Exit>.
8. Play back the music files with lyric.

The lyric appears on the display.

NOTE

If lyric will be not displayed on the screen, please switch the TV format.

Switching the TV Format

1. Touch <System> on the Main screen.

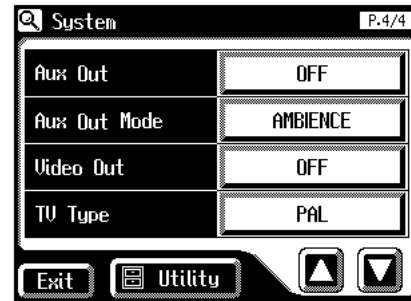

2. Touch the TV Format setting to switch between "PAL" and "NTSC."

Each time you touch the TV Format setting, it will alternate between "PAL" and "NTSC."

Settings: PAL, NTSC

3. Touch <Exit>.

MEMO

This setting remains stored in memory even while power is turned off.

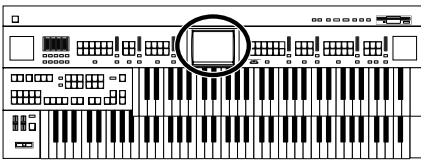

Connecting External Speakers or an external Reverb Unit to Broaden the Reverb (RSS Reverb)

The AT-90S/80S has an Aux Out jack on the bottom of the instrument.

By using this Aux Out jack to connect external speakers, you can sound the reverb (reverberation) from the speakers. An external reverb unit can also be connected and used to apply reverb.

Switching the Aux Out Mode

1. Touch <System> on the Main screen.

The System screen appears.

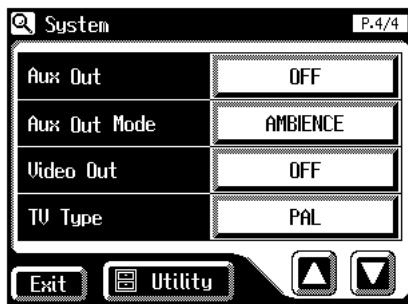

2. Touch the Aux Out Mode setting to switch between “AMBIENCE” and “TO EFFECTOR.”

Each time you touch the TV Format setting, it will alternate between “AMBIENCE” and “TO EFFECTOR.”

AMBIENCE	The reverb sound applied by the ATELIER will be output.
TO EFFECTOR	Direct (unprocessed) sound for processing by reverb will be output.

3. Touch <Exit>.



You can change the depth of Reverb for each part (p. 117).



This setting remains stored in memory even while power is turned off.

Switching the Aux Out On/OFF

1. Touch <System> on the Main screen.

The System screen appears.

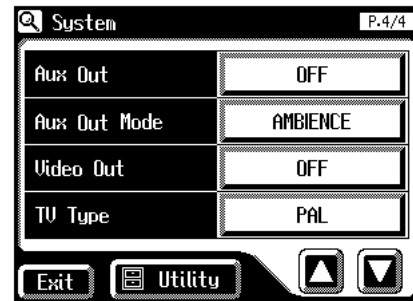

2. Touch the Aux Out setting to switch between “ON” and “OFF.”

Each time you touch the Aux Out setting, it will alternate between “ON” and “OFF.”

3. Touch <Exit>.



This setting remains stored in memory even while power is turned off.

Troubleshooting

If the AT-90S/80S/60S does not function in the way you expect, first check the following chart. If this does not resolve the problem, consult your dealer or a nearby Roland Service Station.

Problem	Check	Solution	Page
When you press the [Power On] switch, the power doesn't come on.	Power cord is not connected correctly.	Connect the power cord correctly.	p. 19
No sound is heard.	The [Master Volume] slider is set too low.	Turn the [Master Volume] knob toward "Max."	p. 19
	Headphones are connected. When you connect the headphones, the sound is heard only through the headphones.	If you want sound to be output from the speakers, disconnect the headphones.	p. 20
	The volume is set too low on the Level [▲] [▼] buttons.	Press the Level [▲][▼] buttons to raise the volume.	p. 48
	The volume is set too low on the Expression Pedal.	Advance the expression pedal.	p. 103
	You do not have a Voice selected. Voices that have their button indicator lit can be played.	Press a voice button to select a voice.	p. 34
No sound is heard. (by the Upper keyboard)	You have selected Drums/SFX for the Lower keyboard, and are playing a key to which no drum sound or Sound Effect has been assigned.	Either turn off Drums/SFX, or play a note to which a drum sound or sound effect is assigned.	p. 54– p. 55
No sound is heard. (by the Lower keyboard)	"Percussion Set 3" has been selected for the Upper keyboard. When "Percussion Set 3" is selected, some keys may have no sound assigned to them.	For the upper keyboard, select a voice other than "Percussion Set 3."	p. 37
No sound is heard. (by the pedalboard)	Pedal cord is not connected correctly.	Use the pedal cable to connect the pedal correctly.	p. 18
No sound is heard (when a MIDI instrument is connected).	The power of the connected external devices is not turned on.	Use the correct procedure to turn on the power of the connected external devices.	p. 180 – p. 185
	The Computer switch on the bottom of the unit is not set to "MIDI."	Change the setting of the computer switch.	p. 183
Damper Pedal does not operate.	The damper pedal affects only the Lower keyboard and Upper keyboard. The damper pedal does not affect the Bass pedalboard.	You can change the settings so that the damper pedal affects the Upper keyboard.	p. 163
	The damper pedal does not affect the Solo voice.	This is not a malfunction.	---
Expression Pedal does not operate.	The function of the Expression Pedal during recording or the function during playback has been set to "COMPOSER."	Set the expression pedal function during recording to "PEDAL," and during playback to "PEDAL" or "PEDAL+COMP."	p. 162

Problem	Check	Solution	Page
Can't use the function assigned to the foot switch.	If "Regist Shift" (change Registrations) is "RIGHT" or "LEFT," the foot switch will be dedicated to switching the Registration.	Turn "Regist Shift" off.	p. 162
When the human voice "Jazz Scat" is selected, playing dynamics do not change the sound.	The setting of "Initial Touch" is turned OFF.	Turn "Initial Touch" off.	p. 158
Rotary effect is not be applied.	Some sounds do not allow the rotary effect to be applied.	This is not a malfunction.	---
Chorus effect does not apply.	Some sounds do not allow the chorus effect to be applied.	This is not a malfunction.	---
When you release your fingers from keys in the Lower keyboard while Automatic Accompaniment and Rhythm are playing, the Rhythm performance only remains playing.	Chord Hold is at OFF.	Turn "Chord Hold" on. The Automatic Accompaniment will play while you press a chord. If Chord Hold is turned ON, the Automatic Accompaniment will continue playing with the Rhythm even when you take your hand off of the Lower keyboard.	p. 165
When you release your fingers from keys in the Lower keyboard, the notes continue sounding.	The Lower Voice [Hold] button is at ON.	Press the Lower Voice [Hold] button to turn it off (dark).	p. 56
Even though you press only one key, a multiple number of notes sound.	Harmony Intelligence is at ON.	Turn "Harmony Intelligence" off.	p. 106, p. 109
	Chord Intelligence is turned ON.	Turn "Chord Intelligence" off.	p. 164
Sound is produced when you take your finger off a key.	You have selected a "Marimba" or "Banjo" sound.	This is not a malfunction. If you select a "Marimba" or "Banjo" sound, a sound will also be produced when you take your finger off the key.	---
Automatic Accompaniment sounds odd.	The keys for a chord were not pressed simultaneously.	Either turn on the Chord Intelligence function, or play the chord correctly.	p. 164
	When Chord Intelligence is OFF, the chord is not being pressed correctly.	Either turn on the Chord Intelligence function, or play the chord correctly.	p. 164
	When performance data from a device other than the AT-90S/80S/60S is being played together with the Automatic Accompaniment, the Automatic Accompaniment may not be sounded correctly.	This is not a malfunction.	---
Rhythm sounds odd.	When performance data from a device other than the AT-90S/80S/60S is being played together with the Automatic Accompaniment, the Rhythm performance may not be sounded correctly.	This is not a malfunction.	---

Troubleshooting

Problem	Check	Solution	Page
Pitch is off	Transpose is in effect.	Simultaneously press the Transpose [-][+] buttons to cancel the transposition (the Transpose [-][+] buttons' indicators will go out).	p. 102
	The tuning is incorrect.	Adjust the standard pitch.	p. 171
	While set for an octave shift (p. 31), you are playing keys beyond the recommended range. This does not indicate a malfunction.	Adjust the Octave Shift setting.	p. 50
Recording is not possible.	If you wish to erase a previously-recorded track and then re-record, touch the track button for the desired track to make that button blink before you begin recording.	On Rec/Play screen, touch the track button for the desired track to make that button indicator blink before you begin recording.	p. 136
The recorded performance has disappeared.	Any performance that has been recorded is deleted when the power to the unit is turned off.	A performance cannot be restored once it's been deleted, so be sure to save it on a floppy disk before you turn off the power.	p. 139
The bass note of the Automatic Accompaniment does not sound.	When a voice is selected for the Pedal Bass part, the bass of the Automatic Accompaniment will not sound.	This is not a malfunction.	---
When you started a Rhythm with an Intro, the Rhythm did not sound.	Some Rhythms do not have rhythm sounds in the intro.	This is not a malfunction.	---
MIDI messages received at MIDI In are not sounded.	The Computer switch is not set to "MIDI" position.	Set the Computer switch to "MIDI."	p. 183
	The Computer switch was set to "MIDI" after the power was turned on.	Turn off the power, and then turn the power on once again.	p. 183
Sound is distorted / cracked.	The Part Balance volume of each part is too high.	Press the Part Balance button to lower the volume.	p. 48
	The Reverb volume has been raised when the volume of each Part Balance button is already raised.	Either lower the Reverb volume, or adjust the Part Balance of each part.	p. 48 p. 115
	The [Master Volume] slider has been used to raise the overall volume excessively.	Use the [Master Volume] knob to lower the overall volume.	p. 19
Some keys (of certain keyboard parts) sound strange.	You are playing notes outside the recommended range of the voice.	This is not a malfunction.	---
The Rhythm does not change when you press the Registration buttons.	The settings at which Registrations are recalled (Registration Arranger Update) has been set to "DE-LAYED."	Set the timing at which the arranger settings are called up (Registration Arranger Update) to "INSTANT."	p. 166
The volume changes during playback of performance data.	When recording is performed repeatedly while changing the Part Balance volume, the previously-recorded Part Balance data remains in the Control track.	If you wish to get rid of the volume changes, use the Erase function to delete the Part Balance data.	p. 152

Problem	Check	Solution	Page
Bass is heard even though you are not playing the Bass Pedalboard.	The Pedal [To Lower] button or the [Bass Split] button is ON. When the Pedal [To Lower] button is ON, the Bass will be sounded by the Lower keyboard.	In the Pedal part, press the Pedal [To Lower] button or [Bass Split] button to turn the button off (dark).	p. 125 p. 126
When playing the same sound in the Upper keyboard and Lower keyboard, the volume is different.	On one of the keyboards, “Initial Touch” is turned ON.	Set the initial touch settings of the Upper keyboard and the Lower keyboard to both On, or both Off.	p. 158
Lower keyboard cannot be heard.	The Lower keyboard will not produce sound while an Intro or Ending is being played.	This is not a malfunction.	---
The sound is not played correctly.	If you layer the same type of sound (for example, Strings 1 and Strings 5), or play an octave-shifted organ sound, the timing at which you play a note or the phase relationship between the two sounds may affect the way in which the sounds are heard, but this is not a malfunction.	You are layering sounds of the same type (e.g., Strings 1 and Strings 5). Alternatively, you are playing an organ sound with Octave Shift. This is not a malfunction.	---
Can't play the demo songs.	A floppy disk is inserted in the disk drive.	In order to play the demo song, you must remove the floppy disk from the disk drive.	p. 68
Nothing appears on screen.	The AT-90S/80S/60S uses a liquid-crystal screen, so text may not be displayed when the ambient temperature is below freezing.	Adjust the brightness of the screen.	p. 178
Lyrics are not indicated properly in the display.	With some music files, the lyrics cannot be displayed correctly.	This is not a malfunction.	---
	In the Score screen, some lyrics or notes could extend beyond the edges of the screen, and not be displayed.	This is not a malfunction.	---
	A button was pressed while the lyrics were being shown in the display. During the display of lyrics, you could be taken to a different screen if you press a button.	If you want to have the lyrics be displayed again, press the [Play/Stop] button.	p. 129
The Touch Screen doesn't respond correctly.	The positioning of the Touch Screen may become displaced if some time has passed since it was last used	Reposition the Touch screen.	p. 175
Certain instrument are not heard while playing a song.	The track is muted.	Turn off track muting.	p. 134
Can't use Chord Intelligence function.	Chord Intelligence is at OFF.	Turn “Chord Intelligence” on.	p. 164

Troubleshooting

Problem	Check	Solution	Page
Score is not indicated properly in the display.	In the Score screen, some lyrics or notes could extend beyond the edges of the screen, and not be displayed.	This is not a malfunction.	---
	The score display feature is particularly unsuitable for the display of difficult, complex musical works that demand accurate notation.	This is not a malfunction.	p. 148
	If you select a part that does not contain performance data, notes will not be displayed in the score.	Change the part that is displayed.	p. 146
Vertical lines can be seen in the screen.	This is attributable to the design fundamentals of a liquid crystal display, and does not indicate a malfunction.	Adjusting the display's contrast can make such lines less noticeable, so you may want to try adjusting it.	p. 178
The Bass Range Sounds Odd, or There Is a Vibrating Resonance.	Playing at loud volumes may cause instruments near the AT-90S/80S/60S to resonate. Resonance can also occur with fluorescent light tubes, glass doors, and other objects. In particular, this problem occurs more easily when the bass component is increased, and when the sound is played at higher volumes.	Use the following measures to suppress such resonance. Place speakers so they are 10-15 cm from walls and other surfaces. Reduce the volume. Move the speakers away from any resonating objects.	---
	When listening through headphones: Here, a different cause (such as resonance produced by the AT-90S/80S/60S) would be suspect.	Consult your Roland dealer or nearest Roland Service Center.	---
The volume level of the instrument connected to AT-90S/80S/60S is too low.	Could you be using a connection cable that contains a resistor?	Use a connection cable that does not contain a resistor.	p. 180

Error Message

Error Message	Meanings
Copy Protected. Can't Save	To protect the copyright, this music file cannot be saved as SMF format.
	When you want to save as Atelier format, you can save only original disk.
Can't Save This Song.	You can only play the music data. It cannot be saved on a floppy disk or internal memory.
Write Protected Disk	The protect tab on the floppy disk is set to the Protect position. Change it to the Write position and repeat the procedure.
Master Disk	This floppy disk cannot store the format or save any data. Insert a different disk and repeat the procedure.
Read Only Song. Can't Save	A new song cannot be saved onto this floppy disk.
No Disk	No floppy disk is connected to the disk drive. Insert the disk correctly, and repeat the procedure.
Disk Full	There is not sufficient space left on the floppy disk for the data to be saved. Save the data onto a different floppy disk or delete music data on the disk.
Unknown Disk	The floppy disk inserted into the disk drive cannot be read. Please format the floppy disk.
Disk Ejected	The floppy disk was removed from the disk drive while loading or writing was in progress. Insert the floppy disk and repeat the procedure.
Damaged Disk	This floppy disk is damaged and cannot be used. Insert a different disk and repeat the procedure.
Can't Read	This song cannot be read.
Can't Play	It cannot be read the floppy disk quickly enough. Press the [Reset] button, then press the [Play/Stop] button to play the song.
Memory Full	The Rhythm data is excessively large, and cannot be loaded.
	The performance data is excessively large, and cannot be loaded.
	Since the internal memory is full, recording or editing is not possible.
MIDI Buffer Full	The AT-90S/80S/60S cannot deal with the excessive MIDI data sent from the external MIDI device. Reduce the amount of MIDI data sent to the AT-90S/80S/60S.
Communication Error	A MIDI cable or computer cable has been disconnected. Connect it properly and securely.
Computer I/F Error	The Computer Switch is set to a wrong position or the computer is set wrongly. Switch off the AT-90S/80S/60S then set the Computer Switch to the correct position and set the computer correctly. After that, switch on the AT-90S/80S/60S again.
Memory Error	There is something wrong with the system. Repeat the procedure from the beginning.

Error Message

Error Message	Meanings
Internal Memory Near Limit	The AT-90S/80S/60S is warning you that its memory will soon become full to capacity, so not much more recording can be done.
Clear Song OK?	To carry out the procedure, you first need to erase performance data in the AT-90S/80S/60S. This message asks you to confirm that you don't mind doing this. To erase the data, touch <OK> on the screen. When you do not want to erase it, touch <Cancel> then save the data on disk.
Overwrite Regist OK?	This Registration is already being used. To overwrite the previous Registration data in this memory, touch <OK>. If you decide to keep the previous Registration data in this memory and save your settings in an unused memory, select a number for which "-" is displayed, and then save the data.
Overwrite Song OK?	There already is performance data having the same name on the disk. To replace the existing data with the new version, touch <OK>. To save it as a separate new file, touch <Cancel> first. Then, after changing the name, save it on disk.
Overwrite Rhythm OK?	Overwrite the internal Rhythm. To replace the Rhythm, touch <OK>. When you do not want to overwrite it, touch <Cancel> then select another Rhythm.
Delete Song OK?	Delete the song stored on floppy disk. To delete the song, touch <OK>. When you do not want to delete it, touch <Cancel>.
Delete Rhythm OK?	Delete the Rhythm. To delete the Rhythm, touch <OK>. When you do not want to delete it, touch <Cancel>.



Voice List (AT-90S/80S)

■ Organ

Full Organ1	*1
Full Organ2	*1
Full Organ3	*1
Full Organ4	*1
Full Organ5	*1
Full Organ6	*1
Full Organ7	*1
Full Organ8	*1
Full Organ9	*1
Jazz Organ1	*1
Jazz Organ2	*1
Jazz Organ3	*1
Jazz Organ4	*1
Jazz Organ5	*1
Jazz Organ6	*1
Rock Organ1	
Rock Organ2	
Lower Organ1	*1
Lower Organ2	*1
Lower Organ3	*1
Lower Organ4	*1
Lower Organ5	*1
Lower Organ6	*1
Pipe Organ1	
Pipe Organ2	
Pipe Organ3	
Pipe Organ4	
Pipe Organ5	
Pipe Organ6	
Pipe Organ7	
 AEx PipeOrg	
Diapason 8'	
FluteCeleste	
Gemshorn 8'	
Trompet 8'	
Hautbois 8'	
Viola 8'	
ViolaCeleste	
Bombarde16'	
T.String 8'	*2
VoxHumana 8'	*2
T.Tuba 8'	*2
T.Trumpet 8'	*2
T.Sax 8'	*2

T.Oboe 8'	*2
T.Krumet 8'	
Eng.Horn 8'	
Tibia 8'	*2
Theater Or.1	*2
Theater Or.2	*2
Theater Or.3	*2
Theater Or.4	*2
Theater Or.5	*2
Theater Or.6	*2
Theater Or.7	*2
 AEx Theater	*2
Synth. Org.1	*2
Synth. Org.2	
Synth. Org.3	*2
Synth. Org.4	*2
Digi Church	*2
Metalic Org.	*2
Pop. Organ1	*1
Pop. Organ2	*1
Pop. Organ3	*1
Org. Attack1	
Org. Attack2	
Org. Attack3	
Org. Attack4	
Org. Click	

■ Strings

Chamber Str	*2
Chamber Str2	*2
Orch.Str.Ens	*2
Strings1	
Strings2	
Strings3	*2
Strings4	*2
Strings5	
Strings6	
Strings7	*2
Strings8	*2
 AEx Strings	
 AEx Str+Brs	
 AEx Str+Chr	
Slow Str.1	
Slow Str.2	
Slow Str.3	*2

Synth. Str.1	
Synth. Str.2	
Synth. Str.3	
Synth. Pad1	
Synth. Pad2	
Synth. Pad3	
Violin	*2
 AEx Violin	*2
Viola	*2
Cello	*2
Cello 2	*2
Pizzicato	*2
Mellow Pizz.	*2

■ Human Voice

Jazz Scat	*2
Jazz Scat 2	
Jazz Scat 3	
Jazz Doo	*2
Jazz Doot	*2
Jazz Dat	*2
Jazz Bap	*2
JazzDowfall	*2
Soprano	*2
Soprano 2	
Tenor	
Tenor&Sop.	
Pop Voice	*2
Classical	
Boys Choir	
Boys Choir2	*2
Kids Choir	*2
Gregorian	
Gospel	
Choir	
Female 1	
Female 2	*2
 AEx Choir	
Synth. Choir	
Synth. Voice	*2
Space Voice	
Dreamy Choir	*2
Vocal Menu	
Choir Chord	



*1 : Rotary: effective, Chorus: ineffective

*2 : Vibrato: effective, Aftertouch: effective

 : Active Expression Voice

Voice List (AT-90S/80S)

■ Piano

Grand Piano	
Piano1	
Piano2	
Piano3	
 AEx PianoStr	
Honky-tonk	
Honky-tonk2	
Stage Rhodes	*2
Dyno Rhodes	*2
E.Piano1	
E.Piano2	
E.Piano3	
E.Piano4	*2
 AEx EP+Str	
Harpsichord	
Clavi.	

■ Guitar

Nylon-str.Gt	*2
Nylon Gt.2	*2
Fl.Guitar	*2
Fl.Gtr Roll	*2
Requint Gt.	*2
 AEx Gtr+Str	*2
Ac.Gtr Sld	*2
Ac.Gtr Hrm	*2
Steel-str.Gt	*2
12str Guitar	*2
SemAc.Guitar	*2
Jazz Guitar	*2
Clean Guitar	*2
JC E.Guitar	*2
Overdrive Gt	*2
DistortionGt	*2
Power Guitar	*2
Rock Rhythm	*2
Muted Guitar	*2
Hawaiian Gt.	*2
Banjo	*2
Banjo Trembl	*3
Mandolin	
Koto	*2
Taisho Koto	*2

Shamisen	*2
Harp	*2
Harp 2	*2
Celtic Harp	*2
Nylon Harp	*2
Harpvox	*2
Sitar	*2
Organ Harp	*2

■ Brass

BrassSect.1	*2
BrassSect.2	
Tp. Section	*2
Brass 1	*2
Brass 2	*2
Brass 3	
Power Brass	*2
Quad Brass	*2
FatPop Brass	*2
Brass Fall	*2
Twin Bones	*2
Bones Sect.	*2
 AEx Brass	*2
Orch.Tutti 1	*2
Orch.Tutti 2	*2
Orch.Tutti 3	*2
Fr.Horn Sect	
Fr.HornSect2	
Fr.HornSect3	
Fr.HornSect4	*2
Orch.Brs Ens	*2
MutedFr.Horn	*2
Sax.Section	*2
Sax.Section2	*2
Sax.Section3	*2
Sax/Brass	
Sax&Clarinet	*2
Synth. Brass	*2
Trumpet	*2
Trumpet2	*2
Trumpet3	
Tp/Shake	*2
Mariachi Tp.	*2
Trumpet Fall	*2
Twin Tp.	*2

 AEx Trumpet	*2
Mute Trumpet	*2
MuteTrumpet2	*2
Cup Mute Tp.	*2
Flugel Horn	*2
Trombone	*2
Trombone2	*2
F.Horn Solo1	*2
F.Horn Solo2	*2
Soprano Sax	*2
Soprano Sax2	*2
Alto Sax Ex	*2
Alto Sax	*2
Alto Sax2	*2
Blow Sax	*2
 AEx AltoSax	*2
Super Tenor	*2
Tenor Sax	*2
Tenor Sax2	*2
BaritoneSax	*2

■ Woodwinds

Flute	*2
Flute2	*2
Flute3	*2
 AEx Flute	*2
Piccolo	*2
Tin Whistle	*2
Synth. Flute	
Pan Flute	*2
Pan Flute 2	*2
BottleBlow	*2
Oboe	*2
 AEx Oboe	*2
Bassoon	*2
Bassoon 2	*2
English Horn	*2
Wood Winds	*2
Wood Winds 2	*2
Clarinet	*2
Clarinet2	*2
Clarinet3	*2
Clarinet4	*2
Bs Clarinet	*2
Shakuhachi	*2

*1 : Rotary: effective, Chorus: ineffective *2 : Vibrato: effective, Aftertouch: effective  : Active Expression Voice

HumanWhistle *2
 Bagpipe *2
 Uilleann Pipe *2

Voice Thum *2

Bird *2

■ Lead

Synth. Lead1 *2
 Synth. Lead2 *2
 Synth. Lead3 *2
 Synth. Lead4 *2
 Synth. Lead5 *2
 CC Solo *2
 JP SuperSaw *2
 Sugar Key *2
 HollowReleas *2
 Accordion
 Bandoneon *2
 Harmonica *2
 Blues Harp *2

■ Percussion

Timpani
 Timpani2
 Soft Timpani
 Ride Cymbal
 Crash Cymbal *2
 Short Cymbal
 MalletCymRol *2
 Tambourine
 Castanet
 Triangle *2
 Woodblock
 Woodblock 2 *2
 Snare Drum
 Bass Drum
 Jingle Bell *2
 Church Bell
 Perc. Set1
 Perc. Set2
 Perc. Set3 *2
 Orch.HitMenu
 DanceHitMenu
 AcGtrNzMenu
 Vibraphone *2
 Glockenspiel
 Celesta
 Music Box *2
 Marimba
 MarimbaTrem1 *3
 Xylophone
 Barafon *2
 Tubular-bell
 Steel Drums
 Steel Drums2 *2
 Kalimba *2
 Santur *2
 Organ Bell
 Vibra Bells *2
 Digi Bells *2
 Hand Bell *2
 Finger Snap
 Footsteps
 Key Typing

■ Bass

Organ Bass1
 Organ Bass2
 Pipe Org. Bs
 Theater Bass
 Bombarde
 String Bass *2
 Bass+Cymbal *2
 String Bass2 *2
 Str.Bass Pdl *2
 Str.BassSolo *2
 Baby Bass *2
 Contrabass1 *2
 Contrabass2 *2
 AEx Bs+Timp
 E.Bass1
 E.Bass2 *2
 E.Bass3 *2
 E.Bass4 *2
 E.Bass5 *2
 Tuba
 Tuba2 *2
 Tuba3 *2
 Synth. Bass1
 Synth. Bass2

*3 : The sounds will also be produced when you take your finger off the key.

Voice List (AT-60S)

■ Organ

Full Organ1	*1
Full Organ2	*1
Full Organ3	*1
Full Organ4	*1
Full Organ5	*1
Full Organ6	*1
Full Organ7	*1
Jazz Organ1	*1
Jazz Organ2	*1
Jazz Organ3	*1
Jazz Organ4	*1
Jazz Organ5	*1
Jazz Organ6	*1
Rock Organ1	
Rock Organ2	
Lower Organ1	*1
Lower Organ2	*1
Lower Organ3	*1
Lower Organ4	*1
Lower Organ5	*1
Lower Organ6	*1
Pipe Organ1	
Pipe Organ2	
Pipe Organ3	
Pipe Organ4	
Pipe Organ5	
Pipe Organ6	
Pipe Organ7	
 AEx PipeOrg	
Diapason 8'	
FluteCeleste	
Gemshorn 8'	
Trompet 8'	
Hautbois 8'	
Viola 8'	
ViolaCeleste	
Bombarde16'	
T.String 8'	*2
VoxHumana 8'	*2
T.Tuba 8'	*2
T.Trumpet 8'	*2
T.Sax 8'	*2
T.Oboe 8'	*2
T.Krumet 8'	

Eng.Horn 8'

Tibia 8'	*2
Theater Or.1	*2
Theater Or.2	*2
Theater Or.3	*2
Theater Or.4	*2
Theater Or.5	*2
Theater Or.6	*2
Theater Or.7	*2
Synth. Org.1	*2
Synth. Org.2	
Synth. Org.3	*2
Synth. Org.4	*2
Pop. Organ1	*1
Pop. Organ2	*1
Pop. Organ3	*1
Org. Attack1	
Org. Attack2	
Org. Attack3	
Org. Attack4	
Org. Click	

■ Strings

Strings1	
Strings2	
Strings3	*2
Strings4	*2
Strings5	
Strings6	
Strings7	*2
Strings8	*2
 AEx Strings	
Slow Str.1	
Slow Str.2	
Slow Str.3	*2
Synth. Str.1	
Synth. Str.2	
Synth. Str.3	
Synth. Pad1	
Synth. Pad2	
Violin	*2
Viola	*2
Cello	*2
Pizzicato	*2

■ Human Voice

Jazz Scat	*2
Jazz Doo	*2
Jazz Doot	*2
Jazz Dat	*2
Jazz Bap	*2
JazzDowfall	*2
Pop Voice	*2
Classical	
Boys Choir	
Gregorian	
Choir	
Synth. Choir	
Synth. Voice	*2
Space Voice	
Dreamy Choir	*2
Vocal Menu	

■ Piano

Grand Piano	
Piano1	
Piano2	
Piano3	
 AEx PianoStr	
Honky-tonk	
Honky-tonk2	
Stage Rhodes	*2
E.Piano1	
E.Piano2	
E.Piano3	
E.Piano4	*2
Harpsichord	
Clavi.	

■ Guitar

Nylon-str.Gt	*2
Nylon Gt.2	*2
 AEx Gtr+Str	*2
Ac.Gtr Sld	*2
Steel-str.Gt	*2
12str Guitar	*2
Jazz Guitar	*2
Clean Guitar	*2
JC E.Guitar	*2

*1 : Rotary: effective, Chorus: ineffective

*2 : Vibrato: effective, Aftertouch: effective

 : Active Expression Voice

Overdrive Gt	*2
Hawaiian Gt.	*2
Banjo	*2
Banjo Tremol	*3
Mandolin	
Koto	*2
Taisho Koto	*2
Shamisen	*2
Harp	*2
Harpvox	*2
Sitar	*2
Organ Harp	*2

■ Brass

BrassSect.1	*2
Tp. Section	*2
Power Brass	*2
 AEx Brass	*2
Fr.Horn Sect	
Fr.HornSect2	
Orch.Brs Ens	*2
Sax.Section	*2
Sax.Section2	*2
Sax/Brass	
Synth. Brass	*2
Trumpet	*2
Trumpet2	*2
Tp/Shake	*2
Mute Trumpet	*2
MuteTrumpet2	*2
Flugel Horn	*2
Trombone	*2
Trombone2	*2
F.Horn Solo1	*2
Soprano Sax	*2
Soprano Sax2	*2
Alto Sax Ex	*2
Alto Sax	*2
Alto Sax2	*2
Blow Sax	*2
Tenor Sax	*2
Tenor Sax2	*2

■ Woodwinds

Flute	*2
Flute2	*2
Flute3	*2
 AEx Flute	*2
Synth. Flute	
Pan Flute	*2
Pan Flute 2	*2
Oboe	*2
Bassoon	*2
Clarinet	*2
Clarinet2	*2
Clarinet3	*2
Clarinet4	*2
Bs Clarinet	*2
Shakuhachi	*2
HumanWhistle	*2

■ Lead

Synth. Lead1	*2
Synth. Lead2	*2
Synth. Lead3	*2
Synth. Lead4	*2
Synth. Lead5	*2
Sugar Key	*2
Accordion	
Bandoneon	*2
Harmonica	*2

■ Bass

Organ Bass1	
Organ Bass2	
Pipe Org. Bs	
Theater Bass	
Bombarde	
String Bass	*2
Bass+Cymbal	*2
String Bass2	*2
Str.Bass Pdl	*2
Contrabass1	*2
Contrabass2	*2
E.Bass1	
E.Bass2	*2
E.Bass3	*2

E.Bass4	*2
Tuba	
Tuba2	*2
Tuba3	*2
Synth. Bass1	
Synth. Bass2	
Voice Thum	*2

■ Percussion

Timpani	
Timpani2	
Ride Cymbal	
Crash Cymbal	*2
Short Cymbal	
Tambourine	
Woodblock	
Woodblock 2	*2
Snare Drum	
Bass Drum	
Jingle Bell	*2
Perc. Set1	
Perc. Set2	
Perc. Set3	*2
Orch.HitMenu	
Vibraphone	*2
Glockenspiel	
Celesta	
Marimba	
MarimbaTremol	*3
Xylophone	
Tubular-bell	
Steel Drums	
Kalimba	*2
Santur	*2
Organ Bell	
Vibra Bells	*2
Finger Snap	
Bird	*2

*3 : The sounds will also be produced when you take your finger off the key.

Drums/SFX Set List

	POP	ROCK	JAZZ BRUSH	VOX DRUM
28	707 Claps	707 Claps	707 Claps	707 Claps
29	Hand Clap [EXC7]	Hand Clap [EXC7]	Hand Clap [EXC7]	Hand Clap [EXC7]
30	Hand Clap2 [EXC7]	Hand Clap2 [EXC7]	Hand Clap2 [EXC7]	Hand Clap2 [EXC7]
31	Hand Clap	Hand Clap	Hand Clap	Hand Clap
32	Pop Pedal HH [EXC1]	Pop Pedal HH [EXC1]	Pop Pedal HH [EXC1]	Pop Pedal HH
33	Gospel Hand Clap	Gospel Hand Clap	Gospel Hand Clap	Gospel Hand Clap
34	Snare Roll	Snare Roll	Snare Roll	Vox Dut
35	Pop Kick	Rock Kick	Pop Kick	Vox Dom
C2 36	Pop Kick	Rock Kick	Pop Kick	Vox Tuush
37	Pop Side Stick	Rock Side Stick	Jazz Snare Swing	Vox Hehho
38	Pop Sanre s	Rock Sanre s	Jazz Sanre	Vox Doyear
39	Pop Snare Ghost	Rock Snare Ghost	Pop Snare Swing	Vox Thu!
40	Pop Snare s	Rock Snare s	Jazz Sanre	Vox That
41	Pop Low Tom f	Rock Low Tom f	Jazz Low Tom f	Vox Aahhh
42	Pop CHH 1 [EXC1]	Rock CHH 1 [EXC1]	Pop CHH 1 [EXC1]	Vox Tu
43	Pop Low Tom	Rock Low Tom	Jazz Low Tom	Vox Dooh
44	Pop CHH 2 [EXC1]	Rock CHH 2 [EXC1]	Pop CHH 2 [EXC1]	Vox Ptu
45	Pop Mid Tom f	Rock Mid Tom f	Jazz Mid Tom f	Vox Down
46	Pop OHH [EXC1]	Rock OHH [EXC1]	Pop OHH [EXC1]	Vox Pa
47	Pop Mid Tom	Rock Mid Tom	Jazz Mid Tom	Vox Bom
C3 48	Pop High Tom f	Rock High Tom f	Jazz High Tom f	Vox Toear
49	Pop Crash Cymbal 1	Rock Crash Cymbal	Jazz Crash Cymbal 1	Vox Aahhu
50	Pop High Tom	Rock High Tom	Jazz High Tom	Vox Toya
51	Pop Ride Cymbal 1	Rock Ride Cymbal 1	Jazz Ride Cymbal 1	Vox Thu
52	Pop Chinees Cymbal	Pop Chinees Cymbal	Jazz Chinees Cymbal	Vox Cheey
53	Pop Ride Bell	Pop Ride Bell	Jazz Ride Cymbal 2	Vox Cymm
54	Tambourine 2	Tambourine 2	Tambourine 2	Vox Tub
55	Splash Cymbal	Splash Cymbal	Splash Cymbal	Vox Pruru
56	Cha Cha Cowbell	Cha Cha Cowbell	Cha Cha Cowbell	Vox Tut
57	Pop Crash Cymbal 2	Chinees Cymbal	Jazz Crash Cymbal 2	Vox Tyun
58	Vibra-slap 2	Vibra-slap 2	Vibra-slap 2	Vox Tdum
59	Pop Ride Cymbal 2	Pop Ride Cymbal 3	Pop Ride Cymbal 2	Vox Afahhhh
C4 60	High Bongo 2	High Bongo 2	High Bongo 2	High Bongo 2
61	Low Bongo 2	Low Bongo 2	Low Bongo 2	Low Bongo 2
62	Mute Conga	Mute Conga	Mute Conga	Mute Conga
63	High Conga 2	High Conga 2	High Conga 2	High Conga 2
64	Low Conga 2	Low Conga 2	Low Conga 2	Low Conga 2
65	High Timbale 2	High Timbale 2	High Timbale 2	High Timbale 2
66	Low Timbale 2	Low Timbale 2	Low Timbale 2	Low Timbale 2
67	High Agogo	High Agogo	High Agogo	High Agogo
68	Low Agogo	Low Agogo	Low Agogo	Low Agogo
69	Shaker 3	Shaker 3	Shaker 3	Shaker 3
70	Shaker 4	Shaker 4	Shaker 4	Shaker 4
71	Short Hi Whistle [EXC2]	Short Hi Whistle [EXC2]	Short Hi Whistle [EXC2]	Short Hi Whistle [EXC2]
C5 72	Long Low Whistle [EXC2]	Long Low Whistle [EXC2]	Long Low Whistle [EXC2]	Long Low Whistle [EXC2]
73	Short Guiro [EXC3]	Short Guiro [EXC3]	Short Guiro [EXC3]	Short Guiro [EXC3]
74	Long Guiro [EXC3]	Long Guiro [EXC3]	Long Guiro [EXC3]	Long Guiro [EXC3]
75	Claves	Claves	Claves	Claves
76	High Wood Block	High Wood Block	High Wood Block	High Wood Block
77	Low Wood Block	Low Wood Block	Low Wood Block	Low Wood Block
78	Mute Cuica [EXC4]	Mute Cuica [EXC4]	Mute Cuica [EXC4]	Mute Cuica [EXC4]
79	Open Cuica [EXC4]	Open Cuica [EXC4]	Open Cuica [EXC4]	Open Cuica [EXC4]
80	Mute Triangle [EXC5]	Mute Triangle [EXC5]	Mute Triangle [EXC5]	Mute Triangle [EXC5]
81	Open Triangle [EXC5]	Open Triangle [EXC5]	Open Triangle [EXC5]	Open Triangle [EXC5]
82	Shaker	Shaker	Shaker	Shaker
83	Jingle Bell	Jingle Bell	Jingle Bell	Jingle Bell
C6 84	Bell Tree	Bell Tree	Bell Tree	Bell Tree
85	Castanets	Castanets	Castanets	Castanets
86	Mute Surdo [EXC6]	Mute Surdo [EXC6]	Mute Surdo [EXC6]	Mute Surdo [EXC6]
87	Open Surdo [EXC6]	Open Surdo [EXC6]	Open Surdo [EXC6]	Open Surdo [EXC6]
88	Cana	Cana	Cana	Cana
89	Falamento Hi-Timbale	Falamento Hi-Timbale	Falamento Hi-Timbale	Falamento Hi-Timbale
90	Falamento Lo-Timbale	Falamento Lo-Timbale	Falamento Lo-Timbale	Falamento Lo-Timbale
91	Falamento Tmbl Flam	Falamento Tmbl Flam	Falamento Tmbl Flam	Falamento Tmbl Flam
92	Shekere 1	Shekere 1	Shekere 1	Shekere 1
93	Shekere 2	Shekere 2	Shekere 2	Shekere 2
94	Low Bongo Mute	Low Bongo Mute	Low Bongo Mute	Low Bongo Mute
95	High Bongo Mute	High Bongo Mute	High Bongo Mute	High Bongo Mute
C7 96	----	----	----	----
97	----	----	----	----
98	----	----	----	----
99	----	----	----	----
100	Falamento HC	Falamento HC	Falamento HC	Falamento HC
101	Falamento HC	Falamento HC	Falamento HC	Falamento HC
102	Bongo Cowbell	Bongo Cowbell	Bongo Cowbell	Bongo Cowbell
103	----	----	----	----

--- : no sound

[EXC] : will not sound simultaneously with other percussion instruments of the same number

Drums/SFX Set List

	JAZZ STANDARD	STANDARD 2	ROOM	ROOM 2
28	Slap	Slap	Slap	Slap
29	Scratch Push [EXC7]	Scratch Push [EXC7]	Scratch Push [EXC7]	Scratch Push [EXC7]
30	Scratch Pull [EXC7]	Scratch Pull [EXC7]	Scratch Pull [EXC7]	Scratch Pull [EXC7]
31	Sticks	Sticks	Sticks	Sticks
32	Square Click	Square Click	Square Click	Square Click
33	Metronome Click	Metronome Click	Metronome Click	Metronome Click
34	Metronome Bell	Metronome Bell	Metronome Bell	Metronome Bell
35	Std Kick 2	Std Kick 2'	Std Kick 2	Kick1
C2 36	Std Kick 1	Kick 1	Std Kick 1	Room Kick
37	Side Stick	Side Stick	Side Stick	Side Stick
38	Snare Drum 1	Std Snr 1	Snare Drum 1	Room Snr 1
39	Hand Clap	Hand Clap	Hand Clap	Hand Clap
40	Snare Drum 2	Std Snr 2	Snare Drum 2	Std Snr 1
41	Low Tom 2	Low Tom 2	Room Low Tom 2	Room Low Tom 2'
42	Closed Hi-hat 1 [EXC1]	Closed Hi-hat 1' [EXC1]	Closed Hi-hat 1 [EXC1]	Closed Hi-hat 1' [EXC1]
43	Low Tom 1	Low Tom 1	Room Low Tom 1	Room Low Tom 1'
44	Pedal Hi-hat 1 [EXC1]	Pedal Hi-hat 1' [EXC1]	Pedal Hi-hat 1 [EXC1]	Pedal Hi-hat 1' [EXC1]
45	Mid Tom 2	Mid Tom 2	Room Mid Tom 2	Room Mid Tom 2'
46	Open Hi-hat 1 [EXC1]	Open Hi-hat 1' [EXC1]	Open Hi-hat 1 [EXC1]	Open Hi-hat 1' [EXC1]
47	Mid Tom 1	Mid Tom 1	Room Mid Tom 1	Room Mid Tom 1'
C3 48	High Tom 2	Room Hi Tom 2	Room Hi Tom 2	Room Hi Tom 2'
49	Crash Cymbal 1	Crash Cymbal 1	Crash Cymbal 1	Crash Cymbal 1
50	High Tom 1	High Tom 1	Room Hi Tom 1	Room Hi Tom 1'
51	Ride Cymbal 1	Ride Cymbal 1	Ride Cymbal 1	Ride Cymbal 1
52	Chinese Cymbal	Chinese Cymbal	Chinese Cymbal	Chinese Cymbal
53	Ride Bell	Ride Bell	Ride Bell	Ride Bell
54	Tambourine	Tambourine	Tambourine	Tambourine
55	Splash Cymbal	Splash Cymbal	Splash Cymbal	Splash Cymbal
56	Cowbell	Cowbell	Cowbell	Cowbell
57	Crash Cymbal 2	Crash Cymbal 2	Crash Cymbal 2	Crash Cymbal 2
58	Vibra-slap	Vibra-slap	Vibra-slap	Vibra-slap
59	Ride Cymbal 2	Ride Cymbal 2	Ride Cymbal 2	Ride Cymbal 2
C4 60	High Bongo	High Bongo	High Bongo	High Bongo
61	Low Bongo	Low Bongo	Low Bongo	Low Bongo
62	Mute High Conga	Mute High Conga	Mute High Conga	Mute High Conga
63	Open High Conga	Open High Conga	Open High Conga	Open High Conga
64	Low Conga	Low Conga	Low Conga	Low Conga
65	High Timbale	High Timbale	High Timbale	High Timbale
66	Low Timbale	Low Timbale	Low Timbale	Low Timbale
67	High Agogo	High Agogo	High Agogo	High Agogo
68	Low Agogo	Low Agogo	Low Agogo	Low Agogo
69	Cabasa	Cabasa	Cabasa	Cabasa
70	Maracas	Maracas	Maracas	Maracas
71	Short Hi Whistle [EXC2]	Short Hi Whistle [EXC2]	Short Hi Whistle [EXC2]	Short Hi Whistle [EXC2]
C5 72	Long Low Whistle [EXC2]	Long Low Whistle [EXC2]	Long Low Whistle [EXC2]	Long Low Whistle [EXC2]
73	Short Guiro [EXC3]	Short Guiro [EXC3]	Short Guiro [EXC3]	Short Guiro [EXC3]
74	Long Guiro [EXC3]	Long Guiro [EXC3]	Long Guiro [EXC3]	Long Guiro [EXC3]
75	Claves	Claves	Claves	Claves
76	High Wood Block	High Wood Block	High Wood Block	High Wood Block
77	Low Wood Block	Low Wood Block	Low Wood Block	Low Wood Block
78	Mute Cuica [EXC4]	Mute Cuica [EXC4]	Mute Cuica [EXC4]	Mute Cuica [EXC4]
79	Open Cuica [EXC4]	Open Cuica [EXC4]	Open Cuica [EXC4]	Open Cuica [EXC4]
80	Mute Triangle [EXC5]	Mute Triangle [EXC5]	Mute Triangle [EXC5]	Mute Triangle [EXC5]
81	Open Triangle [EXC5]	Open Triangle [EXC5]	Open Triangle [EXC5]	Open Triangle [EXC5]
82	Shaker	Shaker	Shaker	Shaker
83	Jingle Bell	Jingle Bell	Jingle Bell	Jingle Bell
C6 84	Bell Tree	Bell Tree	Bell Tree	Bell Tree
85	Castanets	Castanets	Castanets	Castanets
86	Mute Surdo [EXC6]	Mute Surdo [EXC6]	Mute Surdo [EXC6]	Mute Surdo [EXC6]
87	Open Surdo [EXC6]	Open Surdo [EXC6]	Open Surdo [EXC6]	Open Surdo [EXC6]
88	----	----	----	----
89	----	----	----	----
90	----	----	----	----
91	----	----	----	----
92	----	----	----	----
93	----	----	----	----
94	----	----	----	----
95	----	----	----	----
C7 96	----	----	----	----
97	----	----	----	----
98	----	----	----	----
99	----	----	----	----
100	----	----	----	----
101	----	----	----	----
102	----	----	----	----
103	----	----	----	----

--- : no sound

[EXC] : will not sound simultaneously with other percussion instruments of the same number

Drums/SFX Set List

	POWER	ELECTRONIC	TR-808	DANCE
28	Slap	Slap	Slap	Slap
29	Scratch Push [EXC7]	Scratch Push [EXC7]	Scratch Push [EXC7]	Scratch Push [EXC7]
30	Scratch Pull [EXC7]	Scratch Pull [EXC7]	Scratch Pull [EXC7]	Scratch Pull [EXC7]
31	Sticks	Sticks	Sticks	Dance Snr 1
32	Square Click	Square Click	Square Click	Square Click
33	Metronome Click	Metronome Click	Metronome Click	Metronome Click
34	Metronome Bell	Metronome Bell	Metronome Bell	Metronome Bell
35	Std Kick 2	Std Kick 2	Std Kick 2	Kick 1
C2 36	MONDO Kick	Elec BD	808 Bass Drum 1	808 Bass Drum 2
37	Side Stick	Side Stick	808 Rim Shot	808 Rim Shot
38	Gated SD	Elec SD	808 Snare Drum	TR-909 Snr
39	Hand Clap	Hand Clap	Hand Clap	Hand Clap
40	Snare Drum 2	Gated SD	Snare Drum 2	Dance Snr 2
	Room Low Tom 2	Elec Low Tom 2	808 Low Tom 2	808 Low Tom 2
41	Closed Hi-hat 1 [EXC1]	Closed Hi-hat 1 [EXC1]	808 CHH [EXC1]	808 CHH [EXC1]
42	Room Low Tom 1	Elec Low Tom 1	808 Low Tom 1	808 Low Tom 1
43	Pedal Hi-hat 1 [EXC1]	Pedal Hi-hat 1 [EXC1]	808 CHH [EXC1]	808 CHH [EXC1]
44	Room Mid Tom 2	Elec Mid Tom 2	808 Mid Tom 2	808 Mid Tom 2
45	Open Hi-hat 1 [EXC1]	Open Hi-hat 1 [EXC1]	808 OHH [EXC1]	808 OHH [EXC1]
46	Room Mid Tom 1	Elec Mid Tom 1	808 Mid Tom 1	808 Mid Tom 1
C3 47	Room Hi Tom 2	Elec Hi Tom 2	808 Hi Tom 2	808 Hi Tom 2
48	Crash Cymbal 1	Crash Cymbal 1	808 Cymbal	808 Cymbal
49	Room Hi Tom 1	Elec Hi Tom 1	808 Hi Tom 1	808 Hi Tom 1
50	Ride Cymbal 1	Ride Cymbal 1	Ride Cymbal 1	Ride Cymbal 1
51	Chinese Cymbal	Reverse Cymbal	Chinese Cymbal	Chinese Cymbal
52	Ride Bell	Ride Bell	Ride Bell	Ride Bell
53	Tambourine	Tambourine	Tambourine	Tambourine
54	Splash Cymbal	Splash Cymbal	Splash Cymbal	Splash Cymbal
55	Cowbell	Cowbell	808 Cowbell	808 Cowbell
56	Crash Cymbal 2	Crash Cymbal 2	Crash Cymbal 2	Crash Cymbal 2
57	Vibra-slap	Vibra-slap	Vibra-slap	Vibra-slap
58	Ride Cymbal 2	Ride Cymbal 2	Ride Cymbal 2	Ride Cymbal 2
59				
C4 60	High Bongo	High Bongo	High Bongo	High Bongo
61	Low Bongo	Low Bongo	Low Bongo	Low Bongo
62	Mute High Conga	Mute High Conga	808 High Conga	808 High Conga
63	Open High Conga	Open High Conga	808 Mid Conga	808 Mid Conga
64	Low Conga	Low Conga	808 Low Conga	808 Low Conga
65	High Timbale	High Timbale	High Timbale	High Timbale
66	Low Timbale	Low Timbale	Low Timbale	Low Timbale
67	High Agogo	High Agogo	High Agogo	High Agogo
68	Low Agogo	Low Agogo	Low Agogo	Low Agogo
69	Cabasa	Cabasa	Cabasa	Cabasa
70	Maracas	Maracas	808 Maracas	808 Maracas
71	Short Hi Whistle [EXC2]	Short Hi Whistle [EXC2]	Short Hi Whistle [EXC2]	Short Hi Whistle [EXC2]
C5 72	Long Low Whistle [EXC2]	Long Low Whistle [EXC2]	Long Low Whistle [EXC2]	Long Low Whistle [EXC2]
73	Short Guiro [EXC3]	Short Guiro [EXC3]	Short Guiro [EXC3]	Short Guiro [EXC3]
74	Long Guiro [EXC3]	Long Guiro [EXC3]	Long Guiro [EXC3]	Long Guiro [EXC3]
75	Claves	Claves	808 Claves	808 Claves
76	High Wood Block	High Wood Block	High Wood Block	High Wood Block
77	Low Wood Block	Low Wood Block	Low Wood Block	Low Wood Block
78	Mute Cuica [EXC4]	Mute Cuica [EXC4]	Mute Cuica [EXC4]	Mute Cuica [EXC4]
79	Open Cuica [EXC4]	Open Cuica [EXC4]	Open Cuica [EXC4]	Open Cuica [EXC4]
80	Mute Triangle [EXC5]	Mute Triangle [EXC5]	Mute Triangle [EXC5]	Mute Triangle [EXC5]
81	Open Triangle [EXC5]	Open Triangle [EXC5]	Open Triangle [EXC5]	Open Triangle [EXC5]
82	Shaker	Shaker	Shaker	Shaker
83	Jingle Bell	Jingle Bell	Jingle Bell	Jingle Bell
C6 84	Bell Tree	Bell Tree	Bell Tree	Bell Tree
85	Castanets	Castanets	Castanets	Castanets
86	Mute Surdo [EXC6]	Mute Surdo [EXC6]	Mute Surdo [EXC6]	Mute Surdo [EXC6]
87	Open Surdo [EXC6]	Open Surdo [EXC6]	Open Surdo [EXC6]	Open Surdo [EXC6]
88	-----	-----	-----	-----
89	-----	-----	-----	-----
90	-----	-----	-----	-----
91	-----	-----	-----	-----
92	-----	-----	-----	-----
93	-----	-----	-----	-----
94	-----	-----	-----	-----
95	-----	-----	-----	-----
C7 96	-----	-----	-----	-----
97	-----	-----	-----	-----
98	-----	-----	-----	-----
99	-----	-----	-----	-----
100	-----	-----	-----	-----
101	-----	-----	-----	-----
102	-----	-----	-----	-----
103	-----	-----	-----	-----

--- : no sound

[EXC] : will not sound simultaneously with other percussion instruments of the same number

Drums/SFX Set List

	BRUSH	BRUSH 2	ORCHESTRA	SOUND EFFECT
28	Slap	Slap	Pedal Hi-hat [EXC1]	----
29	Scratch Push [EXC7]	Scratch Push [EXC7]	Open Hi-hat [EXC1]	----
30	Scratch Pull [EXC7]	Scratch Pull [EXC7]	Ride Cymbal	----
31	Sticks	Sticks	Sticks	----
32	Square Click	Square Click	Square Click	----
33	Metronome Click	Metronome Click	Metronome Click	----
34	Metronome Bell	Metronome Bell	Metronome Bell	----
35	Std Kick 2	Kick 2	Concert BD 2	----
C2 36	Std Kick 1	Kick 1	Concert BD 1	----
37	Side Stick	Side Stick	Side Stick	----
38	Brush Tap	Brush Tap	Concert SD	----
39	Brush Slap	Brush Slap	Castanets	High Q
40	Brush Swirl	Brush Swirl	Concert SD	Slap
41	Low Tom 2	Brush Low Tom 2	Timpani F	Scratch Push [EXC7]
42	Closed Hi-hat 1 [EXC1]	Closed Hi-hat 2 [EXC1]	Timpani F#	Scratch Pull [EXC7]
43	Low Tom 1	Brush Low Tom 1	Timpani G	Sticks
44	Pedal Hi-hat 1 [EXC1]	Pedal Hi-hat 2 [EXC1]	Timpani G#	Square Click
45	Mid Tom 2	Brush Mid Tom 2	Timpani A	Metronome Click
46	Open Hi-hat 1 [EXC1]	Open Hi-hat 2 [EXC1]	Timpani A#	Metronome Bell
47	Mid Tom 1	Brush Mid Tom 1	Timpani B	Guitar sliding Finger
C3 48	High Tom 2	Brush Hi Tom 2	Timpani c	Guitar cutting noise (down)
49	Crash Cymbal 1	Crash Cymbal 1	Timpani c#	Guitar cutting noise (up)
50	High Tom 1	Brush Hi Tom 1	Timpani d	String slap of double bass
51	Ride Cymbal 1	Ride Cymbal 1	Timpani d#	Fl.Key Click
52	Chinese Cymbal	Chinese Cymbal	Timpani e	Laughing
53	Ride Bell	Ride Bell	Timpani f	Screaming
54	Tambourine	Tambourine	Tambourine	Punch
55	Splash Cymbal	Splash Cymbal	Splash Cymbal	Heart Beat
56	Cowbell	Cowbell	Cowbell	Footsteps1
57	Crash Cymbal 2	Crash Cymbal 2	Concert Cymbal 2	Footsteps2
58	Vibra-slap	Vibra-slap	Vibra-slap	Applause
59	Ride Cymbal 2	Ride Cymbal 2	Concert Cymbal 1	Door Creaking
C4 60	High Bongo	High Bongo	High Bongo	Door
61	Low Bongo	Low Bongo	Low Bongo	Scratch
62	Mute High Conga	Mute High Conga	Mute High Conga	Wind Chimes
63	Open High Conga	Open High Conga	Open High Conga	Car-Engine
64	Low Conga	Low Conga	Low Conga	Car-Stop
65	High Timbale	High Timbale	High Timbale	Car-Pass
66	Low Timbale	Low Timbale	Low Timbale	Car-Crash
67	High Agogo	High Agogo	High Agogo	Siren
68	Low Agogo	Low Agogo	Low Agogo	Train
69	Cabasa	Cabasa	Cabasa	Jetplane
70	Maracas	Maracas	Maracas	Helicopter
71	Short Hi Whistle [EXC2]	Short Hi Whistle [EXC2]	Short Hi Whistle [EXC2]	Starship
C5 72	Long Low Whistle [EXC2]	Long Low Whistle [EXC2]	Long Low Whistle [EXC2]	Gun Shot
73	Short Guiro [EXC3]	Short Guiro [EXC3]	Short Guiro [EXC3]	Machine Gun
74	Long Guiro [EXC3]	Long Guiro [EXC3]	Long Guiro [EXC3]	Lasergun
75	Claves	Claves	Claves	Explosion
76	High Wood Block	High Wood Block	High Wood Block	Dog
77	Low Wood Block	Low Wood Block	Low Wood Block	Horse-Gallop
78	Mute Cuica [EXC4]	Mute Cuica [EXC4]	Mute Cuica [EXC4]	Birds
79	Open Cuica [EXC4]	Open Cuica [EXC4]	Open Cuica [EXC4]	Rain
80	Mute Triangle [EXC5]	Mute Triangle [EXC5]	Mute Triangle [EXC5]	Thunder
81	Open Triangle [EXC5]	Open Triangle [EXC5]	Open Triangle [EXC5]	Wind
82	Shaker	Shaker	Shaker	Seashore
83	Jingle Bell	Jingle Bell	Jingle Bell	Stream
C6 84	Bell Tree	Bell Tree	Bell Tree	Bubble
85	Castanets	Castanets	Castanets	Cat
86	Mute Surdo [EXC6]	Mute Surdo [EXC6]	Mute Surdo [EXC6]	----
87	Open Surdo [EXC6]	Open Surdo [EXC6]	Open Surdo [EXC6]	----
88	----	----	Applause	----
89	----	----	----	----
90	----	----	----	----
91	----	----	----	----
92	----	----	----	----
93	----	----	----	----
94	----	----	----	----
95	----	----	----	----
C7 96	----	----	----	----
97	----	----	----	----
98	----	----	----	----
99	----	----	----	----
100	----	----	----	----
101	----	----	----	----
102	----	----	----	----
103	----	----	----	----

--- : no sound

[EXC] : will not sound simultaneously with other percussion instruments of the same number

Manual Percussion List (AT-90S/80S)

	PERC.SET 1	PERC.SET 2	PERCUSSIONSET 3	ORCHESTRAL SET
28	Crash Cymbal	Mallet Cymbal	Triangl Open	Mallet Cymbal
29	Snare Roll	Slap Stick	Triangl Mute	Snare Roll
30	Concert Snare Drum	Ratchet	Triangl Roll	Concert Snare Drum
31	Concert Cymbal	Concert Cymbal	WindChime Up	Crash Cymbal
32	Concert BD1	Concert BD2	WindChime Down	Concert BD2
33	Jingle Bell	Bar Chime	VibraSlap	MalletCymbal Roll
34	Metronome Bell	Finger Snap	Finger Cymbal	Timpani Roll
35	Timpani Roll	Timpani 2 (Low)	Gong Roll	Timpani 2 (Low)
C2 36	Timpani	Timpani 2 (Hi)	MalletCymbal Roll	Timpani 2 (Hi)
37	Church Bell	Church Bell 2	Cowbell	Triangl Open
38	Big Gong	Church Bell 2 Loop	Claves	Big Gong
39	Hand Clap	Castanet (One Shot)	Clavs Loop	Triangl Roll
40	High Wood Block	Castanet	Tambourine	Tambourine2
41	Low Wood Block	Castanet (Loop)	Tambourine2	Tambourine Roll
42	Tambourine	Tambourine 2	Tambourine Roll	WindChime Up

	LATIN SET	VOICE PHRASE	VOICE PHRASE 2	VOICE PHRASE 3
28	Bongo Open (Low) [mf/f]	Amen 1(Mid)	Alolalo solo	Sabor!
29	Bongo Open (Hi) [mf/f]	Amen 1(Hi1)	Haleluya solo	Sabor Sabor!
30	Conga (Low) [Mute/Open]	Amen 1(Hi2)	Freedom [Long/Short]	Grito-Bah
31	Conga (Hi) [Mute/Open]	Amen 2(Mid)	Glory	Grito-Tiquitita
32	Conga [Roll/Thumb]	Amen 2(Hi)	Haleluya	Baila Baila!
33	Timbales Open (Low)	Amen 3(Mid)	Soul	Arriba Arriba!
34	Timbales (Hi) [Open/Rim]	Amen 3(Hi)	Victry	Sacala Sacala!
35	Timbales Fill [Low/Hi]	Aleluia 1(Mid)	Hey	Azucal Azucal!
C2 36	Claves	Aleluia 1(Hi)	Woo [Long/Short]	Grito-Hahahahaha!
37	Cuica [Low/Hi]	Aleluia 2(Hi)	Yeah [Long/Short]	A si A si!
38	Guiro [Long/Short]	Aleluia 2(Mid)	Yes [Long/Short]	Grito-Hoi Hoi Hoi!
39	Maracas	Hey (Hi)	One	Uno!
40	Shaker [Long/Short]	Hey (Mid)	Two	Dos!
41	Apito [Low/Hi]	Woo (Mid)	Three	Tres!
42	Quijada	Woo (Hi)	Aou	Quatro!

	SFX SET	JAPANESE SET	JAPANESE SET 2
28	Car Engine2	Wadaiko	Hah Doshita (Solo)
29	Car Horn	Wadaiko Rim	Hah Doshita
30	Compresser	Shimedaiko	Hah Sorekara Doshita
31	Big Shot	Atarigane	Yaretto
32	Cricket	Atarigane Side	Enya koraya
33	Horse-Gallop	Furin	Hah Dokkoi
34	SL 1	Hyoshigi	Hai Hai
35	SL 2	Ohkawa	Dokkoi-syo Dokkoi-syo
C2 36	Crack Bottle	Tsuzumi (Low)	Hai Hai (Solo)
37	Ice Ring	Tsuzumi (Hi)	Dokkoi-syo Dokkoi-syo (Solo)
38	Glass & Glam	Mokugyo (Low)	Dokkoisa
39	Pour Bottle	Mokugyo (Hi)	Korasyo
40	Soda	Ho	Haiyasaka
41	Small Club	Iyoh	Sora Enyakora
42	BabyLaughing	Yoh	Hoisa Hoisa

Manual Percussion List (AT-60S)

	PERC.SET 1	PERC.SET 2	LATIN SET	VOICE PHRASE
28	Crash Cymbal	Mallet Cymbal	Bongo Open (Low) [mf/f]	Amen 1(Mid)
29	Snare Roll	Slap Stick	Bongo Open (Hi) [mf/f]	Amen 1(Hi1)
30	Concert Snare Drum	Ratchet	Conga (Low) [Mute/Open]	Amen 1(Hi2)
31	Concert Cymbal	Concert Cymbal	Conga (Hi) [Mute/Open]	Amen 2(Mid)
32	Concert BD1	Concert BD2	Conga [Roll/Thumb]	Amen 2(Hi)
33	Jingle Bell	Bar Chime	Timbales Open (Low)	Amen 3(Mid)
34	Metronome Bell	Finger Snap	Timbales (Hi) [Open/Rim]	Amen 3(Hi)
35	Timpani Roll	Timpani 2 (Low)	Timbales Fill [Low/Hi]	Aleluia 1(Mid)
C2 36	Timpani	Timpani 2 (Hi)	Claves	Aleluia 1(Hi)
37	Church Bell	Church Bell 2	Cuica [Low/Hi]	Aleluia 2(Hi)
38	Big Gong	Church Bell 2 Loop	Guiro [Long/Short]	Aleluia 2(Mid)
39	Hand Clap	Castanet (One Shot)	Maracas	Hey (Hi)
40	High Wood Block	Castanet	Shaker [Long/Short]	Hey (Mid)
41	Low Wood Block	Castanet (Loop)	Apito [Low/Hi]	Woo (Mid)
42	Tambourine	Tambourine 2	Quijada	Woo (Hi)

VOICE PHRASE 2

28	Alolalo solo	
29	Haleluya solo	
30	Freedom	[Long/Short]
31	Glory	
32	Haleluya	
33	Soul	
34	Victory	
35	Hey	
C2 36	Woo	[Long/Short]
37	Yeah	[Long/Short]
38	Yes	[Long/Short]
39	One	
40	Two	
41	Three	
42	Aou	

Rhythm List (AT-90S)

■ Big Band/Swing

Big Band 3
Cool Swing
Big Serenade
BigBand Pop
Jazzy Choir
Organ Swing
Scat Swing
Club Swing
Fast BigBand
New Big Band
BigBandSwing
BigBndBallad
Vocal Swing
Medium Swing
A Cappella
Combo
Big Band
Big Band 2
Jazz Band
ChooChooSwg
Boogie
Blues
Slow Swing
Swing
Shuffle

■ Country/Gospel

DCountry 2
DCountry 1
OldtimeCntry
HonkyTonkin'
Soft Gospel
Gospel Piano
Gospel Pop
Revival
Country Song
C&W Ballad
Hoedown
Twostep
Gospel Shout
GospelBallad
Gospel 1
Gospel 2

CountryPiano
CountrySwing
Easy Country
CountryWaltz
Anthem
Chapel
Cajun
Western
CtrySerenade
CountryRoads

■ Oldies/Contempo

70's 2
JB Soul
Lets Twist
Surf fun
Groovin
Michael'sPop
Swing Pop
8Beat Pop
70's 1
Marsey Beat
Early Rock
50'sBallad
Lets Dance
PopularPiano
Slow Dance
Acoustic Pop
Beach Sound
Twist
50's Pop 1
50's Pop 2
Easy Listen1
Easy Listen2
Dreamin'
Da Blues
Motown
Euro Dance
Pop'n Roll
Rock'n'Roll
Rollin'
16BeatShuffl
Easy Listen3
Easy Listen4

Easy Listen5
ShufflePop 1
ShufflePop 2
Rock'n'Shffl
Light Fusion
Rock'n Pop

■ Ballad

8BeatBallad2
8BeatBallad1
Sunnyfeelin'
Slow Pop
Soft Ballad
Ballad
Love Romance
Love Songs
Torch Song
Torch Song 2
MediumBallad
Pop Ballad
Crystal
Classic

■ World

Hula
Hawaiian
French Waltz
D Marsch 6/8
Scotland
Ireland
Reggae
Habanera

■ Latin

Mambo 3
ChaCha 4
Plena
Bomba
Bossa Nova 1
Piano Latin
Fast Bossa
Slow Bossa
Slow Beguine
Merengue

Latin
Rhumba
Bossa Nova
Bossa Nova 2
FastBosaNova
NewBossaNova
Chacha
Chacha 2
Salsa
Samba
Rhumba 2
Beguine
Mambo
Tango 1
Tango 2
Latin Fusion
Samba Rio

■ Waltz/March

Parade
Slow Waltz 2
ViennaWaltz2
Slow Waltz
March
March 4/4
March 6/8
March 2/4
Jazz Waltz
Summer Days
Last Dance
StringsWaltz
Simple March
Waltz
Musette
Vienna Waltz

■ Trad/Showtime

Stage Waltz
Foxtrot 2
Polka
Raindrops
Dixie
PianoBoogie2
Screen 1

Screen 2
Music Hall
Broadway
Bubbles
Charleston
Foxtrot
Rag Time
Dixieland
PianoBoogie1
Balloon Trip
Festival
Little Steps
WesternMovie
Hula
Hawaiian

■ Acoustic

G.Pop
G.Fast Pop
P.Slow
P.Jazz
PianoRagtime
G.Slow
G.Shuffle
P.Night
P.Pop
P.Concerto

■ Disk

Cute Pop
R&B
Slow Rock
Rock'n'Roll2
60'sBallad
Bossa Nova 3
Bossa Nova 4
Sevilla
Cinema
Entertaining
70's Disco
16Beat Pop 1
16Beat Pop 2
AcousticRock
Rock 1

Rock 2

* *The "Hula" or "Hawaiian" rhythms are found in both the "World" and "Trad/Showtime" rhythm groups.*

Rhythm List (AT-80S)

■ Big Band/Swing

Cool Swing
Big Serenade
Organ Swing
Scat Swing
Fast BigBand
New Big Band
Big Band
Jazz Band
BigBandSwing
BigBndBallad
Vocal Swing
Club Swing
Medium Swing
A Cappella
Combo
Big Band 2
ChooChooSwg
Boogie
Blues
Slow Swing
Swing
Shuffle

■ Country/Gospel

DCountry 1
OldtimeCntry
Hoedown
Twostep
Gospel Shout
Soft Gospel
Gospel Pop
Revival
CountryPiano
CountrySwing
Easy Country
CountryWaltz
GospelBallad
Gospel 1
Gospel 2
Anthem
Chapel
Cajun
CtrySerenade
CountryRoads

■ Oldies/Contempo

Groovin
Michael'sPop
Marsey Beat
Early Rock
JB Soul
70's 1
Da Blues
Lets Dance
50'sBallad
Slow Dance
Swing Pop
8Beat Pop
Euro Dance
PopularPiano
Acoustic Pop
Beach Sound
Twist
50's Pop 1
50's Pop 2
Easy Listen1
Easy Listen2
Dreamin'
Motown
Pop'n Roll
Rock'n'Roll
Rollin'
16BeatShuffl
Easy Listen3
Easy Listen4
ShufflePop 1
ShufflePop 2
Rock'n'Shffl
Light Fusion
Rock'n Pop

■ Ballad

8BeatBallad2
8BeatBallad1
Sunnyfeelin'
Soft Ballad
Ballad
Love Romance
Love Songs

Torch Song
Torch Song 2
MediumBallad
Pop Ballad
Crystal
Classic

■ World

Hula
Hawaiian
French Waltz
D Marsch 6/8
Scotland
Ireland
Reggae
Habanera

■ Latin

Plena
Mambo 3
Slow Beguine
Latin
Piano Latin
Bossa Nova 1
Slow Bossa
FastBosaNova
Rhumba
Bossa Nova
Bossa Nova 2
NewBossaNova
Chacha
Chacha 2
Salsa
Samba
Beguine
Mambo
Tango 1
Tango 2
Latin Fusion
Samba Rio

■ Waltz/March

Jazz Waltz
 Slow Waltz
 Summer Days
 Last Dance
 March
 March 4/4
 March 6/8
 March 2/4
 StringsWaltz
 Waltz
 Musette
 Vienna Waltz
 Simple March

■ Trad/Showtime

Foxtrot 2
 Polka
 Charleston
 Rag Time
 Stage Waltz
 Raindrops
 Screen 1
 Screen 2
 Dixieland
 Bubbles
 Foxtrot
 PianoBoogie1
 Music Hall
 Broadway
 Balloon Trip
 Festival
 Little Steps
 Hula
 Hawaiian

■ Acoustic

G.Pop
 G.Fast Pop
 P.Slow
 P.Jazz
 PianoRagtime
 G.Slow
 G.Shuffle

P.Night
 P.Pop
 P.Concerto

■ Disk

Cute Pop
 R&B
 Rock'n'Roll2
 60'sBallad
 Bossa Nova 3
 Bossa Nova 4
 Sevilla
 Cinema
 Entertaining
 16Beat Pop 1
 16Beat Pop 2
 AcousticRock

** The "Hula" or "Hawaiian" rhythms
 are found in both the "World" and
 "Trad/Showtime" rhythm groups.*

Rhythm List (AT-60S)

■ Big Band/Swing

Fast BigBand
New Big Band
Big Serenade
Organ Swing
Scat Swing
Club Swing
BigBandSwing
BigBndBallad
Big Band
Big Band 2
Jazz Band
Medium Swing
Combo
A Cappella
ChooChooSwg
Slow Swing
Boogie
Swing
Shuffle

■ Country/Gospel

DCountry 1
OldtimeCntry
CountryPiano
CountrySwing
Soft Gospel
Gospel Pop
Revival
GospelBallad
Hoedown
Twostep
Easy Country
CountryWaltz
Gospel 1
Anthem
CountryRoads

■ Oldies/Contempo

JB Soul
70's 1
Marsey Beat
50'sBallad
Michael'sPop
Swing Pop
8Beat Pop
Lets Dance
PopularPiano
Slow Dance
Acoustic Pop
Beach Sound
Twist

50's Pop 1
50's Pop 2
Easy Listen1
Easy Listen2
Dreamin'
Motown
Euro Dance
Rock'n'Roll
Rollin'
Easy Listen3
ShufflePop 1
ShufflePop 2
Rock'n Pop

■ Ballad

8BeatBallad1
Sunnyfeelin'
Soft Ballad
Ballad
Love Romance
Love Songs
Torch Song
MediumBallad
Crystal
Classic

■ World

Hawaiian
French Waltz
D Marsch 6/8
Scotland
Ireland
Reggae

■ Latin

Mambo 3
Plena
Bossa Nova 1
Slow Bossa
Latin
Rhumba
Beguine
Salsa
Bossa Nova
Bossa Nova 2
FastBosaNova
NewBossaNova
Chacha
Mambo
Tango 1
Tango 2
Samba Rio

■ Waltz/March

Jazz Waltz
Slow Waltz
Summer Days
Last Dance
March
March 4/4
March 6/8
StringsWaltz
Waltz
Musette

■ Trad/Showtime

Stage Waltz
Raindrops
Polka
Screen 1
Screen 2
Music Hall
Broadway
Charleston
Foxtrot
Rag Time
Dixieland
PianoBoogie1
Festival
Little Steps
Hawaiians

■ Acoustic

G.Pop
G.Fast Pop
P.Slow
P.Jazz
PianoRagtime
G.Shuffle
P.Night

■ Disk

Cute Pop
60'sBallad
Bossa Nova 3
Bossa Nova 4
16Beat Pop 1
16Beat Pop 2

* *The "Hula" or "Hawaiian" rhythms are found in both the "World" and "Trad/Showtime" rhythm groups. The "Hula" and "Hawaiian" rhythms of the "World" group can be rewritten with disk rhythms by using the World Style Disk.*

Music Style Disk List (AT-90S/80S/60S)

■ Disk 1

- 01 BigBndBalld2
- 02 Boogie
- 03 Jazz Band
- 04 Blues 2
- 05 Blues 3
- 06 Big Band 4
- 07 Swing
- 08 MidiumSwing2
- 09 Slow Swing 2
- 10 Bluegrass 1
- 11 Bluegrass 2
- 12 Cajun
- 13 Slow Country
- 14 ContryBallad
- 15 CountrySwing
- 16 Two Step 2
- 17 Train Beat
- 18 Twist 2
- 19 Slow Rock 2
- 20 Baroque
- 21 Classic
- 22 Charleston
- 23 Dixieland 2
- 24 Foxtrot
- 25 Macarena
- 26 Miami
- 27 Merenge
- 28 Reggae
- 29 Tequila
- 30 Hawaiian 2
- 31 Bossa Nova 2
- 32 FastBosaNova
- 33 Bossa Nova 5
- 34 Chacha 3
- 35 Salsa 2
- 36 Mambo 2
- 37 Samba 2
- 38 Tango 4
- 39 Beguine 2
- 40 Easy Listen3
- 41 Easy Listen4
- 42 Easy Listen5
- 43 Easy Listen6

- 44 Easy Listen7
- 45 Pop Piano
- 46 ShufflePop 1
- 47 Gospel 2
- 48 GospelBallad
- 49 French Waltz
- 50 Vienna Waltz
- 51 Folk Waltz
- 52 Slow Waltz 2
- 53 Swing Waltz
- 54 March 2/4
- 55 D Marsch 6/8
- 56 R&B 2
- 57 Rock'n'Roll2
- 58 Rock'n'Roll3
- 59 Contemp 1
- 60 Contemp 2
- 61 Funk 1
- 62 Dance Pop 2

■ Disk 2

- 01 Standard
- 02 Five
- 03 Afro & Swing
- 04 Country Rock
- 05 ContryWaltz2
- 06 Western
- 07 Western 2
- 08 Ragtime 2
- 09 PianoBoogie2
- 10 Reggae 2
- 11 Volk Musik
- 12 Bossa Nova 6
- 13 Rhumba 3
- 14 Dance Rhumba
- 15 Dance Mambo
- 16 Tango 3
- 17 Tango 5
- 18 Tango 6
- 19 Sevilla
- 20 Pop 1
- 21 Pop 2
- 22 Pop 3
- 23 Ballad 2

- 24 Ballad 3
- 25 Simple 8Beat
- 26 Gt.Arpeggio1
- 27 Gt.Arpeggio2
- 28 ThreeFinger1
- 29 ThreeFinger2
- 30 Gt.Stroke
- 31 Gt.Shuffle
- 32 16BeatShffl2
- 33 DeutchWalzer
- 34 Jazz Waltz 2
- 35 Swing Waltz2
- 36 SimpleMarch2
- 37 Folk Dance
- 38 8Beat Enka
- 39 16Beat Enka
- 40 Ondo
- 41 Schlager 1
- 42 Schlager 2
- 43 Schlager 3
- 44 Contemp 3
- 45 Rock 1
- 46 Rock 2
- 47 Rock 3
- 48 Funk 2
- 49 70's Disco 2
- 50 Dance Pop 1
- 51 Dance Pop 3
- 52 Dance Pop 4
- 53 Dance Pop 5

Chord List

● symbol: Indicates the constituent note of chord.

★ symbol: Chord shown with an “★” can be played by pressing just the key marked with the “★.”

C	C#	D	E♭	E	F
CM7	C#M7	DM7	E♭M7	EM7	FM7
C7	C#7	D7	E♭7	E7	F7
Cm	C#m	Dm	E♭m	Em	Fm
Cm7	C#m7	Dm7	E♭m7	Em7	Fm7
Cdim	C#dim	Ddim	E♭dim	Edim	Fdim
Cm7 (♭5)	C#m7 (♭5)	Dm7 (♭5)	E♭m7 (♭5)	Em7 (♭5)	Fm7 (♭5)
Caug	C#aug	Daug	E♭aug	Eaug	Faug
Csus4	C#sus4	Dsus4	E♭sus4	Esus4	Fsus4
C7sus4	C#7sus4	D7sus4	E♭7sus4	E7sus4	F7sus4
C6	C#6	D6	E♭6	E6	F6
Cm6	C#m6	Dm6	E♭m6	Em6	Fm6

F#	G	A \flat	A	B \flat	B
F#M7	GM7	A \flat M7	AM7	B \flat M7	BM7
F#7	G7	A \flat 7	A7	B \flat 7	B7
F#m	Gm	A \flat m	Am	B \flat m	Bm
F#m7	Gm7	A \flat m7	Am7	B \flat m7	Bm7
F#dim	Gdim	A \flat dim	Adim	B \flat dim	Bdim
F#m7 (b5)	Gm7 (b5)	A \flat m7 (b5)	Am7 (b5)	B \flat m7 (b5)	Bm7 (b5)
F#aug	Gaug	A \flat aug	Aaug	B \flat aug	Baug
F#sus4	Gsus4	A \flat sus4	Asus4	B \flat sus4	Bsus4
F#7sus4	G7sus4	A \flat 7sus4	A7sus4	B \flat 7sus4	B7sus4
F#6	G6	A \flat 6	A6	B \flat 6	B6
F#m6	Gm6	A \flat m6	Am6	B \flat m6	Bm6

Glossary

Arrangement

This refers to changes that have been made in an original tune, by adding a new accompaniment or by changing the instruments used.

Automatic Accompaniment

Automatic Accompaniment is automatic accompaniment when just a few keys in the lower section of the keyboard are pressed to specify the chord.

Basic Chord

This refers to the most commonly used types of chord, which are generally the following six types: major chords, minor chords, minor seventh chords, minor seventh (5) chords, dominant seventh chords, and diminished seventh chords.

Chord

Notes of two or more pitches sounded simultaneously. Chords consisting of three notes are called “triads,” and are the most basic type of chord.

Chorus

An effect that adds spaciousness and richness to the sound.

Ending

This is the last part of the accompaniment. When you stop playing the Automatic Accompaniment, the AT-90S/80S/60S plays an Ending appropriate for the Rhythm.

Glide

An effect that temporarily lowers the pitch and then gradually returns it to normal.

Intro

This is the introductory portion of an Automatic Accompaniment performance. The AT-90S/80S/60S plays an intro ideally suited to each Rhythm when it starts playing the Automatic Accompaniment.

Inversion

When the lowest note of a chord is the root, the chord is said to be in “root position.” In contrast, forms of a chord in which other notes are the lowest pitch are called “inversions.”

Mute

To silence a sound. The AT-90S/80S/60S provides a Track Mute function that allows you to turn off the track button indicator of a track on which music data has been recorded, so that the corresponding track will temporarily be silenced.

Panel Settings

Settings such as sound selections, tempo, Rotary fast/slow.

Pitch Bend

An effect that smoothly raises or lowers the pitch.

Registration

A unit of data that contains the performance state of the instrument, such as sound selections and panel settings.

Reverb

An effect that simulates the reverberation of a room or concert hall.

Root Note

The root note is the basis of a chord. All chords are built on a root note, which is the part of the chord name given in uppercase letters.

Rotary

An effect which simulates the modulation given to the sound when a rotating speaker is used. The Rotary effect produces two types of modulation: fast or slow.

Split

A function which allows the keyboard to be divided into two or more areas, and a different sound assigned to each area. The point at which the keyboard is divided is called the “Split Point.”

Sustain

An effect that adds a decay to each note. The AT-90S/80S/60S allows sustain to be applied to the voices of the upper part, lower part, and pedal part.

Vibrato

An effect that cyclically modulates the pitch.

Voice

The AT-90S/80S/60S is able to produce the sounds of various instruments. These sounds are called “Voices.”

■ About ATELIER Series Sound Generator

The ATELIER series come equipped with GM2/GS sound generators.

General MIDI

The General MIDI is a set of recommendations which seeks to provide a way to go beyond the limitations of proprietary designs, and standardize the MIDI capabilities of sound generating devices. Sound generating devices and music files that meets the General MIDI standard bears the General MIDI logo. Music files bearing the General MIDI logo can be played back using any General MIDI sound generating unit to produce essentially the same musical performance.

General MIDI 2

The General MIDI 2 is a set of recommended specifications that provide detailed definitions for functionality such as sound editing and effects that had not been defined in the General MIDI, and extend the sound map to allow a higher degree of performance expression and compatibility. Since the General MIDI 2 is compatible with the General MIDI, it is capable of reliably playing back music files bearing the General MIDI logo.

GS format

The GS Format is Roland's set of specifications for standardizing the performance of sound generating devices. In addition to including support for everything defined by the General MIDI, the highly compatible GS Format additionally offers an expanded number of sounds, provides for the editing of sounds, and spells out many details for a wide range of extra features, including effects such as reverb and chorus.

Designed with the future in mind, the GS Format can readily include new sounds and support new hardware features when they arrive.

Since it is upwardly compatible with the General MIDI, Roland's GS Format is capable of reliably playing back GM Scores equally as well as it performs GS music files (music files that have been created with the GS Format in mind).

This product supports both the General MIDI and the GS Format, and can be used to play back music data carrying either of these logos.

SMF with Lyrics

"SMF with Lyrics" refers to SMF (Standard MIDI File) that contains the lyrics. When music files carrying the "SMF with Lyrics" logo are played back on a compatible device (one bearing the same logo), the lyrics appears in its display.

Replacing the Illumination Bulbs

⚠ WARNING

- Before replacing any light bulbs, you must turn off the power and disconnect the power cord from the AC outlet.
- Wait until the bulb has cooled to room temperature before attempting to replace it.
- Never touch a bulb while it is still hot.
- If the bulb burns out, replace it as soon as possible.
- In households with small children, make certain that you keep all bulbs or screws that you remove well out of the reach of children, so they don't accidentally put them into their mouths.
- Never turn on the power of the illumination while a bulb is being replaced. If the illumination is powered-on, the bulb will become hot, and may cause burns.
- You must replace the bulb with a bulb of the specified model number.

■ Before you continue

- Note which bulb has burned out.
Before you begin, you must note the location of the bulb that needs to be replaced, to ensure that the illumination is not powered-on while replacing the bulb.
- Leave the power turned off for at least 20 minutes before changing the light bulb.
When the illumination is turned on, the light bulb and the vicinity of the bulb will become hot. Turn off the power of the instrument 20 minutes before changing the light bulb, and verify that the vicinity of the bulb is no longer hot before you exchange the light bulb.
- Obtain the replacement light bulb.

■ Required items

- Phillips screwdriver (no. 2) (when replacing the music stand illumination bulb)
- Slotted screwdriver (when replacing the pedal area illumination bulb)
- Replacement light bulb

Illuminated location	Bulb type
Panel illumination	LAMP FB33 (AT-80S, AT-90S)
Pedal illumination	LAMP TYPE 67 (1460-011) (AT-90S only)
Music stand illumination	LAMP FB33 (AT-90S only)

■ Panel illumination (AT-90/80S)

Remove the panel lamp cover

1. Unplug the power cord from the AC outlet.
2. Use both hands to slightly raise the cover, slide it toward the rear, and open the cover.
3. In four locations of the panel lamp cover (A), loosen screws (B).

NOTE

The panel lamp cover screws cannot be removed from the panel lamp cover.

NOTE

Do not remove any screws other than those in the specified four locations.

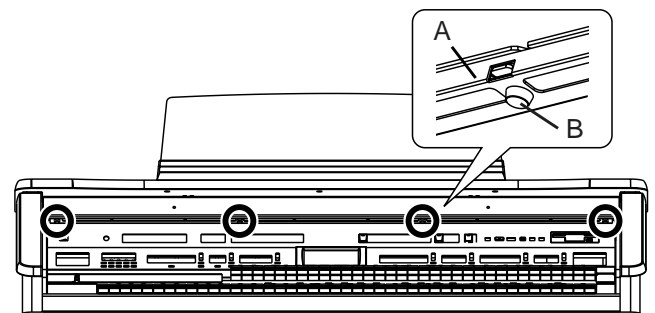

4. Lift the panel lamp cover (A) slightly, and remove it from the hook.

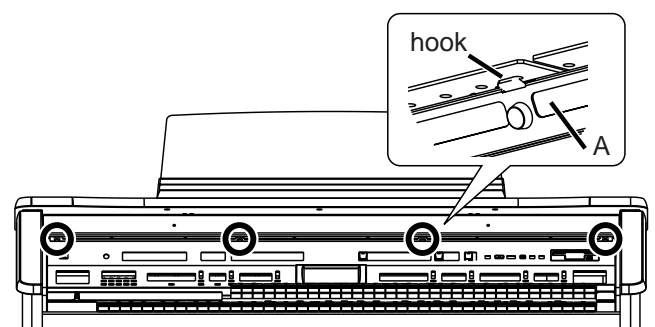

Remove/install the light bulb

5. Slightly raise the cover.
6. Grasping the body of the light bulb, pull it slowly toward yourself to remove it.
7. Align the pins of the new light bulb with the holes of the socket, and insert the bulb straight in.

NOTE

Be aware that if the pins of the light bulb are not aligned with the holes of the socket when installing the bulb, or if the bulb is inserted at an angle, the pins of the bulb could get damaged.

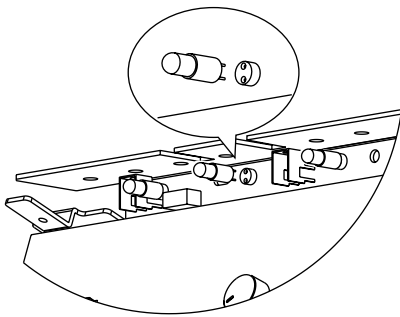

NOTE

Do not disconnect the connector located beside the light bulb.

NOTE

Be careful not to touch the metal by which the lamp board is suspended.

NOTE

Never turn on the power while replacing a light bulb.

Attach the panel lamp cover

1. Align the square hole of the panel lamp cover with the hook.

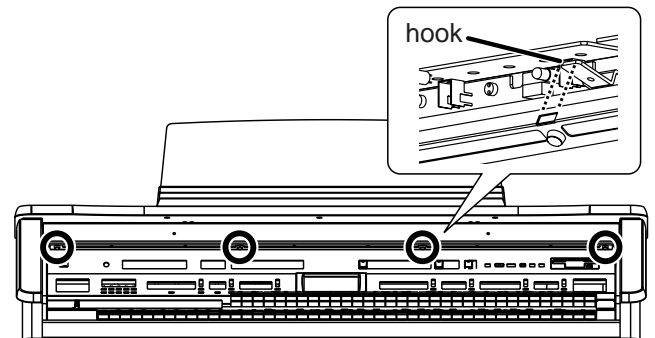

2. Hook the square hole of the panel lamp cover onto the hook.
3. Grasp the two screws located in the center of the panel lamp cover, and while lifting the panel lamp cover, lightly tighten the screws.

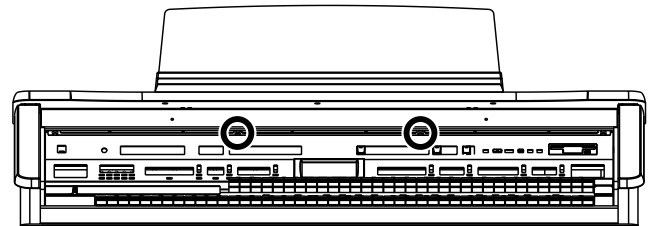

NOTE

Do not completely tighten the two middle screws at this time.

4. Firmly tighten the screws at the left and right ends of the panel lamp cover.
5. Firmly tighten the two screws at the middle of the panel lamp cover.

NOTE

Make sure to tighten the screws in all four locations.

Replacing the Illumination Bulbs

■ Music stand illumination (AT-90S only)

Remove the music stand lamp cover

1. Unplug the power cord from the AC outlet.
2. Use a Phillips screwdriver to remove the screw that fasten the music stand lamp cover.

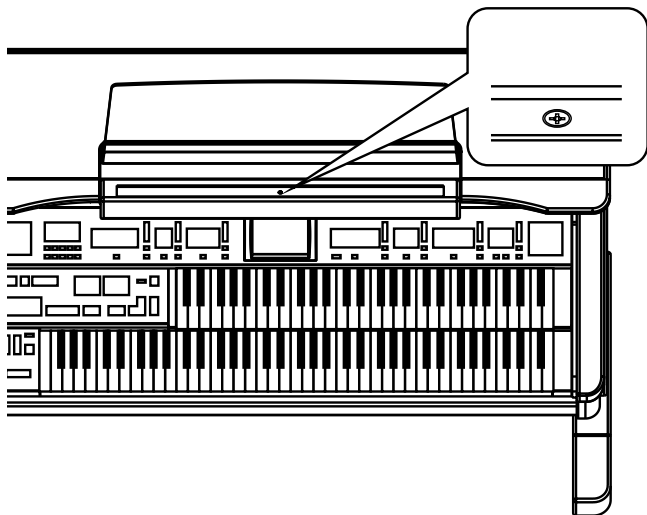

NOTE

Do not lose the screws that you remove, since they will be needed when re-attaching the music stand lamp cover.

3. Slide the right edge and left edge of the music stand lamp cover toward the center.

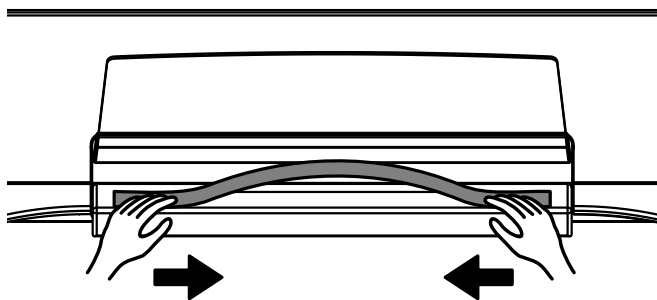

4. Grasp the center of the lamp cover, and remove it.

Remove/install the light bulb

5. Grasping the body of the light bulb, slowly pull it toward yourself to remove it.

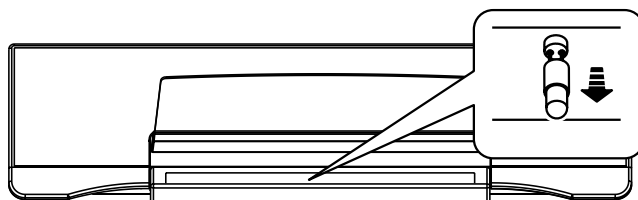

6. Align the pins of the new light bulb with the holes of the socket, and insert the bulb straight in.

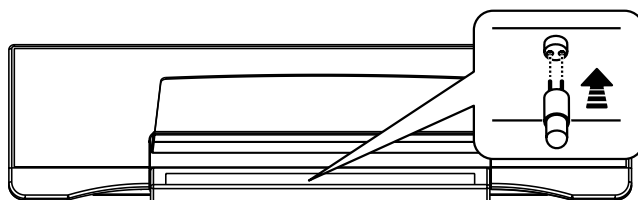

NOTE

Be aware that if the pins of the light bulb are not aligned with the holes of the socket when installing the bulb, or if the bulb is inserted at an angle, the pins of the bulb could get damaged.

NOTE

Never turn on the power while replacing a light bulb.

Attach the music stand lamp cover

7. Place the right edge and left edge of the lamp cover into the groove of the music stand.
8. Lightly press the center of the lamp cover.
9. Align the holes in the lamp cover with the holes in the music stand, and insert the screws.
10. Use a Phillips screwdriver to tighten the screws.

NOTE

At this time, be sure not to tighten the screws excessively.

NOTE

You must use the included screws. If you fail to observe these precautions, the screw holes could become damaged, making it impossible to tighten the screws.

■ Pedal illumination (AT-90S only)

Remove the foot lamp cover

1. Unplug the power cord from the AC outlet.
2. Insert a screwdriver vertically into the slot of the foot lamp cover, and pull the screwdriver toward yourself to remove the foot lamp cover.

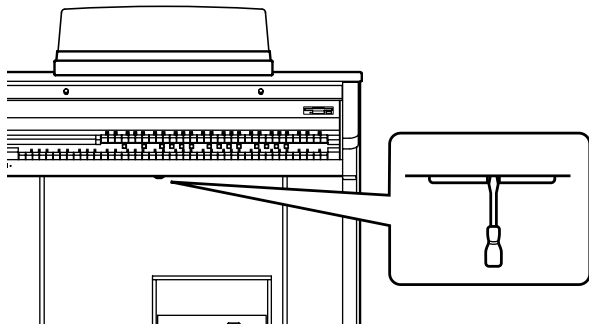

NOTE

When removing the foot lamp cover, do not pull the screwdriver forcefully.

Remove/install the light bulb

1. Grasp the body of the light bulb, and while pressing it inward, slowly turn it toward yourself and remove it.

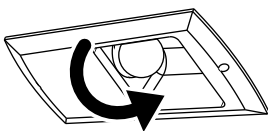

2. Align the protrusions of the new light bulb with the slots of the socket.

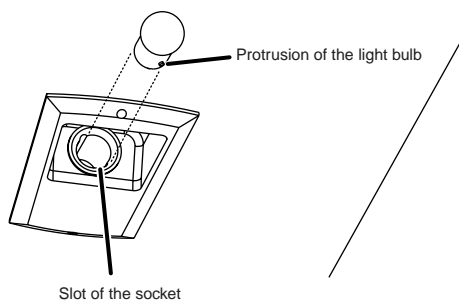

3. While pressing the light bulb inward, turn it away from yourself.

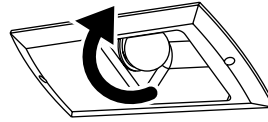

NOTE

When installing the light bulb, turn it until it stops.

Attach the foot lamp cover

1. Position the foot lamp cover as shown in the diagram below.

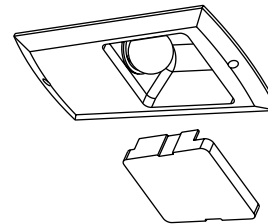

NOTE

When attaching the foot lamp cover, be sure that the left/right orientation is correct. If the left/right orientation is incorrect when you insert the cover into the slot, it may be damaged.

2. Raise the foot lamp cover until it stops.

Remplacement des ampoules

⚠ WARNING

- Avant de remplacer les ampoules, éteignez l'appareil et débranchez le câble d'alimentation de la prise électrique.
- Remplacez l'ampoule une fois qu'elle est refroidie (à la température de la pièce).
- Ne touchez pas une ampoule chaude.
- Si l'ampoule est grillée, remplacez-la le plus tôt possible.
- S'il y a des jeunes enfants, faites attention qu'ils ne mettent pas l'ampoule ou les vis enlevées dans leur bouche.
- Ne mettez jamais l'appareil d'éclairage sous tension pendant que vous remplacez une ampoule. Si l'appareil d'éclairage est sous tension pendant le remplacement, l'ampoule chauffera et il y aura risque de brûlure.
- L'ampoule de remplacement doit être du modèle spécifié.

■ Avant de poursuivre le remplacement

- Notez l'ampoule grillée.
Avant d'entreprendre le remplacement, vous devez noter l'emplacement de l'ampoule à remplacer pour vous assurer que l'éclairage n'est pas allumé pendant que vous remplacez l'ampoule grillée.
- Éteignez l'appareil et laissez-le éteint au moins 20 minutes avant de changer l'ampoule.
Lorsque l'éclairage est allumé, l'ampoule et les surfaces à proximité de l'ampoule seront chaudes. Éteignez l'appareil 20 minutes avant de changer l'ampoule et assurez-vous que les surfaces à proximité de l'ampoule sont refroidies avant de la changer.
- Ayez l'ampoule de remplacement sous la main

■ Outils nécessaires

- Tournevis à pointe cruciforme (no 2) (pour remplacer l'ampoule du lutrin)
- Tournevis pour écrous à fente (pour remplacer l'ampoule d'éclairage des pédales)
- Ampoule de remplacement

Zone d'éclairage	Type d'ampoule
Éclairage du panneau	AMPOULE FB33 (AT-80S, AT-90S)
Éclairage des pédales	AMPOULE TYPE67 (1460-011) (AT-90S uniquement)
Éclairage du lutrin	Ampoule FB33 (AT-90S uniquement)

■ Éclairage du panneau (AT-90S/80S)

Retirer le couvercle de la lampe du tableau

1. Débranchez le câble d'alimentation de la prise.
2. Soulevez légèrement le couvercle des deux mains, faites-le glisser vers l'arrière et ouvrez-le.
3. Dévissez les quatre vis (B) qui retiennent le couvercle (A) de la lampe du tableau.

NOTE

Il n'est pas possible de retirer complètement les vis du couvercle.

NOTE

Ne retirez pas d'autres vis que les quatre vis montrées dans l'illustration.

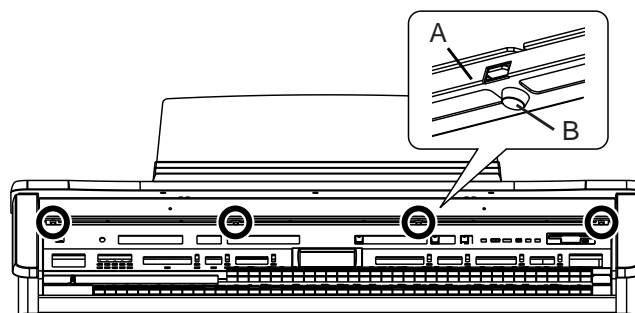

4. Soulevez légèrement le couvercle et retirez-le du crochet qui le retient.

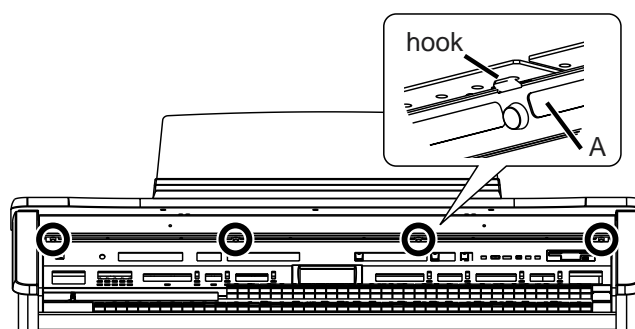

Retrait de l'ampoule grillée et installation de l'ampoule de remplacement

5. Soulevez légèrement le couvercle.
6. Saisissez l'ampoule. **Ne touchez pas la partie métallique de l'ampoule** et tirez-la lentement vers vous pour la retirer.
7. Alignez les broches de la nouvelle ampoule et les trous de la douille et insérez l'ampoule tout droit.

NOTE

Assurez-vous que les broches de l'ampoule soient bien alignées avec les trous de la douille; si l'ampoule est insérée en angle, il y a risque d'endommager les broches.

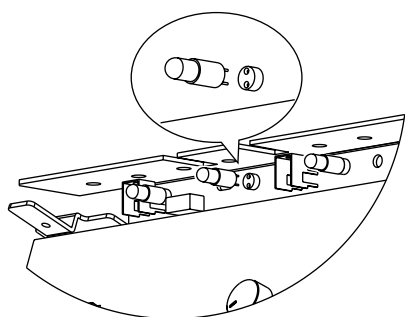

NOTE

Ne déconnectez pas le connecteur situé à côté de l'ampoule.

NOTE

Faites attention de ne pas toucher la pièce métallique à laquelle la plaque de soutien de la lampe est suspendue.

NOTE

N'allumez jamais l'appareil pendant le remplacement d'une ampoule.

Fixer le couvercle de la lampe du tableau

1. Aligned l'ouverture angulaire du couvercle de la lampe du tableau et le crochet.

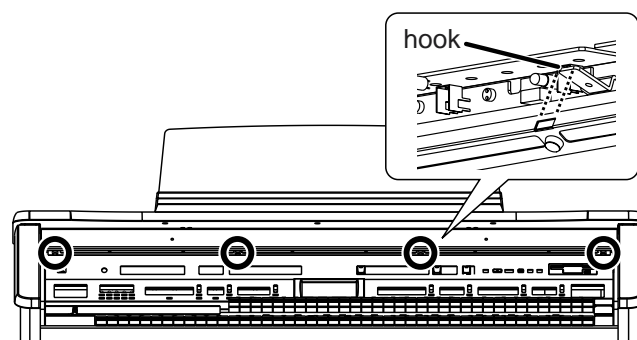

2. Accrochez le couvercle de la lampe au crochet.
3. Saisissez les deux vis situées au centre du couvercle de la lampe et tout en soulevant le couvercle, vissez-les légèrement.

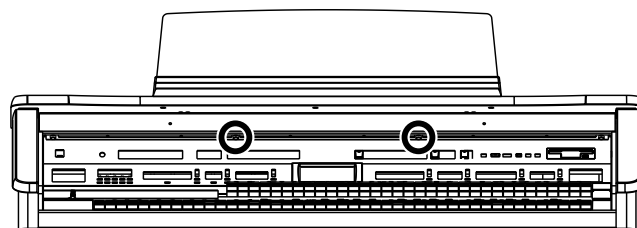

NOTE

À cette étape, ne vissez pas complètement les vis.

4. Vissez complètement les vis aux extrémités gauche et droite du couvercle.
5. Vissez complètement les deux vis au centre du couvercle du panneau de la lampe.

NOTE

Les quatre vis doivent être serrées.

Remplacement des ampoules

■ Éclairage du lutrin (AT-90S uniquement)

Retirer le couvercle de la lampe du lutrin

1. Débranchez le câble d'alimentation de la prise.
2. À l'aide d'un tournevis à tête cruciforme, retirez les vis qui retiennent le couvercle de la lampe du lutrin.

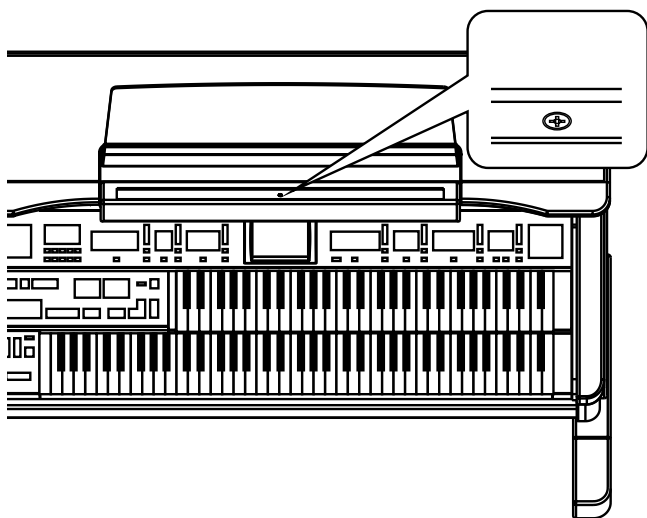

NOTE

Prenez soin de ne pas perdre les vis retirées puisqu'elles serviront à fixer le couvercle une fois l'ampoule remplacée.

3. Faites glisser l'extrémité droite (ou gauche) du couvercle de la lampe du lutrin vers le centre.

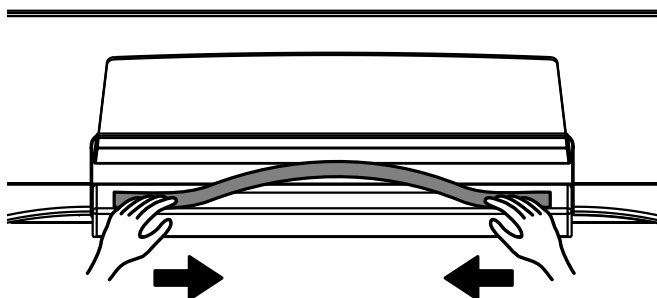

4. Saisissez le centre du couvercle et retirez-le.

Retrait de l'ampoule grillée et installation de l'ampoule de remplacement

5. Saisissez l'ampoule et tirez-la doucement vers vous pour la retirer.

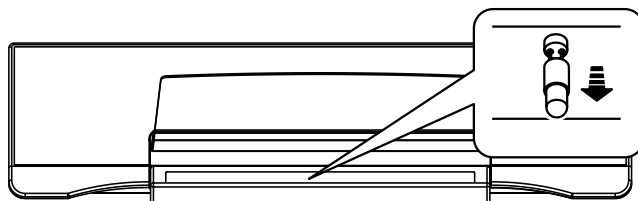

6. Alignez les broches de la nouvelle ampoule et les trous de la douille et insérez l'ampoule tout droit.

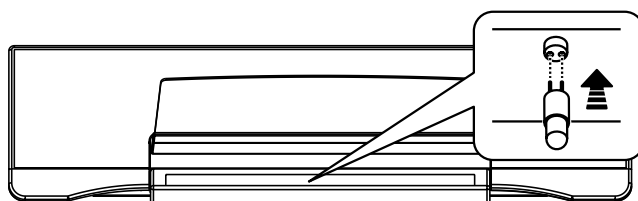

NOTE

Assurez-vous que les broches de l'ampoule soient bien alignées avec les trous de la douille; si l'ampoule est insérée en angle, il y a risque d'endommager les broches.

NOTE

N'allumez jamais l'appareil pendant le remplacement d'une ampoule.

Fixer le couvercle de la lampe du lutrin

7. Placez les extrémités droite et gauche du couvercle de la lampe dans les fentes du lutrin.
8. Appuyez légèrement sur le centre du couvercle de la lampe.
9. Alignez les trous du couvercle et ceux du lutrin et insérez les vis.
10. À l'aide d'un tournevis à tête cruciforme, serrez les vis.

NOTE

À cette étape, assurez-vous de ne pas trop serrer les vis.

NOTE

Il faut utiliser les vis fournies. Si vous ne respectez pas cette consigne, vous risquez d'endommager les trous prévus pour les vis, et il peut devenir impossible de les serrer.

■ Éclairage des pédales (AT-90S uniquement)

Retirer le couvercle de la lampe inférieure

1. Débranchez le câble d'alimentation de la prise.
2. Insérez un tournevis pour écrous à fente verticalement dans la fente du couvercle de la lampe et tirez-le vers vous pour retirer le couvercle.

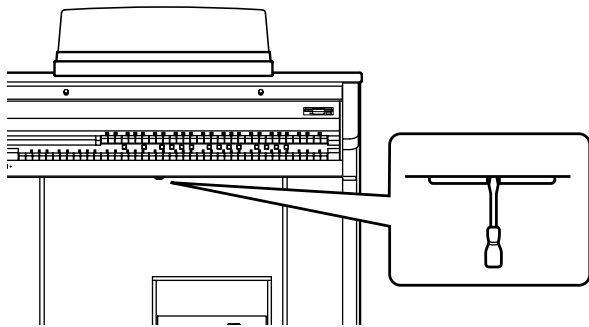

NOTE

Ne tirez pas violemment le tournevis pour retirer le couvercle.

Retrait de l'ampoule grillée et installation de l'ampoule de remplacement

1. Saisissez l'ampoule et, tout en la pressant vers l'intérieur, tournez-la lentement vers vous et retirez-la.

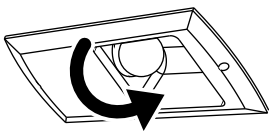

2. Alignez les renflements de l'ampoule de remplacement et les fentes de la douille.

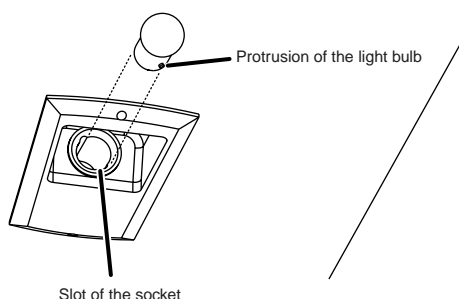

3. Tout en appuyant sur l'ampoule, tournez-la pour l'éloigner de vous.

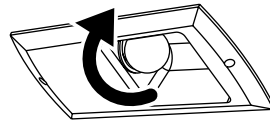

NOTE

Lors de l'installation de l'ampoule, tournez-la jusqu'à l'arrêt.

Fixer le couvercle de la lampe

1. Placez le couvercle de la lampe comme le montre le schéma ci-dessous.

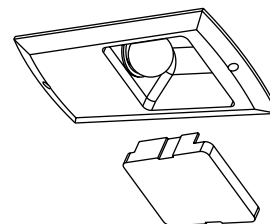

NOTE

Lorsque vous fixez le couvercle de la lampe, assurez-vous que les côtés gauche et droit sont bien orientés. Sinon, vous risquez d'endommager le couvercle en l'insérant dans la fente.

2. Relevez le couvercle jusqu'à l'arrêt.

Settings That Are Stored After the Power Is Turned Off

■ Settings That Are Stored After the Power Is Turned Off

Arranger Update
Transpose Update
Master Tune
Rotary Speed
Rotary Color
Registration Shift
Expression Curve
Send PC Switch
MIDI IN Mode
Lyric On/Off
Metronome Sound
Mic Echo
Aux Out Mode
TV Format
Registration Name

■ Settings That Are Stored In the Registration Buttons

Registration Name
Registration Shift
Arranger Update
Transpose Update

■ Settings That Are Stored In the Individual Registration Buttons

Reverb Type
Reverb Depth
Solo [To Lower] button (ON/OFF)
Bass [To Lower] button (ON/OFF)
Key Transpose
Left Foot Switch Assignment
Right Foot Switch Assignment
Damper Pedal Assignment
Aux Out ON/OFF
[Harmony Intelligence] button (ON/OFF)
Harmony Intelligence Type
Rotary [Fast/Slow] button (ON/OFF)
Rotary [ON/OFF] button (ON/OFF)
Bender/Glide Assignment
Pitch Bend Range
Pedal Bass Mode

Solo Mode
Solo To Lower Mode
Solo Split Point
[Bass Split] button (ON/OFF)
Bass Split Point
Sustain buttons (ON/OFF)
Sustain Length
Tx MIDI Channel
After Touch ON/OFF
Initial Touch ON/OFF
Footage Tablet settings (Organ Type, Upper/Lower Footage, Percussion, Volume, Reverb)
PC Number
Bank LSB
Bank MSB
Wall Type

The Voices assigned for each part
Level [▲] [▼] (Part Balance Volume)
The Reverb depth for each part
The Chorus settings (ON/OFF) of the voice
The Octave settings for each part
The voices assigned to the [Others] buttons for each part
[Drums/SFX] button (ON/OFF)
[Manual Percussion] button (ON/OFF)
Drum/SFX Set
Manual Percussion Set
Selected Rhythm
[Intro/Ending] button (ON/OFF)
[Sync Start] button (ON/OFF)
Style Orchestrator
Variation ON/OFF
Chord Intelligence ON/OFF
Leading Bass ON/OFF
Arranger [ON/OFF] button (ON/OFF)
Lower Voice [Hold] button (ON/OFF)
Tempo setting
Volume of the rhythm Accompaniment part
Reverb depth of the rhythm Accompaniment part
Volume of the rhythm drum part
Reverb depth of the rhythm drum part
Volume of the rhythm bass part
Reverb depth of the rhythm bass part

MIDI Implementation Chart

Function...	Transmitted	Recognized	Remarks
Basic Channel Default Changed	9 (Drums/SFX) 11 (Manual Percussion) 12 (Lower) 13 (Upper) 14 (Pedal Bass) 16 (Solo, Expression, PC) 1-16	1-16 1-16 1-16 1-16 1-16 1-16 1-16	
Mode Default Messages Altered	x x *****	Mode 3 Mode 3, 4(M=1)	* 5
Note Number : True Voice	24-110 *****	0-127 0-127	
Velocity Note ON Note OFF	O *1 x 8n v=64	O x	
After Touch Key's Ch's	x x	O O	*2 *2
Pitch Bend	x	O	*2
Control Change	0, 32 O *1 1 x 5 x 6, 38 x 7 x 10 x 11 O 16 x 64 O 65 x 66 x 67 x 84 x 91 x 93 x 98, 99 x 100, 101 x	O *3 O *2 O *2 O *2 O *2 O *3 O *3 O *3 O *4 O *3 O *3 O *2 O *2 O *2 O *3 O *3 O *3 O *3 O *2	Bank select Modulation Portamento time Data entry Volume Panpot Expression Glide General purpose controller (Glide) Portamento Sostenuto Soft Portamento control Effect1 depth Effect3 depth NRPN LSB, MSB RPN LSB, MSB
Prog Change : True #	0-127 *1 *****	O *3 0-127	Program number 1-128
System Exclusive	x	O	
System Common : Song Pos : Song Sel : Tune	x x x	x x x	
System Real Time : Clock : Commands	O O	x x	
Aux Message : All sound off : Reset all controllers : Local Control : All Notes OFF : Active Sense : Reset	x x x x O x	O (120, 126, 127) O x O (123-125) O x	
Notes	* 1 O x is selectable. * 2 O x is selectable by SysEx. * 3 Recognize only GS Part. * 4 Recognize only Keyboard Part. * 5 Recognize as M=1 even if M≠1.		

Mode 1 : OMNI ON, POLY
 Mode 3 : OMNI OFF, POLY

Mode 2 : OMNI ON, MONO
 Mode 4 : OMNI OFF, MONO

O : Yes
 X : No

Demo Song List

AT-90S/80S

Song Title	Composer	Player	Copyright
Orchestra	Hector Olivera	Hector Olivera	© 2001 Roland Corporation
FastBigBand	Rosemary Bailey	Rosemary Bailey	© 2001 Roland Corporation
Pipe&Choir	Hector Olivera	Hector Olivera	© 2001 Roland Corporation
Soprano	W.A.Mozart	Hector Olivera	© 2001 Roland Corporation
Tenor	Ric Iannone	Ric Iannone	© 1999 Roland Corporation
PianoStrings	Hector Olivera	Hector Olivera	© 2001 Roland Corporation
Soft Gospel	Ric Iannone	Ric Iannone	© 2001 Roland Corporation
Organ Swing	Hal Vincent	Hal Vincent	© 2001 Roland Corporation
Acoustic	Ric Iannone	Ric Iannone	© 2001 Roland Corporation
Jazz Scat	Ric Iannone	Ric Iannone	© 1999 Roland Corporation
Pipe organ	Hector Olivera	Hector Olivera	© 1999 Roland Corporation
Orchestra2	Hector Olivera	Hector Olivera	© 1999 Roland Corporation
Big Band	Ric Iannone	Ric Iannone	© 1999 Roland Corporation
TheaterOrgan	Jonas Nordwall	Jonas Nordwall	© 1995 Rodgers Instruments LLC
Choir	Hector Olivera	Hector Olivera	© 1999 Roland Corporation
Gregorian	Ric Iannone	Ric Iannone	© 1999 Roland Corporation
Soprano2	Rachmaninov S.	Hector Olivera	© 1999 Roland Corporation

AT-60S

Song Title	Composer	Player	Copyright
FastBigBand	Rosemary Bailey	Rosemary Bailey	© 2001 Roland Corporation
Organ Swing	Hal Vincent	Hal Vincent	© 2001 Roland Corporation
PianoStrings	Hector Olivera	Hector Olivera	© 2001 Roland Corporation
Soft Gospel	Ric Iannone	Ric Iannone	© 2001 Roland Corporation
Choir	Hector Olivera	Hector Olivera	© 1999 Roland Corporation
Jazz Scat	Ric Iannone	Ric Iannone	© 1999 Roland Corporation
Acoustic	Ric Iannone	Ric Iannone	© 2001 Roland Corporation
TheaterOrgan	Jonas Nordwall	Jonas Nordwall	© 1995 Rodgers Instruments LLC
Big Band	Ric Iannone	Ric Iannone	© 1999 Roland Corporation
Gregorian	Ric Iannone	Ric Iannone	© 1999 Roland Corporation

Profile

Hal Vincent

Hal consistently delights his audiences with his keyboard artistry. He is equally at home on either the organ, piano, or electronic keyboard. Around the world, his concerts generate the often heard comment "...we loved it because he plays our kind of music." This is another of Hal's special skills: a knack for knowing just what music to play on any occasion.

An extensive repertoire combined with more than 30 years of world touring have netted Hal rave reviews while affording him the opportunity to work with some of the top names in show business. Hal has recorded several albums and published books of organ arrangements while establishing himself as an excellent clinician and teacher.

Hector Olivera

Hector Olivera was born in Argentina. He received his education at the Conservatory and the University of Buenos Aires followed by a scholarship at the famous Juilliard School of Music in New York. Olivera has performed extensively throughout the world including concerts at prestigious places such as the Notre Dame Cathedral in Paris and Carnegie Hall in New York. Hector Olivera's expertise involves both the traditional pipe organ and the electronic organ. Presently Olivera tours internationally playing some of the world's most magnificent pipe organs as well as his preferred electronic organ, the Roland Atelier for which he continues to collaborate with its development.

Jonas Nordwall

A native of Portland, Mr. Nordwall received his Bachelor of Music Degree in 1970 from the University of Portland studying with Arthur Hitchcock. Additional study was done with Frederick Geoghegan, the noted English/Canadian organist. As a teenager, Jonas had the privilege to study with Richard Ellsasser, one of the greatest virtuoso organist of 20th century.

Besides serving as Director of Music for the First United Methodist Church in Portland, Oregon and as the Organist for the Oregon Symphony Orchestra.

He has been a featured recitalist for national conventions of the American Theatre Organ Society and was Organist of the year for 1987.

Ric Iannone

Ric Iannone began playing the piano and accordion at the age of two and a half. By the time he was seven, he was performing public and private engagements with his musician father. For more than 20 years Ric has performed and traveled extensively throughout the United States and Europe, delighting audiences with his unique playing style and music arrangements. He is equally comfortable playing the organ, piano or keyboard, as a concert artist and product demonstrator.

Rosemary Bailey

Rosemary Bailey began playing the piano at the age of five, performing strictly classical music. She soon diversified and incorporated jazz and traditional popular styles in her repertoire. By the time she was nine years old, Rosemary had begun touring throughout the United states.

Concurrently, she maintained a weekly radio show, The Rosemary Bailey Show, broadcast from Chicago.

Rosemary has performed with many name artists including Victor Borge and Peter Nero as well as the Duke Ellington Orchestra. She was also featured soloist with the Chicago Symphony under the direction of Dr. Leon Stein.

At home on electronic as well as pipe organs, her concert schedule has taken her to such countries as Japan, South Africa, Canada, Italy, Spain, England, Holland, Denmark, Portugal, Germany and Australia.

Rosemary's unique arrangements involve the marriage of her classical and popular music background. Perfect pitch enables her to effortlessly field requests from the audience and adds spontaneity to all her programs.

Rosemary has developed a following of musical devotees wherever she performs and her numerous recordings are sought after by young and old alike.

Main Specifications

AT-90S/80S/60S: Music ATELIER

Controller/Function	AT-90S	AT-80S	AT-60S
Keyboard	Upper keyboard 56 notes (C3 - G7), Lower keyboard 76 notes (E1 - G7)		
Pedalboard	25 notes (C2 - C4)	20 notes (C2 - G3)	
Sound Generator	Conforms to GS/GM2		
Max. Polyphony	256 voices	192 voices	128 voices
Voices	340 voices	340 voices	240 voices
Upper Part	Upper Organ, Upper Symphonic, Upper Orchestral		
Lower Part	Lower Organ, Lower Symphonic, Lower Orchestral		
Solo Part	Solo		
Pedal Part	Pedal Organ, Pedal Orchestral		
	Any two voices can be assigned to each [Others] button. (One for Pedal Organ and Pedal Orchestral [Others] button.)		
Footage Voice	O	—	—
Rhythms	200 Rhythms	171 Rhythms	130 Rhythms
Disk Rhythm	16 Rhythms	12 Rhythms	6 Rhythms
	Music Style Disk (MSA series; sold separately) can provide additional Music Styles.		
World Styles	8 styles		6 styles
Number of Accompaniment/SMF play voices	226 voices		
Arranger Function	Arranger On/Off, Start/Stop, Intro/Ending, Sync Start, Fill In (Variation/Original), Leading Bass, Style Orchestrator, Break, Chord Intelligence, One Touch Program, Intro Count Down		
Drum/SFX Sets	16 Drum Sets/1 SFX Set		
Manual Percussion Sets	11 Sets		5 Sets
Master Tuning	415.3 Hz - 466.2 Hz (0.1 Hz Steps)		
Key Transpose	-6 - +5 (Half steps)		
Playback Transpose	-24 - +24 (Half steps)		
Effects	Rotary Sound, Chorus, Sustain, Vibrato, Pitch Bend, Glide		
	Rss Reverb		Reverb
Harmony Intelligence	24 Types	18 Types	12 Types
Registration Memories	12		8
Registration Functions	Load Next, Disk Edit		

Main Specifications

Controller/Function	AT-90S	AT-80S	AT-60S
Composer			
Tracks	7 Tracks		
Note Storage	Approx. 40,000 notes		
Song Length	Max. 999 measures		
Tempo	Quarter note = 20–250		
Resolution	120 ticks per quarter note		
Recording	Realtime (Replace, Punch In/Out, Loop)		
Edit Function	Delete Measure, Delete Track, Erase, Copy, Quantize		
Metronome			
Beat	2/2, 0/4, 2/4, 3/4, 4/4, 5/4, 6/4, 7/4, 3/8, 6/8, 9/8, 12/8		
Volume	10 levels		
Sound	4 types		
Disk Storage: 3.5 inch micro floppy disk			
Disk Format	720 K bytes (2DD), 1.44 M bytes(2HD)		
Songs	Max. 56 (2DD), Max. 99 (2HD)		
Rated Power Output			
	10 W x 2, 60 W x 2, 100 W (low-range)		40 W x 2
Speaker			
Full-range (small)	8 cm x 2		8 cm x 2
Full-range (large)	16 cm x 4		25 cm x 2
Woofer	30 cm x 1		—
Tweeter	5 cm x 4	—	—
Display			
	Graphic 320 x 240 dots backlit LCD with touch screen (Color)		Graphic 320 x 240 dots backlit LCD with touch screen (monochrome)
Score	Great Staff, G Clef Staff, F Clef Staff with note name, with Lyric (Built-in Display)		Great Staff/ G Clef Staff/F Clef Staff with note name, with Lyric (Built-in Display)
Lyric	Yes (Built-in Display, Video Out)		Yes (Built-in Display)
Pedal	Damper Pedal, Expression Pedal		
Connectors			
	Phones jack (Stereo), AC Inlet, Pedal connector, MIDI connectors (In/Out), Audio output jacks (L (mono)/R), Audio input jacks (L (mono)/R), Mic jack, Computer connector		
	Aux Out jack, Video Out jack		—

Main Specifications

Controller/Function	AT-90S	AT-80S	AT-60S
Power Supply	AC 117 V, AC 230 V, AC 240 V		
Power Consumption	380 W (AC 117V) 380 W (AC 230V) 380 W (AC 240V)	340 W (AC 117V) 340 W (AC 230V) 340 W (AC 240V)	130 W (AC 117V) 130 W (AC 230V) 130 W (AC 240V)
Finish	Dark Walnut		Satin Mahogany
Dimensions			
Console	1374 (W) x 677 (D) x 1349 (H) mm 54-1/8" (W) x 26-11/16" (D) x 53-1/8" (H) inches	1350 (W) x 649 (D) x 570 (H) mm 53-3/16" (W) x 25-9/16" (D) x 22-1/2" (H) inches	1331 (W) x 649 (D) x 529 (H) mm 52-7/16" (W) x 25-9/16" (D) x 20-7/8 (H) inches
Stand	—	1328 (W) x 596 (D) x 755 (H) mm 52-5/16" (W) x 23-1/2" (D) x 29-3/4 (H) inches	1324 (W) x 596 (D) x 755 (H) mm 52-1/8" (W) x 23-1/2" (D) x 29-3/4 (H) inches
Pedalboard	1158 (W) x 834 (D) x 130 (H) mm 45-5/8" (W) x 32-7/8" (D) x 5-1/8" (H) inches	—	—
Total	1374 (W) x 999 (D) x 1349 (H) mm 54-1/8" (W) x 39-3/8" (D) x 53-1/8" (H) inches	1350 (W) x 649 (D) x 1317 (H) mm 53-3/16" (W) x 25-9/16" (D) x 51-7/8 (H) inches	1331 (W) x 649 (D) x 1284 (H) mm 52-7/16" (W) x 25-9/16" (D) x 50-9/16(H) inches
Weight			
Console	152.0 kg 335 lbs 2 oz	65.5 kg 144 lbs 7 oz	61.0 kg 134 lbs 8 oz
Stand	—	61.0 kg 134 lbs 8 oz	45.0 kg 99 lbs 4 oz
Pedalboard	24.0 kg 52 lbs 15 oz	—	—
Total	176.0 kg 388 lbs 1 oz	126.5 kg 278 lbs 15 oz	106.0kg 233 lbs 11 oz
Accessories	Owner's manual, 3.5 inch micro floppy disk (2HD) (Blank Disk), Music Style Disk, World Style Setup Disk, Power Cord, Voice and Rhythm List		
	Pedalboard	—	—

* In the interest of product improvement, the specifications and/or appearance of this unit are subject to change without prior notice.

Index

A

Active Expression Voice	44
Aftertouch	157
Aftertouch Sensitivity	157
Arranger Update	166
Automatic Accompaniment	61
Aux Out	185
Aux Out Mode	185

B

Bass Split	125
Beat	170
Bender/Vibrato	163
BMP Installer	175
Break	62, 160
Brilliance	104

C

Calibration	175
Ch. Mute (Channels Mute)	170
Chord Hold	165
Chord Intelligence	63, 164
Chorus Effect	112
Connecting	
Audio Equipment	180
Computer	181
MIDI Devices	183
Copy	154
Count Down	61
Count Down Sound	166
Count-In Recording	145

D

Damper Pedal	103, 161, 163
Delete Measure	149
Delete Track	150
Deleting	
Performance Songs	142
Registrations on a Floppy Disk	94
Demo Song	32
Demo Song List	224
Disk Edit	96
Disk Rhythm	68
Drums/SFX	52
Drums/SFX Set List	198
Drums/SFX Sets	53

E

Editing	149
Effects	106
Erase Event	152
Erasing	
Performance Song	137
EXP. Src (Play)	162
EXP. Src (Rec)	162
Expression Pedal	103

F

Factory Reset	22
Factory Setting	
Disk button	72
World button	75
Fill In	62, 160
Foot Switch	105, 160
Footage	45
Formatting Disks	82

G

Glide	160
-------------	-----

H

Harmony Intelligence	106, 109
Headphones	20
Human Voice	42

I

Illumination	21
Replacing the Illumination Bulbs	214
Initial Touch	158

K

Key Transpose	102
---------------------	-----

L

LCD Contrast	178–179
Leading Bass	64, 160, 165
Load Next	92
Loading	
Disk Rhythms (Music Style Disk)	70
Disk Rhythms (World Style Disk)	73
Individual Registration	89
Performance Songs	140
Set of Registrations	87
Loop Recording	144
Lower Hold	56
Lower Voice	37
Lyrics	167

M

Main Screen	24
Manual Percussion	54
Manual Percussion List	202
Manual Percussion Sets	55
Master Tune	171
Metronome	168
Metronome Sound	169
Metronome Volume	169
Mic Echo	172
Microphone	20
MIDI	183
MIDI IN Mode	173
Music Assistant	30
Music Style Disk List	209

Index

O

- Octave Shift 50
- One Touch Program 66

P

- Part Balance 48
- PC Number 173
- Pedal Bass Voice 38
- Pedal To Lower 126
- PedalBass Mode 158
- Pitch Bend Range 164
- Pitch Bend/Vibrato 104
- Play Transpose 168
- Playing
 - Demo Song 32
 - Performance Song 133
 - Performance Songs Stored on Floppy Disk 130
 - Rhythm 58
- Punch-in Recording 143

Q

- Quick Guide 27
 - Index menu 28
- Quick Registration 100

R

- Recording 129
 - Each Part Separately 135
 - Performance 132
 - Re-Recording 136
- Regist Shift 161
- Registration
 - Arranger Update 78
 - Recalling a Registration 77
 - Storing Registrations 76
- Registrations
 - Created on an Earlier Model 97
- Rename
 - Performance Song 137
 - Registration 80
- Reverb Effect 114
 - Depth of the Reverb 117–118
 - Reverb Type 115
 - Wall Type 116
- Rhythm 57
- Rhythm List 204
- Rotary Effect 111, 160
 - Rotary Color 120
 - Rotary Speed 119
- RSS Reverb 185

S

- Saving
 - Performance Songs 139
 - Registration Sets 84
- Score 145

- Send PC Switch 172
- SMF Format 140
- SMF Music Files 130
- Solo Mode 159
- Solo To Lower 124
- Solo To Lower Mode 159
- Solo Voice 39
- Split Point
 - Bass Split Point 128
 - Solo Split Point 127
- Style Orchestrator 62, 160
- Sub-window 26
- Sustain Effect 113
 - Sustain Length 121
- Sync Start 59

T

- Tempo 60
- Track Button 129
- Track Mute 134
- Trans. Update (Transpose Update) 167
- Transpose
 - Key Transpose 102
 - Play Transpose 168
- TV Format 184
- Tx MIDI Ch. (MIDI Transmit Channel) 174

U

- Upper Voice 37

V

- Video Out 184
- Voice 34
- Voice List 193
- Volume
 - Master Volume 19
 - Part Balance 48

For EU Countries



This product complies with the requirements of European Directives EMC 89/336/EEC and LVD 73/23/EEC.

For the USA

FEDERAL COMMUNICATIONS COMMISSION RADIO FREQUENCY INTERFERENCE STATEMENT

This equipment has been tested and found to comply with the limits for a Class B digital device, pursuant to Part 15 of the FCC Rules. These limits are designed to provide reasonable protection against harmful interference in a residential installation. This equipment generates, uses, and can radiate radio frequency energy and, if not installed and used in accordance with the instructions, may cause harmful interference to radio communications. However, there is no guarantee that interference will not occur in a particular installation. If this equipment does cause harmful interference to radio or television reception, which can be determined by turning the equipment off and on, the user is encouraged to try to correct the interference by one or more of the following measures:

- Reorient or relocate the receiving antenna.
- Increase the separation between the equipment and receiver.
- Connect the equipment into an outlet on a circuit different from that to which the receiver is connected.
- Consult the dealer or an experienced radio/TV technician for help.

This device complies with Part 15 of the FCC Rules. Operation is subject to the following two conditions:

- (1) This device may not cause harmful interference, and
- (2) This device must accept any interference received, including interference that may cause undesired operation.

Unauthorized changes or modification to this system can void the users authority to operate this equipment.
This equipment requires shielded interface cables in order to meet FCC class B Limit.

For Canada

NOTICE

This Class B digital apparatus meets all requirements of the Canadian Interference-Causing Equipment Regulations.

AVIS

Cet appareil numérique de la classe B respecte toutes les exigences du Règlement sur le matériel brouilleur du Canada.

