

8-Channel AD/DA Converter **ADA-7000**

Owner's Manual

Thank you for purchasing the Roland **ADA-7000** 8-Channel AD/DA Converter. By connecting the ADA-7000 to a Roland digital mixer or Roland digital recorder that has an R-BUS connector, you can expand to an additional 8 channels of analog input/output.

Before using this unit, carefully read the sections entitled: "IMPORTANT SAFETY INSTRUCTIONS" (p. 2), "USING THE UNIT SAFELY" (p. 3), and "IMPORTANT NOTES" (p. 5). These sections provide important information concerning the proper operation of the unit. Additionally, in order to feel assured that you have gained a good grasp of every feature provided by your new unit, Owner's Manual should be read in its entirety. The manual should be saved and kept on hand as a convenient reference.

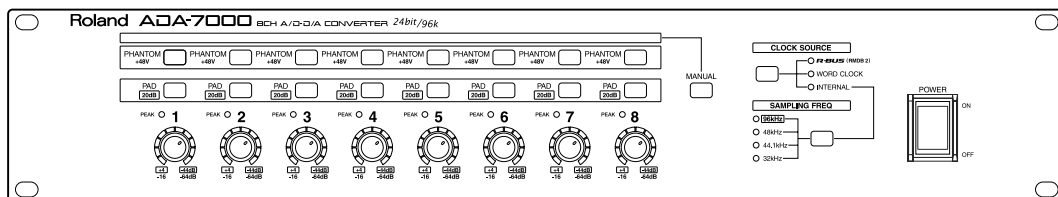



All product names mentioned in this document are trademarks or registered trademarks of their respective owners.

Copyright © 1999 ROLAND CORPORATION

All rights reserved. No part of this publication may be reproduced in any form without the written permission of ROLAND CORPORATION.

Roland Web site: <http://www.roland.co.jp/>

	CAUTION RISK OF ELECTRIC SHOCK DO NOT OPEN	
ATTENTION: RISQUE DE CHOC ELECTRIQUE NE PAS OUVRIR		
CAUTION: TO REDUCE THE RISK OF ELECTRIC SHOCK, DO NOT REMOVE COVER (OR BACK). NO USER-SERVICEABLE PARTS INSIDE. REFER SERVICING TO QUALIFIED SERVICE PERSONNEL.		



The lightning flash with arrowhead symbol, within an equilateral triangle, is intended to alert the user to the presence of uninsulated "dangerous voltage" within the product's enclosure that may be of sufficient magnitude to constitute a risk of electric shock to persons.



The exclamation point within an equilateral triangle is intended to alert the user to the presence of important operating and maintenance (servicing) instructions in the literature accompanying the product.

INSTRUCTIONS PERTAINING TO A RISK OF FIRE, ELECTRIC SHOCK, OR INJURY TO PERSONS.

IMPORTANT SAFETY INSTRUCTIONS

SAVE THESE INSTRUCTIONS

WARNING - When using electric products, basic precautions should always be followed, including the following:

1. Read these instructions.
2. Keep these instructions.
3. Heed all warnings.
4. Follow all instructions.
5. Do not use this apparatus near water.
6. Clean only with a dry cloth.
7. Do not block any of the ventilation openings. Install in accordance with the manufacturers instructions.
8. Do not install near any heat sources such as radiators, heat registers, stoves, or other apparatus (including amplifiers) that produce heat.
9. Do not defeat the safety purpose of the polarized or grounding-type plug. A polarized plug has two blades with one wider than the other. A grounding type plug has two blades and a third grounding prong. The wide blade or the third prong are provided for your safety. When the provided plug does not fit into your outlet, consult an electrician for replacement of the obsolete outlet.
10. Protect the power cord from being walked on or pinched particularly at plugs, convenience receptacles, and the point where they exit from the apparatus.
11. Only use attachments/accessories specified by the manufacturer.
12. Never use with a cart, stand, tripod, bracket, or table except as specified by the manufacturer, or sold with the apparatus. When a cart is used, use caution when moving the cart/apparatus combination to avoid injury from tip-over.
13. Unplug this apparatus during lightning storms or when unused for long periods of time.
14. Refer all servicing to qualified service personnel. Servicing is required when the apparatus has been damaged in any way, such as power-supply cord or plug is damaged, liquid has been spilled or objects have fallen into the apparatus, the apparatus has been exposed to rain or moisture, does not operate normally, or has been dropped.



For the U.K.

WARNING: THIS APPARATUS MUST BE EARTHED

IMPORTANT: THE WIRES IN THIS MAINS LEAD ARE COLOURED IN ACCORDANCE WITH THE FOLLOWING CODE.
GREEN-AND-YELLOW: EARTH, BLUE: NEUTRAL, BROWN: LIVE

As the colours of the wires in the mains lead of this apparatus may not correspond with the coloured markings identifying the terminals in your plug, proceed as follows:

The wire which is coloured GREEN-AND-YELLOW must be connected to the terminal in the plug which is marked by the letter E or by the safety earth symbol  or coloured GREEN or GREEN-AND-YELLOW.



The wire which is coloured BLUE must be connected to the terminal which is marked with the letter N or coloured BLACK.

The wire which is coloured BROWN must be connected to the terminal which is marked with the letter L or coloured RED.







USING THE UNIT SAFELY

INSTRUCTIONS FOR THE PREVENTION OF FIRE, ELECTRIC SHOCK, OR INJURY TO PERSONS

About  WARNING and  CAUTION Notices

 WARNING	Used for instructions intended to alert the user to the risk of death or severe injury should the unit be used improperly.
 CAUTION	Used for instructions intended to alert the user to the risk of injury or material damage should the unit be used improperly. * Material damage refers to damage or other adverse effects caused with respect to the home and all its furnishings, as well to domestic animals or pets.

About the Symbols

	The  symbol alerts the user to important instructions or warnings. The specific meaning of the symbol is determined by the design contained within the triangle. In the case of the symbol at left, it is used for general cautions, warnings, or alerts to danger.
	The  symbol alerts the user to items that must never be carried out (are forbidden). The specific thing that must not be done is indicated by the design contained within the circle. In the case of the symbol at left, it means that the unit must never be disassembled.
	The  symbol alerts the user to things that must be carried out. The specific thing that must be done is indicated by the design contained within the circle. In the case of the symbol at left, it means that the power-cord plug must be unplugged from the outlet.



----- ALWAYS OBSERVE THE FOLLOWING -----

WARNING

- Before using this unit, make sure to read the instructions below, and the Owner's Manual. 

- Do not open or perform any internal modifications on the unit. 

- Do not attempt to repair the unit, or replace parts within it (except when this manual provides specific instructions directing you to do so). Refer all servicing to your retailer, the nearest Roland Service Center, or an authorized Roland distributor, as listed on the "Information" page. 

- Never use or store the unit in places that are:
 - Subject to temperature extremes (e.g., direct sunlight in an enclosed vehicle, near a heating duct, on top of heat-generating equipment); or are 
 - Damp (e.g., baths, washrooms, on wet floors); or are 
 - Humid; or are
 - Exposed to rain; or are
 - Dusty; or are
 - Subject to high levels of vibration.

- This unit should be used only with a rack (SYR-4200 or SYR-600) or the arms that is recommended by Roland. 



WARNING

- When using the unit with a rack or stand recommended by Roland, the rack (SYR-4200 or SYR-600) or the arms must be carefully placed so it is level and sure to remain stable. If not using a rack or stand, you still need to make sure that any location you choose for placing the unit provides a level surface that will properly support the unit, and keep it from wobbling. 





- The unit should be connected to a power supply only of the type described in the operating instructions, or as marked on the unit. 

- Do not excessively twist or bend the power cord, nor place heavy objects on it. Doing so can damage the cord, producing severed elements and short circuits. Damaged cords are fire and shock hazards! 







- This unit, either alone or in combination with an amplifier and headphones or speakers, may be capable of producing sound levels that could cause permanent hearing loss. Do not operate for a long period of time at a high volume level, or at a level that is uncomfortable. If you experience any hearing loss or ringing in the ears, you should immediately stop using the unit, and consult an audiologist. 

- Do not allow any objects (e.g., flammable material, coins, pins); or liquids of any kind (water, soft drinks, etc.) to penetrate the unit. 

 **WARNING**

- In households with small children, an adult should provide supervision until the child is capable of following all the rules essential for the safe operation of the unit. 
- Protect the unit from strong impact. (Do not drop it!) 
- Do not force the unit's power-supply cord to share an outlet with an unreasonable number of other devices. Be especially careful when using extension cords—the total power used by all devices you have connected to the extension cord's outlet must never exceed the power rating (watts/amperes) for the extension cord. Excessive loads can cause the insulation on the cord to heat up and eventually melt through. 
- Before using the unit in a foreign country, consult with your retailer, the nearest Roland Service Center, or an authorized Roland distributor, as listed on the "Information" page. 

 **CAUTION**

- The unit should be located so that its location or position does not interfere with its proper ventilation. 
- Always grasp only the plug on the power-supply cord when plugging into, or unplugging from, an outlet or this unit. 
- Try to prevent cords and cables from becoming entangled. Also, all cords and cables should be placed so they are out of the reach of children. 
- Never climb on top of, nor place heavy objects on the unit. 
- Never handle the power cord or its plugs with wet hands when plugging into, or unplugging from, an outlet or this unit. 
- Before cleaning the unit, turn off the power and unplug the power cord from the outlet. 
- Whenever you suspect the possibility of lightning in your area, pull the plug on the power cord out of the outlet. 

IMPORTANT NOTES

In addition to the items listed under “IMPORTANT SAFETY INSTRUCTIONS” and “USING THE UNIT SAFELY” on pages 2 and 3, please read and observe the following:

Power Supply

- Do not use this unit on the same power circuit with any device that will generate line noise (such as an electric motor or variable lighting system).
- Before connecting this unit to other devices, turn off the power to all units. This will help prevent malfunctions and/or damage to speakers or other devices.

Placement

- Using the unit near power amplifiers (or other equipment containing large power transformers) may induce hum. To alleviate the problem, change the orientation of this unit; or move it farther away from the source of interference.
- This device may interfere with radio and television reception. Do not use this device in the vicinity of such receivers.
- Do not expose the unit to direct sunlight, place it near devices that radiate heat, leave it inside an enclosed vehicle, or otherwise subject it to temperature extremes. Excessive heat can deform or discolor the unit.
- To avoid possible breakdown, do not use the unit in a wet area, such as an area exposed to rain or other moisture.

Maintenance

- For everyday cleaning wipe the unit with a soft, dry cloth or one that has been slightly dampened with water. To remove stubborn dirt, use a cloth impregnated with a mild, non-abrasive detergent. Afterwards, be sure to wipe the unit thoroughly with a soft, dry cloth.
- Never use benzine, thinners, alcohol or solvents of any kind, to avoid the possibility of discoloration and/or deformation.

Additional Precautions

- Use a reasonable amount of care when using the unit's buttons, sliders, or other controls; and when using its jacks and connectors. Rough handling can lead to malfunctions.
- When connecting / disconnecting all cables, grasp the connector itself—never pull on the cable. This way you will avoid causing shorts, or damage to the cable's internal elements.
- A small amount of heat will radiate from the unit during normal operation.

- To avoid disturbing your neighbors, try to keep the unit's volume at reasonable levels. You may prefer to use headphones, so you do not need to be concerned about those around you (especially when it is late at night).
- When you need to transport the unit, package it in the box (including padding) that it came in, if possible. Otherwise, you will need to use equivalent packaging materials.
- Use a cable from Roland to make the connection. If using some other make of connection cable, please note the following precautions.
 - Some connection cables contain resistors. Do not use cables that incorporate resistors for connecting to this unit. The use of such cables can cause the sound level to be extremely low, or impossible to hear. For information on cable specifications, contact the manufacturer of the cable.

Copyright

- Unauthorized recording, distribution, sale, lending, public performance, broadcasting, or the like, in whole or in part, of a work (musical composition, video, broadcast, public performance, or the like) whose copyright is held by a third party is prohibited by law.
- When exchanging audio signals through a digital connection with an external instrument, this unit can perform recording without being subject to the restrictions of the Serial Copy Management System (SCMS). This is because the unit is intended solely for musical production, and is designed not to be subject to restrictions as long as it is used to record works (such as your own compositions) that do not infringe on the copyrights of others. (SCMS is a feature that prohibits second-generation and later copying through a digital connection. It is built into MD recorders and other consumer digital-audio equipment as a copyright-protection feature.)
- Do not use this unit for purposes that could infringe on a copyright held by a third party. We assume no responsibility whatsoever with regard to any infringements of third-party copyrights arising through your use of this unit.

Table of Contents

Front and Rear Panels	7
Front Panel.....	7
Rear Panel	9
An Example of Connection	11
Turning the Power On.....	12
Block Diagram.....	13
R-BUS (RMDB2) Circuit Connection	13
Concerning Copyright	14
Troubleshooting.....	15
Supplementary Notes	16
How to connect the VM-7000 series and the ADA-7000.....	16
If the system software of the VM-C7200/C7100 is version 1.10 or later;	17
How to connect the VM-3100Pro and the ADA-7000	18
How to connect the VSR-880 and the ADA-7000.....	18
Note	19
Specifications.....	20
Memo.....	22

Front and Rear Panels

Front Panel

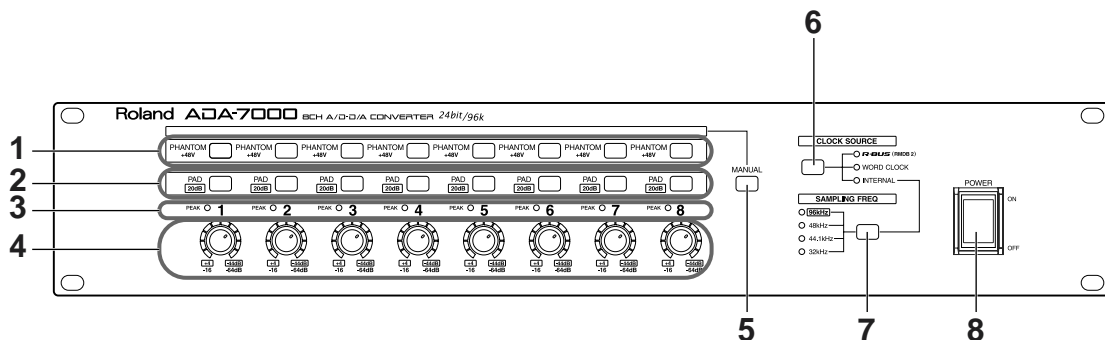

In some cases, it may be possible to make settings on the device connected via R-BUS to disable front panel operations.

1 PHANTOM Buttons 1-8

When connecting the XLR input jack to a device that requires phantom power, turn this on. When phantom power is being supplied, the PHANTOM indicator will light.



Supplying phantom power to a dynamic mic or an audio playback device will cause malfunctions. Carefully read the owner's manual of the device you are using, and **leave this turned off except when connecting a device that requires phantom power (such as a condenser mic).**



When phantom power is turned on/off, high-volume noise may be output, which can damage your amp or speaker system. Be sure to turn down the volume of audio equipment before you turn the phantom power on/off.



Turn phantom power off if nothing is connected to the XLR input jacks. Also, to minimize noise, we recommend that you make the PAD indicator light and turn the INPUT knobs that adjust the input sensitivity all the way to the "+4dBu" position.

2 PAD Buttons 1-8

Switch the input sensitivity (adjustment range of the INPUT knob) for INPUT1-8.

When the PAD indicator is lit: +4 dBu- -44 dBu

When the PAD indicator is dark: -16 dBu- -64 dBu

3 PEAK Indicators 1-8

This will light when the input level of INPUT1-8 is excessive.

The PEAK indicator will light at the level at which the waveform clips (distorts). The ideal level is when the sensitivity is raised as far as possible without causing the PEAK indicator to light. If you wish to make more precise adjustments, watch the level meter of the device connected via the R-BUS connector as you make adjustments.

4 INPUT Sensitivity Knobs 1-8

Adjust the input sensitivity for INPUTs 1-8.

If you rotate the knobs, or push the PAD buttons while the MANUAL indicator is lighted, the value currently indicated by the knob will be put in effect. Previous values will remain in effect for knobs left untouched.

5 MANUAL Button

Selects whether operation of the front panel PHANTOM buttons / PAD buttons / INPUT sensitivity knobs will be enabled or disabled. If you want to enable operation of these buttons/knobs, make the MANUAL indicator light.



If you wish to remotely control the ADA-7000 from a device connected via the R-BUS connector, make the MANUAL indicator go dark.

6 CLOCK SOURCE Button

Selects the source of the sampling clock.



Turn down the volume on all devices connected to the R-BUS (RMDB2) connector, RCA output jacks, and XLR output connectors (on the rear panel) before operating this button.

R-BUS (RMDB2):

The ADA-7000 will operate according to the sampling clock of the device (e.g., digital mixer or digital recorder) connected to the rear panel R-BUS connector. When a clock signal is input from the R-BUS connector, the R-BUS indicator will **light**, and the SAMPLING FREQ indicator for that sampling frequency will light. If no clock is being input from the R-BUS connector, the R-BUS indicator will **blink**. If you have selected “R-BUS (RMDB2)” as the sampling clock of the ADA-7000, you must set the master clock of the connected device to be **other than the R-BUS to which that ADA-7000 is connected**.

WORD CLOCK:

The ADA-7000 will operate according to the word clock signal that is connected to the rear panel WORD CLOCK connector. When a clock is being input from the WORD CLOCK connector, the WORD CLOCK indicator will **light**, and the SAMPLING FREQ indicator for that frequency will light. If no clock is being input from the WORD CLOCK connector, the WORD CLOCK indicator will **blink**. If you have selected “WORD CLOCK” as the sampling clock of the ADA-7000, you must set the master clock of the connected device to be **the R-BUS to which that ADA-7000 is connected**.

INTERNAL:

Select this when you want the ADA-7000 to operate on its own internal clock. Use the SAMPLING FREQ button to set the sampling frequency. If you have selected “INTERNAL” as the sampling clock of the ADA-7000, you must set the master clock of the connected device to be **the R-BUS to which that ADA-7000 is connected**.

7 SAMPLING FREQ Button

If CLOCK SOURCE is set to “INTERNAL,” this selects the sampling frequency at which the ADA-7000 will operate.



The ADA-7000 allows you to select a sampling frequency of **96 kHz**. This is in order to support 96 kHz compatible equipment that will become available in the future. At present (December 1999), no devices with a 96 kHz compatible R-BUS connector are available. For details, please contact your nearest Roland Service Center, authorized Roland distributor, or your dealer.

8 POWER Switch

This turns the power of the ADA-7000 on/off.

Rear Panel

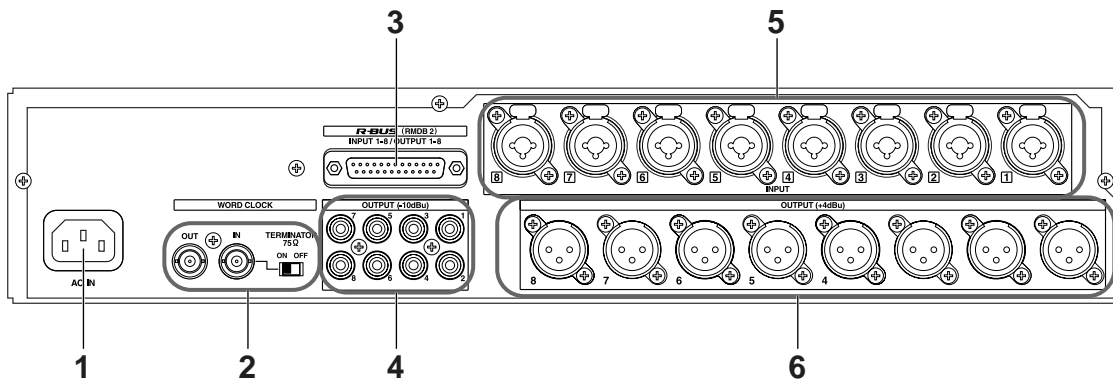

1 AC IN

Connect the included power cable here.



To avoid malfunction, connect only the power supply cord that was supplied with the unit.

2 WORD CLOCK IN/OUT Connectors

IN:

When supplying a sampling clock from an external device to the ADA-7000, input the WORDCLOCK signal here. Use this when you want the reference clock to be another device that outputs a high-precision sampling clock, or when synchronizing to a device that has only a WORDCLOCK OUT.

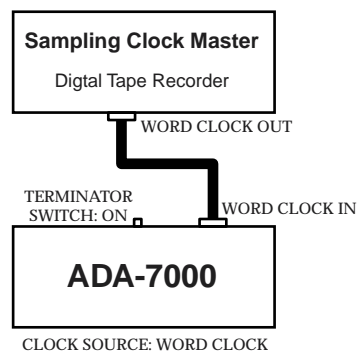

- If you have selected “WORD CLOCK” as the sampling clock of the ADA-7000, you must set the master clock of the connected device to **the R-BUS to which that ADA-7000 is connected.**
- If the master clock of the device connected to the R-BUS connector is the word clock signal, you must select “R-BUS” as the sampling clock of the ADA-7000.

TERMINATOR Switch:

Turn this on if the ADA-7000 is the last device in the word clock signal chain. Normally you will leave this turned on. Turn this off only if you are using a relay connector to distribute the word signal to other devices.

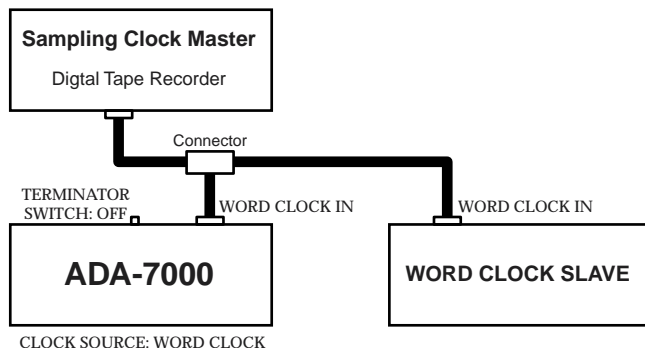

OUT:

This outputs the sampling clock on which the ADA-7000 is operating. Use this when you want another device to synchronize to the sampling clock on which the ADA-7000 is operating.

3 R-BUS (RMDB2) Connector

This is an 8-in/8-out 24 bit digital audio connector. Connect it to another device that has an R-BUS connector (e.g., Roland digital mixer or Roland digital recorder).



Connect the R-BUS (RMDB2) connector only to an R-BUS equipped device. To avoid malfunctions, **never connect it to a SCSI connector, an RS-232C connector, or a parallel connector, even if the connector has the same shape. Use a special R-BUS (RMDB2) cable to make connections.**



RMDB II, RMDB2 and R-BUS are the same standard of Roland corporation.

4 RCA OUTPUT Connectors 1-8 (-10 dBu)

Connect an RCA phono type plug here to output the same analog signal (+4 dBu) as from the XLR output (converted to consumer level).

5 XLR/TRS INPUT Connectors 1-8

Connect either an XLR type or TRS phone plug (not both) here to input an analog signal. Phantom power can be supplied to the XLR input jacks. To turn the phantom power on/off, use the front panel **PHANTOM** buttons.

** Always turn the phantom power off when connecting any device other than condenser microphones that require phantom power. You risk causing damage if you mistakenly supply phantom power to dynamic microphones, audio playback devices, or other devices that don't require such power. Be sure to check the specifications of any microphone you intend to use by referring to the manual that came with it.*

(This instrument's phantom power: 48 V DC, 14 mA/ch Max)

6 XLR OUTPUT Connectors 1-8

Connect an XLR type plug here to output the analog signal (+4 dBu).

An Example of Connection

As an example, we will explain how to connect a Roland **VM-7200** mixing processor.

- * *To prevent malfunction and/or damage to speakers or other devices, always turn down the volume, and turn off the power on all devices before making any connections.*
- * *This instrument is equipped with balanced (XLR) type input jacks. Wiring diagrams for these jacks are shown below. Make connections after first checking the wiring diagrams of other equipment you intend to connect.*

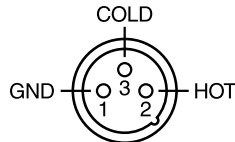

- * *Howling could be produced depending on the location of microphones relative to speakers. This can be remedied by:*
 1. Changing the orientation of the microphone(s).
 2. Relocating microphone(s) at a greater distance from speakers.
 3. Lowering volume levels.

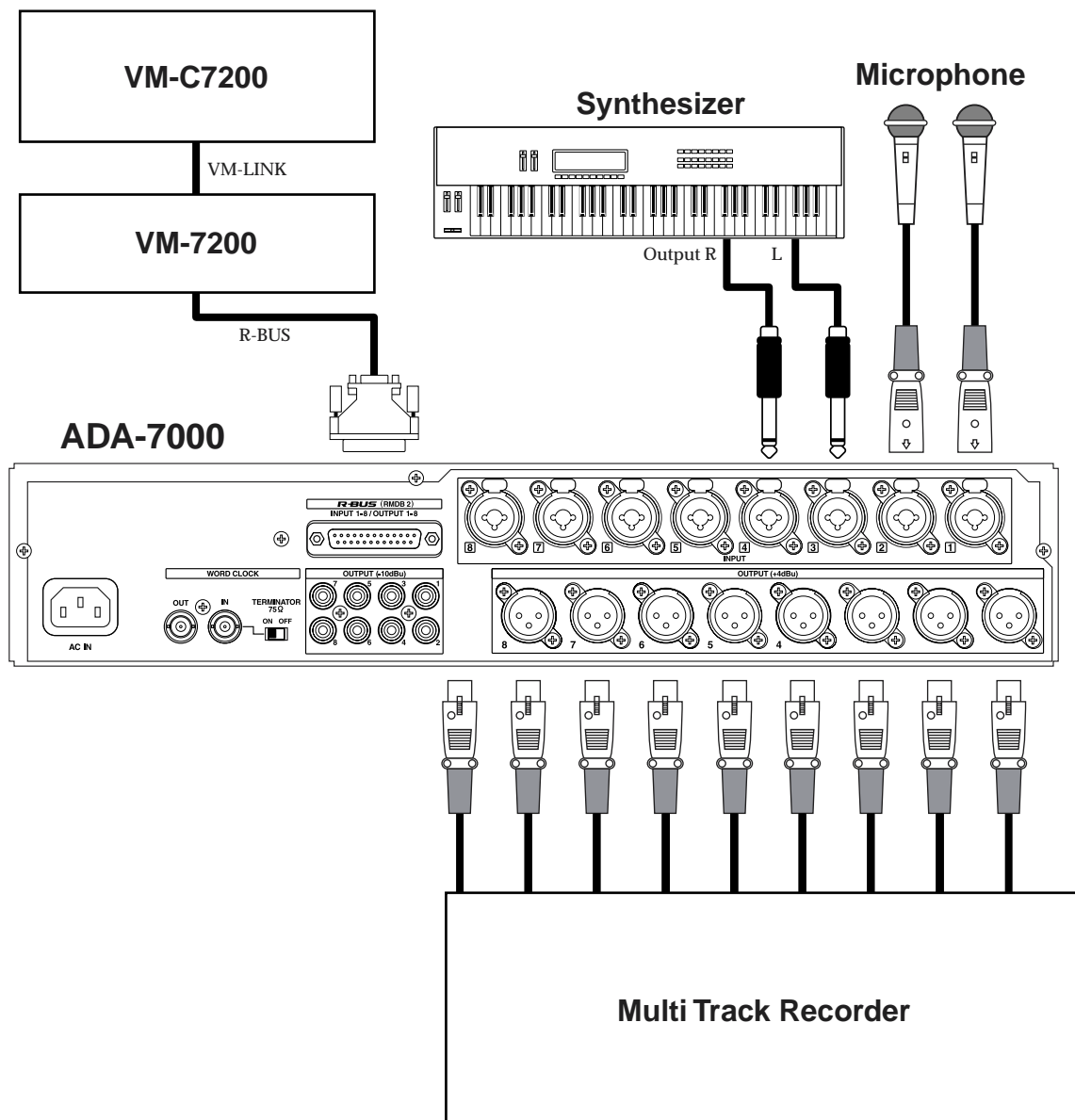

Turning the Power On

** Once the connections have been completed (p. 11), turn on power to your various devices in the order specified. By turning on devices in the wrong order, you risk causing malfunction and/or damage to speakers and other devices.*

** This unit is equipped with a protection circuit. A brief interval (a few seconds) after power up is required before the unit will operate normally.*

- 1. Make sure that the volume of the audio devices have been turned down.**
- 2. Turn on the power of the ADA-7000.**
- 3. Turn on the power of the devices connected to the R-BUS connector.**
- 4. Set the master clock (sampling clock) of the ADA-7000 and of the devices connected to the R-BUS connector of the ADA-7000.**
- 5. Raise the volume of the audio equipments.**

Block Diagram

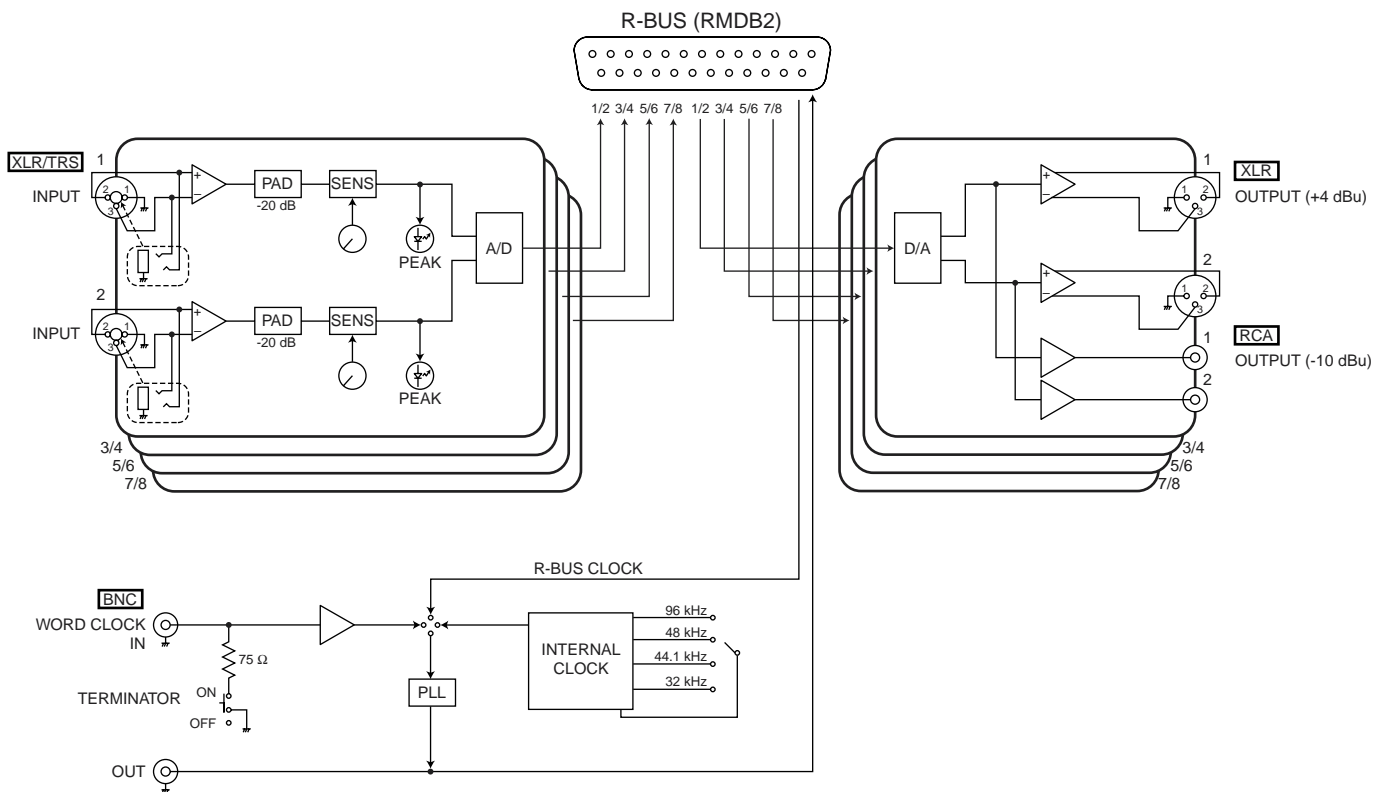

R-BUS (RMDB2) Circuit Connection

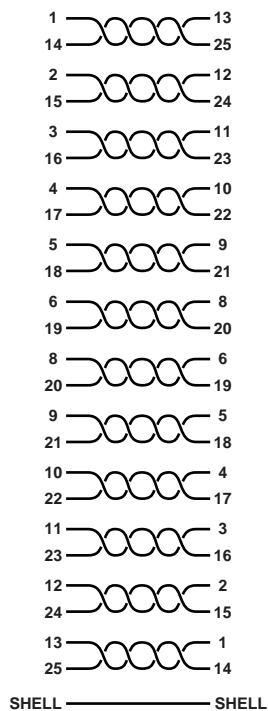

Concerning Copyright

The law prohibits the unauthorized recording, public performance, broadcast, sale, or distribution etc. of a work (CD recording, video recording, broadcast, etc.) whose copyright is owned by a third party.

Roland will take no responsibility for any infringement of copyright that you may commit in using the ADA-7000.

Disclaimer of liability

Roland will take no responsibility for any “direct damages,” “consequential damages,” or “any other damages” which may result from your use of the ADA-7000. These damages may include but are not limited to the following events which can occur when using the ADA-7000.

- Any loss of profit that may occur to you
- Permanent loss of your music or data
- Inability to continue using the ADA-7000 itself or a connected device

About the License Agreement

The ADA-7000 and its CD-R capability are designed to allow you to reproduce material to which you have copyright, or material which the copyright owner has granted you permission to copy. Accordingly, reproduction of music CDs or other copyrighted material without the permission of the copyright owner, other than for your own personal use and enjoyment (private use) constitutes copyright infringement, which may incur penalties. Consult a copyright specialist or special publications for more detailed information on obtaining such permission from copyright holders.

Troubleshooting

If the ADA-7000 does not function correctly, please check the following points before you suspect a malfunction.

If checking these points does not resolve the problem, please contact Roland, a nearby Roland service center, or your dealer.

The CLOCK SOURCE R-BUS (RMDB2) indicator is blinking.

No sampling clock is being input to the R-BUS connector of the ADA-7000. Make the correct master clock settings on the device connected to the R-BUS connector (p. 8).

Alternatively, select a different sampling clock.

The CLOCK SOURCE WORD CLOCK indicator is blinking.

A word clock signal is not being input correctly. Make the correct connections on the device that is supplying the word clock (p. 9). Alternatively, select another sampling clock.

The sound that is input to the ADA-7000 is not output from the device (digital mixer, digital recorder) that is connected to the R-BUS connector of the ADA-7000.

- Has the correct sampling clock (master clock) been selected on the ADA-7000 and on the device connected to the ADA-7000's R-BUS connector?
- Has the volume of the audio device been raised?
- Is the input sensitivity (INPUT knob) too low? (p. 7)

No sound is output from the ADA-7000

- Have you made the correct sampling clock (master clock) settings for the ADA-7000 and for the devices connected to the ADA-7000's R-BUS connector?
- Has the volume of the audio device been raised?

The ADA-7000's buttons and knobs have no effect.

Has the device connected to the R-BUS connector been set to disable the panel operations of the ADA-7000?

The volume level of the instruments connected to OUTPUT connectors is too low.

Could you be using a connection cable that contains a resistor? Use a connection cable that does not contain a resistor.

Supplementary Notes

How to connect the VM-7000 series and the ADA-7000

To connect the VM-7200/7100 and the ADA-7000 via R-BUS, VM-24E I/O Expansion Board (sold separately) is needed. By installing the VM-24E to a VM-7200/7100 processor, you can connect up to three ADA-7000's.

* Refer to VM-7200/7100 Owner's Manual p. 14 "Installing R-BUS (RMDB2) Connectors (VM-24E)."

Connection

Connect the VM-7200/7100 and the ADA-7000 with the R-BUS cable attached in the ADA-7000 box.

* Refer to ADA-7000 Owner's Manual p. 9 "An Example of Connection."

Booting up

Turn the power on the ADA-7000 first, then VM-7200/7100 processor, and finally VM-C7200/C7100 console.

Clock source setting

If clock source has not been set, noise may be generated from the audio output on the ADA-7000 and the VM-7000. While setting the clock source, please turn down the master and monitor level, and turn up again after the setting is finished. Set the sampling clock on the ADA-7000 and the VM-7000 as follows.

Clock Source on the ADA-7000

connected to the R-BUS (1–8): R-BUS

Clock Source on the ADA-7000

connected to the R-BUS (9–16): R-BUS

Clock Source on the ADA-7000

connected to the R-BUS (17–24): R-BUS

Master clock on the VM-7000:

INTERNAL

ADA-7000 setting

Check if the clock source on the ADA-7000 is set to R-BUS. When the ADA-7000 is booted up, the clock source is set to R-BUS. If you connect multiple ADA-7000, set the clock source on all ADA-7000 to R-BUS.

* Refer to ADA-7000 Owner's Manual p. 6 "Clock source."

VM-7000 setting

Set the master clock of the VM-7200/7100 to INTERNAL as follows.

1. Hold down [SHIFT], and press [PROJECT].
2. Press [DOWN] cursor, then [F1 (DIGITAL I/O)].
3. Select "WORD CLOCK SOURCE," and set it to "INTERNAL" with V1 knob, then press [F1 (SET)] to activate the result.

* Refer to VM-C7200/C7100 Owner's Manual p. 32 "Checking the overall system."

* If you set the clock source differently, please refer to the ADA-7000 Owner's Manual p. 6 "Clock source" and the VM-C7200/C7100 Owner's Manual p. 31 "About Digital Connections and the Master Clock."

* VM-7000 is not accommodated with 96.0 kHz sample rate. 96.0 kHz sample rate capability on the ADA-7000 is for the future devices.

* If the system of the VM-C7200/C7100 is version 1.0x, "DIF-AT" is displayed in the R-BUS CONFIG page even though the ADA-7000 is connected. This cause no problem for the operation. With the VM-C7200/C7100 version 1.10 or later, you can set the ADA-7000 with the R-BUS CONFIG page.

If the system software of the VM-C7200/C7100 is version 1.10 or later;

If the system software of the VM-C7200/C7100 is version 1.10 or later, following functions are supported.

Clock source setting

You can set up the ADA-7000's clock source with the VM-C7200/C7100 console.

1. Hold down **[SHIFT]**, and press **[PROJECT]**. SYSTEM menu appears in the display.
2. Select "SYSTEM CONFIG" and go to "R-BUS 1(/2/3)" page.
3. Following page appears in the display.

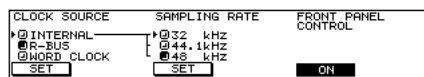
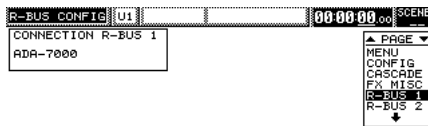

* If the above menu does not appear in the "R-BUS 1(/2/3)" page of "SYSTEM CONFIG" menu, please turn off the power of whole system, check the R-BUS connection and turn on again.

4. Select a desired source with **[V1 (CLOCK SOURCE)]** knob.
5. Press **[F1 (SET)]** and the clock source you selected is activated.
6. If you select "INTERNAL" for the clock source, set the sampling rate with **[V3 (SAMPLING RATE)]** knob.
7. Press **[F3 (SET)]** and the sampling rate you selected is activated.

FRONT PANEL CONTROL

In the R-BUS 1(/2/3) page, you can prohibit the ADA-7000's panel operation.

1. Hold down **[SHIFT]**, and press **[PROJECT]**. SYSTEM menu appears in the display.
2. Select "SYSTEM CONFIG" and go to "R-BUS 1(/2/3)" page.
3. Press **[F5 (FRONT PANEL CONTROL)]**.
 Highlight ON: Panel control enabled
 Normal ON: Panel control invalid

Remote control of the gain and phantom power

You can control the gain setting and phantom power on/off with the VM-C7200/C7100 console.

1. Press **[MULTI IN 1-24]** in the "SECTION" block.
 2. Press **[PREAMP GAIN]** in the "PARAM VIEW on Fader" block.
 3. Control the gain and phantom power on/off in the same manner as for the **[INPUT]**.
- * PAD on the ADA-7000 is automatically switched on/off according to the gain setting.

How to connect the VM-3100Pro and the ADA-7000

Connection

Connect the VM-3100Pro and the ADA-7000 with the R-BUS cable attached in the ADA-7000 box.

Booting up

Turn the power on the ADA-7000 first, then VM-3100Pro.

Sampling clock setting

If clock source has not been set, noise may be generated from the audio output on the ADA-7000 and the VM-3100Pro. While setting the clock source, please turn down the master and monitor level, and turn up again after the setting is finished. Set the sampling clock of the ADA-7000 and the VM-3100Pro as follows.

Clock Source on the ADA-7000: R-BUS
Master clock on the VM-3100Pro: INTERNAL

ADA-7000 setting

Check if the clock source on the ADA-7000 is set to R-BUS. When the ADA-7000 is booted up, the clock source is set to R-BUS.

* Refer to ADA-7000 Owner's Manual p. 6 "Clock source."

VM-3100Pro setting

Set the master clock of the VM-3100Pro to INTERNAL as follows.

1. Hold down [SHIFT], and press [DIGITAL IN].
2. Press [F1 (→INT)].

* Sample rate of the VM-3100Pro is fixed to 44.1kHz. If you use the VM-3100Pro and the ADA-7000 in combination, the ADA-7000 works in 44.1kHz sample rate.

* If you set the clock source differently, please refer to the ADA-7000 Owner's Manual p. 6 "Clock source" and the VM-3100Pro Owner's Manual p. 52 "Inputting signals from digital devices."

How to connect the VSR-880 and the ADA-7000

Connection

Connect the VSR-880 and the ADA-7000 with the R-BUS cable attached in the ADA-7000 box.

Booting up

Turn the power on the ADA-7000 first, then VSR-880.

Sampling clock setting

Set the sampling clock of the ADA-7000 and the VSR-880 as follows. If clock source has not been set, noise may be generated from the audio output on the ADA-7000 and the VSR-880. While setting the clock source, please turn down the master and monitor level, and turn up again after the setting is finished.

Clock Source on the ADA-7000: R-BUS
Master clock on the VSR-880: INTERNAL

ADA-7000 setting

Check if the clock source on the ADA-7000 is set to R-BUS. When the ADA-7000 is booted up, the clock source is set to R-BUS.

* Refer to ADA-7000 Owner's Manual p. 6 "Clock source."

VSR-880 setting

Set the master clock of the VSR-880 to INTERNAL as follows.

1. Press [SYSTEM] while holding [SHIFT]. "SYS System PRM?" appears in the display.
2. Press [ENT/YES].
3. Select SYS MasterClk= INT with TIME/VALUE dial, then press [ENT/YES].

* Refer to VSR-880 Owner's Manual p. 108 "Select the Master Clock."

* If you set the clock source differently, please refer to the

ADA-7000 Owner's Manual p. 6 "Clock source" and the VSR-880 Owner's Manual p. 108 "Select the Master Clock."

Note

* DIF-AT Interface Box cannot be used even if connected to the ADA-7000 via R-BUS.

Specifications

8-channel AD/DA Converter ADA-7000

Signal Processing

AD Conversion: 24 bits, 64 times oversampling
DA Conversion: 24 bits, 128 times oversampling

Sample Rate

96.0 kHz, 48.0 kHz, 44.1 kHz, 32 kHz

Frequency Response

Sample Rate

96.0 kHz: 6 Hz–44 kHz

48.0 kHz: 6 Hz–22 kHz

44.1 kHz: 6 Hz–20 kHz

32.0 kHz: 6 Hz–14 kHz

Nominal Input Level

Input 1–8: -64–+4 dBu

Input Impedance

Input 1–8 (XLR type): 10 k Ω

Input 1–8 (1/4 inch phone type): 10 k Ω

Nominal Output Level

Output 1–8: +4 dBu (XLR type)

Output 1–8: -10 dBu (RCA phono type)

Output Impedance

Output 1–8 (XLR type): 600 Ω

Output 1–8 (RCA phono type): 300 Ω

Recommended Load Impedance

Output 1–8 (XLR type): 10 k Ω or greater

Output 1–8 (RCA phono type): 10 k Ω or greater

Connectors and Jacks

Input 1–8 (XLR type, balanced, phantom power)

Input 1–8 (1/4 inch phone type, TRS balanced)

Output 1–8 (XLR type, balanced)

Output 1–8 (RCA phono type)

R-BUS (RMDB2) Connector (DB-25 type)

Word Clock In (BNC type, with terminator switch)

Word Clock Out (BNC type)

AC Inlet

Power Supply

AC 117 V, AC 230 V or AC 240 V

Power Consumption

19 W

Dimensions

482.0 (W) x 293.0 (D) x 88.9 (H) mm

19 (W) x 11-9/16 (D) x 3-1/2 (H) inches

Weight

5.1 kg

11 lbs 4 oz

Accessories

R-BUS cable (1 m)

AC Cord

Owner's Manual

Options

V-Mixing Station: VM-3100Pro

V-Mixing Console: VM-C7200, VM-C7100

V-Mixing Processor: VM-7200, VM-7100

24-bit Digital Studio Recorder: VSR-880

(0 dBu = 0.775 V rms)

** In the interest of product improvement, the specifications and/or appearance of this unit are subject to change without prior notice.*



This product complies with the requirements of European Directives EMC 89/336/EEC and LVD 73/23/EEC.

For EU Countries

FEDERAL COMMUNICATIONS COMMISSION RADIO FREQUENCY INTERFERENCE STATEMENT

This equipment has been tested and found to comply with the limits for a Class B digital device, pursuant to Part 15 of the FCC Rules. These limits are designed to provide reasonable protection against harmful interference in a residential installation. This equipment generates, uses, and can radiate radio frequency energy and, if not installed and used in accordance with the instructions, may cause harmful interference to radio communications. However, there is no guarantee that interference will not occur in a particular installation. If this equipment does cause harmful interference to radio or television reception, which can be determined by turning the equipment off and on, the user is encouraged to try to correct the interference by one or more of the following measures:

- Reorient or relocate the receiving antenna.
- Increase the separation between the equipment and receiver.
- Connect the equipment into an outlet on a circuit different from that to which the receiver is connected.
- Consult the dealer or an experienced radio/TV technician for help.

This device complies with Part 15 of the FCC Rules. Operation is subject to the following two conditions:

- (1) This device may not cause harmful interference, and
- (2) This device must accept any interference received, including interference that may cause undesired operation.

Unauthorized changes or modification to this system can void the users authority to operate this equipment. This equipment requires shielded interface cables in order to meet FCC class B Limit.

For the USA

NOTICE

This Class B digital apparatus meets all requirements of the Canadian Interference-Causing Equipment Regulations.

AVIS

Cet appareil numérique de la classe B respecte toutes les exigences du Règlement sur le matériel brouilleur du Canada.

For Canada

