

 Roland®

**A-80**

Owner's Manual

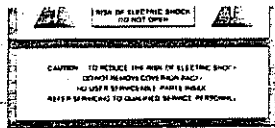

insulated dangerous voltage within the product's enclosure that may be of sufficient magnitude to constitute a risk of electric shock to persons.

The exclamation point within an equilateral triangle is intended to alert the user to the presence of important operating and maintenance (servicing) instructions in the literature accompanying the product.

INSTRUCTIONS PERTAINING TO A RISK OF FIRE, ELECTRIC SHOCK OR INJURY TO PERSONS.

# IMPORTANT SAFETY INSTRUCTIONS

**WARNING** When using electric products, basic precautions should always be followed, including the following:

1. Read all the instructions before using the product.
2. Do not use this product near water—for example, near a bathtub, washbowl, kitchen sink, in a wet basement, or near a swimming pool, or the like.
3. This product should be used only with a cart or stand that is recommended by the manufacturer.
4. This product, either alone or in combination with an amplifier and headphones or speakers, may be capable of producing sound levels that could cause permanent hearing loss. Do not operate for a long period of time at a high volume level or at level that is uncomfortable. If you experience any hearing loss or ringing in the ears, you should consult an audiologist.
5. The product should be located so that its location or position does not interfere with its proper ventilation.
6. The product should be located away from heat sources such as radiators, heat registers or other products that produce heat.
7. The product should avoid using in where it may be affected by dust.
8. The product should be connected to a power supply only of the type described in the operating instructions or as marked on the product.
9. Changing the voltage selector may require the use of a different line cord or attachment plug, or both. To reduce the risk of fire or electric shock, refer servicing to qualified service personnel.
10. The power-supply cord of the product should be unplugged from the outlet when left unused for a long period of time.
11. Do not tread on the power-supply cord.
12. Do not pull the cord but hold the plug when unplugging.
13. When setting up with any other instruments, the procedure should be followed in accordance with instruction manual.
14. Care should be taken so that objects do not fall and liquids are not spilled into the enclosure through openings.
15. The product should be serviced by qualified service personnel when:
  - A: The power-supply cord or the plug has been damaged; or
  - B: Objects have fallen, or liquid has been spilled into the product; or
  - C: The product has been exposed to rain; or
  - D: The product does not appear to operate normally or exhibits a marked change in performance; or
  - E: The product has been dropped, or the enclosure damaged.
16. Do not attempt to service the product beyond that described in the user-maintenance instructions. All other servicing should be referred to qualified service personnel.

## GROUNDING INSTRUCTION

This product must be grounded. If it should malfunction or breakdown, grounding provides a path of least resistance for electric shock. This product is equipped with a cord having an equipment-grounding plug. The plug must be plugged into an appropriate outlet that is properly installed and grounded in accordance with all local codes and ordinances.

**DANGER** — Improper connection of the equipment-grounding conductor can result in a risk of electric shock. Check with a qualified electrician or serviceman if you are in doubt as to whether the product is properly grounded. Do not modify the plug provided with the product — if it will not fit the outlet, have a proper outlet installed by a qualified electrician.

## SAVE THESE INSTRUCTIONS

Lithiumbatteri. Explosionsfare.  
Udskiftning må kun foretages af en sagkyndig, og som beskrevet i servicemanual.

### WARNING !

Lithiumbatteri. Explosionsrisk.  
Får endast bytas av behörig servicetekniker.  
Se instruktioner i servicemanualen.

### ADVARSEL !

Lithiumbatteri. Fare for eksplosion.  
Må bare skiftes af kvalificeret tekniker som beskrevet i servicemanualen.

### VAROITUS!

Lithiumparisto. Räjähdyksvaara.  
Pariston saa vaihtaa ainoastaan laian ammattimies.

### WARNING

THIS APPARATUS MUST BE EARTH GROUNDED.

The three conductors of the mains lead attached to this apparatus are identified with color as shown in the table below, together with the matching terminal on the UK type power plug. When connecting the mains lead to a plug, be sure to connect each conductor to the correct terminal, as indicated.

"This instruction applies to the product for United Kingdom."

MAINS LEADS		PLUG
Conductor	Color	Mark on the matching terminal
Live	Brown	Red or letter L
Neutral	Blue	Black or letter N
Grounding	Green-Yellow	Green, Green-Yellow, letter E or symbol

#### Bescheinigung des Herstellers / Importeurs

Hiermit wird bescheinigt, daß der/die/das

**MIDI KEYBOARD CONTROLLER A-20**

(Gerät, Typ, Bezeichnung)

in Übereinstimmung mit den Bestimmungen der  
Amtsbl. Vfg. 1046 / 1984

(Anzahl der Geräte)

funktionstauglich ist.

Der Deutsche Bundespost wurde das Inverkehrbringen dieses Gerätes angezeigt und die Berechtigung zur Überprüfung der Serie auf Einhaltung der Bestimmungen eingeräumt.

Roland Corporation Osaka / Japan

Name des Hersteller/Importeurs

#### RADIO AND TELEVISION INTERFERENCE

\*Warning — This equipment has been verified to comply with the limits for a Class B computing device pursuant to Subpart J of Part 15 of FCC rules. Operation with non-certified or non-verified equipment is likely to result in interference to radio and TV reception.

The equipment discussed in the manual generates and uses radio-frequency energy. If it is not installed and used properly, it may, in strict accordance with our instructions, cause interference with radio and television reception.

This equipment has been tested and found to comply with the limits for a Class B computing device in accordance with the specifications in Subpart J of Part 15 of FCC Rules. These limits are designed to provide reasonable protection against such interference in a residential installation. However, there is no guarantee that interference will not occur in a particular installation. If this equipment does cause interference to radio or television reception, which can be determined by turning the equipment on and off, the user is encouraged to try to correct the interference by the following measure:

- Disconnect other devices and their power/cable lines one at a time. If the interference stops, it is caused by either the other device or its I/O cable.
- These devices usually require Roland designated shielded I/O cables. For Roland devices, you can obtain the correct shielded cable from your dealer. For non-Roland devices, contact the manufacturer or dealer for assistance.

If your equipment does cause interference to radio or television reception, you can try to correct the interference by using one or more of the following measures:

- Turn the TV or radio antenna until the interference stops.
- Move the equipment to one side or the other of the TV or radio.
- Move the equipment farther away from the TV or radio.
- Plug the equipment into an outlet that is on a different circuit than the TV or radio. (That is, make certain the equipment and the radio or television set are on circuits controlled by different circuit breakers or fuses.)

• Consider installing a radio/television antenna with coaxial cable lead-in between the antenna and TV.

If necessary, you should consult your dealer or an experienced radio/television technician for additional suggestions. You may find helpful the following booklet prepared by the Federal Communications Commission:

"How to Identify and Resolve Radio-TV Interference Problems"

This booklet is available from the U.S. Government Printing Office, Washington, D.C. 20402. Stock No. 004-000-0034-4

Please read the separate volume "MIDI" before reading this owner's manual

Copyright © 1989 by ROLAND CORPORATION

All rights reserved. No part of this publication may be reproduced in

Thank you for purchasing the Roland MIDI Controller A-80.

The A-80 can control the connected MIDI devices, e.g. a sound module, effect unit, sequencer, remote keyboard, as "a system", allowing you to program various combinations of those devices for live performance.

To make the best use of the A-80, read this manual carefully.

The A-80 can transmit various MIDI messages, but these messages may not function properly if the receiver unit cannot receive them. Read the owner's manual of the receiver unit and the separate booklet "Guide Book for MIDI" together with this manual.

For Canada

**CLASS B**

**NOTICE**

This digital apparatus does not exceed the Class B limits for radio noise emissions set out in the Radio Interference Regulations of the Canadian Department of Communications.

**CLASSE B**

**AVIS**

Cet appareil numérique ne dépasse pas les limites de la classe B au niveau des émissions de bruits radioélectriques fixés dans le Règlement des signaux parasites par le ministère canadien des Communications.

## ■ IMPORTANT NOTES

### ◇Power Supply◇

- The appropriate power supply for this unit is shown on its name plate. Please make sure that the line voltage in your country meets the requirement.
- Do not use the same socket used for any noise generating device (such as a motor or variable lighting system.)
- Make sure that the unit is turned off before connecting the power plug to the AC socket.
- Please be sure to connect the power cord to the AC socket on this unit before connecting the power plug to the wall socket.
- When disconnecting the power plug from the socket, do not pull the cord but hold the plug to avoid damaging the cord.
- Avoid damaging the power cord.
- If the unit is not to be used for a long period of time, unplug the cord from the socket.
- It is normal for this unit to become hot while being operated.
- Check with your local Roland dealer if you wish to use this unit in another country.
- Disconnect the AC cord immediately in the event of an electrical storm.
- Before setting up this unit with other MIDI devices, turn this unit along with all other units off.
- Be sure to connect the MIDI cables securely.
- If the MIDI cable is disconnected while the keyboard is being played, various troubles will occur (e.g. the note may continue to sound).
- This unit may not operate correctly if turned on immediately after being turned off. If this happens, simply turn it off a few seconds later, turn it on again.
- To avoid the risk of electric shock, do not perform any servicing, refer all servicing to qualified service personnel.

### ◇ Room Location ◇

- Avoid using this device in excessive heat or humidity conditions, or where it may be affected by direct sunlight or dust and avoid places subject to high vibration.
- Operating the unit near a neon light, fluorescent lamp, TV or CRT Display, may cause noise interference. If so, change the angle or the position of the unit.
- Operating this unit near a TV or radio may cause picture or noise interference. If this happens, move the unit away from these instruments.
- Do not place or drop anything heavy on the main unit or its power cord.

### ◇ Cleaning Care ◇

- Use a soft dry cloth for dusting. To remove fingerprints or dulling film, use a soft cloth slightly dampened with water and a little mild detergent. Immediately wipe dry with a soft cloth. Do not use solvents, such as paint thinners.

### ◇ Memory Back Up System ◇

- This unit features a memory back-up system that retains the data even after switched off. The battery that supports the back-up circuit should be replaced every five years. Call the Roland service station for a battery replacement.

**\* The first replacement may be required before five years, depending on how much time had passed before you purchased the unit.)**

- Although we do our utmost to protect your data during repairs, sometimes, especially when working on the memory itself or on a related area, some of your important data may be lost. Keep a separate record of all the data that you consider important. This can be done by saving it into the Memory Card (M-256D,E) or by writing it down on a sheet of paper.

### ◇ Others ◇

- Adjust the volume control to a level that will not disturb the neighborhood, especially at night when sounds can travel over a long distance.
- Do not allow fluid or foreign matter, such as water, beverages, coins, sand, wires, to enter the A-80.
- Do not examine or modify the internal components or circuitry. Electrical shocks or damage may result.
- Do not subject this unit to strong shocks, or move it while the power is on.
- If this unit fails to operate correctly, turn it off immediately and contact your local Roland dealer.
- Never push or hit the display.

# PANEL DESCRIPTION

## Rear Panel

**WARNING:**  
Do not remove the cover of the selector switch (for voltage change) on the rear of the unit. If you remove the cover and change the position of the switch, electric shock or fire will occur. To change the position for voltage change, call your local Roland service station.

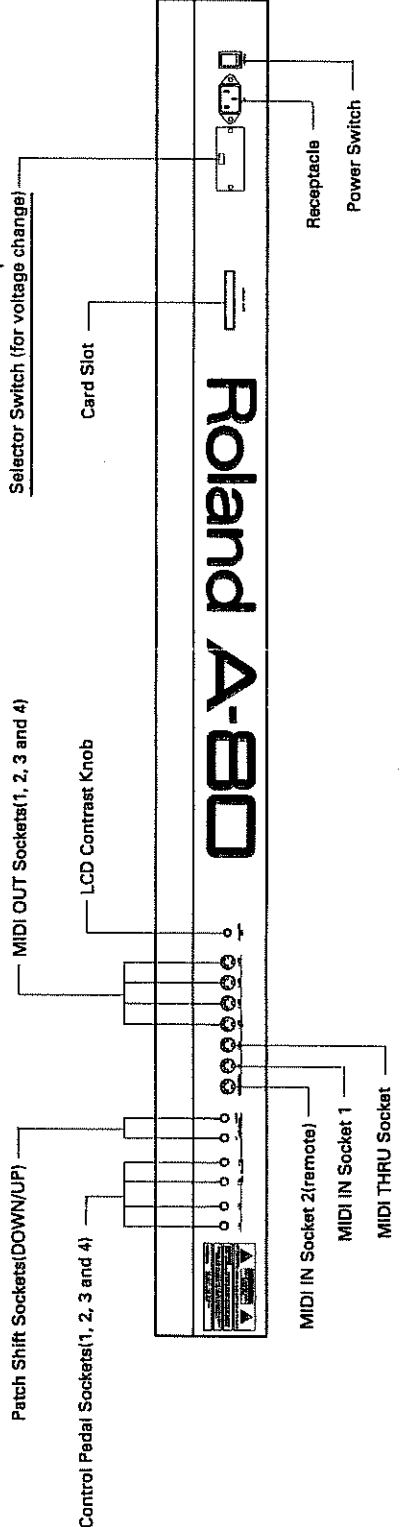

## Front Panel

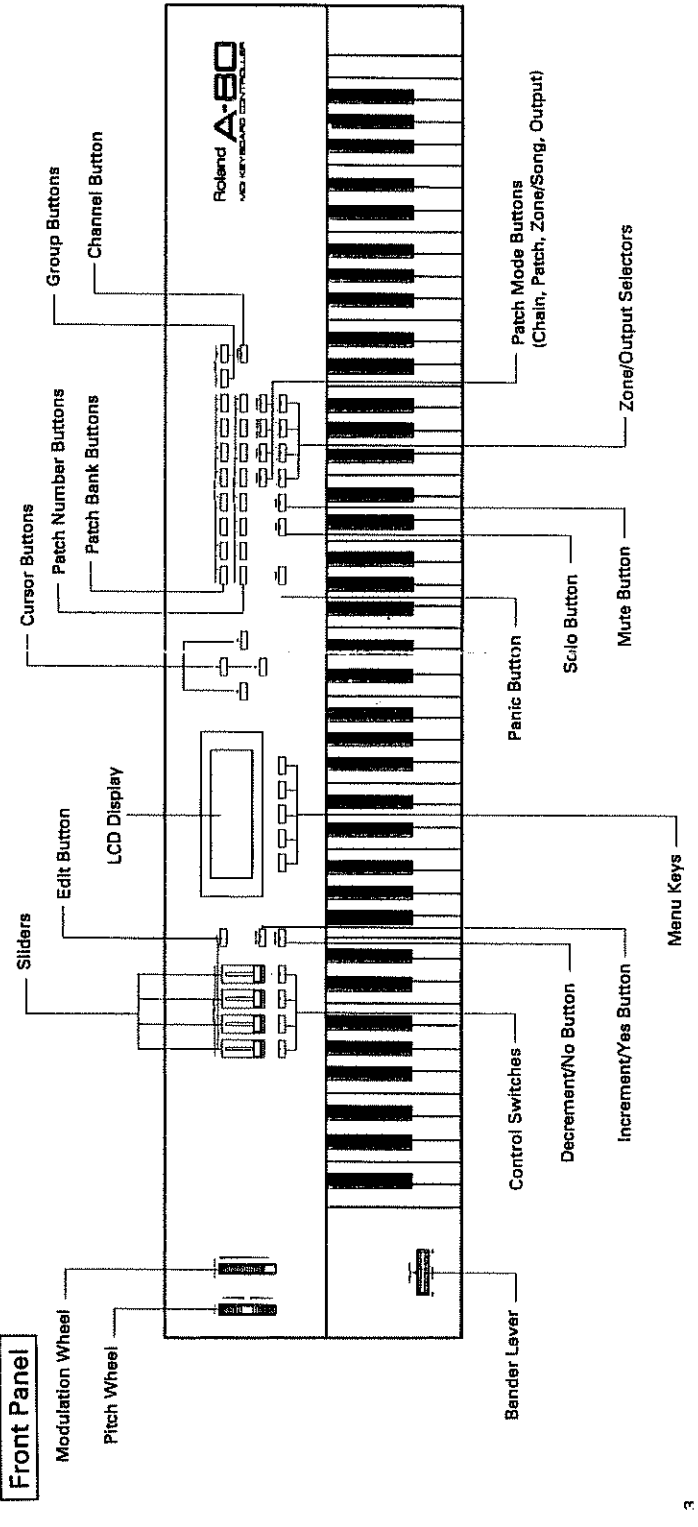



# CONNECTIONS

Socket Layout on the rear of the unit

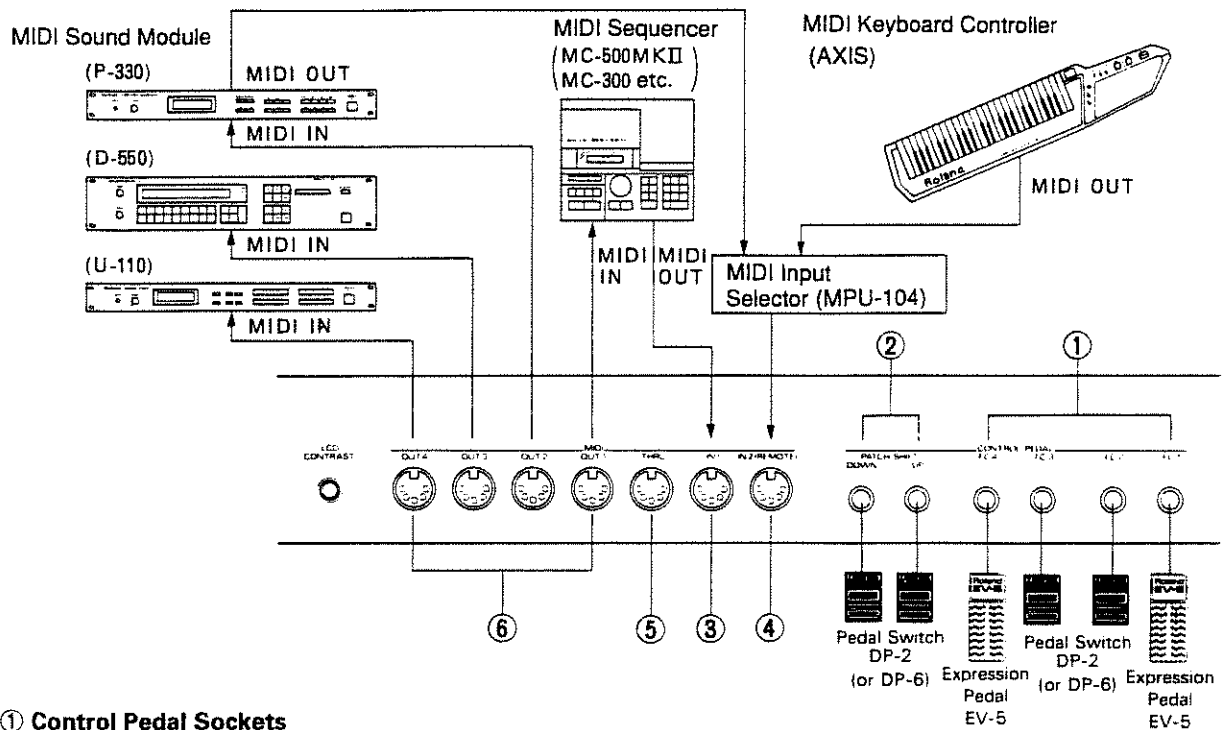

## ① Control Pedal Sockets

The 4 control pedal sockets may be connected to either DP-2 foot switches or EV-5 foot volume pedals (optional). Any combination of foot switches and volume pedals may be used. A different function can be assigned to each socket and controlled using the pedals or switches.

## ② Patch Shift Sockets (DOWN/UP)

These may be connected to DP-2 optional foot switches. They may be used to step Patches or anything controlled by the UP/DOWN cursor keys.

## ③ MIDI IN 1

The MIDI IN 1 may be connected to a sequencer such as an MC-500. An exact copy of the MIDI IN 1 is output at the MIDI THRU or MIDI OUT.

## ④ MIDI IN 2 (Remote)

MIDI IN 2 (REMOTE) MIDI IN may be connected to an external keyboard such as the AXIS-1. The MIDI messages sent to the Remote MIDI socket are always received in OMNI ON mode (that receives all the MIDI channel messages), therefore the messages of the MIDI channel currently set and the real-time messages from the keyboard are ignored.

## ⑤ MIDI THRU

The exact copy of the signal fed into the MIDI IN 1 is sent out through this connector.

## ⑥ MIDI OUTS (1, 2, 3 and 4)

These sockets are connected to the MIDI Inputs of the user sound module and/or sequencer, etc.

# ■ The purpose of this manual

## The structure of this manual

This owner's manual consists of the following four sections:

### Outline of the A-80

This explains about the basic structure and functions of the A-80. You can roughly grasp the overall functions and the control buttons of the A-80 before going into each operation.

### Performance Course

This section explains about the main procedures in the Playing mode. In each item, an example is shown for you to experiment.

### Editing Course

You can write various functions or programs in the A-80 and call any of them later by the flick of a button. In the Advanced Course, such functions and programs (in the Editing mode) are explained respectively.

### Reference

- Troubleshooting..... This explains how to resolve various troubles of the A-80, such as no sound is produced.
- Appendix Tables..... Various Charts are provided to use the A-80 effectively.
- Functional Index ..... This helps you find the relevant page.

## Indication for Buttons/Keys

- Indication such as **EDIT** or **PATCH** means a button or key on the front panel of the unit.



- Reversed indication such as **Patch** or **Edit** means a menu key for menu selection on the display.

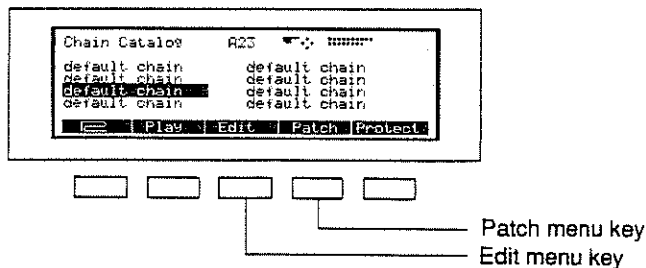



# ■ CONTENTS

Important Notes .....	1
Panel Description .....	3
Connections .....	5
The purpose of this manual .....	6

## Outline of the A-80

<b>[1]Features</b> .....	10
--------------------------	----

<b>[2]Basic Concept of the A-80</b> .....	11
---	----

a. Definition of ZONE .....	12
b. Definition of PATCH .....	12
c. Definition of CHAIN .....	12
d. The A-80's buttons, keys and sliders .....	13
e. Performance Functions .....	16
f. Memory Capability .....	18

<b>[3]Menu Map and interconnection system</b> .....	19
---	----

a. Roland Menu .....	20
b. View .....	20
c. Patch Catalog .....	20
d. Chain Catalog .....	20
e. Utilities .....	20

## Performance Course

<b>[1]Performance Play</b> .....	22
----------------------------------	----

1.Power-up .....	22
2.PATCH selection .....	23
3.CHAIN Selection .....	24
4.Send PROGRAM CHANGE .....	25
5.Send PROGRAM CHANGE on a ZONE .....	27
6.ZONE SOLO/MUTE .....	28
7.OUTPUT socket SOLO/MUTE .....	29

8.Send SONG select .....	30
9.ALL NOTE OFF(PANIC button) .....	31

## Editing Course

<b>[1]EDITING</b> .....	34
-------------------------	----

1.Memory Protect ON/OFF .....	34
2.Edit ON/OFF .....	35
3.Undo .....	35
4.Copy .....	36
a. Procedure to Copy a Patch .....	36
b. Procedure to Copy a Chain .....	37

<b>[2]PATCHES</b> .....	38
-------------------------	----

1.Patch Catalog .....	38
2.View .....	38
a. Patch Name .....	39
b. System Exclusive .....	40
c. Effect Device Program Changes .....	42
3.Zone .....	45
a. Selecting Zones .....	45
b. Zone position .....	46
c. MIDI Channel .....	48
d. Transpose .....	49
e. Velocity Curve .....	50
f. Aftertouch Curve .....	53
g. Extra Menu .....	56
h. Zone Program Change .....	56
i. Zone Volume .....	58
j. Zone Modulation .....	59
k. Pitch Bend On/Off .....	60
l. Switch Controller Definition .....	61
m. Slider Controller Definition .....	62
n. Foot Controller Definition .....	63
4.Channel .....	64
a. MIDI Channel Catalog .....	64
b. Editing the Channel Name .....	65

**[3]CHAINS .....66**

- 1.Chain Catalog .....66
  - a. Edit CHAIN Name/Comment .....67
  - b. Edit Chain Links .....68
- 2. Play Chain .....69

**[4] EDIT MIDI OPTIONS .....70**

- 1. Program Change Receive
  - Channel ON/OFF .....70
- 2. Active Sensing ON/OFF .....71
- 3. ALL Notes Off ON/OFF .....71
- 4. Exclusive Receive ON/OFF .....72

**[5]UTILITIES .....73**

- 1. LOAD .....73
  - a. Loading A-80 memory
    - from RAM CARD .....73
- 2. SAVE .....74
  - a. Saving A-80 memory
    - to RAM CARD .....74
  - b. Editing RAM Card Name .....75
- 3.Data Transfer via MIDI .....76
  - a. Data Transfer to a MIDI
    - sequencer. (Bulk Dump) .....76
  - b. Data Transfer from a MIDI
    - sequencer. (Bulk Load) .....77

**[6]Default Settings .....78**

**Reference**

**[1]Troubleshooting.....80**

**[2]Appendix Tables.....81**

- Roland Exclusive Messages .....85
- MIDI Implementation .....89
- MIDI Implementation Chart .....95
- Specifications.....96
- INDEX .....97

# Outline of the A-80

[1] Features .....	10
[2] Basic Concept of the A-80 .....	11
[3] Menu Map and Interconnection System .....	19

# [1] Features

The A-80 controls up to 4 MIDI sound sources and MIDI effect devices at the same time from the A-80's own keyboard and assignable keyboard controllers.

- **Patch and Chain**                      A Patch is a memorized keyboard setup, and the A-80 can store up to 64 different Patches. A Chain is up to 32 Patches linked together, and up to 32 different Chains can be stored.
  
- **A-80's exclusive data**                Data in the A-80's memory can be stored on an optional memory card or via MIDI Exclusive in an external sequencer, and is compatible with the A-50.
  
- **Zone**                                      A zone is an area defined on the A-80's keyboard. There are 4 zones on the A-80's keyboard. (Any zone can overlap any other zone's key range.) Each zone may have different settings for independent remote control over an external MIDI device.
  
- **Keyboard**                                The 88 note keyboard is sensitive to the pressure of individual keys (Velocity, and Polyphonic Aftertouch).
  
- **MIDI Outputs**                         4 MIDI outputs may be muted during performance without fear of hanging notes.
  
- **MIDI Inputs**                            Two MIDI Inputs; MIDI IN 1 and MIDI IN 2 (REMOTE), are provided.
  
- **Sequencer control**                    The A-80 can mix the MIDI data of the A-80 with the performance data from a sequencer and sends it from any MIDI output sockets. Also, the Song Select, Start/Stop from a sequencer (or rhythm machine) can be controlled from its front panel buttons.
  
- **Pitch Bend/Modulation control**    For the control of Pitch Bend/Modulation, both lever and wheel type are provided.
  
- **Controllers**                            The A-80 features three types of controllers which may be assigned to any MIDI control messages; 4 slider type controllers and button type controllers on the front panel, and 4 foot controllers (control pedal sockets) on the rear panel. Controller assignment will create subtle nuance during live performance.
  
- **LCD display**                            A large LCD display (back-lit) is easy to view. You may make the display show graphic display of parameters for quicker and more accurate editing.
  
- **The Roland menu key**                The  menu key allows you to return to the Roland Menu (initial display) from any editing display, so that you can quickly access the menu you want.
  
- **Panic button**                            The Panic button will resolve hanging notes during performance.

## [2] Basic Concept of the A-80

The A-80 is organized as in the following figure.

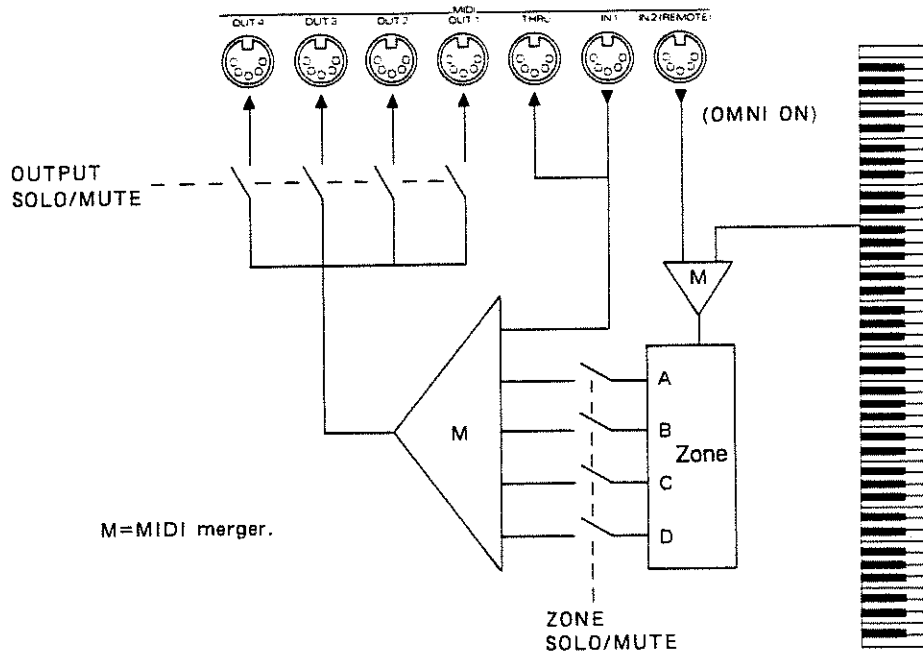

The data from the MIDI IN 2 is merged with the output of the A-80's keyboard. These notes and control changes are then assigned to MIDI channels depending on the current zone definitions. i.e. They are "zoned".

- \* The MIDI messages sent to the MIDI IN 2 (Remote) are always received in OMNI ON mode (that receives all the MIDI channel messages), the original MIDI channel and the real-time messages from the connected keyboard are ignored.
- \* Aftertouch, velocity and controller assignment, etc can be independently set as well as the MIDI channel for each zone.
- \* Each output (A, B, C or D) in a zone can be muted during performance (Zone Solo/Mute function).

The zoned data is then merged with that from MIDI IN 1.

- \* An exact copy of MIDI messages input to MIDI IN 1 is output through MIDI THRU or MIDI OUT.

The merged data is then sent through the 4 MIDI output sockets.

- \* Each output socket sends the same MIDI data.
- \* Each MIDI output can be muted (Output Solo/Mute function).

## a. Definition of ZONE

A zone is an area defined on the A-80's keyboard. There are four zones on the A-80's keyboard. Any zones can overlap any other zone's key range as shown below in fig A, B and C. Each zone has a different MIDI channel, and may have different Velocity curve, Aftertouch curve and Controller definitions, which allows a high level ensemble performance. Each zone also contains a Program Change number, Volume message and Modulation message that is output when the zone becomes active. The Pitch Bender and Wheels may be turned off independently for each zone. Zones may be muted in the same manner as a channel on an audio mixer may be muted.

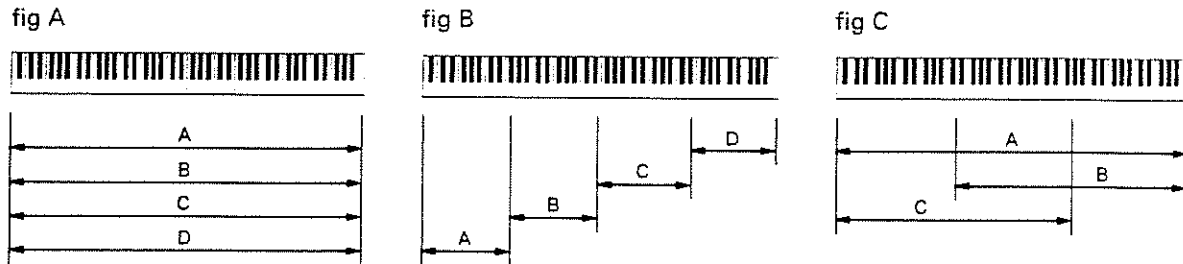

## b. Definition of PATCH

A Patch is a memorized keyboard setup that contains 4 ZONES. It also contains the mute state of the MIDI output sockets and up to 4 effector program changes. The A-80 can store up to 64 different Patches. When a patch is selected, the setup information contained within its 4 ZONES (the program changes, volume and modulation messages) is output, and the keyboard is "zoned" as programmed. It may also, optionally contain system exclusive that will be dumped (to a sound module, etc) when the patch is selected.

\*See the Outline of the A-80's Patch provided.

## c. Definition of CHAIN

A Chain is up to 32 Patches linked together, in any order, to allow simplified use of complicated setups in a performance. There are 32 Chains.

e.g.

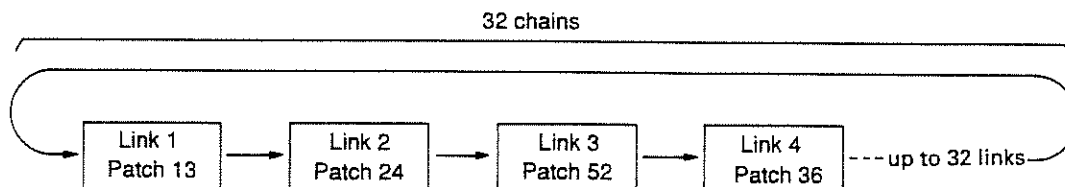

## d. The A-80's buttons, keys and sliders

### Buttons related with the Patch Select buttons

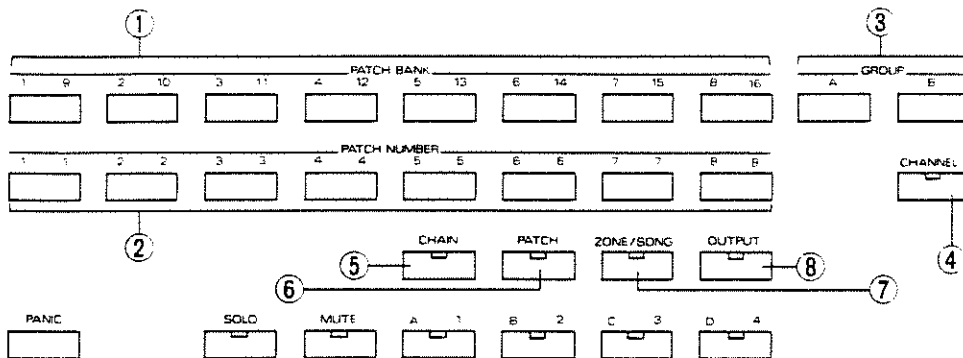

① **Bank buttons (Channel Number buttons when the Channel button is on)**

Use these buttons for Bank(1 to 8) or MIDI channel(9 to 16) selection.

② **Number buttons(Channel Number buttons when the Channel button is on)**

Use these buttons for selecting a Voice number(1 to 8) or MIDI channel(1 to 8).

③ **Group buttons**

Use these button to select a Voice Group.

④ **Channel buttons**

Use these buttons to change MIDI channels.

⑤ **Chain button**

Press this button to change the Chain settings.

⑥ **Patch button**

Press this button to change the Patch.

⑦ **Song/Zone button**

In this section, you can use this button to select a song from an external sequencer.

⑧ **Output buttons**

In this section, pressing this button will output Program Change messages, on the channel specified by use of the channel button.

## Zone/Output Selector :

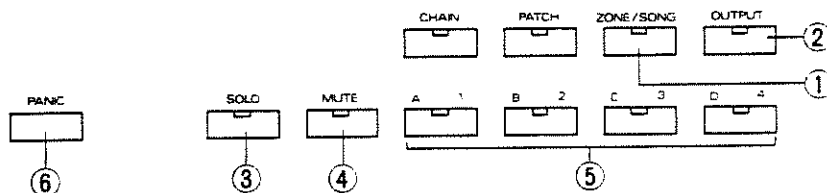

### ① Song/Zone buttons

In this section, you can use this button to set the Solo/Mute status of each zone(A,B,C or D).

### ② Output buttons

In this section, you can use this button to set the Solo/Mute status of each MIDI output(1,2,3 or 4).

### ③ Solo button

Press this button for setting Solo for a Zone/Output.

### ④ Mute button

Press this button for setting Mute for a Zone/Output.

### ⑤ Zone /Output Selectors

Use these buttons to set the Zone/Output Solo or Mute.

### ⑥ Panic button

The Panic button is included to shut down any hanging notes that might occur in a complex setup.

## Editor and Controller Section :

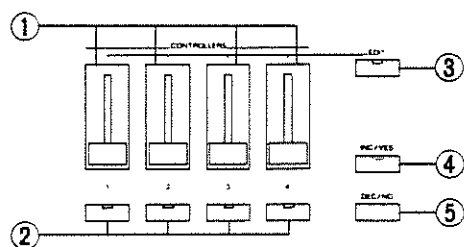

### ① Sliders

When Edit is on, the sliders are used to edit parameters. When Edit is off, they send the Control Changes they have been assigned to.

### ② Control switch

This selects ON/OFF of the effect(MIDI Control Change) currently in use.

### ③ Edit button

Pressing this button in the Protect Off condition turns to the editing mode.

### ④ Increment/Yes button

} These buttons set or monitor the values in editing.

### ⑤ Decrement/No button



## Menu keys and Cursor buttons :

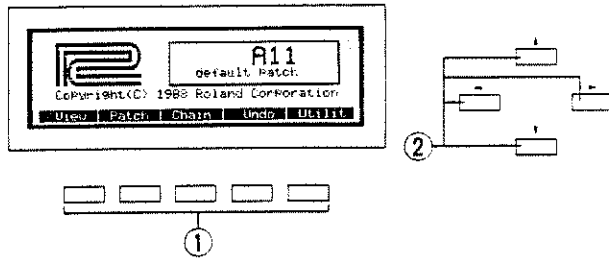

### ① Menu keys

Use a Menu key to access the desired menu. The programming system of the A-80 uses a series of menus to access the A-80's parameters. The menus contain labels for the Menu keys in the reversed section on the last line of the Display. There are 5 reversed boxes, one for each Menu key.

### ② Cursor buttons

Use these buttons to shift to a different parameter during editing. During live performance, these buttons are used to step Patch or Chain.

## e. Performance Functions

The Performance Controlling functions control the sound during live performance.

### Pitch Bend/Modulation control

The A-80 features both lever and wheel type controllers. Using these, the Pitch Bend, and Modulation effect can be controlled. The actual effect of the Modulation will differ depending on the section where the effect is used.

- \* Both the lever and wheel can be simultaneously used.
- \* The Bender Range varies depending how it is set on the sound source.

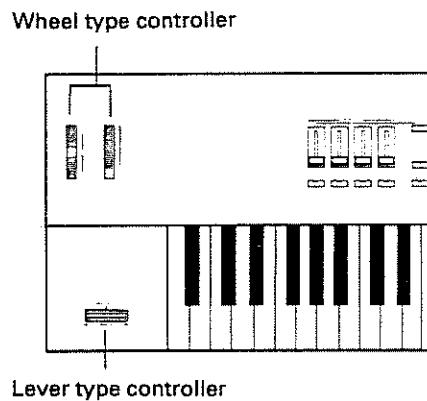

- \* Each zone may have a different Pitch Bend ON/OFF.
- \* No effect may be created by the Pitch Bend or Modulation, or the effect varies depending on the setting on the A-80 or the sound.

### Velocity

The tone and volume changes depending how hard you play the keyboard.

- \* Each zone may have a different Velocity curve.

### Aftertouch

Aftertouch is the function that creates any change in the sound by pressing a key harder after playing it in a normal manner. The aftertouch can control the pitch, vibrato, volume, etc. The A-80's aftertouch includes Channel aftertouch plus independent aftertouch for each key(Polyphonic aftertouch).

- \* Each zone may have a different aftertouch type and aftertouch curve.

## Controller

The A-80 features three types of controllers which may be assigned to any MIDI control messages; 4 slider type controllers and button type controllers on the front panel, and 4 foot controllers(control pedal sockets) on the rear panel. Controller assignment will create subtle nuance during live performance.

## Slider Controllers

The assigned control change is continuously changed.

## Controller Switches

The assigned control change can be turned on or off.

## Foot Controllers

The A-80's Foot Controller inputs can accept Roland Foot Switches(DP-2, DP-6) or Continuous Volume Pedals(EV-5). This allows, for example, "Continuous Damper" generation.

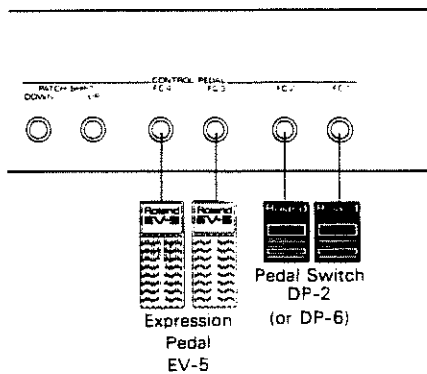

## Patch Shift(Up/Down)

The A-80's Patch Shift sockets can accept the Roland Foot Switches(DP-2, DP-6). This allows you to advance or back up a Patch number by pressing the pedal.

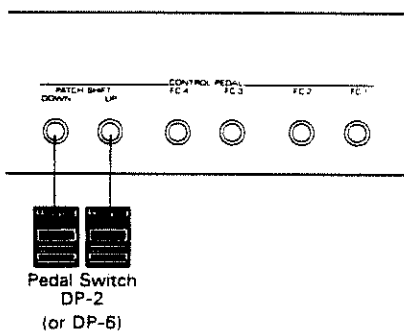

## **f. Memory Capability**

The following is the contents of the A-80's memory.

- 16 MIDI channel names, each of 10 characters.
- 64 PATCHES each with a 16 character name. 32 CHAINS each with a 16 character name, a 32 character comment and up to 32 linked patches each.
- ZONE(A,B,C and D)'s Solo/Mute
- Output(1,2,3 and 4)'s Solo/Mute
- 4 ZONES(each having a "from key" and a "to key" that specify the range to be zoned, channel, transpose, Velocity Curve, Aftertouch curve, Volume Message, Modulation Message, Program Change and Bender On/Off)
- 4 effector program changes
- Control Change number assignment to the 4 slider controllers, 4 controller switches and 4 foot controllers.
- MIDI option settings of receive Program Change channel, Active Sensing disable, All Notes Off enable and Exclusive receive disable.
- About 13000 bytes of System Exclusive data can be stored within the A-80's memory.

## [3] Menu Map and interconnection system

The Menus are set out in a tree structure. Infrequently needed parameters are in deeper branches of the tree. The five Menu keys located under the display window are used for shifting to another menu.

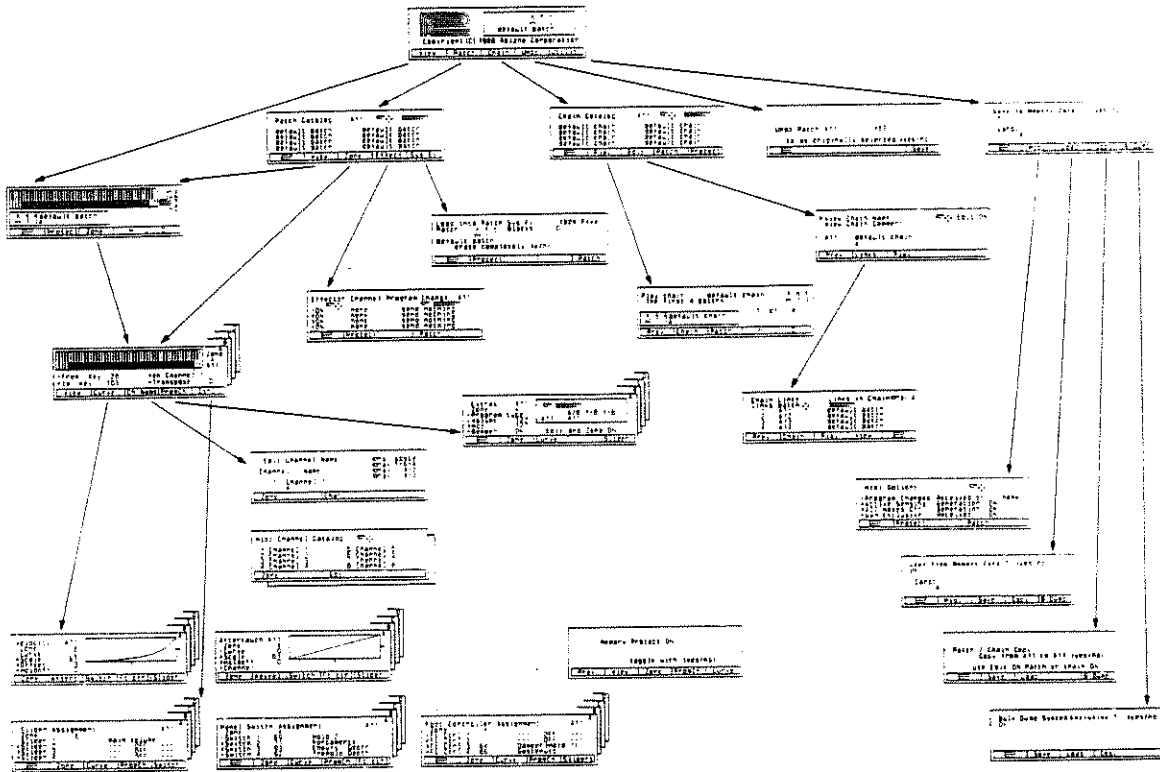

There are many menus that allow direct jumping to menus in different areas of the tree. The menu map is required to become familiar with exactly where the wanted menu is located, and the route required to get to it.

e.g.: **Procedure to get to the Chain Catalog menu from the Chain Copy menu.**



The quickest route is : Press the Roland key (Menu key with  ) to get to the Roland menu, then move to the Chain Catalog menu by pressing the Chain key.

- \* There are several types of "popup" windows that allow you to send out Program Change or Song select messages whatever menu you are currently on.
- \* The A-80 buttons have a "Type ahead" buffer. This means that you do not have to wait for a menu to be displayed, before selecting an item.

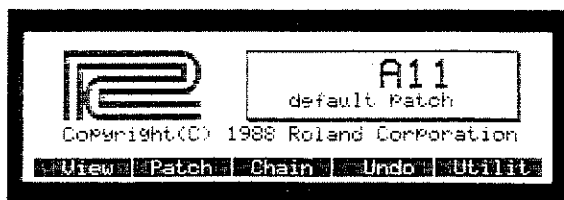
General description of the type of MENUS:



**a. ROLAND menu**

The menu with the ROLAND Symbol  is the first or home menu. Many menus have a  option that takes you directly to this home menu. From the ROLAND menu, the current patch number and its name are displayed, and also new patches may be selected and program changes sent. The patch may be stepped with the pedal switches or cursor up down buttons.

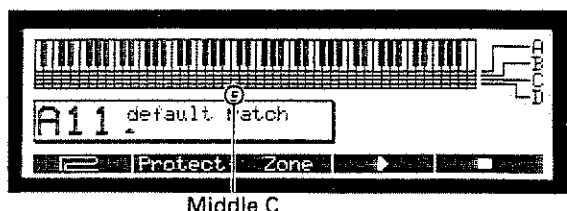

Middle C

**b. VIEW**

This is an over VIEW of the selected PATCH's keyboard. All ZONEs are displayed on the one 88 note piano keyboard graphic. For reference, middle C is marked under the Keyboard graphic. This menu also allows Song selects, MIDI Start and MIDI Stop commands to be sent.

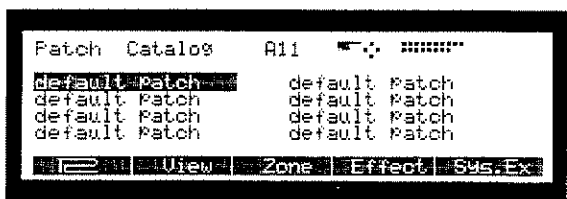

**c. Patch Catalog**

This is a display of the current PATCHs. The cursor displays the current patch. The Patch may be changed with the cursor buttons or with the PATCH(Bank/Number) buttons if the  is ON.

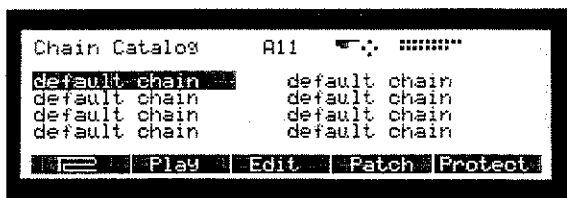

**d. Chain Catalog**

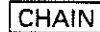
This is a display of the current CHAINs. The cursor displays the current Chain. The Chain may be changed with the cursor buttons or with the PATCH(Bank/Number) buttons if the  is ON.

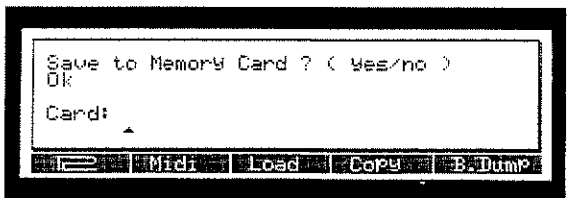

**e. Utilities (Save to Memory Card)**

This accesses such useful procedures as PATCH/CHAIN copy, MEMORY CARD save, load, System Exclusive Bulk Dump and the A-50's MIDI options(such as selecting program change receive channel).

# Performance Course

[1] Performance Play .....22

# [1] Performance play

## 1. Power-up

Make sure that the A-80 is properly connected to the external devices, then take the following procedure.

### STEP 1 Switch the A-80 on.

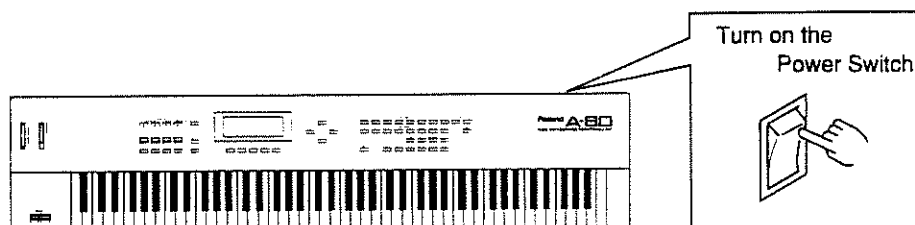

After a delay dependent on the content of the last patch used, the first(ROLAND) menu appears.



### STEP 2 Adjust the LCD contrast control for optimum viewing.

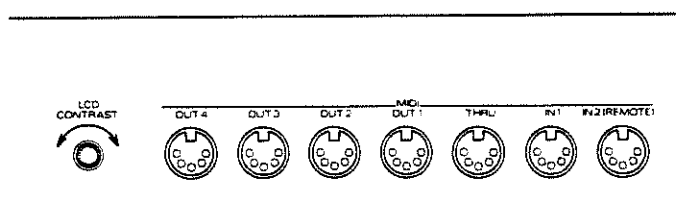



## 2. PATCH selection

The A-80 can store 64 different Patches that are the complete keyboard and sound module setup. To select a Patch, first press the **PATCH** , then the appropriate Bank button(1 - 8) and Number button(1 - 8). The relationship between BANK, NUMBER and the selected patch number is given in the following table.

GROUP A	NUMBER BANK	1	2	3	4	5	6	7	8
	1	0	1	2	3	4	5	6	7
	2	8	9	10	11	12	13	14	15
	3	16	17	18	19	20	21	22	23
	4	24	25	26	27	28	29	30	31
	5	32	33	34	35	36	37	38	39
	6	40	41	42	43	44	45	46	47
	7	48	49	50	51	52	53	54	55
	8	56	57	58	59	60	61	62	63

\*The Group B button is ignored in patch selection.

Procedure to select a patch :

**STEP 1** Push the **PATCH** .

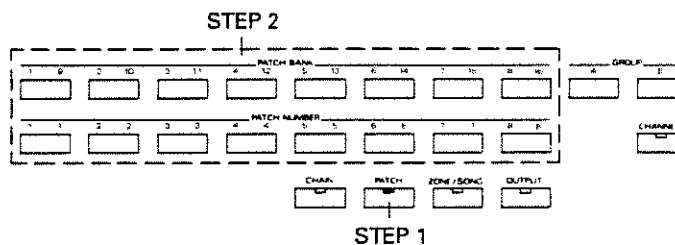

**STEP 2** Push the BANK NUMBER button to select an A-80 Patch.

e.g. : Selecting Patch 25

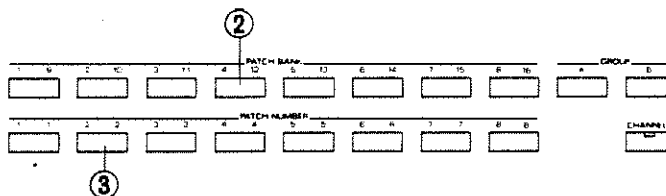

① Push **PATCH** .

② Push BANK button 4.

③ Push NUMBER button 2.

\* The PATCH will change when all notes are off on the keyboards, all notes are off from MIDI IN 1, and HOLD pedals is off.

\* There may be a delay between changing Patches if a lot of System Exclusive data is stored within one patch. For example, the complete patch memory of the P-330.

\* The Patch of the A-80 can also be changed by a Program Change message received from IN2(REMOTE) MIDI IN, when the PATCH button is ON.

### 3. CHAIN selection

The A-80 can store 32 different Chains that contain up to 32 patches in any order. To select a Chain, first press **CHAIN**, then the appropriate Bank button (1 - 4) and Number button (1 - 8). To see the effect of a chain selection, you must be in either CHAIN Catalog or CHAIN Play. The relationship between BANK, NUMBER and the selected Chain number is given in the following table.

**Procedure to get to the Chain Catalog menu from the Roland menu :**

**STEP 1** Press **Chain**.

GROUP A	NUMBER	1	2	3	4	5	6	7	8
	BANK								
1		0	1	2	3	4	5	6	7
2		8	9	10	11	12	13	14	15
3		16	17	18	19	20	21	22	23
4		24	25	26	27	28	29	30	31

\* The Group B button and Group B Banks 5,6,7, and 8 are ignored in chain selection.

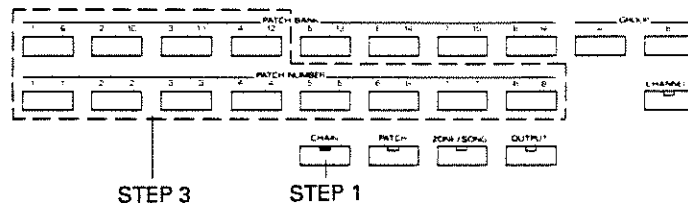

**Procedure to select a Chain :**

**STEP 1** Push **CHAIN**.

**STEP 2** Call the Chain Catalog(or Chain Play) menu so that you can later check the chain selection.

e.g. : Moving to the Chain Catalog menu from the Roland menu. Press the Menu key third from the left.

**STEP 3** Push the BANK and the NUMBER button to select an A-80 chain.

- \* The CHAIN will change when all notes are off for all MIDI inputs and keyboards, and the HOLD pedal is off.
- \* There can be a delay between changing CHAINS, as the MIDI data contained within theCHAIN's first PATCH must first be output.
- \* For details about Chain programming, see page 68 "Chain Link".
- \* The Chain of the A-80 can also be changed by a Program Change message received from MIDI IN2(REMOTE), when the CHAIN button is ON.

## 4. Send PROGRAM CHANGE

Procedure to send program change :

STEP 1 Press **OUTPUT**.

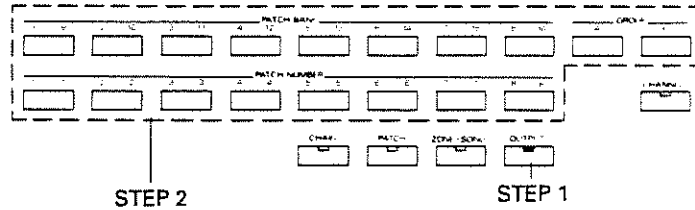

A popup window will appear showing the current output MIDI channel and the current or last sent patch.

STEP 2 Pushing the **GROUP, BANK and NUMBER** buttons will send the **Program Change on the current MIDI channel(or the last MIDI channel selected for output).**

The relationship between **GROUP, BANK, NUMBER** and the Program Change number is given in the following table.

GROUP A	NUMBER BANK	1	2	3	4	5	6	7	8
1	1	0	1	2	3	4	5	6	7
2	2	8	9	10	11	12	13	14	15
3	3	16	17	18	19	20	21	22	23
4	4	24	25	26	27	28	29	30	31
5	5	32	33	34	35	36	37	38	39
6	6	40	41	42	43	44	45	46	47
7	7	48	49	50	51	52	53	54	55
8	8	56	57	58	59	60	61	62	63

GROUP B	NUMBER BANK	1	2	3	4	5	6	7	8
1	1	64	65	66	67	68	69	70	71
2	2	72	73	74	75	76	77	78	79
3	3	80	81	82	83	84	85	86	87
4	4	88	89	90	91	92	93	94	95
5	5	96	97	98	99	100	101	102	103
6	6	104	105	106	107	108	109	110	111
7	7	112	113	114	115	116	117	118	119
8	8	120	121	122	123	124	125	126	127

e.g. : Sending Program Change number 100

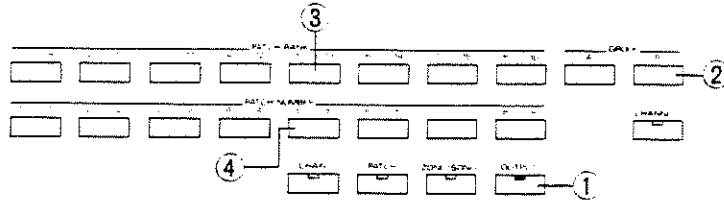

- ① Press the **OUTPUT** .
- ② Press GROUP button B.
- ③ Press BANK button 5.
- ④ Press NUMBER button 5.

To change the output MIDI channel to send a Program Change on.

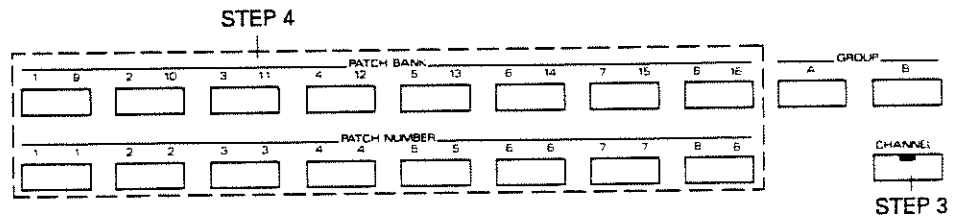

**STEP 3** Press the **CHANNEL** .

**STEP 4** Select a MIDI channel with a Channel number button.

e.g. : Selecting channel 4

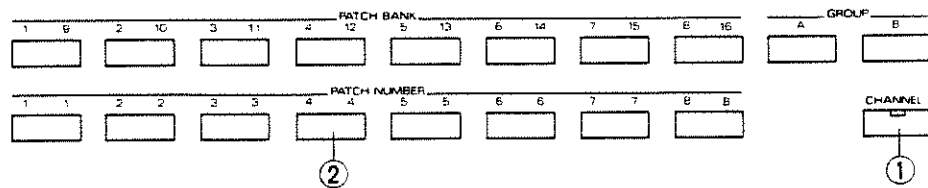

- ① Press the **CHANNEL** .
- ② Press the CHANNEL NUMBER button 4.

- \* The selected MIDI channel will become the current output channel until it is changed again or the power is turned off. At power on, the current Output channel for program change output is set to MIDI channel 1.
- \* The A-80 PATCH or CHAIN remains unchanged even after selecting or sending the Program Change.
- \* If **CHANNEL** is pressed, and some other menu function is selected, the next time the patch select buttons are touched, the channel popup will reappear and select the MIDI channel.

## 5. Send PROGRAM CHANGE on a ZONE

Procedure to send Program Change on a Zone:

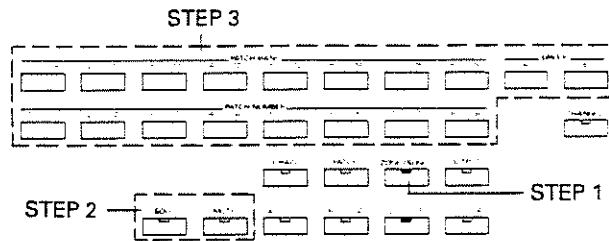

- STEP 1** Press the **ZONE** button. A popup window will display the current program change number and the current or last selected MIDI channel.

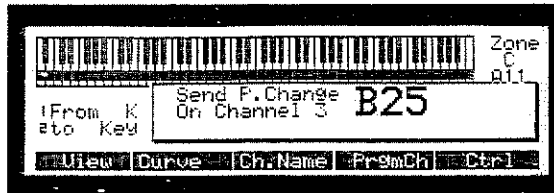

- STEP 2** Press **SOLO** or **MUTE** until they are both OFF. The ZONE button will light to indicate the current ZONE in the popup window. The buttons A, B, C and D now select and change current zone.

\* You may open the ZONE menu for monitoring the zone selection you are performing. (P45)

\* Each zone has a different MIDI channel.

- STEP 3** Using **GROUP**, **BANK** and **NUMBER** buttons, select a patch to be output on the MIDI CHANNEL of the ZONE that was last accessed.

e.g. Send Program Change B-25 on ZONE B's MIDI channel  
Push ZONE/SONG button if not ON.

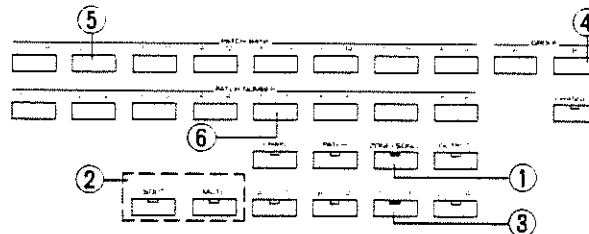

- ① Press **ZONE** button.
- ② Press **SOLO** or **MUTE** until they are both OFF.
- ③ Push the ZONE C button.
- ④ Push GROUP B button.
- ⑤ Push BANK 2 button.
- ⑥ Push NUMBER 5 button.

\* If you wish to change the MIDI channel set on a zone, see page 48 "ZONE b. MIDI channel".

## 6. ZONE SOLO/MUTE

Procedure for setting  
the Zone Solo/Mute :

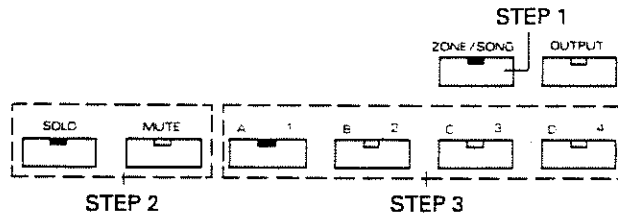

**STEP 1** Push **ZONE** .  
**SOLO** or **MUTE** will light to indicate that the buttons **A B C D** can be used to **MUTE** or **SOLO** ZONES.

**STEP 2** Push **SOLO** or **MUTE** to select the required mode.  
SOLO mode : Only the selected zone is played, the other three muted.

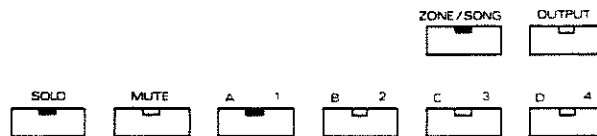

MUTE mode : Each zone can select MUTE ON/OFF individually.

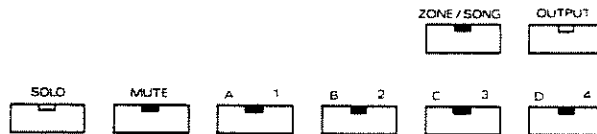

**STEP 3** Pressing **A B C** or **D** will solo or mute/unmute the zone depending on if the mode is **SOLO** or **MUTE**.

\* The current MUTE state will be saved in the patch.

e.g. : Solo ZONE B

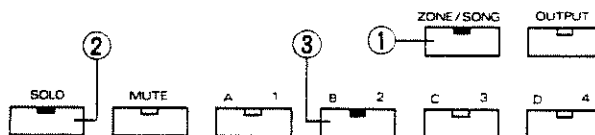

- ① Press **ZONE** .
- ② Push **SOLO** if **MUTE** is ON, or if **SOLO** and **MUTE** are both OFF.
- ③ Push the button **B**.

\* If you cannot get any output from the **A-80**, check to see if the zone you are playing is muted.

\* Zones cannot be muted if notes are still on.

## 7. OUTPUT socket SOLO/MUTE

Procedure for setting the Output socket's SOLO/MUTE :

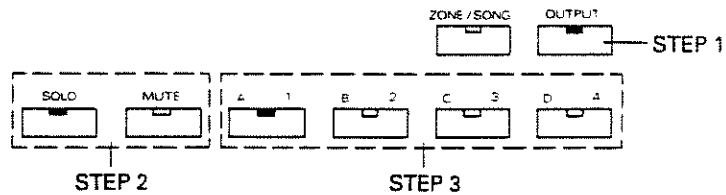

**STEP 1 Push the OUTPUT button.**

The SOLO or MUTE button will light to indicate the A-80's MIDI output sockets 1 2 3 4 mute state.

**STEP 2 Press **SOLO** or **MUTE** to select the required mode.**

**SOLO mode :** Only the selected socket is used, the other three muted.



**MUTE mode :** Each output can select MUTE ON/OFF individually.



**STEP 3 Pressing 1 2 3 or 4 will solo or mute/unmute that socket depending on if the mode is SOLO or MUTE.**

- \* The current MUTE state will be saved in the patch.
- \* A button with an LED ON means that output socket is not muted.

e.g. : MUTE Output Socket 4

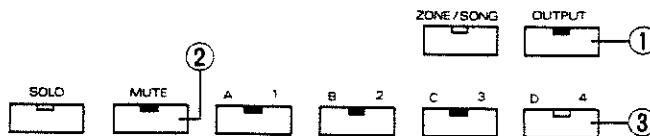

- ① Push **OUTPUT**
- ② Push **MUTE** if **SOLO** is on, and all the four Output buttons will light
- ③ Push "4" button

\* If you cannot get any output from the A-80, check to see if the output socket you are playing is muted.

\* Outputs cannot be muted if notes are still on.

## 8. Send SONG select

The A-80's Song Select function allows you to select a song on a sequencer or rhythm machine.

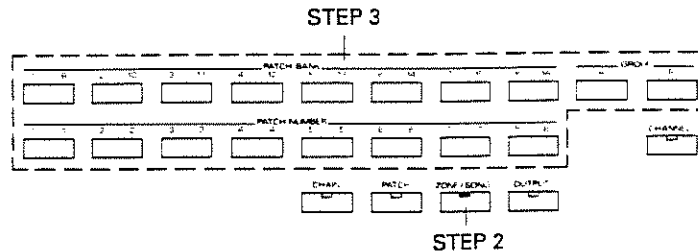

### Procedure to Send Song Select :

**STEP 1** Call the **VIEW** (or **CHAIN PLAY**) menu with the Menu keys.

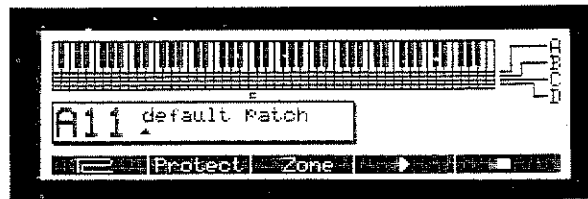

**STEP 2** Push **SONG** .

**STEP 3** The **PATCH SELECT** buttons will select a **SONG** and send a **SONG SELECT** message. (P45)

The relationship between **GROUP**, **BANK**, **NUMBER** and the Song Select number is given in the following table.

GROUP A	NUMBER	1	2	3	4	5	6	7	8
	BANK								
	1	1	2	3	4	5	6	7	8
	2	9	10	11	12	13	14	15	16
	3	17	18	19	20	21	22	23	24
	4	25	26	27	28	29	30	31	32
	5	33	34	35	36	37	38	39	40
	6	41	42	43	44	45	46	47	48
	7	49	50	51	52	53	54	55	56
	8	57	58	59	60	61	62	63	64

GROUP B	NUMBER	1	2	3	4	5	6	7	8
	BANK								
	1	65	66	67	68	69	70	71	72
	2	73	74	75	76	77	78	79	80
	3	81	82	83	84	85	86	87	88
	4	89	90	91	92	93	94	95	96
	5	97	98	99	100	101	102	103	104
	6	105	106	107	108	109	110	111	112
	7	113	114	115	116	117	118	119	120
	8	121	122	123	124	125	126	127	128



e.g.: Send SONG SELECT to select Song number 4

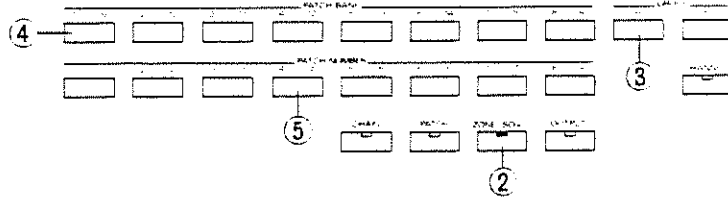

- ① Push **View** until on View menu .
- ② Push **SONG** if not on .
- ③ Push GROUP A button .
- ④ Push BANK 1 button .
- ⑤ Push NUMBER 4 button .

\* The Song Select function may be used with Start key or Stop key in the VIEW menu. It allows remote control on an external unit such as a sequencer.

## 9. ALL NOTE OFF(PANIC button)

Press **PANIC** when hanging notes occur on the external MIDI sound module or the bender or modulation effect is strange.



A popup window will appear, and a NOTE OFF command is sent on every MIDI output. It also resets all the internal MIDI data(returns to the power on state).

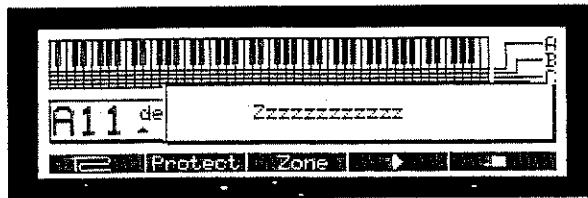

- \* During this time, the keyboard is inactive.
- The A-80 reselects its current PATCH later.



# Editing Course

[1] EDITING .....	34
[2] PATCHES .....	38
[3] CHAINS .....	66
[4] EDIT MIDI OPTIONS .....	70
[5] UTILITIES .....	73
[6] DEFAULT SETTINGS .....	78

**Note:** If the Zone has been muted during editing, or the output Connected to the sound module is muted, there may be no sound generated.

☞ p.28 "ZONE SOLO/MUTE"

☞ p.29 "OUTPUT socket SOLO/MUTE"

# [1] EDITING

## 1. Memory Protect ON/OFF

The Memory Protect function protects data in memory from accidental erasure. At power on, the A-80's memory is write protected(Protect ON). To enable writing, this must be disabled(Protect OFF).

### Procedure to edit

a Patch name:

STEP 1 Press **View** .

STEP 2 Press **Protect** .

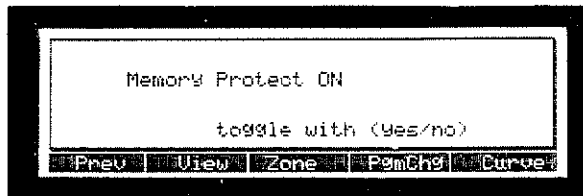

### Procedure to change the Protect state:

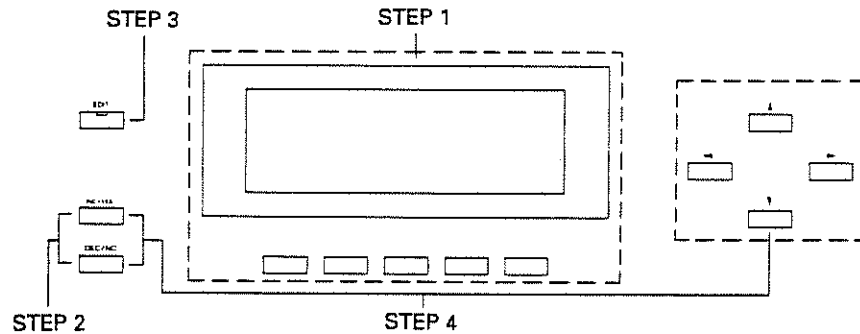

STEP 1 Select a PROTECT menu(it is in several places, VIEW, CHAIN).

STEP 2 Press **YES** or **NO** . This toggles the ON/OFF state.

STEP 3 Press **EDIT** when you wish to change a parameter, otherwise leave it OFF.

If the Memory is Write Protected and **EDIT** pressed, the following message will pop up.

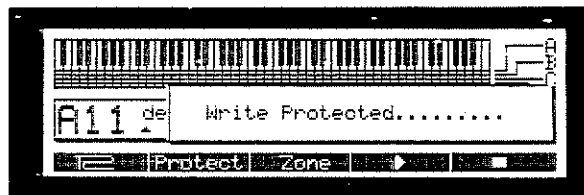

This message can be removed by pressing any of the CURSOR or YES, NO buttons.

## 2. Edit ON/OFF

If **EDIT** is OFF, the Controllers values are converted to a MIDI controller messages and output. If **EDIT** is ON(in the Controller mode), the Controllers value is converted to a menu's parameter, and the old parameters value is lost(Patches do have an UNDO function).

- \* In Edit mode only, the last moved slider is used, even if 4 values are simultaneously available. This means that if the 4 sliders are moved simultaneously when editing, not all values will be updated to represent the new values of all faders.
- \* User assigned controllers will not send any MIDI messages when Edit is ON.

## 3. Undo

The A-80 has no write button for entering edited patches into memory. Instead, it saves a copy of the current PATCH in the undo buffer when the PATCH is selected. If the patch is reselected, it is recopied to this buffer. Whenever the patch is edited, it is the actual PATCH data in memory that is edited. If you wish to UNDO any editing that you have done before another patch is selected, or the current patch is reselected, do as follows:

**Procedure to get to the Undo menu from the ROLAND menu:**

STEP 1 Press **Undo** .

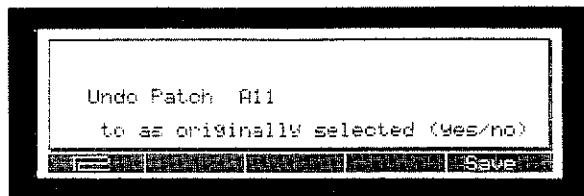

**Procedure to Undo a Patch from an Edit:**

STEP 1 Select the Undo menu.

STEP 2 Press **YES** .

INC/YES



- \* The display will flash to indicate the procedure was done
- \* Chains do not have the Undo function.

## 4. Copy

Any PATCH can be copied to any other patch, any CHAIN can be copied to any other chain, with this menu. The selection of Patch or Chain copy is determined by the state of the Patch or Chain buttons.

**Procedure to get to the Copy menu from the ROLAND menu:**

**STEP 1** Press **Utilit** .

**STEP 2** Press **Copy** .

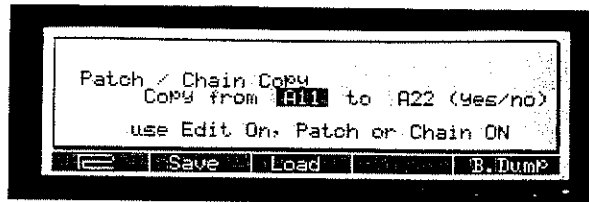

### a. Procedure to Copy a Patch

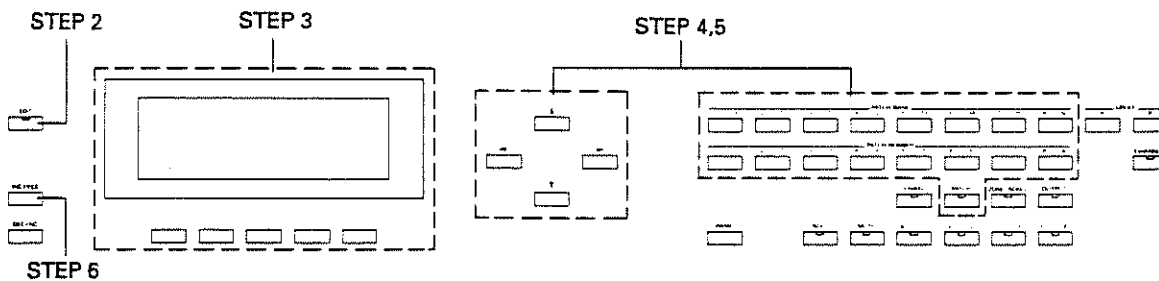

- STEP 1** **Disable Memory Protect**  
(☐ page 34 "Memory Protect ON/OFF").
- STEP 2** Press **EDIT** .
- STEP 3** **Select Copy menu.**  
(☐ "Procedure to get to the Copy menu from the ROLAND menu")
- STEP 4** **Select the patch to copy FROM with the Patch and cursor buttons.**  
Copy from A11 to  
▲
- STEP 5** **Select the patch to copy TO with the Patch and cursor buttons.**  
Copy from A11 to A22  
▲
- Step 6** Press **YES** to copy the Patch.

\* The display will flash to indicate the procedure was done.

## b. Procedure to Copy a Chain

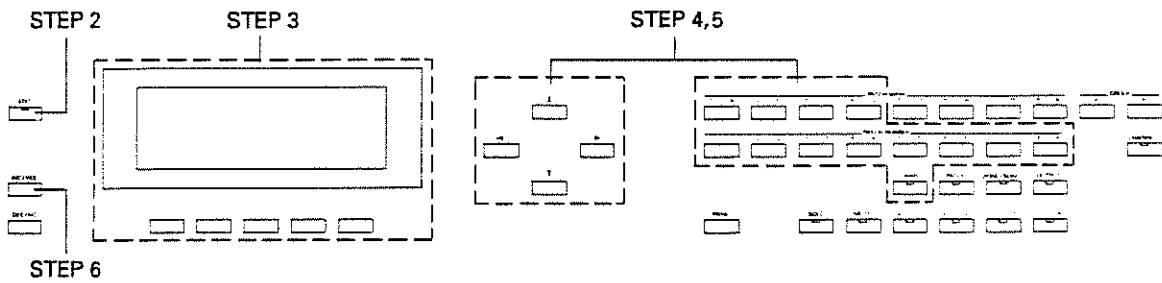

**STEP 1** Disable Memory Protect.

(☞ page 34 "Memory Protect ON/OFF").

**STEP 2** Press **EDIT** .

**Step 3** Select **COPY** menu.

("Procedure to get to the Copy menu from the ROLAND menu")

**STEP 4** Select the Chain to copy **FROM** with the Patch and cursor buttons.

Copy from A12 to



**STEP 5** Select the Chain to copy **TO** with the Patch and cursor buttons.

Copy from A12 to A13



**Step 6** Press **YES** to copy the Chain.

• The display will flash to indicate the procedure was done.

## [2] PATCHES

### 1. Patch Catalog

This menu is a Catalog of the current patches.

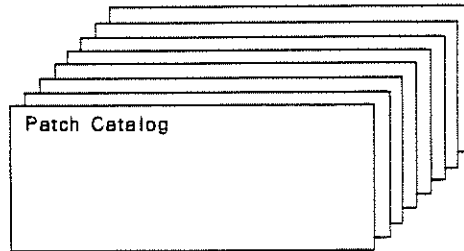

Procedure to get to the Patch menu from the ROLAND menu:

STEP 1 Press **Patch** .

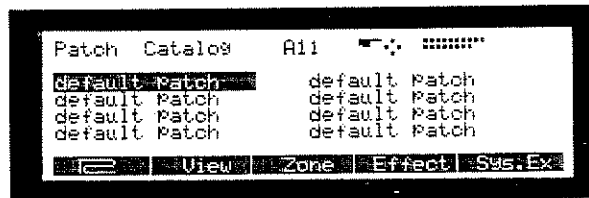

The Patch Catalog is displayed.

There are 8 pages(1 for each BANK) each with 8 entries(for each NUMBER).The currently selected PATCH is reversed. Its number is displayed at the top of the screen. The PATCH may also be selected with the Patch selector buttons or the cursor buttons, if **PATCH** is on.



### 2. View

This menu is an overview of the 4 zones in the current Patch. The extent of each zone is displayed. Normally, keep this menu open while playing, if not using the chain function.

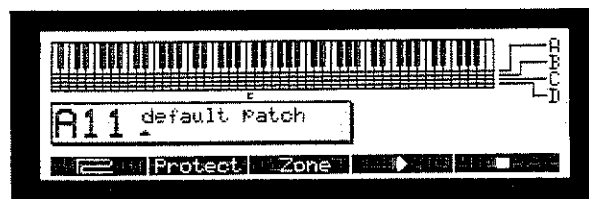
Procedure to get to the View menu from the ROLAND menu:



STEP 1 Press **View** .

Cursor  and  will step sequentially through the patches.

\* The STEP UP, STEP DOWN foot switches will do the same.

The MIDI Start message will be sent when  is pressed.

The MIDI Stop message will be sent when  is pressed.

\* The recognition of the START and STOP message is dependent on the MIDI implementation of the sequencer used.



## a. Patch Name

Each Patch has a name that may be up to 16 characters long.

### Procedure to edit

a Patch name:

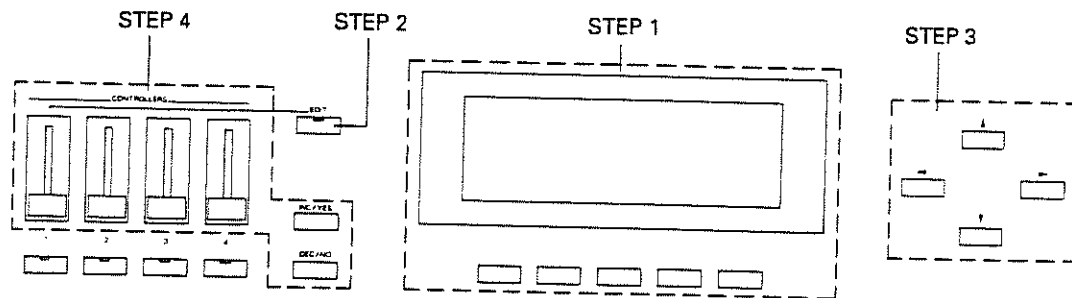

(☞ page 38 "Procedure to get to the View menu from the ROLAND menu")

**STEP2** Press **EDIT** .

(If the Memory Protect is ON, ☞ page 34 "Memory Protect ON/OFF").

**STEP 3** Press the cursor buttons **◀ ▶** to select the character (move the cursor).

A11 default Patch

**STEP 4** Press **INC** or **DEC** or use the sliders to change current character.

\* The sliders have the following characters in name editing.

Slider-1	Space
Slider-2	!"#\$%&'()+,-./0123456789;{:=?
Slider-3	ABCDEFGHIJKLMNOPQRSTUVWXYZ
Slider-4	abcdefghijklmnopqrstuvwxy

## b. System Exclusive

The Patch data of sound modules, Exclusive edit messages or other System Exclusive data, may be stored in a PATCH.

**Procedure to get to the System Exclusive menu from the ROLAND menu:**

**STEP 1** Press **Patch** .

**STEP 2** Press **Sys.Ex** .

\* This memorized System Exclusive will then be output when the PATCH is selected.

\* The Sys.Ex menu allows System Exclusive to be entered into the patch number currently shown.

The Amount of FREE MEMORY available is displayed.



The number of blocks of Exclusive currently contained is also displayed.

\* The current Exclusive will be automatically deleted and replaced with new data, when a Patch is selected, and EDIT is on.

\* The System Exclusive to be stored in the A-80's internal memory must be input to the IN1 MIDI input.

**Procedure for Loading Exclusive data into a patch:**

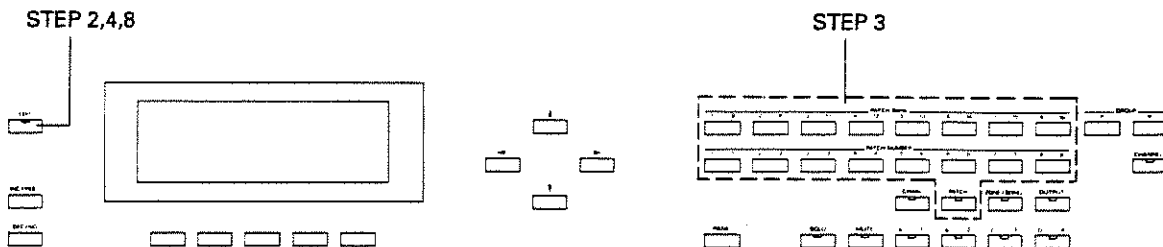

**STEP 1** Disable Memory Protect.  
( ☐ page 34 "Memory Protect ON/OFF").

**STEP 2** Keep **EDIT** OFF.

**STEP 3** Select the Patch that you want to save Exclusive in.

**STEP 4** Turn **EDIT** ON.

**STEP 5** Connect the MIDI device to load Exclusive data via the MIDI IN1 Input (in One-way Dump).

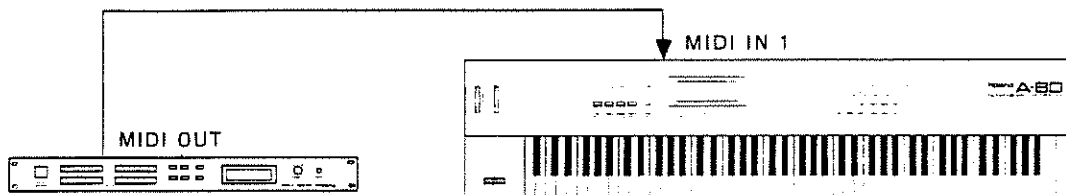

- \* If this patch was the last patch to have Exclusive saved in it, the previous Exclusive may be added to the new data.
- \* If the current exclusive is no longer required, press YES to delete it.

**STEP 6** Dump the Exclusive to the A-80.

- \* The amount of FREE memory and the number of EXCLUSIVE messages saved will be displayed. (The amount of FREE memory is the A-80's total memory left to save Exclusive.)

**STEP 8** Turn  EDIT OFF.

- \* If the A-80's memory filled before the Message was finished loading, the incomplete message will be deleted and a "Not Enough Memory" error will be displayed.

## c. Effect Device Program Changes

An additional 4 Program Changes may be stored in each PATCH. These may be sent on any MIDI channel. These memorized Program Changes will then be output when the PATCH is selected.

### Procedure to get to the Effect

Program Change menu from  
the ROLAND menu:

STEP 1 Press **Patch** .

STEP 2 Press **Effect** .

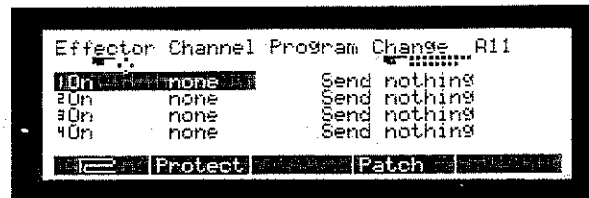

### Procedure for setting Effect's

MIDI channels in a patch

using **INC** or **DEC** :

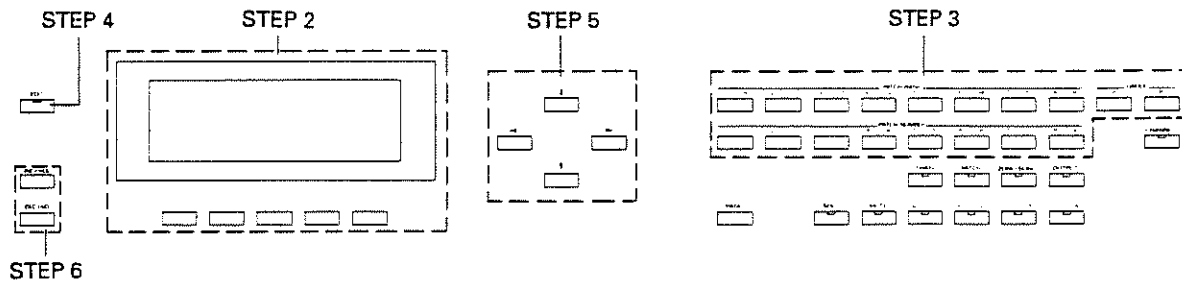

STEP 1 **Disable Memory Protect.**

(☞ page 34 "Memory Protect ON/OFF").

STEP 2 **Select the Effect Program Change menu.**

(☞ "Procedure to get to the Effect Program Change menu from the ROLAND menu")

STEP 3 **Select the Patch that you want to send Effect's Programs from.**

STEP 4 Turn **EDIT** on.

(If the Memory Protect is ON, ☞ page 34 "Memory Protect ON/OFF").

STEP 5 **Move cursor to one of the "On" variables.**

STEP 6 Press **INC** or **DEC** to set a MIDI channel.

\* All channels are cycled through, then —OFF— is selected, giving an "On none Send nothing" message.

**Procedure for setting Effect's  
Program Change in a patch  
using **INC** or **DEC** :**

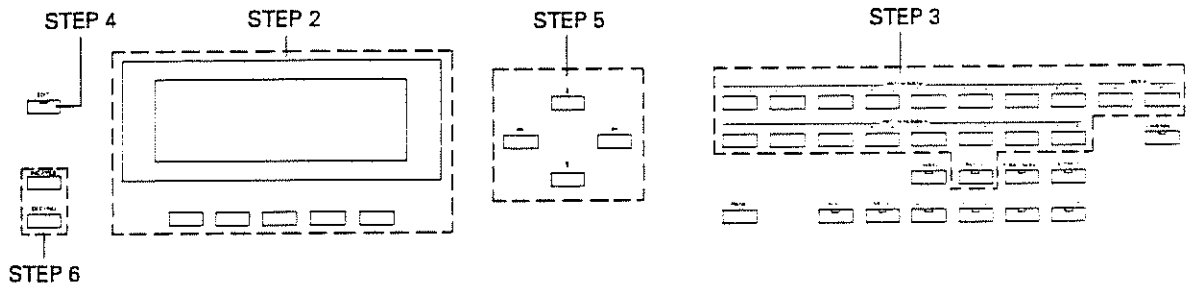

- STEP 1**    **Disable Memory Protect.**  
(☞ page 34 "Memory Protect ON/OFF").
- STEP 2**    **Select the Effect Program Change menu.**  
(☞ "Procedure to get to the Effect Program Change menu from the ROLAND menu")
- STEP 3**    **Select the Patch that you want to send Effect's Programs from.**
- STEP 4**    Turn **EDIT** on.  
(If the Memory Protect is ON, ☞ page 34 "Memory Protect ON/OFF").
- STEP 5**    **Move cursor to one of the "Send" variables.**
- STEP 6**    Press **INC** or **DEC** to select MIDI Program Change Message.  
\* The Program Change will also be output during editing.

**Procedure for setting Effect's  
MIDI channels using a slider  
into a patch:**

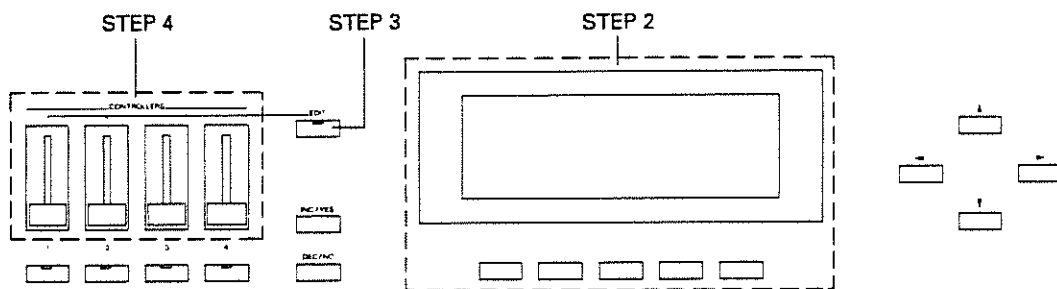

- STEP 1**    **Disable Memory Protect.**  
(☞ page 34 "Memory Protect ON/OFF").
- STEP 2**    **Select the Effect Program Change menu.**  
(☞ "Procedure to get to the Effect Program Change menu from the ROLAND menu")

**STEP 3 Press EDIT on.**  
 (If the Memory Protect is ON, ☞ page 34 "Memory Protect ON/OFF").

**Step 4 Select the slider to match the "On " message required.**  
 Then, set the channel number with the Slider.

\* The Program Change will now be output, along with the other patch data, whenever the patch is selected.

**Procedure for setting Effects  
 Program Change in a patch  
 using Patch Select buttons:**

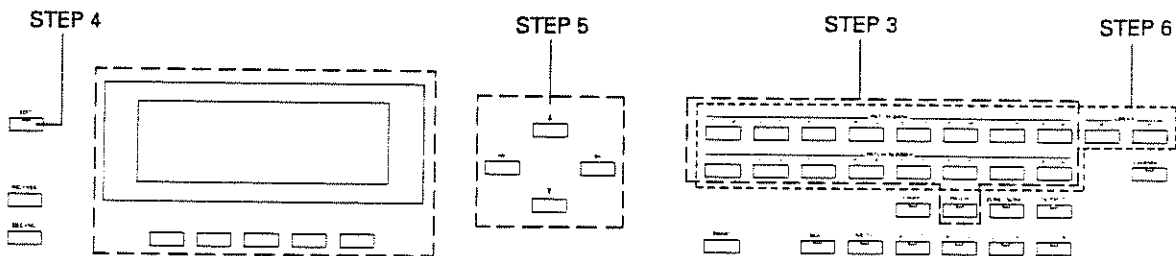

**STEP 1 Disable Memory Protect.**  
 (☞ page 34 "Memory Protect ON/OFF").

**STEP 2 Select the Effect Program Change menu.**  
 (☞ "Procedure to get to the Effect Program Change menu from the ROLAND menu")

**STEP 3 Select the Patch that you want to send Effect's Program from.**

**STEP 4 Press EDIT.**  
 (If the Memory Protect is ON, ☞ page 34 "Memory Protect ON/OFF").

**STEP 5 Move cursor to one of the "ON " or "Send " variables.**

**STEP 6 Press the Patch Select buttons to enter Program Change Message.**

\* The Program Changes are displayed in both Roland Group Bank Number format and decimal 1 to 128.

\* If the Effect's program change is set to the same MIDI channel as an unmuted zone, the Effect's program change will override the zone, as the Effect changes are output last.

# 3. Zone

## a. Selecting Zones

Procedure to get to the Zone menu from the ROLAND menu:

STEP 1 Press **View** .

STEP 2 Press **Zone** .

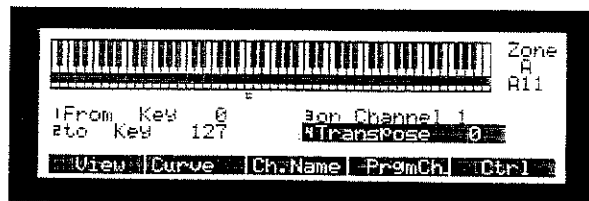

The parameters for Zones cover several menus. Each menu has 4 pages, one for each zone A, B, C, D. To make a Patch made of 4 zones, you must edit the parameters of all zones(pages).

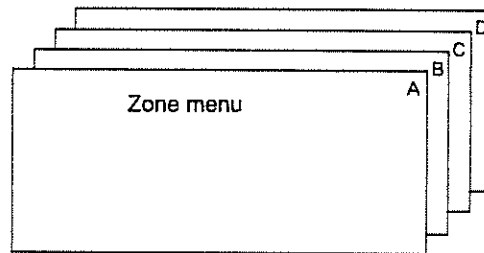

Procedure to select the Zone (page) to be edited:

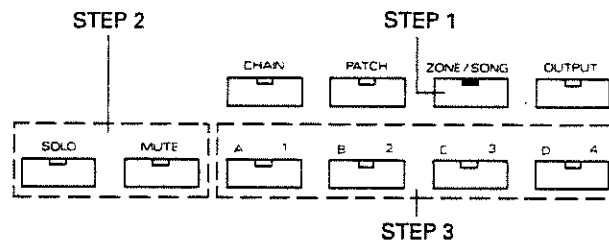

STEP 1 Press **ZONE** .

STEP 2 Press **SOLO** or **MUTE** till they are both OFF.

STEP 3 Buttons A,B,C and D now select the Zone in the Zone Menus.

The selected button lights up, and the corresponding page for the required Zone displayed.

## b. Zone position

Each zone has a FROM KEY number and a TO KEY number which can be used to set up to 4 sound ranges(positions). The Zone position can be edited with sliders, the keyboard and/or the Inc Dec buttons.

### Procedure to edit zone position using sliders:

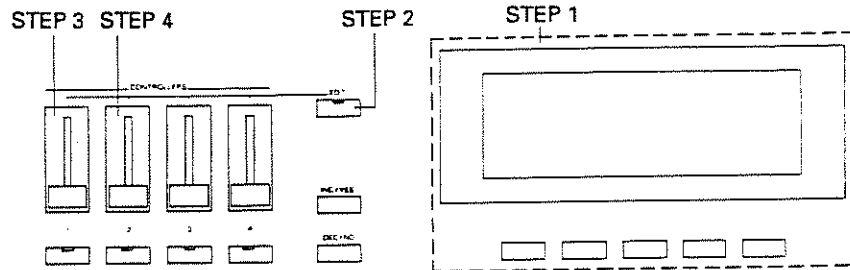

- STEP 1** Select the Zone page to Edit.  
( ☞ Page 45 "Selecting Zones; Procedure to select the Zone(page) to be edited".)
- STEP 2** Press **EDIT** .  
(If the Memory Protect is ON, ☞ page 34 "Memory Protect ON/OFF").
- STEP 3** The FROM KEY may be set with Slider 1.
- STEP 4** The TO KEY may be set with Slider 2.

### Procedure to edit Zone position using the keyboard:

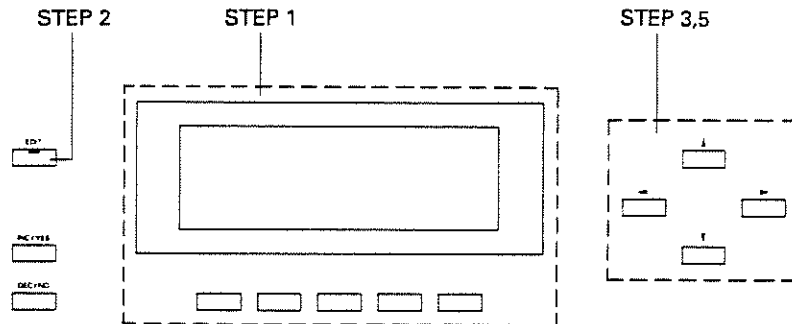

- STEP 1** Select the Zone page to Edit.  
( ☞ Page 45 "Selecting Zones; Procedure to select the Zone(page) to be edited".)
- STEP 2** Press **EDIT** .  
(If the Memory Protect is ON, ☞ page 34 "Memory Protect ON/OFF").



- STEP 3 Move cursor to FROM KEY.
- STEP 4 Press the A-80's keyboard(or an external keyboard) to select the key number.
- STEP 5 Move cursor to TO KEY.
- STEP 6 Press the A-80's keyboard(or an external keyboard) to select the key number.

Procedure to edit Zone position using **INC** or **DEC** :

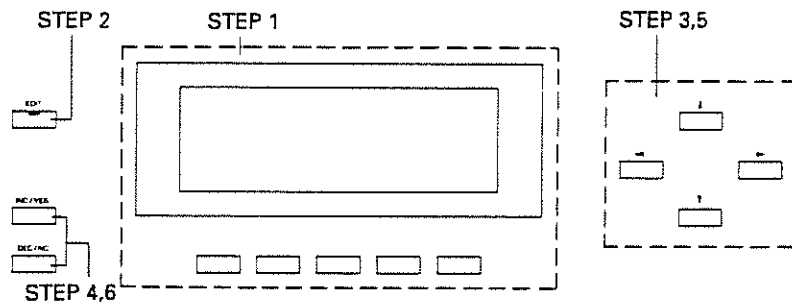

- STEP 1 **Select the Zone page to Edit.**  
(☞ Page 45 "Selecting Zones; Procedure to select the Zone(page) to be edited".)
- STEP 2 **Press EDIT on.**  
(If the Memory Protect is ON, ☞ page 34 "Memory Protect ON/OFF").
- STEP 3 **Move cursor to FROM KEY.**
- STEP 4 **Press the **INC** or **DEC** to select the key number.**
- STEP 5 **Move cursor to TO KEY.**
- STEP 6 **Press the **INC** or **DEC** to select the key number.**

\* MIDI note data is not output if the cursor is over FROM KEY or TO KEY and edit is on.

## c. MIDI Channel

Each Zone has an independent MIDI channel. The MIDI channel can be set using sliders and/or **INC** **DEC** .

### Procedure to edit zone

#### MIDI channel number:

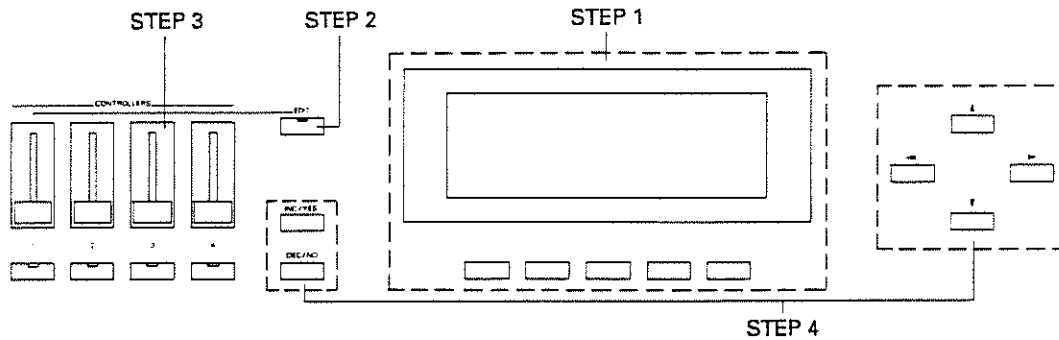

- STEP 1**     **Select the Zone page to edit.**  
( ↪ Page 45 "Selecting Zones:Procedure to select the Zone(page) to be edited")
- STEP 2**     **Press **EDIT** .**  
(If the Memory Protect is ON ↪ Page 34 "Memory Protect ON/OFF")
- STEP 3**     **Select the MIDI channel with Slider 3.**  
-OF-
- STEP 3**     **Move cursor to "on Channel \* \* ", then press the **INC** or **DEC** to select the MIDI channel.**
- \* Each zone must have a different MIDI channel. Zones cannot be set to the same channel.

## d. Transpose

The transpose function shifts the entire ZONE range. Transpose can be set for each zone individually.

### Procedure to edit zone

#### Transpose amount:

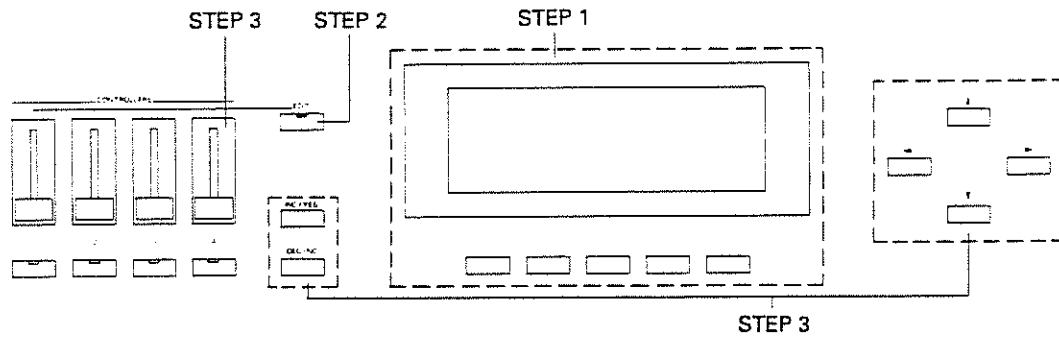

- STEP 1**     **Select the Zone page to edit.**  
(☞ Page 45 "Selecting Zones:Procedure to select the Zone(page) to be edited")
- STEP 2**     Press **EDIT** .  
(If the Memory Protect is ON ☞ Page 34 "Memory Protect ON/OFF")
- STEP 3**     **Select the Transpose amount with Slider 4.**  
-or-
- STEP 3**     **Move cursor to Transpose, then press the **INC** or **DEC** to select the Transpose amount.**

**\*The Transpose cannot be changed while notes are being played.**

## e. Velocity Curve

Each Zone in each Patch may have a different Velocity Curve. There are four parameters: the basic curve selecting parameter and 3 parameters to modify the basic curve in each zone.

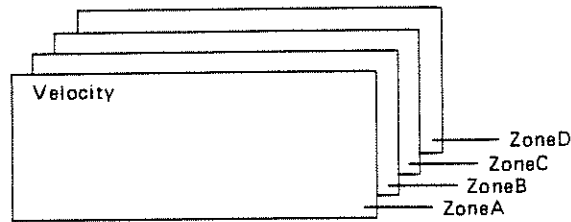

Procedure to get to the Velocity menu from the ROLAND menu:

- STEP 1 Press **View** .
- STEP 2 Press **Zone** .
- STEP 3 Press **Curve** to select the Velocity menu.

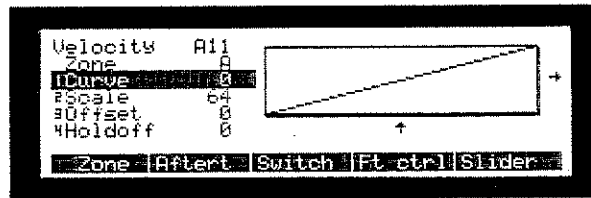

This menu also has a real time level display along the bottom of the Velocity curve display. This meter shows the modified velocity when Edit is On for the current zone.

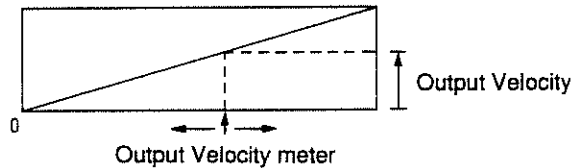

\* If the curve meter does not respond, make sure the Edit is ON, zone is not muted, and that the key you are testing your parameters with is within the current zone. If not, there will be no level display.

The 4 parameters are:

### [Curve]

There are the following 7 basic curves prepared. Select the one(0 to 6) you like, then modify the curve using the other parameters.

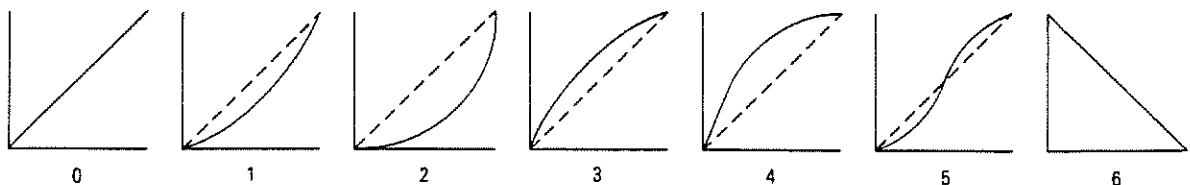

### [Scale]

This multiplies the selected curve by between 50% and 200%, scaled to 0 to 127. This effects the maximum value that the velocity can reach. If scale is set greater than 64, then the velocity data is made larger. If less than 64, then the velocity range is made smaller.

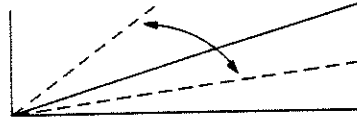

Scale should be set dependent on the velocity range on each sound module.

- \* When the velocity range of the sound module is small, you may set the A-80's scale fairly high to increase the velocity range.
- \* You may scale the A-80's keyboard velocity range to modify the velocity depth of each sound module.
- \* If the remote Keyboard does not generate the full velocity range required by the sound module, set the Scale on the A-80 fairly high to scale the remote keyboard's velocity to the full range.

### [Offset]

This adds a constant number(0 to 127) to the velocity from the keyboard to produce the output velocity.

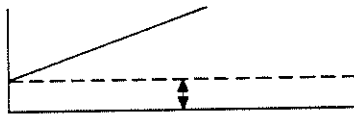

- \* If Scale is set to 0 and Offset is set to 64, then the velocity output will be a constant 64, no matter what the key striking velocity.



### [Holdoff]

This is the minimum velocity required from the keyboard before the curve will start. If the velocity is less than the HOLD OFF value, the first value of the curve is output as the velocity.

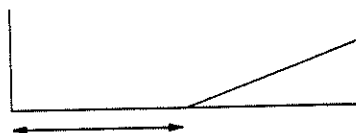

Velocity curve parameters can be set using Sliders and/or **INC** **DEC** buttons.

**Procedure to edit zone Velocity curve parameters:**

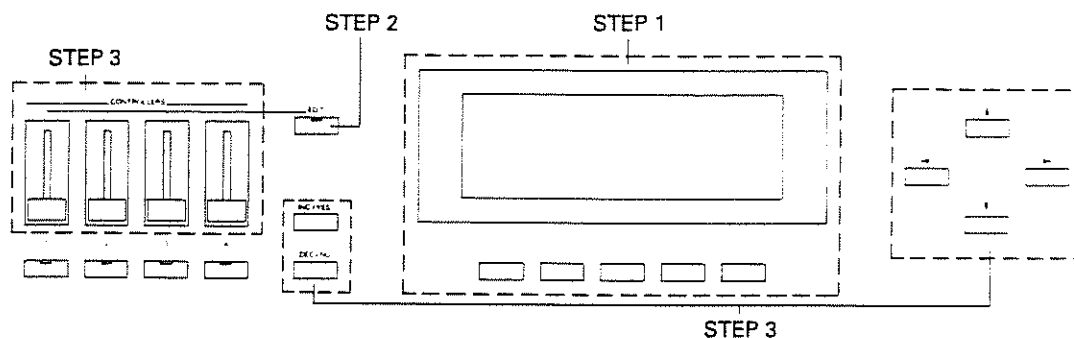

**STEP 1** Select the Velocity menu's page to edit.  
(☞ Page 50 "Procedure to get to the Velocity menu from the ROLAND menu; Procedure to select the Zone(page 45) to be edited")

**STEP 2** Press **EDIT** .  
(If the Memory Protect is ON ☞ Page 34 "Memory Protect ON/OFF")

**STEP 3** Adjust the parameter with the appropriate slider.  
-or-

**STEP 3** Move cursor to required parameter, then press **INC** or **DEC** to change parameter.

\* By mixing two zones which have different velocity curves, sound output can be controlled by changing the strength of the keyboard playing.

● Velocity Mix(the portions of the two sounds vary depending how the keyboard is played)

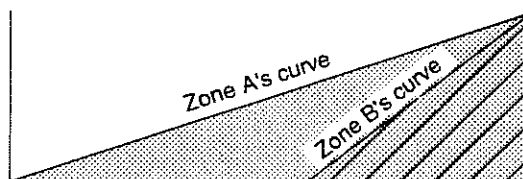

● Velocity Crossfade(either of the two sounds is output depending how the keyboard is played)

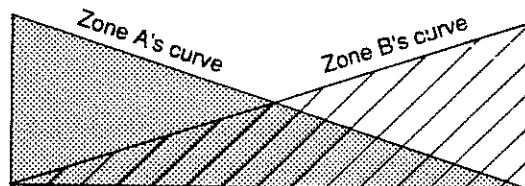

## f. Aftertouch Curve

Each Zone(A, B, C and D) in each Patch may have a different Aftertouch Curve. There are four parameters: the basic curve selecting parameter, 2 parameters to modify the basic curve and the aftertouch mode selecting parameter in each zone.

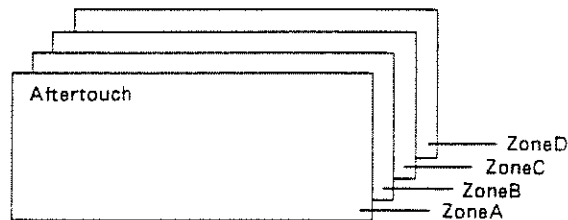

Procedure to get to the Aftertouch menu from the ROLAND menu:

- STEP 1 Press **View** .
- STEP 2 Press **Zone** .
- STEP 3 Press **Curve** .
- STEP 4 Press **Aftert** .

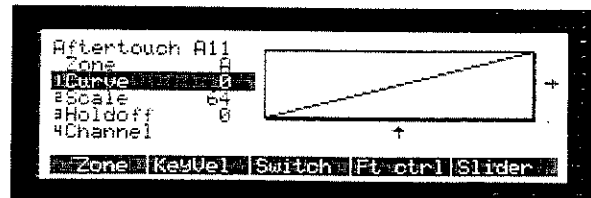

This menu also has real time level display along the bottom of the Aftertouch curve display. This meter shows the modified aftertouch, when Edit is on for the current zone.

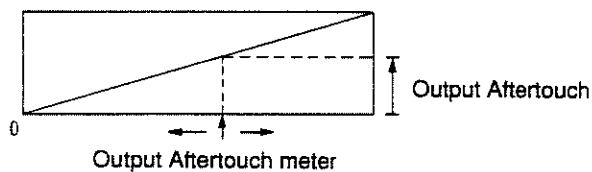

- If the curve meter does not respond, make sure the Edit is ON, zone is not muted, and that the key you are testing your parameters with is within the current zone. If not, there will be no level display.

The 4 parameters are:

**[Curve]**

There are the following 6 basic curves prepared. Select the one(0 to 5) you like, then modify the curve using the other parameters.

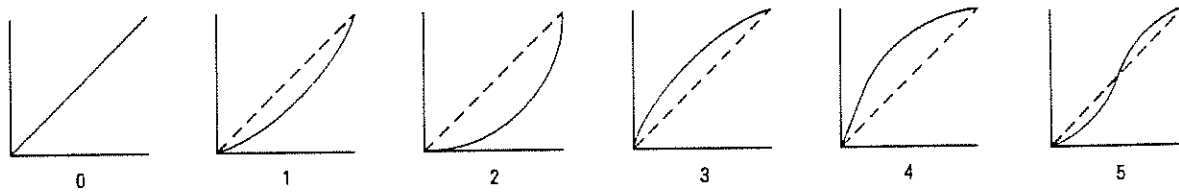

**[Scale]**

This multiplies the selected curve by between 50% and 200%, scaled to 0 to 127. This effects the maximum value that the aftertouch can reach. If scale is set greater than 64, then the aftertouch data is made larger. If less than 64, then the aftertouch range is made smaller.

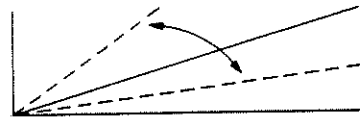

**[Holdoff]**

This is the minimum aftertouch required from the keyboard before the curve will start. If the aftertouch is less than the HOLD OFF value, the first value of the curve is output as the aftertouch.

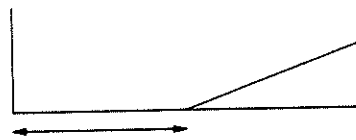

One of the following modes can be set for the Zone:

**[Polyphonic]**

Each key within the zone will respond to pressure individually.

**[Channel]**

All keys in the zone will have the heaviest pressure value within the zone.



**[Touch Off]**

Keys within the zone are insensitive to key pressure.

- If the sound module does not feature the Polyphonic aftertouch function, the effect is not obtained. Check the MIDI implementation chart of the connected sound module.

Aftertouch curve parameters can be set using Sliders and/or **INC** **DEC** .

**Procedure to edit zone Aftertouch curve parameters:**

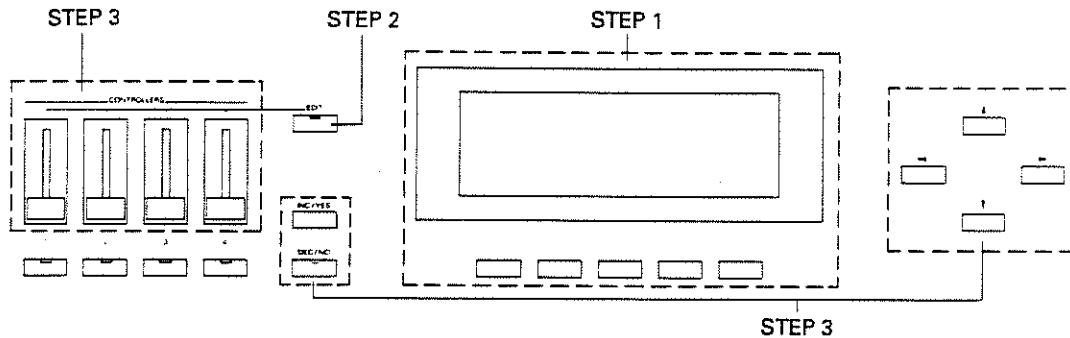

- STEP 1**    **Select the Aftertouch menu's page to edit.**  
(☞ Page 53 "Procedure to get to the Aftertouch menu from the ROLAND menu; Procedure to select the Zone(page 45) to be edited")
- STEP 2**    **Press **EDIT** .**  
(If the Memory Protect is ON ☞ Page 34 "Memory Protect ON/OFF")
- STEP 3**    **Adjust the parameter with the appropriate slider.**  
-or-
- STEP 3**    **Move cursor to required parameter, then press **INC** or **DEC** to change parameter.**

## g. Extra Menu

The Extra menu allows you to send Zone Program Change, Zone Volume, Modulation and Pitch Bend ON/OFF.

**Procedure to get to the Extra menu from the ROLAND menu.**

- STEP 1 Press **View** .
- STEP 2 Press **Zone** .
- STEP 3 Press **Prgm ch** .

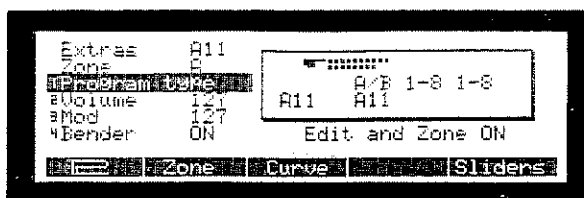

There are 4 Extra page menus, one each for Zones A, B, C and D.

## h. Zone Program Change

Each Zone contains a program change for the zone's MIDI channel that will be output when the patch containing the zone is selected. This program change may be displayed in a format most suited to the sound module being used.

### [Program type]

The Program Change display format allows the display of the Program Change number in a manner that best suits the display patch select method of the sound module being used. The Program Change number of the A-80's format and of the format type you have selected will both be displayed.

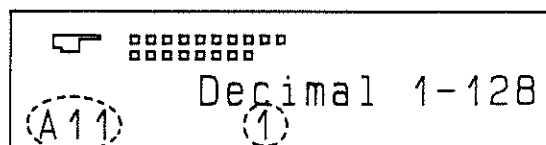

The Program Change number in A-80's format.  
The Program Change number in format type.

There are 9 different display types:

- GROUP A or B, BANK 1-8, NUMBER 1-8
- INTERNAL MEMORY or CARTRIDGE(CARD), BANK 1-8, NUMBER 1-8
- INTERNAL MEMORY or CARTRIDGE(CARD), BANK A-H, NUMBER 1-8
- GROUP A or B, NUMBER 1-16
- GROUP A or B, NUMBER 1-32
- INTERNAL MEMORY or CARTRIDGE(CARD), NUMBER 1-64
- NUMBER 1-128
- NUMBER 0-99
- HEXA DECIMAL 00h-7Fh

Zone Program type parameter can be set using a slider and/or Inc Dec buttons.

**Procedure to edit zone Program  
type parameter:**

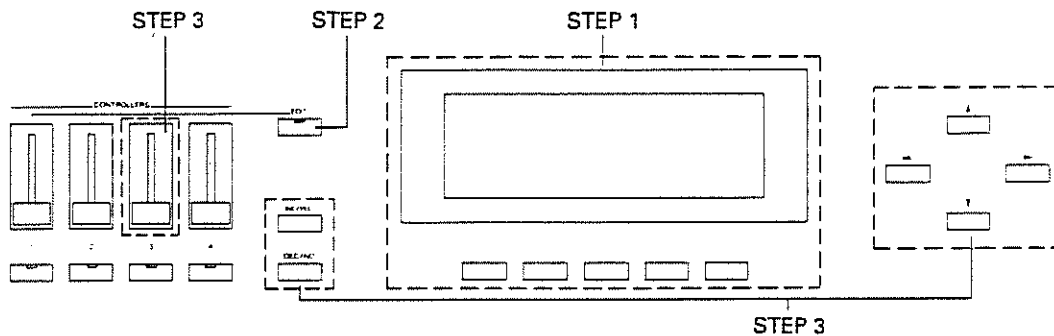

- STEP 1**    **Select the Extra menu's page to edit.**  
( ↪ Page 56 "Procedure to get to the Extra menu from the ROLAND menu; Procedure to select the Zone(page 45) to be edited")
  
- STEP 2**    **Press**  **.**  
(If the Memory Protect is ON ↪ Page 34 "Memory Protect ON/OFF")
  
- STEP 3**    **Select the type using slider 1.**  
-or-
  
- STEP 3**    **Move cursor to Program Type and press the**  **or**  **to change type.**
  
- STEP 4**    **Enter the PROGRAM CHANGE into the ZONE using the Patch Select buttons.**

**\* The selected Program Change is also output.**

**NOTE:**Be sure to select an appropriate Program Type so that Zone Program Change is displayed in the format that best suits the sound module being used.

## i. Zone Volume

This Volume message, scaled with any controller assigned as volume, will be sent on the Zones MIDI channel when the patch is selected.

### [Volume]

This parameter sets the zone's volume(0 to 127).

The volume message can be set using a slider and/or **INC** **DEC** .

### Procedure to edit zone

#### Volume message:

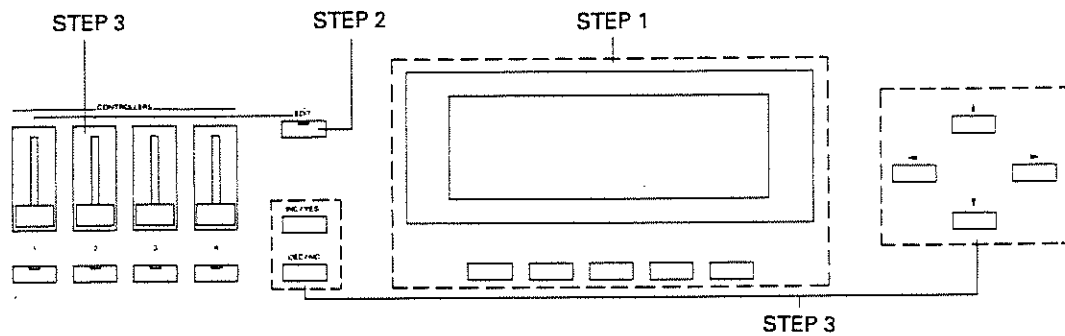

- STEP 1**    **Select the Extra menu's page to edit.**  
( ☞ Page 56 "Procedure to get to the Extra menu from the ROLAND menu; Procedure to select the Zone(page 45)to be edited")
- STEP 2**    **Press** **EDIT** .  
(If the Memory Protect is ON ☞ Page 34 "Memory Protect ON/OFF")
- STEP 3**    **Select the volume level using slider 2.**  
-or-
- STEP 3**    **Move cursor to Volume and press the** **INC** **or** **DEC** **to change Volume message.**

## j. Zone Modulation

This Modulation message, scaled with the current settings of the modulation wheel and bender, for the Zone will be sent when the patch is selected.

### [Mod]

This parameter sets the zone's modulation (0 to 127) .

The Modulation message can be set using a slider and/or **INC** **DEC** .

### Procedure to edit zone

#### Modulation message:

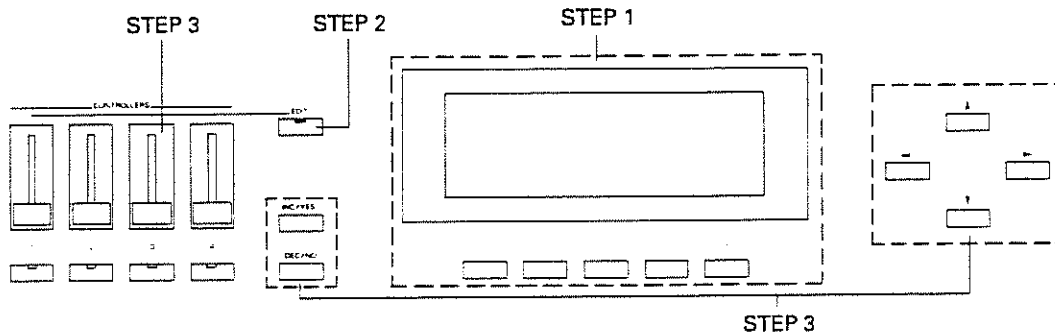

**STEP 1** Select the Extra menu's page to edit.  
(☞ Page 56 "Procedure to get to the Extra menu from the ROLAND menu; Procedure to select the Zone(page 45) to be edited")

**STEP 2** Press **EDIT** .  
(If the Memory Protect is ON ☞ Page 34 "Memory Protect ON/OFF")

**STEP 3** Set the Modulation value using slider 3.  
-or-

**STEP 3** Move cursor to Modulation message and press the **INC** or **DEC** to change Modulation message.

\* The Modulation from the A-50's bender and wheel are added together to produce the modulation message.

## k. Pitch Bend On/Off

Pitch Bend may be independently enabled for each Zone.

### [Bender]

The Pitch Bend message can be set using a slider and/or **INC** **DEC** .

### Procedure to edit zone Bend

#### ON/OFF:

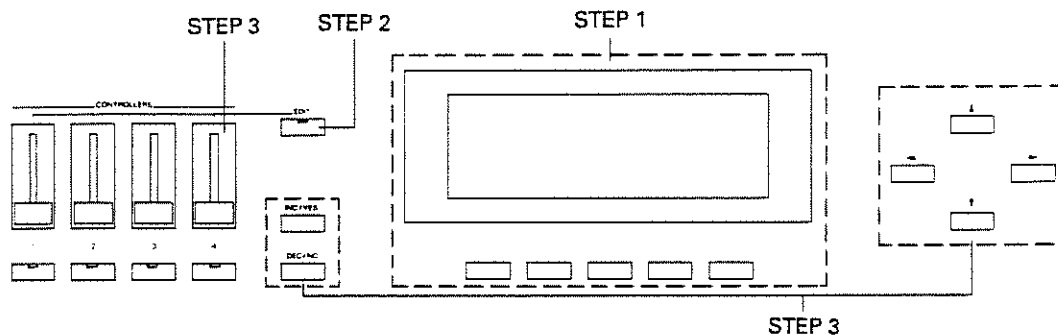

- STEP 1** Select the Extra menu's page to edit.  
(☞ Page 56 "Procedure to get to the Extra menu from the ROLAND menu; Procedure to select the Zone(page 45) to be edited")
- STEP 2** Press **EDIT** .  
(If the Memory Protect is ON ☞ Page 34 "Memory Protect ON/OFF")
- STEP 3** Set Bend ON/OFF using slider 4.  
-or-
- STEP 3** Move cursor to Bend and press the **INC** or **DEC** to select Bend ON or Bend OFF.

\* The A-80's pitch bender and wheel value are added together to produce the bend message.

## I. Switch Controller Definition

The four controller switches(1,2,3,4) may be assigned to any MIDI control message from 0 to 121. The switches are toggle ON(0) and toggle OFF(127) buttons. The button messages will be sent on the MIDI channel of the zone they are defined within. Each Zone (A,B,C,D) may define the controller independently, resulting in the sending of 4 different controller messages per controller if required. The names of defined controllers will be displayed along with the MIDI controller number. They may also be set to AUTO TUNE, OMNI ON, OMNI OFF, MONO ON OR POLY ON.

**Procedure to get to the Switch Assignment menu from the ROLAND menu:**

**STEP 1** Press **View** .

**STEP 2** Press **Zone** .

**STEP 3** Press **Curve** .

**STEP 4** Press **Switch** .

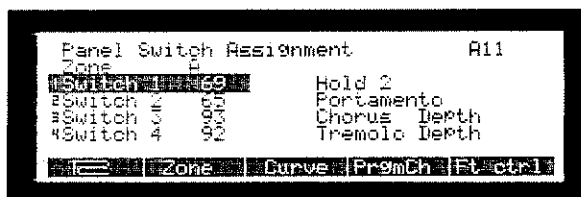

The zone switch definition can be set using a slider and/or **INC** **DEC** .

**Procedure to edit zone switch definition:**

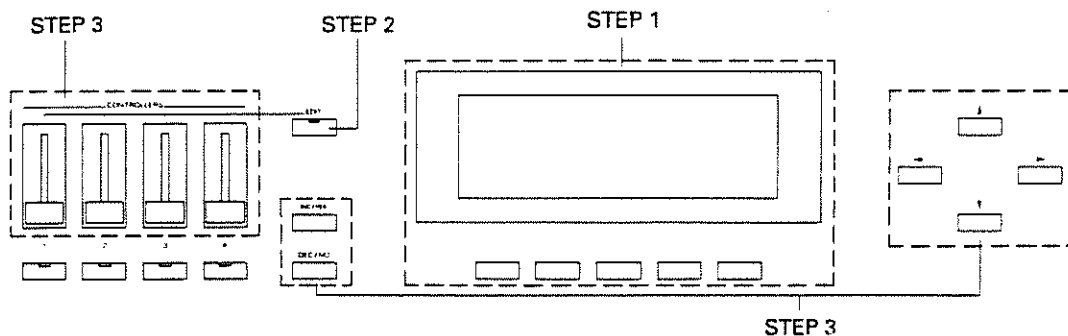

- STEP 1** Select the Switch Assignment menu's page to edit.  
("Procedure to get to the Switch Assignment menu from the ROLAND menu" ⇨ Page 45 "Procedure to select the Zone(page) to be edited")
- STEP 2** Press **EDIT** .  
(If the Memory Protect is ON ⇨ Page 34 "Memory Protect ON/OFF")
- STEP 3** Assign a controller with the corresponding switch's slider.  
-or-

**STEP 3** Move cursor to Button definition to edit, then press **INC** or **DEC** to select to assign the controller.

- \* The currently selected controller may also be set to the MIDI control message sent from a remote controller, connected to MIDI IN2(REMOTE).
- \* If any of two or more controllers are assigned to the same MIDI controller on the same MIDI channel, the last moved controller becomes the current value.

### m. Slider Controller Definition

The 4 slider controllers(1,2,3, and 4) may be assigned to any MIDI control message from 1 to 127. They can change the control level continuously from 0 to 127. Slider messages will be sent on the MIDI channel of the zone they are defined within. They may also be set to AUTO TUNE, OMNI, ON, OMNI, OFF, MONO ON and POLY ON. If they are set to volume or modulation, then the values set for modulation and volume on the Extras menu will be scaled by the settings of such set sliders, then output when the patch is selected. Only a slider that moves value is output. Each Zone(A,B,C, and D) may define the controller independently, resulting in the sending of 4 different controller messages per controller if required. The names of defined controllers will be displayed along with the MIDI controller number.

**Procedure to get to the Slider Assignment menu from the ROLAND menu:**

- STEP 1** Press **View** .
- STEP 2** Press **Zone** .
- STEP 3** Press **Curve** .
- STEP 4** Press **Sliders** .

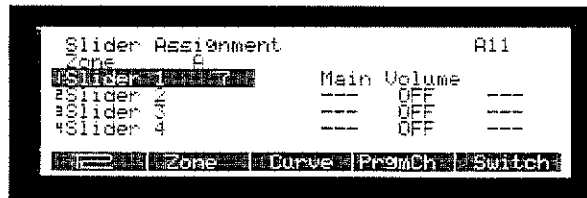

The zone slider definition can be set using a slider and/or **INC** **DEC** .

**Procedure to edit zone slider definition:**

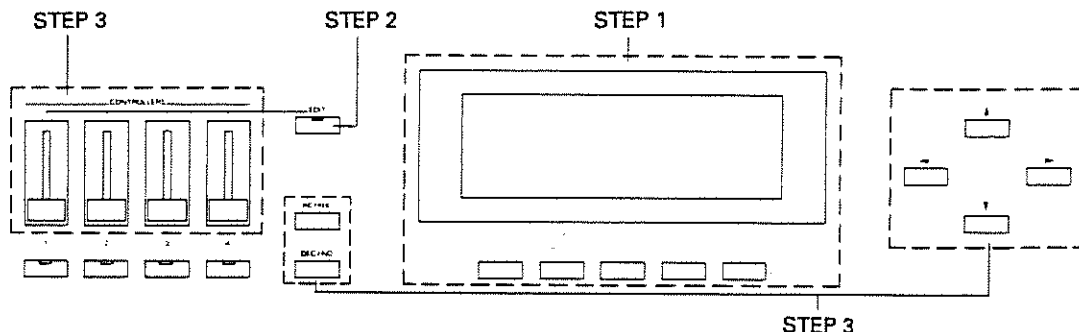

**STEP 1** Select the Slider Assignment menu's page to edit.  
 ("Procedure to get to the Slider Assignment menu from the ROLAND menu", ⇨ Page 45 "Procedure to select the Zone (page) to be edited")

**STEP 2** Press **EDIT** .  
 (If the Memory Protect is ON ⇨ Page 34 "Memory Protect ON/OFF")



STEP 3 Assign a controller with the corresponding slider.

-or-

STEP 3 Move cursor to Slider definition to edit, then press the **INC** or **DEC** to change the controller.

\* The currently selected controller may also be set to the MIDI control message received from a remote controller, connected to MIDI IN2(REMOTE)

\* If any of two or more controllers are assigned to the same MIDI controller on the same MIDI channel, the last moved controller becomes the current value.

## n. Foot Controller Definition

The A-80's 4 Foot Controller inputs can accept Roland Foot Switches(ON/OFF) or Continuous Volume pedals(EV-5). The 4 slider controllers(1,2,3, and 4) may be assigned to any MIDI control message from 1 to 121. Controller messages will be sent on the MIDI channel of the zone they are defined to. Each Zone (A,B,C, and D) may define the controller independently, resulting in the sending of 4 different controller messages per controller if required. The names of defined controllers will be displayed along with the MIDI controller number.

\* The Continuous Volume pedals allow for example "Continuous Damper" generation, while Foot Switches only allows ON/OFF control. They can also be set to AUTO TUNE, OMNI ON, OMNI OFF MONO ON and POLY ON.

Procedure to get to the Foot Controller Assignment menu from the ROLAND menu:

- STEP 1 Press **View** .
- STEP 2 Press **Zone** .
- STEP 3 Press **Curve** .
- STEP 4 Press **Ft ctrl** .

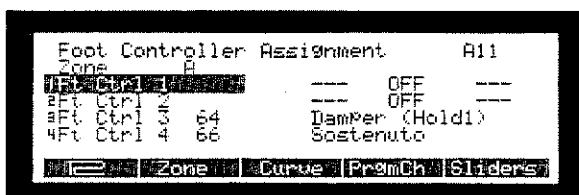

The zone foot controller definition can be set using a slider and/or **INC** **DEC** .

Procedure to edit zone foot controller definition:

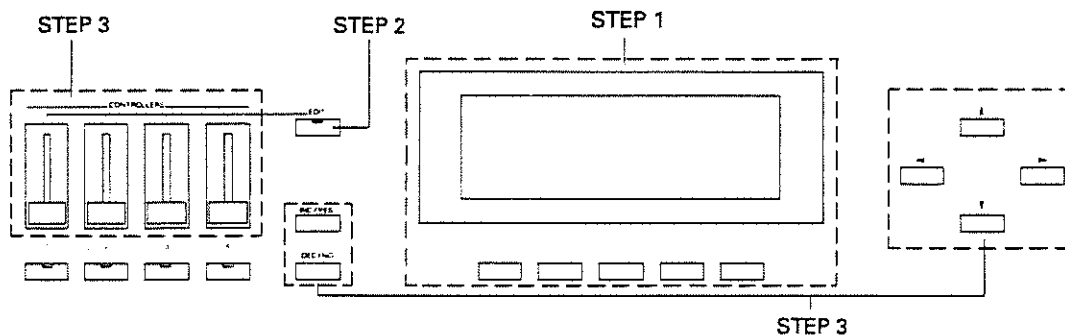

- STEP 1** Select the **Foot Controller Assignment** menu's page to edit.  
 ("Procedure to get to the Foot Controller Assignment menu from the ROLAND menu", ⇨ Page 45 "Procedure to select the Zone (page) to be edited")
- STEP 2** Press **EDIT** .  
 (If the Memory Protect is ON ⇨ Page 34 "Memory Protect ON/OFF")
- STEP 3** Assign a controller with the corresponding slider.  
 -or-
- STEP 3** Move cursor to Foot controller definition to edit, then press the **INC** or **DEC** to change the setting.
- \* The currently selected controller may also be set to the MIDI control message received from a remote controller, connected to MIDI IN2(REMOTE)
  - \* If any of two or more controllers are assigned to the same MIDI controller on the same MIDI channel, the last moved controller becomes the current value.

## 4. Channel

The 16 MIDI channels may be assigned 10 character names. The A-80 displays all MIDI channel reference(2 pages) via this name.

Procedure to get to the MIDI Channel Catalog menu from the ROLAND menu:

- STEP 1** Press **View** .
- STEP 2** Press **Zone** .
- STEP 3** Press **Ch. Name** .
- STEP 4** Press **Chanl** .

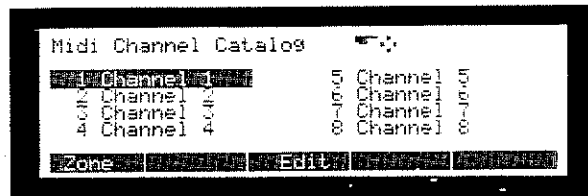

### a. MIDI Channel Catalog

Select the MIDI channel name to edit.

Procedure to select the channel name to be edited:

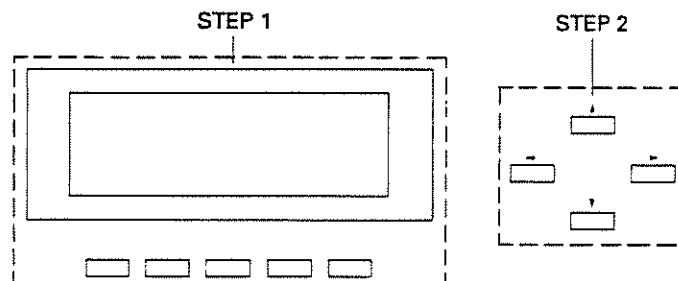

- STEP 1**    **Select the Channel Catalog menu.**  
 ( ⇨ Page 64 "Procedure to get to the MIDI Channel Catalog menu from the ROLAND menu")
- STEP 2**    **Move cursor to the relevant MIDI channel, then select the channel name to be edited.**

## b. Editing the Channel Name

Procedure to edit the MIDI channel name you have selected:

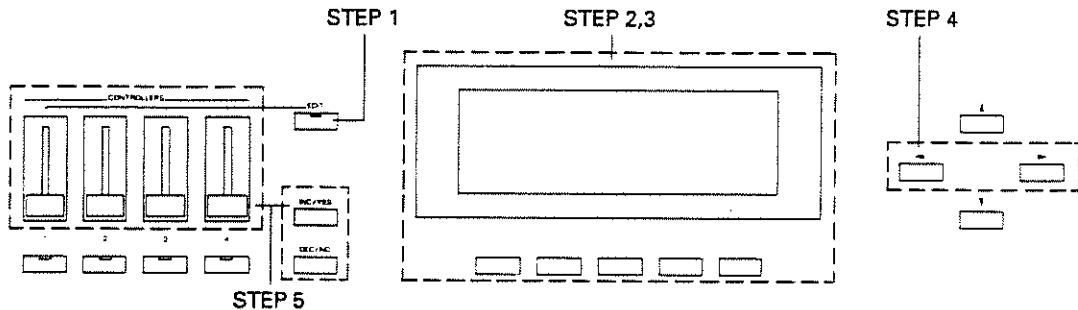

- STEP 1**    **Press** **EDIT** .  
 (If the Memory Protect is ON ⇨ Page 34 "Memory Protect ON/OFF")
- STEP 2**    **Select the Channel Catalog menu.**  
 ( ⇨ "Procedure to get to the Channel Name menu from the ROLAND menu")
- STEP 3**    **Press** **Edit** .  
 The Edit Channel Name menu is selected.

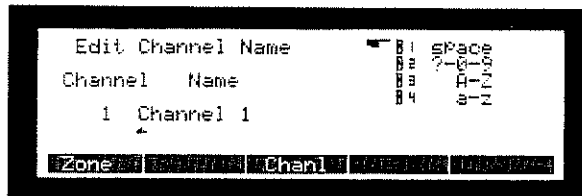

- STEP 4**    **Press cursor buttons** **◀** **▶** **to select the character to be changed.**
- STEP 5**    **Change current character with the sliders or** **INC** / **DEC** .  
 The sliders have the following meaning in name editing.

Slider-1	Space
Slider-2	!"#\$%&'()+,.-/0123456789;(:=?
Slider-3	A B C D E F G H I J K L M N O P Q R S T U V W X Y Z
Slider-4	a b c d e f g h i j k l m n o p q r s t u v w x y z

# [3] CHAINS

A CHAIN consists of up to 32 Patches linked together. Chains have a 16 character name and a 32 character comment. The comment is used to indicate the purpose of the chain.

## 1. Chain Catalog

Procedure to get to the Chain menu from the ROLAND menu:

STEP 1 Press **Chain** .



This menu is a Catalog of current Chains.

There are 4 pages(1 for each Bank) with 8 entries(1 for each group of 8).

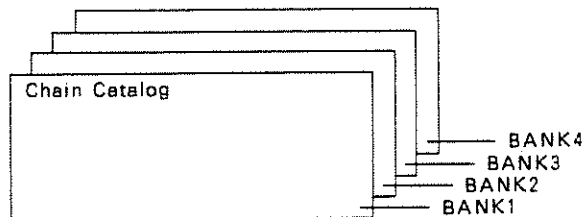

The currently selected CHAIN is reversed. Its number is displayed at the top of the screen.

The CHAIN may also be selected with the Patch selector buttons or via Program Change messages from IN2(REMOTE) MIDI IN if the CHAIN button is ON.(Valid Chain numbers are Group A, Bank 1 - 4, Number 1 - 8. Numbers outside this range are truncated to select a chain in this range.

## a. Edit CHAIN Name/Comment

Procedure to get to the Chain  
Edit menu from the ROLAND  
menu:

STEP 1 Press **Chain** .

STEP 2 Press **Edit** .

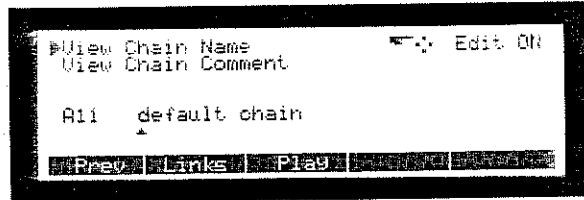

Chains have names of up to 16 characters.

Procedure to edit Chain  
name or comment:

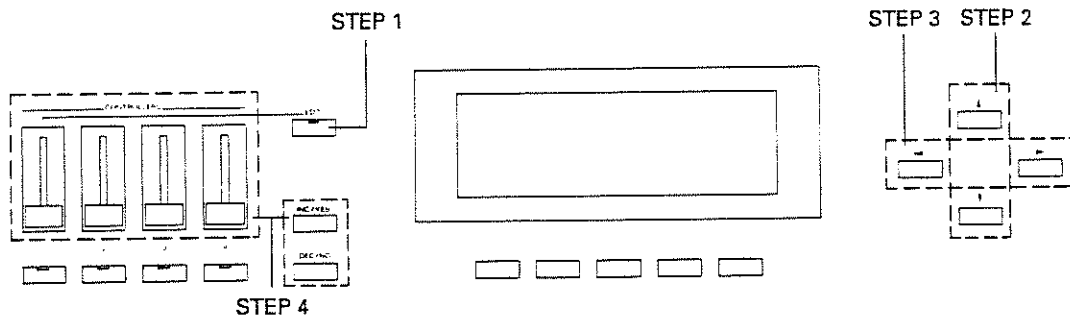

STEP 1 Press **EDIT** .  
(If the Memory Protect is ON → Page 34 "Memory Protect ON/OFF")

STEP 2 Select name or comment with **▲** **▼** .  
The Chain's name or comment will be indicated.

STEP 3 Press the cursor buttons **◀** **▶** to select the character.

STEP 4 Press **INC** or **DEC** or use the sliders to change current  
character.

The sliders have the following meaning in name and comment  
editing.

Slider-1	Space
Slider-2	!"#\$%&'()*+,-./0123456789;(<=>?
Slider-3	ABCDEFGHIJKLMNOPQRSTUVWXYZ
Slider-4	abcdefghijklmnopqrstuvwxyz

## b. Edit Chain Links

The Chain consists of up to 32 patches. Each link in the Chain is a Patch number.

### Procedure to get to the Chain

Link Edit menu from the

Roland menu:

STEP 1 Press **Chain** .

STEP 2 Press **Edit** .

STEP 3 Press **Links** .

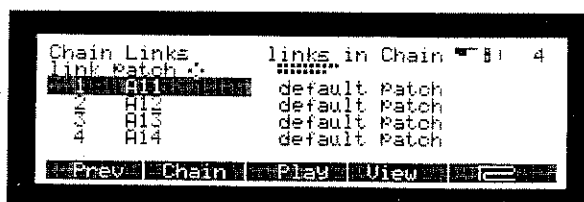

### Procedure for editing Chain Links:

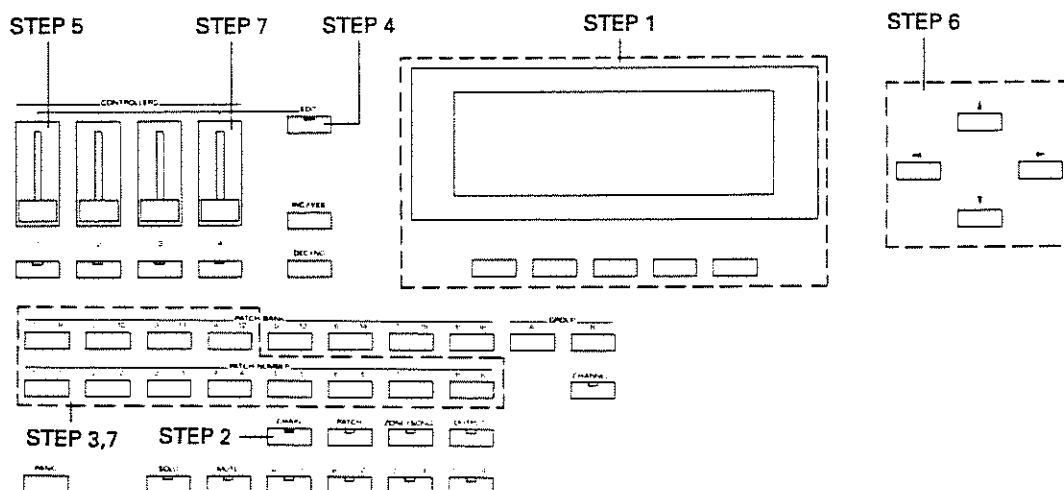

STEP 1 Select the Chain Link menu.

( ☞ "Procedure to get to the Chain Link menu from the ROLAND menu" )

STEP 2 Set the **CHAIN** to ON.

STEP 3 Select the CHAIN to edit with Patch selector buttons.

STEP 4 Press **EDIT** .

(If the Memory Protect is ON ☞ Page 34 "Memory Protect ON/OFF")

STEP 5 Set the number of links in the CHAIN with slider 1 or use the **INC** **DEC** .

STEP 6 Select the link to change with the cursor buttons. **▼** **▲**

STEP 7 Select PATCH number with **PATCH** (GROUP, BANK, NUMBER).

-OR-

STEP 7 Select Patch number using slider 4.

## 2. PLAY Chain

Procedure to get to the Chain Play menu from the ROLAND menu:

STEP 1 Press **Chain** .

STEP 2 Press **Play** .

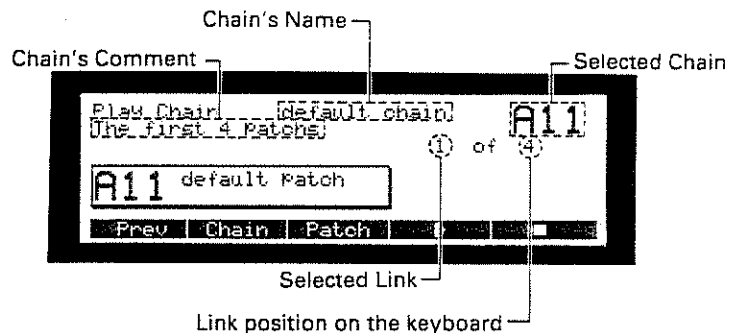

\* The Chain is reset to the first link when it is selected.

The Chain may be changed with the Patch selector buttons (valid range : Group A, Bank 1 - 4, Number 1 - 8) if **CHAIN** is ON.

The link (i.e.PATCH) may be stepped forward with or backward with . It also can be stepped forward with the DOWN foot switch or back ward with the UP foot switch.

### Chain Link Preserve Function :

The CHAIN will not step while there are notes still down or Hold is on. This allows you to select the next patch without changing sounds until releasing all notes and hold off.

### The START and STOP messages:

The MIDI Start message will be sent when the is pressed.

The MIDI Stop message will be sent when the is pressed.

\* The recognition of the START and STOP messages is dependent on the MIDI implementation of the sequencer used.

\* The MIDI clock message isn't sent from A-80, unless it is input from MIDI in1.

# [4] EDIT MIDI OPTIONS

The MIDI function data you have set will be retained even after the unit is switched off .

## 1. Program Change Receive Channel ON/OFF

The A-80 may have the MIDI channel set or disabled(none) for the Receiving of Patch Change messages from MIDI IN 1 . (Default : none)

**Procedure to get to the MIDI menu from the ROLAND menu:**

- STEP 1 Press **Utilit** .
- STEP 2 Press **Midi** .

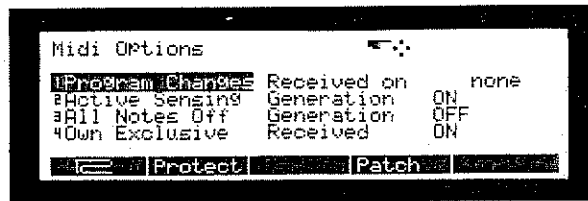

**To edit Receive channel for Program Changes:**

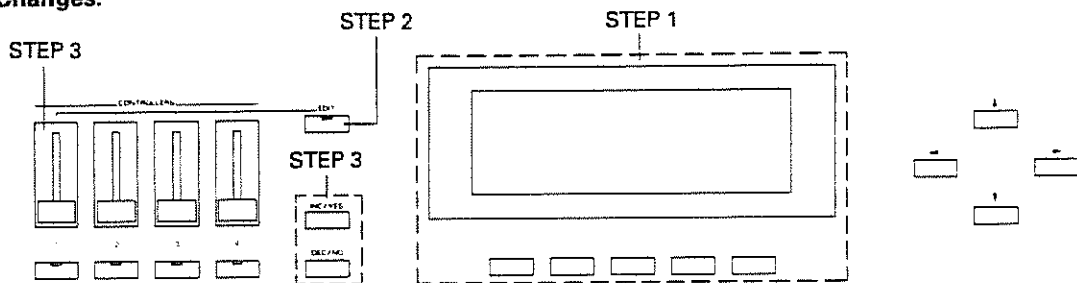

- STEP 1 **Select the MIDI menu.**  
( ☞ "Procedure to get to the MIDI menu from the ROLAND menu")
- STEP2 Press **EDIT** .(If the Memory Protect is ON ☞ Page 34 "Memory Protect ON/OFF")
- STEP 3 **Use slider 1 to change or disable the Receive channel number.**  
-or-
- STEP 3 Press **INC** or **DEC** to change or disable the Receive channel number.

- \* "none" means Program changes will not be recognized from MIDI IN1.
- \* Program changes are always recognized from IN2(REMOTE) MIDI IN on any MIDI channel.



## 2. Active Sensing ON/OFF

The A-80 may have Active Sensing generation and checking, set(ON) or disabled(OFF).(Default : ON)

**Procedure to select Active Sensing ON or OFF:**

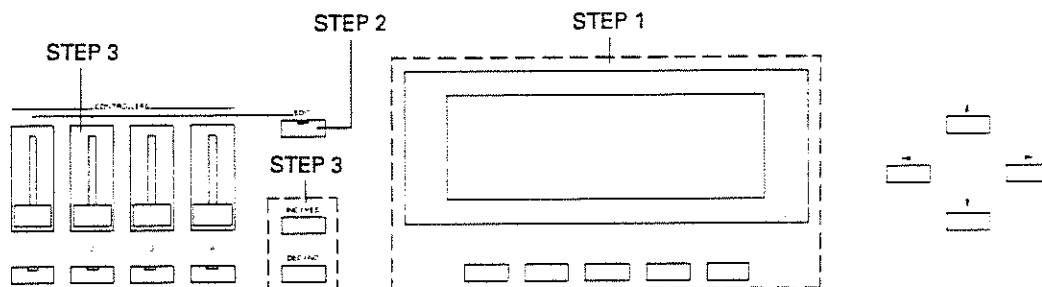

- STEP 1** Select the MIDI menu.  
(☞ "Procedure to get to the MIDI menu from the ROLAND menu")
- STEP 2** Press **EDIT** .  
(If the Memory Protect is ON ☞ Page 34 "Memory Protect ON/OFF")
- STEP 3** Use slider 2 to set ON/OFF.  
-or-
- STEP 3** Press **INC** or **DEC** to set ON/OFF.

## 3. All Notes Off ON/OFF

The A-80 may have ALL NOTES OFF generation enabled(ON). When ALL NOTES OFF is disabled(OFF), the ALL NOTES OFF message is not output when all notes on the A-80 are OFF.

**Procedure to select ALL NOTES OFF ON/OFF:**

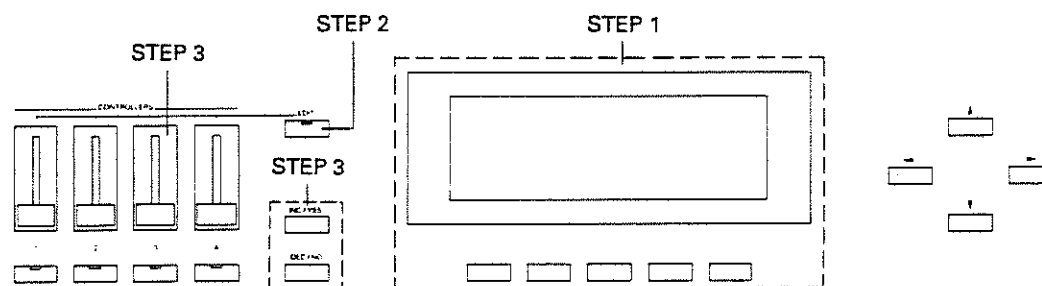

- STEP 1** Select the MIDI menu.  
(☞ "Procedure to get to the MIDI menu from the ROLAND menu")
- STEP 2** Press **EDIT** .  
(If the Memory Protect is ON ☞ Page 34 "Memory Protect ON/OFF")
- STEP 3** Use slider 3 to set ON/OFF.  
-or-
- STEP 3** Press **INC** or **DEC** to set ON/OFF.

## 4. Exclusive Receive ON/OFF

The A-80 may disable the Receiving of A-80 System Exclusive from MIDI IN 1.

### Procedure to select Exclusive

#### Receive ON/OFF:

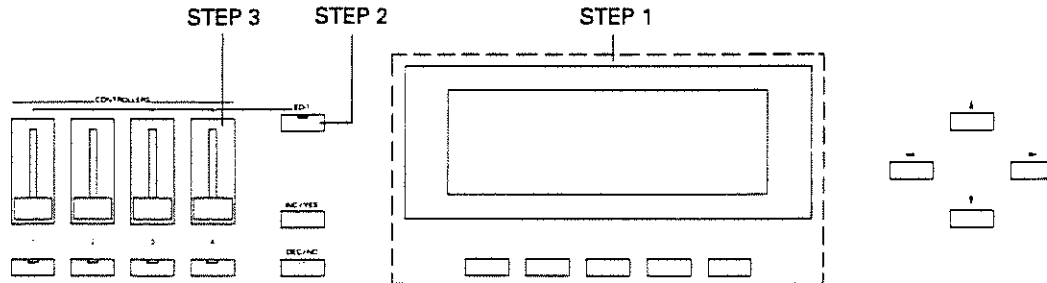

- STEP 1** Select the MIDI menu.  
(☞ "Procedure to get to the MIDI menu from the ROLAND menu")
- STEP 2** Press **EDIT** .  
(If the Memory Protect is ON ☞ Page 34 "Memory Protect ON/OFF")
- STEP 3** Use slider 4 to set ON/OFF.  
-OR-
- STEP 3** Press **INC** or **DEC** to set ON/OFF.

## 2. SAVE

### a. Saving A-80 memory to RAM CARD

SAVE, saves the contents of the A-80 onto the 32k byte RAM card(M-256D, M-256E: optional).

The previous contents of the RAM card is lost.

The entire A-80 memory is SAVED. Patches or Chains may not be individually saved.

**Procedure to save onto a RAM card:**

**STEP 1** Press **Utilit** in the ROLAND menu.

**STEP 2** Insert a memory card into the card slot.

**STEP 3** Turn RAM card protect switch to OFF.

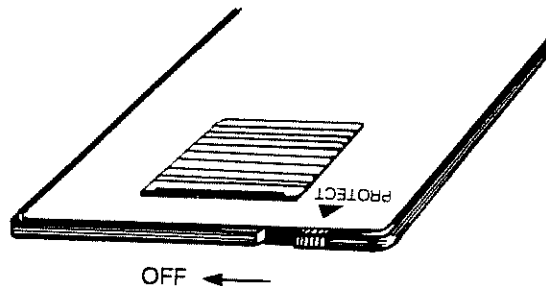

**STEP 4** Select the SAVE menu.

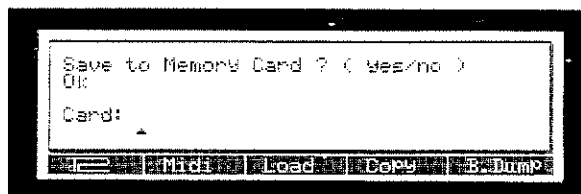

**STEP 5** To "OK" press **YES** .  
(Entering **NO** at any prompt will go back to "OK")

**STEP 6** To "Are you sure ?" press **YES** .  
Now the entire data is saved onto the card.

**STEP 7** Return RAM card protect switch to ON.

# [5] UTILITIES

## 1. LOAD

### a. Loading A-80 memory from RAM CARD

Load, loads the contents of the 32k byte RAM card(M-256D, M-256E: optional) into the A-80. The previous contents of the A-80 memory is lost. The entire A-80 memory is LOADED. Patches or Chains may not be individually loaded.

- \* To use a brand new memory card, first save the entire data in the A-80 onto the card.
- \* The RAM card is for A-80 backup only. It does not increase the number of simultaneously available Patches or Chains.

Patches or Chains.

Procedure to load from  
the RAM card:

**STEP 1** Insert the memory card into the card slot.

- \* An "Illegal Card" message indicates that the RAM card has data saved by a device other than the A-80, or that the card has not had any data saved to it previously. Replace it with a proper card.

**STEP 2** Press **Utilit** in the ROLAND menu.

**STEP 3** Press **Load** .

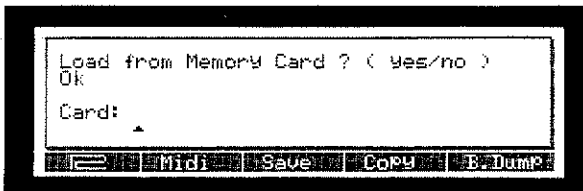

**STEP 4** To "OK" press **YES** .  
(Entering "No" at any prompt will go back to "OK")

**STEP 5** To "Are you sure ?" press **YES** .

Now the entire data is loaded into the A-80.

## b. Editing RAM Card Name

The RAM Card may be given a name up to 16 characters long.

**Procedure to edit RAM card name:**

- STEP 1** Insert the RAM card into the card slot.
- STEP 2** Select the SAVE or LOAD menu.  
(☞ Page 73 "1.LOAD", ☞ Page 74 "2.SAVE")
- STEP 3** Turn RAM card protect switch OFF.
- STEP 4** Press **EDIT** .  
  
(If the Memory Protect is ON ☞ Page 34 "Memory Protect ON/OFF")  
The RAM card's name will be indicated.
- STEP 5** Press the cursor buttons **◀** **▶** to select the character.
- STEP 6** With the sliders or **INC** **DEC** , change current character.  
  
The sliders have the following meaning in name editing.

Slider-1	Space
Slider-2	!"#\$%&'()+,-./0123456789;(:=?
Slider-3	ABCDEFGHIJKLMNOPQRSTUVWXYZ
Slider-4	abcdefghijklmnopqrstuvwxyz

- STEP 7** Turn RAM card protect switch ON again.

### 3. Data Transfer via MIDI

Using the Roland System Exclusive messages, the A-80's data can be transferred to another A-80 or MIDI sequencer, etc. The A-80's data transfer is performed in a One Way method that transmits data without confirming the status of the receiver.

#### a. Data Transfer to a MIDI sequencer(Bulk Dump)

Use One-way setups.

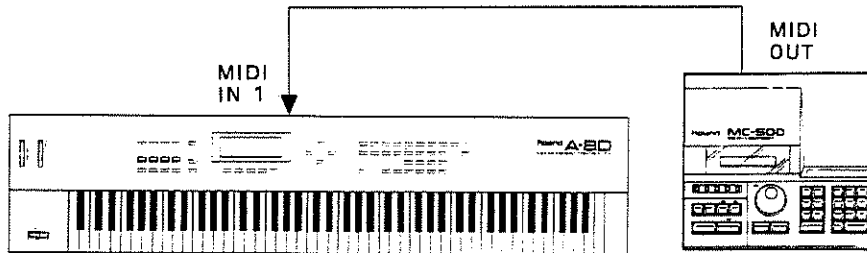

**Procedure to dump  
the A-80's memory:**

**STEP 1** Press Utility menu in the ROLAND menu.

**STEP 2** Press **B. Dump** .

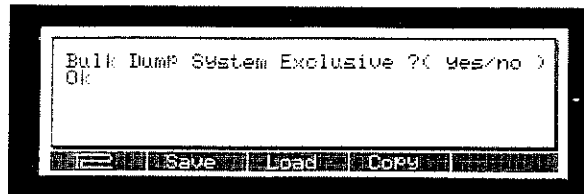

**STEP 3** To "OK" press **YES** .  
(Entering **NO** at any prompt will go back to "OK")

**STEP 4** To "Are you sure ?" press **YES** .

The data will be sent out to the currently enable MIDI outputs.

\* The Dump will take several seconds.

## b.Data Transfer from a MIDI sequencer(Bulk Load)

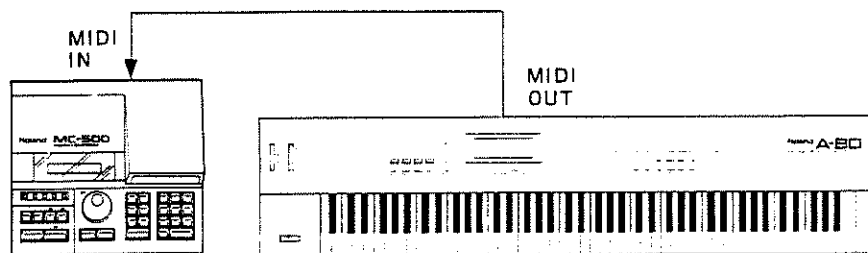

### Procedure for loading Exclusive data:

The transfer procedure is controlled from the transmitting side. You do not need to operate the receiving A-80. However, to receive its own Bulk data, the A-80 must be set to recognize the System Exclusive from MIDI IN 1. (☞ Page 72 "Exclusive Receive ON/OFF")

\* There is no Load Bulk Dump menu as this is handled automatically.

The receiving A-80 will display "Exclusive Loaded" at the completion of the dump if no error occurred. An appropriate error message will appear indicating the location of the data error:

"Error in Chan.Name" : the error occurred in an Exclusive block describing the assigned MIDI channel names.

"Error in Chain Load" : the error occurred in an Exclusive block describing the Chains.

"Error in Patch Load" : the error occurred in an Exclusive block describing the 64 A-80 Patches.

"Error in Bulk Library" : the error occurred in an Exclusive block describing the Bulk Library data.

# [6] Default Settings

## Patch

Patch Name : default patch  
Zone A B C D : 0  
From key : 0  
To key : 127  
Zone Mute : B C D

## Chain

Chain Name : default chain  
Chain Comment : The first 4 Patches

## Edit

Memory Protect : ON

## Channel Name

Channel 1  
Channel 2  
Channel 3  
:  
:  
:  
Channel 16

## Foot Controller

FC1 : —OFF—  
FC2 : —OFF—  
FC3 : Damper  
FC4 : Sostenuuto

## Slider Controller

SL1 : Zone A Volume  
SL2 : Zone B Volume  
SL3 : Zone C Volume  
SL4 : Zone D Volume

## Switch Controller

SW1 : Hold ON/OFF  
SW2 : Portament ON/OFF  
SW3 : Chorus ON/OFF  
SW4 : Tremolo ON/OFF

## Effector Program Change

Effector Program Change : —OFF—

## MIDI options

Program ChangeReceive : none  
Active Sensing : ON  
All Note off : OFF  
System Exclusive : ON



# Reference

[1] Troubleshooting .....	80
[2] Appendix Tables .....	81

# [1] Troubleshooting

If the A-80 does not respond as you expect, Check as follows:

## ■ If the A-80 does not make any sound:

- Is a note being played within any Zone?  
(☞P46 "Zone position")
- Is the Zone being played muted?  
(☞P28 "ZONE SOLO/MUTE")
- Is the output socket connected to the sound module muted?  
(☞P29 "OUTPUT socket SOLO/MUTE")
- Is the Zone set to a different MIDI channel from the sound module?  
(☞P48 "MIDI Channel")
- Is the volume within the Zone set to zero?  
(☞P58 "Zone Volume")
- Is the controller where the volume function is assigned set to zero?  
(☞P61 "Switch Controller Definition")  
(☞P62 "Slider Controller Definition")  
(☞P63 "Foot Controller Definition")
- Is the Zone set out of the range of the actual keyboard?  
(☞P20 "View")  
(☞P46 "ZONE position")
- Is Edit on and the cursor on "TO KEY" or "FROM KEY"?  
(☞P47 "Procedure to edit Zone position using the Inc Dec buttons")
- Has the Zone been transposed out of the range accepted by the sound module?  
(☞P49 "Transpose")

## ■ PATCH cannot be changed:

- Is the Hold Pedal on or any key being played?  
(☞P23 "PATCH selection")

## ■ Zone or Output will not mute:

- Is the Hold Pedal on or any key being played?  
(☞P28 "ZONE SOLO/MUTE")  
(☞P29 "OUTPUT socket SOLO/MUTE")

## ■ The sound will not stop:

- Is the MIDI cable disconnect from the socket?  
(☞P31 "ALL NOTE OFF(PANIC button)")

## ■ The pitch raised by the Pitch Bend will not be returned to the normal:

- Is the MIDI cable disconnected from the socket?  
(☞P31 "ALL NOTE OFF(PANIC button)")

## ■ The Control Change set with a slider will not be edited:

- Is the Edit on?  
(☞P35 "EDIT ON/OFF")

## ■ The A-80's PATCH or CHAIN changes seem very slow:

- Does the PATCH contain a large amount of System Exclusive data?  
(☞P23 "PATCH selection")

## [2] Appendix Tables

Patch Parameters Chart		RAM Card Name	
Patch #		Date	
Name		Output Muting	
		[1]	[2] [3] [4]
Zone	A	B	C D
Muting	[Muted]	[Muted]	[Muted]
From key #			
To Key #			
Channel #			
Transpose			
Velocity	Curve		
	Scale		
	Offset		
	Holdoff		
Aftertouch	Curve		
	Scale		
	Holdoff		
	Type	[P] [C] [OFF]	[P] [C] [OFF]
Slider Control	1		
	2		
	3		
	4		
Switch Control	1		
	2		
	3		
	4		
Foot Control	1		
	2		
	3		
	4		
Effect Program Change 1		Channel	Patch
Effect Program Change 2		Channel	Patch
Effect Program Change 3		Channel	Patch
Effect Program Change 4		Channel	Patch

P = Polyphonic Aftertouch  
 C = Channel Aftertouch

Chain Parameters Chart

		RAM Card Name	
Chain #		Date	
Name			
Comment			
Number of Links			
Link	Patch #	Patch Name	
1			
2			
3			
4			
5			
6			
7			
8			
9			
10			
11			
12			
13			
14			
15			
16			
17			
18			
19			
20			
21			
22			
23			
24			
25			
26			
27			
28			
29			
30			
31			
32			

Channel Name Assignment		RAM Card Name
MIDI Channel #	Assigned Name	
1		
2		
3		
4		
5		
6		
7		
8		
9		
10		
11		
12		
13		
14		
15		
16		
Receive Program Change #		
Active Sensing Generation		[ON] [OFF]
All Notes Off Generation		[ON] [OFF]
Exclusive Receive		[ON] [OFF]



# Roland Exclusive Messages

## 1. Data Format for Exclusive Messages

Roland's MIDI implementation uses the following data format for all exclusive messages (type IV):

Byte	Description
F0H	Exclusive status
41H	Manufacturer ID (Roland)
DEV	Device ID
MDL	Model ID
CMD	Command ID
[BODY]	Main data
F7H	End of exclusive

### # MIDI status : F0H, F7H

An exclusive message must be flanked by a pair of status codes, starting with a Manufacturer-ID immediately after F0H (MIDI version 1.0).

### # Manufacturer-ID : 41H

The Manufacturer-ID identifies the manufacturer of a MIDI instrument that triggers an exclusive message. Value 41H represents Roland's Manufacturer-ID.

### # Device-ID : DEV

The Device-ID contains a unique value that identifies the individual device in the multiple implementation of MIDI instruments. It is usually set to 00H - 0FH, a value smaller by one than that of a basic channel, but value 00H - 1FH may be used for a device with multiple basic channels.

### # Model-ID : MDL

The Model-ID contains a value that uniquely identifies one model from another. Different models, however, may share an identical Model-ID if they handle similar data.

The Model-ID format may contain 00H in one or more places to provide an extended data field. The following are examples of valid Model-IDs, each representing a unique model:

01H  
02H  
03H  
00H, 01H  
00H, 02H  
00H, 00H, 01H

### # Command-ID : CMD

The Command-ID indicates the function of an exclusive message. The Command-ID format may contain 00H in one or more places to provide an extended data field. The following are examples of valid Command-IDs, each representing a unique function:

01H  
02H  
03H  
00H, 01H  
00H, 02H  
00H, 00H, 01H

### # Main data : BODY

This field contains a message to be exchanged across an interface. The exact data size and contents will vary with the Model-ID and Command-ID.

## 2. Address-mapped Data Transfer

Address mapping is a technique for transferring messages conforming to the data format given in Section 1. It assigns a series of memory-resident records--waveform and tone data, switch status, and parameters, for example--to specific locations in a machine-dependent address space, thereby allowing access to data residing at the address a message specifies.

Address-mapped data transfer is therefore independent of models and data categories. This technique allows use of two different transfer procedures: one-way transfer and handshake transfer.

### # One-way transfer procedure (See Section 3 for details)

This procedure is suited for the transfer of a small amount of data. It sends out an exclusive message completely independent of a receiving device status.

Connection Diagram

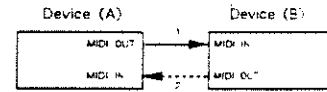

Connection at point 2 is essential for "Request data" procedures. (See Section 3.)

### # Handshake-transfer procedure (See Section 4 for details)

This procedure initiates a predetermined transfer sequence (handshaking) across the interface before data transfer takes place. Handshaking ensures that reliability and transfer speed are high enough to handle a large amount of data.

Connection Diagram

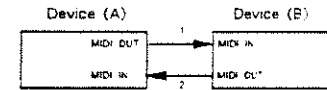

Connection at points 1 and 2 is essential.

### Notes on the above two procedures

- \*There are separate Command-IDs for different transfer procedures.
- \*Devices A and B cannot exchange data unless they use the same transfer procedure, share identical Device-ID and Model-ID, and are ready for communication.

## 3. One-way Transfer Procedure

This procedure sends out data all the way until it stops when the messages are so short that answerbacks need not be checked.

For long messages, however, the receiving device must acquire each message in time with the transfer sequence, which inserts intervals of at least 20 milliseconds in between.

### Types of Messages

Message	Command ID
Request data # 1	RQ1 (11H)
Data set # 1	DT1 (12H)

### # Request data # 1 : RQ1 (11H)

This message is sent out when there is a need to acquire data from a device at the other end of the interface. It contains data for the address and size that specify designation and length, respectively, of data required.

On receiving an RQ1 message, the remote device checks its memory for the data address and size that satisfy the request.

If it finds them and is ready for communication, the device will transmit a "Data set # 1 (DT1)" message, which contains the requested data. Otherwise, the device will send out nothing.

Byte	Description
F0H	Exclusive status
41H	Manufacturer ID (Roland)
DEV	Device ID
MDL	Model ID
11H	Command ID
aaH	Address MSB
⋮	⋮
⋮	LSB
sgH	Size MSB
⋮	⋮
⋮	LSB
sum	Check sum
F7H	End of exclusive





# Request data : RQD (41H)

This message is sent out when there is a need to acquire data from a device at the other end of the interface. It contains data for the address and size that specify designation and length, respectively, of data required.

On receiving an RQD message, the remote device checks its memory for the data address and size which satisfy the request. If it finds them and is ready for communication, the device will transmit a "Data set (DAT)" message, which contains the requested data. Otherwise, it will return a "Rejection (RJC)" message.

Byte	Description
F0H	Exclusive status
41H	Manufacturer ID (Roland)
DEV	Device ID
MDL	Model ID
41H	Command ID
aaH	Address MSB
⋮	⋮
	LSB
ssH	Size MSB
⋮	⋮
	LSB
sum	Check sum
F7H	End of exclusive

\*The size of the requested data does not indicate the number of bytes that make up a "Data set (DAT)" message, but represents the address fields where the requested data resides.

\*Some models are subject to limitations in data format used for a single transaction. Requested data, for example, may have a limit in length or must be divided into predetermined address fields before it is exchanged across the interface.

\*The same number of bytes comprises address and size data, which, however, vary with the Model-ID.

\*The error checking process uses a checksum that provides a bit pattern where the least significant 7 bits are zero when values for an address, size, and that checksum are summed.

# Data set : DAT (42H)

This message corresponds to the actual data transfer process. Because every byte in the data is assigned a unique address, the message can convey the starting address of one or more data as well as a series of data formatted in an address-dependent order.

Although the MIDI standards inhibit non-real time messages from interrupting an exclusive one, some devices support a "soft-through" mechanism for such interrupts. To maintain compatibility with such devices, Roland has limited the DAT to 256bytes so that an excessively long message is sent out in separate segments.

Byte	Description
F0H	Exclusive status
41H	Manufacturer ID (Roland)
DEV	Device ID
MDL	Model ID
42H	Command ID
aaH	Address MSB
⋮	⋮
	LSB
ddH	Data
⋮	⋮
sum	Check sum
F7H	End of exclusive

\*A DAT message is capable of providing only the valid data among those specified by an RQD or WSD message.

\*Some models are subject to limitations in data format use for a single transaction. Requested data, for example, may have a limit in length or must be divided into predetermined address fields before it is exchanged across the interface.

\*The number of bytes comprising address data varies from one model ID to another.

\*The error checking process uses a checksum that provides a bit pattern where the least significant 7 bits are zero when values for an address, size, and that checksum are summed.

# Acknowledge : ACK (43H)

This message is sent out when no error was detected or reception of a WSD, DAT, "End of data (EOD)", or some other message and a requested setup or action is complete. Unless it receives an ACK message, the device at the other end will not proceed to the next operation.

Byte	Description
F0H	Exclusive status
41H	Manufacturer ID (Roland)
DEV	Device ID
MDL	Model ID
43H	Command ID
F7H	End of exclusive

# End of data : EOD (45H)

This message is sent out to inform a remote device of the end of a message. Communication, however, will not come to an end unless the remote device returns an ACK message even though an EOD message was transmitted.

Byte	Description
F0H	Exclusive status
41H	Manufacturer ID (Roland)
DEV	Device ID
MDL	Model ID
45H	Command ID
F7H	End of exclusive

# Communications error : ERR (4EH)

This message warns the remote device of a communication fault encountered during message transmission due, for example, to a checksum error. An ERR message may be replaced with a "Rejection (RJC)" one, which terminates the current message transaction in midstream.

When it receives an ERR message, the sending device may either attempt to send out the last message a second time or terminate communication by sending out an RJC message.

Byte	Description
F0H	Exclusive status
41H	Manufacturer ID (Roland)
DEV	Device ID
MDL	Model ID
4EH	Command ID
F7H	End of exclusive

# Rejection : RJC (4FH)

This message is sent out when there is a need to terminate communication by overriding the current message. An RJC message will be triggered when :

- a WSD or RQD message has specified an illegal data address or size,
- the device is not ready for communication,
- an illegal number of addresses or data has been detected,
- data transfer has been terminated by an operator,
- a communications error has occurred.

An ERR message may be sent out by a device on either side of the interface. Communication must be terminated immediately when either side triggers an ERR message.

Byte	Description
FOH	Exclusive status
41H	Manufacturer ID (Roland)
DEV	Device ID
MDL	Model ID
4FH	Command ID
F7H	End of exclusive

# Example of Message Transactions

● Data transfer from device (A) to device (B).

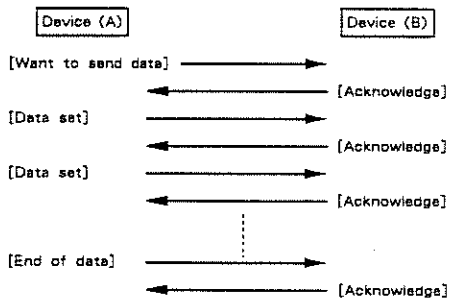

● Device (A) requests and receives data from device (B).

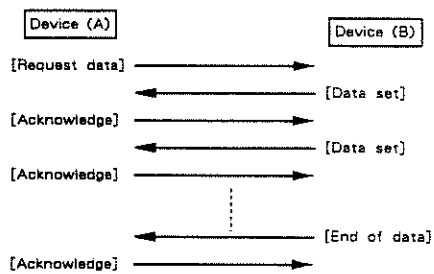

● Error occurs while device (A) is receiving data from device (B).

1) Data transfer from device (A) to device (B).

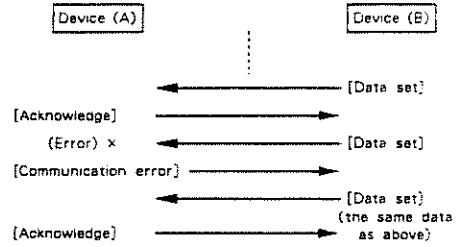

2) Device (B) rejects the data re-transmitted, and quits data transfer.

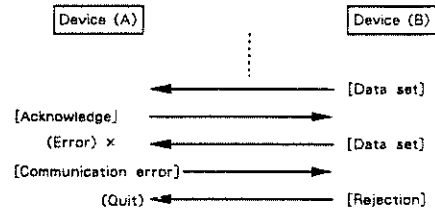

3) Device (A) immediately quits data transfer.

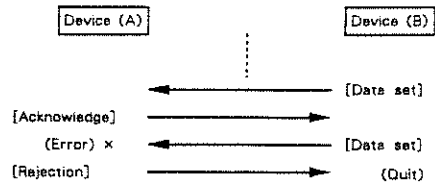

**1. TRANSMITTED DATA**

■ Note event

Note off

Status	Second	Third
9nH	kkH	00H

kk = Note number 17H - 67H ( 21 - 108 )  
 n = MIDI Channel 0H - FH ( 0 - 15 )

Note on

Status	Second	Third
9nH	kkH	vvH

vv = Velocity 01H - 7FH ( 1 - 127 )

Note on and Note off will be sent on the zone (s) Channel (s) that contain the key only.

The Velocity sent will be a function of the keys striking velocity and the Zones Velocity Curve.

Each Zone has an independent Velocity curve.

The range of note numbers can be changed by transposition.  
 The transposition for each zone may be set independently to +/- 36 semitones.

Notes transposed off each end of the 0-127 MIDI note range, will wrap around to the other keyboard extreme.

■ Control change

Status	Second	Third
BnH	ccH	vvH

cc = 00H - 79H ( 0 - 121 ) \* 1 \* 2  
 vv = 00H - 7FH ( 0 - 127 ) for continuous controller  
 vv = 00H off for switch controller  
 vv = 7FH on for switch controller

When a controller is moved, up to 4 control change messages on 4 different channels may be sent, if so programmed.

\* 1 cc = 01H ( 1 ) Modulation messages will be scaled with the value programmed into the patch's zone (s)

\* 2 cc = 07H ( 7 ) Volume messages will be scaled with the value programmed into the patch's zone (s)

■ Program change

Status	Second
CnH	ppH

pp = 00H - 7FH ( 0 - 127 ) Program Change

When CHAIN is selected, a program change will change the currently active CHAIN. The first Patch in the Chain will become the currently active PATCH.

Any program change outside the range 0 - 31 is converted to this range, and the CHAIN changed.

When a PATCH is selected, a program change will change the currently active PATCH.

Any program change outside the range 0 - 63 is converted to this range, and the PATCH changed.

When a CHAIN or PATCH is selected, and all notes are off on the A-80s keyboard, the remote keyboard and on all channels from input 1, and the Hold pedal is off, the following messages are transmitted.

a. The Program Change messages on the channels defined in the newly active non-muted PATCH'S Zones.

b. The Volume messages on the channels defined in the newly active non-muted PATCH'S Zones.

c. The Modulation messages on the channels defined in the newly active non-muted PATCH'S Zones.

d. The System Exclusive that was saved as part of the selected PATCH is output.

e. The Program Change messages on the Effectors MIDI channels defined in the newly active PATCH.

When a ZONE is unmuted, its Volume, Modulation, and Program Change are output.

When OUTPUT is selected, a program change will be output to the currently selected MIDI output (s) only.

The relationship between Group, Bank, Number and the resulting Program Change is given in the following table.

GROUP A	NUMBER	1	2	3	4	5	6	7	8
BANK									
1	0	1	2	3	4	5	6	7	
2	8	9	10	11	12	13	14	15	
3	16	17	18	19	20	21	22	23	
4	24	25	26	27	28	29	30	31	
5	32	33	34	35	36	37	38	39	
6	40	41	42	43	44	45	46	47	
7	48	49	50	51	52	53	54	55	
8	56	57	58	59	60	61	62	63	

GROUP B	NUMBER	1	2	3	4	5	6	7	8
BANK									
1	64	65	66	67	68	69	70	71	
2	72	73	74	75	76	77	78	79	
3	80	81	82	83	84	85	86	87	
4	88	89	90	91	92	93	94	95	
5	96	97	98	99	100	101	102	103	
6	104	105	106	107	108	109	110	111	
7	112	113	114	115	116	117	118	119	
8	120	121	122	123	124	125	126	127	

■ Channel pressure ( Channel aftertouch )

Status	Second
DnH	zzH

zz = Aftertouch 00H - 7FH ( 0 - 127 )

A Channel pressure message is sent on the Zones Channels that have been defined as CHANNEL, if the Key is within the defined note range of such Zones.

The Aftertouch sent will be a function of the hardest pressed keys pressure, and the Zones Aftertouch Curve.

Each Zone has an independent Aftertouch curve.

■ Key pressure ( Polyphonic aftertouch )

Status	Second	Third
AnH	kkH	yyH

yy = Aftertouch 00H - 7FH ( 0 - 127 )

A Key Pressure message is sent on the Zones Channels that have been defined as POLYPHONIC, if the Key is within the defined note range of such Zones.

The Aftertouch sent will be a function of the keys pressure and the Zones Aftertouch Curve.

Each Zone has an independent Aftertouch curve.

■ Pitch Bend

Status	Second	Third
EnH	eeH	bbH

A Pitch Bend message is sent on the Zones Channels that have been defined as Bend On.

Bender resolution is 9 bits.

■ Mode message

Status      Second      Third  
 BnH            mmH            00H

mm = 7BH : ALL NOTES OFF      \* 1  
 mm = 7CH : OMNI ON            \* 2  
 mm = 7DH : OMNI OFF          \* 3  
 mm = 7EH : MONO MODE ON      \* 4  
 mm = 7FH : MODO MODE OFF    \* 5

\* 1 When all keys on the keyboard are released, and ALL NOTES OFF Generation is ON, ALL NOTES OFF is sent.

\* 2 Is sent if a controller assigned OMNI ON is moved, on the MIDI channel the controller is defined in.

\* 3 Is sent if a controller assigned OMNI OFF is moved, on the MIDI channel the controller is defined in.

\* 4 Is sent if a controller assigned MONO MODE ON is moved, on the MIDI channel the controller is defined in.

\* 5 Is sent if a controller assigned POLY MODE ON is moved, on the MIDI channel the controller is defined in.

■ Exclusive

Status  
 F0H : System Exclusive  
 F7H : EOX ( End of Exclusive )

A PATCH will retransmit saved System Exclusive as it was received.

The A-80 sends its own internal data in Roland One-Way type IV Format.

F0H      Status of System Exclusive  
 41H      Roland ID  
 00H      Device ID  
 27H      Model ID  
 12H      Command ID (data set)

aaH      Address (msb)  
 aaH      Address  
 aaH      Address (lsb)

wH      Data w = 00H - 7FH

ssH      Sum ss  
 F7H      End of Exclusive

Refer to Address and data section for details

■ Song Select

Status      Second  
 F3H            ssH

ss = 00H - 7FH ( 0 - 127 ) Song Select

Is sent if on either PATCH VIEW or CHAIN PLAY and the Patch buttons are used in SONG/ZONE mode.

The relationship between Group Bank and Number and the resulting Song Select number is given in the following table.

GROUP A	NUMBER	1	2	3	4	5	6	7	8
	BANK								
	1	0	1	2	3	4	5	6	7
	2	8	9	10	11	12	13	14	15
	3	16	17	18	19	20	21	22	23
	4	24	25	26	27	28	29	30	31
	5	32	33	34	35	36	37	38	39
	6	40	41	42	43	44	45	46	47
	7	48	49	50	51	52	53	54	55
	8	56	57	58	59	60	61	62	63

GROUP E	NUMBER	1	2	3	4	5	6	7	8
	BANK								
	1	64	65	66	67	68	69	70	71
	2	72	73	74	75	76	77	78	79
	3	80	81	82	83	84	85	86	87
	4	88	89	90	91	92	93	94	95
	5	96	97	98	99	100	101	102	103
	6	104	105	106	107	108	109	110	111
	7	112	113	114	115	116	117	118	119
	8	120	121	122	123	124	125	126	127

■ Tune Request

Status  
 F6H

Is sent if assigned to a controller, and the controller moved.

■ Timing Clock

Status  
 F8H

Retransmitted if input to MIDI IN 1

■ Start

Status  
 FAH

Retransmitted if input to MIDI IN 1

Is sent if on either menu VIEW or CHAIN PLAY and the START menu button is pressed.

\* This may not be recognized by Sequencers or Drum machines running on internal sync.

■ Stop

Status  
 FCH

Retransmitted if input to MIDI IN 1

Is sent if on either menu VIEW or CHAIN PLAY and the STOP menu button is pressed.

\* This may not be recognized by Sequencers or Drum machines running on internal sync.

■ Active sensing

Status  
 FEH

If Active Sensing Generation is OFF then Active Sensing is not generated.

■ System Reset

Status  
 FFH

Retransmitted if input to MIDI IN 1.

Sent on all outputs when the PANIC button is pushed, along with

- a. a NOTE OFF command for every note on every channel
- b. an ALL NOTES OFF command on every channel
- c. a DAMPER OFF command on every channel
- d. PITCH BEND to center command on every channel

## 2 RECOGNIZED RECEIVE DATA

### ■Note event

#### Note off

Status	Second	Third
BnH	kkH	vvH
9nH	kkH	00H

kk = Note number                    00H - 7FH ( 0 - 127 )  
 vv = Velocity ignored  
 n = MIDI Channel                    0H - FH ( 0 - 15 )

#### Note on

Status	Second	Third
9nH	kkH	vvH

vv = Velocity                    00H - 7FH ( 0 - 127 )

If the Data is input to the IN2 (REMOTE) input it will be treated as though it were played on the A-80s keyboard.

A Note On played on the IN2 (REMOTE), that is already on on the main keyboard will be retriggered at the new velocity.

A Note that is turned Off on the IN2 (REMOTE) that is still On on the main keyboard will not be turned OFF until the Main Keyboard's key is released.

The same is true if the roles of the Main and Remote Keyboard are reversed.

Note on and Note off will be sent on the zone (s) Channel (s) that contain the key only.

The Velocity sent will be a function of the keys striking velocity and the Zones Velocity Curve.

Each Zone has an independent Velocity curve.

The range of note numbers can be changed by transposition. The transposition for each zone may be set independantly to +/- 36 semitones.

Notes transposed off each end of the 0-127 MIDI note range, will wrap around to the other keyboard extreme.

If the data is input to MIDI IN 1, it will be merged with the Zoned data from the Main and IN2 (REMOTE), and then retransmitted, with notes retriggered, etc as appropriate

### ■Control change

Status	Second	Third
BnH	40H	vvH

vv = 00H - 3FH : Off  
 vv = 40H - 7FH : On

Any control change received on MIDI IN 1 is retransmitted on the enabled MIDI outputs.

Any control change received on IN2 (REMOTE) MIDI IN 1 is retransmitted on the enabled MIDI outputs on ALL the defined NON MUTED zones channels.

### ■Program change

Status	Second
CnH	ppH

pp = Program Change ( 0 - 32 )

When patch change is received from IN2 (REMOTE) input on any MIDI channel.

When CHAIN is selected, a program change will change the currently active CHAIN.

Any program change outside the range 0 - 31 is converted to this range, and the CHAIN changed.

When PATCH is selected, a program change will change the currently active PATCH.

Any program change outside the range 0 - 31 is converted to this range, and the PATCH changed.

When a CHAIN or PATCH is selected, and all notes are off on the A-80s keyboard, the remote keyboard and on all channels from input 1, and the hold pedal is off, the following messages are transmitted.

- The Program Change messages on the channels defined in the newly active PATCH'S Zones.
- The Volume messages on the channels defined in the newly active PATCH'S Zones.
- The Program Change messages on the Effectors MIDI channels defined in the newly active PATCH.
- Controller messages of 0 on the previous patches defined controller messages

If the Program Change is Received from MIDI in 1, and it is not on the same channel as that set in the Received program change menu, it is retransmitted on to the currently selected MIDI outputs and no A-80 patch change occurs.

### ■Channel pressure ( Channel aftertouch )

Status	Second
DnH	zzH

Any Channel pressure received on IN2 (REMOTE) MIDI Input is retransmitted on the enabled MIDI outputs on the zones channels that are defined as Channel aftertouch.

The Aftertouch sent will be a function of the hardest pressed keys pressure, and the Zones Aftertouch Curve.

Any Channel pressure received on MIDI IN 1 is retransmitted on the enabled MIDI outputs.

### ■Key Pressure ( Polyphonic aftertouch )

Status	Second	Third
AnH	kkH	yyH

Any key pressure received on IN2 (REMOTE) MIDI Input is retransmitted on the enabled MIDI outputs on the zones channels that are defined as Polyphonic aftertouch.

Any Key pressure received on MIDI IN 1 is retransmitted on the enabled MIDI outputs.

### ■Pitch Bend

Status	Second	Third
EnH	eeH	bbH

Any Pitch Bend received on IN2 (REMOTE) MIDI Input is retransmitted on the Zones channels that have BEND ON.

Any Pitch Bend received on MIDI IN 1 is retransmitted on the enabled MIDI outputs.

### ■Timing Clock

Status
F8H

Ignored if input to IN2 (REMOTE).  
 Retransmitted if input to MIDI IN 1

### ■Start

Status
FAH

Ignored if input to IN2 (REMOTE).  
 Retransmitted if input to MIDI IN 1

### ■Continue

Status
FBH

Ignored if input to IN2 (REMOTE).  
 Retransmitted if input to MIDI IN 1

■ Stop

Status

FCH

Ignored if input to IN2 (REMOTE).  
Retransmitted if input to MIDI IN 1

■ Active sensing

Status

FEH

Is ignored on the Remote keyboard input.

If incoming to MIDI IN 1, its presence is noted and, if it disappears, ALL NOTES OFF messages and NOTE OFFs for all key on all channels will be sent if any NOTES ON were active at the time of disconnection.

If Active Sensing Recognition is OFF then Active Sensing is ignored and no action is taken if it disappears from MIDI IN 1.

■ Exclusive

Status

F0H : System Exclusive

XXH : Maker ID

XXH : Model ID number

F7H : EOX ( End of Exclusive )

\*If the System Exclusive is input to the IN2 (REMOTE) input and the SAVE SYSTEM EXCLUSIVE page is selected, the incoming System Exclusive will be saved in the patch currently selected. Otherwise it is ignored. If not on SAVE SYSTEM EXCLUSIVE into patch menu, it will be retransmitted.

If Exclusive Receive is ON and a message of the following form is received via MIDI IN 1.

F0H Status of System Exclusive  
41H Roland ID  
00H Device ID  
27H Model ID  
12H Command ID (data set)

aaH Address (msb)  
aaH Address  
aaH Address (lsb)

vvH Data vv = 00H - 7FH

ssH Sum ss  
F7H End of Exclusive

\*It will be loaded into the A-80's memory if the address and data fields match those given in section 3.

The previous contents of the A-80's memory will be lost.

\*If the System Exclusive is input to the MIDI IN input and it is NOT the A-80's System Exclusive, it will be retransmitted on the enabled MIDI outputs.

\*If the A-80 receives a message of the following form, The A-80 will Bulk Dump ALL internal data.

F0H Status of System Exclusive  
41H Roland ID  
00H Device ID  
27H Model ID  
11H Command ID (data set)

xxH

:

F7H End of Exclusive

Any address and size given is ignored.

\*If the A-80 receives a message of the following form, The A-80 will Recrawl the Display and reselect the current patch.

F0H Status of System Exclusive  
41H Roland ID  
00H Device ID  
27H Model ID  
12H Command ID (data set)

41H Address (msb)  
00H :  
00H Address (LSB)

vvH 00h - 3FH Dummy data

ssH Sum ss  
F7H End of Exclusive

\*If the A-80 receives a message of the following form, The A-80 will popup the message window with the sent message.

F0H Status of System Exclusive  
41H Roland ID  
00H Device ID  
27H Model ID  
12H Command ID (data set)

42H Address (msb)  
00H :  
00H Address (LSB)  
vvH Data vv

ssH Sum ss  
F7H End of Exclusive

Where vvH is up to 29 ASCII characters. Extra characters will be ignored

**3. Exclusive Address and Data**

Address mapping of parameters into the A-80

Addresses are shown in Hexa-decimal

Address	MSB	LSB
binary	0aaa aaaa	0bbb bbbb   0ccc cccc
7 bit Hex	AA	BB   CC

The actual address of a parameter in a block is the sum of the start address of each block and one or more offset address.

An Exception is the Bulk Exclusive data which uses the same address range for all patches data.

Parameter base addresses.

Start Address	Description
00 00 00	Globals, MIDI Channel Name Area
00 02 00	Chain 1
00 04 00	Chain 2
00 06 00	Chain 3
00 40 00	Chain 32
01 00 00	Patch 1
02 00 00	Patch 2
03 00 00	Patch 3
40 00 00	Patch 64
41 00 00	Patch selected by Exclusive message
42 00 00	25 character Message popup buffer
50 00 00	System Exclusive Command
51 00 00	System Exclusive Bulk Data
51 00 20	
51 00 40	
51 00 60	

MIDI Channel Names

Table of 16 MIDI Channel Names each 10 characters, and Global MIDI options.

Offset Address	Description
00 00H	0aaa aaaa   MIDI channel 1 name character 0 32-95
00 09H	0aaa aaaa   MIDI channel 1 name character 9 ( ASCII )
01 16H	0aaa aaaa   MIDI channel 16 name character 0 32-95
01 1FH	0aaa aaaa   MIDI channel 16 name character 9 ( ASCII )
01 20H	000a aaaa   A-B0 Program Change receive channel *1
01 21H	0000 000a   Active Sensing Generation/Recognition 0=OFF 1=ON
01 22H	0000 000a   All Notes OFF Generation 0=OFF 1=ON
01 23H	0000 000a   Own Exclusive Receive 0=OFF 1=ON
Total size	0D 01 24H

\*1 Channel Numbers higher than 0FH = receive program change disabled on MIDI input 1.

Chains

Data for 32 chains

Offset Address	Description
00H	0aaa aaaa   chain name character 0 32-95
0FH	0aaa aaaa   chain name character 15 ( ASCII )
10H	0aaa aaaa   chain comment character 0 32-95
2FH	0aaa aaaa   chain comment character 31 ( ASCII )
30H	000a aaaa   Chain length 0-31
31H	00aa aaaa   Link 1 patch's number 0-63
4FH	00aa aaaa   Link 32 patch's number 0-63
Total size	00 00 51H

Patch Parameter Definitions

Offset Address	Description
00 00H	0aaa aaaa   patch name character 0 32-95
00 0FH	0aaa aaaa   patch name character 15 ( ASCII )
00 10H	0000 aaaa   Patch output routing 0 0 0 0 a a a a MIDI 1 MIDI 2 MIDI 3 MIDI 4 0= output muted
00 11H	0000 aaaa   Zone muting 0 0 0 0 a a a a A B C 0= zone muted
00 12H	0aaa aaaa   Zone A parameters
00 2FH	0aaa aaaa   Zone B parameters
00 4CH	0aaa aaaa   Zone C parameters
00 69H	0aaa aaaa   Zone D parameters
01 06H	0aaa aaaa   Effector 1 channel number *1
01 07H	0aaa aaaa   Effector 2 channel number *1
01 08H	0aaa aaaa   Effector 3 channel number *1
01 09H	0aaa aaaa   Effector 4 channel number *1
01 0AH	0aaa aaaa   Effector 1 Program change
01 0BH	0aaa aaaa   Effector 2 Program change
01 0CH	0aaa aaaa   Effector 3 Program change
01 0DH	0aaa aaaa   Effector 4 Program change
Total size	0D 01 0EH

\*1 Channel Numbers higher than 0FH = None.

Zone Parameters

Offset Address	Description
00H	0aaa aaaa   start key 0-127 *1
01H	0aaa aaaa   end key 0-127 *1
02H	0000 aaaa   MIDI channel 0-15
03H	0aaa aaaa   transpose 0-72 0--36 72+36
04H	0000 0aaa   basic velocity curve 0-127
05H	0aaa aaaa   Velocity scaling 0-127
06H	0aaa aaaa   Velocity offset 0-127
07H	0aaa aaaa   Velocity holdoff 0-127
08H	0000 0aaa   basic aftertouch curve 0-5
09H	0aaa aaaa   Aftertouch scaling 0-127
0AH	0aaa aaaa   Aftertouch holdoff 0-127
0BH	0000 00aa   Aftertouch type 0-3 Pol*0 Key*1 off*3
0CH	0000 aaaa   Patch type 0-5
0DH	0aaa aaaa   Volume 0-127
0EH	0aaa aaaa   Modulation 0-127
0FH	0000 000a   pitch bend on=0 off=1
10H	0aaa aaaa   Patch change 0-127
11H	0aaa aaaa   slider controller number 0-127 *2 *3

12H	0aaa aaaa	slider controller 2	number 0-127	*2 *3
13H	0aaa aaaa	slider controller 3	number 0-127	*2 *3
14H	0aaa aaaa	slider controller 4	number 0-127	*2 *2
-----				
15H	0aaa aaaa	switch controller 1	number 0-127	*2 *3
16H	0aaa aaaa	switch controller 2	number 0-127	*2 *3
17H	0aaa aaaa	switch controller 3	number 0-127	*2 *3
18H	0aaa aaaa	switch controller 4	number 0-127	*2 *3
-----				
19H	0aaa aaaa	foot controller 1	number 0-127	*2 *3
1Ah	0aaa aaaa	foot controller 2	number 0-127	*2 *3
1BH	0aaa aaaa	foot controller 3	number 0-127	*2 *3
1CH	0aaa aaaa	foot controller 4	number 0-127	*2 *3
-----				
Total size			00 00 10H	

- \* 1 Start key must be less than or equal to end key
- \* 2 Actual MIDI controller number is (number - 1) 0 = unassigned controller
- \* 3 The Following Controller numbers are assigned non MIDI controller messages

123 is converted to FBH Auto Tune  
 124 is converted to CxH 7CH 00H Omni Off  
 125 is converted to CxH 7DH 00H Omni On  
 126 is converted to CxH 7EH 00H Mono On  
 127 is converted to CxH 7FH 00H Poly On where x is the MIDI channel of the zone the controller is defined in.

#### 14. System Exclusive Bulk Librarian

The Bulk Data from other equipment, memorized by the A-80 is dumped and loaded with three distinct message types.

The Message containing the Patch Number.

The Bulk Data messages.

The Message containing the End of Data.

The command for the A-80s bulk dump and load is the follow message header.

```
F0H      Status of System Exclusive
41H      Roland ID
00H      Device ID
27H      Model ID
12H      Command ID (data set)
50H      Address (msb)
00H      Address
00H      Address (lsb)
vvH      Data vv = 00H - 3FH
ssH      Sum
F7H      End of Exclusive
```

vv is the PATCH number of the Exclusive data to follow.

\*The reception of this command deletes the existing Exclusive data for the patch given, and reclaims unused memory (garbage collection).

\*This command must proceed any data packet, or the integrity of the system memory cannot be garranteed

The Exclusive data for the A-80s bulk data are dumped and loaded with the follow message.

```
F0H      Status of System Exclusive
41H      Roland ID
00H      Device ID
27H      Model ID
12H      Command ID (data set)
51H      Address (msb)
00H      Address
00H      Address (lsb)
ddH      Data dd = 00H - 0FH
:
:
ssH      Sum
F7H      End of Exclusive
```

\*bbbb aaaa is sent 0000 aaaa 0000 bbbb

\*The data packets must be limited to 64 data or less per message to allow time for garbage collection to occur.

\*The Data for all Patches Exclusive Bulk data is loaded from the same address.

\*The Data consists of memorized Exclusive messages F0H...F7H and FFH markers.

For example :

A patch may contain these two exclusive message that have been loaded from an external device.

F0 00 01 F7 F0 02 03 F7

The data message would be transmitted as :

```
F0H      Status of System Exclusive
41H      Roland ID
00H      Device ID
27H      Model ID      A - 80
12H      Command ID (data set)
51H      Address (msb)
00H      Address
00H      Address (lsb)

00H      0000 aaaa      first Exclusive message
0FH      0000 bbbb
00H      0000 aaaa
00H      0000 bbbb
01H      0000 aaaa
00H      0000 bbbb
07H      0000 aaaa
0FH      0000 bbbb

00H      0000 aaaa      second Exclusive message
0FH      0000 bbbb
02H      0000 aaaa
00H      0000 bbbb
03H      0000 aaaa
00H      0000 bbbb
07H      0000 aaaa
0FH      0000 bbbb

0FH      FFH end of patch's Exclusive data marker
0FH
```

The end command must follow the A-80s bulk data dump and load with the follow message.

```
F0H      Status of System Exclusive
41H      Roland ID
00H      Device ID
27H      Model ID
12H      Command ID (data set)
50H      Address (msb)
00H      Address
00H      Address (lsb)
40H      Data vv = 00H - 3FH
ssH      Sum
F7H      End of Exclusive
```

The reception of this command correctly installs the Exclusive data for the given patch.

\*This command must follow any bulk data, or the integrity of the system memory cannot be garranteed

The command for Deleting all the A-80s bulk Exclusive data is the following :

```
F0H      Status of System Exclusive
41H      Roland ID
00H      Device ID
27H      Model ID
12H      Command ID (data set)
50H      Address (msb)
00H      Address
00H      Address (lsb)
41H      Sum
ssH      Sum
F7H      End of Exclusive
```

\*The reception of this command deletes the existing memorized Exclusive data contained within all patches.

\*This command must proceed a full memory Librarian bulk dump.



Function ...		Transmitted	Recognized	Remarks
Basic Channel	Default Changed	1 - 16 1 - 16	1 1 - 16	up to 4 channels
Mode	Default Messages Altered	OMNI ON, POLY/MONO *****	x	
Note Number	True Voice	0 - 127 *****	0 - 127 0 - 127	
Velocity	Note ON Note OFF	○ x (9n v = 0)	○ x	v = 1 - 127
After Touch	Key's Ch's	○ ○	○ ○	
Pitch Bender		○	○	1 in 4 out
Control Change		○	○	assignable
Prog Change	True #	○ (0 - 127) *****	○ (0 - 63) ○ (0 - 31)	
System Exclusive		○	○	
System Common	Song Pos Song Sel Tune	○ ○ ○	x x x	Retransmitted if input to MIDI in 1
System Real Time	Clock Commands	x ○	x x	Retransmitted if input to MIDI in 1
Aux Message	Local ON/OFF All Notes OFF Active Sense Reset	x ○ ○ ○	x ○ ○ x	
Notes				

Mode 1 : OMNI ON, POLY  
 Mode 3 : OMNI OFF, POLY

Mode 2 : OMNI ON, MONO  
 Mode 4 : OMNI OFF, MONO

○ : Yes  
 x : No

# ■ Specifications

A-80 : 88-key MIDI Keyboard Controller

## <Front Panel>

Bender Lever  
Pitch Wheel  
Modulation Wheel  
Sliders  
Control Switch  
Edit Button  
Increment/Yes Button  
Decrement/No Button  
LCD Display  
Menu Keys  
Cursor Buttons  
Patch Bank Buttons  
Patch Number Buttons  
Group Buttons  
Channel Button  
Patch Mode Buttons(Chain, Patch, Zone/Song,  
Output)  
Zone Solo Button  
Zone Mute Button  
Zone/Output Selector  
Panic Button

## <Rear Panel>

Control Pedal Sockets(1, 2, 3 and 4)  
Patch Shift Sockets(DOWN/UP)  
MIDI IN Socket 1  
MIDI IN Socket 2(remote)  
MIDI THRU Socket  
MIDI OUT Sockets(1, 2, 3 and 4)  
LCD Contrast Knob  
Card Slot  
Selector Switch (for Voltage change)  
Receptacle  
Power Switch

**Dimensions** : 1360(W)X 354(D) X 118(H) mm  
47 3/16" 11 3/8" 3 1/2"

**Weight** : 30Kg  
26.5 lb

**Consumption** : 8 W (100V,117V)  
10W (220V,240V)

**Accessories** : Owner's Manual  
Guide book for MIDI  
A-80 Menu map  
Power cord  
Pedal switch (DP-2)

## Option

Keyboard stand \*KS-7  
RAM card M-256D, M-256E  
Pedal switch DP-2, DP-6, FS-5u  
Volume pedal EV-5  
MIDI/SYNC cables MSC-07/15/25/50/100

\* Specifications are subject to change without notice.

# INDEX

<b>Active Sensing</b>	Procedure to select Active Sensing .....	71
<b>Aftertouch</b>	Procedure to edit zone Aftertouch curve parameters .....	55
<b>All Notes Off</b>	Procedure to select ALL NOTES OFF ON/OFF .....	71
<b>Bend</b>	Procedure to edit zone Bend ON/OFF .....	60
<b>Chain</b>	Procedure to select a Chain .....	24
	Procedure to Copy a Chain .....	37
	Procedure to edit Chain name or comment .....	67
	Procedure for editing Chain Links .....	68
<b>Copy</b>	Procedure to Copy a Patch .....	36
	Procedure to Copy a Chain .....	37
<b>Dump</b>	Procedure to dump the A-80's memory .....	76
<b>Exclusive</b>	Procedure for loading Exclusive data .....	77
	Procedure to select Exclusive Receive ON/OFF .....	72
	Procedure for loading Exclusive data into Patch .....	40
<b>Foot controller</b>	Procedure to edit zone foot controller definition .....	63
<b>MIDI Channel</b>	Procedure for setting Effect's MIDI channels in a Patch using INC DEC buttons .....	43
	Procedure for setting Effect's MIDI channels using a slider into a Patch .....	43
	Procedure to edit zone MIDI channel number .....	48
	Procedure to select the (MIDI) channel name to be edited .....	64
	Procedure to edit the MIDI channel name you have selected .....	65
<b>Modulation</b>	Procedure to edit zone Modulation message .....	59
<b>Output</b>	Procedure for setting the OUTPUT socket SOLO/MUTE .....	29
<b>Page</b>	Procedure to select the zone Page to be edited .....	45
<b>Patch</b>	Procedure to select a Patch .....	23
	Procedure to Undo a Patch from an Edit .....	35

	Procedure to Copy a Patch .....	36
	Procedure to Edit a Patch name .....	39
	Procedure for Loading Exclusive data into a Patch .....	40
	Procedure for setting Effect's Program change in a Patch using INC DEC buttons .....	42
	Procedure for setting Effect's Program change in a Patch using Patch Select buttons .....	44
	Procedure for setting Effect's MIDI channels in a Patch using INC DEC buttons .....	43
	Procedure for setting Effect's MIDI channels using a slider into a Patch .....	43
<b>Program Change</b>	Procedure to send Program Change .....	25
	Procedure for setting Effect's MIDI channels in a Patch using INC DEC buttons .....	43
	Procedure for Effects Program Change in a Patch using Patch Select buttons .....	44
	Procedure to edit Receive channel for Program Changes .....	71
<b>Program type</b>	Procedure to edit zone Program type parameter .....	56
<b>Protect</b>	Procedure to change the Protect stage .....	34
<b>RAM card</b>	Procedure to load from the RAM card .....	73
	Procedure to save onto a RAM card .....	74
	Procedure to edit RAM card name .....	75
<b>Slider</b>	Procedure to edit zone Slider definition .....	62
<b>Solo/Mute</b>	Procedure for setting the zone Solo/Mute .....	28
<b>Song Select</b>	Procedure to send Song Select .....	30
<b>Switch</b>	Procedure to edit zone Switch definition .....	61
<b>Transpose</b>	Procedure to edit Transpose amount .....	49
<b>Undo</b>	Procedure to Undo a Patch from an Edit .....	35

<b>Velocity</b>	Procedure to edit zone Velocity curve parameters .....	50
<b>Volume</b>	Procedure to edit zone Volume message .....	58
<b>Zone</b>	Procedure for setting the zone's Solo/Mute .....	28
	Procedure to edit zone position using sliders .....	46
	Procedure to edit zone position using the keyboard .....	46
	Procedure to edit zone position using the INC DEC buttons .....	47
	Procedure to edit zone MIDI channel number .....	48
	Procedure to edit zone Transpose amount .....	49
	Procedure to edit zone Velocity curve parameters .....	50
	Procedure to edit zone Aftertouch curve parameters .....	53
	Procedure to edit zone Program type parameter .....	56
	Procedure to edit zone Volume message .....	58
	Procedure to edit zone Modulation message .....	59
	Procedure to to edit zone Bend ON/OFF .....	60
	Procedure to edit zone Switch definition .....	61
	Procedure to edit zone Slider definition .....	62
	Procedure to edit zone Foot Controller definition .....	63





**Roland®**

---

**10827**

UPC 10827



12901

**Roland®**