

8785 LINEAR DIGITAL TO ANALOG CONVERTER

The two most common questions I hear about the computer - based synthesizer systems we've been developing here are:

- 1) How do I use it with my exponential synthesizer gear?
and
- 2) How do I use it with my Razmataz RMT-80 computer?

The answer to the second question is going to have to wait just a bit longer (though I expect to have a surprising answer soon).

The answer to the first question is what we're going to focus on this time by looking at a Digital to Analog converter that is designed to be compatible with almost every synthesizer in the world with the exception of the linear holdouts- Paia, Yamaha CS series, Unicord, some EML; you know who they are. For them, you use the stuff we've already covered.

By way of a very short review, the differences between D/A's that are to be used with linear response elements and those that are to work with Moog, Arp, or any other exponential system are not great from a basic conceptual standpoint. A binary number is fed in one end, and a DC control voltage comes out the other. But, they do differ greatly in the character of the voltage that comes out.

For linear response equipment, the D/A must produce an output that has an exponential character- as the control voltage increases, the incremental change in voltage must also increase.

Since exponential response equipment has analog circuitry built into the front end of each control input which "bends" the linear control signal into an exponential curve, a D/A that is to be used with this equipment must produce a linear output voltage function. That is, the incremental change in output voltage must be constant. See figure 1.

One of the nicer things about this linear D/A is that it's common, the kind that most applications require. Since it is common, we have a large number of parts to choose from. From that large number we've selected a "5008" type which is made by a number of manufacturers. When Signetics makes it and houses it in a 16 pin plastic package it becomes an NE5008N.

Inside, this chip is relatively simple. It looks like

figure 2. The transistors shown are each a current source and the values of the resistors in the matrix that their emitters are tied to are such that if the source associated with D0 is pumping some current (i), the one that corresponds to D1 will pump twice that (2i). Similarly, the source that goes along with data bit D2 produces what the previous one did (4i), and so on.

In response to a bit being set, the current produced by the source associated with that bit is switched so that instead of appearing at pin 2 of the IC it appears at pin 4 (Iout). At any given instant, this output current will be the sum of the currents corresponding to each input bit which has been set.

To turn this chip into a "system" that accepts data at the input and controls a synthesizer at the output, we need to add such niceties as latches to hold the data that the computer sent out, an I/V (current to voltage) converter to change the 5008's current output to a voltage that our synthesizers will like, and

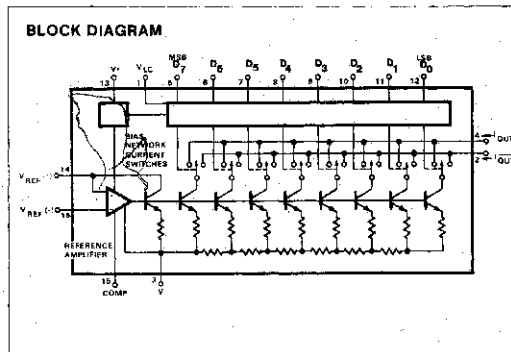
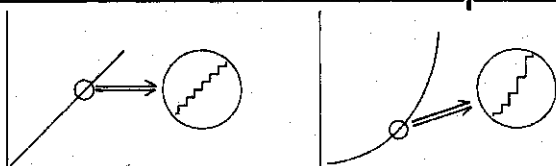

other bells and whistles as available.

When we do all this, the design looks like figure 3. It's pretty straight - forward. We've used 4042's to latch the data coming in and the RD line is the strobe on these latches which, when low, allows the data present at their inputs to appear at the outputs. When RD is high, whatever data was present at the latch inputs when the line went high will be held at the outputs. Notice that the two most significant data bits follow our previous protocols in that they come out simply as flags rather than being presented to the converter circuitry. But notice also the jumper JP1 which, as we'll see later, can be used to double the range of the D/A (although at what might be an unacceptably high cost).

We've used a 4136 quad op-amp to provide all of the analog support that the 5008 needs; one stage serves as a buffer between the calibration trimmer and the 5008's Vref input (IC1a), another comprises a current to voltage converter (IC1b), and a third is an inverting summing amplifier that allows a modulation input (IC1c).

With the exception of the standard "be tidy" caveats, there's nothing very critical about this D/A system and you can build it using whatever construction techniques appeal to you, but the board which is available from Paia has enough interesting features that it's worth taking a special look at it. Check out figure 4.

I suppose the most interesting thing is the way the input, output, and control lines are configured. Notice that the connections to the computer all appear on two 14 pin dip outlines (J1 and J2), while connections to the synthesizer (including some computer address lines that QuASH in an expanded system will need; see "In Pursuit Of The Wild QuASH", Polyphony July '77, page 19) come out to the 15 pin Molex-type edge connector (J3).

We've already examined in general terms how this type of D/A connects at the computer side (see "The Polyphonic Synthesizer", Polyphony February '78, page 28). If the computer you're using is a Paia 8700 (which is not a bad idea since it has some useful music software to support

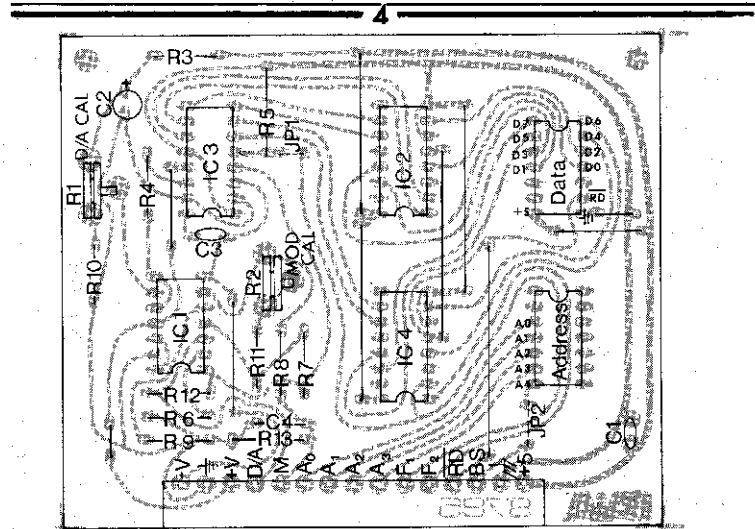
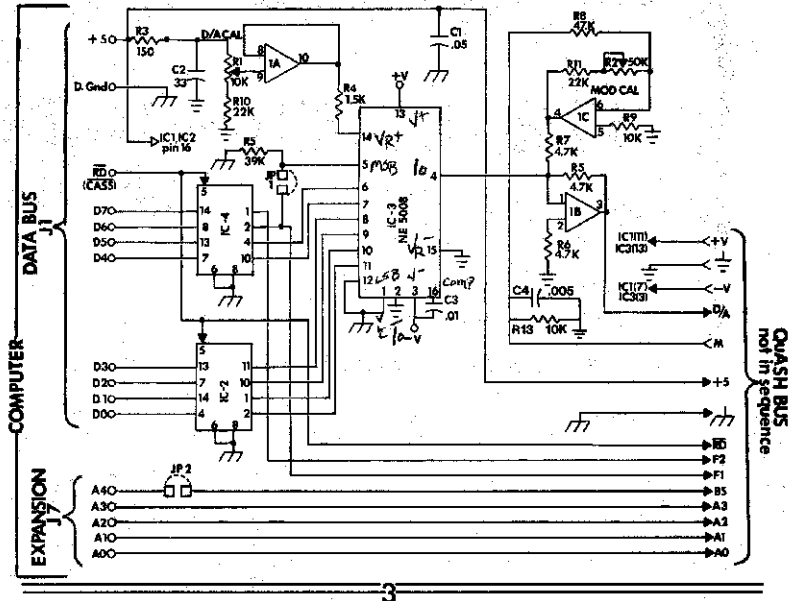

it), these connections couldn't be simpler - there is a one to one correspondence between J1 and J2 and the connectors they mate with on the computer. Standard pre-terminated jumpers are used to connect the two. No soldering.

The wiring to the "synthesizer" side is also arranged to acknowledge the fact that almost everyone will want to expand to a multi-channel system sooner or later (it's actually

what the computer stuff is best at!), so the Molex wiring is the same as that found on QuASH modules.

All of this means that from an inter-wiring standpoint, a fully expanded system is exceptionally easy to implement. Figure 5 shows you how.

Calibration of the 8785 D/A consists of adjusting the D/A CAL trimmer (R1) so that octave changes in the input data produce

octave changes in the module being controlled; this can easily be done by ear. The MOD CAL trimmer (R2) should be set so that a one volt (or whatever represents one octave in your system) change at the modulation input produces a one octave change in the controlled element.

Before we wrap this column up, there are some little detail things that really need to be mentioned.

Going back to the schematic for a minute, observe that there are two "programming" jumpers (JP1 and JP2) indicated on the circuit board.

As we've mentioned again and again, the Paia protocols use the least significant 6 bits of an 8 bit word to specify an analog parameter while the two most significant bits are flags (D6 is used as a gate, and D7 is a general purpose control bit which QuASH recognize as a portamento control bit). Since the 5008 is an eight bit converter, obviously some bits will not be used. I decided to permanently not use the least significant bit (LSB) of the converter (pin 12) by grounding it. The only effect of this is to slide all the lines of the controller "up one" as far as the 5008 is concerned, and it has no electrical effect that we need to worry about.

The other unused 5008 bit is then it's MSB (most significant bit - D7, pin 5) and if the jumper JP1 is not in place, this bit is in fact not used. But, if you are one of those people for whom nothing is ever enough, you have the option of installing the jumper. This means that the MSB of the 5008 is tied to data bit D6, effectively doubling the range of the D/A from 64 notes (over 5 octaves) to 128 notes (almost 11 octaves).

The cost of this "simple" modification is much greater than just a piece of wire, though, because if the option is selected the system is no longer compatible with our existing software (which might be just fine for your purposes). Maybe worse than that, it's no longer compatible with QuASHes either. But if you need it, it's there.

A second jumper (JP2) is meant to be used in systems with 4 or more QuASH and causes the fifth address bit from the computer to serve as the Bank Select (BS) line (see "In Pursuit Of The Wild QuASH" referenced

earlier).

Something else to worry about is grounding. At some point in the system, digital power ground (recognized as a chassis ground symbol) and analog power ground (recognized as an earth ground symbol) must be tied together. However, they must have a common connection at only one point. Otherwise you run the risk of ground loop problems. I recommend that these two grounds be tied together at the Molex connector of the D/A, as shown in figure 5.

Finally, Moog "S" triggers must be pulled to ground rather than accepting the high logic level that our trigger outputs provide. The simple circuit in figure 6 takes care of this using almost any NPN transistor you happen to have laying around.

Synthesizers that have both "gate" and "trigger" inputs can use the scheme shown in figure 7 to derive both of these signals from the single gate that our D/A produces.

8785 Linear D/A
PARTS LIST

IC 1		4136
IC 2, 4		4042
IC 3		NE5008
R1		10K trimmer
R2		50K trimmer
R3	150 ohm	1/4 watt 5%
R4	1.5K ohm	1/4 watt 5%
R5	39K ohm	1/4 watt 5%
R6, R7, R8, R12	4.7K ohm	1/4 watt 5%
R9, R13	10K ohm	1/4 watt 5%
R10, R11	22K ohm	1/4 watt 5%
C1		.05 ceramic disk
C2	33 mfd.	10v. electrolytic
C3		.01 ceramic disk
C4		.005 ceramic disk
Misc.		
3		16 pin DIP sockets
3		14 pin DIP sockets
1		15 pin male molex
1		15 pin female molex
2		14 pin DIP headers
		bare wire

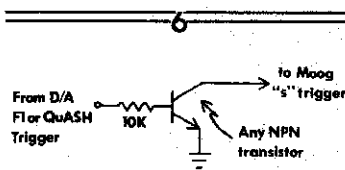
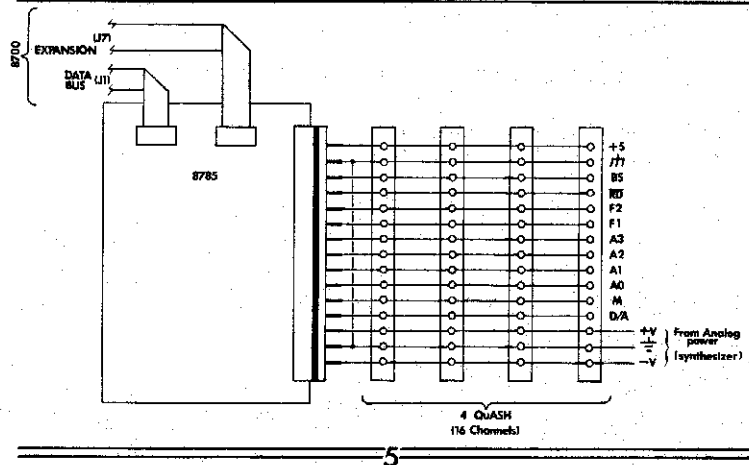

MOOG "S" TRIGGER ADAPTER.

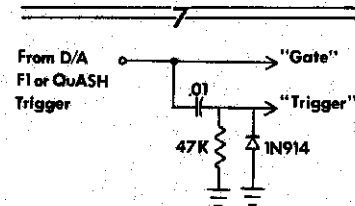

"GATE" & "TRIGGER" ADAPTER.

NOTES ON 8785/8781 (QuASH) USAGE

The Bank Select disabling jumper on the QuASH (marked "**") and the expansion decoding jumper on the 8785 linear D/A (JP2), cannot both be in place at the same time.

Installation of JP2 on the 8785 and elimination of the "**" jumper on the 8781 is recommended.

A stock 8781 can not tolerate control voltages greater than the supply voltage to the multiplexing IC's, IC2, IC3 and IC6. Since the voltage to these IC's is the supply voltage from the computer (nominally 5 volts) and an 8785 which is calibrated to the more or less standard 1 volt/octave will produce a maximum control voltage of 5.33v., you may experience some difficulties.

Typically, problems in this area will result in all QuASH channels appearing to respond when one of them is commanded to produce a high control voltage. With normal software running, this will be heard as very serious pitch (control voltage) modulation on all channels when any one of them is trying to play a high note.

This problem can be eliminated by modifying the 8781 board as follows:

() On the component side of the 8781 board, remove the jumper that connects pin 14 of IC1 to pin 14 of IC2.

() As above, remove the jumper that connects pin 14 of IC5 to pin 14 of IC6.

() Connect a new 680 ohm resistor from the recently vacated hole at pin 14 of IC2 to the hole at pin 14 of IC6.

THIS COMPLETES MODIFICATIONS TO THE COMPONENT SIDE OF THE CIRCUIT BOARD.

() On the conductor side of the circuit board, install a new wire jumper from pin 14 of IC3 to the side of R10 which also connects to the "+" lead of C25.

THESE CHANGES ARE ILLUSTRATED BELOW:

