

TABLE OF CONTENTS

INTRODUCTION 15

WELCOME! 15

ABOUT THE NORD MODULAR G2 SYSTEM 15

ABOUT THIS MANUAL 15

Reading the manual in Adobe Acrobat Reader 15

CLAVIA ON THE INTERNET 16

G2 BASICS 16

Modular synthesis 16

Patches 16

Variations 17

Slots 17

Playing multitimbrally 18

Performances 18

Special features in Performances 18

Focus 19

Modules 19

Parameters 19

Assignable Knobs/Buttons 19

Parameter pages 19

Morphs 20

SYNTH QUICK TOUR 21

CHECKING OUT THE INSTRUMENT FIRST 21

CHECK OUT SOME PATCHES! 21

Access more assigned parameters in the Patch 22

Variations 22

Load a new Patch from the internal memory 22

CHECK OUT SOME PERFORMANCES 23

Access assigned Performance (Global) parameters 23

Loading another Performance from the internal memory 24

Changing Variations when in Global Panel mode 24

WORKING WITH THE SYNTH 25

SYSTEM FUNCTIONS SECTION 26

EDIT SYSTEM SETTINGS 29

LIST OF FUNCTIONS IN THE G2 SYSTEM MENU 30

SOUND FUNCTIONS SECTION 33

EDITING PATCH SETTINGS 34

WORKING WITH PATCHES 36

- Load a Patch from memory 36
- Search for and load a Patch 36
- Creating a blank Patch 36
- Accessing (Edit) any Parameter in a Patch 37
- Assign Parameters to Panel Controls 37
- Patch parameter Variations 39
- Store a Patch 40
- Copying Patches 42
- Rename a Patch 43
- Delete a Patch 43

WORKING WITH SLOTS 43

- Activate several Slots 43
- Layering Patches 43
- Changing Edit Focus but not Keyboard focus 44

MORPH GROUPS 44

- Assign parameters to a Morph group 44
- Deassign parameters from a Morph group 46
- Edit parameters in a Morph group 46
- Copy a Morph group from one source to another 46
- Morph groups in separate Variations 46
- A word about the Keyboard Morph 46
- A word about the Pitch Stick Morph 47

PERFORMANCES 47

- Entering Performance Mode 47
- Exiting Performance Mode 47
- Load a new Performance from the internal memory 48
- Creating a Performance 48
- Editing a Performance 48
- Global (Performance) Parameter Pages 49
- Keyboard Split 49
- Keyboard Zone 50
- Storing a Performance 50
- Extracting Patches from a Performance 51
- Deleting Performances 52

NORD MODULAR G2 ENGINE FRONT PANEL 53**NORD MODULAR G2 REAR PANEL 53**

THE G2 EDITOR SOFTWARE 55

THE EDITOR SOFTWARE 55

- Software installation 55
- Editor system requirements Windows PC 55
- Editor system requirements Macintosh 55
- Windows 98SE/2000/XP, Apple Mac OSX 55
- When editing more than one G2 55
- Installation of the usb driver 56
- Installation of the Editor on a Windows PC 56
- Starting up 57
- Launching the Editor on a Windows PC 57

THE EDITOR APPLICATION 58

TOOLBAR 59

- Perf: (name) 59
- Master Clock 59
- Slot buttons 59
- Connection indicators 59
- Perf 59
- New 60
- Init 1&2 60
- Module Group selectors 60
- Module Icons 60
- Patch Load, Cycles and Memory 60
- Undo & Redo 61
- Color 61
- Morph groups 61
- Patch Name 61
- Category 61
- Voice Mode 62
- Variation 62
- Var Init 62
- Patch Level 62
- Visible cables 62
- Hide all cables 62
- Shake cables 62
- Patch window split bar 63

MAKING YOUR FIRST PATCH 63

POPUP MENUS IN THE EDITOR 68

- Patch window popup 68
- Module popup 69
- Parameter popup 70
- Cable popup 70

BASIC MODULE FUNCTIONS 71

- Cables and connectors 71
- Module output sample rate 71
- Module input sample rate 72
- Red and blue outputs, bipolar and unipolar 72
- Yellow and orange outputs, logic states 72
- Yellow and orange inputs 72
- Display boxes and graphs 73
- leds 73

BASIC MODULE PARAMETER CONTROLS 73

- Parameters 73
- Parameters that can't be changed between Variations 73
- Buttons 74
- Radio Buttons 74
- Arrow buttons 74
- Knobs 74
- Sliders 74
- Drop-down selectors 74
- Scroll buttons 75
- Name buttons 75

MODULATION 76

- Modulation inputs 76
- Mod-amount knobs (attenuators) 77
- Knob positions 77
- Modulation examples 78
- Maximum modulation 79
- Modulation Level knob names 80

WORKING IN THE EDITOR 81

- Sound synthesis on the G2 81
- Create a new empty Patch window 81
- Add modules to a Patch 81
- Rename a module 82
- Move a module 82
- Delete a module 82
- Replace a module 82
- Coloring a module 83
- Connecting modules 83
- Edit module parameters in a Patch 84
- Voice Area and FX Area 85
- Download a Patch to the synthesizer 86
- Store a Patch 86
- Delete a Patch 88
- Creating Patch parameter Variations 88
- Save a Variation 89
- Copy a Variation 89
- Variation Init 89
- midi control of Variations 89

KNOBS AND CONTROLLERS 89

- The Parameter Pages window 89
- Assign a parameter to a knob 90
- Assign all module parameters to a set of knobs 91
- midi controllers 91

MORPH GROUPS 92

- Assign parameters to a Morph group 93
- Deassign parameters from a Morph group 93
- Edit parameters in a Morph group 94
- Copy a Morph group to another source 94
- Morph groups in separate Variations 94
- Keyboard Morph and Pitch Stick morph 94

THE EDITOR AND PERFORMANCES 94

- Performance mode and Patch mode 94
- Uploading a Performance to the Editor 95
- Creating a Performance in the Editor 95
- Keyboard Split (Keyboard Range) 96
- Keyboard range and G2 panel split function 96
- Combining Split and Layer 96
- The Global Parameter Pages 96

STORING A PERFORMANCE 97

- Storing in the synth 97
- Saving on the computer 97
- Renaming single Patches in Performances 97

EXTRACTING PATCHES FROM A PERFORMANCE 97

- Extract a Patch and store it in the synth 97
- Extract a Patch and save it on the computer 98

DELETING PERFORMANCES IN THE SYNTH 98**EXITING PERFORMANCE MODE 98****THE PATCH MUTATOR 99****INTRODUCTION 99**

- The Patch Mutator Window 100
- Using the Patch Mutator 101
- Quick Start 102

PATCH MUTATOR REFERENCE 103

- Which parameters will be affected? 104
 - Exclude from mutation 104
 - The Quick Lock buttons 104
 - Probability distributions 105
 - Permanently locked parameters 105
 - Modules excluded by default 106
 - Mutate 106
 - Randomize 107
 - Interpolate 107
 - Cross 108
 - The Temporary Storage 109
 - Saving Sounds 110
 - Patch Mutator Shortcuts Overview 110
- HISTORICAL BACKGROUND 111**
- Further reading 111

THE PATCH ADJUSTER 113**INTRODUCTION 113****EDITOR MENU REFERENCE 115****EDITOR MENU BAR 115****FILE MENU 115**

- New Patch {Ctrl-N} 115
- New Performance 115
- Open {Ctrl-O} 115
- New To 115
- Open To 116
- Save {Ctrl-S} 116
- Save As 116
- Save All 116
- Save From 116
- Save InitPatch1 & 2 116
- Recent Files 116
- Quit {Ctrl-Q} 116

EDIT MENU 117

- Undo {Ctrl-Z} 117
- Redo {Ctrl-Y} 117
- Cut {Ctrl-X} 117
- Copy {Ctrl-C} 117
- Paste {Ctrl-V} 117
- Clear 117
- Paste Params {Ctrl-E} 117
- Select All {Ctrl-A} 117

PATCH MENU 118

- Patch Settings {Ctrl-P} 118
- Textpad {Ctrl-H} 119
- Delete Unused Modules 119
- Download To Slot {Ctrl-D} 119

PERFORMANCE MENU 119

- Performance Settings {Ctrl-R} 119
- Download 120

SYNTH MENU 120

- Synth Settings {Ctrl-G} 120
- Upload Active Slot {Ctrl-U} 122
- Save In Synth 122
- Bank Upload (From Modular) 123
- Bank Download (To Modular) 124
- Send Controller Snapshot {Ctrl-M} 124
- Dump one {Ctrl-1} 125

SETUP MENU 125

- Options 125

TOOLS MENU 125

- Parameter Pages {Ctrl-F} 125
- Using Parameter pages to make knob assignments 126
- Parameter Overview {Ctrl-L} 126
- Using Parameter Overview to make knob assignments 126
- Virtual Keyboard {Ctrl-K} 128
- Patch Browser {Ctrl-B} 128
- Assign midi to Selection 130
- Deassign midi to Selection 130
- Deassign All midi 130
- Extended Toolbar {Ctrl-T} 130

WINDOW MENU 130

- Close {Ctrl-W} 130
- Close All 130
- Cascade 130
- Tile horizontally 131
- Tile vertically 131
- Tile Active Slots {Ctrl-I} 131
- Tile All Slots 131
- Currently open Patches/Performances 131

HELP MENU 131

- Contents/Search/Index 131
- Keyboard Shortcuts 131
- About 131

COMPUTER KEYBOARD SHORTCUTS 131

TECHNICAL REFERENCE 134

SIGNAL TYPES IN A PATCH 134

- Definitions 134
- Audio signals, red connectors 135
- Control signals, blue connectors 135
- Logic or gate signals, yellow and orange connectors 135
- Bandwidth considerations 137
- Resolution and audio signal headroom 137
- Self-optimizing modules 137
- Experiment! 138

VOICE ALLOCATION AND POLYPHONY 138

CALCULATION ORDER FOR THE MODULES 139

UPDATING THE SYNTH OS 140

MIDI IMPLEMENTATION 141

WHAT IS MIDI? 141

MIDI GLOBAL CHANNEL 142

MIDI CONTROLLERS 143

MIDI AUTOMATION 144

- MIDI-Learn function (L key) 145
- Troubleshooting MIDI CC#'s 145
- MIDI CC# Auto assignment function 146
- MIDI Talkback function 147
- The G2 as a MIDI controller box 147

G2 MIDI SYSTEM EXCLUSIVE SPECIFICATION 148

MIDI IMPLEMENTATION CHART 153

MODULE REFERENCE 155

IN/OUT GROUP 156

- Common In/Out module parameters and definitions 156
- 2-Out 157
- 4-Out 157
- 2-In 158
- 4-In 158
- FX-In 158
- Keyboard 158
- MonoKey 159
- Device 160
- Status 160
- NoteDet 162
- Name 163

NOTE GROUP 164

NoteQuant 164
KeyQuant 164
PartQuant 165
NoteScaler 167
Glide 168
PitchTrack 168
ZeroCnt 169
LevScaler 170

OSCILLATOR GROUP 172

Common Oscillator parameters 172
OscA 174
OscB 175
OscC 176
OscD 176
OscPM 176
OscShpA 176
OscShpB 178
OscDual 179
OscString 180
OscPerc 181
DrumSynth 181
Noise 182
MetNoise 182
OscNoise 183
OscMaster 183
Operator 184
DXRouter 185

LFO GROUP 187

Common LFO parameters 187
LfoA 189
LfoB 189
LfoC 189
LfoShpA 189
ClkGen 191

RANDOM GROUP 193

Common random generator parameters 193
Clocked random generator inputs and parameters 194
RandomA 195
RandomB 195
RndClkA 196
RndClkB 196
RndTrig 196
RndPattern 196

ENVELOPE GROUP 197

Common Envelope Generator parameters 197
EnvADSR 200
EnvH 200
EnvD 201
EnvADR 201
EnvAHD 201
EnvADDSR 202
EnvMulti 202
ModAHD 202
ModADSR 203

SHAPER GROUP 204

Common Shaper parameters 204
Clip 205
Overdrive 205
Saturate 206
ShpExp 206
WaveWrap 206
ShpStatic 206
Rect 207

FILTER GROUP 208

Common Filter parameters 208
FltLP 209
FltHP 209
FltNord 209
FltClassic 210
FltMulti 211
FltStatic 211
WahWah 211
FltVoice 211
Vocoder 212
EqPeak 213
Eq2Band 213
Eq3Band 214
FltPhase 214
FltComb 215

MIXER GROUP 216

Common Mixer parameters 216
Mix1-1A 217
Mix1-1S 217
Mix2-1A 217
Mix2-1B 217
Mix4-1A 217
Mix4-1B 218
Mix4-1C 218
Mix4-1S 218
Mix8-1A 218
Mix8-1B 218
MixFader 219
MixStereo 219
Pan 219
X-Fade 219
Fade1-2 220
Fade2-1 220

SWITCH GROUP 221

Common Switch parameters 221
SwOnOffM 222
SwOnOffT 222
Sw2-1M 222
Sw2-1 222
Sw4-1 222
Sw8-1 223
Sw1-2M 223
Sw1-2 223
Sw1-4 223
Sw1-8 223
ValSw2-1 223
ValSw1-2 223
WindSw 224
Mux8-1 224
Mux1-8 224
Mux8-1X 224
S&H 224
T&H 225

LEVEL GROUP 226

- Common Level module parameters 226
- Constant 226
- ConstSwM 226
- ConstSwT 226
- LevAdd 227
- LevConv 227
- LevAmp 227
- LevMult 227
- Ringmodulator 228
- LevMod 229
- EnvFollow 231
- NoiseGate 231
- CompLev 231
- CompSig 232
- MinMax 232
- ModAmt 233

LOGIC GROUP 234

- Common Logic module parameters 234
- Gate 235
- Invert 235
- FlipFlop 235
- ClkDiv 236
- Pulse 236
- Delay 237
- 8Counter 237
- BinCounter 238
- ADConv 238
- DACConv 238

SEQUENCER GROUP 240

- Common Sequencer parameters 240
- SeqEvent 242
- SeqVal 243
- SeqLev 243
- SeqNote 243
- SeqCtr 244
- Sequencing examples 244

FX GROUP 248

- Common FX group parameters 248
- StChorus 248
- Phaser 248
- Flanger 249
- Digitizer 249
- FreqShift 249
- PShift 250
- Scratch 251
- Reverb 251
- Compress 252

DELAY GROUP 253

Common Delay group parameters 253

DlySingleA 254

DlySingleB 254

DelayDual 254

DelayQuad 254

DlyEight 254

DlyShiftReg 254

DlyClock 255

DelayA 255

DelayB 255

DlyStereo 255

MIDI GROUP 256

Common MIDI module parameters 256

CtrlSend 256

PCSend 257

NoteSend 258

CtrlRcv 259

NoteRcv 259

NoteZone 260

Automate 260

KEYBOARD SHORTCUTS 262**SYNTHESIS BASICS 264****SUBTRACTIVE SYNTHESIS 264**

Modules - the building blocks 264

CONNECTIONS 265**THE OSCILLATORS AND WAVEFORMS 265**

Pitch 265

Waveform 266

THE FILTER 270

Filter types 271

Roll-off (slope) 272

Cutoff frequency 273

Resonance 274

THE AMPLIFIER 274**ENVELOPES 275**

ADSR-Envelope 275

AD-Envelope 278

LFOs 278**ADDITIVE SYNTHESIS 279**

Creating a waveform 279

OTHER SYNTHESIS AND MODULATION METHODS 280

FM synthesis 280

AM synthesis 280

Ring modulation 281

1. INTRODUCTION

WELCOME!

Thank you for choosing the Nord Modular **G2** synthesizer and welcome to the fascinating world of modular synthesis. Prepare yourself for a journey where your creativity can reach new levels, in a way that has not been conceivable with synthesizers before (except with the previous Nord Modular family). As you will find out in a few minutes, the Nord Modular **G2** manages to go where no modular synthesizer has ever gone before.

ABOUT THE NORD MODULAR G2 SYSTEM

The Nord Modular **G2** system consists of two parts: the synthesizer, which will be named *the synth* or **G2** from now on, and the editor software, which is named the Editor. The **G2** hardware itself is a polyphonic MIDI synthesizer, the Editor is used to upload the synth with different sounds which were stored on a computer or to create sounds yourself. You will find the Editor software on the CD that is included in the back of this manual.

The Nord Modular **G2** system comes in three different hardware models:

- The basic Nord Modular **G2** with a three-octave keyboard, Pitchstick and Modwheel
- The large Nord Modular **G2X** with a five-octave keyboard and the **G2** expansion board fitted as standard plus two extra Global ModwheelAftertouchs plus a goose-neck dynamic microphone
- The 1U high 19-inch rack mountable Nord Modular **G2 ENGINE**, offered as a **G2** system computational engine without any panel controls

ABOUT THIS MANUAL

Every time this manual wants your attention to an object on the synth panel, the name of that object will be printed **LIKE THIS**, e.g. 'press the **STORE** button'. The LCD displays on the **G2** synth are always referred to as the **DISPLAYS (MAIN OR ASSIGNABLE)** and the computer monitor is always referred to as the 'screen'. Whenever there is a reference to the 'keyboard' it means the three or five octave keyboard on the synth *or* to any incoming MIDI notes to the synth. The parts of the manual that describe operation from the synth frontpanel *do not* apply to the rack mountable Nord Modular **G2 Engine**. Since the Nord Modular **G2 Engine** lacks the hardware user interface from the other **G2** family models, it has to be programmed entirely from the Editor! Therefore, if you have the Nord Modular **G2 Engine**, please refer to the chapters that describe operation from the Editor.

READING THE MANUAL IN ADOBE ACROBAT READER

This manual is also available as a PDF file. It can be downloaded, free of charge, from Clavia's web site at <http://www.clavia.se>. When reading the manual as PDF file, you will need Adobe Acrobat Reader 4.0 or later. This program can be downloaded, free of charge, at <http://www.adobe.com>.

With Adobe Acrobat Reader it is possible to use special navigation features like hyperlinks. This means that you can click with the mouse on a word or sentence and automatically get to the location indicated by the word/sentence. To better show what words or sentences are hyperlinked in this manual, these words are written in **purple** color.

CLAVIA ON THE INTERNET

If you have access to the Internet, you can check out the Nord Modular **G2** section at Clavia's web site. There, you will also find a sound library with Patches for the Nord Modular **G2** system. Point your browser to <http://www.clavia.se>.

In the **G2** section of the Clavia website you will also find links to a Nord Modular **G2** dedicated Mailing list and Forum, maintained by the Nord Modular **G2** user community.

G2 BASICS

In the following paragraphs some definitions of the basic principles used in the **G2** are explained. You will need to read these paragraphs to better understand what the **G2** is all about.

MODULAR SYNTHESIS

The Nord Modular **G2** synthesizer is an electronic musical instrument that remains true to the traditional modular synthesis concept. This concept of modular synthesis means that all sounds are generated by a freely configurable set of *modules*. Each module will have a specific function in the sound that you create or process. The modules themselves are easy to use, most modules look and feel similar to the devices most musicians are familiar with, like a wahwah pedal, phaser stompbox, a tape echo, delayline, a vocoder, etc. Just like these mentioned devices, the **G2** modules have inputs and outputs. Connecting the modules is as easy as plugging a cable from the output of an electric piano into the input of a power amplifier. The amount of modules needed for a specific sound depends on how complex you want that sound to be. There are many different modules available, all specialized to have a specific function in a sound. Some modules are used to generate raw audio signals like waveforms, others modify the waveforms by filtering, distortion or controlling the loudness dynamics like attacks and decays. Additionally there are modules which can mix signals together or switch between signals, add effects like echo and reverb, modules to sequence notes or modulation patterns, modules to manage MIDI or react on outside events and play controllers, etc.

The current **G2** system software V1.4x contains over 160 different types of modules to work with. All modules are described in detail in the Module Reference section in this manual and in the Help-file of the **G2** Editor software.

PATCHES

The name **PATCH** is traditionally used for how specific types of sounds are set up on a modular synthesizer. Basically a **PATCH** defines which modules are used and how they are cabled up. Examples are a **PATCH** that can be a ready-to-play model of a certain vintage synthesizer, a **PATCH** that creates a Phaser effect on audio coming in on an external audio input, a **PATCH** that creates the sound effect of a thunderstorm, etc. A **PATCH** can produce one particular sound like a synth lead, or several sounds at once like in a drumkit, depending on how many sound sources are used in the **PATCH**.

Think of a **PATCH** as a *complete synthesizer* that you can play in either polyphonic or monophonic mode. If a Patch is monophonic it can optionally be played in Legato mode to bind the notes in the same way as

on traditional monophonic synthesizers from the past. If a patch is played polyphonic it can use up to thirtytwo voices, depending on the complexity of the sound.

PATCHES made on the **G2** can be stored in the internal memory banks of the synth and/or saved on the computer as a Patch-file. Patch-files can be exchanged with other **G2** owners, e.g. by storing them on a floppy disk or sending them over the Internet through email. Patch-files have the file-extension ***.PCH2**.

Even though you have to use the Editor to create your own Patches, it is possible to use the Editor program to only transfer Patches from the computer to the synth, then disconnect the synth from the computer and use the synth as a stand-alone synthesizer on stage. This solution makes the Nord Modular **G2** system extremely flexible and portable.

Additionally, sounds can be dumped over MIDI by the push of a button from the **G2** panel of the **G2** Keyboard and **G2X** models or from the **G2** Editor software. Such a dump can be stored into a MIDI-file using common MIDI sequencer programs. Meaning that sounds contained in MIDI-files can be uploaded from a MIDI sequencer program, even without using the **G2** Editor program. It is common practice in recording studios to store sounds this way in the 'song', 'arrangement' or 'project' file of a MIDI sequencer program, to always guarantee the correct sounds for the song.

The Nord Modular **G2** has 4096 memory locations to store Patches (32 Banks with 128 memory locations each). The size of a Patch in memory depends on the complexity of the Patch, very complex Patches use more memory, decreasing the total amount of patches you can store in the **G2** Patch Banks. The Banks should therefore be considered more like the "folders" you find on a computer.

VARIATIONS

Each **PATCH** can contain up to 8 different complete parameter setups which are named **VARIATIONS**. A Nord Modular **G2** **VARIATION** is a complete setup of module knob and push button settings *plus* all patch settings like Arpeggiator On/Off, etc. In other words, it's possible to have up to eight completely different "sounds" as **VARIATIONS** in each Patch. **VARIATIONS** can instantly be *selected* by pressing one of the **VARIATION** buttons. If you compare a **PATCH** in the Nord Modular **G2** with a traditional hard-wired synth, a **G2** **VARIATION** is like a 'Sound', 'Program' or 'Preset' in that synth, ready to be instantly recalled.

All **VARIATIONS** in a Patch are automatically stored within a Patch or a Patch-file.

SLOTS

A Patch loads into a **SLOT**, which is the physical location from where a Patch can be played. A Slot has its own MIDI channel and can have its own keyboard split range and keyboard transposition. A **SLOT** can be considered an *individual instrument* for playing and editing. You activate a **SLOT** by pressing one of the **SLOT** buttons on the Nord Modular **G2** front panel.

There are four **SLOTS** labelled **A**, **B**, **C** and **D** on the Nord Modular **G2**. Any combination of these four **SLOTS** can be active at the same time. As you can load a different Patch in each **SLOT** you can play up to four Patches at the same time, by stacking them and/or using keyboard splits.

The **LED** below the **SLOT** button indicates that the Patch in the **SLOT** is actually loaded and active, and that it is using computational resources. If the Slot is inactive (LED is dimmed) there is actually still a Patch in the Slot, but the Patch is deactivated and is not using any computational resources.

The **LED** above the **SLOT** button will be lit to indicate that the **SLOT** is ready for playing by the *keyboard*. If a **SLOT** is active but the **SLOT** is not connected to the keyboard (only the lower **LED** lights up) the **SLOT** can still be played by incoming MIDI signals in the MIDI channel the **SLOT** is assigned to. The **MAIN**

DISPLAY shows the memory bank location from where the Patch was recalled, plus the name of the Patch as well as a possible Sound Category selected for the Patch.

PLAYING MULTITIMBRALLY

The **SLOTS** can receive MIDI information on separate MIDI channels, making the Nord Modular **G2** up to 4 part multitimbral. If you want to use the **G2** multitimbrally, you first have to load the Patches you want to layer into individual **SLOTS**. Hold down **SHIFT** and press the **SLOT** buttons you want to include in the multitimbral configuration. Then, simultaneously press the **SLOT** buttons for the **SLOTS** you want to play by the **G2** keyboard.

One of the active **SLOTS** has its active **LED** flashing, this is the *focused* slot, the slot that is ready for optional editing. You can change the focused **SLOT** by pressing the corresponding **SLOT** button of another active **SLOT**. To deactivate and reactivate **SLOTS** in a multitimbral setup, hold **SHIFT** and the desired **SLOT** button(s). The **MAIN DISPLAY** shows the memory location and the name of the Patch as well as the Sound Category for the *focused* Patch.

TIP! If you don't use a slot for play by the keyboard or play by incoming MIDI you should deactivate this **SLOT** to allow for more voices in the other **SLOTS**.

PERFORMANCES

A multitimbral setup of Patches in the four Slots can be stored as a **PERFORMANCE**. Basically a Performance *groups* up to four Slots with their Patches together, with the individual keyboard split and zone settings for each Slot. By recalling a Performance which was saved earlier, the complete setup of all four Slots and their Patches is immediately recalled. You can go into and out of Performance Mode by just one single pushbutton. Storing a **PERFORMANCE** will store all four Slots, including what is in the inactive Slots.

PERFORMANCES have their own memory banks, separate from the memory banks where Patches are stored. This means that the Patches which are saved in a **PERFORMANCE** lose their relation to their original Patch when they are saved in a **PERFORMANCE** memory bank. So, changing a Patch in a **PERFORMANCE** will not change the original Patch stored in one of the Patch memory banks. This relieves you from keeping track of any changes you make to the Patches used in Performances.

SPECIAL FEATURES IN PERFORMANCES

The idea of a Performance is that it contains 'as much as possible' of what you need to perform a song, and you can recall all this 'at the push of a button'. A Performance in the Nord Modular **G2** system doesn't necessarily have to be just four layered/split Patches. It can also be four individual patches that you use in different parts of the song. Or a sequenced patch plus a patch which you use to play along with the sequence. Or three patches you play on the keyboard plus a patch controlling other equipment by using the MIDI OUT features of the Nord Modular **G2**. Or one patch you play from the keyboard plus three patches played by an external MIDI sequencer device.

The flexible routing possibilities within the Nord Modular **G2** system make it possible to internally route both audio and MIDI between Patches, which can make a **PERFORMANCE** a really powerful configuration. Imagine a Patch which controls another Patch in another Slot by sending it MIDI information. The four 'inter-slot' Audiobusses make it possible to have, for example, the audio output signals of three Patches in three Slots routed to a "global" audio Effects Patch in the fourth Slot, and additionally use the four Line In audio inputs, routing to the same or different audio Effects.

Performances can be used and configured in many different ways, for many different musical purposes and for many different musical styles.

Recalling a Performance from the **G2** Performance memory banks is virtually instantly. When stored on the computer **PERFORMANCE**-files will have the extension ***.PRF2**.

The Nord Modular **G2** has 1024 memory locations for Performances (8 Banks with 128 memory locations each). Since a Performance can be quite large (around 15-20 kB), it's not likely that you will be able to use all Performance memory locations. The Banks should therefore be considered more like "folders" to store different projects. A Performance-file stores information about which Slots should be active, layered and also any Keyboard Split settings plus a number of other settings.

FOCUS

An often used expression in this manual is "focus". For example, you can put a Slot, a Patch Variation or a sound parameter in a Patch "in focus". This simply means that the focused object is currently selected and enabled for editing. The focused object will be the only object affected by the editing.

MODULES

Modules are the basic building blocks used to build up a sound. A Module in the Nord Modular **G2** can be, for example, an oscillator to control pitch, an envelope generator to control the volume dynamics, a filter to control the timbre, a step sequencer to play patterns, etc. There are currently over 160 different types of modules available in the **G2** system. The **G2** is not limited to use only one module of a specific type in a Patch. Several identical modules can be used together, creating, for example, really fat multi-oscillator sounds. You can add modules until all computational resources are in use. Adding an expansion board to your system will double the computational resources and allows four more voices in Patches. The **G2X** model is factory fitted with an expansion board as standard, giving you the maximum power right out of the box.

Note! To create a totally new Patch, with your own setup of modules and signal routing between the modules, you can use the Windows PC or Mac OSX version Editor application that is on the CD in the back of this manual.

PARAMETERS

There are usually one or more sound parameters in each module, e.g. the parameter that sets the basic pitch of a sound or the tempo of a modulation pattern. A parameter can be controlled by a knob, a slider, a pushbutton or a selector switch with 'radiobuttons'. In fact, you can think of a parameter as a 'knob to tweak'. You change the setting of a parameter either with an **ASSIGNABLE KNOB/BUTTON** on the synth front panel or with the mouse in the Editor software.

ASSIGNABLE KNOBS/BUTTONS

On the frontpanel are eight **ASSIGNABLE KNOB/BUTTON** combinations which can be linked to the parameters of the modules used in a Patch. This will turn the 'virtual control' on a module into a 'real world' knob or pushbutton on the frontpanel. The **ASSIGNABLE KNOBS** are endless rotary dials with LEDs that roughly indicate the current position/value of the knob. The **ASSIGNABLE BUTTONS** are placed under the **ASSIGNABLE KNOBS** and have a LED that indicates if the button function is On or Off. The exact values of the knobs and buttons is displayed in the four associated **DISPLAYS** above the **ASSIGNABLE KNOBS**.

PARAMETER PAGES

The eight **ASSIGNABLE KNOBS/BUTTONS** on the G2 frontpanel give access to parameters grouped in one of fifteen **PARAMETER PAGES**. These fifteen **PARAMETER PAGES** are arranged in a matrix with a width of three pages and a height of five pages. The five pages in one column each have a character

assigned to them: **A** to **E**. The three pages in a row have a number assigned to them: **1** to **3**. Each **PARAMETER PAGE** can be selected by referencing the character and the number, like **PAGE A1** or **PAGE D2**. You can access the eight **ASSIGNABLE KNOBS/BUTTONS** in a certain page by pressing the corresponding buttons in the panel section named **PARAMETER PAGES**. The **PARAMETER PAGES** concept gives you quick and easy access to a total of 120 **ASSIGNABLE KNOBS/BUTTONS** in a Patch. Additionally there are 15 **GLOBAL PARAMETER PAGES** where a total of 120 **ASSIGNABLE KNOBS/BUTTONS** can be assigned to knobs and pushbuttons in a mix from all four Slots. One button lets you instantly switch between the **PARAMETER PAGES** in a patch and the **GLOBAL PARAMETER PAGES**.

MORPHS

MORPHS allow you to tweak several parameters at once by *one physical play controller*, like by a Modwheel or the Keyboard Aftertouch. Which basically means that one physical controller will 'play' several module knobs at once. Each parameter can have its individual **MORPH** range. In total there are eight **MORPH** groups, each associated with its own physical controller. A total of twentyfive parameters can be assigned to the **MORPH** groups. **MORPHS** can be instantly assigned and their **MORPH** ranges adjusted with the panel controls on the **G2** and **G2X** models.

2. SYNTH QUICK TOUR

This chapter refers to the G2 Keyboard and G2X models. If you have a G2 Engine model you can still read this chapter if you desire to do so, as virtually all described G2 Keyboard and G2X panel functions are also available as ‘soft’ functions in the Editor program.

CHECKING OUT THE INSTRUMENT FIRST

The G2 synthesizers are crafted as fine musical instruments that let themselves be played expressively. They come with an extensive set of factory sounds in different musical styles, from traditional keyboard styles to hardcore underground noises. You are strongly advised to first check out the G2 system as the stand-alone performance synthesizer it really is, before considering to connect your Nord Modular G2 Keyboard or G2X to a computer to run the Editor program. The reason that you are given this advice is simply that if you first discover what your G2 can do for you as the expressive musical instrument it is, it will be much easier to later use the Editor software to create perfectly playable sounds for you. Sounds that will better suit *your* style of music and playing skills. After all, it is all about making music. If you go through this and the next chapter step by step, and try out every step immediately, you will get to know your new instrument intimately in no time. And have fun while you play...!

CHECK OUT SOME PATCHES!

Before installing and starting to use the Editor software, let’s have a look at the Nord Modular G2 synthesizer and check out some internal sounds and basic functions. Turn on the power!

When you have turned on the Nord Modular G2, a Patch is automatically loaded in Slot A and the Patch name shows up in the MAIN DISPLAY. Then, if necessary, press the PARAMETER PAGE A button to the upper right to make the 4 ASSIGNABLE DISPLAYS show some of the assigned Patch parameters. In the 4 ASSIGNABLE DISPLAYS, 8 different Patch parameters are displayed together with their current values. Below the ASSIGNABLE DISPLAYS, the 8 LED GRAPHS around the ASSIGNABLE KNOBS show the parameters’ coarse values. Now, if you turn one of the ASSIGNABLE KNOBS to make changes to the sound, the LED GRAPH will change and the exact value will be shown in the ASSIGNABLE DISPLAY above the knob.



The Patch that you just loaded (and in fact all Patches) contains eight different sounds, named VARIATIONS. Just above the middle of the keyboard you see a row of nine buttons and the left most

eight are numbered **1** to **8**. Play some notes on the keyboard and press one of these numbered **VARIATIONS** buttons. Listen to how these **VARIATIONS** are indeed complete new sounds, although all based on the same Patch.

Now tweak some of the **ASSIGNABLE KNOBS** while you play some notes on the keyboard. Listen to how the sound changes. When you have lost the original sound by too much tweaking you can immediately restore the original sound of a **VARIATION** by keeping the grey **SHIFT** button pressed and press the numbered button for the **VARIATION** which has its LED blinking.

ACCESS MORE ASSIGNED PARAMETERS IN THE PATCH

To the bottom right of the front panel are **5+3** programmable **PARAMETER PAGES** selection buttons. See also *“Parameter pages” on page 19.*

Pressing the **A** and the **2** buttons give access to **PARAMETER PAGE A2**. Now, 8 new parameters are shown in the **ASSIGNABLE DISPLAYS** and you can edit them right away. If you press the **3** button, another 8 parameters are displayed. You can continue by pressing other combinations to check out more assigned parameters. The **PARAMETER PAGES** buttons are conveniently arranged in a way that you can press two buttons simultaneously at once with two fingers for super fast Page selection.



VARIATIONS

Below the 8 **ASSIGNABLE KNOBS** are 8 **VARIATION BUTTONS**. See also *“Variations” on page 17.*

The LEDs above the buttons show which **VARIATION** is currently active. Select another **VARIATION** by pressing another **VARIATION** button.

VARIATIONS can be *selected plus restored* by pressing **SHIFT** plus the **VARIATION** button. This will restore the knob settings to the same positions as when the patch was loaded from memory.

This **SHIFT-VARIATION1-8** ‘select and restore’ function is indispensable when playing on stage, as it undoes all the tweaks in an earlier played **VARIATION**. If you go wild on expressively tweaking the sound during a stage performance, **SHIFT-VARIATION1-8** gives you immediate and reliable control over what sound to play next, no matter the earlier tweaks you did on that sound.



LOAD A NEW PATCH FROM THE INTERNAL MEMORY

Load a new Patch into the active Slot (Slot A in this example) by first turning the **ROTARY DIAL** to select the Patch. If you like you can also switch between Banks by pressing the **UP/DOWN NAVIGATOR** button. Load a Patch into the Slot by first turning the **ROTARY DIAL** to select the Patch, then press the **PATCH LOAD** button to load and activate the Patch for play. Now, you can try out other Patches from the



internal memory banks, tweak the parameters knobs and check out different Variations as described above.

Note that to be able to load individual Patches the Performance Mode LED should be OFF.

CHECK OUT SOME PERFORMANCES

A Performance is a *combination of up to four Slots*. See also “[Playing multitimbrally](#)” on page 18 and “[Performances](#)” on page 18.

Enter Performance mode by pressing the **PERFORMANCE MODE** button (button LED lights up). Load a Performance into the Slots by first turning the **ROTARY DIAL** to select the Performance, then press the **PATCH LOAD** button to load and activate the Performance for play. As you can see, several **SLOT LEDs** are now lit to indicate that several Patches are used in the Performance. The Performance name is shown in the **MAIN DISPLAY** and the first 8 parameters of the focused Patch are shown in the **ASSIGNABLE DISPLAYS**.

Note that a Performance always loads in all four Slots, storing any previously loaded Patches in the Slots in a temporary buffer, so changing back to Patch mode will reload those previously loaded Patches before Performance mode was activated. Also note that in the loaded Performance not all Slots need to be active. If a Slot LED does not light up it simply indicates that this Slot is inactive.



ACCESS ASSIGNED PERFORMANCE (GLOBAL) PARAMETERS

Each Performance can have a separate set of **GLOBAL PARAMETER PAGES**, in addition to the Parameter Pages of each Patch in the Performance. See also “[Parameter pages](#)” on page 19 and “[Global \(Performance\) Parameter Pages](#)” on page 49.

Hold down **SHIFT** and press the **PATCH SETTINGS** button to access **GLOBAL PARAMETER PAGE A1**. Alternatively you can ‘double click’ the **PATCH SETTINGS** button. Now, 8 new parameters are shown in the **ASSIGNABLE DISPLAYS** and you can edit them.

If you go to the **PAGE A2**, another 8 Performance parameters are displayed, and so on. If you want to access the Programmable Parameter Pages of each individual Patch, hold down **SHIFT** and press the **PATCH SETTINGS** button again. Alternatively you can ‘double click’ the **PATCH SETTINGS** button. Now, the first Parameter Page of the Patch in the focused Slot is shown in the **ASSIGNABLE DISPLAYS**.

This means that a total of 600 knob assignments can be stored in a Performance, 120 for each Slot plus and extra 120 in the Global pages. The assignments in the Global pages can be a mix of module knob assignments from all four Slots. Note that globally assigned knobs do *not* have to be previously assigned in the individual Slot pages themselves.



LOADING ANOTHER PERFORMANCE FROM THE INTERNAL MEMORY

Load another Performance into the Slots by first turning the **ROTARY DIAL** to select another Performance. If you like you can also switch between Banks by pressing the **UP/DOWN NAVIGATOR** button. Then load the selected Performance into the Slots by pressing the **PATCH LOAD** button. Now, you can try out other Performances of the internal memory and edit parameters as described above.

To revert to “Patch mode”, press the **PERFORMANCE MODE** button. If the **PERFORMANCE MODE LED** turns OFF you’re back in Patch Mode.



CHANGING VARIATIONS WHEN IN GLOBAL PANEL MODE

Changing **VARIATIONS** differs for when the **G2** is in **PATCH PANEL** mode where the **ASSIGNABLE KNOBS/DISPLAYS** show Parameters from the active Slot, or when the **G2** is in **GLOBAL PANEL** mode (the **GLOBAL PANEL LED** lights up), where the **ASSIGNABLE KNOBS/DISPLAYS** can show a mix of Parameters from all Slots/Patches.

When in **GLOBAL PANEL** mode, selecting another **VARIATION** with one of the **VARIATION** buttons will cause *all active* Slots to switch to this selected **VARIATION**. However, when the **G2** is in **PATCH PANEL** mode (the **GLOBAL PANEL LED** is dimmed), selecting another **VARIATION** will only change the **VARIATION** for the *focused* Slot.



3. WORKING WITH THE SYNTH

This chapter refers to the G2 Keyboard and G2X models. If you have a G2 Engine model you can still read this chapter if you desire to do so, as virtually all described G2 Keyboard and G2X panel functions are also available as ‘soft’ functions in the Editor program.

NORD MODULAR G2 AND G2X FRONT PANEL

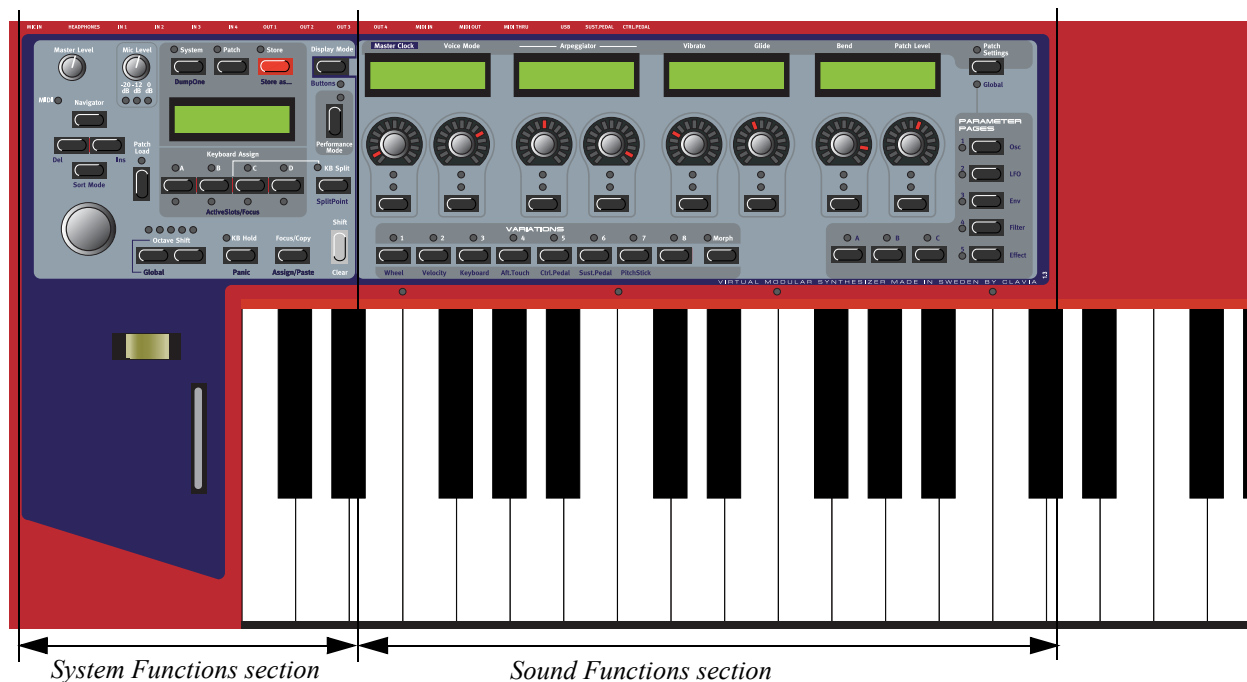

The frontpanel is divided in two sections, the **SYSTEM FUNCTIONS** section at the left side and the **SOUND FUNCTIONS** section at the right side.

In the **SYSTEM FUNCTIONS** setting you can recall sounds from the **G2** sound banks, change modes for multitimbral play and layering of sounds, edit system default settings, MIDI settings, etc. All system settings changes you make in this section will be immediately memorized by the **G2** and when the **G2** is powered up it will use the settings that were last made before the **G2** was powered down.

In the **SOUND FUNCTIONS** section you can make edits to the sound or sounds you are currently playing. This **SOUND FUNCTIONS** section is designed to give you easy access to all tweakable knobs and buttons in a sound. A modular system can have many knobs to tweak, much more than the eight physical knobs and buttons located under the four displays. The **G2** uses a clever paging system named **PARAMETER PAGES** to access up to 120 tweakable parameters in a single sound. To make the changes to a sound definitive, the sound can be stored in the **G2** sound memories. Use the Store function in the System Functions section to save your tweaks.

SYSTEM FUNCTIONS SECTION

MASTER LEVEL

The **MASTER LEVEL** knob controls the output level of all four **OUT** jacks and the **HEADPHONES** output. Use this knob to set the overall volume level of your instrument or set the sound level when using headphones.

Tip! The Master Level knob does not send or receive any MIDI CC# information, but is only used to control the entire instrument's output level. To affect the volume of an individual Patch through MIDI (e.g. from a sequencer track), you can use MIDI CC#7, which is hardwired to the Patch Gain knobs in the respective Slots (see more about this on ["Patch Level" on page 62](#)).



MIDI LED

The **MIDI LED** indicates incoming MIDI Note, MIDI CC# and MIDI SYSEX messages on any MIDI channel. MIDI messages on any of the Slot's MIDI Channels and/or the Global MIDI Channel are indicated by *long* LED blinks. Messages on other MIDI Channels are indicated by *short* LED blinks. Long LED blinks means that there should most probably be sound, and short LED blinks mean that there is MIDI information received but ignored, as this information is not in MIDI channels the Slots are 'listening to'.



MIC LEVEL

The **MIC LEVEL** knob controls the XLR microphone input preamp level. Below the **MIC LEVEL** knob are three **LEDS** which show the input level of the dynamic microphone connected to the **XLR INPUT** on the rear panel. If you don't use a mic, the **LEVEL LEDS** will indicate the input level of the line level signal routed to the **IN 1** input instead. Note that the **MIC LEVEL** knob only affects the **XLR INPUT** - not the **IN 1** input.



SYSTEM, PATCH AND STORE BUTTONS

Above the **MAIN DISPLAY** are the **SYSTEM** (see ["Edit System Settings" on page 29](#)) and **PATCH** (see ["Accessing \(Edit\) any Parameter in a Patch" on page 37](#)) buttons which can be used to enter all system and Patch related menus. The **STORE** button (see ["Store a Patch" on page 40](#) and ["Storing a Performance" on page 50](#)) is used for storing Patches and Performances.



NAVIGATOR BUTTONS, ROTARY DIAL AND MAIN DISPLAY

Below the **MASTER LEVEL** knob is a set of four buttons, the **NAVIGATOR** buttons. These are used to navigate in the **MAIN DISPLAY** and to select different functions. Below the **NAVIGATOR** buttons is the **ROTARY DIAL**. With the **ROTARY DIAL** you can select Patches and Performances, enter various kind of data etc.

Note that the functions for the **NAVIGATION BUTTONS**, the **ROTARY DIAL** and the **MAIN DISPLAY** will change when the **G2** is set to a different mode. Modes can be changed by pressing either the **SYSTEM**, the **PATCH**, the **STORE** or the **PERFORMANCE MODE** button.

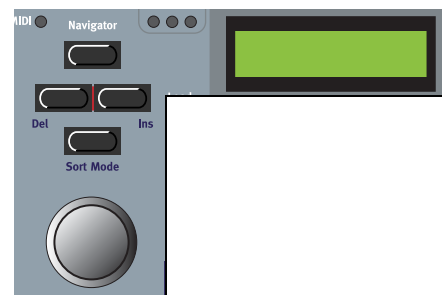

LOAD PATCH

Press this button when you want to load a selected Patch or Performance into the focused Slot/Slots (see ["Search for and load a Patch" on page 36](#) and ["Load a new Performance from the internal memory" on page 48](#)).

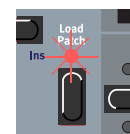

SLOT BUTTONS

Below the **MAIN DISPLAY** are the four **SLOT** buttons (**A**, **B**, **C** and **D**). You can load one Patch in each of the Slots at a time. See “[Sound Functions section](#)” on page 33, “[Activate several Slots](#)” on page 43 and “[Creating a Performance](#)” on page 48 for info on how to use the Slots.

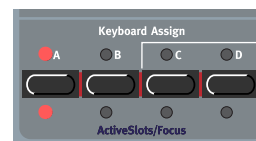

OCTAVE SHIFT BUTTONS

With these buttons you can either transpose a Patch in a Slot or transpose the whole Keyboard globally over a range of +/-2 octaves.

In *Patch Transpose* mode, the **OCTAVE SHIFT** buttons transpose each of the Slots individually. In this mode the keyboard itself is *not* transposed. The Patch transposition takes effect immediately. In Patch Transpose mode only one of the five LEDs will light up. When pressing **SHIFT** plus the *left* **OCTAVE SHIFT** button the LEDs will *invert*, meaning that all LEDs but one light up. This puts the octave shift controls in *Global Octave Shift* mode which will transpose the *keyboard* globally instead of only the Slot. When in Global Octave Shift mode all Slots will be transposed equally. The notes played on the keyboard that are sent as MIDI NoteOn through the **MIDI OUT** jack of the synth will also be transposed, meaning that in this mode the **G2** keyboard acts like a Master Keyboard.



KB HOLD/PANIC

Press the **KB HOLD** button to make every note or chord you play sustain until you press any new keys. The Keyboard Hold function is also very useful together with the Arpeggiator (see “[Arpeggiator](#)” on page 35). If notes should hang or the synth should behave strange, press **SHIFT+KB HOLD** to send an internal ALLNOTESOFF to the synth.



THE FOCUS/COPY/(ASSIGN/PASTE) BUTTON

To the right below the **MAIN DISPLAY** section you find the **FOCUS/COPY** button. This button can be used in many situations, for example when you want to copy & paste various things and also when you assign parameters to Parameter Pages. Holding **SHIFT+FOCUS/COPY** alternates the functionality to Assign/Paste.

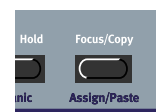

PERFORMANCE CONTROLS

Below the **MAIN DISPLAY** section you find the performance controls: the **PITCH STICK** and **MODWHEEL**. The **PITCH STICK** can be used to control pitch bend (see “[Bend](#)” on page 35) as well as an entire Morph group. The **MODWHEEL** can control Vibrato (see “[Vibrato](#)” on page 35) and also a separate Morph group. See “[Morph groups](#)” on page 44 for info on how to use these controls with Morph groups.

G2X GLOBAL MODWHEELS

The Nord Modular **G2X** model features two extra **GLOBAL MODWHEELS**. These wheels can control extra modulations. The **GLOBAL MODWHEELS** are hardwired to Morph groups 5 & 8 and can control any parameter in a Patch through these Morph groups. See “[Morph groups](#)” on page 44 for info on how to use these controls with Morph groups.

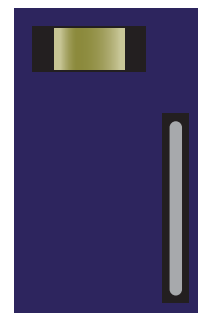

NOTE! In contrast to the standard Modwheel these two extra Modwheel are not affected by the keyboard focus, meaning that they also work in Patches played from external MIDI signals.

DISPLAY MODE

This button lets you switch between *two different display modes* for the **ASSIGNABLE DISPLAYS**. By default, the **ASSIGNABLE DISPLAYS** show module names and parameter names. When you turn an **ASSIGNABLE KNOB** or press an **ASSIGNABLE BUTTON**, the parameter name is temporarily replaced by the parameter value. In the other display mode, the parameter names and values are constantly displayed. However, the module names are not shown in this mode. Think of the Display having to show three lines of text, where the display mode lets you choose to see either lines 1 & 2 or see lines 2 & 3.

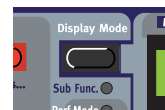

FltNord1-----	
Freq	Res

Freq	Res
622.5Hz	1.72

KB SPLIT MODE

Lets you split the keyboard and play/control Slots from a left hand and a right hand keyboard zone. The two left most Slots A and B will be assigned to the left hand keyboard zone, while the two Slots C and D will be assigned to the right hand keyboard zone. The split point can be altered by pressing the **KB SPLIT** button while holding the **SHIFT** button. Repeating **SHIFT/KB SPLIT** will move the keyboard split point. The LEDs directly above the keyboard show the current split point.

It is possible to make more advanced keyboard split settings through the system menu, see “[Keyboard Split](#)” on page 49 and “[Keyboard Zone |Pe](#)” on page 32.

SUB FUNC

Hold **SHIFT** and press the **DISPLAY MODE** button to go into **SUB FUNC** mode and display the names of *button parameters* instead of knob parameters in the **ASSIGNABLE DISPLAYS**. This is useful when you have assigned combined knob+button parameters to the **ASSIGNABLE DISPLAYS**.

PERFORMANCE MODE

In Performance mode you can create Keyboard Split/Layers configurations of up to 4 Slots. In Performance mode Pathes loaded to the four Slots can be saved and recalled together as a single Performance (file). See “[Performances](#)” on page 47. When the Performance button LED lights up it indicates the **G2** is in Performance mode. If the LED is dimmed it indicates the **G2** is in Patch mode.

**SWITCHING BETWEEN PATCH AND PERFORMANCE MODES**

Patch Mode and Performance Mode are completely separate modes, each with its own separate buffer to hold the Patches loaded in all Slots for that mode. This means that when changing to Performance mode, all Patches loaded in the four Slots in Patch Mode remain in their buffer. Switching back to Patch Mode will automatically bring up those four original Patches from the Patch Mode buffer again. Note that this ‘double buffering’ allows you to have up to eight Patches instantly standby, four Patches in Performance mode and four Patches in Patch mode. Simply pressing the **PERFORMANCE** button allows you to switch between these two sets of up to four Patches.

COPYING PATCHES BETWEEN PATCH AND PERFORMANCE MODES

Holding the **SHIFT** button while pressing the **PERFORMANCE** button will ‘transport’ a copy of the Patches to the other mode. This will overwrite the temporary Patch buffers for the Patch and the Performance modes. While in Patch mode, pressing **SHIFT-PERFORMANCE** will transfer a set of up to four Patches into a new Performance, which can then be stored as a Performance in the Performance memory banks. While in Performance mode, pressing **SHIFT-PERFORMANCE** will ‘separate’ the Performance into individual Patches to be played or edited in Patch mode.

KB SPLIT MODE/SET SPLIT POINT

Lets you split the keyboard and play/control different Slots from different keyboard zones. See “Keyboard Split” on page 49.

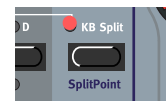

KEYBOARD SPLIT LEDS

Above the keyboard are four Keyboard Split LEDs which indicate current keyboard split position in Keyboard Split mode (see “Keyboard Split” on page 49). These LEDs only light up if the Keyboard Split is set up through the KB Split function on the front panel of the G2 Keyboard and G2X models. See also “Activate several Slots” on page 43 and “Layering Patches” on page 43.

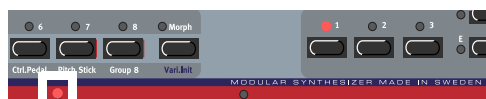

THE SHIFT/CLEAR BUTTON

The **SHIFT** button is used to activate functions printed below some buttons on the front panel. It’s also used for deleting entire Morph groups and for clearing Variations.

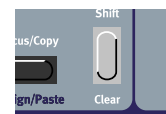

DUMP ONE

Hold down **SHIFT** and press the **SYSTEM** button to send a MIDI SYSEX dump of the Patch in the focused Slot, or of an entire Performance in Performance Mode. Note that an average MIDI SYSEX dump of a Patch is approximately 5 kB and that of a Performance nearly 20 kB. This means the recording device - a sequencer, for example - must be prepared for this amount of data.



It takes a MIDI cable about one second to transfer 3kB of data, so it might take up to seven seconds before a Performance Dump is completed. See also “G2 MIDI System Exclusive Specification” on page 148.

DUMP CC (SEND CONTROLLER SNAPSHOT)

Hold down **SHIFT** and press the **PATCH** button (**DUMP CC**) to send the values of all MIDI CC# controllers used in the Patch in the active Slot. See also “MIDI SendCtrl | Pa” on page 31, “MIDI Controllers” on page 143 and “MIDI Automation” on page 144.



EDIT SYSTEM SETTINGS

Press the **SYSTEM** button to access the system parameters and functions. The System menu is divided into three types of parameters:

1. System parameters, which are global for the entire synth (indicated in the **DISPLAY** by ‘|SY’ in the upper right corner). Note that changing System parameters has an effect at the ‘top level’ of the synthesizer, meaning that they will affect all Slots equally.
2. Patch parameters, which are unique for the currently focused Patch (indicated in the **DISPLAY** by ‘|PA’ in the upper right corner) Note that as changing a Patch parameter will only have an effect on the currently focused patch you will have to first select the Patch you want to apply a change to with the Slot buttons. You can do this by simply pressing the Slot button the Patch is in.



3. Performance parameters, which are unique for the currently active Performance (indicated in the **DISPLAY** by '|PE' in the upper right corner)

Note that some Performance parameters are actually a group of parameters for the Slots used in the Performance. The setting for each Slot can be different to that of the other Slots. Just like with the Patch parameters, you can select a Slot by pressing its Slot button and then change the Performance parameter for that particular Slot. But note that the settings for all the Slots used in the performance are actually saved in the Performance and not in the individual Patches.

Select a function with the **DOWN NAVIGATOR** button.

LIST OF FUNCTIONS IN THE G2 SYSTEM MENU

MASTER TUNE |SY

Use this function to transpose the keyboard in semitones and/or fine tune the synth to other instruments or already recorded tracks. The transposition range is from -6 to +6 semitones and is set with the

Master Tune	Sy
<u>0</u> semi	0 cent

ROTARY DIAL.

Note that if you want to transpose up from A to Bes you just go one semitone up. If you would need to transpose down from A to E you will have to go 5 semitones down, so the display shows '-5 semi'.

Transposing down from A to D is done by first transposing 5 semitones up and additionally set the Global Octave Shift for the keyboard one octave down with the Octave Shift buttons. This results in a total transposition of seven semitones down.

Fine adjustment ranges from -100 to +100 cents. 100 cents is one semitone. All Oscillator and Filter modules that are set to track the keyboard are affected by the Master Tune function. Select the fine tuning amount with the **ROTARY DIAL**.

MIDI LOCAL |SY

Turn the MIDI Local Control On or Off. Select Local On to be able to control the synth from the internal keyboard and the pedals. MIDI data is also transmitted via the MIDI OUT jack. In the Local Off mode, the keyboard and pedal actions are transmitted only via MIDI and *do not play the synth itself*.

MIDI Local	Sy
<u>On</u>	

Local Off is a function found on almost all MIDI synthesizers and is used with external MIDI sequencers. Imagine that the MIDI OUT jack of the synthesizer is routed back, via the external sequencer, to the MIDI IN jack. Now imagine that you play a note on the keyboard to play a sound on the synth, and this note is also sent out through MIDI to the sequencer. If the sequencer 'echoes' this note back to the synth, the note will be played a second time, now from the MIDI IN jack, which in general does not sound good. MIDI Local Off will prevent this, as in this mode only the 'echoed' note will sound. This way you can also be sure that the sequencer did actually receive the played note. MIDI sequencers do in general have a setting named ECHO that will set if the sequencer will or will not retransmit the received notes back. So, you will have to check the sequencer as well when making a change to this MIDI Local setting.

MIDI SLOT CH |SY

Set the MIDI channel for each **SLOT** (A-D). The set channels will be used for receiving and transmitting MIDI data. If you select 'Off', the Slot will not receive or transmit any MIDI data at all. Press desired **SLOT** button and set MIDI channel with the **ROTARY DIAL**. Then,

MIDI Slot Ch	Sy
<u>1</u>	2 3 4

repeat the procedure for the other Slots by pressing the corresponding **SLOT** buttons. Note that in Performance Mode, the internal keyboard will *send* on all Slot's MIDI channels that have Keyboard Assign.

MIDI GLOB CH | SY

Here you set the Global MIDI Channel for the synth. The Global MIDI Channel should be used for receiving MIDI note data and control data (Modwheel, Aftertouch, Velocity, Aftertouch and Pedals) if this data needs to be played by *all* Slots, no matter the MIDI channel they are in. The Global MIDI Channel should also be used for sending and receiving MIDI Program Change messages in Performance mode. Select Global MIDI Channel with the **ROTARY DIAL**. Range: Channel 1-16, Off. See also “MIDI Global Channel” on page 142.

MIDI Glob Ch | Sy
16

MIDI CLK SEND | SY

Here you choose whether or not to send out MIDI Clock to the **MIDI OUT** jack of the synth. Sending out a MIDI Clock signal will only work when you use the internal Master Clock as clock source. Select On or Off with the **ROTARY DIAL**.

MIDI Clk Send | Sy
Off

MIDI CLK RECV | SY

Here you choose whether or not to accept external MIDI Clock signals received on the **MIDI IN** connector at the back of the **G2**. If set to 'On', the Master Clock of the **G2** will automatically sync to any incoming MIDI Clock. Select On or Off with the **ROTARY DIAL**.

MIDI Clk Recv | Sy
Off

MIDI PRG CHNG | SY

Here you select how the synth should handle Program Change and Bank Select (MIDI CC# 32) MIDI messages. Select Off, Send (only), Receive (only) and Send and Receive with the **ROTARY DIAL**.

MIDI Prg Chng | Sy
Send & Receive

MIDI CTRL | SY

Here you select how the synth should handle MIDI CC# messages. Select Off, Send (only), Receive (only) and Send and Receive with the **ROTARY DIAL**.

MIDI Ctrl | Sy
Send & Receive

MIDI SENDCTRL | PA

This function lets you send the current values of all the MIDI CC# controllers that are used in a patch to the **MIDI OUT** connector on the back of the **G2**. This function can be used to record all current MIDI CC# values to one position in a song on a MIDI sequencer or MIDI recording software. Note that it takes a little time to send all MIDI CC# values.

MIDI SendCtrl | Pa
Press > to send

When the **G2** is controlled by an external MIDI controller device and the **MIDI OUT** at the back of the **G2** is connected to the **MIDI IN** of the controller device, this function can be used to instantly refresh the current values of the knobs and sliders on the MIDI controller. Using this function is often necessary after a variation change is initiated from the **G2** panel. Alternatively, the MIDI controller device can be programmed to send a SysEx command to the **G2** to initiate this function each time a variation change is initiated from the MIDI controller device. See also “1.5 All Controllers Request” on page 149. Press the rightmost (Ins) Navigator button to start the transmission over the **MIDI OUT** connector. The function can also be activated by holding down **SHIFT** and pressing the **PATCH** button (**DUMP CC**).

MIDI SysEx ID | Sy

Here you can set an ‘Instrument SysEx ID’. This is very useful if you’re sending SysEx dumps of sounds from a sequencer to the Nord Modular G2 and have several G2 synthesizers MIDI connected.

Let’s say you have two G2 synthesizers. These two instrument models have the same ‘Manufacturer ID’ and ‘Model ID’ in the SysEx protocol. By defining separate SysEx ID’s on each of the two synths, you will be able to “direct” the SysEx dumps from the sequencer to one of the G2’s while the other one will ignore the dumps. Just make sure that you define a separate SysEx ID before dumping the sounds to the sequencer. Select Instrument SysEx ID with the **ROTARY DIAL**. Range: 1-16, All. See also “G2 MIDI System Exclusive Specification” on page 148.

MIDI SysEx ID | Sy
16

SUST PED POL | Sy

Different sustain pedals use different polarity to activate the sustain switch. Select between ‘Open’ and ‘Closed’ with the **ROTARY DIAL**.

Sust Ped Pol | Sy
Open

CTRL PED GAIN | Sy

Different control/expression pedals have different characteristics. Here you can select Gain to adjust the control pedal functionality of the synth to your specific expression pedal. Select range (x1.00-x1.50) with the **ROTARY DIAL**.

Ctrl Ped Gain | Sy
x1.00

MEMORY PROT | Sy

Select memory protection for the entire internal Patch and Performance memory. Select On or Off with the **ROTARY DIAL**.

Memory Prot | Sy
Off

KEYBOARD ZONE | Pe

Here you can set individual note ranges for each of the Slots in a Performance. Press desired **SLOT** button and set lower note limit with the **ROTARY DIAL**. Press the **RIGHT NAVIGATOR** button and set the highest note limit with the **ROTARY DIAL**. Then, repeat the procedure for the other Slots by pressing the corresponding **SLOT** buttons. It’s also possible to have overlapping keyboard zones. Note that these ranges are also affected by any Keyboard Split setting you have in your Performance (see “Keyboard Split” on page 49). When you store your Performance, these settings will be stored with it.

Keyboard Zone | Pe
C-1 - B3

SUSTAIN PEDAL ON/OFF | Pa

Select if you want the Sustain Pedal functionality on or off in the Patch. If set to On, a connected sustain pedal will control both sustain and any parameters assigned to the Switch Morph group. Select On or Off with the **ROTARY DIAL**.

Sustain Pedal | Pa
On

VIBRATO RATE | Pa

Select Vibrato Rate for the Patch. Range: 4.00-8.00 Hz. (The Vibrato Amount is set in the Patch Settings “menu” for the Patch. See “Editing Patch Settings” on page 34).

Vibrato Rate | Pa
6.02 Hz

SYNTH NAME | Sy

Here you can name your synth. Select characters with the **ROTARY DIAL** and change the “cursor” position with the left/right **NAVIGATOR** buttons. Alternatively, press and hold the **DOWN**

Synth Name | Sy
ModularG2

NAVIGATOR button and select letters with the **ROTARY DIAL**. Each time you release the **DOWN NAVIGATOR** button the cursor in the **DISPLAY** advances one step. Repeat the procedure for the entire Synth name. If you want to delete a letter/position and thus move all the letters to the right of the cursor one step back, hold down **SHIFT** and press the **LEFT NAVIGATOR (DEL)** button. (This function is the same as using the Delete key on a computer keyboard.) If you want to move all letters to the right of the cursor one step forward and thus make room for more letters, hold down **SHIFT** and press the **RIGHT NAVIGATOR (INS)** button.

SOUND FUNCTIONS SECTION

ASSIGNABLE KNOBS AND BUTTONS WITH DISPLAYS

Module parameters in a Patch can be assigned freely to any of the **8 ASSIGNABLE KNOBS** or **BUTTONS** below the four **ASSIGNABLE DISPLAYS**. These knobs are designed to be the main controls to tweak the sound of a Patch. See also “Assignable Knobs/Buttons” on page 19 and “Accessing (Edit) any Parameter in a Patch” on page 37 .



PARAMETER PAGES BUTTONS

To the right are **8 PARAMETER PAGE** selection buttons. Select one of the 15 available **PARAMETER PAGES** by pressing a **ROW** and a **COLUMN** button. See “Parameter pages” on page 19. See also “Accessing (Edit) any Parameter in a Patch” on page 37 and “Global (Performance) Parameter Pages” on page 49 for info on how to use these pages.



VARIATION/MORPH BUTTONS

There are **8 VARIATION** buttons with which you can select up to eight different Patch Variations (complete parameter setups) within each Patch (see “Patch parameter Variations” on page 39).

In *Morph Mode*, these 8 buttons double as *Morph group selection buttons* to set *Morphing ranges* when you want to control several parameters in a Patch from a single controller source (see “Morph groups” on page 44).



PATCH SETTINGS/GLOBALPANEL

This button is used when you want to switch the four parameter displays between either showing the Patch parameters, which are printed above the **ASSIGNABLE DISPLAYS** (see “Editing Patch Settings” on page 34), or the **PARAMETER PAGES** (see “Accessing (Edit) any Parameter in a Patch” on page 37)

Pressing **SHIFT+PATCH SETTINGS** or ‘double click’ **PATCH SETTINGS** to enter the **GLOBAL PANEL** mode (see “Global (Performance) Parameter Pages” on page 49).

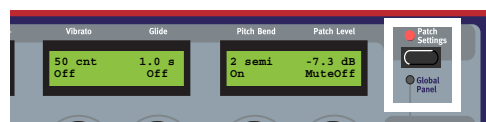

EDITING PATCH SETTINGS

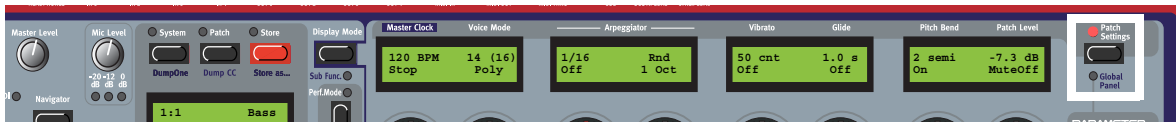

Press the **PATCH SETTINGS** button to the top right of the panel so the button LED lights up. This mode displays basic Patch settings for the Patch. The parameter names are printed on the panel above each **ASSIGNABLE DISPLAY** and you can edit them by turning the **ASSIGNABLE KNOBS** and/or the **ASSIGNABLE BUTTONS**.

You can revert back to Patch Edit mode by pressing the **PATCH** button again so the button LED dims.

MASTER CLOCK

Set the Master Clock Rate with the corresponding Knob. Run/Stop the Master Clock with the corresponding Button below the Knob.

The Master Clock can control several different functions:

4. It can be the MASTER MIDI CLOCK for your whole MIDI setup
5. It controls the Arpeggiator Speed
6. Several LFO modules can be controlled directly by the Master Clock
7. The Delay-time of some Echo Delay modules can be synced to the Master Clock
8. When several Slots are active they can all sync to and follow the current Master Clock rate, as the Master Clock is global to the whole **G2** system.
9. When the Master Clock is the MIDI MASTER CLOCK in your setup, the Run/Stop button will send out MIDI START and MIDI STOP commands over the MIDI OUT connector. Note that the **G2** system must be set in the System menu to send MIDI CLOCK commands over the MIDI OUT connector to use the **G2** system for the MIDI MASTER CLOCK in your setup.
Sending MIDI CC#80 on the Global MIDI channel will also start/stop the Master Clock. This feature is particularly useful when a **G2 ENGINE** model is controlled by an external MIDI controller device.
10. If the **G2** is set to receive MIDI CLOCK commands and a MIDI CLOCK signal is present on the MIDI IN connector, this external MIDI CLOCK will automatically take over and start to be the Master Clock. The Arpeggiator, the LFO's and the Delay modules set to Clk mode will now sync automatically to the external MIDI CLOCK. The average tempo of the external MIDI CLOCK will be displayed in the panel display and the endless knob that normally sets the tempo will become inactive.
Note that an EXTERNAL MIDI CLOCK signal must be stable and 'jitter free' for reliable control of the delay time on delay modules.

VOICE MODE

Set requested polyphony with the Knob (2-32 voices). The actual polyphony is displayed together with the requested polyphony within parenthesis. Actual polyphony depends on the complexity of the loaded Patches and how many Slots are loaded and active (Slot LEDs light up).

Select Voice Mode (Poly, Mono or Legato) with the Button below the Knob. In Legato mode, the Envelope modules do not retrigger when you play in a legato fashion, i.e. when you play a new key before releasing the previous key.

ARPEGGIATOR

Select Period (note length/sync division rate) for the Arpeggiator in relation to the Master Clock rate with the Knob. Run/Stop the Arpeggiator with the Button below the Knob. *Note that the Master Clock has to be active for the Arpeggiator to run.* Select Direction with the right Knob and Range with the Button below the Knob. If you want the Arpeggiator to continue when you release the keys, use the KB Hold function described on “[KB Hold/Panic](#)” on page 27.

The Arpeggiator uses MIDI SONG POSITION POINTER when synched to an external MIDI CLOCK, which means that if you record the chords that control an arpeggio in an external sequencer, it will always play back the pattern exactly the same way it played while recording the chord - even if you start the sequencer in the middle of the sequence.

VIBRATO

This is a separate vibrato which affects all Oscillator modules in the Patch set to Keyboard Tracking. Set the Vibrato amount, in cents of a semitone, with the Knob and select control source (Aftersustain, Modwheel or Off) with the Button below the Knob. Set the Vibrato rate in the System menu described on “[Vibrato Rate | Pa](#)” on page 32.

GLIDE

The *Glide* or *portamento* function is mainly intended for use in *mono or legato Voice Mode* (see above). The glide characteristics can be described as “constant rate”. “Constant rate” means that the greater the “distance” between two subsequent notes, the longer the glide time. Turn the Knob to adjust the glide rate and press the Button to select glide mode. ‘Normal’ means the glide is always active and ‘Auto’ that glide is active only when you play legato (you press a new key before you release the previous key). Range: 19 milliseconds per octave to 6.27 seconds per octave.

Note that if you use Glide in *polyphonic mode*, the glide will be *unpredictable* and perceived as more or less random. This is because the glide is between voices rather than between keys. The glide will therefore be from the available voices’ latest note values to the new notes rather than from the previously pressed keys.

BEND

Set the Pitch bend range, in semitones, with the Knob. The pitch bend will affect all Oscillator modules in the Patch set to Keyboard Tracking when you bend the **PITCH STICK**. Switch on/off the pitch bend function with the Button below the Knob.

PATCH LEVEL

Set the total output level of the Patch with the Knob. Mute the output from the Patch by pressing the Button below the Knob.

WORKING WITH PATCHES

LOAD A PATCH FROM MEMORY

Before loading a patch first check that the Performance LED is OFF.

Press a **SLOT** button to select the Slot in which to load the Patch. Load the Patch into the Slot by first selecting Bank (if necessary) with the **UP/DOWN NAVIGATOR** buttons and then turning the **ROTARY DIAL** to select the Patch. Load the selected Patch into the Slot by pressing the **PATCH LOAD** button. Note that every time you load a Patch into a Slot, there will be a brief moment of silence when the Sound engine recalculates the Patch data



SEARCH FOR AND LOAD A PATCH

By default, when you load a Patch into a Slot, by first selecting Bank with the **UP/DOWN NAVIGATOR** buttons and then turning the **ROTARY DIAL** and pressing **PATCH LOAD**, the Patches are displayed by *memory location number*.

Note that you can change the sort/search mode to either 'Alphanumerical' or by 'Category'.

SEARCH FOR A PATCH IN ALPHABETICAL ORDER

By pressing the **SHIFT + DOWN NAVIGATOR** buttons you will be able to load Patches in *alphabetical order* rather than by memory location number. Select letter by pressing the **UP/DOWN NAVIGATOR** buttons and select Patch with the **ROTARY DIAL**.



SEARCH FOR A PATCH IN A SPECIFIC SOUND CATEGORY

By holding down **SHIFT** and pressing the **DOWN NAVIGATOR** button twice you will be able to load Patches by *Category* rather than by memory location number. The Patches within a Category will now be displayed in alphabetical order. Select Category by pressing the **UP/DOWN NAVIGATOR** buttons and select Patch with the **ROTARY DIAL**.



CREATING A BLANK PATCH

This can *only* be done with the **G2 EDITOR SOFTWARE** and you will need a suitable Windows computer or Macintosh OSX computer. Please refer to [“Making your first patch” on page 63](#).

ACCESSING (EDIT) ANY PARAMETER IN A PATCH

Press the **PATCH** button above the **MAIN DISPLAY**. Hold down **SHIFT** and press the **DOWN NAVIGATOR** button to get to the first module in the Voice Area (VA) of the Patch. The module currently “in focus” in the Patch will appear in the **MAIN DISPLAY** with its name and visual position in the Editor within brackets [1:1] (first row, first column). These rows and columns refer to how a Patch would show up on the computer screen when the Editor program would be used.



The names of the modules should give you a clue on what they do in a sound. Sometimes the clue is pretty clear, like when a module is named FltNord or OscA. Other times the name might be obscure. If tweaking a knob in a module that you have no idea about what it is doing should give strange and unwanted behaviour you can simply restore all tweaks in the Variation you’re in by pressing Shift and the current Variation button. The first module’s (up to) eight parameters will appear in the **ASSIGNABLE DISPLAYS**. You can now change the values of the parameters by turning the **ASSIGNABLE KNOBS** or pressing the **ASSIGNABLE BUTTONS**. Navigate to the next module by pressing the **DOWN** or **RIGHT NAVIGATOR** button or turning the **ROTARY DIAL**. If a module should contain more than eight parameters, the remaining parameters can be found by pressing the **2** and **3 PARAMETER PAGES** buttons. Hold down the **SHIFT** button and press the **UP/DOWN NAVIGATOR** button to immediately change Patch Area focus between the Toolbar (Morph groups), Voice Area and the FX Area. Note that all changes you make to parameters are only made in the current Variation you’re in right now. The same parameter will not be affected in the other Variations.

Play on the synth while turning the **ASSIGNABLE KNOBS** to instantly hear what effects they have on the sound. If the **G2** system is connected to a computer running the Editor software, the Editor will echo any



adjustments that you make from the synth front panel on the computer screen and vice versa. When editing module parameters it can be useful to switch Display Mode (see “[Display Mode](#)” on page 28) to constantly view the actual values of each parameter in the **ASSIGNABLE DISPLAYS**. Some modules, like Mixers with Mute buttons, have a combination of button+knob parameters assigned to each individual control. By default, the **ASSIGNABLE DISPLAY** shows the knob parameter name. To view the button parameter name instead, hold **SHIFT** and press the **DISPLAY MODE** button.

Note that while in Patch mode you have access to literally any knob/parameter in a Patch. In the factory patches all sensible parameters are already assigned to **ASSIGNABLE KNOBS**, so it hardly pays to use Patch mode. But for the Patches that you made yourself, and probably know very well, Patch mode gives you total control on literally everything that can be tweaked in your Patch.

ASSIGN PARAMETERS TO PANEL CONTROLS

It’s possible to assign nearly every module parameter in a Patch to a separate **ASSIGNABLE KNOB** or **ASSIGNABLE BUTTON** on the synth front panel. Do like this:

1. Press the **PATCH** button above the **MAIN DISPLAY** to enter Patch Edit Mode (button LED lights up). Hold down **SHIFT** and press the **DOWN NAVIGATOR** button to get to the first module in the Voice Area of the Patch.
2. Use the **NAVIGATE** buttons to ‘scroll’ to the module which contains the parameter you want to assign. The module’s name and first parameters are shown in the **ASSIGNABLE DISPLAYS**. (If a module contains more than 8 parameters, you can access the remaining parameters by pressing the **2** and **3** **PARAMETER PAGES** buttons.)



3. When you have found the module and parameter you want to assign to an **ASSIGNABLE KNOB** or **ASSIGNABLE BUTTON**, hold down the **FOCUS/ASSIGN** button and turn the parameter **KNOB** (or push the parameter **BUTTON** if the module parameter is a button). In this example we choose the FltMulti1 Freq parameter.

Note that some modules, like Mixers with On/Off buttons, have a *combination of button+knob parameters assigned to each individual control*. If you want to assign these types of “combination parameters” to an Assignable Knob and Button, you have to *copy* the knob parameter and *paste* it by *turning the Assignable Knob* for the parameter combination to be assigned properly.



4. Press the **PATCH** button or a **PARAMETER PAGE** button to exit Patch Edit Mode (**PATCH** button LED dims) and revert to normal “play mode”.
5. Press the desired **PARAMETER PAGES** buttons to get to the desired destination. You can choose freely where to assign a parameter but it could be convenient to use the **PARAMETER PAGES** group names printed in blue on the front panel. Here, we choose **PARAMETER PAGE D1** (Filter).

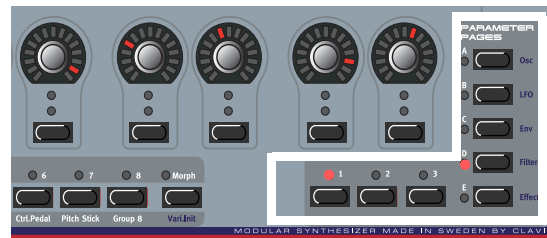

6. Hold down the **SHIFT** and **FOCUS/COPY** buttons (Paste) and turn the **ASSIGNABLE KNOB** (or push the **ASSIGNABLE BUTTON**) you want to assign the module parameter to. We choose to assign the parameter to the first **ASSIGNABLE KNOB**. The **LED GRAPH** around the **ASSIGNABLE KNOB** (or the **ASSIGNABLE BUTTON LED**) will light up with the pasted module parameter’s current value and the parameter name will be shown in the corresponding **ASSIGNABLE DISPLAY**.



- If you want to assign more module parameters, press the **PATCH** button and repeat the procedure from step 3 above. If you have assigned several parameters from the same module to adjacent **ASSIGNABLE KNOBS/BUTTONS** in a **PARAMETER PAGE**, the module name will only be shown for the first parameter. There will be dashes in the **ASSIGNABLE DISPLAYS** to indicate that the following parameters are from the same module.

PATCH PARAMETER VARIATIONS

WHAT IS A VARIATION?

A **VARIATION** is basically a *memory of all current knob settings in a patch* both for the module knobs and the global patch parameter settings. See “Variations” on page 17.

CHANGE A VARIATION

- Load a Patch in a Slot. The **VARIATION 1** LED lights up.
- Select another Variation by pressing the **VARIATION 2** button. The **VARIATION 2** LED lights up to indicate it’s now the focused Variation.
- Change the settings on a couple of parameters in the Patch either by using the **PARAMETER PAGES** buttons and turning the **ASSIGNABLE KNOBS** or by entering Patch Edit mode by pressing the **PATCH** button and navigating to the parameters.
- Now, press the **VARIATION 1** button again to put Variation 1 in focus. The parameters you changed now revert to their original settings belonging to Variation 1.



If you want to change more Variations in your Patch, simply press another **VARIATION** button and change parameter settings. When you store your Patch, all changed Variations will automatically be saved within the Patch.

SAVE A VARIATION

All current Variations are automatically saved when you store the Patch (see “Store a Patch” on page 40).

COPY A VARIATION

To copy the parameter settings of an existing Variation to another Variation in the Patch, *hold down* the **FOCUS/COPY** button *while pressing* the **VARIATION** button that you want to copy parameters from. Then *hold down* **SHIFT+FOCUS/COPY** (Paste) *while pressing* the destination **VARIATION** button to paste all parameter values.

VARIATION INIT

The **VAR INIT** is a “default” parameter setup for your Patch. This Init parameter setup can be recalled in any Variation by pressing the **VAR INIT** button (**SHIFT+MORPH**) to the right of the Variation buttons. When you do this, the **VAR INIT** parameter



settings will be copied to the currently focused Variation. The **VAR INIT** itself can be seen as a ‘hidden’ ninth Variation, as it can not be used as a regular Variation.

SAVE A VARIATION INIT

This has to be done in the Editor. Refer to “Variation Init” on page 89.

CLEAR A VARIATION

You clear a Variation and reset all module parameters in the Patch to their default settings by pressing **SHIFT** and desired **VARIATION** button. The default settings are the settings when the Patch was loaded from Patch memory.

STORE A PATCH

Storing a Patch will permanently overwrite an existing Patch. Be careful so that you don’t accidentally erase Patches you want to keep! **Note! When the Nord Modular G2 is shipped from factory, Memory Protect is set to ‘On’. To be able to store Patches, first disable the Memory Protect function. See “Memory Prot |Sy” on page 32.**

Storing a Patch on the Nord Modular **G2** can be done in two ways:

STORING WITHOUT CHANGING THE PATCH NAME

1. First, press the **STORE** button once. The **LED** above the **STORE** button will start flashing.
2. Now you must select a *location* in the *current memory bank* to save the patch to. Turn the **ROTARY DIAL** to an empty location or a location that can be overwritten. Optionally you can switch between memory banks by pressing the **UP/DOWN NAVIGATOR** buttons. As you scroll through the memory bank locations, you can see the Patch names in the **DISPLAY**. This prevents you from overwriting a Patch that you want to keep.



3. Press **STORE** *again* to actually store your Patch in the selected location in the selected memory bank. (To cancel the operation, press **ANY OTHER** button.)

STORING WITH NEW CATEGORY AND/OR NEW PATCH NAME

To make it easier to find different types of sounds in the **G2** system memory banks, it is possible to define a category for each Patch. When you’re looking for a specific type of sound you can then search by Category, instead of Alphabetically or Numerically. There are 13+2 different categories to choose between:

CATEGORY	DESCRIPTION
Acoustic	Patches with an acoustic character like flutes, violins, guitars, ethnic sounds, bells, mallets etc. Doesn’t necessarily have to be emulations of existing instruments
Sequencer	Sounds which use sequencer modules to produce melodic and/or rhythmic lines.
Bass	All sorts of bass sounds

CATEGORY	DESCRIPTION
Classic	Traditional “clean” analog types of polyphonic synth sounds based on the classic waveforms
Drum	Drum and percussion sounds
Fantasy	Melodic effects sounds and textures, often with rhythmic modulations
FX	Atonal effects sounds like water, laser guns, explosions etc. Sometimes with heavy modulations.
Lead	Sounds meant for lead lines. Usually monophonic sounds.
Organ	Different types of organ sounds
Pad	Melodic polyphonic “chord” sounds with fairly slow attacks like strings, choirs, etc.
Piano	Different types of electric and acoustic piano emulations
Synth	All sorts of melodic polyphonic synth sounds
AUDIO IN	All sorts of Patches that make use of the Audio Ins of the synth.
User1	Reserved for your own Sound Category
User2	Reserved for your own Sound Category

To store a Patch in a specific Category and change the Patch name, do like this:

1. Hold down **SHIFT** and press **STORE** (Store as...). The **STORE LED** starts flashing and the **DISPLAY** shows the current Category or, if no Category was selected, 'No Cat'.
2. Select Category with the **ROTARY DIAL**. Let's say we select 'Acoustic' in this example. Note that you can't revert to 'No Cat' after you have selected another Category for your Patch.



3. Press the **DOWN NAVIGATOR** button once and select letters for the Patch name by turning the **ROTARY DIAL**. Change the cursor position with the **LEFT** (and **RIGHT**) **NAVIGATOR** buttons.

Alternatively, press and hold the **DOWN NAVIGATOR** button and select letters with the **ROTARY**



DIAL. Each time you release the **DOWN NAVIGATOR** button the cursor in the **DISPLAY** advances one step.

Repeat the procedure for the entire Patch name. If you want to delete a letter/position and thus move all the letters to the right of the cursor one step back, hold down **SHIFT** and press the **LEFT NAVIGATOR (DEL)** button. (This function is the same as using the Delete key on a computer keyboard.) If you want to move all letters to the right of the cursor one step forward and thus make room for more letters, hold down **SHIFT** and press the **RIGHT NAVIGATOR (INS)** button. (Press a **SLOT** button to cancel the Storing operation).



4. Press **STORE** again. The **STORE LED** continues to flash. Select memory location by turning the **ROTARY DIAL**. Switch between Banks pressing the **UP/DOWN NAVIGATOR** buttons. As you scroll through the memory locations, you can see the Patch names in the **DISPLAY**. This prevents you from overwriting a Patch that you want to keep.
5. Press **STORE** again to store your Patch. (To cancel the operation, press **ANY OTHER** button.)

Note! If you started to save a Patch by only pressing the Store button and then change your mind and want to change Category and/or name, you can press Shift+Store right after you pressed Store the first time. This way you don't have to abort the initial storing procedure but can continue right away.

COPYING PATCHES

FROM ONE MEMORY LOCATION TO ANOTHER

Copying a Patch from one memory location to another is just a variation of storing. You just change the memory location after you pressed **STORE** the first time as described in [“Store a Patch” on page 40](#).

Of course you could also copy a Patch to a new memory location and change the Patch name and/or Category. Just follow the instructions in the paragraph [“Storing with new Category and/or new Patch name” on page 40](#).

FROM ONE SLOT TO ANOTHER

You can also copy a Patch from one Slot and paste it into another Slot. Do like this:

Press and hold the **FOCUS/COPY** button and while holding it, press the **SLOT** button containing the Patch you want to copy. Release all buttons. Press and hold **SHIFT+FOCUS/COPY** (Paste) and while holding them press the destination **SLOT** button.

Note: The copied Patch is not stored in any memory location after this operation. It is only copied to the new Slot's edit buffer.



RENAME A PATCH

Renaming a Patch is the same as saving the Patch with a new name to the same memory location. Just follow the instructions in the paragraph [“Storing with new Category and/or new Patch name” on page 40](#) and select the same memory location.

DELETE A PATCH

Deleting Patches from the internal memory of the synth can only be done from the Editor. Please refer to [“Delete a Patch” on page 88](#).

WORKING WITH SLOTS

ACTIVATE SEVERAL SLOTS

Due to the Sound engine architecture of the Nord Modular **G2**, which always tries to optimize the Patch Load and voice allocation resources, there are some things to bear in mind:

In live and sequencing situations you may want to quickly (without any silence) switch between Patches by simply accessing another **SLOT**. In order for the Sound engine to “prepare” for this, it has to recalculate the entire Slot configuration in advance. Therefore, you need to activate all the Slots you plan to use, with their Patches loaded, in advance.

Activate the Slots you want to use by holding down the **SHIFT** button and pressing the **SLOT** button(s) you plan to use. The **ACTIVESLOTS/FOCUS LEDS** for each active Slot will light up, indicating they’re used in the total Sound engine calculation. The **LED** for the currently focused Slot will flash to indicate it’s selected for editing. Now, when you press another **SLOT** button to play another active Patch, there will be no silence since the Sound engine has already recalculated the entire Slot configuration. If you switch between Slots which haven’t been previously enabled with the ActiveSlots/Focus function, the Sound engine has to recalculate every time you change Slot and thus cause a brief moment of silence.



LAYERING PATCHES

First of all you have to activate the Slots you plan to use as described above. Then, simultaneously press the **SLOT** buttons containing the Patches you want to layer. Alternatively, double-click the **SLOT** buttons, one by one, to add them to the layer. The **KEYBOARD ASSIGN LED** for each selected Slot in the layer will light up. The **ACTIVE/FOCUSED SLOTS LED** for the currently focused Slot will flash to indicate it’s selected for editing. The Patches in the active Slots will now sound when you play the keyboard or send MIDI Note data on the **MIDI IN** on the Global MIDI Channel (see [“MIDI Glob Ch | Sy” on page 31](#)). Change focused Slot by pressing another active **SLOT** button. Deselect a Slot from the layer by double-clicking the **SLOT** button you want to exclude from the layer. (See more about layering Patches in [“Performances” on](#)



page 47). Note that every time you load a Patch into any Slot, there will be a brief moment of silence when the Sound engine recalculates and optimizes the Patch data.

CHANGING EDIT FOCUS BUT NOT KEYBOARD FOCUS

By default, changing keyboard focus by pressing a Slot button in a layer automatically also changes the edit focus. By ‘edit focus’ we mean the Slot which holds the Patch currently enabled for editing from the front panel (and from the Editor). In some situations you may want to have the edit focus on a Patch in a Slot which is different from the Patch you’re playing from the keyboard. Then, Hold down the **FOCUS/COPY** button and press the desired **SLOT** button. This will change the edit focus but not the keyboard focus. In the picture to the right, Slot A has edit focus and Slot C has keyboard focus.



MORPH GROUPS

The **MORPH** function lets you continuously control defined ranges of several Parameters in a Patch, using only a single control source. This lets you produce radical changes in a sound in a very fast and easy way through a single physical controller like the Modwheel, a Footpedal or an Assignable Knob. See “Morphs” on page 20. The Nord Modular **G2** features eight separate **MORPH GROUPS** per Patch. You may assign 25 Parameters in total in each Patch to the 8 **MORPH GROUPS**. A Parameter can also be assigned so several **MORPH GROUPS** (all 8 if you like), and thus be controlled differently from several sources. Also, if you use several Variations in a Patch, the **MORPH GROUPS** assignments can be different for each Variation. The control sources are Keyboard Velocity, Keyboard Range, Keyboard Aftertouch, Global Modwheel 2, Modwheel, Control Pedal, Pitch/Control Stick and Global Modwheel 1, on the front panel. Note that the Global Modwheels are only presents on the Nord Modular **G2X** model. On the other **G2** models you can assign these **MORPH GROUPS** to e.g. Assignable Knobs. Additionally the **MORPH GROUPS** can be decoupled from their default physical controller and assigned to an **ASSIGNABLE KNOB** instead.

ASSIGN PARAMETERS TO A MORPH GROUP

In the example below we will assign the A, D, S and R parameters of an ADSR Envelope module to the **MODWHEEL**. However, the procedure is exactly the same for the other parameters and Morph groups as well. First we press the **PATCH** button and navigate down to the EnvADSR1 module. This figure shows the current parameter settings:



1. Press the **MORPH** button to the right of the **VARIATIONS** buttons. The LED above the **MORPH** button lights up to indicate the **G2** is in **MORPH ASSIGN** mode.

- When in **MORPH ASSIGN** mode, press the **WHEEL MORPH** button and *keep it pressed down*. All circular **LED GRAPHS** on the front panel will go blank. Alternatively you can quickly press the Wheel Morph button two times (like a double click on a mouse button on a computer) and the Wheel Morph LED will flash.

- While keeping the Wheel Morph button pressed down, turn the parameter **KNOBS** you want to assign to the Wheel Morph group. The first and last LED of the Morph range will light up. A Morph range can be either negative or positive according to your choice. The “zero” Morph value is the parameter’s initial setting. In this example we assign the A, D, S, and R parameters of the EnvADSR1 module.



- Note that while the Wheel Morph LED *lights up steadily* and *without* keeping the Wheel Morph button pressed, you can set the *lower limit* of the Morph range. And while the Wheel Morph LED *flashes* after the double press you can set the *upper limit* of the Morph range. When the Wheel Morph LED flashes press the Wheel Morph button once more to make it light up steady again.

When you are ready with the assignments, release the **WHEEL MORPH** button and the LED graphs will light up again to show the regular settings. Now, the Wheel Morph LED will light steadily to indicate that there are parameters assigned to this Morph group.

Note that you can also assign parameters directly from the Parameter Pages to Morph groups. In other words, you don’t have to enter Patch Edit mode if the parameters you want to morph are already assigned to a Parameter Page.

To change the initial parameter value(s) and thus move the entire Morph range (sector), just change the parameter value without pressing any **MORPH GROUP** button (just as you would change an unassigned parameter).

The Wheel, Aftertouch, Control Pedal, Sustain Pedal and Pitch Stick Morphs will show the actual parameter values when you change the source value is the morphed parameters are currently displayed in the **ASSIGNABLE DISPLAYS**. The Velocity and Keyboard Morphs don’t show the actual parameter values as you play on the keyboard. It’s made this way because it gets irritating after a while to watch all flickering LEDs as you play.

Note: If you have assigned the same parameter to several Morph groups and control the parameter simultaneously from the different Morph group control sources, the parameter values will be added together. This means that the parameter value can go beyond the ranges set for each individual Morph group.

Tip! If you want to enter “Morph Assign” mode without needing to hold the **MORPH GROUP** button you can double-click the **MORPH GROUP** button. Click again to exit Morph Assign mode.

DEASSIGN PARAMETERS FROM A MORPH GROUP

1. Navigate to the morphed parameter you wish to deassign.
2. Press the **MORPH** button. Then, hold the **MORPH GROUP** button. The parameters assigned to that Morph group will indicate their morph ranges.
3. Turn the parameter **KNOB** you wish to deassign until it meets the initial (start) value. The LED graph will go blank to indicate that the parameter has been deassigned from the Morph group.

To deassign all assigned parameters from a Morph group, hold down **SHIFT** and press the corresponding **MORPH GROUP** button (Morph Clear).

EDIT PARAMETERS IN A MORPH GROUP

The Morph range will always start at the current position of the parameter. The relationship between the setting of the parameter and the Morph range will be fixed, even if you move the setting of the parameter after a Morph range has been set.

EDIT A MORPHED PARAMETER WHICH IS ASSIGNED TO A PARAMETER PAGE

Press the corresponding **PARAMETER PAGE** button to display the desired morphed parameter. You can edit the morph range (the size of the sector) by first pressing the **MORPH** button and then holding down the **MORPH GROUP** button and turning the morphed **KNOB**.

EDIT A MORPHED PARAMETER WHICH IS NOT ASSIGNED TO A PANEL KNOB

Press the **PATCH** button to enter Patch Edit Mode. Navigate to the parameter you wish to edit. You can edit the morph range (the size of the sector) by first pressing the **MORPH** button and then holding down the **MORPH GROUP** button and turning the morphed **KNOB**.

COPY A MORPH GROUP FROM ONE SOURCE TO ANOTHER

The special Copy/Paste function can be used to copy an entire Morph Group with all its assigned parameters from one Morph source to another. To copy and paste a Morph Group, do like this: First, press the **MORPH** button. Then, press and hold the **FOCUS/COPY** button and while holding it, press a **MORPH GROUP** button. Release all buttons. Press and hold **SHIFT+FOCUS/COPY** (Paste) and while holding them, press the new destination **MORPH GROUP** button. You can copy **MORPHS** to another **VARIATION** by first selecting that **VARIATION** before pasting.

MORPH GROUPS IN SEPARATE VARIATIONS

Each Variation in a Patch can have its own unique Morph group assignments.

COPY MORPH GROUPS BETWEEN VARIATIONS

All Morph groups in a Variation are automatically copied together with the rest of the parameter values when you copy a Variation to another Variation as described on [“Copy a Variation” on page 39](#).

A WORD ABOUT THE KEYBOARD MORPH

Keyboard Morph lets you control the Morphed parameters differently depending on where on the keyboard you play. The minimum source value is the lowest key of the five octave Nord Modular **G2X** keyboard when no Octave Shift is used, i.e. note C1, and maximum is the highest key, i.e C6. When you

transpose the keyboard up or down, the Keyboard Morph range will extend beyond the set Morph limits, in other words the Morph will still have effect outside the C1 to C6 range by using ‘extrapolation’.

ADVANCED EXAMPLE: When a Constant module is connected to the direct Pitch input on an Oscillator and the Constant module is assigned to the Keyboard Morph set to a range between -28 to +32 units (knob positions 36 to 96), and the Keyboard Tracking on the Oscillator is set Off, the Oscillator will track the keyboard accurately through the Morph on the Constant module. Now note that when you play outside the C1-C6 range the Oscillator still keeps on tracking the keyboard.

A WORD ABOUT THE PITCH STICK MORPH

The lower (or start) limit of the Pitch Stick Morph range is the Pitch Stick neutral position, so the centre position it is in when you don’t touch it. When moving the Pitch Stick to the right the Morph travels to the upper or end limit of the Morph range. If you move the Pitch Stick to the left the Morph range will be mirrored, so from the start limit to the mirrored value of the end limit. Imagine that the Pitch Stick Morph is assigned to a Constant module with a range from +20 to +32 units. Moving the Pitch Stick to the right will Morph from +20 to +32, but moving the Pitch Stick to the left will morph from +20 to +8, as +8 is the mirror value of +32 when mirrored at +20.

PERFORMANCES

See also “Performances” on page 18.

Note that the edits and settings you make for each individual Patch in a Performance do not affect the original Patch in any way. The Performance memory is completely separate from the Patch memory. The Patches saved in a Performance are only copies of the Patches from the Patch memory.

ENTERING PERFORMANCE MODE

Enter Performance mode by pressing the **PERFORMANCE MODE** button. The Performance button LED will light up to indicate the synth is in Performance mode.

EXITING PERFORMANCE MODE

To exit Performance mode, press the **PERF MODE** button again. Now you return to the regular Patch mode. You will note that the Patches that were loaded before entering Performance will reload to the Slots.



See also “Switching between Patch and Performance modes” on page 28.

LOAD A NEW PERFORMANCE FROM THE INTERNAL MEMORY

First, be sure you're in Performance Mode. Then, load a new Performance into the Slots by first turning the **ROTARY DIAL** to select the Performance. If you like you can also switch between Banks by pressing the **UP/DOWN NAVIGATOR** button. Then load the selected Performance into the Slots by pressing the **PATCH LOAD** button. Now, you can try out other Performances of the internal memory and edit parameters as described above. To revert to "Patch mode", press the **PERFORMANCE** button.



Note that selecting a new Performance changes a lot of parameters. This might possibly lead to unexpected behavior, e.g. if a Performance contains self-running sequencer modules you might hear a complete song starting to play.

CREATING A PERFORMANCE

First of all you need to activate the Slots you plan to use for your Performance. Do this by holding **SHIFT** and pressing the **SLOT** buttons you want to include as described in "Layering Patches" on page 43.

SELECTING PATCHES FOR THE SLOTS

To select Patches as base in a Performance, do like this:

1. In Performance Mode, hold down the desired **SLOT** button (A in this example). The **SLOT LED** flashes to indicate that it's the active Slot. The **DISPLAY** shows the name of the Patch in Slot A (if any).



2. Select a new Patch for the Slot by holding down the **SLOT A** button and scrolling with the **ROTARY DIAL**. To switch between Patch Banks, hold down the **SLOT A** button and use the **UP/DOWN NAVIGATOR** buttons. Repeat the procedure for the other Slots.

Note! Do not press the Patch Load button during this operation. The Patch is automatically loaded to the Slot as soon as you release the Slot button.

If you want to assign or deassign a Patch in an active Slot to be controlled by the keyboard (Keyboard Assign), double-click the **SLOT** button you want to include/exclude. If you want to include an unused Slot or deactivate an active Slot, Press **SHIFT+SLOT** button.

EDITING A PERFORMANCE

This is done just as in Patch (non-Performance) mode as described in "Editing Patch Settings" on page 34. To activate a Slot for editing, simply press the desired **SLOT** button. The **LED** below it flashes to indicate it's the currently active Slot.

Note that when you save the Performance you save edited copies of Patches within the Performance. The original Patches (from the Patch memory) that you may have used as base for

the Performance are *not* affected in any way. And if you later make changes to the original Patches this will *not* affect the Patch copies saved in the Performance.

So, when a performance is saved, any links to the original Patches will be broken. When you think about this deeply, you will realize that this is exactly what one would want.

GLOBAL (PERFORMANCE) PARAMETER PAGES

A Performance can have a separate set of programmable **GLOBAL PARAMETER PAGES**, *in addition* to the **PATCH PARAMETER PAGES** of each Patch in the Performance. Hold down **SHIFT** and press the **PATCH SETTINGS** button or ‘double click’ the **PATCH SETTINGS** button to access **GLOBAL PARAMETER PAGE A1**. Now, 8 new Performance parameters can be assigned to the **ASSIGNABLE KNOBS** and/or **ASSIGNABLE BUTTONS**. If you want to access the Parameter Pages of each individual Patch, hold down **SHIFT** and press the **PATCH SETTINGS** button again or ‘double click’ the **PATCH SETTINGS** button. Now, the first Parameter Page of the Patch in the focused Slot is shown in the **ASSIGNABLE DISPLAYS**. You can freely assign module parameters from any of the Slots to the Global Parameter Pages. See “Accessing (Edit) any Parameter in a Patch” on page 37 for info on how to assign parameters to the Parameter Pages.



KEYBOARD SPLIT

The Keyboard Split function allows you to *split the keyboard in two sections*, each playing separate Patches. When Keyboard Split is activated, Slots A and B will be played from the lower (left) part of the keyboard, while Slots C and D will be played from the upper (right) part. The Keyboard Split function is a pure synth *performance feature* and doesn’t exist in this way in the Editor. Activate Keyboard Split function by pressing the **KB SPLIT** button.



SETTING THE SPLIT POINT

You set the Split Point (the key where the keyboard should be split) by holding down **SHIFT** and pressing the **KB SPLIT** button. The lowest **KEYBOARD SPLIT LED** above the keyboard will light up to indicate the split position. Hold down **SHIFT** and press the **KB SPLIT** button again to move the split point to the next position. The next Keyboard Split LED will light up instead above the keyboard.

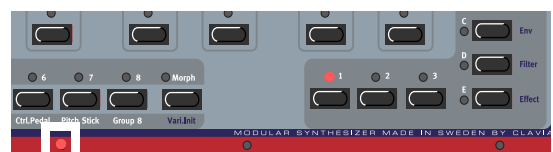

COMBINING SPLIT AND LAYER

Since Slots A and B will be played from the lower part of the split point and Slots C and D from the upper part, you can split the keyboard and play layers of two Patches on each “keyboard half”. Just select Patches for all Slots, and activate Keyboard Split.

See also “Keyboard Zone |Pe” on page 32, “Keyboard Zone |Pe” on page 32 and “Performance Settings {Ctrl-R}” on page 119 to read more about more advanced Keyboard Split and Layering settings.

KEYBOARD ZONE

It's also possible to set separate note ranges for each of the Slots in a Performance. Separate note ranges overrides the Keyboard Split, as it is basically a more advanced setting of Keyboard Split. Making the settings is done in the System menu.

Please refer to “Keyboard Zone | Pe” on page 32, “Keyboard Zone | Pe” on page 32 and “Performance Settings {Ctrl-R}” on page 119 for how to make more advanced Keyboard Split and Layering settings.

STORING A PERFORMANCE

Note! When the Nord Modular G2 is shipped from factory, Memory Protect is set to ‘On’. To be able to store Performances, first disable the Memory Protect function. See “Memory Prot | Sy” on page 32.

STORING WITHOUT CHANGING THE NAME

1. Press the **STORE** button once. The **LED** above it starts flashing.
2. Select memory location by turning the **ROTARY DIAL**. Switch between Banks 1-8 by pressing the **UP/DOWN NAVIGATOR** buttons. As you scroll through the memory locations, you can see the Performance names in the **DISPLAY**. This prevents you from overwriting a Performance that you want to keep.



3. Press **STORE** again to store your Performance. (To cancel the operation, press **ANY OTHER** button.)

STORING WITH THE POSSIBILITY TO CHANGE THE NAME

1. Hold down **SHIFT** and press **STORE** (Store as...). The **LED** starts flashing and the **DISPLAY** shows the name of the current Performance. Select letters with the **ROTARY DIAL** and change the cursor position with the **LEFT** and **RIGHT NAVIGATOR** buttons.

Alternatively, press and hold the **DOWN NAVIGATOR** button and select letters with the **ROTARY DIAL**. Each time you release the **DOWN NAVIGATOR** button the cursor in the **DISPLAY** advances one step. Repeat the procedure for the entire Performance name. If you want to delete a letter/position and thus move all the letters to the right of the cursor one step back, hold down **SHIFT** and press the **LEFT NAVIGATOR (DEL)** button. (This function is the same as using the Delete key on a computer keyboard.) If you want to move all letters to the right of the cursor one step forward and thus make room for more letters, hold down **SHIFT** and press the **RIGHT NAVIGATOR (INS)** button. (Press **ANY OTHER** button to cancel the Storing operation).



2. Press **STORE** again. The **LED** continues flashing. Select memory location by turning the **ROTARY DIAL**. Switch between Banks 1-8 by pressing the **UP/DOWN NAVIGATOR** buttons. As you scroll through the memory locations, you can see the Performance names in the **DISPLAY**. This prevents you from overwriting a Performance that you want to keep.
3. Press **STORE** again to store your Performance. (To cancel the operation, press **ANY OTHER** button.)

The Patches you use in the Performance Slots are saved complete with all parameter settings, Keyboard Split info and Parameter Pages (also Global) configurations within the Performance itself, when the Performance is saved. The above point means that there is no need to store the Patches separately. As soon as you save the Performance, all Patches that are used in the Performance are also saved within the Performance itself. This also means that if you later change any of the original Patches while in Patch mode, the Patches stored in the Performances are *not* affected in any way. And if you later make changes to the Patches in the Performance, this will *not* affect the original Patches saved in the Patch memory banks.

So, when a performance is saved, any links to the original Patches will be broken. When you think about this deeply, you will realize that this is exactly what one would want.

EXTRACTING PATCHES FROM A PERFORMANCE

As stated earlier, the Patches used in the Slots of a Performance are *not* references to Patches stored in the Patch memory banks, but separate Patches that only exist within the Performance itself. You will find several unique sounds in the factory Performances; sounds that you will not find in any of the internal Patch memory banks. You may want to extract such a Patch from a Performance to play it on its own, and/or to save it as a single Patch in the Patch memory. See also “[Performance Mode](#)” on page 28.

EXTRACT A PATCH AND SAVE IT

1. Select the Performance containing the sound you want to extract.
2. Press **SHIFT** together with the **PERF MODE** button to exit Performance mode (Performance button LED dims). See also “[Copying Patches between Patch and Performance modes](#)” on page 28.
3. Press the **SLOT** button to activate the Slot (**ACTIVE SLOTS/FOCUS LED** is flashing) containing the desired Patch.
4. Press **STORE**. The **LED** above the **STORE** button starts flashing
5. Select Patch memory location by turning the **ROTARY DIAL**. Switch between Banks by pressing the **UP/DOWN NAVIGATOR** buttons. As you scroll through the memory locations, you can see the Patches in the **DISPLAY**. This prevents you from overwriting a sound that you want to keep.
6. Press **STORE** again to store your Patch. (To cancel the operation, press a **SLOT** button.) The Patch is now stored as a single Patch.

EXTRACT A PATCH, RENAME IT AND SAVE IT

1. Select the Performance containing the sound you want to extract.

2. Press **SHIFT** together with the **PERF MODE** button to exit Performance mode. See also “[Copying Patches between Patch and Performance modes](#)” on page 28.
3. Press the **SLOT** button to activate the Slot (**ACTIVE SLOTS/FOCUS LED** is flashing) containing the desired Patch.
4. Hold down **SHIFT** and press **STORE** (Store as...). The **LED** above the Store button starts flashing.
5. Select Category with the **ROTARY DIAL**.
6. Press the **DOWN NAVIGATOR** button once and select letters for the Patch name by turning the **ROTARY DIAL**. Change the cursor position with the **LEFT** (and **RIGHT**) **NAVIGATOR** buttons.

Alternatively, press and hold the **DOWN NAVIGATOR** button and select letters with the **ROTARY DIAL**. Each time you release the **DOWN NAVIGATOR** button the cursor in the **DISPLAY** advances one step.

Repeat the procedure for the entire Patch name. If you want to delete a letter/position and thus move all the letters to the right of the cursor one step back, hold down **SHIFT** and press the **LEFT NAVIGATOR (DEL)** button. (This function is the same as using the Delete key on a computer keyboard.) If you want to move all letters to the right of the cursor one step forward and thus make room for more letters, hold down **SHIFT** and press the **RIGHT NAVIGATOR (INS)** button. (Press a **SLOT** button to cancel the Storing operation).

7. Press **STORE** again. The **STORE LED** continues to flash. Select memory location by turning the **ROTARY DIAL**. Switch between Banks pressing the **UP/DOWN NAVIGATOR** buttons. As you scroll through the memory locations, you can see the Patch names in the **DISPLAY**. This prevents you from overwriting a Patch that you want to keep.
8. Press **STORE** again to store your Patch. (To cancel the operation, press a **SLOT** button.) The Patch is now stored as a single Patch.

DELETING PERFORMANCES

Deleting Performances from the internal memory of the synth can only be done from the Editor. Please refer to “[Deleting Performances in the synth](#)” on page 98.

NORD MODULAR G2 ENGINE FRONT PANEL



UPDATE MODE BUTTON

This button is used in the factory to manually set the **G2** Engine in Update Mode. For information on how to update the system software see [“Updating the Synth OS” on page 140](#).

MIDI LED

Indicates incoming MIDI messages received on the **MIDI IN** jack.

USB LED

Lights steadily when the **G2** Engine’s **USB** port is connected to the computer’s **USB** port and the Editor has established contact.

POWER ON LED

Lights steadily when the **G2** Engine is powered on.

ON/OFF BUTTON

Switch on and off the **G2** Engine with the **ON/OFF** button.

NORD MODULAR G2 REAR PANEL

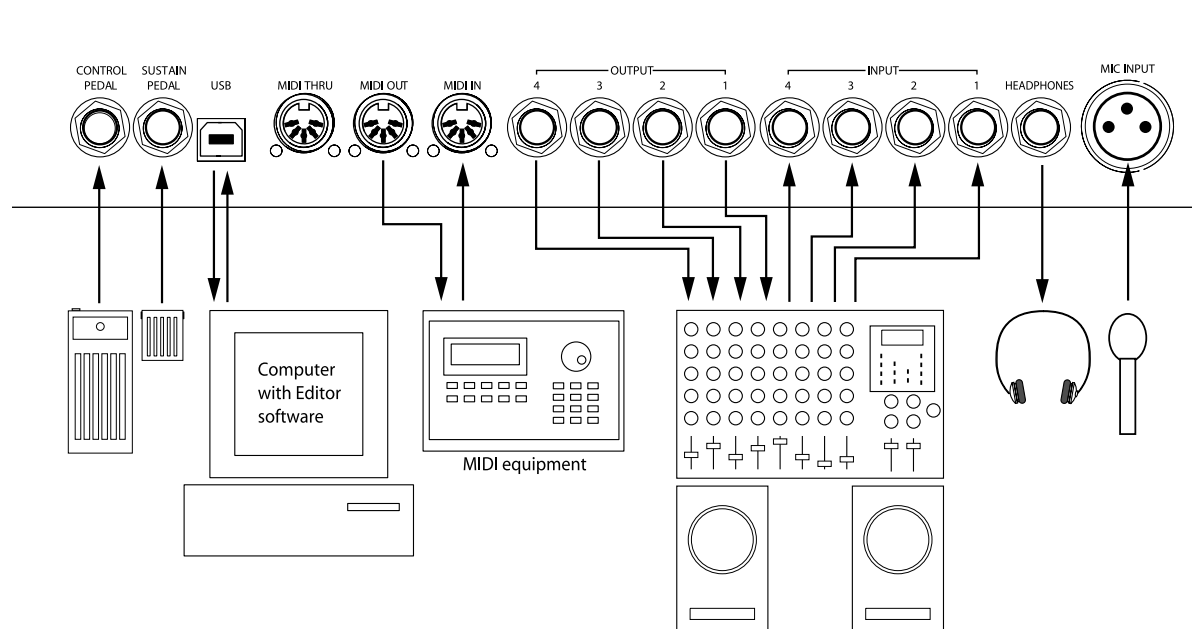

CONTROL PEDAL (G2, G2X)

Connect a control/expression pedal to the **CONTROL PEDAL** input. The sensitivity of the Pedal input can be adjusted in the System menu for different brands of pedals. See [“Ctrl Ped Gain | Sy” on page 32](#).

SUSTAIN PEDAL (G2, G2X)

Connect a sustain pedal to the **SUSTAIN PEDAL** input. The polarity of the input can be adjusted to suit different types of Sustain Pedals.

USB CONNECTOR

The **USB** (1.1) connector is used to connect the **G2** to a computer. Connect a free **USB** port of the computer that runs the Editor software to the **USB** Port. The **USB** connection is hot-pluggable.

MIDI IN, MIDI OUT AND MIDI THRU CONNECTOR

Connect any external MIDI equipment to the **MIDI IN**, **MIDI OUT** and **MIDI THRU** ports. This could be a sequencer, a master keyboard or another MIDI device.

AUDIO OUTPUTS

The unbalanced, line level (-10 dBV) audio outputs **OUTPUT 1-4** route the audio signals from the four virtual mix buses in Nord Modular **G2**. Use **OUTPUT 1** if you are going to use Nord Modular **G2** with a mono sound system. If only **OUTPUT 1** is connected, the audio from **OUTPUT 2** is mixed to **OUTPUT 1**.

AUDIO INPUTS

By connecting external sound sources to the unbalanced, line level (-10 dBV) inputs **INPUT 1-4**, you can feed audio signals into the **G2** and process the audio with any of the available **G2** modules.

HEADPHONES OUTPUT

The **HEADPHONES** output routes audio signals which are assigned **OUTPUT 1** and **2**.

Note! Since the **G2** Engine lacks a volume knob, be careful when you use headphones so the volume isn't too loud. Make it a habit of always lowering the **Patch Level** in the Editor before using headphones with the **G2** Engine.

XLR MICROPHONE INPUT (G2, G2X)

The **XLR MIC INPUT** can be used for dynamic, non-Phantom powered microphones. If you use the **INPUT 1**, it will automatically override and disable the **MIC INPUT**. So, if you want to use a microphone be sure *no jack plug* is connected to the **INPUT 1**. The **MIC INPUT** has a built-in preamp so you don't have to amplify the signal externally to use a dynamic microphone on this input. The **G2X** model comes with a goose-neck microphone that can be readily plugged into the XLR connector.

G2 ENGINE REAR PANEL

Note! The Control Pedal input, the Sustain Pedal input and the XLR Microphone input are *not* available on the **G2** Engine model.

4. THE G2 EDITOR SOFTWARE

THE EDITOR SOFTWARE

On the CD-ROM that comes in the back of this manual you will find the **G2** Editor software for Windows and Macintosh OSX computers. This software opens up the full potential of the **G2** system. With this software you can manage the Patch and Performance memory banks, control all System, Performance and Patch functions and last but not least *create your own synthesizer and audio Effects models* as Patches and combine them into Performances ready to be recalled and played from the **G2** system Patch and Performance memory banks.

SOFTWARE INSTALLATION

NOTE! BASIC COMPUTER SPECIFICATIONS ARE FOR EDITING ONE G2.

EDITOR SYSTEM REQUIREMENTS WINDOWS PC

The Nord Modular **G2** Editor software requires a Pentium II PC running at 500 MHz or better with minimum 64 MB RAM for Windows 98SE, or a Pentium II PC running at 500 MHz or better with minimum 128 MB for Windows2000 and XP. Additionally a free **USB** (1.1) port plus a CD ROM drive to install the software from CD, a keyboard, a mouse and a graphics display with an on-screen resolution of 1024 by 768 pixels and a 16-bit color or better graphics adaptor.

The computer has nothing to do with the actual sound processing in the Nord Modular **G2** - it is used only for visual Patching and to send instructions to the Nord Modular **G2**. Note that a PC with lower specifications could be used without affecting the **G2** synthesis capabilities, but graphics might be dead slow and the PC might not be able to sustain the high **USB** data rate between the PC and the **G2**.

EDITOR SYSTEM REQUIREMENTS MACINTOSH

The Nord Modular **G2** Editor software requires as a minimum a Macintosh G3, 400 MHz, **USB**-port, 128 MB RAM and OSX 10.2 or later.

WINDOWS 98SE/2000/XP, APPLE MAC OSX

It is beyond the scope of this manual to explain the functions of these operating systems. In order to run the Editor, you need to be familiar with the basic functions of the computer, like mouse functions, saving and loading files to and from disk drives, moving and closing windows, closing dialog boxes etc. It is also important that the computer has a free **USB** port. On a Windows PC the Nord Modular **G2** **USB** driver must have been properly installed before connecting the Nord Modular **G2** synth to the PC.

WHEN EDITING MORE THAN ONE G2

The **G2** V1.4x Editor software supports up to four **G2** units to be connected to the computer. The system requirements in the previous paragraphs are for editing a single **G2**. To edit more than one **G2** you might want to use a computer that is about twice, three times or four times the specifications of the ones described, to prevent the screen graphics to appear slower. A currently 'state of the art' computer, like a Pentium IV running at 2GHz or faster, will easily be able to edit four **G2**'s and still have fast graphic screen refreshing for all the LEDs on the modules in a patch.

INSTALLATION OF THE USB DRIVER

Before connecting the Nord Modular **G2** synthesizer to a Windows PC, you need to install the **USB** driver for the Windows operating system. The **USB** driver makes it possible for the Windows PC to recognize the **G2** and for the Editor to communicate with the synth. To install the **USB** driver, do like this:

1. Insert the 'Nord Software CD' installation CD into the CD-ROM drive.
2. Connect the **USB** cable between the synth and the computer. The 'Found New Hardware' wizard should appear.
3. Let the wizard search the CD-ROM for the **USB** driver and install it.

INSTALLATION OF THE EDITOR ON A WINDOWS PC

1. Insert the 'Nord Software CD' CD into the CD-ROM drive.
2. Run SetupModular**G2_V1_4x.exe** located in the Modular G2 folder and follow the instructions in the setup program.
3. The Editor software will be installed in a folder named Clavia in the Program Files folder on the hard disk. During the installation you will be able to select an alternative location for the software.
4. Confirm every window in the installation procedure by clicking on the Next button. The installation may be aborted by clicking on Cancel.
5. When the installation is complete, click the Close button to return to the Windows desktop. There is no need to check in the 'Synth Updater' check box since the synth has the latest OS already installed from factory.

INSTALLATION OF THE MACINTOSH OSX EDITOR

To install the Editor software, simply drag the Editor V1.4x application located in the Modular G2 folder from the accompanied installation CD-ROM to the Macintosh and start the application from the computer.

STARTING UP

Make all the audio connections before turning on any of the devices. The computer that runs the Editor must be connected via an **USB** port to the Nord Modular **G2**. The **G2 V1.4x** Editor software supports up to four **G2** units to be connected to the computer, provided your computer is fast enough to handle all the data exchange between these four units.

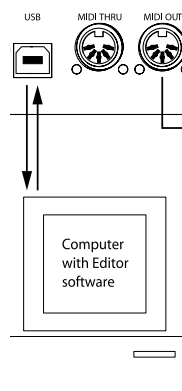

Connecting the G2 to the PC

SOUND SYSTEM

Connect the desired outputs of the Nord Modular **G2** to a sound system. We suggest that you start by connecting output 1 to the left channel and output 2 to the right channel of the sound system. Turn on Nord Modular **G2** first, followed by the sound system. Alternatively you can connect a head phone to the head phone output at the rear of the **G2**.

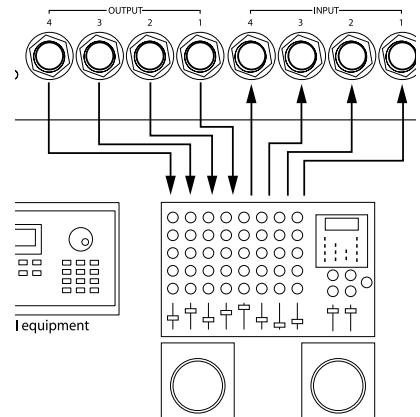

Connecting the G2 to the sound system

LAUNCHING THE EDITOR ON A WINDOWS PC

Power on the synth and make sure the **USB** cable is properly connected between the synth and your computer. From the Start menu in the Windows taskbar, select Programs | Nord Modular **G2** V1.4x | Modular Editor V1.4x. During the start-up procedure, the Editor software will automatically search for and establish contact with the Nord Modular **G2** synthesizer. If the connection between the synth and the computer is not working properly, an error message will appear. In that case, check the **USB** cable, make sure that the **USB** driver is properly installed and working, and that the synth is turned on. When the Editor has found the synth, the name of the connected synth is shown in the Status line.

5. THE EDITOR APPLICATION

The Editor provides you with a single, flat interface from where all functions can be easily accessed. The Editor screen is divided into a few sections, the Menu bar, a Toolbar, a Voice Area (VA) where modules are placed that are used in an individual Voice, and an Effects Area (FX) where a mix of the signals from the individual Voices can be routed to for processing by Effects modules like e.g. reverberation.

The Voice Area shows one Voice of the Patch. Other Voices will be exact copies of this one Voice, so there is no need to show these other Voices. Every action that you do in the Voice Area will affect all Voices in the Patch.

The Effects Area is per definition monophonic. This Area is similar to an External Effects unit used in a studio to give several instruments e.g. the same Hall reverberation. Note that on the G2 all types of modules can be placed in this Area, it is no problem to build up a synth here. However, that synth will only play monophonically. The Effects Area is also the ideal place to build the part of a drumkit that holds the Kick, the Snare and the HiHats, as these drum instruments are in essence monophonic.

Both the Voice Area and the Effects Area can use up a Patch load of 100% of Cycles and Memory.

Menu bar "Editor menu reference" on page 115

Toolbar "Toolbar" on page 59

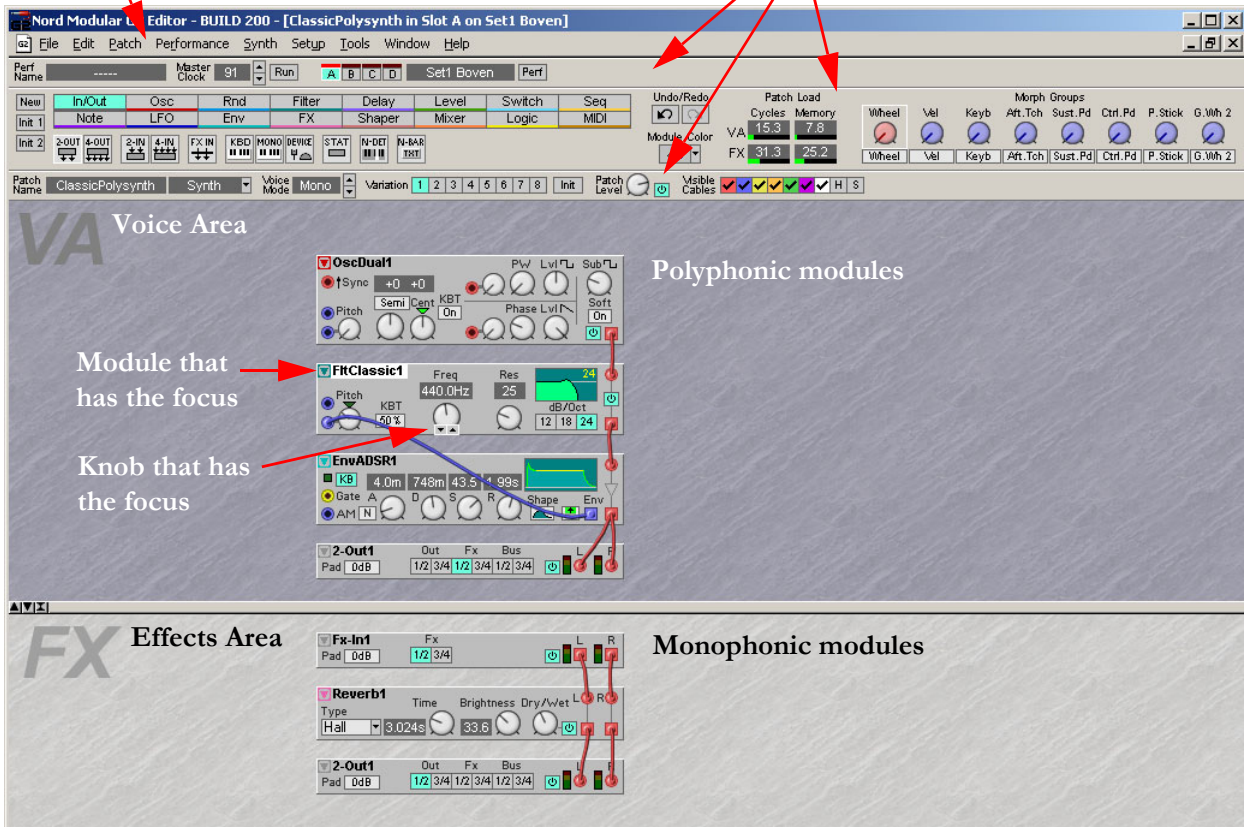

Module that has the focus

Knob that has the focus

Polyphonic modules

Monophonic modules

You will use the Toolbar a lot when making or changing a Patch. So, let's first have a look at the functions in the Toolbar before delving deeper.

TOOLBAR

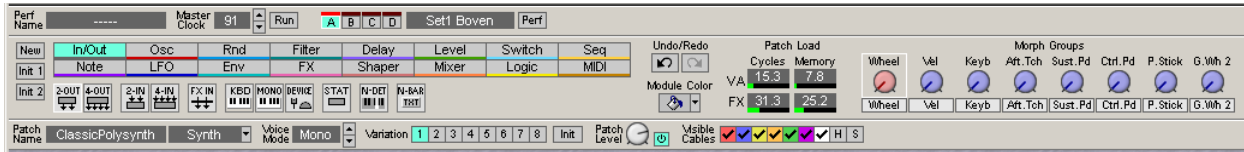

PERF: (NAME)

When the connected synth is in Performance Mode, or when the synth is disconnected, you can enter a name for your current Performance by clicking in the Perf box, typing in a name and pressing Enter. When the connected synth is in Patch mode, this box is disabled for editing.



MASTER CLOCK

Set the tempo for the Master Clock in BPM (Beats Per Minutes) by clicking the arrow buttons. Start and stop the Master Clock by clicking the Run button. Note that the Master Clock settings affects Patches in all four Slots in the synth. If the Master Clock receives external MIDI Clock (see “[Synth Settings {Ctrl-G}](#)” on page 120), the display box background will turn red and the current MIDI Clock rate will be displayed. When synched to external MIDI Clock, the tempo arrow buttons are disabled as well. When the **G2** system is sending MIDI Clock over the MIDI OUT connector the Run button will transmit MIDI Start/Stop commands.



SLOT BUTTONS

You can give a Slot the focus for editing by clicking on the Slot button. The window that contains the focused Slot/Patch will move to the foreground in the Editor application. The focused Slot has a white frame around it. Note that only one Patch can be focused in the Editor at the same, so you can only edit one Patch at a time. To edit another Patch in another Slot give that Slot the focus by clicking on its Slot button.



You can activate/deactivate several Slots on the same instrument by Shift-clicking on the corresponding Slot buttons. If several Slots are active, this is indicated by the blue Slot buttons. If you want to change the Keyboard Assign settings (to select which Slot(s) should be controlled from the **G2** keyboard), Ctrl-click the Slot button(s). All slot buttons that have a *red line on top* (the keyboard indicator) of them will *follow the keyboard*, activated slot buttons that do not have a red line will *only follow* MIDI.

CONNECTION INDICATORS

Here, the connected Nord Modular **G2** synths are visible. The name is shown in the box to the right of the Slot buttons. Connecting or disconnecting the **USB** cable will make the connection indicator(s) automatically appear or disappear.



When editing more than one **G2**, the names of the connected synths will appear from left to right in alphabetical order in the toolbar. Click on the Slot button next to the name of another connected **G2** to start editing the patch in the Slot on the other synth.

PERF

The Perf button indicates if the connected synth is in Performance Mode or not. Performance Mode will group the four Slots together, leaving Performance Mode will ungroup the Slots. Click



this button to go into or leave Performance Mode. You can also switch mode on the connected synth by clicking the Performance Mode button on the **G2** frontpanel. See also “Performances” on page 18.

NEW

Creates a new, empty Patch window. If connected to the synth, the currently active Slot will be cleared to host your new Patch. See “Making your first patch” on page 63 for info on how to create a new Patch.



INIT 1 & 2

Click on the Init 1 or Init 2 buttons to recall one of the two Init Patches (see “Save InitPatch1 & 2” on page 116 for info on how to create Init Patches). If connected to the synth, the selected Init Patch will be downloaded to the currently active Slot.



MODULE GROUP SELECTORS

The **MODULE GROUP** selectors are



located in the left section of the Toolbar. Click on a selector to select a module group. The currently focused Module Group is shown as a blue Module Group selector button.

MODULE ICONS

When a Module group is selected all the modules in that group will



show up as **MODULE ICONS** under the Module Group selectors. As you move the cursor over each **MODULE ICON**, a preview of the module with its module name is shown. Modules are added to a Patch by simply dragging a **MODULE ICON** to either the Voice Area or the FX Area.

PATCH LOAD, CYCLES AND MEMORY

The Patch Load indicators indicate how much computational resources the Patch uses. The VA indicator shows the Patch Load for the Voice Area (upper part of the Patch window), and the FX indicator for the FX Area (lower part of the Patch window). The reason for having two separate Patch Load indicators is because it makes it easier for the user to calculate the maximum polyphony of a Patch. If you run out of computational resources in a Patch (if 100% Load is exceeded in any of the Areas), the corresponding Patch Load indicator turns red and the outputs of the synth will be muted. Delete one or several modules to reduce the Patch Load, or change a module with radio button selectors to a module with a dropdown selector. You might alternatively use shorter delays by selecting a shorter maximum delatime in a delay module dropdown selector. See “Voice allocation and polyphony” on page 138 to read more in depth info about how the **G2** uses computational resources.

Patch Load		
	Cycles	Memory
VA	23.3	30.5
FX	40.6	55.4

The two Memory indicators basically have the same functionality as the Patch Load indicators, but display the use of memory in the Patch.

Note! If any of the indicators goes above 100%, the outputs of the synth will be muted. Delete one or several modules that uses memory to reduce the Memory load. See [“Voice allocation and polyphony” on page 138](#) to read more in depth info about how the **G2** uses memory.

UNDO & REDO

The Undo (to the left) and Redo buttons can be used to undo or redo changes you made in the Patch. There are many levels of Undo in the Editor, which is great when experimenting with a patch. The Redo function works like a “reversed” Undo.

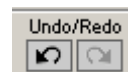

Note! The effect of the Rnd and Clr buttons on Sequencer modules can not be undone.

COLOR

You can choose to recolor any modules in the Patch window. First select a module and then select a color from the Color selector in the Toolbar. Note that the color selector stays in its new selection, causing any new modules that you add to the Patch window to get the selected color. You can also make a selection of any combination of modules in the Patch window (Ctrl-LeftClick) and then click on the “paint bucket” icon, or select a new color from the drop-down list, to apply the color to the module(s).

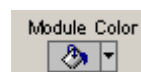

MORPH GROUPS

There are eight Morph groups available in each Patch and you may assign a total of 25 Patch parameters to these Morph groups. You can assign



each Morph group to any of the predefined controls **MODWHEEL, KEYBOARD VELOCITY, KEYBOARD NOTE VALUES, AFTERTOUCH, CONTROL PEDAL, SUSTAIN PEDAL, PITCH STICK, THE G2X GLOBAL MODWHEELS** or to **ASSIGNABLE KNOBS** on the front panel.

If you want to assign a Morph group to an **ASSIGNABLE KNOB** instead of the predefined control source, simply click a Morph knob in the Toolbar to give it focus. Then, right-click the Morph group knob and select Assign | Page X | Knob. The captions above the Morph knobs can be renamed by right-clicking on a knob and selecting ‘Edit name’. You can also assign the Morph **GROUP** knob to a MIDI controller by right-clicking and selecting MIDI Controller | Assign. Note that the fifth Morph group can be controlled by either the Sustain Pedal, the Global Wheel 1 or a Knob.

See [“Morphs” on page 20](#) for more info about Morph groups.

PATCH NAME

Here is the name for the active Patch shown. Click in the box to type in a Patch name. Press Enter on the computer keyboard to enter the name and exit the Patch name box. To exit without changing the name, press Esc. If the Patch is active in a Slot of the synth, the name will be shown in the **MAIN DISPLAY** as well. A standard English character set is available. Any ‘illegal’ characters that you may type will be substituted with empty spaces.



CATEGORY

Select sound category for the active Patch from the drop-down list. See [“Selecting Sound Category for the Patch” on page 87](#) for more info.

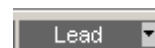

VOICE MODE

The actual polyphony of a Patch is displayed in the Voice Mode display box. The requested number of voices is displayed within parenthesis. Select number of voices with the arrow buttons (mono, legato, 2-32). Note that every time you change the number of voices, the Sound engine has to recalculate the Patch data which will cause a brief moment of silence. Should your request for polyphony exceed the available computational resources, the system assigns the highest possible amount of voices to the Patch instead. See [“Voice allocation and polyphony” on page 138](#) for more info. If a patch exceeds 100% or it cannot fit because other slots have already used up all computational resources or audio delay memory, the display will turn red.

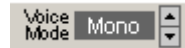

VARIATION

Select one of the 8 Patch Parameter Variations by clicking the corresponding Variation button. Click the Init button to load the Variation Init settings for the Patch. See [“Creating Patch parameter Variations” on page 88](#) for info on how to create Variations. The Variation buttons are hard-wired to MIDI Controller #70, so you can select another Variation by sending MIDI CC70 plus a value to the Slot. Clicking with the right mouse button on one of the Var. buttons will open a popup menu where you can quickly copy the focused Variation to another Variation or to the Variation Init buffer.

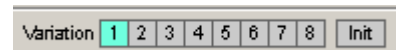

VAR INIT

This will copy the variation settings from the Variation Init buffer to the focused Variation. Note that the Variation Init buffer is stored within a Patch along with the eight Variations.

PATCH LEVEL

Set the total output level from the Patch with the knob. Mute the output from the Patch by clicking the On/Off button. The Patch Level knob is hard-wired to MIDI Controller #7.



VISIBLE CABLES

Click on any of the seven colored buttons to select which cable group(s) should be visible/invisible in the Patch. “Invisible” cable connections will be indicated by a colored dot on the in- and outputs of the connected modules. The white button represents any remaining connections after you have broke a part of a cable chain.



HIDE ALL CABLES

Click the {H} button to hide all visible cables in the active Patch. “Invisible” cable connections will be indicated by a colored dot on the in- and outputs of the connected modules. Pressing the space bar on the computer keyboard performs the same operation.

SHAKE CABLES

Click on the {S} button to reposition - shake - the cables in a Patch. This can be useful if it is hard to see where the cables are actually connected, or if they hide visual information (display boxes etc.) in the Patch. Pressing the Ctrl key and the space bar on the computer keyboard performs the same operation.

PATCH WINDOW SPLIT BAR

Click-hold on the Patch window split bar and drag up or down to resize the two Patch sections, the Voice and FX Areas. Click on the up arrow button to the left in the bar to show only the Voice Area, and on the down arrow button to show only the FX Area. Click on the double arrow button to place the split bar on the previous split position. Press V on the computer keyboard to toggle between the current split position and viewing only the Voice Area. Press F on the computer keyboard to toggle between the current split position and viewing only the FX Area.



MAKING YOUR FIRST PATCH

CREATING A NEW EMPTY PATCH

Click on the **NEW** button. Modules that were shown on the screen will disappear and there is a new blank Patch.



INSERTING AN OUTPUT MODULE

Click on the **IN/OUT** Module Group selector. Click on the leftmost Module Icon named **2-OUT**, hold the mouse button pressed and drag the Module Icon onto the grey background of the Voice Area. Output modules connect signals in a Patch to the physical LineOut and Headphone connectors on the back of the **G2**. So, its a good idea to always start with an Output module to be able to hear sound while patching.

INSERTING A SOUND SOURCE MODULE

Now you are going to insert a module that will actually generate sound. The module that is going to be inserted is named an Oscillator and will basically be responsible for the pitch of the sound. Click on the **OSC** Module Group selector and hold the mouse over the Module Icons until you find a Module that is named **OSCDUAL**. Drag this module onto the Voice Area background. Lower the volume of your amplifier or set the Master Level on the **G2** to very low, as you are going to connect the output of the OscDual module to an input on the 2-Out module, which will immediately output sound on the LineOut1 connector or the headphone.

Click with the mouse on the *squared red connector* in the lower right corner of the OscDual module and keep the mouseknob pressed. Drag the mouse pointer to the left *circular red connector* named 'L' on the 2-Out module and release the mouseknob there. This will draw a cable between the OscDual output and the 2-Out left input. If all went well you should hear a bright tone from one of your speakers.

Click again on the squared red connector on the OscDual module and again drag, but now to the circular red connector named 'R' on the 2-Out module. After this you should hear the tone come out of the other speaker as well. Adjust the Master Level knob on the **G2** or your amplifier volume knob for a comfortable sound level.

Play some notes on the keyboard and hear how the OscDual automatically follows the keyboard. Oscillator modules will follow the keyboard by default. Notice that *squared connectors* on modules are *outputs*, and that *circular connectors* are *inputs*.

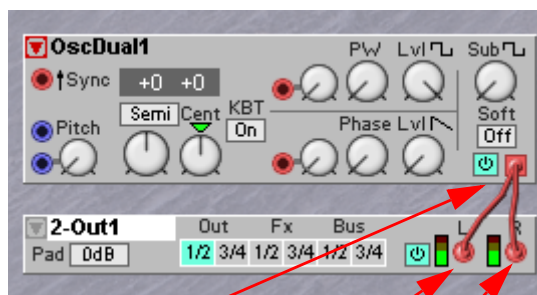

Output connector

Input connectors

DISCONNECTING A CABLE

An Oscillator gives a continuous output and needs something extra to give it a loudness contour or envelope, to cause a Patch to only make sound when a key is pressed on the keyboard. For this you need an extra module inbetween the Oscillator output and the Output module input. First disconnect the cables. Do this by doubleclicking on one of the circular input connectors on the 2-Out module and keeping the mousebutton pressed on the second click. Now slowly drag the mouse away from the circular input connector onto the grey background of the Patch and release the mousebutton. If all went well the cable has disappeared. Disconnect the cable on the other circular input connector in the same way.

INSERTING AN ENVELOPE MODULE

Select the Module Group selector named **ENV**. Drag the leftmost Module Icon named **ENVADSR** in the Voice Area inbetween the OscDual module and the 2-Out module. Notice that the new module will 'push' the other modules away if there seems not enough space between the already placed modules. This is to prevent that modules would overlap and maybe become invisible. In fact it is impossible for modules to overlap, the Editor will not allow this.

Now make connections from the **ENVADSR** *squared blue output* connector that is in the *lower righthand corner* of the module to both *circular input connectors* of the 2-Out module. Next step is to connect the *squared red output* of the OscDual module to the *circular blue input* at the *top righthand corner* of the EnvADSR module. Notice that when you connect a red output to a blue input the blue input changes to a red color and the blue output on the same module changes to red as well. This red color indicates that this module will now process signals at the highest audio quality.

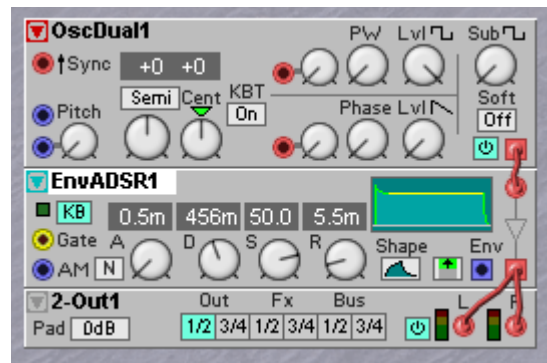

At this point the patch should look like the illustration. Notice that you don't hear any sound, as the **ENVADSR** isolates the OscDual from the outputs. However, when you now press a key on the keyboard you will hear a note play as long as you hold the key.

This shows one of the basics of modular synthesis, the OscDual module and the EnvADSR module work together to do a musically sensible thing, each doing its own thing in the sound: the Oscillator defines the pitch and the Envelope defines the loudness contour.

Have a closer look at the **ENVADSR** module. Notice the four knobs named **A**, **D**, **S** and **R**. These four knobs define the form of the loudness contour. Click and hold the mouse on the rightmost knob named **R** and try to turn it so the display reads 1.60s. Again play some notes on the keyboard. You hear how the played notes die out more slowly after you released the key.

MAKING THE PATCH POLYPHONIC

At this point the patch plays monophonic. With the Voice Mode setting you can easily assign more voices to this Patch. Click on the upper triangle button next to the Voice mode display until it shows eight voices.



When playing the keyboard you will notice that now you can play chords and the dying out of the voices will overlap new notes.

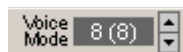

The actual polyphony of a Patch is displayed in the Voice Mode display box. The requested number of voices is displayed within parenthesis. The system assigns the highest possible amount of voices to the Patch when your request for polyphony exceed the actual capacity of the Sound engine. In practice many traditional polyphonic synthesizer sounds can be played with six to eight voices of polyphony, the amount of voices one would typically find on a traditional analog polysynth.

Note! The dynamic allocation method used by other multitimbral hardware synthesizers is not applicable to the Nord Modular **G2**, see also “Voice allocation and polyphony” on page 138.

You can easily adjust the polyphony for a Patch in the synth by selecting a **SLOT**, pressing the **PATCH SETTINGS** button and turn the **KNOB** below the Voice Mode **DISPLAY**. This can be useful if you have a couple of Patches loaded in several **SLOTS** and wish to quickly redistribute the polyphony among the Patches.

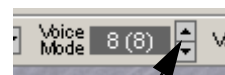

Set the requested number of voices by clicking the arrow buttons. The requested number of voices is shown within parenthesis and the actual number of voices is shown to the left in the display box.

The Nord Modular **G2** note recognition system operates according to the “last note” principle. If you run out of polyphony and continue to play notes, the synthesizer will always add the last note played and remove the first note, with one exception: it will try to keep the lowest note sounding.



See the actual and requested number of voices allocated to the Patch in the display.

ADDING SOME TIMBRAL CONTROL

The sound of this Patch is not really something special, it sounds overly bright, a bit thinnish and not very lively. It is time to do something about the timbre by adding a filter module that will give more character to the sound. This filter will be inserted between the OscDual output and the EnvADSR input.

Select the **FILTER** module Group selector and find a Module Icon named **FLTCLASSIC**. Drag the Module Icon into the Voice Area on the separation line between the OscDual and the EnvADSR module. Next step is to disconnect the cable between the OscDual and the EnvADSR. Then make a cable connection from the OscDual output to the FltClassic input and from the FltClassic output to the EnvADSR input. Notice that inputs and outputs line up nicely at the right side of the modules.

When you play notes you will notice that the sound lost much of its brightness, caused by the filter removing all the high harmonics. To give the sound more character it is custom to give the timbre a contour, similar to the loudness contour. On the **ENVADSR** module you see an extra blue output named **ENV**. This output produces a control signal that follows the loudness contour. This signal can cause the FltClassic to follow the loudness contour as well, which makes the filter ‘sweep’. For a filter sweep a cable connection has to be made from this blue Env output to the Pitch input on the FltClassic module. Then, by opening the knob next to this Pitch input the amount of contour that controls the FltClassic can be set. Open this Pitch knob on the FltClassic about a quarter and also lower the **S** knob on the EnvADSR module until it is halfway, to make the contour more snappy.

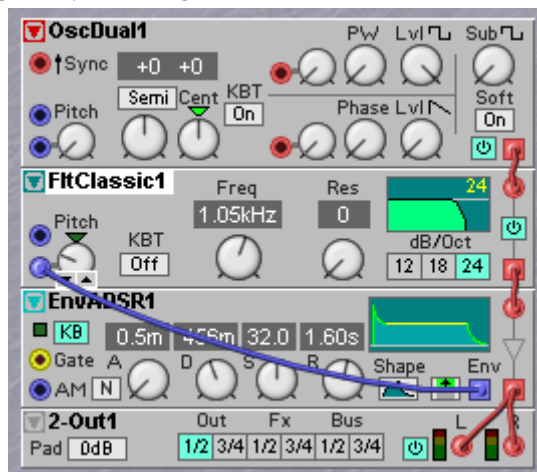

At this point you have made a basic patch that has three separate modules to control the pitch, the timbre and the loudness contour. Now it is time to try out the knobs on the modules. Change knobs by small bits only, so you clearly hear in what ‘direction’ it makes the sound change.

ADDING REVERB

Adding some reverberation can greatly enhance the sound of a synthesizer. Reverb can be applied globally to all voices, so it is best to place this reverb into the **FX AREA**. The audio signals from the Voices must be routed to the FX Area first. On the 2-Out module you see an *Output Destination selector*. If you click on the button **FX 1/2** the signals will be routed to the FX Area. In the FX Area these signals need to be received and there is a special module for this, the **FX-IN** module that you will find in the **IN/OUT** Module Group. The FX Area also needs an output module to the LineOuts and this can again be a **2-OUT** module, with its *Output Destination selector* set to the default **OUT 1/2**. Between the Fx-In and the 2-Out module in the FX Area you can connect the Reverb module that you will find in the FX Module Group. Insert these modules in the patch and make the cabling just like in the illustration.

Note that there can be a lot of sound coming in on the FX-In module when routing a *polyphonic* patch into the FX Area and a lot of notes are played at the same time. This might cause the mix of the Voices to hit the signal headroom and cause clipping. To prevent possible clipping you must set the **PAD** button on the left side of the **FX-IN** module to **-6dB** by clicking once on this button. This will give you some extra 6dB of headroom, but will also make the overall output volume drop. To compensate for the drop in volume you can set the **PAD** button on the **2-OUT** module in the **FX AREA** to **+6dB**. To always be on the safe side, it is wise to make these settings in every polyphonic patch that uses the FX Area. For monophonic patches it is not necessary to make these settings.

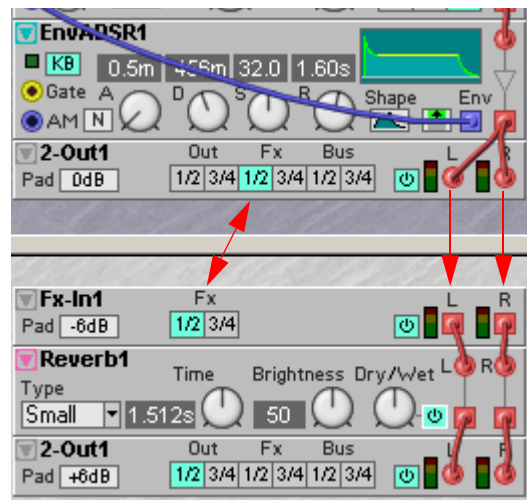

ADDING VELOCITY SENSITIVITY THROUGH A MORPH

To use the keyboard *Velocity Sensitivity* we will use the **VELOCITY MORPH GROUP**. The question is only where to apply it. The most logical use for Velocity is to control the loudness of each individual keypress. So, you need to apply the Velocity Morph to a volume control that is in the voice itself. But right now there is none, meaning that you first need to insert a module with a volume knob. A very interesting choice is to use a **EQPEAK** module, which you will find in the **FILTER** Module Group. This EqPeak module has a volume control named **LEV**. When acoustic sounds are played louder the middle frequency range is also boosted a bit. This module gives you the possibility to both control the volume for the note *plus* boost the middle range by applying the Velocity Morph to both **LEV** and **GAIN**.

First insert a EqPeak module in the patch and connect it between the output of the EnvADSR and the 2-Out module in the

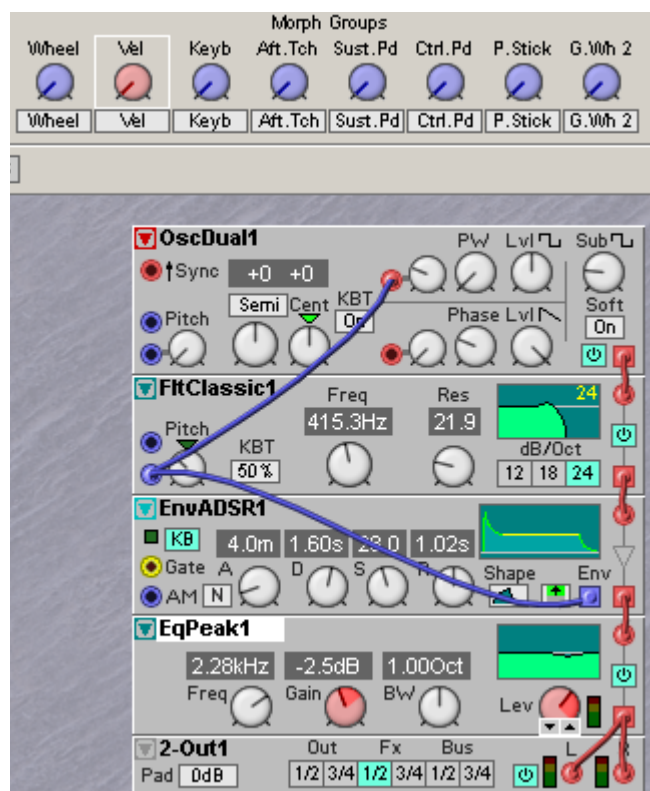

Voice Area. Now click on the knob above the **VEL** Morph Group, so this knob shows up in red. Reduce the Lev knob on the EqPeak module to about 80. Now press the Ctrl key on the computer keyboard, keep it pressed, and turn the Lev knob fully open with the mouse. You see that this leaves a *red area* on the Lev knob that shows the *Morph range*. Now set the Freq of the EqPeak to between 2kHz and 3kHz, set the Gain knob to about -2.5dB, again keep the Ctrl knob pressed and open the Gain knob to about +7dB. These actions have assigned the Lev knob and the Gain knob to the Velocity Morph. If all went well it should look like in the illustration. Play some notes on the keyboard and hear how the Velocity now works out on the sound.

RECHECK YOUR WORK

Take some time now to retrace the signal flow in the Patch until you are sure you understand how the initial signal from the Oscillator is processed by the other modules and ends up in the FX Area.

CHANGING A MODULE INTO ANOTHER TYPE FROM THE SAME MODULE GROUP

When you want to check out another Oscillator instead of the OscDual, you can instantly replace it through the **DROPDOWN MENU ICON** in the top lefthand corner of the module. If you click on this Dropdown Menu Icon a list will appear, showing all modules in the Module Group. Instead of the OscDual you could e.g. pick the OscShapeA module and play with its Shape knob to change the basic sound of this oscillator.

Note that this Shape knob also has a modulation input where you can connect the Env output of the EnvADSR module to have the waveshape glide along with the loudness contour, just like the filter swept along with the loudness contour.

NOTE! When replacing a module by another module the Editor will try to keep all cable connections. Note however that some modules do have extra inputs, and if these are used it might affect the recabling. Like if you change the OscShpA into a OscD oscillator the cable to the Shape input will get lost. Try out and see for yourself how choosing another module affects the recabling.

Note that you can always use the Undo function a couple of times to revert to a previous situation.

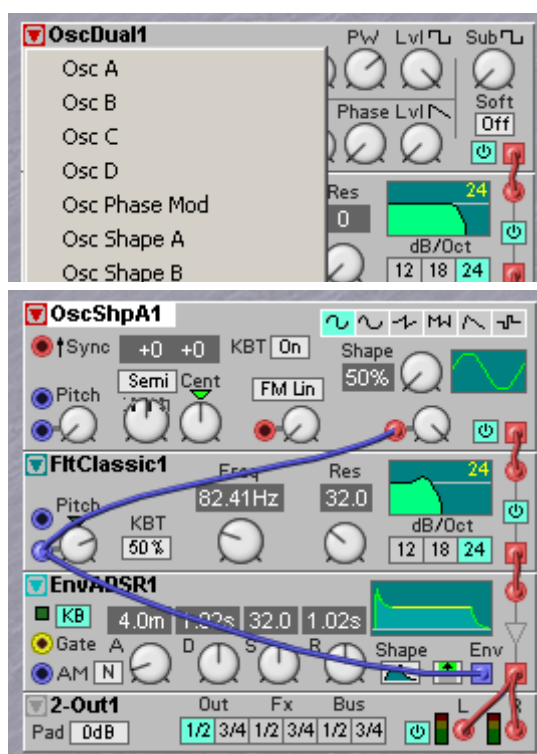

ASSIGNING FRONTPANEL KNOBS

Finally, to make the Patch editable and controllable from the Nord Modular **G2** front panel, you can assign any parameter in the Patch to any of the 8 **ASSIGNABLE KNOBS**.

Let's say you want to assign the 'EnvADSR1' Attack to **PAGE 1A, KNOB1**.

First, use **CTRL-F** to call up the **PARAMETER PAGES** window from the **TOOLS** menu. Hold the **ALT**-key and drag the EnvADSR **A** knob to the grey display in the **PARAMETER PAGES** window above the leftmost knob.



Proceed with Alt-dragging some more knobs to the **PARAMETER PAGES** window until you are satisfied. Alternatively you can drag a grey display above a knob in the parameter pages to a module knob without using the Alt-key. See also [“Assign a parameter to a knob” on page 90](#) for alternative ways to make assignments.

RENAMING AND SAVING A PATCH

To (re)name the Patch, click on the Patch Name display box to the upper left of the toolbar and enter a Patch name. Press Enter on the computer keyboard and the Patch name is changed in the Editor and in the **MAIN DISPLAY**.

Save your Patch on the computer using **SAVE AS** from the **FILE** menu. To save the Patch in the memory of the Nord Modular **G2** (and Engine), select **SAVE IN SYNTH** from the **SYNTH** menu. Select memory location from the list(s) and click Store. *Note that the original Patch in the selected memory location (if any) will be overwritten by your new Patch. Make sure you do not overwrite Patches you want to keep! It is a good idea to save a backup of all your Patches on the computer, just in case.*

POPUP MENUS IN THE EDITOR

PATCH WINDOW POPUP

Right-clicking on the background of the Patch window brings up a popup with the following alternatives:

CUT/COPY/PASTE

Use to cut and paste or copy and paste module(s) in the Patch window or between different Patch windows.

INSERT

Brings up a sub menu which features the different module groups including their

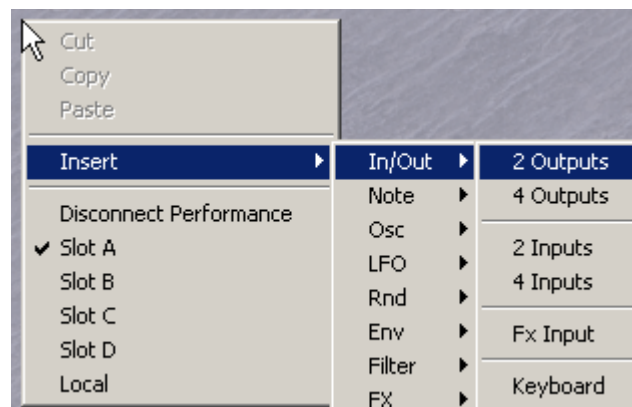

modules. Select desired module by clicking on it from the list. A phantom frame appears and the cursor gets a plus-sign next to it. Place the phantom frame where you want the module to be placed in the Patch window and click to drop the module.

DISCONNECT PERFORMANCE

Select to disconnect your active Performance from the Slots and continue working on it locally in the Editor.

SLOT A/B/C/D/LOCAL

Select the Slot to use for your active Patch by selecting Slot X from the popup. If you want to disconnect your active Patch from a Slot, select Local.

MODULE POPUP

Right-clicking on the background of a module brings up the module popup.

CUT/COPY/PASTE/PASTE PARAMS

Use to cut and paste or copy and paste module(s) in the Patch window or between different Patch windows. Use the Copy and Paste Params to copy all parameter values from the selected modules and paste the values to other modules of the same type *or the same modules in another variation*.

RENAME

Allows you to rename the module. Type in a new name and press Enter. Press Esc to cancel the operation.

ASSIGN

Select to assign all module parameters to one (or more, if necessary) Parameter Pages.

GLOBAL ASSIGN

Select to assign all module parameters to one (or more, if necessary) Global Parameter Pages.

HELP

Brings up the context-sensitive help-text for the selected module type.

DELETE

Allows you to delete the module from a Patch. All the cables that are connected to and from the module will be deleted as well. Any serial connections of cables will be rerouted.

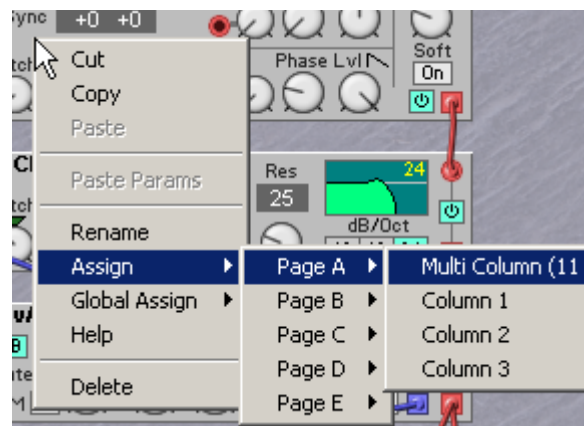

PARAMETER POPUP

Right-clicking on a module parameter brings up the parameter popup.

DEFAULT VALUE

Resets the parameter to its default value.

MORPH ASSIGN

Allows you to assign or deassign the parameter to/from one of the 8 available morph groups.

EDIT NAME

Allows you to rename a renamable module parameter (Name buttons like the On/Off buttons on Mixer/Switch modules, for example). Type in a new name of maximal seven characters and press Enter. Press Esc to cancel the operation. See also [“Name buttons” on page 75](#).

ASSIGN

Select to assign the module parameter to a knob/button on a Parameter Page. See also [“Using Parameter Overview to make knob assignments” on page 126](#).

GLOBAL ASSIGN

Select to assign the module parameter to a knob/button on a Global Parameter Page. See also [“Using Parameter Overview to make knob assignments” on page 126](#).

MIDI CONTROLLER

Allows you to assign one of the available MIDI controllers to the parameter. Selecting Remove clears an assignment. See also the chapter [“MIDI Controllers” on page 143](#).

HELP

Brings up the context-sensitive help text file for the selected module.

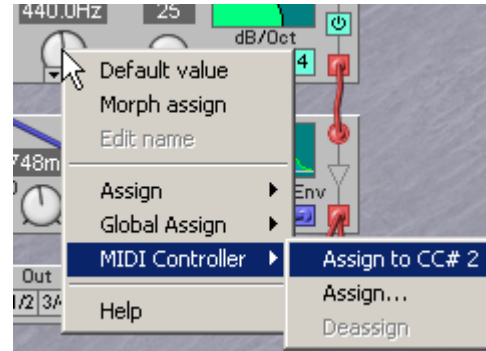

CABLE POPUP

Right-clicking on a cable connection brings out the cable popup.

DISCONNECT

Deletes the connection. Any remaining cable chains will be rerouted.

BREAK

Breaks a serial connection between a selected input connector and the previous connector in the serial chain. The rest of the serial chain will remain unaffected, meaning that the first part of the chain will still work, and the last part will be connected but non-functional (input-to-input connection(s) only). If you choose to break a connection at an output, the connection(s) between the output and the first input of one or more serial chains will be removed. The rest of the chain(s) will remain connected but non-functional (input-to-input connection(s) only).

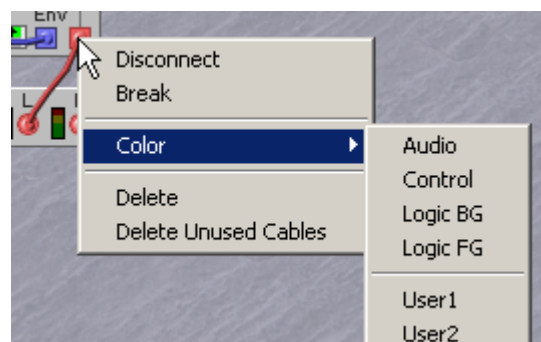

Any non-functional input-to-input connections are indicated by white cable color.

COLOR

The six available cable colors are identified by their names.

- Audio cables are red
- Control cables are blue
- Logic cables are yellow
- Logic cables at full bandwidth are orange
- User1 cables are green
- User2 cables are purple

You can choose another color (name) for a cable in this popup. Changing cable type will not affect the functionality in any way, just the appearance. Cables in a serial cable chain will always have the same color. Cables in a branch connection may have different colors. It's possible to show and hide cables of different colors in the Patch to make Patching easier. See [“Visible cables” on page 62](#).

DELETE

Deletes the entire serial cable chain that the connection is part of. If you want to delete a complete branch connection, this must be done from the cable origin of the branch.

DELETE UNUSED CABLES

Deletes all non-functional input-to-input connections (white cables) in the Patch.

BASIC MODULE FUNCTIONS

CABLES AND CONNECTORS

Almost every module and nearly every function of a module can be Patched to other modules and functions, using virtual cables. Each module has one or more connectors (except for some modules in the MIDI module group which have no connectors). These connectors come in two different shapes: circular inputs and square outputs, and three different variants: red audio, blue control and yellow logic connectors. Most of the modules share the same basic layout, with the audio input connector(s) to the top right and the audio output connector(s) to the bottom right.

MODULE OUTPUT SAMPLE RATE

Modules can process and output signals at two sample rates: 96kHz and 24kHz.

The fast 96kHz sample rate is used for processing audio signals. Modules that generate audio signals, like Oscillators, all generate the audio at a 96kHz sample rate. You can tell the sample rate of an output signal by the color of the output connector, if it is red or orange the sample rate of the output signal is 96kHz. Cables connected to this output will inherit this color. Note that you can change the color of the cables

later, which does not change the sample rate! Always look at the color of the output connector, as that color will not change when changing the color of a cable and give the correct indication.

The sample rate of 24kHz is used for slowly changing modulation signals, like the signals from LFO modules. A module that produces signals at the 24kHz sample rate will have a blue or a yellow output. The 24kHz sample rate is also used for Event signals (*logic* signals, see “[Yellow and orange outputs, logic states](#)” on page 72) like the Gate signal of the keyboard.

It is very well possible to use signals at the 24kHz sample rate as audio signals, but they will have a slightly ‘LoFi’ character, especially at higher audio frequencies.

MODULE INPUT SAMPLE RATE

The inputs of modules can also work at either the 24kHz or 96kHz sample rate. Most inputs work by default at 24kHz, but when a red or orange signal is connected they will automatically change to a red or orange input and start to work at the ‘high quality’ 96kHz sample rate. This will guarantee maximum quality audio when a module is modulated by an audio signal. Red and orange inputs will use more computational resources in the G2, so you will see the Patch Load go up when an input changes color from blue or yellow to red or orange.

RED AND BLUE OUTPUTS, BIPOLAR AND UNIPOLAR

These outputs produce smooth ‘analog’ signals with a very fine resolution. They are used for audio purposes (red) or smoothly gliding modulation purposes (blue). The signals can be *bipolar*, which means that they can take on positive and negative values, or *unipolar* which means that the signal has only positive or only negative values. On many modules a scroll button will allow you to select if the output is bipolar, unipolar, inverted and some more settings. E.g. the bipolar signal on the output of an LFO module will swing smoothly between values of -64 units and +64 units. A positive unipolar signal will swing smoothly between 0 units and +64 units. As +1 unit on the Pitch input of an Oscillator will transpose the Oscillator by one semitone, this means that a bipolar LFO signal can sweep the oscillator over five octaves up and five octaves down.

Audio signals are in general bipolar, just imagine that the cone of your loudspeaker swings backwards and forwards from its neutral position.

Modulation signals are often unipolar, to make a modulation go into one direction only. Imagine a tone that only sweeps up in respect to its basic pitch played from the keyboard.

See for more in depth information “[Signal types in a Patch](#)” on page 134.

YELLOW AND ORANGE OUTPUTS, LOGIC STATES

These outputs produce a signal that can only be HIGH or LOW. They are used to flag musical Events, like the pressing of a key on the keyboard or when the Masterclock advances a tick and are named *logic* signals. The output value is interpreted as a HIGH or a LOW *state*, but it has an actual value of either 0 units or +64 units. Logic signals can be safely scaled down in a mixer, which will change the yellow or orange signals into blue or red signals.

See for more in depth information “[Signal types in a Patch](#)” on page 134.

YELLOW AND ORANGE INPUTS

Yellow and orange inputs will not only accept yellow and orange signals, but also red and blue signals. In this last case the input will interpret a positive signal level as a HIGH state and a negative or zero signal level as a LOW state.

Yellow and orange inputs that react on a Trigger (these inputs have an arrow symbol next to their input), and receive a red or blue signal, react to the moment when the red or blue signal changes from any negative or zero value to any positive value. This moment is sometimes named the ‘zero crossing’. See for more in depth information “[Signal types in a Patch](#)” on page 134.

DISPLAY BOXES AND GRAPHS

Some modules feature one or more display boxes that display alphanumeric and/or graphical information. Some oscillator modules, for example, display the frequency. The read-out of the oscillators is selectable between Hertz (absolute frequency values) and semitones (pitches on the musical scale), by clicking on the corresponding scroll button. Graphical information in display boxes can be envelope curves, wave shapes, frequency diagrams etc.

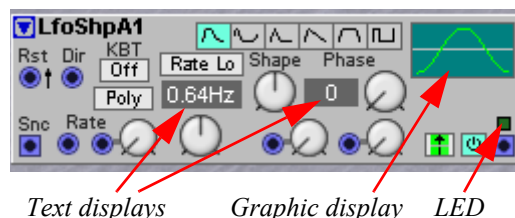

LEDS

Some modules have LEDs to indicate functions. The rate of a LFO, the opening or closing of an Envelope or the current step position in a sequencer module are some examples of where LEDs are used. The LED’s of some modules can be assigned to a panel knob, making the LED-ring around the knob give a visual indication about speed and waveform of some LFO’s or the VU-level of an output module.

BASIC MODULE PARAMETER CONTROLS

PARAMETERS

See for definition “[Parameters](#)” on page 19.

A knob parameter in the Editor is “turned” by click-holding it and moving the mouse. Click on the increment and decrement buttons to change the value one step at a time. You can also use the computer keyboard Up and Down arrow keys to increase and decrease the focused parameter value. A button is toggled simply by clicking on it.

Tip! When pressing the Patch button on the **G2** panel (associated LED lights up), the module that is selected in the Editor program by a mouse-click on the module will have all its knobs and controls temporarily auto-assigned to the assignable knobs on the **G2** Panel. The Displays on the Panel will show the values and you can immediately tweak the Panel knobs instead of turning the knobs with the mouse in the editor program. Use the **PARAMETER PAGES 1 to 3** buttons if the module has more than eight knobs and controls. Pressing the Patch button again (LED goes Off) will make the Panel return to its normal mode.

PARAMETERS THAT CAN’T BE CHANGED BETWEEN VARIATIONS

There are some things in the Patch that can’t be changed for different Variations: the number of modules, cable connections and functions in drop-down selectors on modules, such as the drop-down waveform selectors on Oscillator C and D, for example. This is because when the above mentioned things are changed, the internal **G2** system sound-engine has to recalculate the whole Patch, which necessarily causes a brief moment of silence. Since Variation changes should be “glitch free”, these restrictions are unavoidable. If you want to be able to switch Oscillator waveforms between Variations, use modules with radio buttons instead, Oscillator A, B and ShpA, for example. The same goes for some of the LFO modules.

Technically it is also not possible to ‘smoothly glide’ from one Variation into another, as Radio Buttons and Switch modules simply would not know when to switch during such a smooth glide, or ‘glide through’ or ‘jump over’ intermediate switch positions. Still, if a Parameter on a module is controlled through a Constant module connected to a modulation input, and a Glide module is inserted between the Constant module output and the modulation input, it is very well possible to make a smooth glide *for that one parameter* when switching to another Variation. Meaning that it is possible to create ‘smooth glide effects’ between Variations, but you have to set it all up yourself with Glide modules while creating a new patch in the Editor program.

BUTTONS

A (push)button can only have two states (ON or OFF). An example of a button is the ON/OFF button of the Oscillator modules. The ON position is indicated by a colored button, meaning that the button ‘lights up’ to e.g. show that the module is active.



RADIO BUTTONS

Radio buttons are basically a row of selection Buttons where *only one* button can be ON or active. If you click on one of the buttons, the previously active button will automatically be deactivated. An example of radio buttons are the waveform buttons of the OscillatorA module. The selected button is indicated by a colored button

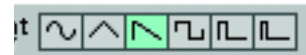

ARROW BUTTONS

By clicking on an arrow button you increment or decrement a parameter value by one step at a time. If you click and hold an arrow button the value is auto incremented/decremented. An example of arrows button are the buttons in the Analysis section of the Vocoder module.



KNOBS

A knob is the type of circular knob found on almost all modules in the Nord Modular G2 system. Examples are the Pitch modulation, Semitone and Fine tune knobs on the OscillatorA module. If a knob has a *green triangle* above it, you can click the triangle to reset the knob to this *default* 12 o'clock position. Knobs are the prime controllers to interactively tweak the sound of your patch. When you want to tweak a knob from the front panel while playing, assign it to one of the assignable panel knobs.



SLIDERS

A slider basically has the same functionality as a knob - only a different appearance. Just think of sliders as the faders commonly used on mixing desks. Sliders can also be found on some of the Sequencer modules.



DROP-DOWN SELECTORS

Some modules feature drop-down selectors, which are similar to drop-down menu's in a computer program. With a drop-down selector you select between functions (oscillator waveforms for example) by selecting the option from the drop-down list. The advantage of using these drop-down selectors in a module is that the module uses less Patch Load compared to a module with radio buttons. However, changing function with these drop-



down selectors will force the Sound engine to recalculate the patch and thus cause a brief moment of silence.

Drop-down selectors are distinguished by a vertical rectangular button with a small black triangle on it. When you click and hold this type of selector, a drop-down list with various alternatives is shown. Some drop-down selectors also feature a graph to display the current selection (a waveform, for example). The advantage of using drop-down selectors compared to radio button selectors in a module is that the module *replaces* the function rather than switches between functions. This makes modules with drop-down selectors use less Patch Load than radio button modules, e.g. compare the Patch Load of the OscShpA and the OscShpB modules. However, when you change these types of drop-down parameters, it will force the Sound engine to recalculate the Patches in all active Slots and thus cause a brief moment of silence.

Note that drop-down selectors CANNOT be assigned to a KNOB, MORPH GROUP or MIDI CONTROLLER, and they can ONLY be set to a new setting in the Editor program.

Also, modules with drop-down selectors can have *only one selection for all Variations* in a Patch.

SCROLL BUTTONS

Some buttons look like regular “single” buttons. However, they have *more* than two states! These buttons are called scroll buttons since you “scroll” through the different states. The different states are selected by clicking the button repeatedly. An example of a scroll button is the ‘Semi/Partial/Frequency/Factor’ scroll button on the Oscillator modules. When you click on a scroll button you activate the *next function in line*. When you click again the following function is activated and so on. An example of a scroll button is the Attack/Decay Shape button of the ADSR Envelope module.

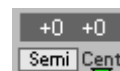

NAME BUTTONS

Several modules are equipped with buttons that allow you to *change their caption text*. If these buttons are associated with a knob (e.g. the Mix4-1C module) and the knob is assigned to an assignable knob on the **G2** panel, the button is automatically assigned to the panel push-button under the panel knob as well. Additionally the caption text shows up in the panel display that belongs to the panel knob. These buttons are a powerful way to create your own user interface for your patch. If the button is on a mixer module you can type the name of the sound that is controlled by this mixer knob, e.g. ‘HiHat’ or ‘Kick’ in a drumkit patch. This will make it much easier to work with the **G2** on stage. Caption texts can be changed by right clicking on the button and choosing ‘Edit name’ in the pop-up menu.



The Name buttons not only show these names in the panel display but also act as *mute* buttons. Another module that can be used to make your own ‘patch to panel’ interface is the ConstSwT or Constant Switch Toggling module from the Level Module Group selector (third one from the left in the Level Module Group). This module produces a level on its output that can



be connected to a modulation input on another module. By assigning the module knob to a **G2** panel knob and putting your own text on the Name button you have a convenient way of naming a parameter any way you like, as long as the new name fits in seven characters.

Name buttons can be *toggling* or *momentary* push buttons. If there is an arrow next to a Name button it is a momentary push button that is ON as long as you keep the Name button pressed and goes OFF as soon as the button is released. Modules that have a momentary Name button have a capital M in their name,

like ConstSwM. When there is *no arrow* the Name button will *toggle* between ON and OFF when repeatedly pressing the name button.

MODULATION

The method of controlling one function in a module with another function is named *to modulate*. When you play on a keyboard and the oscillator changes its pitch when you wiggle the Pitchstick controller, you are manually modulating the pitch with the Pitchstick. Modulating can be done automatically (as opposed to manually) by means of varying control signals. A good example is when an envelope sweeps a filter when a key is pressed. Logic signals from the keys tell the envelope to start modulating the cut-off frequency of the filter. Modulation can be positive or negative, e.g. the cut-off frequency of a filter can increase with positive modulation and decrease with negative modulation or vice versa. As you will see, there are some modules in Nord Modular **G2** that can change the polarity of a modulator signal. Some modules can be set to send either bipolar or unipolar control signals, like the Envelope, LFO and Constant modules or the Control Sequencer module.

MODULATION INPUTS

A module parameter that can be modulated through a control signal must have a modulation input where the control signal can be connected to. A modulation input is often combined with a modulation amount knob. For short a modulation input is named a mod-input. The modulation amount knob attenuates the incoming signal to the wanted modulation depth. The mod-inputs can be red, like the Sync, FM and Shape inputs of the OscillatorB module, which means they are capable of handling signals at full audio bandwidth. Alternatively mod-inputs can be blue, like the Vowel modulation input of the Voice Filter module, working at 1/4 audio bandwidth. The modulation inputs can also be self-optimizing, like the Pitch inputs of the Oscillator B module, meaning that they adapt their bandwidth to the incoming modulation signal bandwidth. This is indicated by the inputs changing color.

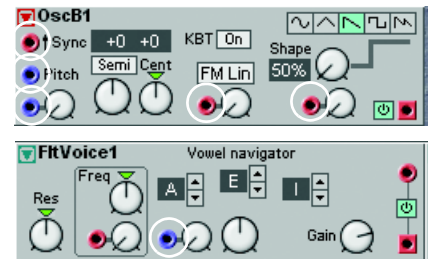

MOD-AMOUNT KNOBS (ATTENUATORS)

There are three different response behaviors for the mod-amount knobs next to the modulation inputs: *linear* [Type I], *exponential/dB* [Type II] and *amplified linear* [Type III]. The different response type(s) will be indicated for each module in the module reference section starting on [page 155](#).

TYPE I

The mod-amount knobs attenuates the incoming signal in a linear fashion. A setting of 100 (maximum) leaves the incoming signal unaffected, a setting of 50 attenuates the incoming signal by a factor 0.5 (leaving half of the level of the incoming signal to modulate). A setting of 0 shuts off the modulation completely. Oscillator pulse width modulation is an example of Type I attenuation. When mod-amount knobs have a *value display* consider the displayed value as a *percentage*.

TYPE II

The mod-amount knob attenuates the incoming signal in an exponential fashion. A setting of 100 (maximum) leaves the incoming signal unaffected, a setting of 50 attenuates the incoming signal by a factor considerably less than 0.5 (leaving less than half of the level of the incoming signal to modulate). A setting of 0 shuts off the modulation completely. The pitch mod-input on the various oscillators and the 'dB' attenuation alternative in the Mixer modules are examples of Type II attenuation. Note that Exp and dB are in fact exactly the same scale, but display differently if the mod-amount knob has a value display.

TYPE III

The mod-amount knob affects the incoming signal in an attenuated and amplified, linear fashion. A setting of 200% (knob position 127 or maximum) amplifies the incoming signal to twice its original level, a setting of 100% (knob position 64) leaves the incoming signal unaffected and a setting of 50% (Knob position 32) attenuates the incoming signal by a factor of 0.5 (leaving half of the level of the incoming signal to modulate). A setting of 0 shuts off the modulation completely. The frequency mod-input on the various filters are the sole examples of Type III attenuation.

*Signal attenuation/
amplification factor*

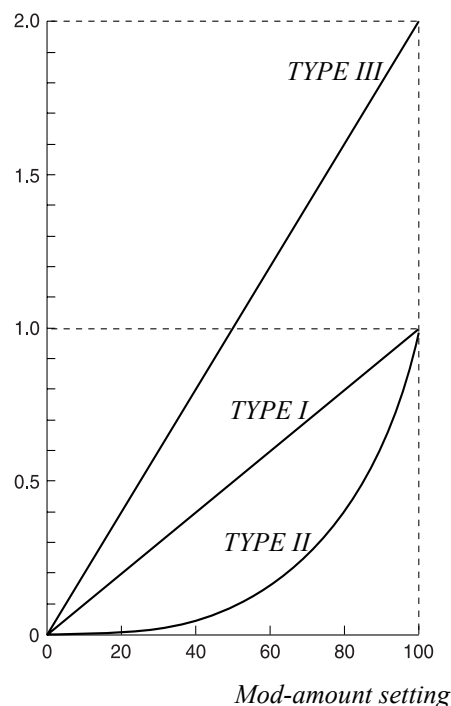

KNOB POSITIONS

To be compatible with the MIDI standard all knobs have 128 physical knob positions. When a knob is tweaked in the Editor a temporary yellow popup will display the knob value plus the actual knob position in parenthesis. The knob position numbers in parenthesis are also the numbers send by MIDI to and from other MIDI devices. After recording a knob movement through a MIDI CC# in a MIDI-sequencer program on a computer the *sequencer data* will show the *knob positions*, and not the values displayed at the top of the

pop ups or in value displays on the module. The reason is that MIDI only knows how to handle knob positions. Make note that knob positions do not show up in the **G2** panel displays.

MODULATION EXAMPLES

PULSE WIDTH MODULATION

As an example the Pulsewidth of the Pulse waveform on the OscDual module will be modulated according to two scenarios:

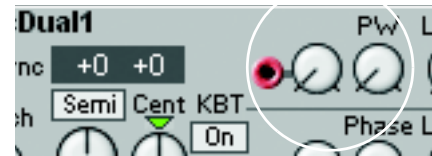

1. If you want to modulate the pulse width from the minimum value (1%) to the maximum value (99%) with a *positive envelope* (that produces a control signal with a peak to peak level swing from 0 units to +64 units), set the initial pulse width (PW) to 50% at PW knob position 0 and the mod-amount to 100 at knob position 127.
2. If you want to modulate the pulse width from an exact square wave value (50%) to a very thin pulse at the maximum value (99%) with a *bipolar LFO waveform* (a control signal with a peak to peak level swing from -64 units to +64 units), set the initial pulse width (PW) to 75% at PW knob position 64 and the mod-amount to 50, also at knob position 64.

Note: Increasing the setting of the mod-amount on this PW mod-input can force the pulse-width beyond the limits (1% – 99%), resulting in the signal being “mirrored”. This is not common on all mod-inputs, some will exhibit this behaviour, while other mod-inputs will not allow a modulation signal to exceed the limits of modulation. It depends on what is modulated and if mirroring is sensible.

It is the difference between the total amount of modulation from an envelope (unipolar, 64 units) and from an LFO (bipolar, -64 to + 64 units = 128 units) that explains why the first scenario has the mod-amount set to 100, and the second scenario the mod-amount set to 50 for maximum modulation.

PITCH MODULATION

A signal routed to a Pitch input on a module affects the pitch by modulating it on the note scale (see figure to the right below)



The figure to the right shows an A4 note being pitch modulated by a symmetric bipolar signal. The modulation sweeps the pitch up and down by one octave around the A4 note. If a lower or higher note is played the sweep will still be over one octave.

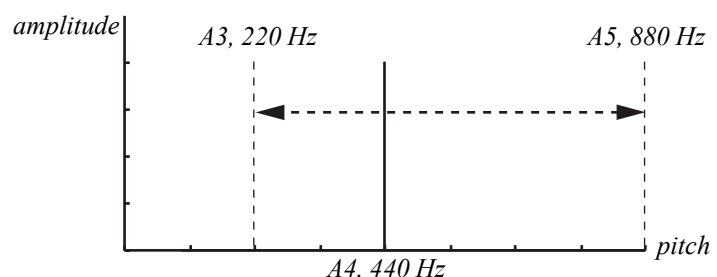

FREQUENCY MODULATION (FM)

A signal routed to an FM input on a module affects the pitch by modulating it linearly in the frequency scale (see figure to the right below).

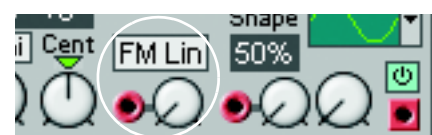

The figure shows an A4 note being pitch modulated by a symmetric bipolar signal. FM Lin modulation will sweep the frequency by a fixed number of Hertz, on either side of the basic pitch, in the example by 300 Hz. If another note is played the sweep will still be 300 Hz, but to our ears the sweep will be larger for lower notes and smaller for higher notes. The new note will most probably sound inharmonic and severely out of tune. Still, FM Lin can be a powerful synthesis technique when the relation between the modulated pitch and the signal modulating the pitch are under tight control.

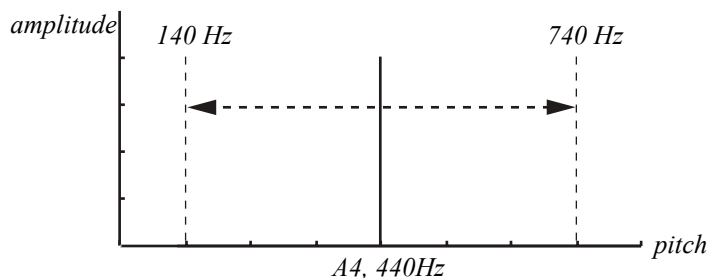

OSCILLATOR SYNC

A waveform of an oscillator with a Sync input can be synchronized with a signal of another oscillator. A Sync modulation input is in a way very similar to a yellow Trigger or Rst input. Oscillator synchronization forces an oscillator module to restart its waveform at the pitch of the audio signal connected to the Sync input. Each time the modulating audio signal at the Sync input goes from a value of zero or below to any value greater than zero, the oscillator waveform will restart at either its own zero crossing point or at a flank in the waveform. The result is that the

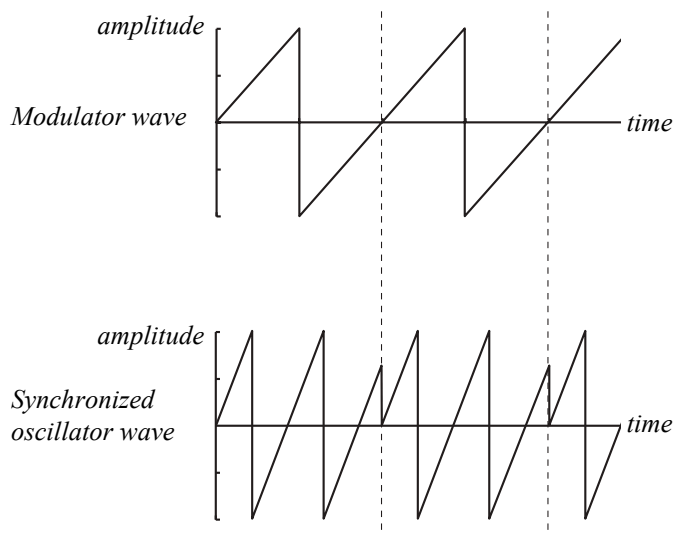

synced oscillator will inherit the pitch of the audio signal connected to the Sync input, which results in a complex waveform that depends both on the oscillator pitch setting and on the modulator pitch. When sync is used, the oscillator pitch is locked to the modulator pitch. If you change the modulator pitch, you will affect the overall pitch, and if you change the oscillator pitch, this will create changes in timbre rather than in pitch.

If you let the synchronized oscillator pitch vary continuously, from an LFO or other modulator, you will change the timbre of the wave in a very interesting and characteristic way.

MAXIMUM MODULATION

For most modules the maximum amount of modulation that a mod-input will accept is +/-64 units from the initial setting of the parameter. There are some exceptions, like the Filter Pitch modulation inputs which will actually accept +/-128 units of modulation. The FM Lin, FM Trk and Phase Mod inputs accept all values within the signal headroom of the G2 system. And there are modules that modulate between two 'limit' values, like the Pan mixer where 'left' and 'right' are the Panner limits. In this last case modulation can not exceed the two limits.

The final modulation depth on a module is the sum of all modulation signals appearing at the modulation inputs, taking all mod-input attenuation knobs in account before the sum is calculated.

Modulation depth on the G2 can in general be very deep from a musical point of view, the G2 is capable of much deeper modulation than was possible on the analog modular systems of the past.

Let us use the OscA module as an example: there are two pitch modulation inputs and the KBT (KeyBoard Tracking) function. The total modulation amount of these three inputs can not be greater than ± 64 semitones. If you turn the coarse tuning down to e.g. E0, add a transpose value of +64 with a Constant module to the first pitch-mod input, you will reach a point, when playing on the keyboard, where the pitch of the oscillator will be fixed. Any additional, positive modulation will have no effect, which could lead to interesting effects. For example, an LFO would be able to modulate the pitch of the oscillator downwards, but not upwards.

MODULATION LEVEL KNOB NAMES

The knobs that set the modulation level for a modulation input will always be shown in displays as the name for the parameter plus a capital M after the name. E.g for a Freq input the modulation level knob will be named 'Freq M' in the G2 displays. This way you can easily identify modulation level knobs from parameter knobs.

6. WORKING IN THE EDITOR

SOUND SYNTHESIS ON THE G2

Modular synthesis is probably the most powerful way to synthesize sounds. There are many different synthesis techniques possible on the **G2** system, much more than can be described in this manual. To help you on your way there is a chapter after the Module Reference section that describes in short the most common techniques. But note that this chapter will only scratch the surface of what is possible on the **G2**.

There is an active community of modular synthesizer users on the Internet, including a mailing list and a forum dedicated solely to the **G2** system. This **G2** mailing list and forum are maintained by **G2** users themselves and it is up to you if you want to join them. But there is so much valuable information shared over there that we from Clavia wholeheartedly recommend you to at least check them out. You can find links on the Clavia website at <http://www.clavia.se>. On the Clavia website you will also find links on the “**G2** Tips and Tricks” pages to workshops and tutorials, and some go way deep into sound synthesis and audio processing techniques.

CREATE A NEW EMPTY PATCH WINDOW

Create a new Patch by selecting File | New. This opens up a new, empty Patch window in the Editor and clears the selected **SLOT** in Nord Modular **G2**. Alternatively press the [New] button in the Toolbar.

ADD MODULES TO A PATCH

The modules are grouped together in module groups. You access these groups by clicking the Module Group selectors in the toolbar located above the Patch window.

The various modules in each group are distinguished by icons

Select a Module Group, click-hold on a

module icon and drag it to the Patch window. When you place the cursor over any of the module buttons, a preview image of the module appears. Drag the “phantom frame” of the selected module to the Patch window. The other modules will move, if necessary, when you drop a new one. The modules will automatically snap to a grid in the Patch window. If you like you could also double-click a module icon to automatically add it to the Patch window below the currently focused module. The Patch window will expand when needed and scroll-bars will appear at the bottom and to the right if the Patch window becomes larger than the available screen area. As you add modules to the Patch window, the Patch Load indicator(s) on the toolbar will expand, indicating the use of the Sound engines. Maximum Patch Load is 100% per Patch Area.

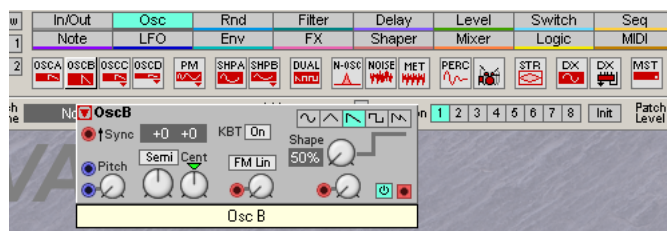

Another way of adding modules to the Patch is by right-clicking on the background of the Patch window and selecting 'Insert'. A popup of the module groups appears. Select a desired module by selecting it from the popup. The cursor gets a plus sign next to it. Place the cursor where you want the module to be placed and click to drop the module.

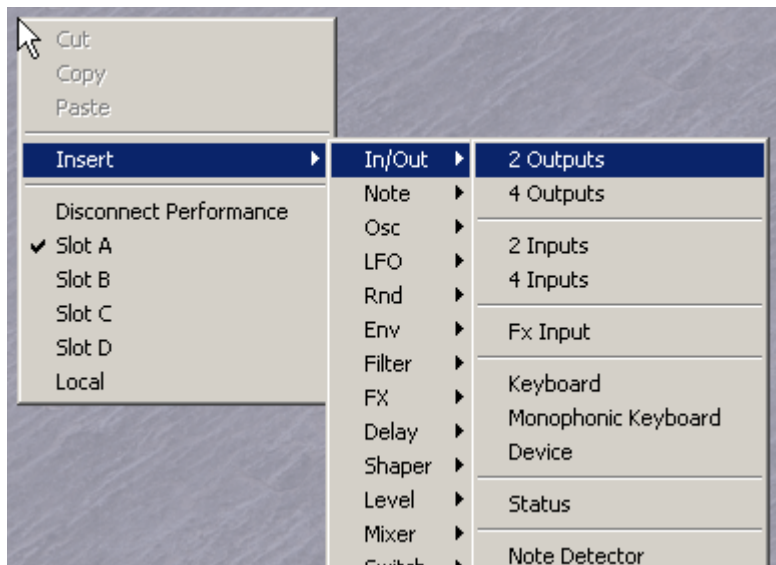

RENAME A MODULE

Double-click on the name of the module to rename it. You can also right-click on the gray background of the module and select Rename. Type in the new name and press Enter on the computer keyboard. This is the name which will be shown in an **ASSIGNABLE DISPLAY** if you later assign any of the module's parameters to an **ASSIGNABLE KNOB** on the synth front panel.

MOVE A MODULE

You can move the modules in the Patch window by click-holding on the module grey background and move the frame that appears. Any connected cables will extend themselves and other modules will move out of the way automatically. You can also move several modules at the same time by placing the cursor on the Patch window background and click-hold and mark the modules you want to move. Another way of selecting several modules is to Shift-click on the desired modules. The names of the selected modules are highlighted to indicate that they have been selected.

DELETE A MODULE

To delete a module from a Patch, either click on the module and press Delete on the computer keyboard or select Clear from the Edit menu. Alternatively, right-click on a module's background and select Delete from the popup. Note that all cable connections made to the module will also be deleted or rerouted. You can also delete several modules by selecting them as described in the example above. Then, either press the Delete key, select Clear from the Edit menu or right-click on one of the selected modules and choose Delete from the popup.

REPLACE A MODULE

There is an intelligent module replace function in the Editor. To replace a module with another module of the same module group, click the arrow button to the left of the module name. A popup appears with the names of the other modules in the group. Click on one of the modules in the popup. Now, the selected module will replace the current one - with all cable connections preserved (if possible)! This function

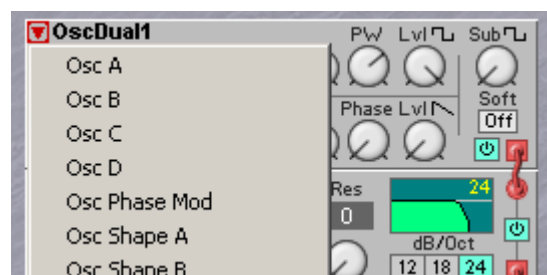

saves a lot of time if you, for example, need a Mixer with more inputs or an Oscillator or Envelope generator with more/different functions. Note that the “replacement module pop-ups” doesn’t always feature exactly the same modules as the module groups in the Toolbar.

COLORING A MODULE

To distinguish a module, or a group of modules, from other modules in a Patch, it’s possible to paint modules with different colors. Select a color from the Color selector in the Toolbar. Any new modules you add to the Patch window will now get the selected color. You can also focus any modules in the Patch window by Shift-clicking them and then clicking on the “paint bucket” icon to apply the selected color to the module(s) or select another color from the drop-down palette.

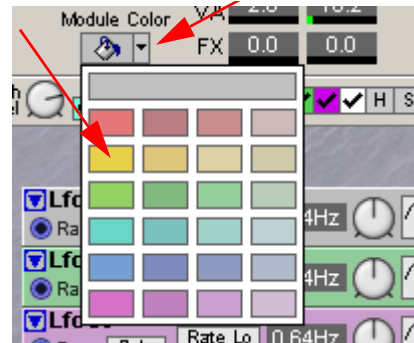

CONNECTING MODULES

CONNECTING CABLES IN A PATCH

Place the cursor on a module connector and click-hold. The cursor will change to a plug. Drag the cursor to a suitable connection elsewhere in the Patch. As you drag the cursor away from the source connector, a line will appear between the cursor and the connector. When you reach the destination connector, the cursor will change to a cable with a white dot instead of a plug. As you release the mouse button, a cable will appear between the two connections. The color of the output connection will determine the color of the resulting cable. You can later change the cable color if you like.



It is also possible to connect cables between connectors of different colors, e.g. connect an audio signal output to a control signal input etc. This depends on the actual application. If a connection is not possible to make, this will be shown; the cursor will not change to a cable with a dot as you reach the “illegal” destination connector. It is not possible to damage the system in any way by connecting “wrong” - feel free to experiment!

You can connect one output to several inputs to make a parallel connection.



You can also make a serial connection, from input to input. The result is exactly the same as in a branch connection. If a module within a serial cable chain is removed, the remains of the cable chain will be re-routed.



It is also possible to make a serial connection between several inputs, without connecting to an output. This won’t result in any signal flow, but can be useful if you want to choose an output after having connected all inputs. These “non-functional” input-to-input connections are indicated by white cable color. When you connect such a chain to an output, the cable color will change to the output’s color. It is also possible to combine parallel and serial connections in several ways. For example, you could have a serial connection branch off to a parallel connection anywhere in the chain.

Summary of the connection possibilities that the editor will allow or refuse:

- An output can be connected to one or more inputs

An input can be connected to only one output and optionally share that output with other inputs
 Two outputs can never be connected to each other
 Several inputs can be connected to each other, but they must be connected to one single output to actually receive a signal

HIGHLIGHT CABLES AND CABLE CHAINS

To make it easy to follow cable connections and signal paths visually in the Patch, click-holding a connector will highlight any connected cables or cable chains. The highlighted cable(s) turns light blue for as long as you hold the mouse button.

DISCONNECT OR RE-ROUTE CABLES IN A PATCH

To remove a cable, right-click on a connection (input or output) and select Disconnect, or double-click-hold or Ctrl-click on a connection (an extra wire appears next to the connector cursor) and “pull out” the connector by dragging the connector symbol away from the input/output and release the mouse button. If you place the “disconnected” plug on another connection instead, the cable will be rerouted.

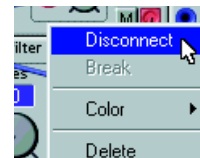

right-click

OR

*Double-click/
Ctrl-click*



EDIT MODULE PARAMETERS IN A PATCH

PUT A MODULE PARAMETER “IN FOCUS”

A parameter can be a knob, slider or a selector switch (button). Put a parameter “in focus” by clicking on it. An increment and decrement button appears below the knob or slider parameter as you move the cursor over it, and the current setting of the parameter displays briefly in a yellow hintbox. When you click on the parameter, the increment/decrement buttons (or button selectors) are highlighted.

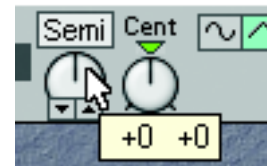

To move the focus to another parameter in the module, press the Left/Right arrow buttons on the computer keyboard.

To move the focus to another module in the Patch, press the Shift key on the computer keyboard together with the Up/Down/Left/Right arrow buttons. The modules in a Patch are accessed depending on how they were visually placed in the Patch window.

EDITING A MODULE PARAMETER

You can edit the parameters with the mouse. Place the cursor over a knob, click-hold it (put it in focus) and then move the mouse. The knobs have no end stops; you may jump from maximum to minimum by turning past the 6 o'clock position (if Knob control is set to 'Circular' in the Setup | Options dialog box). When a knob is in focus, two small buttons will appear beneath the knob. Clicking on the 'up' button will increase the value one step for each click and clicking the 'down' button will decrease. You can also use the computer keyboard's Up/Down arrow keys to increase and decrease the focused parameter value. Click on a button to select e.g. a waveform button of an oscillator. The selected button will be "depressed".

*Editing a knob**Editing a button***VOICE AREA AND FX AREA**

A Nord Modular G2 Patch consists of two Area's: a polyphonic Area and a monophonic Area. In the Editor, these two parts are represented by two sections of the Patch window, divided by a horizontal split bar. The upper section is called the Voice Area and the lower section the FX Area. In the Voice Area you place modules that should be duplicated for each voice, e.g. oscillators, envelope generators and filters. In the lower Patch window, the FX Area, you can place modules that should act equally on all voices in the Patch, e.g. different types of FX modules. Modules used in the FX Area will act on the sum of the signals output from the Voice Area, and consequently will not be duplicated for each voice in the Patch. This gives two big advantages:

- A module in the FX Area is able to process whole chords from the Voice Area, and not just a single voice, affecting the sound the same way an external audio processor would.
- In most situations you will be able to free up Sound engine power (Patch Load) so you could increase the polyphony of the Patch. E.g. you don't need a separate Reverb in each voice, all voices can share one Reverb module in the FX Area. This works for many audio Effects modules like the Vocoder, Echo Delay-lines, Chorusing, Phasing, Flanging, Pitch Shifting, etc. Still, on the G2 system you can use all these effects separately in each voice if you want.

Cables cannot be connected from modules in one Patch Area to modules in the other. However, you can route four separate audio signals from the Voice Area to the FX Area by using the FX In module. The routing is one-way only; from the Voice Area to the FX Area. You can also use the four global audio Bus channels to route audio signals to and from both Patch Areas of all Slots. The global audio Bus routing is "bidirectional"

EXAMPLE OF A PATCH THAT USES BOTH THE POLY AND FX AREAS

This example shows a Patch where both the Poly and FX Areas are used:

The '2-Out1' module in the Voice Area is set to route the signal to FX In 1/2, the Left and Right output of the 'FX In1' module in the FX Area. The sum of all voices from the Voice Area is sent to the FX Area to be processed in the 'Reverb1' module and output at **OUT1** and **OUT2** jack of the synthesizer.

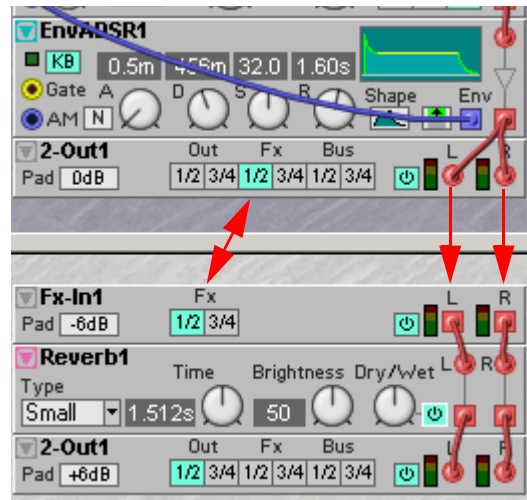
**DOWNLOAD A PATCH TO THE SYNTHESIZER**

If you have opened a couple of Patches in the Editor while the synth wasn't connected and you want to download one of the Patches from the Editor to the synth, do either of the following:

1. Right-click on the Patch window background and select a Slot from the bottom of the popup. This will download your Editor Patch, overwriting the Patch that is currently in the destination Slot.

OR:

2. Select Patch | Download To Slot and select Slot in the dialog box that appears.

STORE A PATCH

A Patch can be stored in two different locations: in the internal memory of the synthesizer, and/or on disk on the computer. The examples below describes three different ways of saving/storing a Patch.

1. Save a Patch only on the computer by selecting File | Save. File | Save As will let you rename and/or relocate the Patch before saving to disk. File | Save All will save all open Editor Patches to their original locations.
2. Store a Patch in one of the Nord Modular **G2** internal memory locations by pressing the **STORE** button on the front panel once. The **LED** above the **STORE** button will flash. Select a bank (1-32) with the **UP/DOWN NAVIGATOR** buttons and a memory location (1-128) with the **ROTARY DIAL**. Confirm by pressing **STORE** again. Abort by pressing any other button.
3. To store a Patch in the Nord Modular **G2** internal memory from the Editor, select Synth | Save In Synth. Select a memory location and a bank from the Drop-down lists and click 'Save'. **Note that the original Patch in the selected memory location (if any) will be overwritten by your new Patch. Make sure you do not overwrite Patches you want to keep!**

There is a memory protect function to minimize the risk of accidentally overwriting Patches. Read more about the internal memory protection in the section "[Memory Prot |Sy](#)" on page 32.

SELECTING SOUND CATEGORY FOR THE PATCH

To make it easier to define different types of sounds in the synth’s memory it’s possible to specify a Sound Category for each Patch. There are 13+2 different categories to choose from. Select Category from the drop-down list to the right of the Patch Name display box in the Toolbar:



Select Category from the drop-down list to the right of the Patch Name display box in the Toolbar:

CATEGORY	DESCRIPTION
Acoustic	Patches with an acoustic character like flutes, violins, guitars, ethnic sounds, bells, mallets etc. Doesn’t necessarily have to be emulations of existing instruments
Sequencer	Sounds which use sequencer modules to produce melodic and/or rhythmic lines.
Bass	All sorts of bass sounds
Classic	Traditional “clean” analog types of polyphonic synth sounds based on the classic waveforms
Drum	Drum and percussion sounds
Fantasy	Melodic effects sounds and textures, often with rhythmic modulations
FX	Atonal effects sounds like water, laser guns, explosions etc. Sometimes with heavy modulations.
Lead	Sounds meant for lead lines. Usually monophonic sounds.
Organ	Different types of organ sounds
Pad	Melodic polyphonic ‘chord’ sounds with fairly slow attacks like strings, choirs etc.
Piano	Different types of electric and acoustic piano emulations
Synth	All sorts of melodic polyphonic synth sounds
AUDIO IN	All sorts of Patches that make use of the Audio Ins of the synth.
User1	Reserved for your own Sound Category
User2	Reserved for your own Sound Category

ABOUT THE NORD MODULAR G2 INTERNAL MEMORY

As mentioned above, the Nord Modular **G2** internal memory is divided into 32 banks with 128 memory locations each. However, it’s not possible to fit in 4096 (32x128) Patches at the same time in the Nord Modular **G2** memory due to the total size of the Patches. Considering that an average Patch uses around 5 kB memory, this means you’ll be able to fit in approximately 1200 Patches. If you also have stored Performances, the number of Patches will be less. The reason the **G2** has this many Banks and memory locations is that it makes it easier to manage your Patches. For example, you could have all your Patches for a certain song or project in a separate Bank.

The dynamic structure of the internal memory makes it suitable to consider it a storage device similar to a computer hard disk, with banks representing folders and Patches representing files.

When you want to store a Patch in a memory location that doesn't contain any Patch, this is indicated in the **MAIN DISPLAY** as shown:

Store to 2:24
Empty Patch

If you should run out of internal memory when trying to store a Patch, this will be indicated by the following message in the **DISPLAY**: You will then have to delete one or several Patches to make room for new ones. This can be done using the Tools | Patch Browser window (see below).

Patch Name
Memory Full

DELETE A PATCH

To delete a Patch from the internal memory of the synth you have to use the Patch Browser. Select Tools | Patch Browser and click the Patch tab to display the Patches of the internal memory of the synth. Right-click on a Patch icon and select 'Delete'.

CREATING PATCH PARAMETER VARIATIONS

First of all, you need to create or open a Patch to be able to create Patch parameter Variations. Let's use the Patch we created in the 'Getting Started' chapter:



Locate the row of Variation buttons to the right of the Voice Mode arrow buttons at the top of the Patch window. As you can see, the Variation 1 button is already focused. This is because as soon as you create a Patch, you have automatically also created a Variation within that Patch. This Variation contains the parameter data for the Patch. Now, to create more Variations, do like this:

1. Click on the Variation 2 button at the top of the Patch window. The Variation 2 button is focused to indicate it's the currently active Variation in the Patch



On the synth front panel, the **VARIATION 2 LED** lights up to indicate it's the focused Variation.

2. Change the settings on a couple of parameters in the Patch. **Note!** Modules that have a drop-down selector, for example Oscillator C and LFO B, can only have one waveform for all eight Variations. This is because when changing waveform in these types of modules, the Sound engine has to recalculate the whole Patch the same way as if you replaced the entire module. If you want to have different Oscillator or LFO waveforms in different Variations, use modules with radio button selectors instead, e.g. Oscillator A and B and LFO A.



3. Click the Variation 1 button to focus Variation 1 again. On the synth front panel, the **VARIATION 1 LED** lights steadily to indicate it's now in focus. As you can see, the parameters you changed in Variation 2 now get their Variation 1 values again. You have now created two Variations in the Patch.

If you want to have more Variations in your Patch, click another Variation button and change parameter settings. Each Patch contains eight different Variations. When you save your Patch (on your computer or in the synth), all Variations will automatically be saved within the Patch.

SAVE A VARIATION

All Variations are automatically saved when you save the Patch. You can't save Variations as separate files.

COPY A VARIATION

To copy the parameter settings in one Variation to another in the Patch, right-click the Variation button and select the destination Variation from the pop-up window.

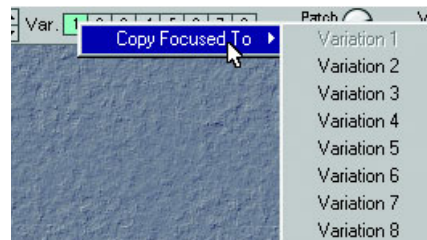

VARIATION INIT

The last selection in the Copy pop-up window described above is the 'Var Init'. Here you can paste parameter values of a selected Variation to be used as a "default" parameter setup for your Patch. This parameter setup can then be recalled for any Variation by pressing the Init button to the right of the Variation buttons.

MIDI CONTROL OF VARIATIONS

The Variation buttons transmit and respond to MIDI Controller #70.

KNOBS AND CONTROLLERS

The 8 **ASSIGNABLE KNOBS** and 8 **ASSIGNABLE BUTTONS** on the front panel of Nord Modular **G2** can be used to tweak parameters in real-time. The **ASSIGNABLE KNOBS** and **BUTTONS** and controllers can be assigned to almost any parameter in a Nord Modular **G2** Patch. You have direct access to 5 x 3 pages with 8 assignable controllers each for a total of 120 assignable parameters per Patch.

THE PARAMETER PAGES WINDOW

The Parameter Pages window is the graphical representation in the Editor of the **PARAMETER PAGES** with **ASSIGNABLE KNOBS** of the Nord Modular **G2** front panel. The Parameter Pages window gives you both visual indication and the possibility to edit the parameters currently assigned to an **ASSIGNABLE KNOB/BUTTON**. The module name and its current value in the corresponding Parameter Pages display box indicates that the knob/button is assigned to a module parameter.

When you edit a knob in the Parameter Pages window, by click-holding and turning the knob, the corresponding module parameter in the Patch window will be focused and change too. The value of the **ASSIGNABLE KNOB/BUTTON** on the Nord Modular **G2** front panel will also change. If you turn an assigned **ASSIGNABLE KNOB** on the front panel, the knob in the Parameter Pages window and the corresponding module parameter will change, also visually.

Bring up the Parameter Pages window by selecting Parameter Pages from the Tools

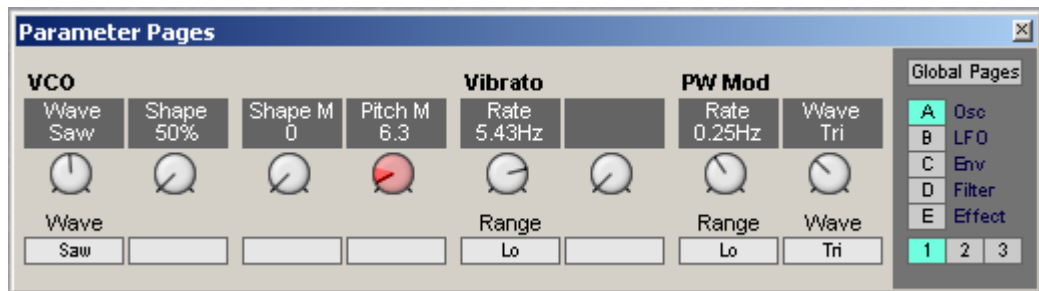

menu or use **CTRL-F**. The Parameter Pages window is a floating window, meaning it can be positioned “on top” anywhere in or outside the application window (as long as the application itself is “on top”).

ASSIGN A PARAMETER TO A KNOB

A parameter can be either a continuous parameter (knob or slider), or a button, radio buttons or scroll button. There are three ways of assigning a parameter to a to an **ASSIGNABLE KNOB**, two in the Editor and one in the synth.

1. Right-click on a parameter in the Editor window, select Assign | Page | Knob from the popup menu and select one of the Knobs in the menu
2. To deassign an **ASSIGNABLE KNOB**, select Disable at the bottom of the popup menu. You can also re-assign an **ASSIGNABLE KNOB** by selecting another (unused) knob in the popup menu.

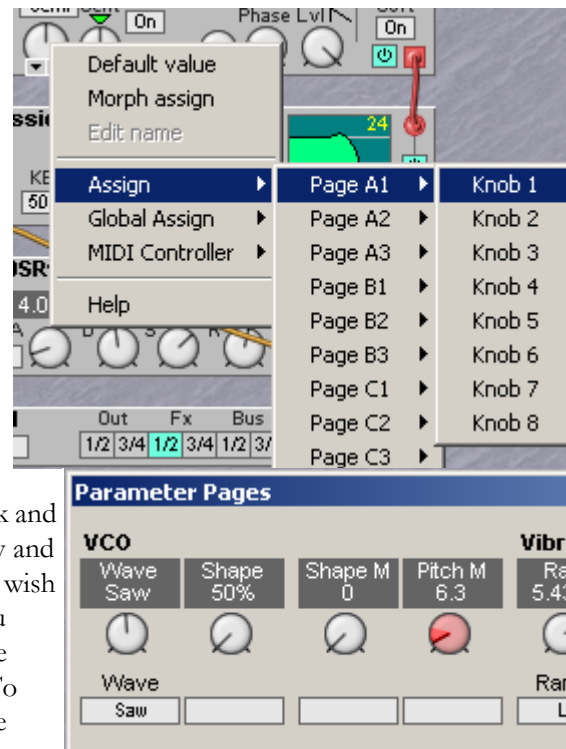

3. The other way of assigning a parameter in the Editor is to use the Parameter Pages window. Click and hold a display box in the Parameter Pages window and then drag the cursor to the module parameter you wish to assign. The arrow gets a + sign next to it as you reach an assignable module parameter. Release the mouse button and the assignment is completed. To deassign, right-click the knob or display box in the Parameter Pages window and select ‘Deassign’

Alternatively you can keep the Alt key pressed and drag a knob from a module to a grey display area on the Parameter Pages window.

See also [“Using Parameter pages to make knob assignments”](#) on page 126

An **ASSIGNABLE KNOB** will always control the entire range of a parameter. If you need to control only a part of the range, use a Morph group instead. The Morph concept is described in [“Morph groups”](#) on page 92.

MOVE ASSIGNED PARAMETERS

By click-holding on a display box and then dragging the cursor to another display box and releasing, you can move the assignment to another **ASSIGNABLE KNOB/BUTTON**. If you want to move a parameter assignment to another **PARAMETER PAGE**, right-click the knob or display box and select ‘Move To’ and select destination. Another way of moving a parameter assignment is to use the Parameter Overview window described on [page 126](#).

USING THE PARAMETER OVERVIEW WINDOW.

Instead of using the parameter pages you can use the Parameter Overview window from the Tools menu. The Parameter Overview gives you a representation of all Parameter pages at once. See “[Using Parameter Overview to make knob assignments](#)” on [page 126](#)

ASSIGN ALL MODULE PARAMETERS TO A SET OF KNOBS

You can easily assign all module parameters to a set of Knobs. This is very useful when assigning Sequencer module parameters, for example. Right-click the module background and select Assign | Page X | Multi Column. This will automatically assign all module parameters to as many Pages as necessary to fit in all parameters. For modules that contain 8 or less parameters, you can select Page and specific Column from this pop-up menu. Alternatively, you can click-hold a Parameter Page button in the Parameter Pages window and drag to a module in the Patch window. Release the mouse button on the module to assign all module parameters.

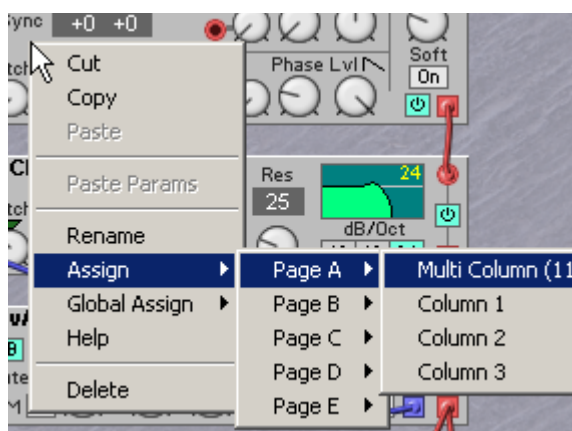

MIDI CONTROLLERS

Almost any parameter in the different modules can be assigned to a MIDI CC#. This is very useful if you want to record parameter adjustments to an external sequencer or if you want to control external MIDI devices from the **ASSIGNABLE KNOBS**. When a parameter is assigned to a MIDI CC#, the parameter will transmit MIDI data when being edited, as well as receive data from external MIDI sources (sequencer, master keyboard, etc.).

Right-click on a module parameter and select MIDI CC# from the parameter popup. Here you can choose either to assign the parameter to *the last received* MIDI CC# or to any of the listed MIDI CC# numbers in the [Assign...] window.

You are free to assign up more than 100 MIDI CC#s to module parameters. Some “predefined” MIDI CC#s like #1 (Modwheel), #0 and #32 (Bank Select) and #64 (Sustain Pedal) cannot be selected from this list. When you edit a parameter that is assigned to a MIDI CC#, it will transmit MIDI CC# data. It does not matter if you edit the parameter from the Editor or on the **G2** synthesizer with the **ROTARY DIAL**.

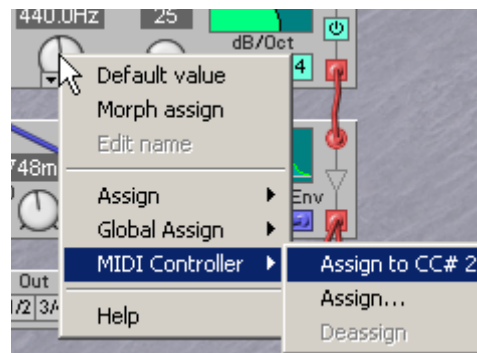

You may also assign a parameter to an **ASSIGNABLE KNOB** as described earlier. In that a case, turning a **KNOB** will result in editing the parameter, which subsequently generates MIDI CC# data. Deassign a parameter from a MIDI CC# by highlighting a controller and clicking Remove in the dialog box.

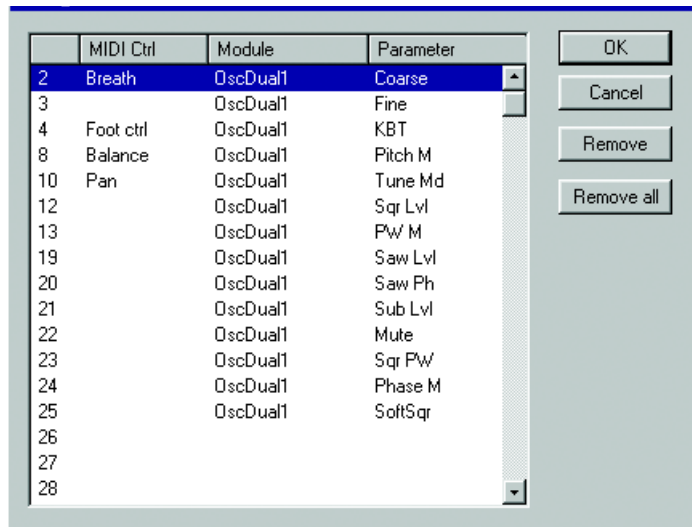

AUTO ASSIGN MIDI CONTROLLERS

It's also possible to automatically assign MIDI CC#s to all parameters of selected modules. Select the modules you want to assign MIDI CC#s to, select Tools | Assign MIDI to Selection. Now, all parameters of the selected modules will be automatically assigned to MIDI CC# numbers. If you want to deassign MIDI CC#s of specific modules, select the modules and choose Tools | Deassign MIDI from Selection.

USING THE ASSIGNABLE KNOBS TO SEND MIDI CONTROLLERS

If you want to use one or several **ASSIGNABLE KNOBS** to exclusively transmit MIDI CC# data to external devices, you will need to take a detour and assign the **ASSIGNABLE KNOBS** to parameters on modules that are not used (connected) in the Patch. Then, assign the parameters to MIDI controllers. Very useful for this purpose is the MIDI Ctrl send module (see [page 256](#)), which does not use any Sound engine resources. You determine which MIDI channel to use directly in this module. Read more about the MIDI modules in “MIDI group” on [page 256](#).

MORPH GROUPS

The Morph function lets you continuously control defined ranges of several parameters in a Patch, using only a single control source. This lets you produce radical changes in a sound in a very fast and easy way. Nord Modular **G2** features eight separate Morph groups per Patch. A parameter can also be assigned to several Morph groups - all Morph groups, actually - and thus be controlled differently from several sources. Also, if you use several Variations in a Patch, the Morph group assignments can be totally different for each Variation.

The Morph groups and their corresponding knobs are located in the Editor toolbar. There are eight Morph groups available in each Patch and you may assign a total of 25 Patch parameters to these Morph groups.



ASSIGN PARAMETERS TO A MORPH GROUP

1. Click on any of the Morph group knobs in the toolbar to select it. The white frame moves to the selected Morph group and the Morph group knob turns red. Then Ctrl-click on the knob, button or slider you wish to assign to the selected Morph group. Alternatively, right-click on the module parameter and select 'Morph assign'. The color of the selected parameter will now change to red to indicate it's been assigned to the selected Morph group.

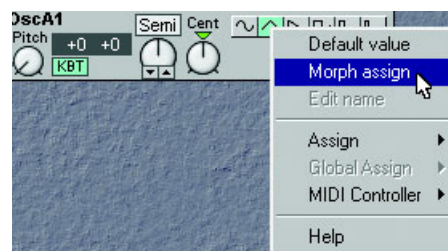

2. Every parameter assigned to a Morph group should also be given a Morph range. Place the cursor on the knob that you assigned to the Morph group. Hold down the Ctrl key and Click-drag the cursor as if you were turning the knob. A red sector will appear, indicating the Morph range. The range will also appear in a yellow hintbox next to the parameter. The initial Morph value is where the black line is on the knob. **Note that if you assign buttons to a Morph group, the Morph range will always be fixed at the maximum range.**



3. Turning the Morph group knob in the toolbar will now control the morphed parameter within the selected range. Note that the morphed knob(s) in the module(s) won't change visually.

4. If you want to assign parameters to another Morph group, click another Morph group knob in the Toolbar and repeat the procedure from step 1. Any parameters assigned to other Morph groups will now turn blue to indicate they are morphed from another source.



You can assign each Morph group knob to any of the predefined controls
MODWHEEL, KEYBOARD VELOCITY, KEYBOARD NOTE VALUES,



AFTERTOUCH, CONTROL PEDAL, SUSTAIN PEDAL, PITCH STICK, G2X GLOBAL WHEELS or to **ASSIGNABLE KNOBS** on the front panel. If you want to assign a Morph group only to an **ASSIGNABLE KNOB** instead of the predefined control source, simply click the Group button below the Morph group knob in the Toolbar. Then, right-click the Morph group knob and select Assign | Page X | Knob. The caption above the Morph knobs can also be renamed by right-clicking and selecting 'Edit name'. You can also assign the Morph group knob to a MIDI controller by right-clicking and selecting MIDI Controller | Assign.

DEASSIGN PARAMETERS FROM A MORPH GROUP

To deassign a parameter from a Morph group, right-click on the parameter and deselect 'Morph assign' in the popup.

To deassign all assigned parameters from a Morph group, right-click on the Morph group knob in the Toolbar and select 'Clear'.

EDIT PARAMETERS IN A MORPH GROUP

The Morph range will always start at the current position of a knob or slider. The relationship between the setting of the parameter and the Morph range will be fixed, even if you move the setting of the parameter after a Morph range has been set.

You can edit the morph range (the size of the sector) by using the mouse in conjunction with the Ctrl key on the computer keyboard. You can also use the computer keyboard Up and Down Arrow keys in conjunction with the Ctrl key to increase and decrease the focused parameter's Morph range.

You can also get a read-out of which Morph group a parameter is assigned to by pressing the F7 function key on the computer keyboard. Pressing the F5 key displays the Morph ranges (start and end values) of the assigned (morphed) parameters.

COPY A MORPH GROUP TO ANOTHER SOURCE

Right-click the Morph group knob in the Toolbar you wish to copy. Select Copy To | Group X. You may also want to delete the original Morph group source afterwards by right-clicking the Morph group knob and selecting 'Clear'.

MORPH GROUPS IN SEPARATE VARIATIONS

Each Variation in a Patch can have its own unique Morph group assignments.

COPY MORPH GROUPS BETWEEN VARIATIONS

Any Morph group assignments are automatically copied when you copy the entire Variation as described in ["Copy a Variation" on page 89](#).

KEYBOARD MORPH AND PITCH STICK MORPH

To read more on how the Keyboard Morph range and the pitch Stick Morph range work, see ["A word about the Keyboard Morph" on page 46](#) and ["A word about the Pitch Stick Morph" on page 47](#).

THE EDITOR AND PERFORMANCES

See ["Playing multitimbrally" on page 18](#) and ["Performances" on page 18](#) for the definition of Performances and why they are used.

PERFORMANCE MODE AND PATCH MODE

One single button on the **G2** Keyboard or **G2X** Front panel allows you to switch between Performance mode and Patch mode. The same button is also available in the Editor program Toolbar to facilitate the **G2** Engine. In practice there is little difference between working in Patch mode or in Performance mode, but Performance mode is basically a way to group everything together and store everything as a grouped unity, so all can be recalled instantly when you need it later.

Note that Patches are stored as copies in a Performance. Which means that if you change the original separate Patches, the copies in the Performance do not change. It is even possible to delete the original separate Patches from the **G2** Patch memory banks, without destroying the Patches in the Performances. To build a Performance you can start in Patch mode, loading and editing Patches and setting global



settings. And by pressing the Performance mode button you will bring everything instantly in Performance mode and you can store the whole setup in a new Performance. Later, while in Performance mode, you can still do all types of edits on the patches in the Slots. So you see, Performance mode is mainly about how to group, store and recall whole setups, which reflects how you organize your work and keep together what belongs together in a song or project.

UPLOADING A PERFORMANCE TO THE EDITOR

When you upload a Performance from the synth to the Editor, you replace the four Patches currently in the Slots A to D with the Patches in the Performance. The name of the Performance will show up in the Toolbar.



1. Click the Prf button in the Toolbar, so the Prf button is highlighted. Alternatively on the **G2** Keyboard or **G2X** model, you can press the Performance button on the front panel. The associated Performance button LED will light up, indicating that the **G2** system is in Performance mode.
2. Open the Patch Browser by selecting Tools | Patch Browser from the menu. The Browser window opens up. Click on the Synth tab to display the Performances of the internal memory in the synth.
3. Double-click on a Performance icon in the Patch Browser to load the Performance in the synth and upload to the Editor. The focused Patch in the Performance is placed on top in the Editor.

CREATING A PERFORMANCE IN THE EDITOR

SELECTING PATCHES FOR THE SLOTS

1. Select File | New Performance
2. Select Patches for the Slots by using the File | Open To | Slot X command. Repeat the procedure for the Slots you want to use.
3. To activate or exclude a Slot from the Performance, Shift-click on the desired Slot button in the Toolbar. To enable or disable Keyboard Assign (which Slots are going to be controlled from the keyboard), Ctrl-click on the desired Slot button(s).

Note! Even if you exclude a Slot from the Performance, any Patches in deselected Slots will still be saved with the Performance. If you want to keep the file size of a Performance down, load any deselected Slots with empty Patches (no modules in the Patch window).

EDITING

This is done just as in Patch (non-Performance) mode. To activate a Slot for editing, simply click the desired Slot button in the Toolbar. The focused Slot is indicated by a white frame surrounding the Slot button. Note that to be able to play the selected Slot, you also need to activate Keyboard Assign for it. Do this by Ctrl-clicking the selected Slot button (a red horizontal bar appears above the Slot button).

KEYBOARD SPLIT (KEYBOARD RANGE)

The Keyboard Split function allows you to define separate keyboard ranges for all Slots in the Performance. It's also possible to have the Slots' keyboard ranges overlapping each other. Activate Keyboard Split as follows:

1. Select Performance | Performance Settings from the menu.
2. Check in the Keyboard Range box. The red LED above the **KB SPLIT** button on the synth front panel lights up to indicate that the keyboard is enabled for split.
3. Type in the keyboard ranges (MIDI Note ranges) for each of the Slots in the Lower and Upper boxes.

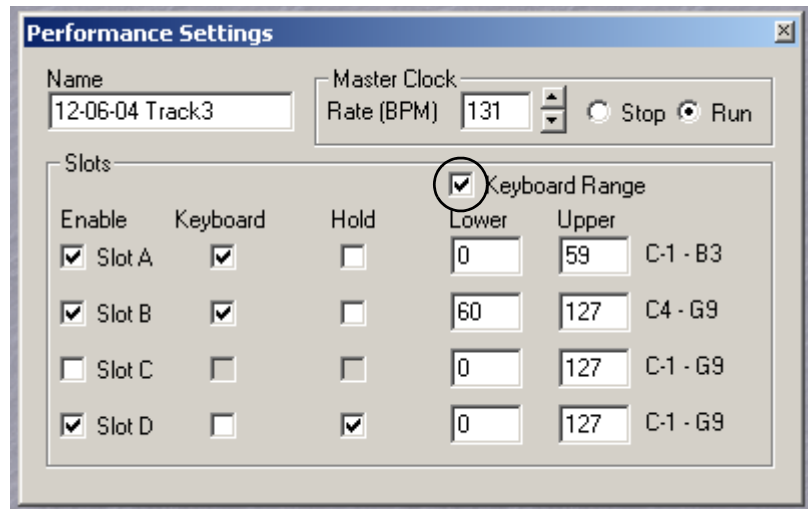

KEYBOARD RANGE AND G2 PANEL SPLIT FUNCTION

On the **G2** Keyboard and the **G2X** models a KB Split mode allows to set up split points quickly from the panel. This KB Split mode sets up the Keyboard range settings, but in a simplified way. The KB Split sets the same left range for Slots A and B, and the same right range for the Slots C and D. Four predefined split points can be chosen and are indicated by four LEDs right above the keyboard. Note that these are just very common cases to set up a simple left and right range Keyboard Split. In the Performance Settings window you can edit and override these splits set by the KB Split function into more complex split and layered configurations. Note that when the split points are not on the positions where the LEDs are above the keyboard the LEDs do not light up any more. The KB Split LED however still lights up. So, if you see the KB Split LED light up but you do not see any of the Split Point LEDs light up you know that there is indeed split points and/or layers set up, but in a more complex user defined setup. To see this setup on the **G2** front panel, press the System button while in Performance mode and scroll through the System menu until you see 'Keyboard Zone' in the display. Now press a Slot button to see or edit the range for that Slot.

COMBINING SPLIT AND LAYER

Layering Slots simply means that you overlap keyboard ranges for the Slots you want to layer.

THE GLOBAL PARAMETER PAGES

Each Patch in a Performance can have its own Parameter assignments, just like in Patch (non-Performance) mode. Additionally, a Performance can have an extra separate setup of 5x3 Parameter Pages with up to 8

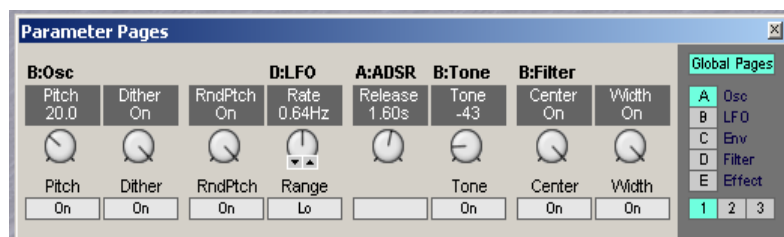

Parameters per page - the Global Parameter Pages. To assign parameters to the Global Parameter Pages, click the Global Pages button in the Tools | Parameter Pages window and assign the parameters as described in “Assign a parameter to a knob” on page 90. When you assign Parameters to the Global Parameter Pages each assignment will be displayed with an initial letter indicating from which Slot the module parameter originates from

STORING A PERFORMANCE

Note! When the Nord Modular G2 is shipped from factory, Memory Protect is set to ‘On’. To be able to store Performances, first disable the Memory Protect function. Select Synth | Synth Settings and uncheck the Memory Protect On box.

STORING IN THE SYNTH

Storing a Performance in the synth from the Editor can be done in two ways. Either, select Synth | Save in Synth from the menu. Then, select memory location and click OK, or:

1. Select Tools | Patch Browser to open the Browser window.
2. Click on the Perf tab to display the Performances in the internal memory of the synth.
3. Right-click on a Bank icon, select ‘Save Current Performance to’ and select a memory location for your Performance.

SAVING ON THE COMPUTER

Select File | Save or Save As... from the menu. If you selected ‘Save As...’, select a folder and press/click OK.

RENAMING SINGLE PATCHES IN PERFORMANCES

It’s also possible to name each of the Patches in a Performance individually. In Performance Mode, simply click on a Slot to focus the Patch. Enter a new Patch name in the Patch display box. Click on another Slot button to put the next Patch in focus. Enter a new Patch name in the Patch display box. When you’re done, store and/or save the Performance as described above.

EXTRACTING PATCHES FROM A PERFORMANCE

The Patches used in the Slots of a Performance are *not* references to Patches in the Patch memory of the synth, but complete Patches “on their own” in the Performance. You will find several unique Patches in the factory Performances; Patches that you will not find in any of the internal Patch memory locations. You may want to extract such a Patch, to use as a single regular Patch, or to make it part of another Performance.

EXTRACT A PATCH AND STORE IT IN THE SYNTH

Click on the Slot button that contains the Patch you want to extract. Click the Prf button in the Toolbar to exit Performance mode. Then, select Synth | Save In Synth. Select Patch memory location and click OK.

EXTRACT A PATCH AND SAVE IT ON THE COMPUTER

Select File | Save From | Slot X. Select folder, rename the Patch if you like, and click OK.

DELETING PERFORMANCES IN THE SYNTH

Do like this to delete a Performance from the internal memory of the synth:

1. Select Tools | Patch Browser to open the Patch Browser window.
2. Click on the Perf tab to display the Performances in the internal memory of the synth.
3. If necessary, double-click a Bank icon. then right-click on a Performance icon and select Delete.

EXITING PERFORMANCE MODE

To exit Performance mode, click the Prf button in the Toolbar, so it is not highlighted any more. Now you return to the regular Patch mode. Note that the four Slots contain the same Patches they had in Performance mode and also that any Layering and Keyboard Range settings remain unchanged. On the front panel of the **G2** Keyboard and **G2X** you can press the Performance button, so the Performance button LED goes off.

7. THE PATCH MUTATOR

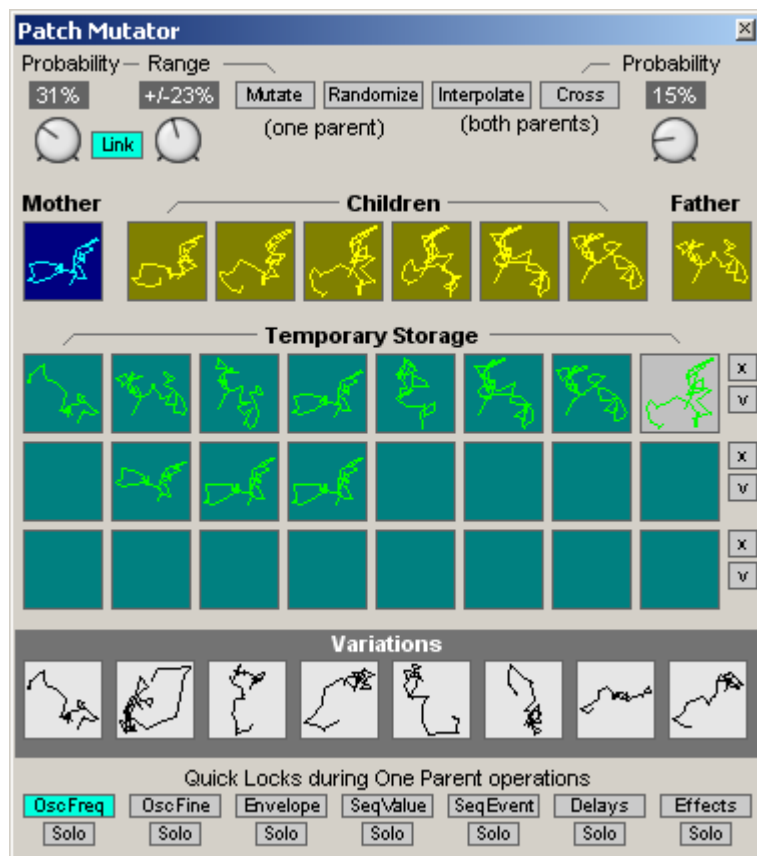

INTRODUCTION

The Patch Mutator is a toolbox for creating new patch variations guided by your ear. It will help you explore different knob settings within a certain patch by simply listening and selecting the sounds you like. Most patches can generate a vast range of different sounds, but it is tedious and difficult to explore them manually, because of the sheer number of parameters in a patch, and because of the difficulty to predict the sonic results. Also, with the extreme flexibility of the Nord Modular G2, it is tempting to always look for new patches, and neglect the fact that one single patch often equates a full hardware synthesizer, with vast possibilities waiting to be explored.

In an interactive process inspired by natural evolution, the Patch Mutator creates a number of variations for you, based on one Mother sound, or based on a Mother and a Father, or more or less random. You listen to these new Children sounds one at a time, and select which one will be the parent of the next generation of children. This process can be repeated any number of generations, until you find the sounds you want. Usually you find lots of interesting sounds in the process.

The Patch Mutator is designed for speed and ease of use, with great care put into the interface design. In a few minutes you can create whole sets of new sounds, or series of interesting variations on existing sounds. The evolutionary approach makes it very different from simple patch randomizers available in

some synthesizer editors. You always work with a “family” of related sounds, comparing and selecting the best from each generation.

At any moment, a Child sound can be saved for future use in a Temporary Storage. Also, any sound from the Temporary Storage can be brought back into the breeding process as a parent. The G2 architecture allows eight variations to be stored with the patch, and any sounds from the temporary storage can easily be transferred to the eight variation buffers, and be saved as a patch in flash memory or on disc.

The main purpose if the Patch Mutator is encourage and simplify creative sound design, but there are many variations on this theme. A few suggestions:

- Quickly modify a sound in a studio situation where you want a specific sound.
- Explore the potential of your patches beyond the default values and your first tweaks.
- Explore other people’s patches without knowing exactly how they are constructed.
- As a composition tool: Create a number of related but different sounds or textures that can later be put together.
- Evolve complex sequences that control other equipment through MIDI.
- Evolve mappings from MIDI controllers to sound engines, to find new and interesting ways of performing.
- Evolve new sounds, loops and textures live, as a way of improvisation.

There are probably as many ways to use it as there are users. Consider it a powerful toolbox at your disposal for sonic exploration guided by your ears.

The Patch Mutator has been developed in collaboration with composer and researcher Palle Dahlstedt, based on his research in computer-aided creativity. Read more about the historical and theoretical background in the end of this chapter.

NOTE! The Patch Mutator will turn the knobs and push the buttons for you, but it will not affect the connections between modules, and it will not add or delete modules.

NOTE! The Patch Mutator only exists in the editor, and is not available in the synth itself. Therefore, it can only be used when the G2 is connected to the computer editor.

THE PATCH MUTATOR WINDOW

The Patch Mutator is a floater in the editor, just like the Virtual Keyboard and the Parameter Pages. It can be opened or closed by selecting Patch Mutator on the Tools menu (Shortcut: Ctrl-2). With the Patch Mutator floater open, you can still edit the patch as usual, add or delete modules or turn the knobs.

The Patch Mutator float consists of five different regions. From top to bottom:

- Various settings and action buttons for the different breeding operations that generate new children: Mutate, Randomize, Interpolate and Cross. See the Patch Mutator Reference section below for a detailed explanation.
- A row of boxes representing the parent and children sounds. Each box contains a “chromosome” graph. The shape of this curvy line is derived from the actual parameter values. The chromosomes show at a glance how different the variations are. In the screenshot above, the children are clearly quite similar, while the sounds in the temporary storage look completely different from each other.
- The Temporary Storage, which serves as a scratch pad during the evolutionary process. You can save sounds you like by dragging them to a box in the storage, and later you can drag them from the storage to one of the parent boxes in the row above, to continue breeding. A row from the Temporary Storage can quickly be transferred to the eight patch variation buffers by clicking on the “v” button to the right of the row. Click the “x” button to clear the row. Right-click and select Delete to clear a box.
- A row of eight boxes representing the eight variation buffers of the G2. Clicking on one of these boxes is the same as pushing a variation button on the G2. The variations can be dragged to the parent boxes or copied to the Temporary Storage.
- A row of Quick Lock buttons that are used to select which parameter categories are temporarily excluded from the random changes caused by the Mutate and Randomize operations. In many cases you want to vary certain parameters, while leaving others unchanged. For example, you may not want to affect the pitch of the oscillators in the patch. Then you uncheck this button, and they will be left unchanged by these operations. By clicking the *solo* button below a category, only one category is affected by the random changes.

USING THE PATCH MUTATOR

The Patch Mutator can be used with all patches, also with any patch from previous OS versions. It works well with most patches straight out-of-the-box, while others may need some slight modifications and tweaking. Experiment with the *Quick Lock* buttons, and you will probably find a way to evolve interesting sounds with most patches. After a while, you will understand how to create patches that are tailor-made for evolutionary exploration.

You may want to exclude certain modules permanently from random changes, for example a part of a patch that has been carefully worked out and should stay as it is.

- To exclude one or more modules from the Patch Mutator operations, select the module(s), right click and check *Exclude From Mutations*.

When the Patch Mutator is visible, excluded modules are indicated by a thin red frame. The *Exclude From Mutations* settings are saved with the patch.

To simplify the use of the Patch Mutator, some modules are excluded by default. Most of these are modules that you probably wouldn’t want to change in a random way, such as output modules,

compressors, MIDI out modules or pitch trackers. If you want, you can include them by simply right-clicking and unchecking the *Exclude From Mutations* option.

QUICK START

The Patch Mutator contains a range of very powerful tools for creating Patch variations, and it can be used in many different ways. Below is a short description of the tools available:

Tool	Description
Mutate	Mutations are small random changes in a sound, similar to the slight reading errors occurring in DNA replication in nature. The changes may be good or bad. You decide. Use this tool to create new variations based on one existing sound.
Randomize	Use this tool to create completely random patch variations. All parameters will get a new random value. Use this tool to find interesting starting points for further exploration.
Interpolate	Use this tool to create a set of variations that gradually progress from one existing sound to another.
Cross	In nature, DNA from two parents is combined in a partially random process called crossover. Basically different segments are copied from each parent and combined. Use this tool to create new variations based on random combinations of two existing sounds.

Try this step-by-step example of how to use the Patch Mutator to get a feel for what it can do. See the Patch Mutator reference section later in this chapter for a detailed explanation of each operation and further hints on how it can be used.

1. Load or create a patch you want to explore. It may be wise to start with a rather simple patch, maybe a sequencer patch, where you here the changes as they happen.
2. If the sound came with some Patch Variations, listen to them and select one that you think is a nice departure point.
3. Drag the selected variation to the Mother box and click Mutate to generate six new children (shortcut: double-click on the variation, or press E on the computer keyboard).
4. Listen to the children one by one, by clicking once on each box or moving the focus with the arrow keys. They will be slight variations of the parent sound. If you like one and want to save it, drag it to the Temporary Storage (shortcut: S).
5. Select the best of the children, drag it to the Mother box and click Mutate (or simply press E). Six new children are created. These are grandchildren to the sound you started with. If none of the children suits your taste, click Mutate again. Six new Children are created from the same Mother as before.

6. If a sound is good, but not quite there yet, you can try the Patch Adjustor knobs to make swift changes, for example shorten the attack times or adjusting the timbre. Then go on from the modified sound.
7. If the children differ too much or too little from the parent, try changing the Mutation Probability (few or many changes) and Mutation Range (small or large changes).
8. Repeat steps 3 to 5 any number of times, and save the sounds you like in the Temporary Storage.
9. Also try mating one sound with another. Drag one nice variation to the Mother box, and another to the Father box. Then press *Cross*. Six new children will be created that are random mixes of the two parent sounds. This works best if the parents are not too similar.
10. When you are finished, copy a row from the Temporary Storage to the eight variation buffers by clicking the “v” button to the right of the row, and save the patch.

Instead of starting with an existing sound, you can click Randomize to generate six completely random children. Some of these may be very ugly, or even totally quiet. That is part of the game. If none is good, try clicking Randomize again. For most patches you will soon find a sound that will work as a good starting point. Remember that the sound doesn't need to be perfect. Through the process of repeated breeding you can modify it to suit your taste.

You can manually modify any sound (child, parent or in the storage) at any time, either by turning knobs in the usual way, or by using the Patch Adjustor. If you breed from this changed sound, these changes will be inherited by the children.

NOTE! All operations in the Patch Mutator works with multi-step UNDO in the usual way.

NOTE! The Temporary Storage is not saved with the patch. When the patch is closed, the contents are lost and cannot be recreated. Only the eight Patch Variations in the bottom row are saved with the patch. Make sure that you save your favorite sounds as Patch Variations (see below).

PATCH MUTATOR REFERENCE

In this section you will find a detailed description of the different operations in the Patch Mutator, and some hints about how to use them in sound design.

There is only one Patch Mutator window, but under the surface there are one instance of the Patch Mutator per open patch. This means that each open patch has its own Temporary Storage, probability settings and Quick Locks. However, these settings are not saved with the Patch.

Normally the G2 has eight edit buffers, the Patch Variations, and one of them is always active. With the Patch Mutator, this is no longer the case. If a parent, child or a sound from the Temporary Storage has focus, no Patch Variation is selected. Instead, the Patch Mutator uses a ninth, internal variation. This means that you can evolve and experiment without touching any of the eight Patch Variations.

WHICH PARAMETERS WILL BE AFFECTED?

The Patch Mutator turns a lot of knobs for you, and it is important to understand which parameters are affected, and how you can permanently or temporarily lock or exclude some parameters or modules from being changed.

EXCLUDE FROM MUTATION

Many patches contain parts that should not be changed, either because you want to keep manual control over, say, your reverb settings, or because you have carefully designed a circuit that only will be messed up by random changes.

You can exclude any module or combination of modules permanently from being affected by the Patch Mutator. Excluded modules are marked with a red frame when the Patch Mutator is open. This property is saved with the Patch.

- Select one or more modules, right-click and check *Exclude From Mutation*.

The Exclude From Mutation setting can be used to optimize a patch for sound breeding, by locking all modules that will cause unwanted changes, and leave the rest for the Patch Mutator to explore. This is very useful when sharing patches with other people. They can start evolving immediately, without detailed knowledge about the patch.

Sometimes you want to freeze only one or a few parameters of a specific module, but leave others for evolutionary changes. In most cases you can achieve this by locking the module and using an extra Constant module to modulate the parameter. By adjusting the modulation amount, you can also control the range of the mutations, as in this example:

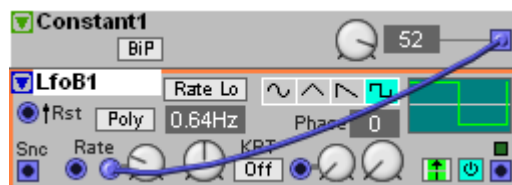

The LFO is excluded from mutations, but the rate will still be evolved within a specific range, controlled with the Rate modulation amount.

THE QUICK LOCK BUTTONS

You may not always want to evolve all kinds of parameters at the same time. Halfway through, maybe the sequencers behave very nicely, but you want to continue to evolve the other parts of the patch. Or you may want to temporarily exclude all effects from random changes without. Or the opposite – for a while you want to evolve only the sequencer values and sequencer events.

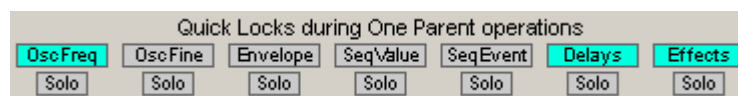

The Quick Lock buttons. In this case oscillator frequencies, delays and other effects are locked.

Using the Quick Lock buttons in the Patch Mutator, this kind of temporary parameter exclusions are easily achieved. There are seven categories, covering some of the basic parameter types. When a button is lit, parameters of that category are not affected by random mutations.

Below each button is a Solo button. Click this if you want to evolve only the parameters of a specific category. It is possible to activate more than one Solo button at the same time. Note that the solo buttons temporarily locks *all* other parameters, also those that are not covered by the other Quick Lock buttons. If you click the SeqValue Solo button, only the levels from the various step sequencer modules in the patch will be evolved. Nothing else.

Quick Lock Button	Description
OscFreq	The main frequency parameter of various kinds of oscillators, often called Semi, Freq, Fact or Partial. Also DrumSynth MasterOsc and SlaveOsc frequencies. This category should often be locked when you evolve keyboard patches, to avoid unwanted transpositions.
OscFine	The oscillator fine tune parameter, often called Cent.
Envelope	All Envelope times and levels.
SeqValue	All value faders of the step sequencers, including the Note Sequencer and the Control Sequencer.
SeqEvent	All gate and trigger event buttons in the various sequencers.
Delays	Parameters of the various Delay modules.
Effects	Parameters of the modules in the FX group.

Please note that the Quick Locks only makes sense with the Mutate and Randomize operations. Interpolate will have to interpolate also locked parameters to provide a smooth transition between the Mother and the Father. On the other hand, the Cross operation takes all the parameter values for the Children from either of the parents, and hence does not perform any random changes of parameters. It only combines existing parameter values randomly from two sources.

PROBABILITY DISTRIBUTIONS

All parameters are assigned a probability distribution to maximize the chance of good musical results. For example, an attack time of 45 seconds is seldom wanted. Hence, the attack parameter will tend towards lower parameter values. Likewise, extreme Oscillator Frequency settings are less probable, and Oscillator Cent parameters tend towards middle values.

PERMANENTLY LOCKED PARAMETERS

Also, there are a few parameters in different modules that are never possible to evolve. These choices have been made to optimize the Patch Mutator for use with any patch from your patch library, and to make the tool easier to use by excluding parameters that are unlikely to be evolved. For example, you wouldn't normally want to evolve the signal type (positive, bipolar, inverted positive etc) that can be set on the output of many modules, or the Mute or Bypass buttons on many oscillators, filters and effects. If you still want to evolve these parameters, you can mimic the behavior with other modules, and evolve the parameters on those. For example, bypass functionality can easily be created with a Switch 2-1 module.

MODULES EXCLUDED BY DEFAULT

A number of module types are excluded from mutations by default when you import old patches or create new modules. This is done to simplify the use of the Patch Mutator for newcomers, and to make it easy to evolve new sounds with old patches without tedious modifications.

Examples of modules excluded by default are: Input and Output modules, most MIDI modules, the Vocoder, the 6ch Stereo Mixer and a few others.

If you want to evolve the parameters of any of these modules, simply right-click it and uncheck *Exclude from Mutations*.

MUTATE

The Mutate operation produces new Children from one parent by introducing random changes to the parameter values of the Mother, so called *mutations*, similar to the DNA reading errors in the biological reproduction process. The extent of the random changes can be adjusted from small, almost unnoticeable nuances to wild alterations approaching total randomization.

When you click the Mutate button, six new children will be created based on the Mother sound. You can adjust the mutation probability, and the maximum range of the random changes. These are linked by default, so that a small mutation probability will lead to few but large random parameter changes. A high probability will lead to many, but very small random changes. You can adjust them individually by unchecking the *Link* button between the knobs.

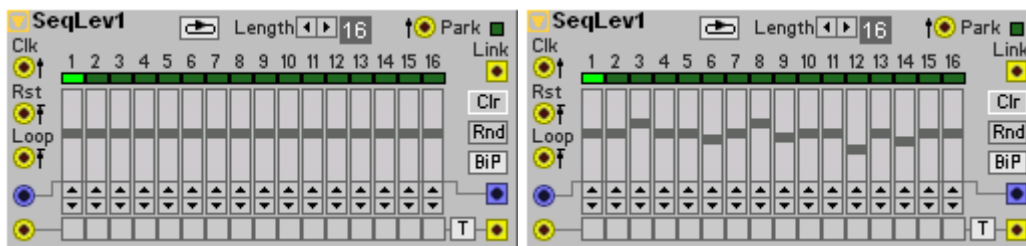

Mother (left), and a Child produced with default Mutation Probability and Mutation Range.

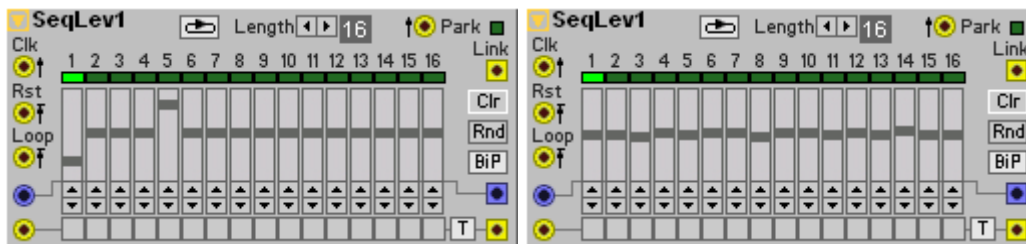

Two Children produced by Mutation, with low Mutation Probability and high Mutation Range (left), and high Mutation Probability and low Mutation Range (right)

Parameters that are excluded from random changes, either in excluded modules, or parameters locked with the Quick Lock buttons, will be copied from the parent sound without changes.

USAGE HINTS

The primary use of the Mutate operation is to create variations on existing sounds. Start with rather high probability and range settings to explore the possibilities. When you find a sound you like, you can use smaller and/or fewer mutations to explore the nearest vicinity of the sound.

If you find it difficult to evolve all parameters at the same time, lock some categories with the Quick Locks and evolve a subset of the parameters.

SHORTCUTS

Mutate from any sound in the Patch Mutator by double-clicking on it, or select it and press the E key on the computer keyboard. The sound is copied to the Mother position and six new Children are produced.

To produce six new Children from the current Mother, press the U key on the computer keyboard.

RANDOMIZE

Six new children will be created by generating completely random values for all parameters that are not excluded by the right-click menu option or by the Quick Lock buttons. The values of the excluded or locked parameters will not be randomized, but instead copied from the sound that has the focus when the Randomize operation is performed.



Random Children bear no resemblance to each other.

Randomize often produce wild and crazy sounds, but with careful use of the Quick Lock buttons and module exclude, you can control which parameters will be affected.

If you want only slight random variations on your sounds, use Mutation instead (see above).

USAGE HINTS

The Randomize operation is wild, and can create really strange sounds. Sometimes they are completely quiet, or very soft, usually because some mixer level was set very low by accident. But don't give up. For most patches you will soon find interesting and very unexpected sounds, that may serve well as starting point for further breeding with the Mutate and Cross operations.

Also try Crossing a random sound with a nice Patch Variation. In this way you can create new sounds that are not completely weird, but still new and fresh.

SHORTCUT

Press N on the computer keyboard to create six new random Children. Locked and excluded parameters will be copied from the currently focused sound.

INTERPOLATE

Six new children will be created by interpolating all parameter values linearly between the Mother sound and the Father sound. The children will show a step-wise progression from left to right. This is clearly visible in the chromosome graphs, which will morph between the two parents' graphs.



The result of an Interpolation between two sounds. Note how the graphical representation of the sound gradually “morphs” between the Mother and the Father.

Parameters with a range of only a few values (e.g., sequencer events or radio buttons) will switch at slightly different times, to create a more interesting result.

NOTE! Interpolate can change the values of all parameters in the patch, regardless of the lock buttons and module excludes. However, parameters that have the same value in the father and the mother will not change.

USAGE HINTS

This tool is useful to create smooth progressions between two different sounds. If you think the steps are too large between the Children, you can further interpolate between them.

SHORTCUTS

While holding Shift on the computer keyboard, drag and drop one sound on another to perform an Interpolation between them.

You can also perform an Interpolation without using the mouse. With the Patch Mutator active, select a variation you want to use as parent. Then copy it to a parent box with the O key (Mother) or the T key (Father) on the computer keyboard. When both parents are in place, press I to perform the Interpolation.

CROSS

Six children will be created by copying each parameter value from either the Mother or the Father sound. This is similar to the merging of DNA from two parents in natural reproduction. It works like this:

The parameter values are copied from one of the parents. At random points in the process the copying process starts reading from the other parent instead. In this way, the copying jumps back and forth between copying from the mother and copying from the father. The result is a sound where the parameters come from both parents, in a random combination.

With a higher *Cross Probability* setting, the copying will switch more often between the two parents during the copying process. In different words – a small cross probability will result in large sections of the patch being intact from one parent, for example a whole sequencer module, or a few neighbor modules. This will result in children more obviously similar to the parents. An example:

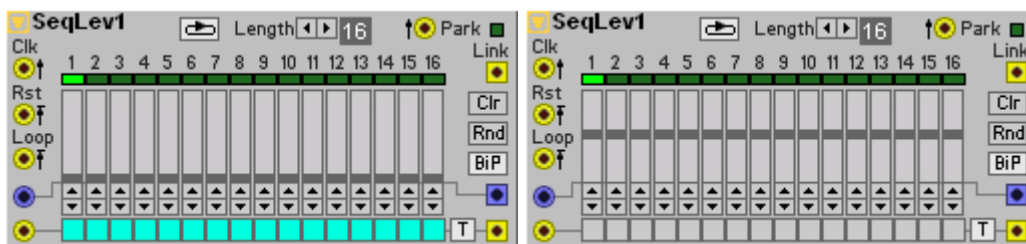

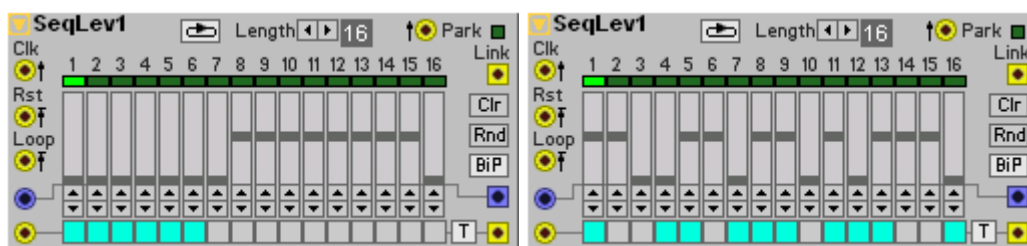
Mother and Father.*Their Children, produced with low (left) and high (right) Cross Probability.*

During the crossover process, no random changes are made to the parameter values. All parameters of the children will have the value from either the mother or the father.

USAGE HINTS

Cross works very well when the parents are rather different. The Children will differ in the same way as brothers and sisters do – the nose from Father, the eyes from Mother. The rhythms, timbre or other qualities of the sound will be clearly identifiable as coming from either parent.

Since Cross doesn't introduce any random changes, it can be used with tricky patches that are not so well suited for mutations and randomization. This can be the case with FM synthesis and other synthesis techniques where the internal relationship between the parameters is crucial. Since it uses only "safe" values, there is a good chance that the children will be good.

Try mating two nice Patch Variations, to produce more nice and well-behaved variations. You can also try to mate a nice sound with a weird random sound to induce some new life into too well-behaved variations.

Mating siblings (two sounds from the same set of children) usually doesn't work well. Usually siblings are already genetically quite similar, so the resulting sounds will not exhibit much interesting variation.

SHORTCUTS

While holding Ctrl on the computer keyboard, drag and drop one sound on another to perform a Crossover from those two sounds.

You can also perform a Crossover operation without using the mouse. With the Patch Mutator active, select a variation you want to use as parent. Then copy it to a parent box with the O key (Mother) or the T key (Father) on the computer keyboard. With the parents in place, press X to perform the crossover.

THE TEMPORARY STORAGE

With the Patch Mutator, it is easy to produce a vast number of sounds, and often one doesn't know until later which sounds should be kept. Temporary results and unexpected sounds can be stored in the Temporary Storage, to be reused later in the breeding process.

To save any sound (parent, child or variation) in the Temporary Storage, drag it to any of the 24 storage boxes. If box already contains a sound, it will be overwritten. You can also move a sound within the storage by dragging it to a new box.

Click the “x” button to the right of a row of sounds in the Temporary Storage to clear the whole row. Right-click a box and select Delete to clear it.

If you accidentally overwrite or erase a sound, remember that Undo (Ctrl-Z) works with all operations in the Patch Editor.

SAVING SOUNDS

The Temporary Storage is not saved with the patch to flash memory or disk. Only the usual eight Patch Variations are saved with the patch. However, you can easily transfer your favorite sounds to the eight patch variations and save the patch.

To save a set of eight sounds from the Temporary Storage, arrange them in a row in the storage with the mouse. Then click the “v” button to the right of the row. The whole row will be copied to the eight patch variations (overwriting the current variations). Then you can save the patch in the usual way, to flash memory or to disk.

NOTE! If none of the eight Patch Variations is selected during Save, the Patch will open with the first Patch Variation selected. This means that the Patch may not sound exactly as it did when you saved it.

PATCH MUTATOR SHORTCUTS OVERVIEW

Keyboard Shortcuts	Action
Ctrl-2	Show or hide the Patch Mutator
Ctrl-3	Show or hide the Patch Adjustor
1	Set focus on Mother
2, 3, 4, 5, 6, 7	Set focus on one of the Children
8	Set focus on Father
Arrow keys	Move focus around in four directions
O	Copy focused variation to Mother
T	Copy focused variation to Father
E	Copy focused variation to Mother and create new Children by Mutation
U	Create new Children by Mutation from current Mother
N	Create new Children by Randomize
I	Create new Children by Interpolation between current Mother and Father
X	Create new Children by Crossover from current Mother and Father
S	Save focused variation to first empty box in the Temporary Storage
Mouse Shortcuts	
Click on a box	Set focus
Double-click on a box	Copy focused variation to Mother and create new Children by Mutation
Drag-drop a box to Temporary Storage	Save a variation in the Temporary Storage. Previous contents of that position are overwritten.
Drag-drop a box to a Patch Variation	Copy a sound to one of the eight Patch Variations. Previous contents of the variation are overwritten.

Shift-drag-drop	Copy the source and destination sounds to Mother and Father and create new Children by Interpolation.
Ctrl-drag-drop	Copy the source and destination sounds to Mother and Father and create new Children by Crossover.

HISTORICAL BACKGROUND

The Patch Mutator is based on evolutionary algorithms, a subdiscipline of the research field of Artificial Life. In this field, natural processes are studied and simulated, based on the conviction that we can learn from nature, both about how it works and how to perform other tasks more efficiently inspired by these processes. This has led to a deeper understanding of the complex systems in nature, but also to new algorithms for many computational tasks, such as optimization and searching.

Evolutionary algorithms were first proposed by computer science pioneer John Holland in the 1970s, in a form he called the “genetic algorithm”. Inspired by Darwinian evolution, it applies random variation and selection as an optimization technique. However, when working with aesthetic objects like images and sounds, it is impossible to define any formalized selection criterion. Nobody can define what is a beautiful sound!

In the middle of the 1980s, the British biologist and writer Richard Dawkins proposed a variation on the genetic algorithm, where a human does the selection based on whatever his aesthetic preferences are, a kind of interactive evolution. Others further elaborated upon this technique, for example computer graphics wizard Karl Sims, who designed a system for interactively evolving stunning computer graphics images. Since then, it has been used in numerous graphical applications, but not nearly as much in music, maybe because it is much easier to browse and judge a bunch of images than a bunch of sounds or compositions.

The G2 Patch Mutator is based on the work of Palle Dahlstedt, Swedish composer and researcher. His research interest has primarily been in the application of evolutionary algorithms as creative tools, aiding the search of novel musical expressions. This has resulted in a series of tools for evolving electronic sounds and musical scores, and also in programs that compose music by themselves using evolutionary techniques.

FURTHER READING

There are many books and articles published about evolutionary algorithms in different contexts. Below are references to a few texts relevant for the Patch Mutator, and also some introducing the field in general.

Richard Dawkins: *The Blind Watchmaker*. Longman Scientific and Technical, 1986.
The book that introduced the concept of interactive evolution.

Karl Sims: *Artificial Evolution for Computer Graphics*, 1991
Seminal paper on artistic use of interactive evolution by one of the pioneers, available online at: <http://www.genarts.com/karl/papers/siggraph91.html>

Stephen Levy: *Artificial Life – A report from the frontier where computers meet biology*, 1992
A popular science book introducing the broad field of Artificial Life.

Palle Dahlstedt: Sounds Unheard of – Evolutionary algorithms as creative tools for the contemporary composer. Chalmers University of Technology, 2004

A doctoral dissertation about the techniques behind the Patch Mutator, and other musical applications of evolutionary algorithms. Contains a historical and theoretical introduction, a series of papers and sound examples. It is available online at: <http://www.id.gu.se/palle/dokt/soundsunheardof.htm>

8. THE PATCH ADJUSTER

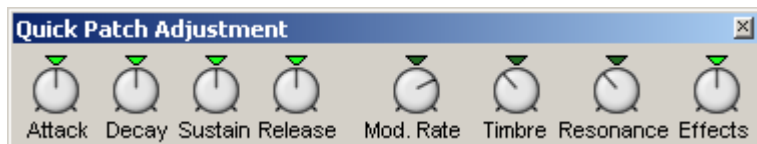

INTRODUCTION

The Patch Adjuster contains a number of knobs for quick adjustment of all parameters of a certain category, such as all attack times or all resonances. In this way, you can quickly shape a sound in a more general way, without knowing the specifics of the patch.

For example, turning the *Attack* knob to the left will decrease all attack times in the patch, relative to their current position. Turning the *Timbre* knob will adjust filter frequencies, FM amounts, shapers and some other parameters that affect the timbre of the sound. If the result is not what you expected, just turn the knob back to its middle position, or click the centre marker. As soon as you move the focus to another variation or add or remove a module, the changes will be permanently applied, and the knobs will return to their middle positions.

When browsing a large number of patches, or when evolving new patch variations with the Patch Mutator, this kind of quick changes can be very useful. A patch may be promising, but not exactly what you want. Then you can apply that last touch with the Patch Adjustor knobs. You do not need to track down where the specific parameters are situated in a complex patch.

Patch Adjustor knob	Description
Attack	All envelope Attack parameters, as well as compressor, noise gate and envelope follower Attack parameters.
Decay	All envelope Decay parameters, as well as some Time parameters in the multi-stage envelopes.
Sustain	All envelope Sustain parameters, and some Level parameters of the multi-stage envelopes.
Release	All envelope Release parameters, as well as compressor, noise gate and envelope follower Release parameters.
Mod. Rate	All LFO and Random rates, and the rates of all effect modules incorporating an internal LFO, such as Chorus, Phaser and Flanger.
Timbre	Filter cutoff frequencies, FM modulation amounts, various waveshape parameters in oscillators and shapers, as well as various FX parameters affecting the timbre of the sound.
Resonance	All filter resonances, and Phaser and Flanger feedback.
Effects	Dry/wet effect parameters.

The Patch Adjuster lives as a floater on top of the editor window, like the Patch Browser, the Parameter Pages and the other tools of the G2 Editor. The Patch Adjuster is only available in the G2 Editor, not in the hardware synth itself.

It is important to understand how the Patch Adjuster knobs work. They are not to be considered as additional parameters in the patch or as additional Morph categories. They rather act as remote, relative editing tools for all parameters of a specific category, wherever they are located in the patch. Because of their different nature, these knobs cannot be assigned to MIDI Controllers or to physical knobs on the synth.

9. EDITOR MENU REFERENCE

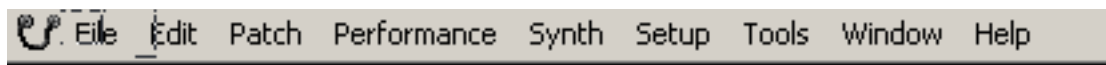

In the Editor, the usual Windows98SE/2000/XP and Mac OSX keyboard commands are available. The drop-down menus can be accessed by pressing the Alt key and the underlined letter in the menu bar. The functions in the drop-down menus can then be accessed by pressing the key corresponding to the underlined letter in the drop-down menus.

Most of the commands can also be accessed by pressing the Ctrl key together with the letter shown next to the command name in the drop-down lists.

EDITOR MENU BAR

The best thing to do first is a quick scan through the Editor Menu bar before you actually try to make your first patch. This will help you a lot with getting familiar with all the Editor ‘household’ functions that will make creating your patches easy. Even if you are already a very experienced computer user, it is always good to know what is in the menus and in which menus to find certain functions.

FILE MENU

NEW PATCH {CTRL-N}

Creates a new, empty Patch window. If connected to the synth, the currently active Slot will be cleared to host your new Patch. See [“Making your first patch” on page 63](#) for info on how to create a Patch.

NEW PERFORMANCE

Creates 4 new, empty Patch windows. If connected to the synth, all 4 Slots will be automatically activated and cleared to host your new Performance. Slot A will be assigned to the keyboard. The synth will also switch to Performance Mode. See [“Creating a Performance in the Editor” on page 95](#).

OPEN {CTRL-O}

Brings up the file selector and allows you to open a Patch or Performance file from disk. Select between Patch and Performance files from the ‘Files of type’ drop-down selector. Select a file and click Open to open and download the Patch/Performance to the Slot(s) in the synth. **Note that if you open a Patch in Performance mode with the synth connected, the selected Patch will be opened and downloaded in Slot A and all other Slots will be cleared.**

NEW TO

Creates a new, empty Patch window in a selectable Slot of the connected synth, or in Performance Mode. If connected to the synth, the selected Slot will be cleared to host your new Patch. See [“Making your first patch” on page 63](#).

OPEN TO

Brings up the file selector and allows you to open a Patch file from disk and download to a selectable Slot. Select a file and click Open to open and download the Patch to the selected Slot in the synth. This command is useful when you select Patches when creating a Performance.

SAVE {CTRL-S}

This command will save the current Patch or Performance to a storage disk on the computer. If the Patch or Performance wasn't opened from the computer using the File | Open command (see above) or if you changed the Name in the Toolbar, you will be prompted for a file name and destination folder. Patches that are saved from the Editor automatically gets the extension '.pch2' and Performances '.prf2'.

SAVE AS

This command will prompt you for a file name and destination folder before saving the Patch or Performance to disk. This is useful for renaming a Patch file before saving it, leaving any original Patch intact on the disk. Patches that are saved from the Editor automatically gets the extension '.pch2' and Performances '.prf2'.

SAVE ALL

This command will save all open Patches and/or Performances to a storage disk on the computer. If a Patch or Performance has not been saved before, you will be prompted for a file name. Patches that are saved from the Editor automatically gets the extension '.pch2' and Performances '.prf2'.

SAVE FROM

This command will let you save a Patch from a selectable Slot to disk. You will also get the opportunity to rename the Patch file before saving it, leaving any original Patch intact on the disk. Patches that are saved from the Editor automatically gets the extension '.pch2'. This command is useful if you want to extract a Patch from a Performance and save it as a single Patch on the computer.

SAVE INITPATCH 1 & 2

This command will save the current Patch as an InitPatch to a storage disk on the computer. An InitPatch can be used as a "template" Patch to recall instantly by pressing the Init buttons in the Toolbar (see "Init 1&2" on page 60). You can save two InitPatches.

RECENT FILES

Here you can choose to open any of the most recently opened Patches.

QUIT {CTRL-Q}

Quits the Editor software. **Any unsaved Patches will automatically be deleted.** Closing a Patch in the Editor or quitting the Editor will not remove Patches that have been downloaded to a Slot in the synth.

EDIT MENU

UNDO {CTRL-Z}

Click to undo your latest operations/commands.

REDO {CTRL-Y}

Click to step back through the latest Undo operations. Works like a reversed 'Undo' function.

CUT {CTRL-X}

Cuts out one or several modules, including their common cable connections and parameter settings, and places in the clipboard memory.

COPY {CTRL-C}

Copies one or several modules, including their common cable connections and parameter settings, and places in the clipboard memory.

PASTE {CTRL-V}

Pastes one or several modules, including their common cable connections and parameter settings, that previously have been cut or copied to the clipboard memory. The Paste command results in a cursor with a small '+' sign attached to it. Place the cursor where you want in the Patch window and click to paste the module(s).

CLEAR

Deletes one or several selected modules (and their mutual cable connections) from the Patch window.

PASTE PARAMS {CTRL-E}

This command should be used if you only want to paste a copied module parameter values to another module of the same type. You can also select several modules in one Variation, select Copy and then Paste Params in another Variation.

SELECT ALL {CTRL-A}

Selects all modules in the most recently used section of the Patch window for clearing, copying, moving etc.

PATCH MENU

PATCH SETTINGS {CTRL-P}

Opens up the Patch Settings floating window. The Patch Settings parameters can be different for different Variations. (These functions are also available for editing on the synth if you press the **PATCH SETTINGS** button. See “Editing Patch Settings” on page 34).

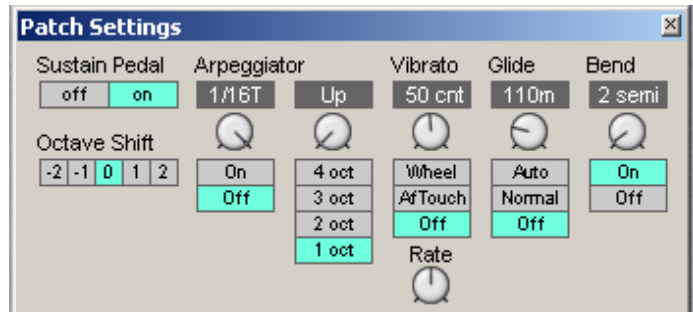

SUSTAIN PEDAL

Select if a sustain pedal connected to the **SUSTAIN PEDAL** input on the rear panel of Nord Modular **G2** should act as a Sustain pedal and On/Off switch or only as an On/Off switch.

Note! If you use it only as an on/off switch (the ‘Off’ alternative), you have to assign the switch to module parameters in a Patch to the Sustain Pedal Morph group (see “Morph groups” on page 92).

OCTAVE SHIFT

Here you select the octave setting of the Patch. This information is saved with the rest of the Patch data in the Patch. Note that this setting is active only if you play the Patch from a Nord Modular **G2** keyboard version.

ARPEGGIATOR

Select Period (sync division) for the Arpeggiator in relation to the Master Clock rate with the knob. Activate/stop the Arpeggiator with the radio buttons below the knob. Note that the Master Clock doesn’t have to be active for the Arpeggiator to run. Select Direction with the right knob and Range with the radio buttons below the knob.

The Arpeggiator uses MIDI Song Position Pointer when synced to an external MIDI Clock, which means that if you record an arpeggio in an external sequencer, it will always play back the pattern exactly the same way it was recorded - even if you start the sequencer in the middle of the sequence.

VIBRATO

This is a separate vibrato which affects all modules in the Patch set to Keyboard Tracking. Set the Vibrato amount, in cents of a semitone, with the knob and select control source (Aftertouch, Modwheel or Off) with the radio buttons below the knob. Set the Vibrato rate with the knob below the radio buttons.

GLIDE

The Glide function is mainly intended for use in mono or legato (see “Voice Mode” on page 62). The glide characteristics can be described as “constant rate”. “Constant rate” means that the greater the “distance” between two subsequent notes, the longer the glide time. Turn the knob to adjust the glide rate and press the radio buttons to select glide mode. ‘Normal’ means the glide is always active and ‘Auto’ that glide is active only when you play legato (you press a new key before you release the previous key).

Note: If you use Glide in polyphonic mode, the glide will be unpredictable and perceived as more or less random. This is because the glide is between voices rather than between keys. The

glide will therefore be from the available voices' latest note values to the new notes rather than from the previously pressed keys.

BEND

Set the Pitch bend range, in semitones, with the knob. The pitch bend will affect all modules in the Patch set to Keyboard Tracking when you bend the **PITCH STICK** or receive pitch bend data from MIDI. Switch on/off the pitch bend function with the radio buttons below the knob.

ASSIGNING MIDI CC# CONTROLLERS TO PATCH SETTINGS KNOBS.

All controls in the patch Settings panel, except for the Octave Shift, can be assigned to MIDI CC# controllers in the same way as you assign module parameter knobs to MIDI CC# controllers.

TEXTPAD {CTRL-H}

Brings up the Textpad floating window. Here you can type in text (description, comments s etc.) about the Patch.

DELETE UNUSED MODULES

Select this function to clear all unused modules in the Patch. This is useful if you have edited an existing Patch and want to get rid of any superfluous modules.

DOWNLOAD TO SLOT {CTRL-D}

Brings up a dialog box in which you can choose to download the currently active Editor Patch to a selectable Slot in the connected synth.

PERFORMANCE MENU

PERFORMANCE SETTINGS {CTRL-R}

Brings up the Performance Settings floating window. Here you can edit the common Performance parameters.

NAME

Type in the Performance name and press Enter. The name will also be shown in the 'Perf' display box in the Toolbar.

SLOTS ENABLE

Click in the check boxes for each of the Slots you want to include in the Performance.

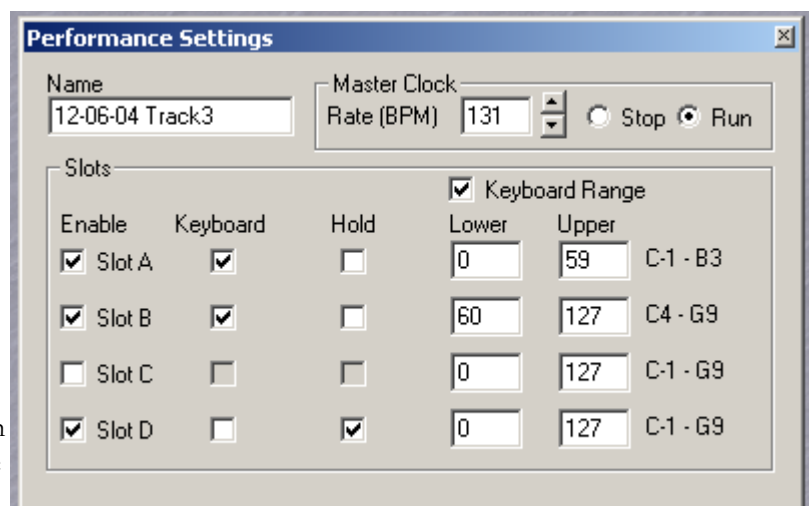

KEYBOARD

Click in the check boxes for each of the Slots you want to play from the internal keyboard of the synth and/or respond to MIDI Note data on the Global MIDI Channel (see "midi Settings" on page 121).

HOLD

Click in the check box to activate Keyboard Hold for each of the Slots in the Performance.

KEYBOARD RANGE

Activate the Keyboard Range function by clicking in the Keyboard Range check box. Set any keyboard note ranges for each of the Slots in the Performance. It's possible to have overlapping keyboard ranges for several Slots if you like. If the Keyboard Range function is not active, all enabled Slots will respond to notes in the entire MIDI note range (C-1 to G9).

MASTER CLOCK

Here you can select the Master Clock Rate for your Performance. You can also select whether to have the Master Clock active or not when you upload your Performance by clicking in the Stop or Run box.

DOWNLOAD

If you have been working on a couple of Performances in Local mode (synth unconnected) and you want to download one of the Performances after having established contact with the synth, you can use the Download command.

SYNTH MENU**SYNTH SETTINGS {CTRL-G}**

The Synth Settings window allows you to set basic settings for the **G2**. Any settings that you make will be activated instantly and automatically stored in the synth when you click the OK button. If you press Cancel, all parameters will revert to their original settings. (Some of these functions are also available for editing from the synth if you press the **SYSTEM** button).

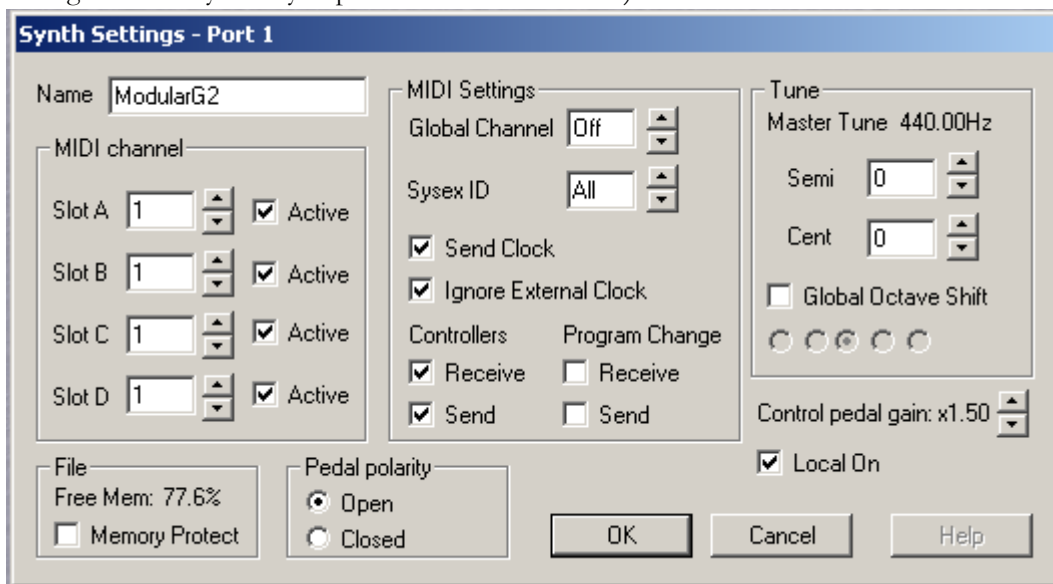
**NAME**

Type in a name for your connected synth and press Enter. This is especially useful if you run several Nord Modular **G2** synthesizers from the Editor. The name will also be displayed in the Synth Name display box in the Toolbar.

MIDI CHANNEL

Set the MIDI channel for each Slot. This channel will be used for reception and transmission of MIDI messages.

MIDI Active check box:

Click in the corresponding check box to activate the Slot to receive and transmit MIDI messages.

LOCAL ON

Click the Local On check box to turn the MIDI Local Control on. Select Local On to be able to control the synth from the internal keyboard and the pedals. MIDI data is also transmitted via the **MIDI OUT** jack. In the Local Off mode, the keyboard and pedal actions are transmitted only via MIDI and do not control the synth itself. Local Off should be used with external sequencers if the **MIDI OUT** jack of Nord Modular **G2** is routed back, via the external sequencer, to the **MIDI IN** jack. If Echo is active in the sequencer, “double notes” will appear when playing the keyboard in Local On mode.

MIDI SETTINGS**GLOBAL CHANNEL:**

Here you set the Global MIDI Channel for the synth. The Global MIDI Channel should be used for sending and receiving MIDI note data and for sending control data (Modwheel, Aftertouch, Velocity, Aftertouch and Pedals) as well as sending and receiving MIDI Program Change messages in Performance mode to change to another Performance. Select Global MIDI Channel by clicking the arrow buttons.

SysEX ID:

Here you can set an ‘Instrument SysEx ID’. This is very useful if you’re sending SysEx dumps of sounds from a sequencer to the Nord Modular **G2** and have several **G2** synthesizers MIDI connected. Let’s say you have two **G2** synthesizers. These two instrument models have the same ‘Manufacturer ID’ and ‘Model ID’ in the SysEx protocol. By defining separate SysEx ID’s on the two synths, you will be able to “direct” the SysEx dumps from the sequencer to one of the **G2**’s while the other one will ignore the dumps. Just make sure that you define a separate SysEx ID before dumping the sounds to the sequencer. Select Instrument SysEx ID by clicking on the arrow buttons. If SysEx ID is set to All the G2 will ignore the SysEx ID in the SysEx data and always accept the SysEx data.

SEND CLOCK:

Here you choose whether or not to send out MIDI Clock to the **MIDI OUT** jack of the synth. Sending out a MIDI Clock signal will only work when you use the internal Master Clock as clock source.

IGNORE EXTERNAL CLOCK:

Here you choose whether or not to accept external MIDI Clock signals received on the **MIDI IN** jack of the synth. If unchecked, the Master Clock of the synth will automatically sync to any incoming MIDI Clock.

CONTROLLERS: RECEIVE AND SEND:

Here you select how the synth should handle MIDI Controller messages. Select Off, Send and Receive by clicking in the respective check boxes.

PROGRAM CHANGE:

Here you select how the synth should handle Program Change and Bank Select (Controller #32) MIDI messages. Select Off, Send and Receive by clicking in the respective check boxes.

TUNE**MASTER TUNE:**

Use this function to tune the synth to other instruments. The range is from -6 to +6 semitones and fine adjustment from -100 to +100 cents. 100 cents is one semitone. All Oscillator modules are affected by the Master Tune function. Select tuning with the respective arrow buttons.

GLOBAL OCTAVE SHIFT:

Click in the check box to activate Global Octave Shift which means that the octave shift will affect all Slots when controlled from the internal keyboard. Set octave shift range (-2 to +2 octaves) by clicking in the corresponding box.

CONTROL PEDAL GAIN

Control/expression pedals from different brands can have different characteristics. You can adjust the control pedal sensitivity of the synth to match your pedal. Adjust the Gain setting (x1.00-x1.50) with the arrow buttons.

FILE

MEMORY PROTECT:

Select memory protection for the entire internal Patch and Performance memory by clicking in the check box.

SORT BY:

Select if you want Patches in the internal memory of the synth to be displayed by Program Number, Alphanumerical or by Category by clicking the desired box. See [“Search for and load a Patch” on page 36](#) for more info on how to use the different Sort Modes on the synth.

PEDAL POLARITY

Different sustain pedals use different polarity to activate the sustain switch. Select between ‘Open’ and ‘Closed’ by clicking the desired box.

UPLOAD ACTIVE SLOT {CTRL-U}

This command will upload the Patch from the currently active Slot in the synth to the Editor. This is useful if you have closed the Patch in the Editor earlier and want to edit the Patch in the Slot again. A new Patch window will be created for the uploaded Patch.

SAVE IN SYNTH

This function lets you save the Patch or Performance of the active Patch window in any of the synthesizer’s memory locations.

Select Bank and Patch location from the drop-down menus. Click Save to execute and exit the dialog box, or Cancel to exit without saving.

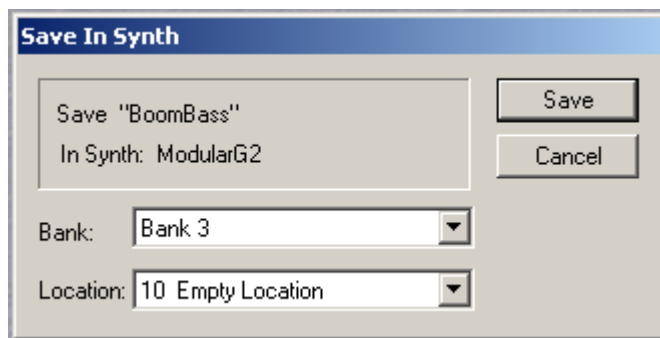

BANK UPLOAD (FROM MODULAR)

This feature is a quick way of saving a complete Patch or Performance bank from the synth memory to disk without needing to upload and save each Patch/Performance separately.

1. Select Type (Patch or Performance) and which bank to upload (1-32 for Patches or 1-8 for Performances).
2. Click Browse Location to select a destination folder on the computer.
3. In the 'File name' field, you can type in your own file name. By default, a Patch file is named PatchBank# and a Performance Bank PerfBank# with the # representing the Bank number you have selected to upload. Click Save. Now all sounds of the selected bank are saved individually together with a Patch list file with the extension '.pchList'. The original memory location of each Patch is also saved with the 'List' file, so you can download them to the correct memory location later. As the sounds are uploaded from synth, a progress bar indicates the elapsed time.

Tip!

Don't save several Bank files in the same folder on the computer. The Bank file is saved together with all individual Patch/Performance files. If several Bank files should contain the same Patch/Performance name(s), these files will be renamed with a post-fix number and could cause confusion when downloading the Bank files back to the synthesizer. To avoid this problem, save each Bank file in a separate folder on the computer.

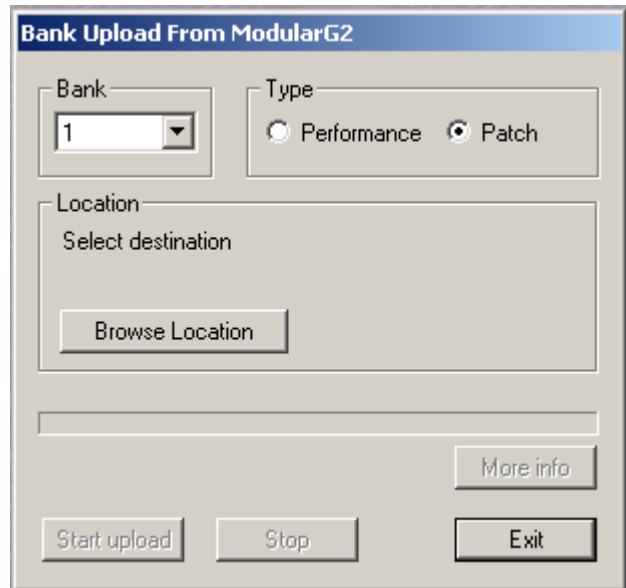

BANK DOWNLOAD (TO MODULAR)

1. Select source by clicking on one of the two buttons:

‘Browse for Bank file’ lets you select a Bank file (.pchList) previously saved on the computer. Browse and select the pchList file you want to download to a bank in the synth.

‘Browse for folder’ lets you select a folder containing separate Patch or Performance files. The folder doesn’t have to contain a pchList file. The sound files of the selected folder will be downloaded to the synth in alphabetical order. If a folder should contain more than 128 sound files the “overflowing” files will be ignored. Note that the folder could also contain other file types, but only Patch or Performance files will be downloaded to the synth.

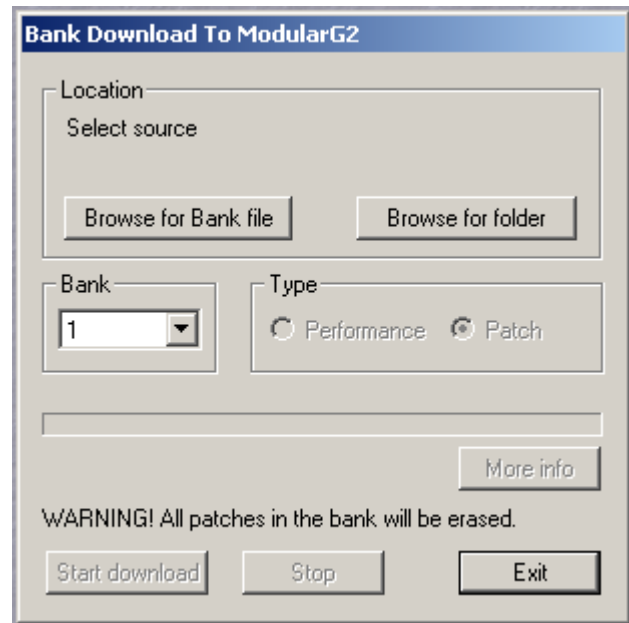

2. Select which bank (1-32 for Patches or 1-8 for Performances) to replace with your selected bank.

If you selected ‘Browse for Bank file’, click Open to select the file and prepare for downloading the Patches or Performances to their original memory location within the selected bank.

If you selected ‘Browse for folder’, click OK to select the folder and prepare for downloading the Patches or Performances, in alphabetical order, to the selected bank.

3. Click the ‘Start download’ button. A progress bar indicates the elapsed time as the files are stored in the Nord Modular **G2** internal memory. They will remain in the internal memory as if they were stored one by one using the **STORE** button or the ‘Store’ function of the Browser (see [page 128](#)) in the Editor.

Note!

The entire memory bank you chose to download to will be overwritten in the Nord Modular G2 synthesizer. Even if the bank you download from the computer doesn’t contain Patches/ Performances in all memory locations, all previously stored sounds in the Nord Modular G2 synthesizer bank will be erased. Therefore, it could be wise to consider the banks in the synthesizer more like folders on the computer. When you download an entire bank to the synthesizer it would be similar to deleting and replacing a folder on the computer, i.e. the whole content of the bank (folder) would be erased and replaced.

SEND CONTROLLER SNAPSHOT {CTRL-M}

Use this command to send all assigned MIDI Controller values to the **MIDI OUT** of the synthesizer. This is very useful if you are recording in a sequencer program and want to make sure the sound sounds exactly as you want.

DUMP ONE {CTRL-1}

This command will transmit the complete patch in the active Slot as a MIDI SYSEX dump over the MIDI OUT connector. This allows you to embed a patch as MIDI SYSEX in a MIDI sequencer program running on a computer. The **G2** Keyboard and **G2X** models have a panel button to initiate a patch dump over MIDI, but for the **G2** Engine model you will have to initiate a patch dump through this command. Note that the MIDI SYSEX information is in a compressed, unreadable format. If the MIDI SYSEX dump is transmitted from the MIDI sequencer program the **G2** system will load it as a new patch in the current Slot.

SETUP MENU

OPTIONS

The functions in this dialog box affects the configuration of the Editor. The parameters are automatically saved when you exit the Options window by clicking OK.

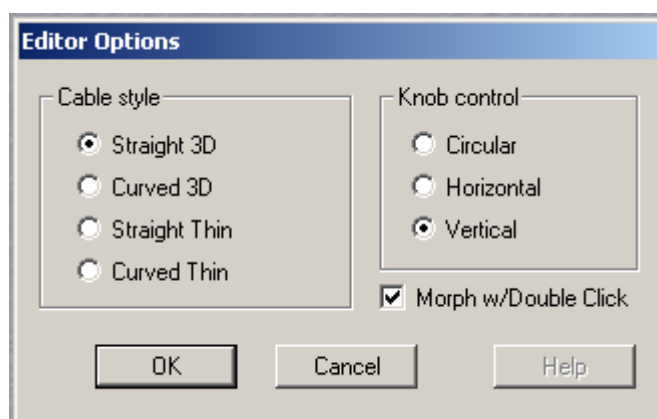

CABLE STYLE

This is where you can adjust the appearance of the Patch cables in the Editor. Choose between Straight 3D, Curved 3D, Straight Thin and Curved Thin.

KNOB CONTROL

Here you select if you want the knob and slider parameters in the Editor Patch window to respond to Circular, Horizontal or Vertical motions with the mouse.

MORPH W/DOUBLE CLICK

Click this check box to enable Morph group assignment of module parameters by double-clicking the parameter(s). If unchecked, you have to Ctrl-click a parameter (or right-click and select from pop-up) to assign it to a Morph group.

TOOLS MENU

PARAMETER PAGES {CTRL-F}

This function activates the Parameter Pages floating window. The Parameter Pages window is a graphical representation of the **ASSIGNABLE KNOBS** and **BUTTONS** of the synth's front panel. The Parameter Pages gives you both visual indication and the possibility to edit the parameters currently assigned to an



ASSIGNABLE KNOB/BUTTON. Any assigned module parameters show up with their name and current value in the corresponding display box.

Click-hold an assigned knob in the Parameter Pages window and change its value, just like you would change a module parameter. As you can see, the assigned module parameter will change its value, also visually, when the knob is changed. If you turn an **ASSIGNABLE KNOB** on the synth's front panel, the knob in the Parameter Pages window and the corresponding module parameter will change, also visually. Change Parameter Page by clicking on another Page button. In Performance mode you can also choose to display the Global Parameter Pages by clicking the Global Pages button. See [“The Parameter Pages window” on page 89](#) for info on how to assign module parameters to the Parameter Pages.

USING PARAMETER PAGES TO MAKE KNOB ASSIGNMENTS

You can quickly make a knob assignment by ‘dragging with the mouse’ the grey display area above a knob in the Parameter Pages window to a knob on a module in the patch. Try it out now and see for yourself how easy and quick this works. Alternatively you can press and hold the Alt-key and then drag the module knob with the mouse to a grey display area in the Parameter Pages window.

PARAMETER OVERVIEW {CTRL-L}

Brings up the Parameter Overview floating window which displays all Parameter Pages at once. It's also possible to assign module parameters to any of the knobs/buttons in this window by click-holding a display box and dragging and dropping on a module parameter in the Patch window. If you like, you can also move parameter assignments by click-holding on a display box and then dragging the cursor to another display box and releasing the mouse button. Display the Global Pages by clicking the Global Pages button to the top right of the window.

USING PARAMETER OVERVIEW TO MAKE KNOB ASSIGNMENTS

You can quickly make a knob assignment by ‘dragging with the mouse’ a grey display area in the Parameter Overview window to a knob on a module in the patch. Try it out now and see for yourself how easy and quick this works. When dragging a grey display area for a knob to another grey display area you move the knob

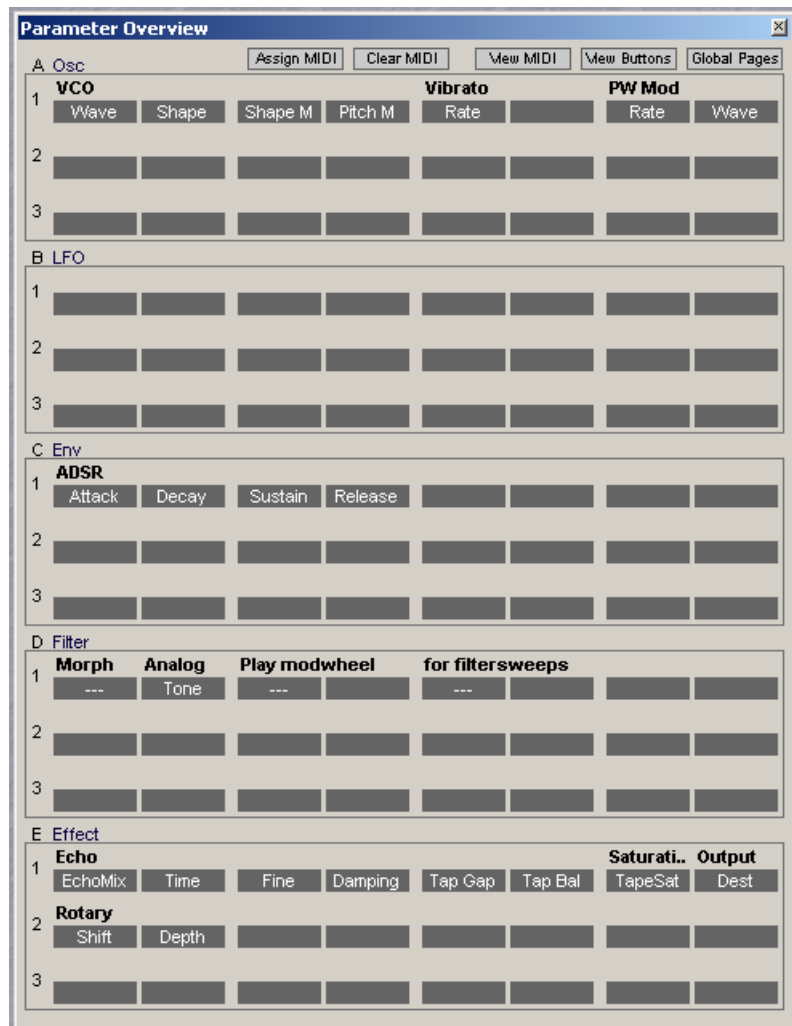

assignment to the new position. With this function you can very quickly reorganize all your knob assignments. Again, try it out and see for yourself.

Alternatively you can drag a knob from a module to the Parameter Overview by first pressing and holding the Alt key on the computer keyboard and then drag the knob to a location on the Parameter Overview window.

ASSIGN MIDI

With this button you can instantly assign MIDI CC#s to all knobs and buttons that are assigned in the Parameter Overview. The function will start by assigning the first available MIDI CC# to the first assigned knob in the first parameter page. Then it will assign the next available MIDI CC# to the next assigned knob, and so on, until all available MIDI CC#s are used.

In practise you would probably first assign some MIDI CC#s by hand, e.g. if you would use the GM (General MIDI) prescribed MIDI CC#s for things like panning, etc. Then you fill in the rest with this Assign MIDI function.

Note that it is also possible to assign a MIDI CC# directly to a knob on a module that is not assigned to a panel knob. To do so you have to use the rightclick menu directly on the knob on the module itself. Or alternatively use the **MIDI LEARN** function (see also “[MIDI-Learn function \(L key\)](#)” on page 145).

CLEAR MIDI

With this function you can immediately clear *all* assigned MIDI CC#s. Note that this is quite drastic, if you did all the MIDI CC# assignments by hand all you work will get lost. This function must be seen as the reversal of the Assign MIDI function. Note that you can use the Editor Undo function if you accidentally hit this function button.

VIEW MIDI

This function instantly shows all assigned MIDI CC#s for those knobs and buttons that are also assigned to panel controls through the Parameter Pages. Note that knobs and buttons on modules that are not assigned in the Parameter Pages can still have a MIDI CC# assigned to them. Use the rightclick menu MIDI Controller (**M** key) function to get the complete list of all MIDI CC# assignments in a Patch.

VIEW BUTTONS

On some modules, like the Sequencer modules, a single assignment assigns both the knob/slider plus its associated pushbutton to a frontpanel endless rotary dial and its associated pushbutton. With the View Buttons function you can toggle the display between the knobs/sliders and the pushbuttons. If you have assigned MIDI CC#s you will see that the knobs/sliders and the buttons can have different MIDI CC# assignments. To check this function out, create an empty patch, drag only a Sequencer module into the patch and from the ‘rightclick on the module background’ menu choose Assign->PageA->Multicolumn. Then click Assign MIDI. Now click the View Buttons function and the View MIDI function and have a good look to see how things got assigned.

GLOBAL PAGES

This function makes the Parameter Overview window toggle between the assignments made for the Patch in the Slot you’re currently working on, or the assignments that you are making for the Global Parameter Pages assignments.

Note that Global Parameter Pages allows for a mix of assignments from all slots. Global Pages are ideal to use when you are making a Performance which uses several slots. (see also “[Global \(Performance\) Parameter Pages](#)” on page 49)

VIRTUAL KEYBOARD {CTRL-K}

This activates the Virtual Keyboard window. This window can be used to play a Patch



without using the synth keyboard. Click on the keys of the Virtual Keyboard to play single notes. The selected note will be indicated by a black dot on the corresponding key. The note will sustain if you keep the mouse button depressed, just like pressing a key on a real keyboard.

You can expand the keyboard to cover the whole MIDI note range simply by placing the cursor on either side of the window frame. When the double-arrow appears, click-drag horizontally to desired size. You can also show/hide the button bar by resizing the Virtual Keyboard window.

The four buttons to the left are used to scroll up and down the keyboard, either one octave (the double-arrow buttons) or one note (the single-arrow buttons) at a time.

Click on the 'Drone' button to make the next played note start sounding "infinitely". Click the Drone button again to disengage.

Click on the 'Repeat' button to make the last played note play repeatedly. Click the Repeat button again to disengage.

PATCH BROWSER {CTRL-B}

This function activates the Patch Browser floating window. The Patch Browser gives a very good overview of all Patches and Performances currently stored in the internal memory of the connected synth, as well as of Patches and Performances stored on the computer. The Patch and Perf tabs of the Patch Browser are automatically updated as soon as you perform any of the operations described below, even if they are done from the synth's front panel. The Patch Browser can be used to save and load Patches and Performances both from disk and the internal memory of the synth.

There are three tabs in the Patch Browser window:

DISK

Click on the Disk tab to view folders and Patch/Performance files stored on the computer. Double-click on a folder to step down one level in the hierarchy. Click the "arrow up" button to the upper right corner to step up one level in the hierarchy. Click the refresh (double arrows) button to rescan disks and/or folders to update the Disk tab contents list.

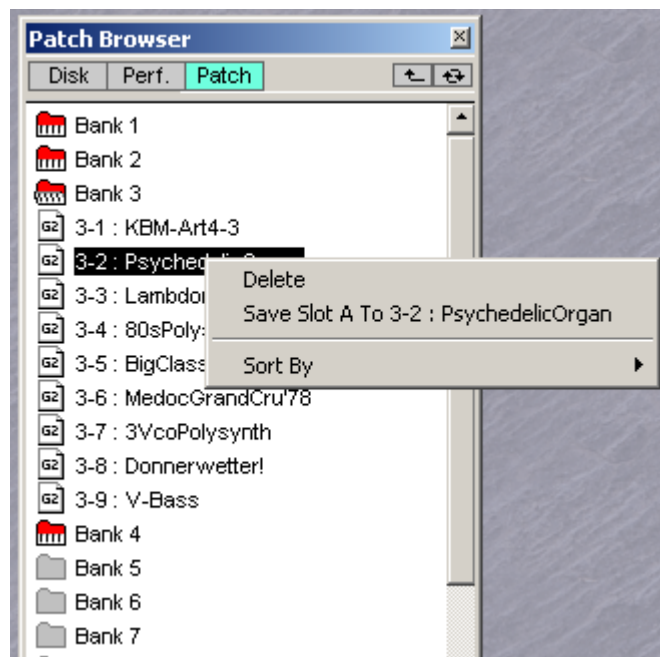

To load a Patch or Performance to active Slot(s):

Double-click on a Patch or Performance file to automatically load the Patch/Performance to the active Slot(s) in the synth and open up the Patch/Performance in the Editor Patch window. This is the same as using File|Open. You can also use the Up and Down arrow keys to select Patch/Performance and load by pressing Enter.

To load Patch or Performance to Slot or store in internal memory:

By right-clicking on a Patch in the Disk tab you can choose to either load the selected Patch to any of the Slots of the connected synth and open the Patch in the Editor Patch window, or to save the selected Patch in an internal memory location. The last function is exactly the same as storing a Patch using the **STORE** button and the **ROTARY DIAL** on the Nord Modular **G2** front panel (see [“Store a Patch” on page 40](#)).

PATCH

Click on the Patch tab to view Patch Banks and Patches stored in the internal memory of the connected synth.

Load a Patch to active Slot:

Double-click on a Patch to automatically load the Patch to the active Slot in the synthesizer and open up the Patch in the Editor Patch window. This function is exactly the same as loading a Patch using the **PATCH LOAD** button and the **ROTARY DIAL** on the Nord Modular **G2** front panel (see [“Sound Functions section” on page 33](#)). You can also use the Up and Down arrow keys to select Patch and load by pressing Enter. You can also open and close the content of an entire Bank by clicking the Bank icon or selecting it (with the arrow keys or the mouse) and pressing Enter.

Store or delete Patch from internal memory:

By right-clicking on a Patch in the Patch tab you can choose to either store the Patch of the active Slot in the selected memory location, or to delete the selected Patch from its memory location.

Store Patch of active Slot to a selected bank:

By right-clicking on a Bank icon in the Patch tab you can choose to store the Patch of the active Slot in one of the selected bank's memory locations, or delete the entire Bank with all its Patches, or change Sort Mode.

PERF.

Click on the Perf tab to view Performance Banks and Performances stored in the internal memory of the connected synth.

Load a PERFORMANCE:

Double-click on a Performance to automatically load the Performance to the Slots in the synthesizer and open up the Performance in the Editor. This function is exactly the same as loading a Performance using the **PATCH LOAD** button and the **ROTARY DIAL** on the Nord Modular **G2** front panel (see [“Load a new Performance from the internal memory” on page 48](#)). You can also use the Up and Down arrow keys to select Performance and load by pressing Enter. You can also open and close the content of an entire Bank by clicking the Bank icon or selecting it (with the arrow keys or the mouse) and pressing Enter.

Store or delete PERFORMANCE from internal memory:

By right-clicking on a Performance in the Performance tab you can choose to either store the Performance of the active Slots in the selected memory location, or to delete the selected Performance from its memory location, or change Sort Mode.

Store Performance of active Slot to a selected Bank:

By right-clicking on a Bank icon in the Performance tab you can choose to store the Performance of the active Slots in one of the selected Bank's memory locations, or delete the entire Bank with all its Performance, or change Sort Mode.

BANK ICONS IN THE PERF. AND PATCH TABS

By right-clicking a Bank icon in the Perf. or Patch tabs you can choose to either store the Patch or Performance of the active Slot(s) to any of the selected Bank's memory locations, delete all Patches or Performances of the entire Bank from the internal memory of the synth, or change Sort Mode for the Patches/Performances of the entire internal memory of the synth.

ASSIGN MIDI TO SELECTION

It's possible to automatically assign MIDI CC# controllers to all parameters of selected modules. Select the modules you want to assign MIDI CC# controllers to, select Assign MIDI to Selection. Now, all parameters of the selected modules will be automatically assigned to MIDI CC# controller numbers. See also the chapter [“MIDI Controllers” on page 143](#).

DEASSIGN MIDI TO SELECTION

If you want to deassign MIDI CC# controllers of specific modules, select the modules and choose Deassign MIDI Controllers. See also the chapter [“MIDI Controllers” on page 143](#).

DEASSIGN ALL MIDI

This function will deassign *all* ASSIGNED MIDI CC# controllers in a patch.

Tip: If you hit this item by accident, immediately use the Undo function (Ctrl-Z on a PC keyboard), to avoid having to make all assignments again later. See also the chapter [“MIDI Controllers” on page 143](#).

EXTENDED TOOLBAR {CTRL-T}

Select whether to show or hide the lower part of the Toolbar.

WINDOW MENU

CLOSE {CTRL-W}

Closes the current Patch window. Closing a Patch in the Editor will not affect Patches in the synth.

CLOSE ALL

Closes all the Patch windows. Closing a Patch in the Editor will not affect Patches in the synth.

CASCADE

Arrange multiple Patch windows in a cascaded configuration.

TILE HORIZONTALLY

Arrange multiple Patch windows in a horizontally tiled configuration.

TILE VERTICALLY

Arrange multiple Patch windows in a vertically tiled configuration.

TILE ACTIVE SLOTS {CTRL-I}

Arrange the Patch windows of the currently active Slots in the connected synth.

TILE ALL SLOTS

Arrange the Patch windows of all four Slots in the connected synth.

CURRENTLY OPEN PATCHES/PERFORMANCES

Here, all Patches and Performances that are open in the Editor are shown. You can select any of the open Patches/Performances by clicking on them. Note that selecting an open Patch or Performance from this list automatically makes it active in the synthesizer.

HELP MENU**CONTENTS/SEARCH/INDEX**

This will launch the **G2** Help file and display the sections Contents, Search or Index.

If you right-click on a module or a parameter in the Patch window, you can bring up the help text for individual modules by choosing Help from the popup menu (see “[Module popup](#)” on page 69 and “[Parameter popup](#)” on page 70). Putting a module or parameter in focus and pressing the function key F1 will bring up the help text for that specific module.

KEYBOARD SHORTCUTS

Launches the Keyboard Shortcuts section of the **G2** Help file.

ABOUT

Displays a copyright note, tells you about Clavia and informs you about the Editor version.

COMPUTER KEYBOARD SHORTCUTS

Any commands that can be launched from the computer keyboard are shown next to the command/function name in the menu drop-down lists. In addition to these keyboard commands there are a number of *special functions short-cut keys*.

A list of the special function short-cut keys is printed on the next pages.

Short-cut Key	'Special function'
Escape	Abort Mouse Dragging Operations
Delete	Delete Selected Modules
Keys 1 to 8 (numerals)	Select Variation #
F	Show FX Area or revert to previous view
V	Show Voice Area or revert to previous view
Arrow Up	Increase value of focused Parameter by one tick
Arrow Dn	Decrease value of focused Parameter by one tick
Arrow Left	Set focus to Previous Parameter on a Module
Arrow Right	Set focus to Next Parameter on a Module
Ctrl + Arrow Up	Increase Morph Range on Focused Param
Ctrl + Arrow Dn	Decrease Morph Range on Focused Param
Ctrl + Arrow Left	Set focus to Previous Parameter (same as Arrow Left)
Ctrl + Arrow Right	Set focus to Next Parameter (same as Arrow Right)
Shift + Arrow Up	Select Next Module Up
Shift + Arrow Dn	Select Next Module Down
Shift + Arrow Left	Select Next Module Left
Shift + Arrow Right	Select Next Module Right
Space	Show/Hide Cables (toggling between Show and Hide)
Ctrl + Space	Shake Cables
A	Select Slot A (if Slot is Active)
B	Select Slot B (if Slot is Active)
C	Select Slot C (if Slot is Active)
D	Select Slot D (if Slot is Active)
L	Assign focused Parameter to Last Received MIDI CC# (= MIDI LEARN)
M	Open MIDI CC# Assign Dialog for the focused Parameter
R	Toggle Master Clock (=RUN/STOP & can send MIDI START/STOP from G2)
F5	View Parameter Values (as yellow popup boxes)
F6	View Morph Groups (as yellow popup boxes)
F7	View Knob Assignments (as yellow popup boxes)
F8	View MIDI CC# Assignments (as yellow popup boxes)
Ctrl + F8	View Parameter MIDI Values (how knobs are sent or received by MIDI CC#s)
Tab	Select Next Module Group Selector in Module Toolbox
Shift + Tab	Select Previous Module Group Selector in Module Toolbox
> or .	Select Next Module in Module Toolbox
< or ,	Select Previous Module in Module Toolbox

Short-cut Key	'Special function'
Return	Add focused Module in Module Toolbox to the edited Patch
Ctrl + A	Select all Modules in currently focused Patch Area
Ctrl + B	Show or hide the Patch Browser
Ctrl + C	Copy selected items
Ctrl + D	Download Patch in active Window to Slot
Ctrl + E	Paste Parameters of last copied selection to current selection (if matching!)
Ctrl + F	Show or hide Parameter Pages window
Ctrl + G	Show or hide Synth Settings window
Ctrl + H	Macintosh-only OSX system function (= hide application)
Ctrl + I	Tile windows of currently Active Slots
Ctrl + J	Show or hide the Textpad window
Ctrl + K	Show or hide the Virtual Keyboard
Ctrl + L	Show or hide the Parameter Overview window
Ctrl + M	Send Controller Snapshot
Ctrl + N	New Empty Patch, clear focused Slot and Patch window
Ctrl + O	Show Open dialog box
Ctrl + P	Show or hide the Patch Settings window
Ctrl + Q	Quit the Editor program
Ctrl + R	Show or hide the Performance Settings window
Ctrl + S	Save Patch or Performance to disk, or show Save dialog box
Ctrl + T	Show or hide the Extended Toolbar
Ctrl + U	Upload Active Slot from the G2
Ctrl + V	Paste selection
Ctrl + W	Close current Patch window
Ctrl + X	Cut selection
Ctrl + Y	Redo last Undo
Ctrl + Z	Undo last action (there are many levels of Undo in the Editor software)
Ctrl + 1	Dump One (= dump patch as SysEx to the MIDI OUT connector)

10. TECHNICAL REFERENCE

SIGNAL TYPES IN A PATCH

DEFINITIONS

Just as in a traditional analog system, modules and parameters in Nord Modular **G2** interact with each other by means of signals being connected from one place to another using a *patch cable* or *patch cord*. The Patch cables are simply drawn with the mouse by clicking on a module output and dragging the mouse to another module's input while holding the mouse button down during the dragging. In a typical analog system, the signals running through the patch cables are represented by alternating voltages ranging from e.g. -10 to +10 volts. The signal levels in the Nord Modular **G2** system are instead represented by **UNITS**, where a value of +1 unit corresponds to a half note upwards transposition on a Pitch input on a module. *These units have nothing to do with the internal resolution of the Nord Modular G2 system, which is 24-bit, but units are used to easily indicate signal levels in the system.* The Nord Modular **G2** uses three types of signals in its Patches:

- bipolar signals (-64 to +64 units)
- unipolar signals (0 to +64 units or sometimes 0 to -64 units)
- logic or *gate* signals (either 0 units for LOW or +64 units for HIGH)

The illustration to the right shows the levels and the polarity of the signals from the keyboard, an LFO, an envelope, an audio signal and a logic signal.

The LFO signal in the illustration is an example of a bipolar modulation signal. Musically this means that this LFO signal can make an Oscillator pitch swing higher and lower around its default pitch setting. Note that the G2 keyboard also produces a bipolar signal. The key E4 (MIDI note number 64) represents 0 units in the Nord Modular **G2** system and each increment of 1 unit means a pitch increment of a half note up the keyboard, and a decrement of 1 unit plays a half note down.

Envelope generators typically produce a unipolar signal to control a loudness contour. This is logical as volume is only positive, there is no such thing as negative volume or 'anti-volume' in nature. So, an envelope signal will typically only modulate in one direction. However, on the **G2** envelope generators, the envelope *control* signal output can be set to either unipolar, negative unipolar or bipolar with a scroll button. For the simple reason that envelope control signals are used to modulate more than just a loudness contour, e.g. sweep a filter.

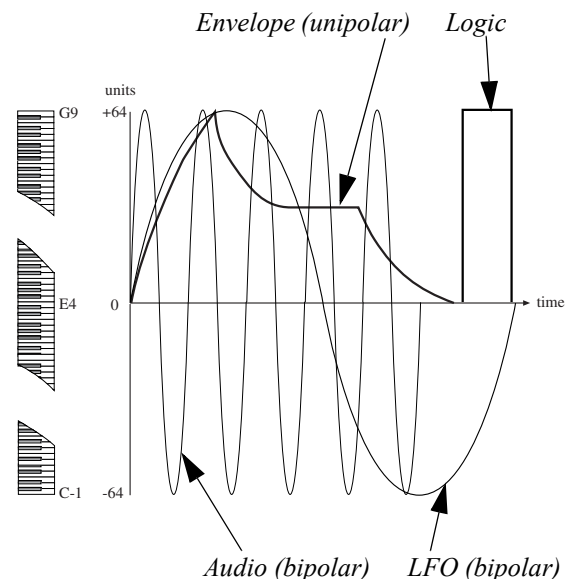

The Clock generator is an example of a module which sends logic signals. A logic signal is in essence a unipolar control signal, but a logic output on a module can produce two possible values only (named *states*): LOW (0 units) and HIGH (+64 units).

The types of output signals of each module in the Nord Modular **G2** are described in this manual using the definitions: **bipolar**, **unipolar** and **logic**.

AUDIO SIGNALS, RED CONNECTORS

Audio signals are bipolar as described above and are sent from *red outputs*. The audio signals in the Nord Modular **G2** are 24-bit at 96 kHz sampling frequency for extremely high quality, and they have highest priority in the Sound engine. Note that the **G2** is designed in a way that it will never drop not even a single audio sample at its 96kHz sample rate. Audio connectors are distinguished by the red color. Do not let the description “audio” stop you from experimenting with these signals. They can be used to modulate things too. You can, for example, patch the red audio output from an oscillator to a blue Pitch input of another oscillator.

CONTROL SIGNALS, BLUE CONNECTORS

Control signals are sent from the *blue outputs* on envelope generators, LFOs, the keyboard, sequencers etc. The control signals can be either unipolar or bipolar, which defines whether a modulation will sweep in only one direction, e.g. only upwards, or swing both upwards and downwards. Control signals are used to control or modulate parameters in a Patch. The control signals are 24-bit at 24 kHz sampling frequency, i.e. a quarter of the audio signal bandwidth. This is because they are often low-frequency signals by nature, and do not require a high bandwidth. The control signal connectors are distinguished by the blue color. Still, the 24kHz sample rate on blue module outputs is high enough for the blue signals to be used as audio signals, although sonically they will have a slightly ‘LoFi’ character. Many modules have blue input and output connectors by default, e.g. all mixer modules. Connecting a red signal to a blue input will change all the inputs and outputs of most blue modules to a red color and the modules will change to work at the 96kHz audio sample rate.

LOGIC OR GATE SIGNALS, YELLOW AND ORANGE CONNECTORS

Logic or Gate signals are mainly used to clock, trigger or gate *musical events*, like signalling that a key is pressed on the keyboard and a new note must be played. Or telling a sequencer that it must advance to the next step in the sequenced pattern.

Gate signals have two possible levels, LOW (0 units) or HIGH (+64 units). Amongst musicians the names Gate and Trigger signal are commonly used for the signals that cause a new note to be played. But these signals can be used for many other purposes as well, and can be processed in ways similar to the mixing and processing of audio and modulation signals. The names *Logic* and *combining* are used when processing signals that can only be HIGH or LOW, just like the name *mixing* is used when audio signals are added together.

Gate and Trigger signals are good examples for Logic signals. So, if in the rest of this manual there is a reference to Logic signals, simply remember the common keyboard Gate signal and how it can be HIGH or LOW and set other things in motion. And read Gate or Trigger instead of Logic, if this makes things more clear to you.

LOGIC OUTPUTS

Logic signals are sent from *yellow or orange outputs*. The Logic signals can use either 24 kHz (yellow) or 96 kHz (orange) bandwidth depending on application and actually do use the 24-bit resolution, meaning that they can be scaled down to an ‘analog’ value by e.g. a mixer. Logic signal output connectors are distinguished by the yellow or orange color, which means that a yellow or orange output can only produce

either a low level of 0 units or a high level of +64 units. When a red signal is connected to a module with a yellow input, a yellow output connector on that module often changes to orange (and the blue outputs to red), which indicates that the module will now use the 96 kHz bandwidth inherited from the red signal on its input.

The moment when a Logic signal switches from LOW to HIGH (= 0 units to +64 units) is named the *positive edge* or positive flank. When the Logic signal changes back to LOW units again, is named the *negative edge* or negative flank. The Logic inputs on the **G2** modules can react to an incoming signal in three different ways. These are easily recognized by either an **ARROW** or a **BARRED ARROW** symbol next to the input, or by the *absence* of such a symbol.

LOGIC INPUTS

A Logic input that responds to the HIGH or LOW *level* or *state* of the Logic signal looks like a standard round input connector without any symbol next to its name. A typical example is the Gate input on an Envelope module. Several modules with Logic inputs have an associated green indication light in the Editor screen that lights up to show whether the signal on the input is currently processed as a LOW signal or as a HIGH signal.



Please note that even though the input responds to the *state* of the Gate signal, the response can be subtly different for the positive and the negative edges. An example is when the Gate input on the ADSR envelope generator receives a Logic signal from another module. The positive edge of the Logic signal will "start" the envelope. Then, while the Logic signal stays HIGH the envelope is 'sustained', and when at the negative edge the Logic signal switches back to LOW again the envelope is 'released'.

A Logic input that reacts only to the *positive edge* has an **arrow**, pointing upwards, next to it. This positive edge is often named a *trigger* or a *clock pulse*. This is a typical behaviour of a clock input on a Sequencer, a Sample & Hold or a Clock Divider module. This type of input is only interested in the *exact moment* a logic signal *changes* from LOW to HIGH. Keep in mind that a trigger is always used to *flag some change on an exact moment in time*. The advantage of triggering is that it can force something to happen right on the beat.



There are some Logic inputs that will react to the positive edge of a Logic signal, but will delay their action until a clock signal on another Clk input is coming into the module as well. These inputs have a **barred arrow** symbol next to them. A barred arrow looks like an arrow pointing upwards towards a horizontal bar (line). The Rst input on the various sequencer modules is an example of this. When a Rst input receives a positive edge it will *prepare* the module to *restart on the next Clk pulse*. This will cause the restart of the sequencer to happen right on the beat. This behaviour is sometimes named *delayed logic*, as there is small time-delay involved to make sure that all happens in sync to the beat.



A logic input with a barred arrow signal *always* needs another logic input with a plain arrow, and will synchronize its effect to the input with the plain arrow.

The different behavior of the logic inputs is in general considered to be a difficult subject. To fully understand the subtle difference you need to experiment with these signals and closely observe how they react. After some time you will develop a feel on how to use these inputs. When making complex sequencer patches it is important to build and check them *brick by brick*. This makes it easier to keep some overview and control over the timing of the gate and trigger signals that will sequence the note and modulation patterns.

WHAT HAPPENS WHEN CONNECTING A RED OR BLUE SIGNAL TO A LOGIC INPUT.

It is possible to connect any type of signal to the logic inputs. The output of a LFO, for instance, can be a good clock source for a sequencer module or could be used to start envelopes. A logic input *interprets* any signal with a *level of 0 units or less* as a LOW or OFF signal and any signal with a *level greater than 0 units* as a HIGH or ON signal. A *trigger* or positive edge is the moment when the LFO signal *crosses the zero line upwards* from a value of 0 units or less to any positive value.

BANDWIDTH CONSIDERATIONS

The two different red/orange and blue/yellow signal bandwidths of 96 kHz and 24 kHz in the Nord Modular **G2** are important to keep in mind. You can Patch a red audio output to a blue control input and vice versa. Since the output of an LFO is a control signal, updated at the quarter speed of a red audio signal, the quality of a signal generated by a LFO might not be good enough for you to be used as an audio signal. If high audio quality is important in a Patch, always use oscillators as audio signal generators. The LFOs can, however, provide excellent signals to be used as frequency modulators in an FM-type Patch or provide for LoFi effects.

RESOLUTION AND AUDIO SIGNAL HEADROOM

The resolution in the Nord Modular **G2** system is 24 bits to ensure a supreme audio quality. The headroom of the audio signals in Nord Modular **G2** is -12 dB for every sound source (Oscillator). This means that you can safely mix up to 4 sound sources in a mixer, when mixing more sound sources attenuate the level of the sound sources on the mixer module, e.g. by using the Pad button on a multi-input mixer.

Output modules have an extra 6 dB headroom per bus.

If your sound hits the headroom limit (which might soundslike crackling or clicking) you need to determine where in the signal flow this is caused. *If the FX area is used*, set the Pad control on the FX-In module to -6dB and the Pad button on the Output module in the FX-Area to +6dB. This will increase the headroom limit by 6dB, but still keep the overall sound level equal. Then try to lower the Patch Gain level on the top of the Patch window to give some extra overall output headroom. If you still have headroom issues, lower the input signals to the mixers in the Voice Area of the Patch. Some modules have settings that can easily lead to clipping, like the GC controls on some Filter modules, keep the GC buttons On when using high resonance settings on the filters. One more tip is to use a 6dB highpass filter set to 40 Hz to 80 Hz just before an Output module in a voice. This will prevent possible level-offsets in the audio signal to push the audio towards the headroom limits.

SELF-OPTIMIZING MODULES

A lot of modules in the Nord Modular **G2** system are self-optimizing. This means they automatically adapt their Patch Load according to which connectors are being used and to the bandwidth of the incoming signal(s). All Mixers, for example, default to blue (control signal) inputs and outputs. If you connect only blue and yellow control signals to a Mixer, the inputs and outputs will remain blue and the Mixer will use less Patch Load - enabling for larger Patches or more polyphony. However, if you connect a red (audio signal) cable to a Mixer input, all inputs and outputs will automatically “update” to audio bandwidth for maximum signal quality. This is indicated on the module by the inputs and/or outputs changing color.

NOTE! Another advantage of the self-optimizing modules is that most *unconnected* inputs do not use any Patch Load at all. This is another important **G2** feature to enable more polyphony.

EXPERIMENT!

You can always try to Patch the three different types of signals to wherever you want. You may run into situations where the result of a connection will not be what you expected, but that is part of the charm of any modular system. A blue control signal output can be very useful for modulating a yellow logic signal input, and an audio signal output can certainly produce interesting results connected to a control signal input or a logic signal input. The colors are only there to help you identify the various signal types, not to restrict you in any experiments.

VOICE ALLOCATION AND POLYPHONY

The **G2** system uses DSP-chips to generate the sound. These chips are computer chips specialized in doing the type of calculations used in sound synthesis. DSP-chips work like computer processor chips in a way that they can do only one calculation instruction at a time, like a multiplication instruction (e.g. used for the down scaling function of a knob) or an addition instruction (e.g. used for mixing two signals). Basically all modules and cable connections in each voice appear internally as a piece of DSP programming code that needs to be executed to actually generate sound. This piece of code is a string of DSP instructions that are executed one after another. For every output sample of the **G2**, and there are 96 thousand samples a second, the piece of code for each voice needs to be executed completely. The more modules there are and the more complex each module, the more instructions will be needed and the longer it will take to execute the piece of code. There is a limit to the total amount of instructions that can be executed in the available time. The amount of instructions within the piece of code for one voice determines the available polyphony, or how much time is left for execution of code for more voices. When the piece of code is short it can be executed many times within the time frame of one output sample, so there can be many voices. But if the piece of code is very long there might not be the time to execute it for a lot of voices, so polyphony will drop to what just *fits fully* in the available time. The **G2** has four DSP-chips or eight chips with the expansion board fitted and in the **G2X** model. The DSP-chips work in parallel, meaning that if one voice takes all the resources of one DSP the polyphony would be four voices, or eight voices with an expansion board. Note that a single voice cannot exceed the code that fits in one DSP-chip. The FX Area can also use up to one DSP, and if this is the case the minimum polyphony is three voices plus effects or seven voices plus effects in an expanded or **G2X** model. The Patch Load indication shows the percentage of available calculation time claimed by one voice. In practice the average polysynth voice can be modelled within 25% to 33%, and a 'luxury' polysynth model with more than two oscillators within 50%. When a voice uses 100% you can be sure that only a single key could give a truly massive sound, but at a price of limited polyphony. These 25%, 33% and 50% are 'magic numbers' when it comes to setting the amount of polyphony, as these are the percentages where the system will suddenly drop voice count. E.g. when in a patch the Patch Load percentage is increased from 33% to 34% the polyphony will drop from 12 to 8 voices on an unexpanded system (3 times 34% does just not fit fully into 100% any more).

The Memory display indicates the memory which is used directly by a DSP-chip. The DSP-chip can access two types of memory, internal memory in the DSP-chip itself and 256 kWord of 24-bit RAM memory. The internal memory is used to store the output values of each module in a patch. The DSP-chip has room to store over a hundred module output values and this also sets a limit on polyphony. E.g. when a patch uses about 40 outputs on its modules the internal DSP memory load is just under 33% and this would allow 12 voices or 24 voices on an expanded system or on the **G2X** model. Even if the Patch Load is e.g. 24% the used memory of 33% would set the polyphony limit in this example. To get an idea of the possible polyphony, always look at which display shows the highest value, the Patch Load or the Memory display. The one with the highest value will set the limit. When the Memory percentage exceeds the Patch Load percentage and you need to save just one percent of memory to be able to increase voice count, try to use modules with less outputs. E.g. try to use an ADSR module instead of an ADR module, as the

extra End output on the ADR module takes an extra 0.8% of Memory. Also try to use Morph groups, e.g. use the Velocity Morph, instead of the Keyboard module if the Keyboard module is only used for its Velocity output.

The internal DSP memory is also used by each 'module group', e.g. when you place the first LFO in a patch you will see that it uses a rather large amount of memory, but the next LFO module will only use a little memory. The reason is that some modules in a specific module group need to 'talk to each other' between voices, e.g. take a look at the Poly/Mono button on the LFO's. To be able to use this function the voices need to share some internal DSP memory to share one global LFO between the voices when in Mono mode.

The RAM memory is used for audio delay-line effects, the reverb module and assorted effects and modules that need memory to dynamically hold a larger amount of sound. If the first voice uses 25% of this RAM memory in the Voice Area the second voice has to use another 25%, as else the memorized audio in the two voices would get in conflict when stored in the same physical memory area (the two voices probably use different audio signals). To make the explanation of the memory display even more complex, the display shows either the internal DSP-chip memory or the RAM memory, depending on which one is the biggest value. This means that it is uncertain which memory is actually shown. But in practice this doesn't matter as it is only the biggest percentage that will set the limit on polyphony. So, what works very simple in practice is just very difficult to explain how it technically works.

You don't need to understand all this technical babble to work with the **G2** system, the internal **G2** uses an intelligent optimizing algorithm to find the most efficient way to use the DSP and memory resources. But what you do need to understand when creating new patches is that it is the 'magic numbers' like 20%, 25%, 33% and 50% that are very important in defining the polyphony and it is always the biggest number in the displays that counts. Remember that when it is about polyphony, the **G2** system simply works very different to other 'fixed patch' synthesizers that have a fixed polyphony. On the **G2** the polyphony depends purely on the complexity of the sound as the DSP programming code is different for each Patch. On a fixed patch system the DSP programming code would be the same for every sound, so it will have a predictable amount of polyphony that simply never changes. But not so on the **G2** system, as it gets totally reprogrammed every time a patch is loaded in a Slot or a new patch is created. This actually works to your advantage in two ways; very simple patches will give relatively more polyphony than other systems, but the **G2** also allows for very big and complex patches that simply can not be done on other synths, but with a relatively low polyphony.

CALCULATION ORDER FOR THE MODULES

As mentioned in the previous paragraphs the DSP-chips can do only one calculation at a time. This means that the modules are processed in serial order, one after another. In cases this order can be an issue, e.g. when there are two parallel module chains where these chains share the same source signal and are mixed together at their ends, a one sample delay (latency) in one of the chains could affect the sound. The **G2** uses an intelligent 'back-tracing' algorithm to define the order in which modules are calculated. This algorithm first identifies signal sources, like the outputs of oscillators. Starting at these sources it traces the cabling connections and uses this information to set the calculation order for the modules. This guarantees that there are no latency problems in parallel chains of modules. When multiple feedback connections are made it might become obscure how the processing chain can be traced, e.g. which feedback connection chain should be calculated first. In this case the order in which the modules are placed on the screen is taken into account, first from top to bottom and then from left to right, and the screen order will determine which feedback chain is calculated first.

1 1. UPDATING THE SYNTH OS

Note! If you received a brand new Nord Modular G2 or G2 Engine, the latest operating system is already installed from factory. If so, there is no need to update the synth.

If you need to update the OS in the synth, do like this:

1. Make sure the **USB Driver and Editor** are properly installed as described earlier in this chapter.
2. Power on the **G2** synth and connect the **USB** cable between the synth and computer.
3. Make sure the **G2 Editor** is **NOT** running.
4. Open the ‘Modular Synth Updater’ in the Programs | Nord Modular **G2** folder in the Start menu of the computer and click the Update button to complete the OS update. As the update proceeds, the different stages are shown in plain text in the **G2** Main Display. On the **G2** Engine, the different LEDs show the status of the update according to the following:



*1. Receiving new OS via USB:
MIDI LED is blinking slowly.
USB LED is flashing*



*2. Erasing old OS and storing new OS in memory:
MIDI LED and USB LED are flashing alternating.*



*3. Starting new OS and reverting to normal operation:
Both LEDs go off and then the USB LED is lit until you quit the Synth Updater program.*

5. When the **G2** synth has started up with the new OS you can exit the Synth Updater program and start the **G2** Editor.

Note! If the Synth Updater program shouldn't recognize the connected **G2** synth for some reason, even though the **USB Driver** has been properly installed, you may have to enter Update Mode manually in the synth. On the Nord Modular **G2**, hold the **STORE+PERFORMANCE MODE** buttons and power on the synth.



On the **G2** Engine, press the “hidden” button inside the hole to the right of the **G2** logotype and power on the synth. First, the **MIDI** LED lights up, then the **USB** LED lights up and finally both LEDs light up. Then, both LEDs go off and the synth goes into “Update Mode” as indicated by the slowly blinking **MIDI** LED. Now, you can run the Synth Updater program as described above.



Update Mode button

12. MIDI IMPLEMENTATION

WHAT IS MIDI?

MIDI is an acronym for Musical Instrument Digital Interface, which is a music industry wide standard to connect electronic musical instruments. By using MIDI one instrument can play another instrument, no matter the brand or model for the two instruments. MIDI is a combination of a hardware connection and a set of software commands sent over the hardware connection. In essence MIDI is a one way connection, but most instruments have two or three connectors, a MIDI IN, a MIDI OUT and optionally a MIDI THRU connector. If one instrument needs to play another instrument the MIDI OUT connector of the first instrument must be connected to the MIDI IN connector of the instrument to be played by the first instrument. If an instrument has both a MIDI IN and a MIDI OUT connector it can in essence play another instrument and be played from the other instrument. The MIDI THRU connector is used to chain more than two instruments and simply passes on what comes in on the MIDI IN connector.

There are eight groups of software commands that can be sent over MIDI. These command groups are:

NoteOff	used to silence a playing note
NoteOn	used to play a note
Poly Key Pressure	used to apply key pressure of individual keys (very rarely implemented)
Control Change	used to signal changes in a panelknob or play controller like a modwheel
Program Change	used to change to another sound or patch
Channel Pressure	used to apply global key pressure (like on the G2)
Pitchwheel Change	used to apply changes in the Pitchstick position
System Commands	used to send global or instrument specific information

MIDI MODULES

The **G2** system offers MIDI modules to send and receive NoteOn/NoteOff commands, Control Change (or MIDI CC#) commands and Program Change commands. The data that will be embedded in these commands can come from signals generated by other modules, like LFO modules, sequencer modules, etc. By using MIDI OUT modules in a patch other MIDI instruments can be controlled, sequenced and modulated directly with signals generated within the Patch. Of course it is up to you to send commands and data that will make the other instrument do sensible things.

SYSTEM COMMANDS

In the System Commands group are the global information commands that keep timing by sending MIDI CLOCK, MIDI START and MIDI STOP commands. When the **G2** is set to sending MIDI CLOCK these commands are used by the Master Clock control and the Run/Stop button on the **G2** frontpanel.

Note that the **G2** frontpanel Run/Stop button can be emulated on the G2 Engine by sending MIDI CC#80 to the **G2** on the *Global MIDI channel*. Use a value of 0 or 127 to stop or start the MIDI CLOCK. After reception of MIDI CC#80 on the Global MIDI channel, MIDI START or MIDI STOP commands will be relayed to the **MIDI OUT** connector on the back of the **G2**. See also [“MIDI Global Channel” on page 142](#).

SYSTEM EXCLUSIVE COMMANDS

A special subgroup in the System Command group are the System Exclusive or SYSEX commands. In a SYSEX command instrument specific information can be embedded. An example of a SYSEX command is a patch dump or performance dump, where a complete patch or performance is embedded in the

command. SYSEX can also be used to send intelligent commands, like a command to ask a **G2** to dump the current values of all assigned MIDI CC#'s in a patch or performance. A SYSEX command for a **G2** system specific function has three identification tags, the Clavia identification tag, the **G2** system identification tag and an extra device identification tag. The Clavia and **G2** tags are fixed. The identification tag can be set by you in the **G2** System menu under the header of MIDI SYSEX ID. The tag value can be 1 to 16, or All (which means undefined). If a SYSEX command is received your **G2** will only listen to it if the device identification tag in the SYSEX command is equal to the MIDI SYSEX ID tag set on your instrument or if the **G2** is set to All. If it is not equal, the SYSEX command will be ignored by your instrument. This allows for a setup of sixteen **G2** synths that can each receive their own SYSEX commands, e.g. to receive different patch or performance dumps. See also “[Synth Settings {Ctrl-G}](#)” on page 120.

MIDI GLOBAL CHANNEL

In the Synth Settings window is a setting for the MIDI Global Channel. This MIDI Global Channel affects the processing of MIDI commands received on the MIDI IN connector. The MIDI Global Channel is very important when using the Performance features of the G2.

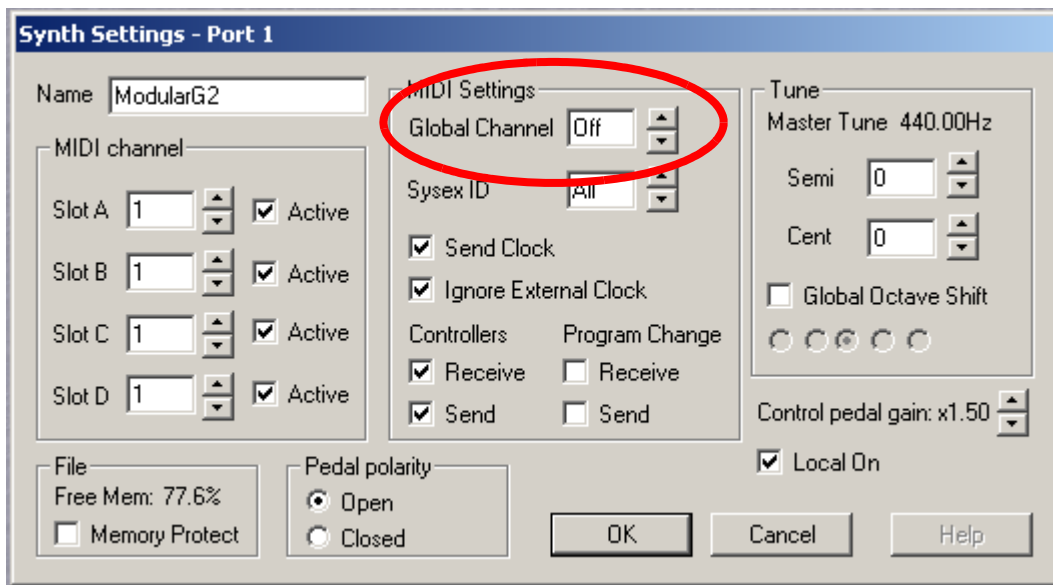

All MIDI messages received on the MIDI Global Channel will be processed like if these messages came from the keyboard. This means that if you are in Performance Mode and keyboard splits and layers are set for the Slots, a received note on the MIDI Global Channel makes the G2 behave exactly the same like pressing a key on the keyboard. Meaning that in this case a single MIDI Note On command can actually play sounds in up to four Slots at once. No matter the MIDI channels set for the Slots and depending on which Slots are active and the split and layering settings made in the Performance Settings window.

IMPORTANT! In general the MIDI Global Channel should always be set to a *different* MIDI channel as the channels used by the Slots.

When the G2 receives a Program Change command on the channel set for a Slot, the Slot will load the corresponding Patch from the Patch memory. When the G2 receives a Program Change command on the MIDI Global Channel, it will instead load the corresponding Performance from the Performance memory.

Note that when using a MIDI *master keyboard* to play the G2 in Performance Mode, you would want to set the MIDI master keyboard to send only on the MIDI Global Channel. This will make the master keyboard play the G2 exactly the same like the G2 keyboard does (with the splits, layers, etc.). However, when sequencing the G2 multitimbrally from a MIDI sequencer, you would probably set four tracks to the MIDI channels set for the four Slots, to be able to handle the Slots as fully independent ‘sounds’. In this case, set the MIDI Global Channel to Off to free this MIDI channel for other equipment, *unless* you would want to be able to load other Performances through Program Change commands.

The MIDI Global Channel has preference over a Slot MIDI Channel if they happen to use the same MIDI channel. Meaning that if the MIDI Global Channel is e.g. set to MIDI channel 5 and Slot2 is also set to MIDI channel 5, a Program Change command on MIDI channel 5 would load a Performance (and load *all four* Slots) and not just load a Patch in Slot2 only. This is why it can be quite important to set the MIDI Global Channel to a different MIDI channel as the channels used for the four Slots.

Note that when the MIDI Global Channel is set to Off there is no way to load another Performance through a Program Change command, you will have to use the MIDI Global Channel to do so.

The MIDI Global Channel is mainly used while receiving MIDI messages. The only thing that is actually ever sent on the MIDI Global Channel is a Program Change message when you change Performances. Note that if the MIDI Global Channel is set to Off no Program Change message will be sent when switching Performances in Performance Mode.

Everything else is sent on the Slot Channels including the G2X Global Wheels MIDI CC#s. If there is a layer with two Slots that are set to different MIDI channels, everything is sent on *both* MIDI channels.

Note! When the G2 is shipped from the factory the MIDI Global Channel is set to Off.

MIDI CONTROLLERS

In the Nord Modular **G2**, ‘MIDI continuous controller commands’, or for short MIDI CC#’s, have to be manually or automatically assigned to module parameters separately for each Patch. In other words, there exists no preconfigured MIDI CC# list except for the special parameters described below. Here are some general rules for MIDI CC#:

- The reception and transmission of MIDI CC# can be turned on/off. See “MIDI Ctrl |Sy” on page 31 and “Synth Settings {Ctrl-G}” on page 120.
- All parameters use the entire control range 0-127. For button parameters and for some other parameters the range is divided into equally big “sections” depending on the number of states of the parameter. For example, the Oscillator A waveform selectors can have 6 different “positions” and are therefore divided into 6 equally large sections between the values 0 and 127.

The following MIDI CC# are preassigned and can not be assigned (nor deassigned) by the user:

MIDI CC#	Physical controller or function
0	Bank Select MSB
1	Modwheel
7	Patch Volume
11	Expression Pedal

17	Octave Shift
18	Keyboard Hold
19	Performance/Patch Mode Select. (MIDI CC# 19 is preassigned for <i>Global MIDI channel only</i> and is available for user to assign on all other channels)
32	Bank Select LSB
64	Sustain Pedal
70	Sound Variation
80	G2 MASTERCLOCK/MIDI CLOCK Stop/Run (MIDI CC# 80 emulates the Stop/Run frontpanel button and is preassigned for <i>Global MIDI channel only</i> . It is available for user to assign on all other channels)
96	G2X Global Modwheel 1 (Morph Group 8)
97	G2X Global Modwheel 2 (Morph Group 5)
121	Reset All Controllers
123	All Notes Off

All MIDI CC# in the range 0 - 119, except the ones listed above, are available for user to assign. MIDI CC# 120 - 127 are not available for user to assign.

MIDI AUTOMATION

MIDI automation means to let the **G2** and another MIDI instrument control each other. MIDI automation makes use of a special type of MIDI command, the MIDI Continuous Controller or MIDI CC# command. This command assumes that a unique identification number is assigned to every physical controller on the equipment. This identification number is named the CC#, where the # character means 'number', so CC# can be read out full as 'Continuous Controller Number'. There are 127 CC#'s available in each MIDI channel and there are sixteen MIDI channels on one cable, meaning that in theory some 2000 controllers could be managed through one MIDI cable. In practice there are much less MIDI CC#'s available, as in general an instrument is in one single MIDI channel and often several MIDI CC#'s are already used for functions like switching to another bank of presets and loading sounds from that new bank. On the average instrument some 80 MIDI CC#'s are available to be freely assigned by the user.

The values that a MIDI CC# can send are whole numbers in the range between 0 and up to and including 127. This value is in essence associated with a knob position, the MIDI specification assuming that each knob always has 128 positions. There are some standard MIDI CC# assignments, like MIDI CC#1 for a Modwheel, MIDI CC#2 for a breath controller and MIDI CC#7 for the volume for the sound in the particular MIDI channel. All MIDI equipment has to have these controllers assigned to these MIDI CC#'s, so a Modwheel will always work, no matter the brand of the equipment. But for the freely assignable MIDI CC#'s it is the Wild West, and you can pretty much do what you like. Note that Pitchbend is not a MIDI CC#, as it is handled by a dedicated pitchbend MIDI command.

The **G2** editor tries to make assigning MIDI CC#'s as light and easy as possible. There are a few functions available that work together. These are the MIDI-LEARN function and the ASSIGN MIDI, CLEAR MIDI ASSIGNMENTS and VIEW MIDI functions in the Parameter Overview window. Additionally there is a special MIDIAutomate module that allows for MIDI talkback.

See also “[Dump CC \(Send Controller Snapshot\)](#)” on page 29 and “[MIDI SendCtrl | Pa](#)” on page 31.

MIDI-LEARN FUNCTION (L KEY)

When in the Editor program and right clicking on a knob control in a module, a popup menu appears where settings about the knob control can be made.

Under the menu entry MIDI Controller there is a submenu and at the top of this submenu there is the menu item 'Assign to CC# xx'. The number that is shown is the last MIDI CC# that the **G2** received on its MIDI IN connector or from another Slot. Note that there must at least have been one MIDI CC# value received since the power-up of your **G2** to show this menu item. If this menu item is chosen, the knob will from now on follow the values that are send through this MIDI CC# from another instrument or Slot.

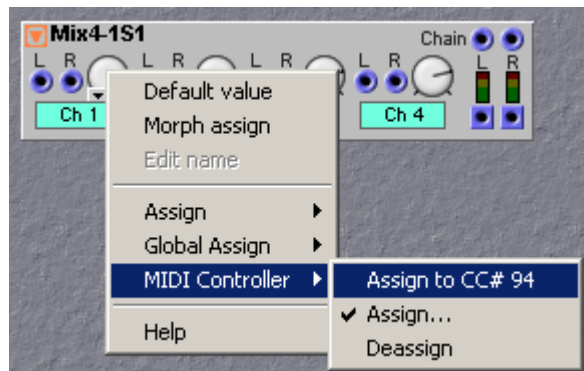

USING THE POPUP-MENU

In practice do the following:

- 1) Make sure the other instrument is in the same MIDI channel as the **G2** slot and the physical knob on the other instrument is indeed sending MIDI CC# values.
- 2) Turn the knob on the other machine that should control the knob in the **G2**.
- 3) Right click on the knob control in the **G2** editor and first check if the Assign to CC# xx menu item indeed shows the MIDI CC# that the other instrument is sending. If so, just click on the menu item and the assignment is made. Turn the knob on the other machine again and the **G2** should immediately update the knob control on the **G2** module. If this works all right, the assignment is properly made and will be saved in the patch when the patch is stored in the **G2** or on the computer.

USING L

Alternatively the keyboard short-cut L can be used. All you have to do here is click on a knob on a module and press L. The last received MIDI CC# will now automatically be assigned to this knob. L is a much faster way of assigning than using the popup-menu. But the popup-menu offers the possibility to check which MIDI CC# will actually be used and so is a more safe way. Note that a MIDI CC# can only be assigned to one single knob in the patch and if L assigns a MIDI CC# to a knob that was already assigned to another knob the other knob will lose its assignment. Which means that you should use L only if you are really sure which MIDI CC# was received last and that it can be safely assigned.

Note that MIDI CC# assignments and panel rotary dial assignments can be made independently. But when a knob on a module is assigned to both a MIDI CC# and a panel rotary dial, turning the rotary dial will also send the MIDI CC# values. And when the **G2** is receiving MIDI CC# values over the MIDI IN connector, it will update the LED collar around the dial and update the value in the panel display to the received MIDI CC# value. So, both MIDI CC# and panel assignments need to be made separately and both can work without the other. But when both assignments have been made they will work together fine.

TROUBLESHOOTING MIDI CC#'s

When the **G2** did not immediately start to follow the knob control after the MIDI-LEARN function is used, you first need to check if the other machine is indeed still sending the MIDI CC# and if the Slot in the **G2** is indeed in the proper MIDI channel. Then check if in the Synth Settings menu in the **G2** editor the Send

and Receive check marks in the Controller section are indeed check marked. It is important to check these settings, especially if you keep your **G2** powered on all the time. As maybe the Assign to CC# xx shows the last MIDI CC# that it received a few days ago before you disabled these check marks for some reason for a project you did then, and forgot to enable these check marks later. If after checking the other instrument and the Synth Settings menu and redoing the MIDI-LEARN function it still does not work how it should, or only appears to work now and then, always check if using another MIDI cable does give exactly the same behavior. Replacing the MIDI cable sounds trivial, but in practice bad MIDI cables are very often the source of trouble. MIDI cables get plugged in and out often and can wear out quickly. Point is that you don't hear them crackling like a bad audio cable would, it is only that MIDI starts to do strange things now and then. A good tip for live performers is to always have some brand-new spare MIDI cables with you. And a bad MIDI cable in the studio can be a headache for weeks.

The MIDI LED on the **G2** hardware can help you while troubleshooting possible MIDI problems. When the MIDI LED lights up shortly it indicates that MIDI signals are actually present on the MIDI IN of the **G2**. If this MIDI data will also be used by the **G2**, e.g. keyboard data in a valid MIDI channel, etc., the MIDI LED will lit up for a longer period of time.

MIDI CC# AUTO ASSIGNMENT FUNCTION

With the MIDI-LEARN function it is possible to conveniently assign MIDI CC#'s one at a time. But sometimes one might want to assign all the panel knobs to MIDI CC#'s in one go. This can be done in the Parameter Overview window. Look at the next picture where four mixer knobs are assigned to four panel knobs.

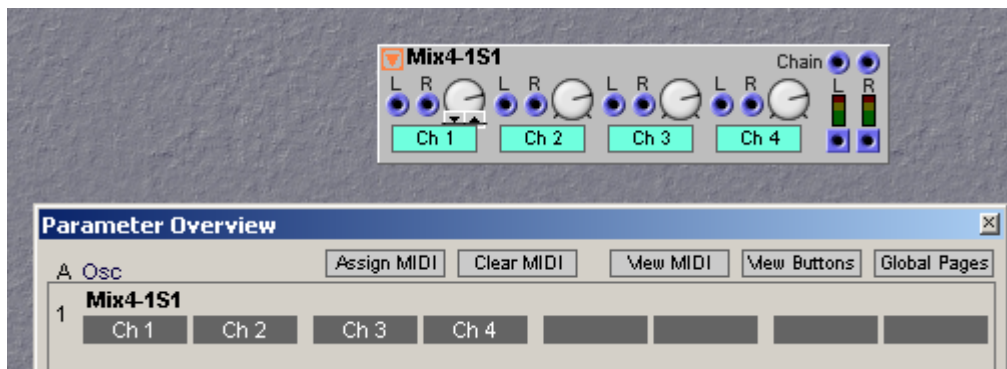

Clicking the Assign MIDI button will auto assign the four panel knobs to the first four available MIDI CC#'s. Next click on View MIDI to see the assignments.

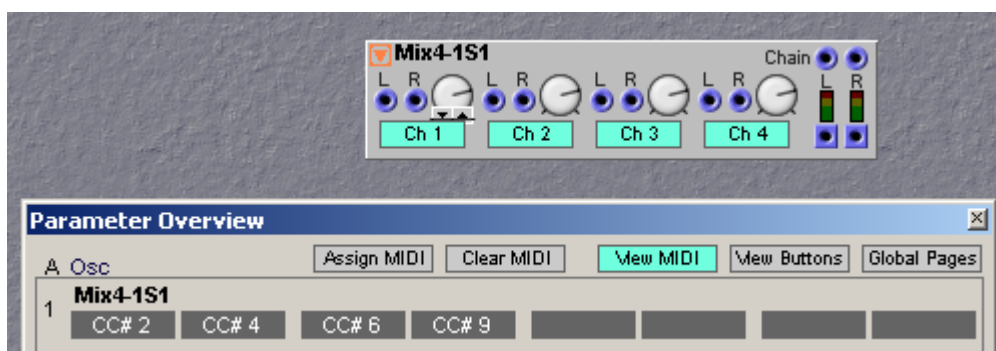

Note that the four Mute buttons on the Mixer module have been assigned to MIDI CC#'s as well, clicking

the View Buttons button will show their assignments.

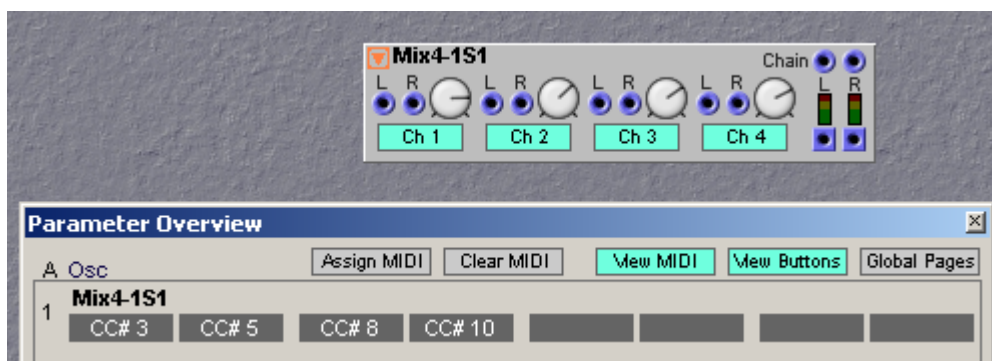

The ASSIGN MIDI auto assign function will only use available MIDI CC#'s. Panel controls that had already been assigned to MIDI CC#'s will of course not be reassigned.

If for some reason you want to deassign all MIDI CC# assignments, use the Clear MIDI button. Note that Clear MIDI is a very dangerous function, it will not ask you if you are really sure you want to do this and it clears the assignments immediately. But don't worry if you hit this button accidentally, immediately use the Undo function in the Edit menu of the editor, or alternatively use Ctrl-Z on the computer keyboard to undo the clearing.

MIDI TALKBACK FUNCTION

MIDI TALKBACK is when two MIDI instruments are connected to each other and MIDI CC#'s are shared with the purpose to control each instrument from the other instrument. Imagine that you want to use the panel controls of the **G2** as a MIDI controller to control another instrument. The ideal situation is when on the other instrument another preset is chosen the **G2** would immediately adjust the LED-collared rotary dials to the proper settings of the preset on the other machine. In this situation the **G2** has to know what happens on the other instrument, meaning that the other instrument has to tell the **G2** its knob settings first. So, the other instrument has to send all its controller values automatically when a new preset is chosen on that instrument. Most recent MIDI equipment and MIDI sequencer programs running on computers will do this, but take note that not all MIDI equipment supports this function. Look in the manual of the other instrument if and how this is supported. If sending the controllers is not done automatically on selecting the preset on the other machine, it is many times possible to do a 'Send All Controllers' or 'Dump Parameters' command on the other instrument to tell the **G2** what the preset values are.

THE G2 AS A MIDI CONTROLLER BOX

Using the **G2** as a MIDI controller is best done by using the Automate module in the MIDI Module Group. This module has the advantage that it can send and receive in a different MIDI channel than the **G2** Slot is actually in. When using a dedicated Automate module for each MIDI CC#, one single Slot can be used to control different other instruments that are in different MIDI channels. Both the Voice area and the FX area of a Slot can hold some hundred modules, meaning that quite a complex MIDI controller setup can be made in one single patch, controlling several other instruments over one MIDI cable.

When professionals set assignments by hand they take notes on paper, as in the future there will come a moment when you have forgotten how and why certain assignments were made in a certain way.

Remember that other equipment is also involved. Your notes on paper will later prove to be invaluable!

G2 MIDI SYSTEM EXCLUSIVE SPECIFICATION

The Nord Modular **G2** supports MIDI SYSEX dump and download of single Patches and Performances over the MIDI IN and MIDI OUT connectors on the backside of the **G2**. With this function you can upload patches or performances directly from a Nord Modular **G2** to a MIDI sequencer device or another Nord Modular **G2**, or receive patches or performance from another MIDI device without having to use the Editor program.

Note that a MIDI SYSEX dump will have another file format than a '.pch2' patch or '.prf2' performance file. Only a MIDI SYSEX file that was uploaded to and stored on a computer with the 'Dump One' command, plus a MIDI SYSEX dumper utility program running on the computer, can be send back to a **G2** system over the MIDI IN connector. The '.pch2' patch or '.prf2' performance files can only be used by the Editor program.

Refer to [“Dump One” on page 29](#).

The Nord Modular G2 V1.3x supports the following MIDI SYSEX messages:

1 INCOMING SYSEX MESSAGE (TO NORD MODULAR G2)

1.1 PATCH REQUEST (PATCH SPECIFIED BY SLOT)

When receiving the SysEx message specified below the Nord Modular G2 responds by sending the specified patch over MIDI as a SYSEX dump (see description of SysEx Patch Dumps).

Byte (hex)	Description
\$f0	Start of System Exclusive
\$33	Manufacturer ID (Clavia DMI AB)
<Device ID>	Device ID for this specific instrument
	\$00...\$0f : Only the Nord Modular G2 with specified device ID will respond
	\$10.....\$7e : Undefined
	\$7f : All connected Nord Modular G2's will respond
\$0a	Model ID (Nord Modular G2)
\$30	Message ID (Patch Request by slot)
<Slot>	\$00...\$03 : Corresponds to slot A to D
	\$04 : Corresponds to active slot
	\$05...\$7f : Undefined
\$00	Spare, must be\$00
\$f7	End of System Exclusive

1.2 PATCH REQUEST (PATCH SPECIFIED BY FILE INDEX)

When receiving the SysEx message specified below the Nord Modular G2 responds by sending the specified patch over MIDI as a SYSEX dump (see description of SysEx Patch Dumps).

Byte (hex)	Description
\$f0	Start of System Exclusive
\$33	Manufacturer ID (Clavia DMI AB)
<Device ID>	Device ID for this specific instrument
	\$00...\$0f : Only the Nord Modular G2 with specified device ID will respond
	\$10...\$7e : Undefined
	\$7f : All connected Nord Modular G2's will

	respond
\$0a	Model ID (Nord Modular G2)
\$31	Message ID (Patch Request by file index)
<Bank>	\$00...\$1f : Corresponds to bank 1 to 32
	\$20...\$7f : Undefined
<Patch>	\$00...\$7f : Corresponds to patch 1 to 128
\$f7	End of System Exclusive

1.3 PERFORMANCE REQUEST (ACTIVE PERFORMANCE)

When receiving the SysEx message specified below the Nord Modular G2 responds by sending the specified performance over MIDI as a SysEx dump (see description of SysEx Performance Dumps).

Byte (hex)	Description
\$f0	Start of System Exclusive
\$33	Manufacturer ID (Clavia DMI AB)
<Device ID>	Device ID for this specific instrument
	\$00...\$0f : Only the Nord Modular G2 with specified device ID will respond
	\$10...\$7e : Undefined
	\$7f : All connected Nord Modular G2's will respond
\$0a	Model ID (Nord Modular G2)
\$38	Message ID (request for loaded performance)
\$00	Spare1, must be\$00
\$00	Spare2, must be\$00
\$f7	End of System Exclusive

1.4 PERFORMANCE REQUEST (PERFORMANCE SPECIFIED BY FILE INDEX)

When receiving the SysEx message specified below the Nord Modular G2 responds by sending the specified performance over MIDI as a SysEx dump (see description of SysEx Performance Dumps).

Byte (hex)	Description
\$f0	Start of System Exclusive
\$33	Manufacturer ID (Clavia DMI AB)
<Device ID>	Device ID for this specific instrument
	\$00...\$0f : Only the Nord Modular G2 with specified device ID will respond
	\$10...\$7e : Undefined
	\$7f : All connected Nord Modular G2's will respond
\$0a	Model ID (Nord Modular G2)
\$39	Message ID (Performance Request by file index)
<Bank>	\$00-\$07 : Corresponds to bank 1 to 8
	\$08-\$7f : Undefined
<Perf>	\$00-\$7f : Corresponds to performance 1 to 128
\$f7	End of System Exclusive

1.5 ALL CONTROLLERS REQUEST

When receiving the SysEx message specified below the Nord Modular G2 responds by sending all current MIDI CC# controller values for the specified slot.

Byte (hex)	Description
\$f0	Start of System Exclusive
\$33	Manufacturer ID (Clavia DMI AB)

<Device ID>	Device ID for this specific instrument
	\$00...\$0f : Only the Nord Modular G2 with specified device ID will respond
	\$10...\$7e : Undefined
	\$7f : All connected Nord Modular G2's will respond
\$0a	Model ID (Nord Modular G2)
\$40	Message ID (All Controllers Request)
<Slot>	\$00...\$03 : Corresponds to slot A to D
	\$04 : Corresponds to active slot
	\$05...\$7f : Undefined
\$f7	End of System Exclusive

2 INCOMING, AND OUTGOING, SYSEX MESSAGES (FROM NORD MODULAR G2)

2.1 PATCH DUMP

When dumping patches to, or from, the Nord Modular G2 over MIDI, each patch will be split into one or more SysEx blocks. Each of these SysEx blocks has the following format structure:

Byte (hex)	Description
\$f0	Start of System Exclusive
\$33	Manufacturer ID (Clavia DMI AB)
<Device ID>	Device ID for this specific instrument
	Sending a SysEx Patch Dump:
	\$00...\$0f : Corresponds to SysExId = 1... 16
	\$10...\$7e : Undefined
	\$7f : Corresponds to SysExId = 'All'
	Receiving a SysEx Patch Dump:
	\$00...\$0f : Corresponds to SysExId = 1 ... 16.
	Only the Nord Modular G2 with specified device ID will respond.
	\$10...\$7e : Undefined
	\$7f : Corresponds to SysExId = 'All'.
	All connected Nord Modular G2's will respond.
\$0a	Model ID (Nord Modular G2)
\$20	Message ID (Patch Dump)
\$00	Nord Modular G2 SysEx protocol version
<slot>	Slot from which the patch originates.
	If patch was requested from synthesizer file system, slot equals\$04 (=active slot)
\$00	Spare
<Block ID MSB>	ID of this SysEx block (7 most significant bits)
<Block ID LSB>	ID of this SysEx block (7 least significant bits)
	Block ID (14 bits, MSB and LSB combined) is 0 for first SysEx block in a transfer and [Block Count - 1] for last SysEx block in a transfer.
<Block Count MSB>	Total number of SysEx blocks for this transmission (7 most significant bits)
<Block Count LSB>	Total number of SysEx blocks for this transmission (7 least significant bits)
<name 1>	Patch name (1:st character)

<name 2>	Patch name (2:nd character)
...	...
<name 16>	Patch name (16:th character).
	If patch name is shorter than 16 characters, it will be padded with zeros, filling up all 16 name bytes.
\$00	Spare
<data 1>	Patch data
...	...
<data n>	Patch data
<checksum>	Least 7 bits of the sum of all bytes sent in this SysEx block except the checksum itself and the EOX byte.
\$f7	End of System Exclusive

2.2 PERFORMANCE DUMP

When dumping performances to, or from, the Nord Modular G2 over MIDI, each performance will be split into one or more SysEx blocks. Each of these SysEx blocks has the following format structure:

Byte (hex)	Description
\$f0	Start of System Exclusive
\$33	Manufacturer ID (Clavia DMI AB)
<Device ID>	Device ID for this specific instrument
	Sending a SysEx Performance Dump:
	\$00...\$0f : Corresponds to SysExId = 1 ... 16
	\$10...\$7e : Undefined
	\$7f : Corresponds to SysExId = 'All'
	Receiving a SysEx Performance Dump:
	\$00...\$0f : Corresponds to SysExId = 1 ... 16.
	Only the Nord Modular G2 with specified device ID will respond.
	\$10...\$7e : Undefined
	\$7f : Corresponds to SysExId = 'All'.
	All connected Nord Modular G2's will respond.
\$0a	Model ID (Nord Modular G2)
\$28	Message ID (Performance Dump)
\$00	Nord Modular G2 SysEx protocol version
\$00	Spare1
\$00	Spare2
<Block ID MSB>	ID of this SysEx block (7 most significant bits)
<Block ID LSB>	ID of this SysEx block (7 least significant bits)
	Block ID (14 bits, MSB and LSB combined) is 0 for first SysEx block in a transfer and [Block Count - 1] for last SysEx block in a transfer.
<Block Count MSB>	Total number of SysEx blocks for this transmission (7 most significant bits)
<Block Count LSB>	Total number of SysEx blocks for this transmission (7 least significant bits)
<name 1>	Performance name (1:st character)
<name 2>	Performance name (2:nd character)
...	...
<name 16>	Performance name (16:th character).
	If performance name is shorter than 16 characters,

	it will be padded with zeros, filling up all 16
	name bytes.
\$00	Spare
<data 1>	Performance data
...	...
<data n>	Performance data
<checksum>	Least 7 bits of the sum of all bytes sent in this
	SysEx block except the checksum itself and the EOX
	byte.
\$f7	End of System Exclusive

MIDI IMPLEMENTATION CHART

Model: Clavia Nord Modular G2 OS V1.1x Date: 2004-02-18

Function		Transmitted	Recognized	Remarks
Basic Channel	Default Channel	1 – 16 1 – 16	1 – 16 1 – 16	
Mode	Default Messages Altered	Mode 3 X *****	Mode 3 X	
Note Number	True Voice	0 – 127 *****	0 – 127 0 – 127	
Velocity	Note ON Note OFF	O v = 1 – 127 O	O v = 1 – 127 O	
Aftertouch	Key Channel	X O	X O	
Pitch Bend		O	O	
Control Change		O	O	See the MIDI Implementation section.
Prog Change	True #	O 0 – 127	O 0 – 127	
Bank Select	True #	O 0 – 31	O 0 – 31	MIDI CC#32
System Exclusive		O	O	
System	: Song Pos	X	O	When using external sync of Master Clock
Common	: Song Sel	X	X	
	: Tune	X	X	
System	: Clock	O	O	
Real Time	: Commands	X	X	
Aux	: Local ON/OFF	X	X	
Mes-	: All Notes Off	X	X	
sages	: Active Sense	X	X	
	: Reset	X	X	
Notes				

Mode 1: OMNI ON, POLY
Mode 3: OMNI OFF, POLY

Mode 2: OMNI ON, MONO
Mode 4: OMNI OFF, MONO

O: Yes
X: No

13. MODULE REFERENCE

The Nord Modular G2 modules are grouped in 16 module groups, which you access by clicking on the module group buttons in the toolbar. The modules are visually identified with illustrations. When you place the cursor over an illustration, a module preview and a brief description appears.

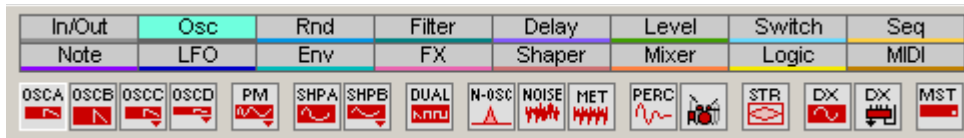

When you add a new module to a patch, the Nord Modular G2 mutes the outputs for a short moment, as the Editor program will have to optimize the DSP engine data and occasionally reallocate the voices in the active Slots to other DSP engine resources. Theoretically, you could use over 200 modules in each patch, about 100 in the Voice Area and 100 in the FX Area, but you will probably run out of DSP engine resources before reaching the module limit. DSP engine resources are shown in the two Patch Load Cycles and Memory displays in the toolbar. It is possible to use several modules of the same type in both Areas of a Patch, except for the 'FX Input' module which can only be used in the FX Area.

In this Module Reference chapter the description of each module group is preceded by explaining parameters that are common for all modules in the specific group. If you don't find descriptions of certain parameters together with the individual modules, check the module group introduction parts.

IN/OUT GROUP

This group contains modules that connects the patch to the outside world. The In/Out modules give you access to incoming keyboard information, route audio signals to and from the four physical audio **IN** and **OUT** jacks, allow you to route audio signals between the Voice Area and the FX Area, and route audio signals to and from the Audio Bus channels, which are shared by the four Slots of the Nord Modular G2. By using these Bus channels you can route audio from one Patch to another internally. You will need at least one 2-Out module in a Patch to be able to listen to audio signals created in the Patch.

COMMON IN/OUT MODULE PARAMETERS AND DEFINITIONS

AUDIO SIGNAL CHANNELS

There are a number of different audio signal channels in the Nord Modular G2 system. First, you have 4 separate Audio In channels which route the incoming audio signals on the four **AUDIO IN** jacks and the **XLR MIC INPUT** of the synth to the Input modules in the four Slots. There are also 4 separate Audio Out channels which are hard-wired to the four **AUDIO OUT** jacks of the synth. In each Patch you can also route 4 separate audio signals from the Voice Area to the FX Area (see “FX-In” on page 158).

In addition to these audio signal channels, there are 4 global audio Bus channels which can be used by Patches to route audio signals between the four Slots of the synth. In other words, the audio Bus concept makes it possible to send and receive audio signals internally between Patches in the four Slots. This is useful when creating multi-Slot Performances where one Slot is used as an FX processor for the other Slots. The audio Bus channels can be used freely by both the Voice Area and the FX Area. This means that you could actually route audio back from the FX Area to the Voice Area if you like. The figure below shows how audio signal channels can be routed in the Nord Modular G2 system:

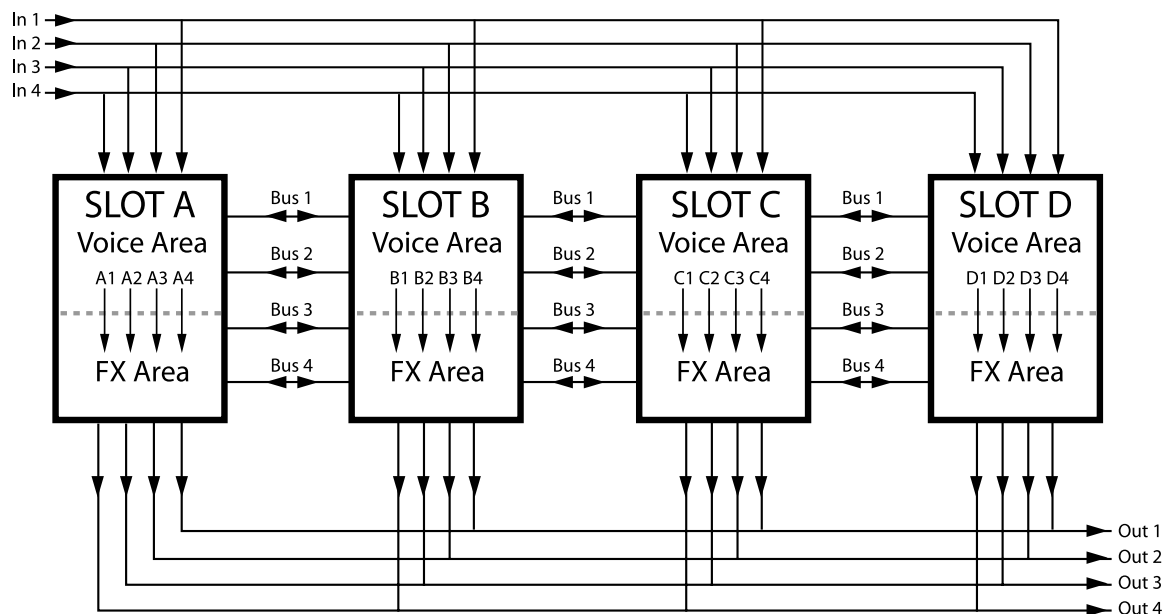

Note that the four audio Bus channels are parallel and can be used by Patches in the Slots in no specific order.

NOTES ABOUT USING THE AUDIO IN SOURCES

The ‘In’ selector routes **LINE LEVEL** audio signals from the **IN 1-4** inputs on the rear panel of Nord Modular G2 to your patch. You can also use a dynamic microphone in the **XLR MIC INPUT** on the rear panel. This input has a built-in preamp and you control the input gain with the **MIC GAIN** knob on the front panel. If you use a dynamic microphone in the **XLR MIC INPUT**, make sure **no cable** is connected to the **LINE IN 1** jack on the back of the G2. The **MIC INPUT** signal can then be patched from the Out 1 (or L) output of the Input modules. A total of four separate audio signals can be patched into the system at a time.

If you use the **IN 1-4** inputs it’s important that you amplify the input signals to line level externally to get good sound quality. If you put in too low a signal and amplify it, using for example the Pad scroll button or the Amplifier module, the sound quality won’t be good. The reason for this is that the internal amplification is digital, and a low analog input signal will result in low resolution. A low resolution signal that is digitally amplified will have a LoFi sound quality.

Note: If you want to process a stereo input signal, remember taht almost all modules have only one mono input. This means that any processing modules (filters etc.) have to be duplicated in the patch, one for the Left channel and another one for the Right channel.

PAD

The Pad scroll button on the Input and Output modules can be used to attenuate or amplify the signals. On the Input modules you can select between 0dB, -6dB, -12dB and +6dB and on the Output modules between 0dB and +6dB.



ON/OFF

Click the On/Off button to mute the signal(s) of the In/Out module. Blue color indicates ‘On’ and gray ‘Mute’.



LEVEL METERS

The level meters on the Input modules displays the following signal levels: green LEDs between -40dB and 0dB, yellow LEDs between >0dB and +11dB and red LED at >11dB.



Tip! Level meters can be assigned to frontpanel knobs with a right mouse click on the level meter. This will cause the LEDs around the knob to act as a (circular) VU-meter.

2-OUT

This module is used to patch stereo signals to the Audio Outs, the FX Area or the audio Buses.

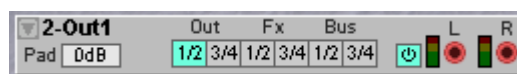

SOURCE SELECTOR BUTTONS

Here you select the signal destination: Audio Out channels 1/2 or 3/4, FX Area channels 1/2 or 3/4 or audio Bus channels 1/2 or 3/4. Note that it makes no sense to use the FX channels when the module is in the FX Area, in fact the FX channels are disabled when this module is placed in the FX Area.

To read more on signal routing check out "[Common In/Out module parameters and definitions](#)".

4-OUT

This module is used to patch individual signals to different destinations: the Audio Out, the FX Area or the Global Buses.

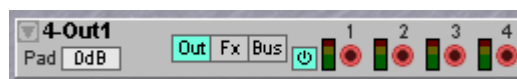

SOURCE SELECTOR BUTTONS

Here you select the signal destination: Audio Out channels 1-4, FX Area channels 1-4 or audio Bus channels 1-4. Note that it makes no sense to use the FX channels when the module is placed in the FX Area. See also "[Common In/Out module parameters and definitions](#)".

2-IN

This module is used to route stereo signals from the Audio Ins or the audio Buses.

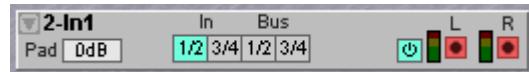
**SOURCE SELECTOR BUTTONS**

Here you select the signal source: Audio In channels 1/2 or 3/4 or audio Bus channels 1/2 or 3/4. See also "[Common In/Out module parameters and definitions](#)".

4-IN

This module is used to route individual signals from the Audio Ins or the audio Buses.

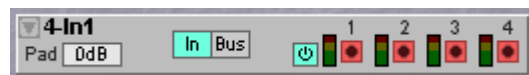
**SOURCE SELECTOR BUTTONS**

Here you select the signal source: Audio In channels 1-4 or audio Bus channels 1-4. See also "[Common In/Out module parameters and definitions](#)".

FX-IN

This module should be used when you want to route audio signals from the Voice Area to the FX Area. Since the FX In module processes the sum of all voices from the Voice Area, the volume depends on the number of notes you play simultaneously. See an example of how to use the Voice and FX Areas in "[Voice Area and FX Area](#)" on page 85. See also "[Common In/Out module parameters and definitions](#)".

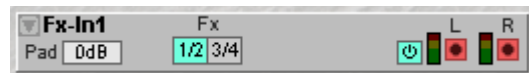
**KEYBOARD**

The Keyboard voice module gives you access to a few basic and important signals associated with the keyboard on Nord Modular G2, or a keyboard connected to the synth via MIDI In. The signals are generated from each key played and affect one voice at a time.

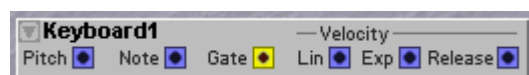
**PITCH**

This blue output provides you with a pitch control signal that is a mix of the value for the **played note** *plus* **pitch bend** *plus* **glide** values from the Nord Modular **G2 KEYBOARD** or from the **MIDI IN** port. This same signal is also hardwired internally in a patch to every module that has a KBT control or button. The pitch bend value is scaled before it is combined with the note information. The pitch Bend Range parameter controls the scaling amount, or in other words the sensitivity of the pitchstick. This ratio can be set from the G2 frontpanel or in the Patch Settings menu, see "[Patch Settings {Ctrl-P}](#)" on page 118.

The note E4 (MIDI note 64), which is the middle E on the Nord Modular G2 keyboard when the **OCT SHIFT** selector is in the center position, represents an output signal level of 0 units. Each half note up or down on the keyboard will increase or decrease the value by one unit. MIDI note 0 (C-1) represents -64 units and MIDI note 127 (G9) represents +63 units.

Signal: **Bipolar**.

NOTE

This blue output provides only the Note number value as a control signal, so *without* any additional pitch bend or glide data. E4 (MIDI note 64), which is the middle E on the Nord Modular G2 keyboard when the **OCT SHIFT** selector is in the center position, represents an output signal level of 0 units. MIDI note 0 (C-1) represents -64 units and MIDI note 127 (G9) represents +63 units.

Signal: **Bipolar**.

GATE

This yellow output sends a logic HIGH signal (+64 units) every time a key is pressed on the keyboard, or a MIDI note-on is received at the **MIDI IN** port. The logic signal switches back to a logic LOW signal (0 units) when the key is released. If a sustain pedal is activated, the logic signal will be HIGH for as long as the pedal is pressed. Signal: **Logic**.

LIN & EXP VELOCITY

These blue outputs transmit the note-on velocity signals from the keys that you play on the Nord Modular G2 or any velocity that is received on the **MIDI IN** port. The velocity response of the Nord Modular G2 keyboard is linear on the Lin Vel output and exponential on the Exp Vel output. Signal: **Unipolar Positive**.

RELEASE VELOCITY

This blue output provides you with the release velocity signal from the keys that you play on the Nord Modular G2, or any release velocity that is received via MIDI. The release velocity response of the Nord Modular G2 keyboard is linear. Signal: **Unipolar Positive**.

MONOKEY

This module provides three different control signals to emulate the keyboard behaviour of a classic monophonic synth. The signals are generated from the last/lowest/highest note (depending on the alternative below) played and affect all allocated voices, in contrast to the Keyboard module described above.



last/lowest/highest note (depending on the alternative below) played and affect all allocated voices, in contrast to the Keyboard module described above.

LAST/LO/HI

Select which notes should be output. 'Last' will output the data from the latest key played. 'Lo' will output data from the lowest key played and 'Hi' from the highest key played.

Tips! The Lo and Hi alternatives are perfect for creating a polyphonic Patch with a separate sound for the bass (Lo) or lead (Hi) lines. Patch the Pitch and Gate outputs (see below) to the bass/lead sound oscillator(s) Pitch input and the Envelope Gate input. Disable the Oscillator KBT and Envelope KB functions.

PITCH

This blue output provides you with a complete pitch (note number + any pitch bend and/or glide) signal from the last/lowest/highest note (depending on the alternative above) played on the keyboard, or received at the **MIDI IN** port.

E4 (MIDI note 64), which is the middle E on the Nord Modular G2 keyboard when the **OCT SHIFT** selector is in the center position, represents a signal level of 0 units. MIDI note 0 (C-1) represents -64 units and MIDI note 127 (G9) represents +63 units.

Signal: **Bipolar**.

GATE

This yellow output sends a HIGH logic level (+64 units) every time a key is pressed on the keyboard or a MIDI note-on is received at the **MIDI IN** port. The logic signal switches back to a LOW logic level (0 units) when the last key is released. You can use this signal to start envelopes in the single-trigger fashion. If a sustain pedal is activated, the logic signal will be HIGH for as long as the pedal is pressed. Signal: **Logic**.

VEL

This blue output provides you with a control signal from the last/lowest/highest (depending on the alternative above) note-on velocity. The velocity response of the Nord Modular G2 keyboard is linear from this output. Signal: **Unipolar Positive**.

DEVICE

The Device module represents a number of physical controls on the synth and routes their respective control signals for use in the Patch.

**WHEEL**

The blue Wheel output provides a positive control signal according to the position of the **MOD WHEEL**. Signal: **UNIPOLAR POSITIVE**.

AFTERTOUGH

The blue Aftertouch output provides a positive control signal according to the current Keyboard Aftertouch value. Signal: **UNIPOLAR POSITIVE**.

CONTROL PEDAL

The blue Control Pedal output provides a positive control signal according to the position of a connected Control/Expression pedal. Signal: **UNIPOLAR POSITIVE**.

SUSTAIN PEDAL

The yellow Sustain Pedal output provides a logic HIGH signal (+64 units) as soon as a connected sustain pedal is depressed. In the system menu you can set if the Sustain pedal is of a 'make-contact or 'break-contact' type. Signal: **LOGIC**. See also Sustain Pedal Polarity at "[Sust Ped Pol | Sy](#)" on page 32

PITCH STICK

The blue Pitch Stick output provides both the negative and positive control signal range of the **PITCH STICK**. It will output a signal as soon as the **PITCH STICK** is moved. Signal: **BIPOLAR**.

STATUS

The Status module is an extremely useful module for controlling things in a Patch. It gives you the possibility to control or define events on the moment when you load a Patch (e.g. to send specific MIDI commands) and also when you switch between Variations in the Patch. It also gives you the possibility to control your Patch depending on which individual voice is used.

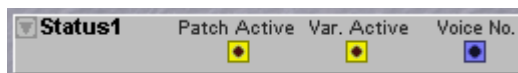
**PATCH ACTIVE**

Provides you with a logic HIGH signal (+64 units) as soon as a Patch is loaded into a Slot or activated. This signal can be used to reset or sync events in the Patch that you want to reset automatically after Patch load. Signal: **LOGIC**.

VAR. ACTIVE

Provides you with a logic HIGH signal (+64 units) as soon as a Variation is active. When you switch between Variations, the signal drops to a logic LOW (0 units) for a short while and then immediately raises to a logic HIGH (+64 units) again. This signal can be used to reset, sync or start events in the currently selected Variation of the Patch that you want to reset, sync or start automatically immediately after you switched from another Variation to the current Variation. Signal: **LOGIC**.

VOICE NO.

The blue Voice No output sends out a Ctrl signal value for the voice number currently used. This means you can control each voice in a polyphonic patch separately. The Ctrl values for the voice numbers sent out from the Voice No output corresponds to the ranges of the Ctrl inputs of the Multiplexer modules in the Switch group (see page 221) and also the Volt input of the Volt Sequencer module (see page 244). The output Ctrl signal output values are these: Voice 1: 0, Voice 2: 4, Voice 3: 8, Voice 4: 12, Voice 5: 16, Voice 6: 20, Voice 7: 24, Voice 8: 28, Voice 9: 32, Voice 10: 36, Voice 11: 40, Voice 12: 44, Voice 13: 48, Voice 14: 52, Voice 15: 56, Voice 16: 60, Voice 17: 64, Voice 18: 68, Voice 19: 72, Voice 20: 76, Voice 21: 80, Voice 22: 84, Voice 23: 88, Voice 24: 92, Voice 25: 96, Voice 26: 100, Voice 27: 104, Voice 28: 108, Voice 29: 112, Voice 30: 116, Voice 31: 120 and Voice 32: 124.

As you can see, the output Ctrl signal has double the range compared to general control signals. This means that if you want to control general control signal applications you need to add a negative offset for Voice 17 and above to not hit the +64 units “headroom” of the control signal inputs.

EXAMPLE 1: 4 SEPARATELY DETUNED VOICES

Let’s say you want to simulate an old analog 4 voice synthesizer which has slightly different oscillator tunings for each voice. Sounds familiar? Use the Status module and the Volt Sequencer module and patch the Voice No output to the Volt input of the Volt Sequencer. Then, we set the Voice Mode in the Patch window to 4 voices. We click the Clr button on the Volt Sequencer to set each step to 0 units. Then, we set each of the four first steps of the Volt Sequencer slightly differently. Then we patch the Volt Sequencer control signal output to the Oscillator A Pitch modulation input and raise the attenuator knob a bit. Now, play and add a key at a time till you play a 4 note chord. Each of the voices sound slightly detuned as we would expect. Release one of the keys and press it again. Now, the same voice sounds again with its unique tuning.

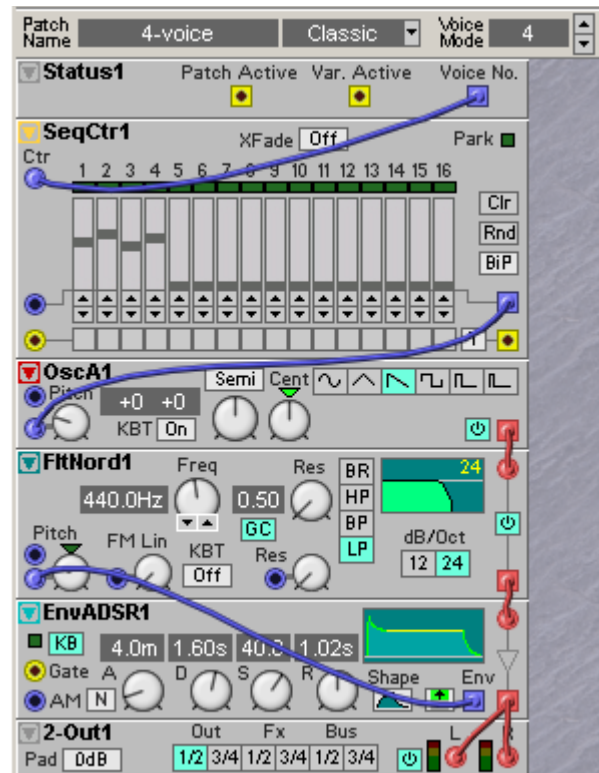

EXAMPLE 2: 4 VOICES AND 4 WAVEFORMS

By using the Voice No output of the Status module in combination with the Ctrl input of an 8-1 Multiplexer module, you can even create polyphonic Patches that have completely different sounds for each individual voice. This example shows a 4 voice polyphonic Patch with separate oscillators and waveforms for each voice

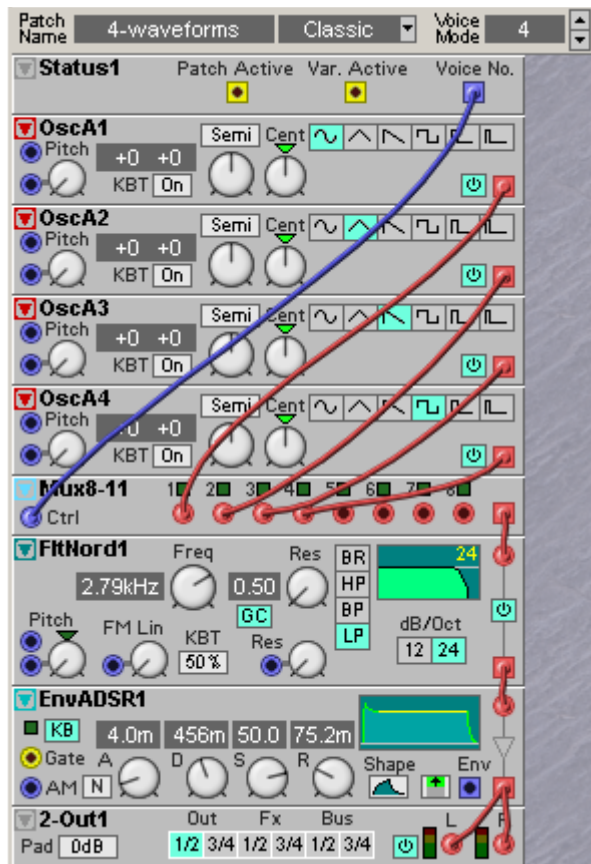

NOTEDET

This module can detect if a certain note is played, either on the Nord Modular G2 keyboard, on the **MIDI IN** connector, or when sent from another Slot with a MIDI NoteSend module with the Slot this module is in as destination. This module is commonly used to trigger drum or percussive sounds assigned to a fixed MIDI note. A logic HIGH signal will be transmitted, together with a velocity control signal, when the selected key is detected. The logic signal will switch to a logic LOW signal, and a release velocity control signal will be sent, when the selected key is released. The Note Detect module is global and affects all voices assigned in a patch. The behavior is similar to the MonoKey module described on [page 159](#). The Note detect module is not affected by the polyphony of the patch. It will detect notes, even if you run out of polyphony.



NOTE KNOB

Select the note to be detected. Range: C-1 to G9.

OUTPUTS

Gate signal: **Logic**.

Velocity (linear Velocity signal): **Unipolar Positive**.

RelVel (linear Release Velocity signal): **Unipolar Positive**.

NAME

The Name module is used to include text comments in a patch. It's handy if you, for example, want to describe a group of modules in the Patch window. Just place the Name module together with the modules in the group, right-click on the Name module and select 'Rename' from the pop-up and type in an appropriate text. Then press Enter to apply the text to the module. Note that this module does not show in the G2 panel displays and only serves as a hintbox for the Editor program.



Tip! To distinguish a group of modules in the Patch from other modules, you can also use the Color feature described on [page 83](#).

NOTE GROUP

Modules in this group do operations on blue signals that represent keyboard note information. In this group you will find modules that can rescale and quantize pitch control signals to halfnote scales, chord scales, harmonic scales and extract pitch control signals from audio signals.

NOTEQUANT

This module will first scale down the input signal according to the Range setting. Then it will quantize the scaled input signal to the closest exact semitone which fits in the semitone scale set by the Notes control.

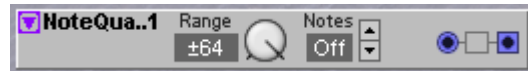

RANGE KNOB

Scales down a full input signal range between -64 to +64 semitones to the smaller range as shown in the associated display. If the input range is smaller than full range, e.g. between -32 and +32 semitones, then the actual output range will be also half of the range shown in the display. Note that one semitone corresponds to 1 unit in a signal level.

NOTES

Sets the desired quantization interval in a number of exact semitones. Range: Off and 1 to 127 semitones.

IN

The blue control signal input.

OUT

Signal: **Bipolar**.

KEYQUANT

This module will first scale down the input signal according to the Range setting. Then it will quantize the scaled input signal to the closest exact semitone which fits in the scale set by the mini-keyboard.

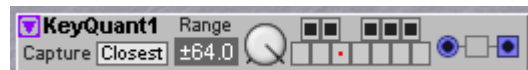

RANGE KNOB

Scales down a full input signal range between -64 to +64 semitones to the smaller range as shown in the associated display. If the input range is smaller than full range, e.g. between -32 and +32 semitones, then the actual output range will be also half of the range shown in the display. Note that one semitone corresponds to 1 unit in a signal level.

ONE OCTAVE MINI-KEYBOARD BUTTONS

Click a button on the mini-keyboard to highlight notes that you want to quantize to. The note interval for the shown octave is automatically duplicated across the whole key Range.

CAPTURE

Select 'Evenly' with this button to force the module to "split up" the key quantization grid in equally big sections per octave.

We have selected the notes E, F and F# to quantize to in every octave. The Capture function is set to 'Closest'. As you can see, the quantization will be to the closest matching note.

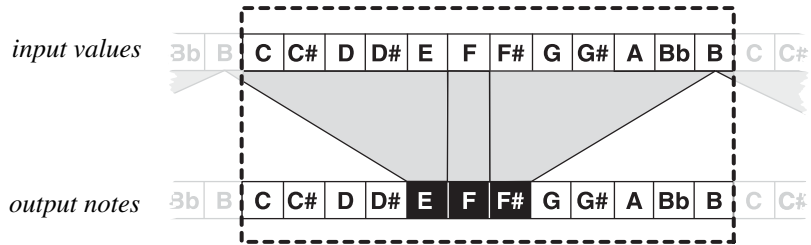

Here the Capture function is set to 'Evenly'. As you can see, the input signal will be quantized to the selected notes in equal sections, per octave, across the selected range.

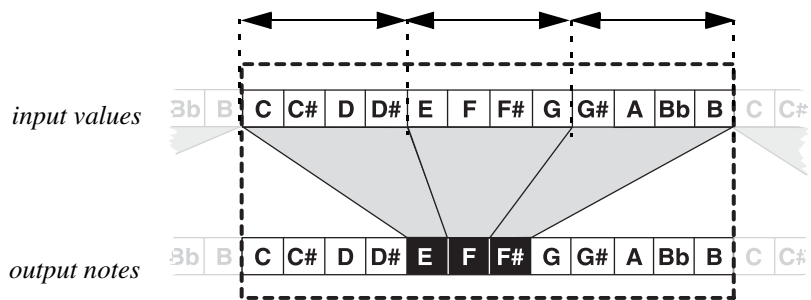

IN

The Range control signal input.

OUT

Signal: **Bipolar**.

EXAMPLE

The example below shows the principle for creating a simple arpeggiator. LFO A is set to generate a triangle wave, since this signal has linear, symmetrical ramps. This guarantees even change of control values over time. Press four Note buttons on the module's mini-keyboard and selected a Range of +/- 32 semitones on the KeyQuant module. The output signal from the KeyQuant module is routed to the direct, unattenuated Pitch input of the Osc A module to ensure correct semitone intervals. Select Capture 'Evenly' to make the notes be output at a steady rate when controlled from the Triangle wave LFO.



PARTQUANT

The Partial Quantizer module is used to transpose an Oscillator to one of its harmonic partials. It works similar to the NoteQuant module, but instead of quantizing to semitone values this module quantizes to 'overtone' values. The PartQuant module is similar to the Part

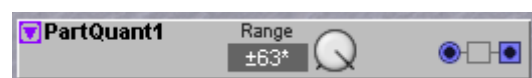

setting on a G2 oscillator module. The PartQuant transforms a Pitch control signal to a new signal value that will offset the frequency of an oscillator in an exact harmonic interval. The range of the partial generator is 0 to +/- 64 partials in steps of 1 harmonic. Note that the practical limit for this module is +/- 32 harmonics. This means that if the input value is greater than +32 units, the output signal will quantize to the 32nd harmonic control signal value, as that's where the scale stops. In normal use the PartQuant output is connected to a direct Pitch input (without attenuator knob) of an Oscillator or a Filter module. Positive input signals will tune an oscillator to a higher harmonic, while negative input signals will make the oscillator produce 'undertones'.

RANGE KNOB

Scales down a full input signal of +64 units to a control value which will produce the overtone shown in the associated display (the actual harmonic is one higher as the display shows, e.g. when the display shows +/- 2 it actually means the third harmonic). If the input signal is smaller than +64 units, e.g. +32 units, then the actual output control signal will produce the harmonic that is half as low as the value shown in the display. Note that an increase in value of 1 unit of the input signal level corresponds to a step of one harmonic, provided the Range is set to +63*. Knob settings which exceed +/- 32 partials are shown with an asterisk, indicating that the practical output limit is exceeded.

As the output is a result of both the Range setting and the value of the input signal, it is recommended to either use the Range knob with an input setting of +64 units, or instead set the Range knob fully open to +/-63* and vary the level of the input signal with e.g. a Constant module to force an oscillator or filter to a fixed harmonic. When the purpose of the module is to arpeggiate an oscillator through its harmonic series, use a Lfo waveform set to positive only. As the Lfo waveform will in this case vary between 0 and +64 units the Range knob will set the harmonic arpeggiator range.

Note that when the display shows +1 it will detune to the second harmonic, and when set to +2 detune to the third harmonic, etc.

INPUT

The blue control signal input.

OUT

Signal: **Bipolar**.

EXAMPLE OF A HARMONIC ARPEGGIATOR

In this example a positive only triangle lfo waveform is quantized to an up down arpeggio that steps from the fundamental pitch up to the eighth harmonic and down again.

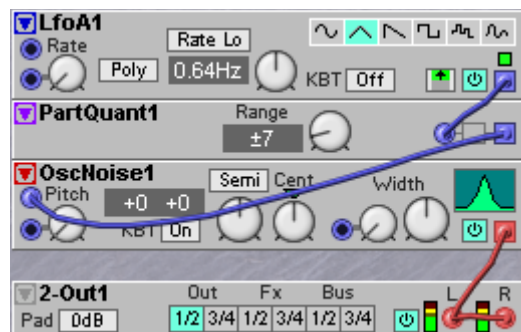

EXAMPLE OF JUST TUNING

Just tuning is commonly based on ‘pure’ ratios that can be expressed as rational fraction ratios of relatively small numbers, e.g. a pitch can have a 3:2, 4:3 or 5:4 ratio in respect to another pitch. These detune ratios are excellent to use in techniques like FM and ringmodulation, where two oscillators are often detuned to rational fraction ratios to have minimal ‘beating’ effect. The PartQuant can be easily used to create rational fraction ratios. For a rational fraction a numerator and a denominator are given. On the G2 the ‘pure’ detuning can be calculated by creating a numerator and a denominator with two PartQuant modules, and then simply subtract the denominator value from the numerator value. Subtracting is done with a two input mixer with the Inv button ON for the denominator. The two Constant modules in the example together define the actual detune, which in this case is 4(+1) divided by 3(+1), so 5:4. Adding one to the value of the Constant module to know the proper ratio is necessary, as when the Constant module shows 4 it is actually the fifth harmonic that will be generated (remember that when both values are zero the ratio is 1:1). So, in this example the second oscillator is detuned to the ‘fourth undertone’ of the ‘fifth overtone’ of the fundamental.

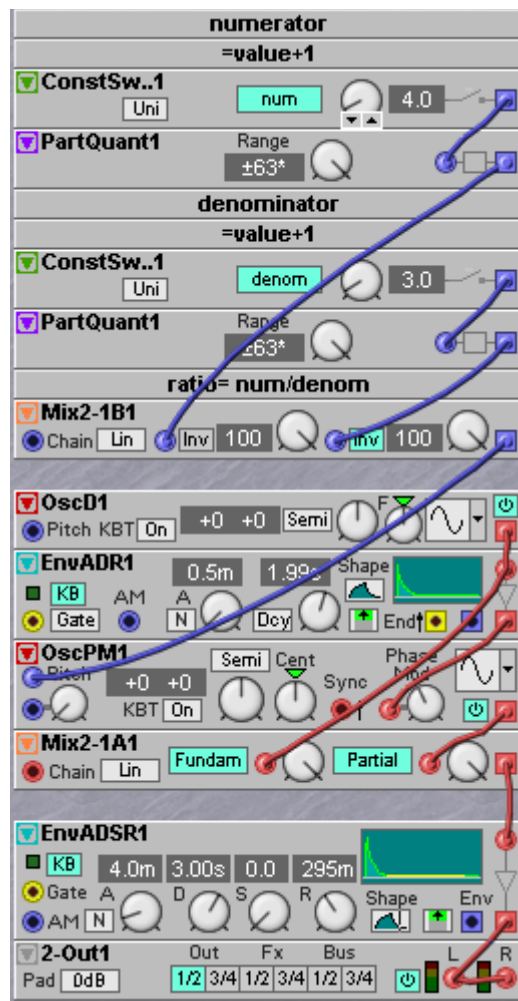

NOTESCALER

This module works like a control signal attenuator, with a scale display that makes it easy to process keyboard note values. You set the output peak-to-peak limits in semitones. This could be useful if you want to “tune” the output from a controller. The Note Scaler works with either uni- or bipolar signals.

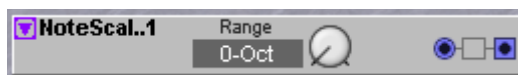

RANGE KNOB

Scales down a full input signal range between -64 to +64 semitones to the smaller range as shown in the associated display. If the input range is smaller than full range, e.g. between -32 and +32 semitones, then the actual output range will be also half of the range shown in the display. Note that one semitone corresponds to 1 unit in a signal level.

IN

The blue control signal input.

OUTPUT

Signal: Bipolar.

GLIDE

This module will smooth or slew sudden transitions in level of a control signal. This will create a glide effect between ‘jumping’ values in a control signal, similar to the portamento effect. You can think of this module as a lowpass filter for control signals. The glide effect can be linear (which will produce a longer glide time if the input signal value makes a bigger jump in value) or logarithmic (basically the same glide time for smaller and bigger jumps in input value). Tip! To make a legato introduced portamento on notes played on the G2 keyboard, it is often more convenient to use the Keyboard Glide function in the Patch | Patch Settings window as described at “Glide” on page 118.



GLIDE ON

Patch a high logic signal here to activate the gliding transition between the input signal levels (if the Glide button is off). If no connection is made, the portamento can be controlled with the Glide button.

SHAPE

Select ‘Lin’ (different time depending on the range between adjacent input values) or ‘Log’ (basically the same time regardless of the range between adjacent input values).

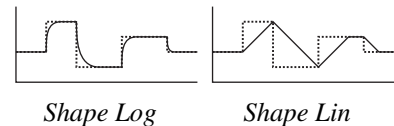

TIME

Sets the transition (glide) time with the knob.

Log Range: 0.2 msec to 22.4 sec.

Lin Range: 0.2 msec/octave to about 23.5 seconds/octave

IN

The blue control signal input.

OUTPUT

Signal: **Bipolar**.

PITCHTRACK

The Pitch Tracker module can transform the pitch of a monophonic audio input signal into a blue control signal on the Pitch output. The output control signal can be patched directly into a Pitch input of an oscillator or filter. The module features a Gate function with selectable threshold which produces a logic HIGH signal when the input level exceeds the Threshold value.



The Pitchtrack module uses an advanced tracking method that is a good trade off between speed, noise immunity and accuracy.

INPUT

The input of the PitchTrack module.

PERIOD

Outputs a very short logic HIGH pulse every time a new pitch measurement value is available.

Signal: **LOGIC**.

PITCH

Signal: **BIPOLAR**

GATE

Outputs a logic HIGH signal when the input signal level exceeds the Threshold level (see below).

Signal: **LOGIC**.

THRESHOLD

Set the threshold level for the input signal to generate the Gate signal (see above).

EXAMPLE PATCH

This example patch can be used when a microphone is connected to the XLR input on the G2. The oscillator OscA1 KBT button should be set to Off to prevent the oscillator to also track the keyboard. Though when the KBT button is On you can offset the Pitch by the keyboard, note E4 will be the reference Pitch to which you have to calculate the Pitch offset. E.g. playing note E5 will transpose the oscillator one octave higher as the pitch of the incoming audio signal.

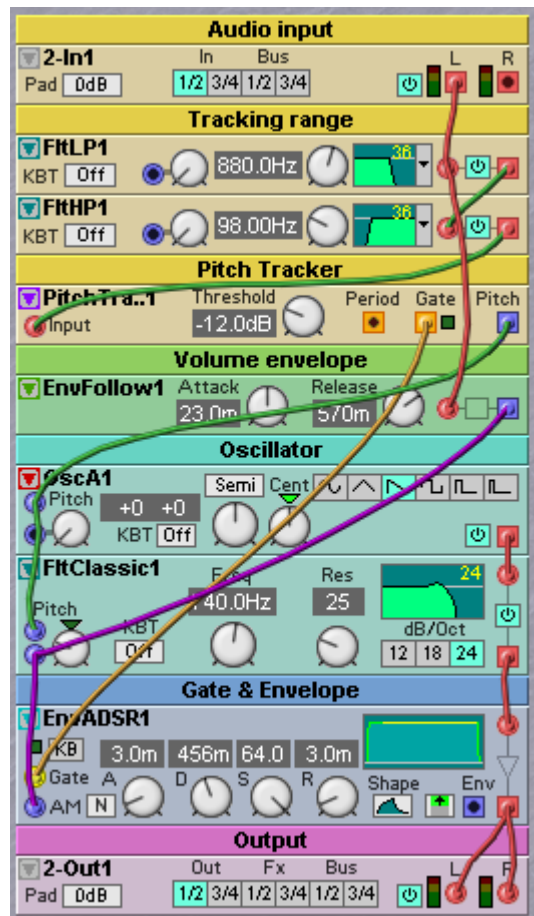

ZEROCNT

The Zero Crossing Counter module can be used for detecting the pitch of input signals of a single simple waveform. Note that for this module the input signal has to be fairly simple regarding harmonic content. The practical pitch detection range is equal to the default oscillator pitch range when tracking a red or orange signal, or the default Lfo range when tracking a blue or yellow signal (set Lfo to 0.64 Hz).



The PitchTrack module uses a simple method which measures the time between two positive zero crossings of the audio input signal. The measured time is then transformed into the Pitch control signal output value. The advantage of this method is that it is very fast, the Pitch value is available immediately at the end of each waveform cycle in the input signal. But this method expects reasonably simple

waveforms and cannot handle chords or complex waveforms where the waveform crosses the zero line several times during one cycle.

INPUT

The input of the ZCounter module.

PITCH

Signal: **BIPOLAR**

EXAMPLE OF TAP TEMPO

In this example the rate of the lfo can be set by tapping *two times* on the Tap button. The time between the two times will be measured and held on the ZeroCnt output. Note that while tapping a new tempo, the Rate in between the first two taps on the tap button is basically undefined.

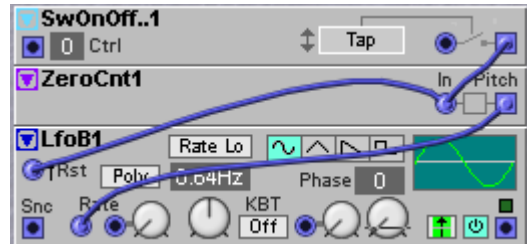

LEVSCALER

This module is used to scale the level of a signal depending on either a position on the keyboard (KBT=ON and Note input is not used) or depending on the value of a control signal (KBT =OFF and the control signal is connected to the Note input). This module is useful to create variable Keyboard Scaling, like used on some FM synthesizers. To create the Keyboard Scaling, first set a break point key and then set different amplification/attenuation slopes for the sections on either side of the break point. The scaling will be applied to the signal connected to the input in the upper right corner and the scaled input signal will be available on the output in the lower right corner. An internal gain controller or VCA is used to do the actual scaling. The control signal that controls this internal gain controller is available on the Level output and can be used to 'slave' other LevMult modules. Note that when the L and R controls are set to 0.0dB no scaling takes place and the gain of the internal gain controller is unity. Which means that the Level output will in this case produce a value of +64 units, no matter what note is played on the keyboard.

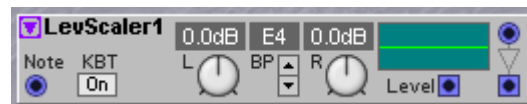

NOTE

An optional control signal to control the scaling. Patch this input to e.g. the Pitch or Note outputs of the Keyboard input module (see [page 158](#)). Alternatively, the module can be used as a waveshaper for Lfo waveforms. Do this by connecting a triangle waveform to the Note input and setting the KBT button to OFF. Take the output from the Level output and tweak the L, R and Breakpoint controls. Best results are when both the L and R controls are set to negative dB values (turn knobs left). Note that when the L and R controls are both set to 0.0dB the Level output produces a steady level of +64 units. Judge results by ear.

KBT

This is an internally hard-wired connection for the LevScaler module to the keyboard (and the MIDI input). If KBT is set to ON the LevScaler will track the keyboard at the rate of one semitone for each key. If KBT is set to OFF, the keyboard will not affect the LevScaler Note control.

LOWER

Set the amplification/attenuation slope for the lower key section with the knob. The value is displayed in the corresponding display box. Range: +/-8.0 dB per octave.

BP

Set the break point note number. The value is displayed in the corresponding display box. Range: C-1 to G9.

UPPER

Set the amplification/attenuation slope for the upper key section with the knob. The value is displayed in the corresponding display box. Range: +/-8.0 dB per octave.

GRAPH

Displays the two gain slopes and the break point graphically. The Y-axis represents the output level (logarithmic) and the X-axis the entire note range (C-1 to G9). the horizontal line represents the +64 units (0 dB) output level.

LEVEL OUTPUT

The output value is the combined result of the note input and scaling values. Signal: **Unipolar**.

INPUT

The **DYNAMIC AUDIO/CONTROL** signal input to the internal gain control function. Patch for example an Oscillator audio signal here and patch the output to a FM input of another oscillator.

OUTPUT

The output of the amplified/attenuated input signal. Signal: **BIPOLAR**.

OSCILLATOR GROUP

The Nord Modular G2 oscillators produce continuous waveforms with a certain pitch and an amplitude swing that is between -64 and +64 units. If you connect an oscillator output to a mix bus, it will generate a constant sound - just as you would expect. If you want the behaviour of a traditional synthesizer, i.e. to generate sound only when you play on the keyboard, patch the output of the oscillator to the audio signal input of an envelope generator. Then, patch the audio signal output of the envelope generator to an Output module.

COMMON OSCILLATOR PARAMETERS

WAVEFORM RADIO BUTTONS

Some oscillators feature waveform selectors of radio-button type. All waveforms instantly available after selection, which means that you can switch waveform without any interruption. This radio-button control can be assigned to a frontpanel knob to instantly select waveforms on the frontpanel.



WAVEFORM DROP-DOWN SELECTORS

Some oscillators feature drop-down waveform selectors. The different waveforms of these oscillators are not instantly available as in the “radio button” oscillators described above. Waveforms from the drop-down menu must be preselected in the Editor program. Selecting another waveform in the Editor will force the G2 to optimize the DSPs and will cause a brief moment of silence. The advantage of this is that these oscillators use less Patch Load. Note that Oscillators with drop-down waveform selectors will use the preselected waveform in all 8 Variations. If you want different waveforms in different Variations, use oscillators with radio buttons instead.



WAVEFORM DROP-DOWN SELECTORS WITH GRAPHS

The Shape Oscillators have drop-down waveform selectors with a graphical display of the wave shape that shows how the waveform changes when tweaking the Shape knob. Waveforms from the drop-down menu must be preselected in the Editor program. Selecting another waveform in the Editor will force the G2 to optimize the DSPs and will cause a brief moment of silence. The advantage of this is that these oscillators use less Patch Load.

Note that Oscillators with drop-down waveform selectors will use the preselected waveform in all 8 Variations. If you want different waveforms in different Variations, use oscillators with radio buttons instead.

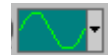

SEMI/FREQ/FAC/PART SCROLL BUTTON

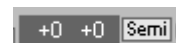

Click this button to switch the frequency control modes between Semitone, Frequency, Partial and Factor mode. The respective mode is also shown in the Display box. The following ranges and characteristics are valid for the different modes:

- Semitone range: -64 to + 64 (C-1 to G9) relative to the input value on an unattenuated Pitch input on the oscillator module. If the KBT button is on, the Semitone value is relative to the note played on the keyboard (or received via MIDI). If KBT is not active and no Pitch modulation is present, the factor value is relative to the note E4.



- Frequency range: 8.1758 Hz to 12.55 kHz if KBT is not active and no Pitch modulation is present.



- Factor range: x0.0248 to x38.055 relative to the input value on an unattenuated Pitch input on the oscillator module. If the KBT button is on, the factor is relative to the note played on the keyboard (or received via MIDI). If KBT is not active and no Pitch modulation is present, the factor value is relative to the note E4. 
- Partial range: 0 Hz up to 5.15 Hz (knob position 0 to 31) and 1:32 upto 64:1 (knob position 32 to 127) relative to the input value on an unattenuated Pitch input on the oscillator module. If the KBT button is on, the partial is relative to the note played on the keyboard (or received via MIDI). If KBT is not active and no Pitch modulation is present, the partial value is relative to the note E4. 

The lowest value in Partial mode is 0 Hz. When an oscillator is at 0 Hz it actually stops oscillating, which causes it to stop generating any sound on its own. At 0 Hz the output will be a DC level (steady level) with a value that depends on both the waveform and the phase position in the waveform at the moment when the oscillator was stopped (was set to 0 Hz). This 0 Hz position can be useful when applying frequency modulation, it presents a special case of linear FM which is used when modulating non-sinewave waveforms like a triangle waveform frequency modulated with a pulse waveform. Bipolar linear frequency modulation of a 0 Hz signal will generate both positive and negative - 180 degrees phase shifted - frequencies and create very interesting timbres. Oscillator B and C plus the two Shape Oscillators feature FM inputs. In these oscillators, you can set the Partial to 0 Hz and then frequency modulate the signal by selecting 'FM Trk' and connecting a modulator signal to the FM input. This technique can produce a virtually unlimited amount of new waveshapes.

THE SEMI (OR FREQ/PART/FAC) KNOB

Changes the coarse tuning of the oscillator. Ranges: depending on frequency display mode (see above).



THE CENT KNOB

Adjust the fine tuning of the oscillator. The range is +/- half a semitone divided into 100 steps. Click on the triangle above the knob to reset the fine tuning to the current coarse tuning value (see above).



PITCH MODULATION

There are one or more **DYNAMIC CONTROL/AUDIO** inputs for modulating the pitch on the oscillators. There can also be a pitch modulation attenuator next to the input of **ATTENUATOR TYPE II**. See "[Pitch modulation](#)" on page 78 for more info.



SYNC MODULATION

The Sync input is used for synchronizing the oscillator with a control source, which could be another oscillator, an LFO or the keyboard gate signal. Synchronization forces the oscillator to restart its waveform cycle, in sync with the signal of the controlling device. The oscillator will restart whenever the syncing signal on this input goes from a negative to a positive amplitude value. Waveforms with a flank, like the sawtooth or pulse waveforms, will restart at a flank, while waveforms without a flank like the sine and triangle waveforms will restart at a zero value.



The pitch of the controlling oscillator will interact with the controlled oscillator pitch. For a traditional synthesizer sync-sound, start with two oscillators set to the same pitch and connect only the synced oscillator to an output. Turning the tuning knob or modulating the pitch of the sync-controlled oscillator will produce radical changes in the timbre. In general the synced oscillator is tuned higher as the syncing

oscillator, causing the syncing oscillator to define the pitch and the synced oscillator to define the timbre. See “[Oscillator Sync](#)” on page 79 for more information.

SHAPE AND SHAPE MODULATION

Use the Shape knob to set the initial shape of waveform. The shape range is from 50% to 99%.

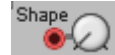

There is also an input for controlling the shape of the selected waveform from a modulator, starting at the initial value set with the Shape control. The modulation amount is determined by the rotary knob next to the input of **ATTENUATOR TYPE I**. See [page 78](#) for modulation examples.

FM LIN/FM TRK

Some oscillators feature an FM scroll button in combination with an FM input and an attenuator of **ATTENUATOR TYPE II**. A signal on the FM input will affect the oscillator signal frequency according to the following:



The Nord Modular G2 system features different types of FM. Using the FM input with the Lin/Trk option produces true linear FM, meaning that it is the actual (internal) linear frequency parameter of the oscillator that is modulated. The difference between FM Lin and FM Trk is that FM Lin causes a constant frequency deviation and FM Trk causes a constant modulation index over the keyboard range. This means that when the modulated oscillator is in ‘FM Trk’ mode, it will keep the new waveshape the same over the keyboard range. The waveshape can change shape dynamically when the FM knob is opened and in general will produce a brighter sound when the modulation depth is increased. If the modulated oscillator is in FM Lin mode, FM modulation will cause a waveform with a sound spectrum with a strong fixed formant structure, where the form and position in the sound spectrum of this formant structure depends on the modulation depth set by the FM knob and the waveforms used. A common way to use both FM Lin and FM Trk is to use a triangle or pulse waveform for the modulating signal on the FM input and use a flankless waveform like a triangle or sine waveform on the modulated oscillator. Then connect the output of the modulated oscillator to the envelope generator audio input. See “[Frequency modulation \(FM\)](#)” on page 78 for more info.

KBT

KBT, **KeyBoard Tracking**, is the internal connection between the oscillator and the keyboard (and the MIDI input). If KBT is activated the oscillator will track the keyboard. If KBT is not activated, the keyboard will not affect the oscillator frequency.



ON/OFF

Click to mute the output of the oscillator. Blue button color indicates that the oscillator is ON



OUTPUT

The signal output on the oscillator. Signal: **BIPOLAR**



OSCA

This oscillator can produce one of six waveforms: Sine, Triangle, Sawtooth, Square, 25% Pulse or 10% Pulse.

The oscillator has two pitch modulation inputs. See also “[Common Oscillator parameters](#)”.



OscB

OscillatorB can produce one of five waveforms: Sine, Triangle, Sawtooth, Pulse with selectable asymmetric pulse width, Pulse with selectable symmetric pulse width and DualSaw. The oscillator has two pitch modulation inputs, one frequency modulation input, one sync modulation input and a Shape modulation input.



SHAPABLE WAVEFORMS

The fourth waveform is Pulse with selectable pulse width. This is the type of waveform found in most analog synthesizers. At 50% Shape setting, the signal is a perfect Square, at 75% a Pulse with 25/75% pulse width and at 99% a Pulse with 1/99% pulse width. When the Shape is modulated with negative values, the signal is “mirrored”.

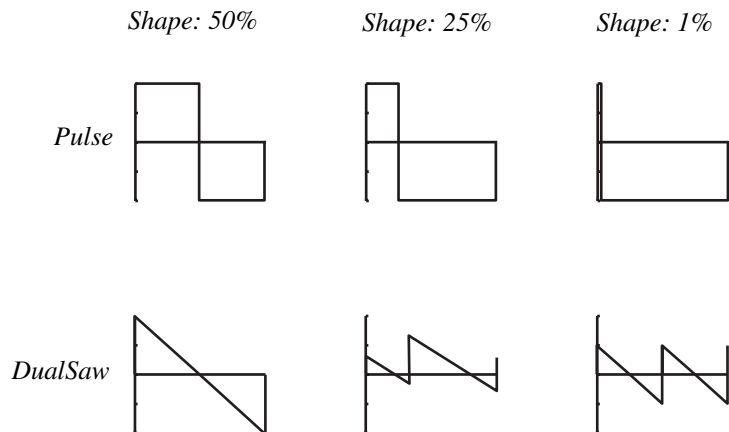

The fifth waveform is a DualSaw.

At 50% Shape setting, the signal consists of two Sawtooth waves in phase with each other, at 75% two Sawtooth waves slightly phase shifted and at 99% two Sawtooth waves 90 degrees phase shifted. When the Shape is modulated with negative values, the signal is “mirrored”. See also ["Common Oscillator parameters"](#).

EXAMPLE OF USING THE DUALSAW

This is an example on how to use the DualSaw waveform to create the sound of two steadily detuned sawtooth waveforms. When a Lfo sawtooth is used and the Shape modulation knob is fully open the same signal is produced as when mixing two sawtooth oscillators (note that when the Shape modulation knob is not fully open it will cause clicks in the sound). One of the two oscillator sawtooths will have the normal pitch of the oscillator, while the other sawtooth is detuned by a frequency which is equal to the rate of the Lfo sawtooth. Depending on whether the Lfo sawtooth is sloping up or down the second oscillator sawtooth is detuned down or up. The detuning of the second sawtooth is an equal amount of Hz over the keyboard range, making the detuned sound too lively in the lower and too static in the higher frequency ranges. Assigning the keyboard morph to the Lfo rate knob can correct the detune, making the unisono effect sound more balanced over the whole keyboard range.

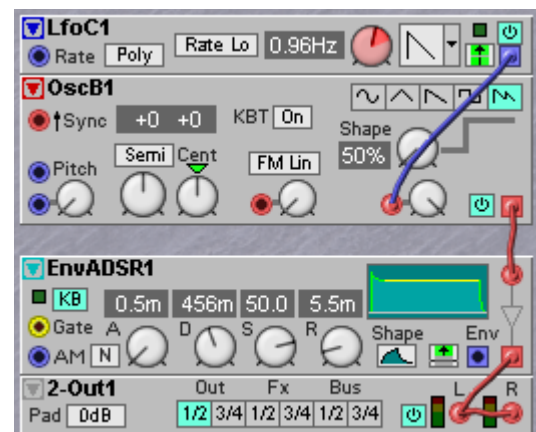

OscC

This oscillator produces one of six available waveforms. It also has two pitch modulation input. The oscillator has the same waveforms as OscA but uses less Patch Load because of the waveform drop-down selector, meaning that waveforms must be preselected in the Editor program. See also ["Common Oscillator parameters"](#).

**OscD**

This oscillator is similar to OscillatorC but has less modulation inputs. See also ["Common Oscillator parameters"](#).

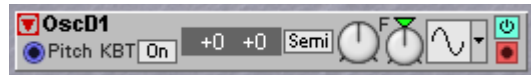
**OscPM**

The Phase Modulation Oscillator uses the same basic technology for signal generation as the DX7. By constantly modulating the phase of a signal, an "FM" type of signal is generated. The frequency bands track the basic pitch similar to the 'FM Trk' modulation in OscB and C described above but with slightly different characteristics. The OscPH also features inputs for pitch modulation and sync. See also ["Common Oscillator parameters"](#).



With this type of FM it is actually the phase of the waveform which is modulated, which means that the waveform is shifted forwards and backwards at a fast audio rate. The advantage of this method is that the modulation is not sensitive for what is named a DC component in the modulating signal. A DC component shifts the waveform upwards or downwards, making its long term average a positive or negative level. With true linear frequency modulation a DC component can detune the oscillator, which happens with the the oscillators with the FM Lin and FM Trk modes. But when the phase is modulated instead of the linear frequency parameter this detuning can never happen. This detuning is especially an issue when selfmodulation by feedback of the output to the modulation input is used. Selfmodulation works only reliable on this OscPM oscillator.

Tip! If the OscPM is set to 0 Hz in the Part tuning mode and initially reset by a short pulse on the Sync input (e.g. by using the Status module Var. Change output) this module can act as a sine function. To use this option, open the Phase Mod knob fully and add a linear mixer in front of the Phase Mod input. If the linear mixer knob is set to [6.3 (8)], a control signal between -64 and +64 units will cover exactly 360 degrees of a sine function. The sine value will be available on the output of the module.

OscShPA

This Shape oscillator is able to generate a vast variety of waveform shapes. There are six basic waveforms to choose from. Since you can transform and modulate the shape of each of these waveforms, it's possible to generate very interesting signals with very varying harmonic content. The principle for all Sinewave based signals is to start with a signal with a pure sinewave and then, by gradually transforming the signal, adding more overtones and creating a more complex and rich signal. The sonic result of changing the shape is



similar to running a complex signal through a filter and changing the cutoff frequency. The oscillator also has inputs for modulating pitch and frequency (FM) as well as sync.

WAVEFORMS AND SHAPES

Sine1 is a phase modulated sine wave. At 50% Shape setting, the signal is a perfect sine wave and at 99% similar to a sawtooth wave. When the Shape is modulated with negative values, the signal is “mirrored”.

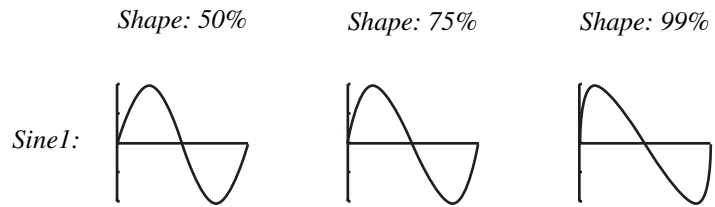

Sine2 is a Sine -> Double Sine signal. At 50% Shape setting, the signal is a pure sine wave and at 99% Shape setting, the first half of the period almost covers the entire period length and the second half is a very narrow “spike”. When the Shape is modulated with negative values, the signal is “mirrored”.



Sine3 is a Sine -> Even harmonics signal. At 50% Shape setting, the signal is a perfect sine wave and at 99% a lot of even harmonics have been added. When the Shape is modulated with negative values, the signal is limited at pure sine wave shape.



Sine4 is a Sine -> Odd harmonics signal. At 50% Shape setting, the signal is a perfect sine wave and at 99% a lot of odd harmonics have been added. When the Shape is modulated with negative values, the signal is limited at pure sine wave shape.

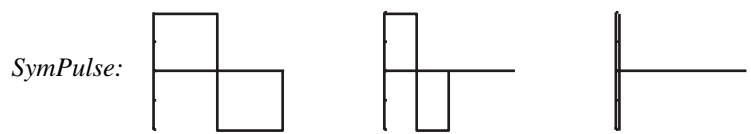
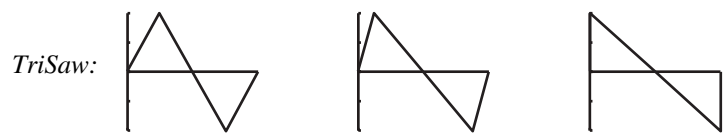
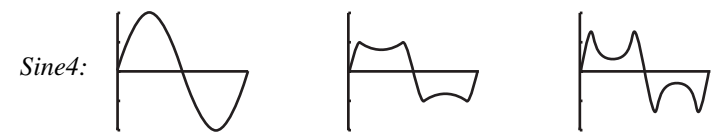

TriSaw is a Triangle -> Sawtooth signal. At 50% Shape setting, the signal is a perfect Triangle and at 99% a perfect Sawtooth. When the Shape is modulated with negative values, the signal is “mirrored”.

The last signal is a Pulse with selectable **SYMMETRIC** pulse width. At 50% Shape setting, the signal is a perfect Square, at 75% a Pulse with 25% symmetric pulse width and at 99% a Pulse with 1% symmetric pulse width. When the Shape is modulated with negative values, the signal is “mirrored”. See also ["Common Oscillator parameters"](#) and ["Shape Oscillator tips"](#) (below).

OscShpB

This Shape oscillator is able to generate a vast variety of waveform shapes. There are eight basic waveforms to choose between and since you can transform and modulate the shape of these waveforms, it's possible to generate very interesting and varying signals.



WAVEFORMS AND SHAPES

Sine1 is a phase modulated sine wave. At 50% Shape setting, the signal is a perfect sine wave and at 99% similar to a sawtooth wave. When the Shape is modulated with negative values, the signal is “mirrored”.

Sine2 is a Sine -> Double Sine signal. At 50% Shape setting, the signal is a pure sine wave and at 99% Shape setting, the first half of the period almost covers the entire period length and the second half is a very narrow “spike”. When the Shape is modulated with negative values, the signal is “mirrored”.

Sine3 is a Sine -> Even harmonics signal. At 50% Shape setting, the signal is a perfect sine wave and at 99% a lot of even harmonics have been added. When the Shape is modulated with negative values, the signal is limited at pure sine wave shape.

Sine4 is a Sine -> Odd harmonics signal. At 50% Shape setting, the signal is a perfect sine wave and at 99% a lot of odd harmonics have been added. When the Shape is modulated with negative values, the signal is limited at pure sine wave shape.

TriSaw is a Triangle -> Sawtooth signal. At 50% Shape setting, the signal is a perfect Triangle and at 99% a perfect Sawtooth. When the Shape is modulated with negative values, the signal is “mirrored”.

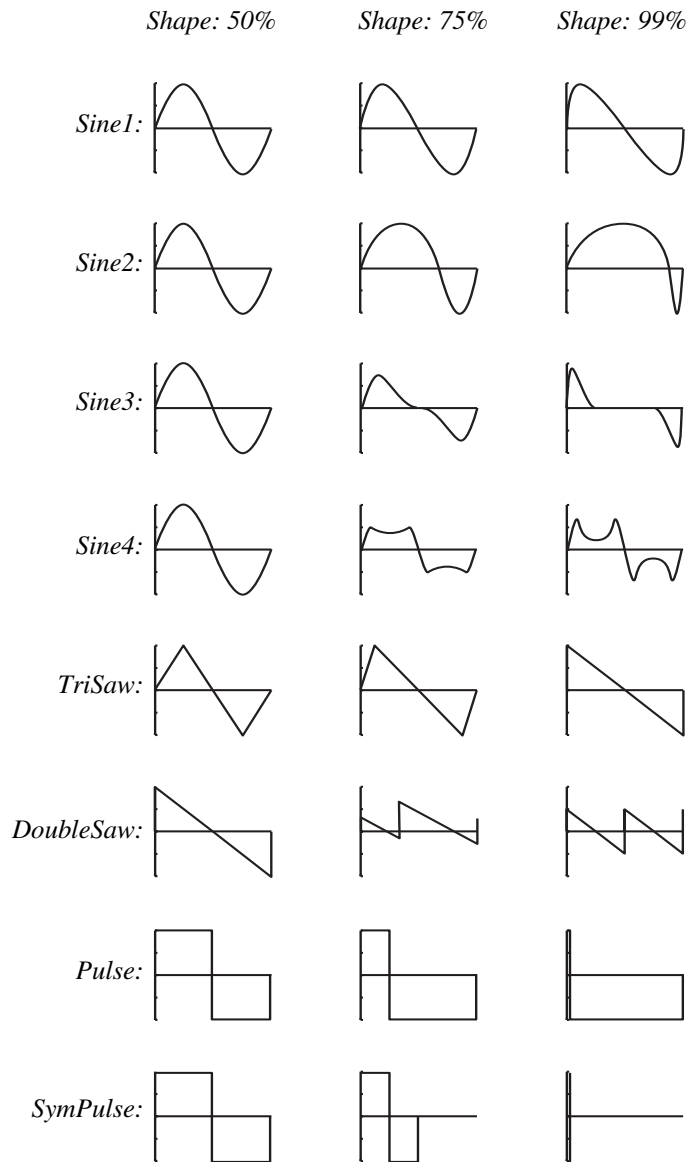

Double Saw signal. At 50% Shape setting, the signal consists of two Sawtooth waves in phase with each other, at 75% two Sawtooth waves slightly phase shifted and at 99% two Sawtooth waves 90 degrees phase shifted. When the Shape is modulated with negative values, the signal is “mirrored”.

Pulse is a Pulse with selectable **ASYMMETRIC** pulse width. This is the type of pulse waveform found in most analog synthesizers. At 50% Shape setting, the signal is a perfect Square, at 75% a Pulse with 25%/75% pulse width and at 99% a Pulse with 1%/99% pulse width. When the Shape is modulated with negative values, the signal is “mirrored”.

SymPulse is a Pulse with selectable **SYMMETRIC** pulse width. At 50% Shape setting, the signal is a perfect Square, at 75% a Pulse with 25% symmetric pulse width and at 99% a Pulse with 1% symmetric pulse width. When the Shape is modulated with negative values, the signal is “mirrored”. If this waveform is modulated with a triangle Lfo waveform it produces a nice ‘raw’ type of PWM sound. See also "[Common Oscillator parameters](#)".

SHAPE OSCILLATOR TIPS

With the Shape Oscillators A and B it’s very easy to create an “analog style” sound without using a Filter. Connect the OscShpB module according to the picture, select the Sine1 waveform and assign the Shape knob to an **ASSIGNABLE KNOB**. Play on the keyboard and turn the **ASSIGNABLE KNOB** to increase the overtone content. The effect is very similar to running a sawtooth wave into a filter and increasing the Filter Cutoff Frequency value.



OscDUAL

The Dual Oscillator produces pulse and sawtooth waveforms and a suboctave with a square waveform. Three mixer knobs set the blend of the three waveforms on the output of the oscillator. The pulse width of the pulse oscillator and the phase of the sawtooth signal can be modulated. The Soft button reduces the overtone content of the suboctave, making the suboctave sound warmer. See also "[Common Oscillator parameters](#)".



EXAMPLE OF THE OSCDUAL

The Dual Oscillator is perfect for creating those classic “analog” polysynth sounds. Connect the modules according to the figure to the right and you’re there. The LfoC1 triangle controls the width of the Pulse wave while the LfoC2 sawtooth modulates the Phase of the Sawtooth wave which gives the sound a subtle unisono effect (similar to the modulation example of the DualSaw on OscB). Note that the Phase knob must be exactly in the central position to avoid clicks in the sawtooth. The Lfo rates are controlled by the keyboard morph group to get a balanced unisono chorusing effect over the keyboard range. Note that this example patch can be played with 24 voices on an unexpanded G2.

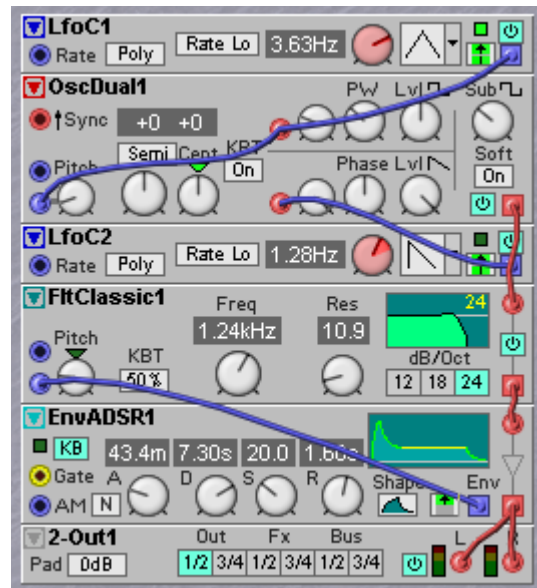
**OSCSTRING**

The String Oscillator is a little different from the other oscillators. One significant difference is that *it requires a short burst of audio on the red input* to be able to produce sound. The Sting Oscillator is basically a delay line with feedback tuned to the keyboard, with controls for decay and damping of the feedback signal. The String Oscillator is ideal for simulating plucked strings. With this module it’s quite easy to simulate an acoustic string instrument like a nylon-string guitar (see example below).

**DECAY**

Set the decay time of the internal feedback signal through the delay line. The higher the decay value, the longer it will take for the signal to decay to silence.

DAMP

Set the high frequency damping of the internal feedback signal through the delay line. The higher the damp value, the more mellow the signal. See also ["Common Oscillator parameters"](#).

EXAMPLE OF THE OSCSTRING

The Sting Oscillator requires some sort of input signal or a pulse to start oscillating. In this example a plucked string instrument is simulated. Feed a short noise burst through an AHD Envelope to the input of the StingOsc. Set all the module parameters according to the picture and you will get sort of a “plucked or hammered string” sound when you play the keyboard. The keyboard morph group is used on the Decay of the String Oscillator and the Hold time of the EnvAHD to get a more balanced sound over the keyboard range.

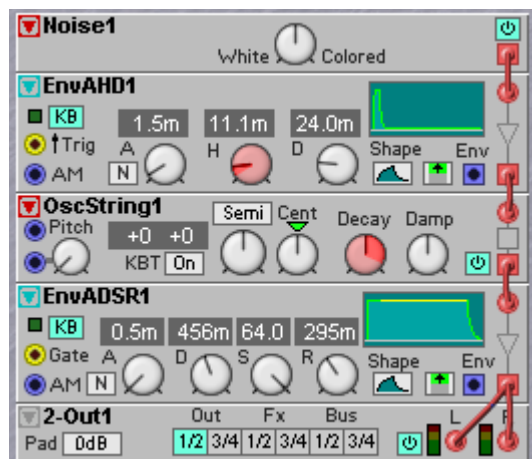

OSC PERC

This oscillator generates a damped sinewave after being triggered on the Trig input.

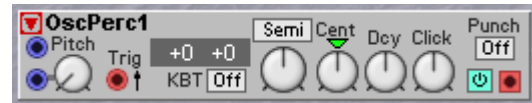

TRIG INPUT

Use this input to trig the sound. The red color of the input indicates that it also accepts audio frequency signals.

DCY

Sets the decay time of the sound.

CLICK

With the Click knob you can add a clicking sound to the attack of the sound.

PUNCH

Adds a distinct attack to the sound by doubling the frequency of the first period of the signal.

DRUMSYNTH

The Drum synth module is designed to generate classic analog drumcomputer or rhythmbox sounds. It consists of a master and a slave oscillator in combination with a noise source and a multimode noise filter. The global parameters include a bend function and a click and noise mixer.



TRIG

The yellow Trig input trigs the Drum synth module each time it receives a signal that changes from 0 units or below to anything above 0 units. This signal could come from a gate output of a Keyboard or Sequencer module, for example. A green LED indicates when a trig signal is received.

VEL MODULATION INPUT

This blue control input is used to receive velocity information from an external source. The input velocity signal will affect Master and Slave Oscillator Level, Noise Filter Sweep, Bend Amount, Click Level and Noise Level. Maximum input velocity will force the parameters to reach their current settings.

PITCH MODULATION INPUT

This blue control input is used to receive pitch data from an external module such as a Keyboard or Sequencer module, for example.

MASTER AND SLAVE DISPLAY BOXES

The Master display box shows the master pitch in Hz, and the Slave display box the pitch ratio related to the master pitch. Range: Master: 20.0 Hz to 784 Hz. Slave: 1:1 to 6.26.

MASTER AND SLAVE KNOBS

These are the parameters of the two oscillators that generate the basic drum waveform.

TUNE: The tune of the Master can be set between 20.0 and 784 Hz. The Slave ranges from 1 to 6.26 times the Master frequency.

DCY: Decay determines the decay time for each oscillator. Range: 0.5 ms to 45 s.

LEV: With the Level knobs you set the respective volume of the two oscillators.

NOISE FILTER

Here you can filter and affect the noise component of the Drum synth module.

FREQ: With the Freq knob you set the cutoff frequency of the noise. Range: 10 Hz to 15.8 kHz.

Res: With the Res knob you set the resonance amount around the cutoff frequency.

Swp: With the Sweep knob you set a sweep range for the cutoff frequency. The setting results in a sweep from a high cutoff frequency down to the frequency you set with the Freq knob. Range: 0 to 5 octaves.

Dcy: The Decay knob sets the noise sweep and decay time. Range: 0.5 ms to 45 s.

HP/BP/LP: Click on the HP, BP or LP button to select filter mode: highpass, bandpass or lowpass.

BEND

Bend is a global function for the Master and Slave oscillators.

Amt: With the Amt knob you set the bend amount, i.e. the frequency range to bend through. The bending always start from the higher frequency and sweeps down in frequency. Range: 0 to 5 octaves.

Dcy: With the Dcy knob you set the bend decay time. The bend time can be considered more as a bend rate, since the actual decay time is determined by the Decay knobs of the two oscillators. Range: 0.5 to 45 s.

CLICK

With the Click knob you can add a clicking sound to the attack of the sound.

NOISE

With the Noise knob you set the noise level in the total mix.

PRESET

Here you can choose between a number of factory presets by clicking on the up or down buttons. The preset name is shown in the display box.

NOISE

This module produces a noise signal, the noise timbre is selectable from white (very bright) to colored (low rumble).

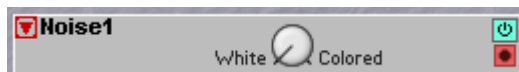
**WHITE/COLORED**

Set the color of the noise with the control knob. Colored noise contains less high frequency energy than white noise. See also "[Common Oscillator parameters](#)".

METNOISE

The metallic noise generator produces a noisy signal with a bright metallic timbre. The timbre is created by a dense cloud of short pulses with carefully detuned frequency relations, creating clusters of high pitched partials in its audio spectrum. This type of noise is useful to create the metallic sounds made by acoustic cymbals and hihats.

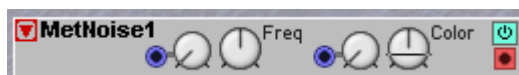
**FREQ**

The Freq knob controls the basic pitch sensation of the metallic noise timbre.

COLOR

The Color knob acts like a highpass filter. When the Color knob is turned to the right it will pull the timbre away into the highest parts of the audio range.

TIPS ON CREATING CYMBALS SOUNDS

If this module is used to make a cymbal sound the combination of the Freq and Color knobs sets the basic size and timbre of the cymbal. An extra envelope generator module will be needed to create the cymbal sound. The shape and dynamics of the envelope that is applied to the metallic noise, plus perhaps some additional filtering, may set where and how hard the cymbal is hit, e.g. on the edge or at the cup. Note that the shape of the applied envelope is as important as the Freq and Color settings to create convincing cymbal sounds.

Applying a random signal to the modulation inputs can create a lively modulated cymbal pattern. The effect will sound the most convincing when the random value only changes on each new hit. In general just a tiny amount of modulation depth on the Freq input is already enough. The random value can be generated by a clocked random generator or by using a Sample&Hold module sampling a varying waveform like a triangle wave. By using the Keyboard Velocity value the timbre of the cymbal sound can be varied by the keyboard or from a MIDI sequencer program. The setting of the modulation amount knobs can best be tweaked by ear to get the timbre variations to your own taste.

OSCNNOISE

The noise oscillator produces a narrow band of noise. The bandwidth can be so narrow that the noise will have a distinct pitched character, sounding like a noisy sine wave.



WIDTH

The Width knob sets the bandwidth of the band of noise. By opening the Width knob the noise can be tweaked between a lively fluctuating sine wave, through a noisy whistle, to a wide band of noise. When the Width knob is fully opened the bandwidth is about two octaves.

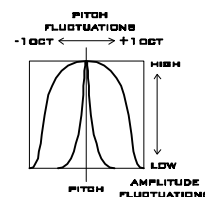

TIPS ON USING THE NOISE OSCILLATOR

The noise oscillator can be used in drawbar organ sounds, which are in general created by adding the outputs of several sine wave oscillators tuned to the overtones of the basic pitches on the keyboard. By replacing a few of the sine wave oscillators with noise oscillators a drawbar organ sound will get a lively character, sounding more like a pipe organ where the narrow band of noise simulates the turbulence of the stream of air in a pipe.

Note that by using the Partial tuning setting the oscillator can be easily tuned to the overtone of the basic pitch of the key played on the keyboard. See also "[Common Oscillator parameters](#)".

OSCMMASTER

The Master Oscillator doesn't generate any audio signal. Instead, it generates a Pitch control signal which can be used to control other Oscillator modules on their Pitch inputs. The combination of the Master Oscillator with a number of other Oscillators makes it possible to simultaneously tune all connected Oscillators from the Master Oscillator instead of having to tune each individual connected Oscillator.



OPERATOR

The Operator module consists of a sinewave oscillator in combination with a Level & Rate amplitude envelope generator and a keyboard level scaler. The Operator module has the same functionality as an ‘operator’ in the well-known DX7 FM synthesizer. Note that as this is a replica of the classic DX7 synth, all the parameters and controls behave like on the DX7. Which means that they behave completely different to how all the normal G2 controls behave. The reason is of course that it should be easy for you to copy an original DX7 sound by setting the controls in this module to the same values as the DX7 sound. This way the copied sound will be a very close approximation. Several Operator modules can be used together with the DXRouter module to form a six operator FM synthesis engine. See [page 185](#) for example.

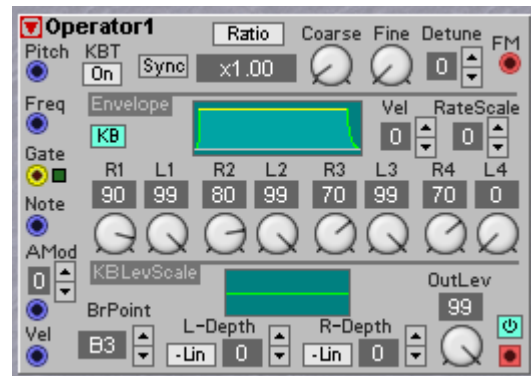

RATIO/FIXED

Select Ratio to set the frequency as a multiple relative to the input value on the Pitch input. Select Fixed to set the frequency as a fixed number of Hz relative to the Pitch input value. If the KBT button is on, the value is relative to the note played on the keyboard (or received via MIDI). If KBT is not active and no Pitch modulation is present, the value is relative to the note E4.

DETUNE

Here you can fine adjust the pitch in even smaller steps than with the Fine knob. Range -7 to 7.

FM INPUT

A modulator connected to the FM input will modulate the operator frequency in a linear fashion.

PITCH INPUT

Input for pitch modulation. An input value of +32 units will generate zero modulation. An input value of 0 units will generate 0 Hz pitch output from the Operator and an input value of +64 units will generate a pitch twice as high as the Operator pitch. If left unconnected, the modulation will be zero.

VEL

Select velocity sensitivity with the arrow buttons for the velocity signal received at the Vel input. Range 0-7 where 7 is the highest sensitivity.

RATESCALE

Select the envelope rate scaling with the arrow buttons for the note signals received at the Note input. Range 0-7. The higher the RateScale value, the faster the envelope rates at higher notes.

GATE INPUT

A signal at the Gate input will gate the envelope.

NOTE INPUT

A signal present at the Note input will affect all the rates of the envelope if the RateScale value is higher than 0 (see above). It will also affect the Keyboard Level Scaler (see below).

R1-R4 & L1-L4

Here you set the rates (R) and Levels (L) of the envelope. The lower the Rate values, the longer it will take for the envelope to reach the next Level. L3 is the level at which the envelope will sustain.

Note that the Level settings also affect the Rates. The greater the difference between two adjacent Level settings, the longer it will take to “travel” between the Levels. If two adjacent Level settings are the same, the Rate value between these levels is of no importance.

AMOD

This is the function for modulating the amplitude with a bipolar control signal. Patch a control signal to the AMod input and set the sensitivity with the arrow buttons. Range 0-7 where 7 is the highest sensitivity.

VEL INPUT

Here you control the levels of the level & rate envelope generator. The velocity sensitivity is set with the Vel arrow buttons as described above. Note that lower envelope levels means that the entire envelope cycle becomes faster!

BRPOINT

Set the break point note number for the Keyboard Level Scaler. The value is displayed in the corresponding display box. Range: A-1 to C8.

-LIN/-EXP/+EXP/+LIN

Click to select Linear or Exponential attenuation or amplification characteristics of the level scaling.

L-DEPTH

Set the amplification/attenuation slope for the lower key section with the arrow buttons. The value is displayed in the corresponding display box.

R-DEPTH

Set the amplification/attenuation slope for the upper key section with the arrow buttons. The value is displayed in the corresponding display box.

GRAPH

Displays the two gain slopes and the break point graphically. The Y-axis represents the output level and the X-axis the entire note range (A-1 to C8). the horizontal line represents the 0 dB output level.

DXROUTER

The DXRouter module is intended for use with the Operator modules described on [page 184](#). It works exactly like the Algorithm selector on the DX7 synthesizer, i.e. it routes the Operator output signals either to Operator FM inputs or to the audio mix output and allows for different types of FM synthesis.

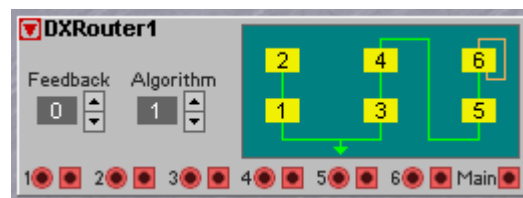
**FEEDBACK**

Select the internal feedback amount for the connected Operator. An internal feedback loop is indicated with orange lines in the DXRouter graph. Range 0-7.

ALGORITHM

Select one of 32 different algorithms (connection paths) for the connected Operator modules. These 32 algorithms corresponds to the factory algorithms of the DX7 synthesizer. The algorithms are shown in the graph.

EXAMPLE

Below is an example of the DXRouter module used together with six Operator modules to form a basic DX7 configuration. Connect each Operator output to the corresponding input of the DXRouter module. Connect each output of the DXRouter module to the corresponding FM input of each Operator.

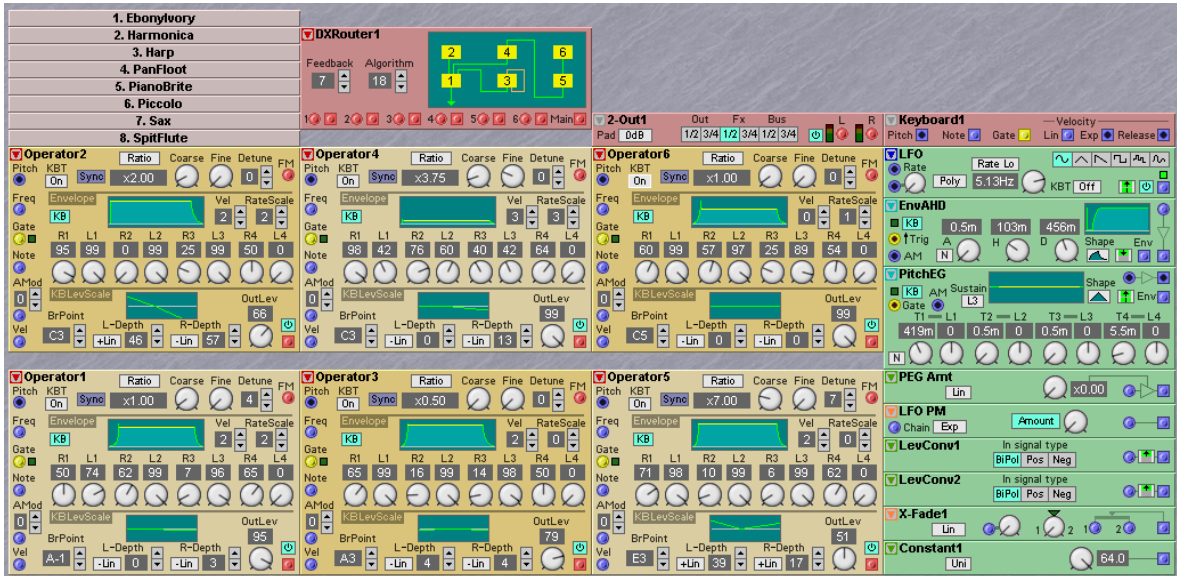

In the example above, algorithm 18 is used. If you look in the graph you can see that the output signals of Operator 1 is mixed to the DXRouter output. You can also see that Operator 2, 3 and 4 are frequency modulating Operator 1, Operator 6 is frequency modulating Operator 5 and Operator 5 is frequency modulating Operator 4. Operator 3 also has an internal feedback loop as indicated by the orange line. The internal feedback amount of Operator 3 in this algorithm can be set with the Feedback selector on the DXRouter module.

LFO GROUP

LFOs or Low Frequency Oscillator modules are used to create varying control signals for periodic modulations. The waveforms they produce can be used for vibrato, tremolo or as clock sources. Some of the LFOs in Nord Modular G2 have a very wide frequency range, from very low to frequencies in the audio range.

COMMON LFO PARAMETERS

WAVEFORM RADIO BUTTONS

LFO A, B and ShpA have waveform selectors of radio button type. All waveforms in these LFOs are instantly available by clicking the desired waveform button.



WAVEFORM DROP-DOWN SELECTORS

LFO C has a drop-down waveform selector. The different waveforms of LFO C are not instantly available as in the “radio button” LFO described above. The advantage of this is that LFO C uses less Patch Load. However, changing waveform in LFO C will force the Sound engine to recalculate and thus cause a brief moment of silence. So if you’re looking for lower Patch Load, use this LFO instead of the “radio button” one.



WAVEFORM GRAPH

LFO B and ShpA have graphical display of the waveform with phase and shape (LFO ShpA). The yellow number to the bottom left indicates the current Phase setting in degrees.

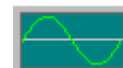

RATE LO/RATE HI/BPM/CLK/RATE SUB SCROLL BUTTON

Selects one of three ranges of the LFO rate: Rate Lo (normal), Rate Hi and Rate Sub, plus BPM and Master Clock Sync mode. The Rate Lo range is from 62.9 secs/cycle to 24.4 Hz, the Rate Hi range is from 0.26 Hz to 392 Hz, the Rate Sub range is from 699 secs/cycle to 5.46 secs/cycle. The BPM range is from 24 to 214. The Clk sync mode automatically locks on to the synth’s Master Clock and here you set the intervals between 64:1 and 1:64T. The ‘T’ (triplet) indicates that the note value is 4/3 times the original note value and the ‘D’ (dotted) indicates that the note value is 3/2 times the original note value.



Note that the Clk sync mode is only available in the LfoB and LfoShpA modules.

RATE

Set the rate of the LFO with the knob. The Output LED will show you an approximation of the rate, while the display box will indicate the exact frequency in Hertz, seconds, BPM or Sync factor.



PHASE

Set the phase of the LFO signal. The phase is shown, in degrees, in the Display Box and also in the Graph. The phase can also be modulated from an external source. The modulation amount can be attenuated with the knob of [Attenuator Type I].



PITCH MODULATION INPUT

There are one or more **CONTROL** signal inputs for a modulation source to control the pitch of the LFO. There can also be a modulation attenuator next to the input of [ATTENUATOR TYPE II].



RST INPUT

An input signal which goes from 0 units or below to anything above 0 units will force the LFO to restart its waveform cycle.



SNc OUTPUT

The Snc (Sync) output sends out a high logic signal every time a new waveform period starts. This signal can be used to restart other LFOs on their Rst input (see above) in order to sync the rates and phase lock the signals.



POLY/MONO

Mono mode synchronizes the LFO modules in polyphonic patches to each other. This means that if you play a chord, the module will control all voices in sync. The preset setting of this parameter is Poly. Note that if you use the Clk (clock sync) rate mode (LfoB and LfoShpA), Mono mode will synchronise the frequency and the phase of the LFOs, whereas Poly mode will only sync the frequency of the LFOs.



KBT SCROLL BUTTON

KBT, **KeyBoard Tracking**, is the hard-wired connection between the LFO rate/pitch and the keyboard (and the MIDI input). Click to select Off, 25%, 50%, 75% or 100%. If KBT is set to 100%, the LFO will track the keyboard at the rate of one semitone for each key. If KBT is set to Off, the keyboard will not affect the LFO rate. Note that if you use the Clk (clock sync) rate mode (LfoB and LfoShpA), the KBT setting will have no effect.



OUTPUT TYPE SCROLL BUTTON

With the Output Type scroll button you determine how the LFO signal should be output. There are six different alternatives:



- **BIP**: Bipolar signal ranging from -64 to +64 units, peak to peak.
- **BIPINV**: Bipolar signal ranging from -64 to +64 units, peak to peak but 180 degrees phase shifted compared to the 'Bip' alternative above.
- **POS**: Positive Unipolar signal ranging from 0 to +64 units, peak to peak.
- **POSINV**: Positive Unipolar signal ranging from 0 to +64 units, peak to peak but 180 degrees phase shifted compared to the 'Pos' alternative above.
- **NEG**: Negative Unipolar signal ranging from 0 to -64 units, peak to peak.
- **NEGINV**: Negative Unipolar signal ranging from 0 to -64 units, peak to peak but 180 degrees phase shifted compared to the 'Neg' alternative above.

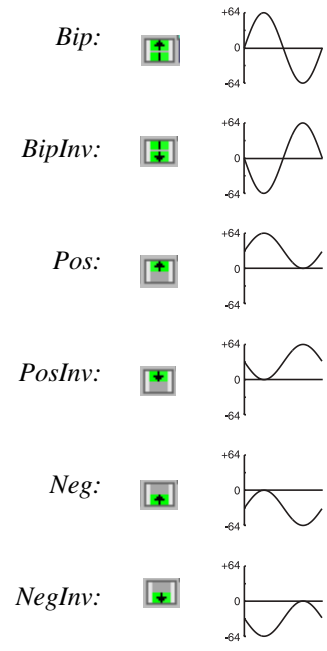

ON/OFF

Click to mute the output of the LFO. Blue button color indicates On.



OUTPUT

The signal output on the LFO. Signal: **BIPOLAR OR UNIPOLAR** depending on Output Type selection (see above).



LFOA

LFO A produces one of six different control signals. The rate of the LFO can be modulated from external sources.

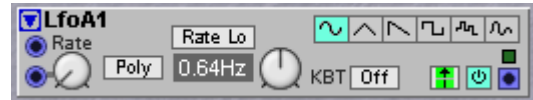

WAVEFORMS

Select waveform with the radio buttons. The waveforms are: Sine, Triangle, Sawtooth, Square, Random Steps and Random. The Random Steps signal is “colored” meaning that the effect is more gentle than a true random signal. It contains less radical differences between adjacent values. The Random signal is a smooth random control signal. See also ["Common LFO parameters"](#).

LFOB

LFO B generates one of four different control signals. The phase of the signal can be controlled and modulated. The rate of the LFO can be modulated by a modulation source and the keyboard. The wave cycle can also be forced to restart via the Rst input. See also ["Common LFO parameters"](#).



LFOC

This LFO produces one of six selectable waveforms. The rate of the LFO can be modulated. LfoE has the same wave shapes as LfoA but uses less Patch Load because of the drop-down waveform selector. See also ["Common LFO parameters"](#).

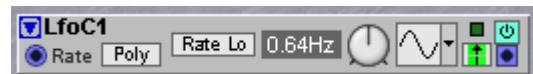

LFO SHPA

LfoShpA generates one of six different shapable control signals. The shape and phase of the signal can be controlled and modulated. The rate of the LFO can be modulated by a modulation source and the keyboard. The wave cycle can also be forced to restart via the Rst input. It’s also possible to alter the rate and “direction” of the signal via the Dir input (see below).



WAVEFORMS AND SHAPES

Select one of six shapable LFO waveforms by clicking one of the radio buttons. The waveforms are:

‘Sine’ is a sine>sawtooth type of signal. At 50% Shape, the signal is a pure sine wave. At 1% Shape, the signal is a “down sawtooth” and at 99% Shape, an “up sawtooth” signal.

‘CosBell’ is a cosine signal with variable “width”. At 1% Shape, the signal has a very narrow peak which expands with increasing Shape amount up to 99%, where the signal is a pure (co)sine wave.

‘TriBell’ is a triangle wave with variable “width”. At 1% Shape, the signal has a very narrow peak which expands with increasing Shape amount up to 99%, where the signal is a pure triangle wave.

‘Saw>Tri’ is a variable sawtooth>triangle wave. 1% Shape, the signal is a “down sawtooth” which transforms into a triangle wave and then to an “up sawtooth” with increasing Shape amount.

‘Tri>Square’ is a triangle wave which gradually transforms into a square wave with increasing Shape amount.

‘Pulse’ is a regular pulse wave with adjustable pulse width, from 1% to 99%.

DIR

The Dir input can be used to continuously control the rate and “direction” of the LFO signal. Let’s say we have set the LFO rate to 200 Hz. An input offset value of +64 units on the Dir input will then make the LFO run at 200 Hz. An input offset value of 0 units will force the LFO to stop completely and an input offset value of -64 units will force the LFO to run at -200 Hz, i.e. produce a 180 degrees phase shifted LFO signal. See also ["Common LFO parameters"](#).

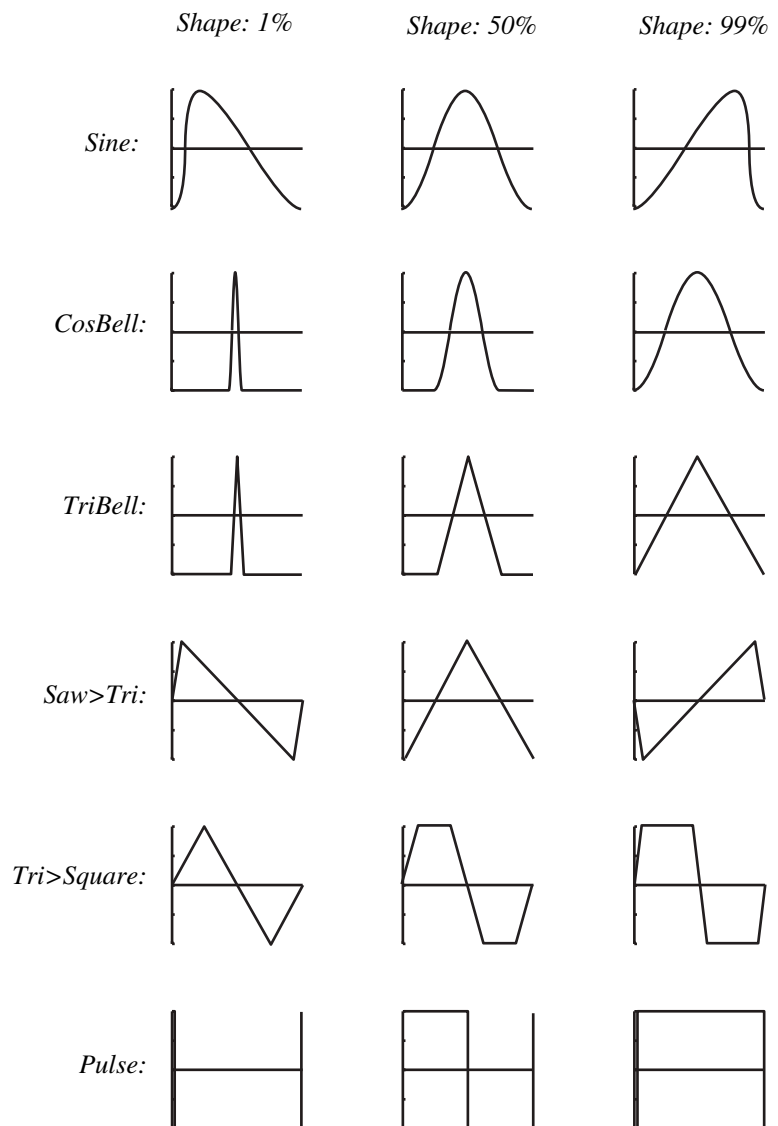

CLKGEN

The Clock Generator module generates a stream of logic signals. The Clock Generator can either act on its own or use the Master Clock signal. If you want to sync to external MIDI CLOCK, you must select Master Clock as Source and then sync the Master Clock to external MIDI CLOCK (see “[Synth Settings {Ctrl-G}](#)” on page 120). For examples on how to use the Clock Generator together with Sequencer modules, see “[Sequencing examples](#)” on page 244.

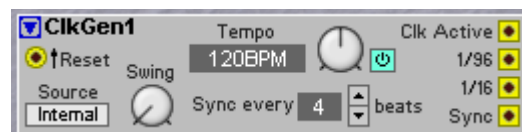

RESET INPUT

The yellow Reset input forces the clock generator to restart on the *positive edge* of a logic HIGH reset pulse. If the reset signal is not a logic signal, e.g. a blue signal, it will first be transformed to a logic signal before being used. This signal could come from a Gate output of a Keyboard module, for example. When the clock generator is reset, it also transmits a high logic signal on the Sync output.

CLOCK SOURCE

Click the scroll button to select Internal or Master Clock signal. If Master is selected, the tempo is selected in the Master Clock section in the Toolbar.

SWING

Set the desired swing factor of the output clock signal. Range: 50%-75%.

TEMPO KNOB

Set the desired tempo, in beats per minute, with the knob. Range: 24 to 214 BPM. The tempo is shown in the display box to the left of the knob. If Master is selected as Clock Source (see above), the tempo is selected in the Master Clock section in the Toolbar.

ON/OFF

Starts and stops the output of clock pulses.

SYNC EVERY NN BEATS

Here you set the interval for sending a logic pulse on the Sync output of the Clock Generator module. This logic pulse can be used for resetting the sequencer modules in Nord Modular G2 to the “first beat in the bar”. If you do not use the Sync function, the sequencer modules have no chance of knowing where they are in a bar. By using the Sync function, it will never take longer than the set number of beats for the sequencer modules to realign themselves if you decide to start your sequencer modules in the middle of a song.

If you are synchronizing Nord Modular G2 to a MIDI Clock source, this function will also keep track of any incoming MIDI Song Position Pointer messages.

ACTIVE OUTPUT

This yellow output provides you with a logic HIGH signal when the Click Generator is switched on in Internal Clock Source mode. If you have selected Master Clock Source, the Active output will send a logic HIGH signal as soon as a MIDI Start or MIDI Continue command is received at the **MIDI IN** port. The logic signal will switch back to LOW when Nord Modular G2 receives a MIDI Stop signal at the **MIDI IN** port. When the G2 does not receive MIDI CLOCK the active output will follow the RUN/STOP state of the G2 Master Clock.

Signal: **Logic**.

1/96 OUTPUT

This yellow output transmits 96 clock pulses per quarter bar (or 24 clock pulses for each quarter note).
Signal: **Logic**.

1/16 OUTPUT

This yellow output transmits 16 clock pulses per quarter bar (or 4 clock pulses for each quarter note).
Signal: **Logic**.

SYNC OUTPUT

This yellow output provides you with a logic pulse, which is calculated from the Clock signal, at a rate set by the 'Sync every nn beats' parameter mentioned above. The Sync function provides a method of telling the Nord Modular G2 sequencer modules where the first beat in a bar is. Patch this output to the Rst (reset) input of the sequencer modules. This function is absolutely essential to use if you plan to synchronize patches in different slots to each other, or if you want to synchronize Nord Modular G2 to an external sequencer. Signal: **Logic**.

- Try to make a habit out of always using this function if you are using more than one sequencer module in a patch, especially if you want to mix modules clocked with e.g. triplet resolutions with other modules clocked with eighth or sixteenth notes.

See also "[Common LFO parameters](#)".

RANDOM GROUP

Random signal generators can be used to create random variations in a sound. This class of modules is closely related to audio noise generators, as noise is also a random signal. But while noise is an audio signal where each frequency in the hearing range is present, randomness is not about audio frequencies but about generating sequences of random values to be used as control signals. Random values can be used to e.g. give human feel to musical events like key presses, sequenced notes, etc. In practice random signal generators produce a constantly changing sequence of values on their outputs, where each next value appears to be randomly chosen. Still, a new value is always generated in some relation to a previous value and it is this relation to the previous value that defines how the sequence of values evolves over a longer time. When there are only little differences to the previous values, the signal will evolve gradually. But when there are a lot of differences the signal might evolve wildly and appear to jump all over the place. The random signals can be smooth control signals or stepped signals. Some random signal generators can be run at audio rate, in which case their output signal will sound like common audio noise. Tweaking the controls on the module will change the timbre of the noise.

The G2 offers two classes of random signal generator modules, depending on whether the next value is initiated by an internally generated clock or an external clock signal. The class with the internal clock creates a continuously evolving signal and modules in this class are similar to LFO's with a random waveform output, but the dedicated random modules offer much more control over the random wave shape. Modules in this class have Rate controls to set the rate at which new values are generated. The other class of random modules creates a new random value after receiving a trigger command from a clock signal, hence their name 'clocked random generators'. Modules in this class lack Rate controls, instead they need a gate or oscillator signal connected to their trigger input to produce a new value. Clocked random generators are very useful to add some human feel to a musical event. E.g. when the keyboard gate is used to trigger a clocked random generator, there is a random signal available which can vary the cutoff frequency of a filter, create a slight detune of an oscillator, etc. Clocked random generators are also very useful to varyate sequencer patterns or are used to play notes at random. When the modules are clocked by the ClockGenerator module 1/16th output and the ClockGenerator module is set to the Master setting, the random steps will be synced to Midiclock, either by the G2 internal Midi Masterclock or by the Midiclock signal that is received on the Midi In connector. Patching an EventSeq module between the ClockGenerator output and a clocked random signal generator makes it possible to define exactly on which notes in a bar a new random value is created.

Locking by a red or orange signal will change the clocked modules into audio mode. In this mode the module can be clocked at variable clock rates up to 48kHz, turning the module into a flexible 'LoFi' noise generator.

COMMON RANDOM GENERATOR PARAMETERS

RATE

The Rate controls and Pitch inputs work exactly the same as those on the Lfo modules, read the section on Common Lfo parameters in the Lfo section to learn more about their workings.

See also "[Common LFO parameters](#)".



POLY

When the Mono/Poly control is in Mono mode it will use the same pattern for all voices in a Patch. When set to Poly mode the module will instead create different patterns for each voice. In other words, if set to Mono the voices share one global pattern from the Random module, and if set to Poly mode each voice has its own individual pattern that is different to the pattern in another voice.



STEP

This setting controls the possible difference between a new value and its previous value. When set to 100% the difference might be from the lowest extreme value to the highest extreme value, although such a big step will occur only rarely. When lowering the step percentage value the average difference to the previous step becomes smaller. A very low step percentage value will create a signal that evolves so slowly that the changing is hardly noticed. Still, over a long time the signal can change over quite a big range. 

EDGE

Edge causes glides between the steps. When a random signal generator is used at low speed the Edge setting will create a portamento effect between the steps. At audio rates the Edge function can filter away possible zipper caused by stepping from one value to the next value. 

CLOCKED RANDOM GENERATOR INPUTS AND PARAMETERS**CLOCK INPUT**

The clock input accepts a waveform that can be a blue signal, a yellow signal or a red signal. Every time the signal on the clock input changes its value from a zero or negative value to a positive value, the output of the clocked random generator changes value. 

If the clocked random generator produces a yellow pulse or a state wave shape, the clock works slightly differently. For these two cases the module will either pass on the input clock pulse or instead block the input clock pulse. On the next input clock pulse a new decision is made to either block or pass the input pulse signal.

PROB (=PROBABILITY)

This setting applies to the random trigger wave shapes on the RndTrig and RndPattern modules. A random trigger signal is a pulse signal that is either a logic HIGH or a logic LOW, where the state of the output refers to either the HIGH state or the LOW state. When the RndTrig module is clocked by a 1 Hz clock signal, every once a second there is the chance for the state to change from the LOW state to the HIGH state and stay HIGH during the time the input clock signal is HIGH or the value on the Clk input is greater than zero. When Prob is set close to 100% it means that there is a very high probability that an output pulse will be passed on every second, creating almost the original signal but with an occasional hiccup now and then. When Prob is close to 1% the probability that an output trigger will be passed on is low, meaning that over a longer time much less output pulses will occur. In effect it will 'thin out' the train of clock pulses from the input. 

On the RndPattern module, which can produce state signals (a state signal is basically an analog pulse wave shape alternating between -64 and +64 units), the probability of occurrence can be set by the combined Step/Prob control.

So, when a random module is in random trigger mode it first waits for a trigger pulse to arrive. The moment the pulse arrives it decides whether to let this trigger pulse through to the output or block it until the next trigger pulse arrives. So, it is a little bit like a switch is opened or closed at random on the moment the trigger pulse arrives and this switch passes or blocks this incoming trigger pulse. This means that the signal at the output of the module will have the same pulsewidth or pulse length as the trigger pulse on the Clk input of the module, although the output will always be a logic level on the RndTrig module and a signal alternating between -64 and +64 units on the RndPattern module.

CHARACTER

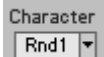
The random signal generators appear random to our ears, but in the very long run the sequence of values produced by the generators will actually repeat itself. Still, this type of digital random 

number generators is commonly used in synthesizers, in fact many analog synthesizers from the past used digital random number generators to produce audio noise. This type of generators is sometimes named pseudorandom, as the sequence will eventually repeat itself. In practice, if the rate of a random signal generator is set to 1000 Hz a sequence on the G2 will last over four and a half hours. In this case a thousand random values a second would be produced, making the amount of data simply too much for the human brain to ever notice any repetition, meaning that for musical purposes the signal is random enough. Still, within such a sequence there might be tendencies to cluster short and almost similar patterns or motifs. This is caused by how a number of consecutive values appear as a group. The Rnd 1 setting is virtually free of such motifs, but the Rnd 2 setting does exhibit clusters of values that show some similarities. When in Rnd 2 it might appear that there are little upwards arpeggios now and then, all of slightly different lengths and different shapes and at irregular intervals, but still appearing as the sort of motifs a musician would name arpeggios.

The Rnd 1 and Rnd 2 settings use different methods to generate the values. The Rnd 1 setting uses what is named a linear congruential method, while the Rnd 2 setting uses a shift register method.

RST INPUT AND SEED INPUT

At the explanation of the Character parameter it was said that the string of random numbers forms a very long sequence. When a trigger signal is applied to the Rst input the sequence will restart at the point where it starts on patch load or after a recalculation of the patch. When a control signal is connected to the Seed input, the trigger on the Rst input would cause the module to start at a different position in the sequence. This start position is defined by the momentary value on the Seed input. The value at the Seed input is commonly named the seed. Note that the Seed input must be used together with the Rst input to do the job. The actual seed can be any possible fractional value between the positive and the negative clipping level of the G2 system, meaning that there are many million start positions possible, depending on the value on the Seed input. The sequence will always develop in the same way from the start position defined by the seed.



DICE

The RndClkA module is fitted with a Dice button. The Dice button can be used to manually advance the pattern by one extra step in between the steps generated by the module itself. When this button is assigned to a button on the G2 panel and pressed, mouse-clicked in the editor program, or assigned to a MIDI CC# that is activated from the outside or from the patch itself through a MIDI CC# Out module, the module will step to the next position in the sequence.



RANDOMA

This random wave shape module produces a random waveform that is stepped when Edge is at 100%, slewed between steps for the settings 25%, 50%, and 75%, and a smoothly gliding random wave when Edge is at 0%. When Step is at 100% the difference between the current and the next random values can be quite big, while a Step setting of 25% generates much smaller steps. The rate of the module can be patched to track the keyboard by connecting the Pitch output on a Keyboard module to the Pitch input on this module.

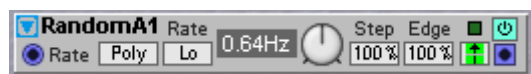

RANDOMB

The modulatable random wave shape module is quite similar to the LfoA module in Random Steps or Random waveform mode, but with the added Step and Edge

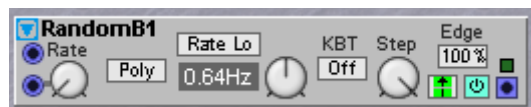

controls to fine-tune the random wave shapes or sequence of random values. The rate can be easily modulated by applying a varying control signal to the Pitch input that has the modulation depth knob.

RNDCLKA

The clocked random step module produces a new random value each time it receives a trigger pulse on its Clk input. Use the Dice button to 'randomize' the module manually, instead of using the Clk input.



RNDCLKB

The modulatable clocked random signal module produces a new random value each time it receives a trigger pulse on its Clk input. Using the Rst input and the Seed input will 'randomize' the module to a position in the pseudorandom sequence that is set with the value on the Seed input. Step settings can be modulated by a control signal on its input, setting the amount of modulation is done with the modulation depth knob.

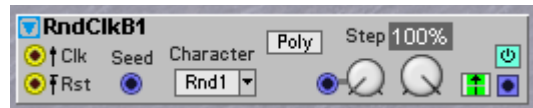

RNDTRIG

The random state or random pulse module produces a yellow pulse or gate output signal at a state that is either a logic HIGH or logic LOW. The output signal can be used directly to trigger yellow Trigger or Gate inputs. Note that when using the output signal as an analog (to a blue or red input) control signal, the output alternates between a logic LOW or 0 units for the OFF state and a logic HIGH or +64 units for the ON state.



For every new pulse it is decided if it is passed to the output or not, making the output signal equal in ON duration to the ON duration of the input pulse signal. This means that if gate signals of different lengths are used to clock this module, the length of the current gate signal is left unaltered if the module decides to 'pass' this current clocking gate signal to the output of the module.

RNDPATTERN

The RndPattern generator produces short repeating sequences of either random values or random state signals. Length of the sequences can be set by the Length control. This module is similar in its core to the modulatable clocked random signal module. The difference is that this module has an internal clock rate divider prepatched internally to the Rst input. There are over 32000 different patterns with a maximum length of 128 steps, presettable by the A and B pattern and the Length controls.



By connecting control signals to the A and B inputs the control signal values will set the pattern to be played. These control values are added to the values set by the A and B controls, expanding the pattern range to many millions of possible patterns.

Two different types of pattern are available, one based on the Character Type 1 random sequence and one based on the RndTrig random sequence. If the output wave shape is set to random trigger mode, the clocking gate signal will pass through to the output in the same way as described by the RndTrig module, though with a signal alternating between -64 and +64 units.

ENVELOPE GROUP

An envelope generator produces a control signal which resembles the volume envelope of a single note played on an acoustic instrument. This control signal can be used to control a filter or an amplifier, for example. The envelope starts when it receives a logic HIGH trig or gate signal and it decays after the trig/gate signal switches back to a logic LOW signal. Envelopes go through some specific stages, each denoted by an abbreviation character. During these stages, some envelopes can be retriggered. The output control signal from an envelope is usually unipolar, with a range of 64 units (+ or -), but can also be bipolar. All Nord Modular G2 envelope generators feature a built-in envelope controlled amplifier (known as VCA's on analog synths). This makes it possible to patch an oscillator output signal directly into the VCA section of an envelope generator and take out an enveloped signal with the desired "envelope contour".

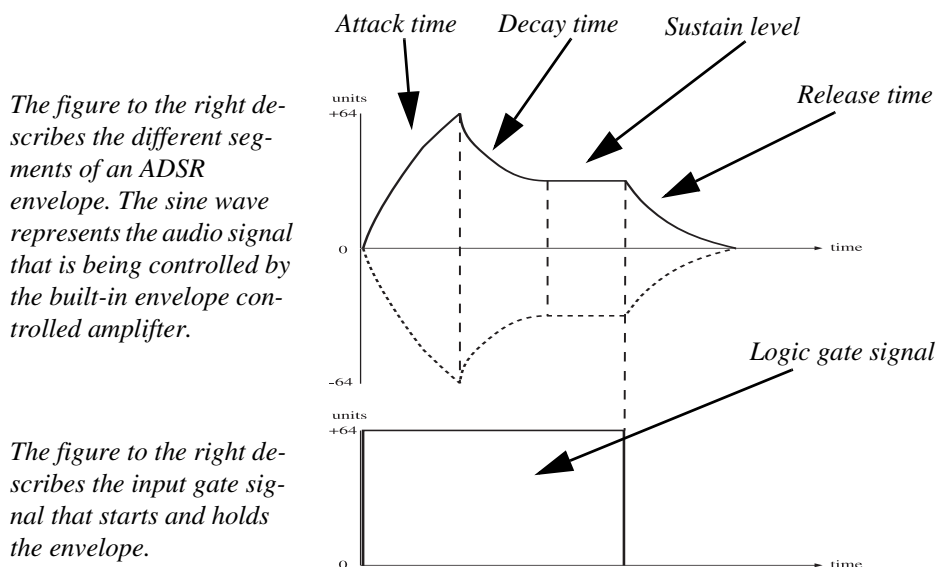

The figure to the right describes the different segments of an ADSR envelope. The sine wave represents the audio signal that is being controlled by the built-in envelope controlled amplifier.

The figure to the right describes the input gate signal that starts and holds the envelope.

- If the logic gate signal at the Gate input on an ADSR envelope generator switches to a logic LOW before the envelope has completed one or more of the stages, the envelope will jump directly to the release stage.
- If an envelope is restarted before all the stages were completed, it will (by default) restart the attack from the current envelope level of the release stage.

COMMON ENVELOPE GENERATOR PARAMETERS

KB BUTTON

This is the hard-wired gate signal "connection" with the keyboard. By activating the **KeyBoard Gate** function, there is no need to patch a logic gate signal cable to the Gate input from the Gate output of the Keyboard module. The LED lights up while the envelope is receiving a gate signal from the keyboard or via **MIDI IN**. 

GATE INPUT

A high logic signal appearing at this yellow input will start and can keep the envelope in an open-gate state for as long as the Gate signal is high. The LED lights up while the envelope is receiving a signal with a value greater than 0 units. If the Gate signal switches to 0 before the envelope has 

completed one or more of the stages, the envelope will jump directly to the corresponding level in the release stage.

TRIG INPUT

A high logic signal appearing at this yellow input will trig the envelope. The LED lights up while the envelope is receiving a signal with a value greater than 0 units. A triggered envelope only needs a short high logic signal to start. When the envelope has started after a Trig signal, it will proceed to the very end of the cycle even if the Trig signal drops to zero

N/R BUTTON

By default, when you release a key and then press is again, the envelope will restart the attack stage at the current release level and not from zero. This is normally the behavior you would want in an amplitude envelope. However, for pitch and filter envelopes it's often more desirable if the envelope always restarts at zero level. Click the N/R button to force the envelope to always restart the attack stage at zero level.

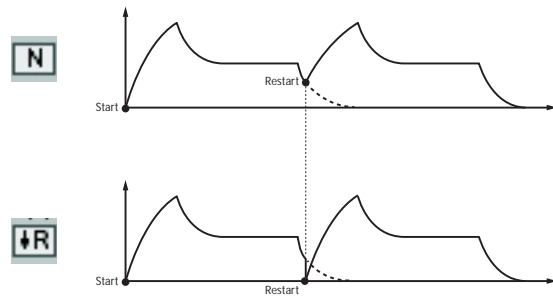

AM INPUT

A control signal input used for controlling the overall amplitude of the envelope. If you want a velocity sensitive envelope, patch any of the Velocity output of the Keyboard module to the AM input of the Envelope module.

SHAPE SCROLL BUTTON

Set the characteristics of the attack and decay/release stage(s) of the envelope by clicking this scroll button. There are four alternatives:

Logarithmic Attack & Exponential Decay/Release, Linear Attack & Exponential Decay/Release, Exponential Attack & Decay/Release and Linear Attack & Decay/Release.



A(TTACK)

Sets the attack time. When the envelope receives a high logic signal at the Gate input, the output control signal from the envelope rises up to the maximum value, 64 units. The time to get from 0 to 64 units is the attack time. If the logic Gate signal drops to zero before the envelope has completed the attack stage, it will skip the decay and sustain stages and immediately proceed with the release stage. The attack time is displayed in milliseconds or seconds in the corresponding display box. Range: 0.5 ms to 45 s.



D(ECAY)

Sets the decay time. After the envelope has completed the attack part, it will drop down to the sustain level with the decay time. The decay is exponential. If the sustain level is 64, the decay stage will not be needed, there is simply nothing to decay down to. If the logic Gate signal drops to zero before the envelope has completed the decay stage, it will immediately proceed with the release stage. The decay time is displayed in milliseconds or seconds in the corresponding display box. Range: 0.5 ms to 45 s.



S(USTAIN)

Sets the sustain level. This level will be held (sustained) for as long as the logic Gate signal is high. When the logic Gate signal drops to zero, the envelope will proceed with the release stage. The sustain level is displayed in 'units' in the corresponding display box. Range: 0 to 64 units



H(OLD)

Sets the time the envelope should remain at maximum level. The hold time is displayed in milliseconds or seconds in the corresponding display box. Range: 0.5 ms to 45 s.



R(ELEASE)

Sets the release time. When the logic Gate signal drops to zero, the envelope will decrease from the sustain level to zero with the release time. The release is exponential (or selectable between exponential and linear in some modules). The release time is displayed in milliseconds or seconds in the corresponding display box. Range: 0.5 ms to 45 s.



ATTACK/DECAY/SUSTAIN/HOLD/RELEASE MODULATION

Some Envelope Generators feature control signal inputs for modulating the envelope segments. You can adjust the level of each control signal by turning the corresponding rotary knob of [ATTENUATOR TYPE I]. Note that the A, D, H and R control inputs handles bipolar control signals. Positive control signals shortens the times and negative control signals increase the times. With the H parameter it is the other way around.



GRAPHS

All Envelope Generator modules features a graph which displays the envelope shape. Any sustain level is indicated with an orange line; the rest of the envelope segments are green. There is also a yellow horizontal line which indicates the zero level of the envelope.



OUTPUT TYPE SCROLL BUTTON

With the Output Type scroll button you determine how the envelope control signal should be output and affect the envelope controlled amplifier. There are six different alternatives:



- **POS:** Positive Unipolar signal starting from 0 units, going up to +64 units and then down to 0 units again.
- **POSINV:** Positive Unipolar signal starting from +64 units, going down to 0 units and then up to +64 units again, i.e. an inverted signal.
- **NEG:** Negative Unipolar signal starting from -64 units, going up to 0 units and then down to -64 units again.
- **NEGINV:** Negative Unipolar signal starting from 0 units, going down to -64 units and then up to 0 units again.
- **BIP:** Bipolar signal with a range of 64 units and its sustain level at 0 (the MultiEnv can have user definable sustain level in this mode).
- **BIPINV:** Bipolar inverted signal with a range of 64 units and its sustain level at 0 (the MultiEnv can have user definable sustain level in this mode).

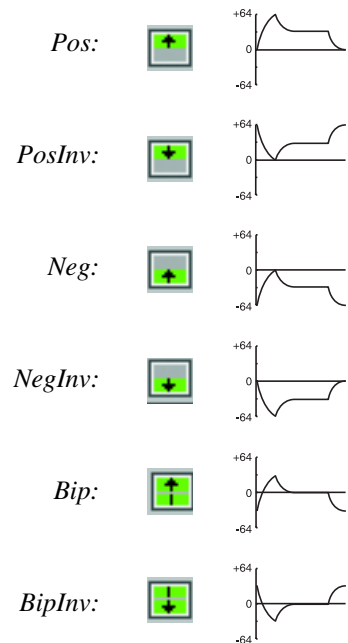

Note! The Multi-Envelope module has full range (-64 to 64 units) in Bipolar and Inverted Bipolar mode.

INPUT

The **DYNAMIC CONTROL/AUDIO** signal input. Here you can patch a bipolar signal to the envelope controlled amplifier.



OUTPUT

The **DYNAMIC CONTROL/AUDIO** signal output from the envelope controlled amplifier. Signal: **Bipolar**.



ENV OUTPUT

The blue control signal output from the envelope generator. Signal: **UNIPOLAR OR BIPOLAR**.



ENVADSR

This is a regular four-stage ADSR (Attack, Decay, Sustain and Release) envelope. The ADSR Envelope is well suited for controlling audio signal amplitude, pitch and filter cut-off frequency, for example. See also "[Common Envelope Generator parameters](#)".



ENVH

This is a Hold Envelope that can be used to gate an audio signal for a specified duration. It has a Hold time control and an AM input. The Hold Envelope has an immediate attack and decay times. This means that when the Hold Envelope is used for controlling the amplitude of an audio signal, there may be a clicking sound at the beginning and end, due to the immediate attack and decay times. If you want to be able to control Attack and Release times, check out



the “EnvADR” on page 201 or “EnvAHD” on page 201. See also “Common Envelope Generator parameters”.

ENV D

This is a Decay Envelope. It has a Decay time control and an AM modulation input. The attack time of the Decay Envelope is immediate, which makes it suitable for controlling the amplitude of percussive and click sounds where a click at the start of the sound is desirable. The Env output signal can be used as audio e.g. to generate rhythmic audio clicks. Other applications could be to control Pitch, Filter and FM modulation. If you want to be able to control Attack time, check out the “EnvADR”. See also “Common Envelope Generator parameters”.

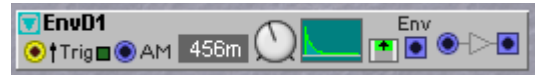

ENVADR

This is an envelope with two or three stages, Attack and Decay or Attack, Sustain and Release. In [Rel] mode, the Sustain level is fixed at maximum level for the duration of the Keyboard Gate pulse or pulse on the Gate input, turning the module into an ASR-type envelope generator. When in [Rel] mode the Gate/Trig button must be set to Gate, else the module will still work as when in [Dcy] mode.



GATE/TRIG SCROLL BUTTON

Select whether the envelope should be gated or triggered.

DCY/REL

Click to change from Attack and Decay stages to Attack, Sustain and Release stages. The Sustain level is fixed at maximum level.

END OUTPUT

This yellow logic output sends out a logic HIGH signal as soon as the envelope has completed its stages and the envelope signal is back to zero units. This signal can be useful for gating or triggering other modules. Another interesting application is that you can connect this output directly to the Gate/Trig input and thus create a repeating envelope signal - like a sort of shapeable “LFO” (see figure). You will have to set the Gate/Trig button to Trig for this to work. In this case the Envelope will restart itself after it has finished its envelope shape. See also “Common Envelope Generator parameters”.

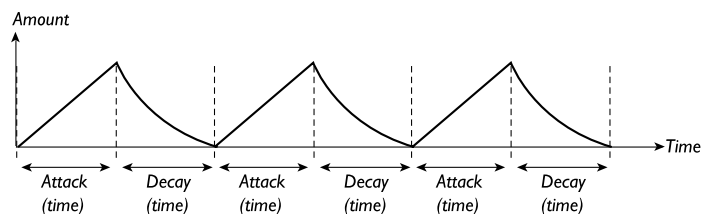

ENVAHD

The Attack-Hold-Decay envelope is an envelope with three stages: Attack, Hold and Release. The AHD Envelope is well suited for audio gating applications, for example. See also “Common Envelope Generator parameters”.



ENVADDSR

This is what you could call an enhanced ADSR-envelope. It features Attack, Decay, Break, Decay, Break and Release controls. The sustain segment is selectable between the first and second Brake stage.



SUSTAIN SCROLL BUTTON

Click to select stage L1 or L2 as sustain segment.

L1 & L2

These are level parameters. The L1 or L2 segment can be selected to act as sustain stage and will then represent the level at which the envelope will be held (sustain) when the Gate signal is high. See also "[Common Envelope Generator parameters](#)".

ENVMULTI

The Multi stage envelope is a 5-segment time and level envelope with selectable sustain segment.



L1-L4

By turning the rotary knobs L1 to L4 you can set the amplitude of each of the four level segments in the envelope. The envelope always ends at the L4 level, which can indeed be different from the initial start level. When you then restart the envelope at the L4 stage, the start level will be the same as L4. If the R button is depressed, the envelope will always restart at zero level. The levels can be either unipolar or bipolar as described above. The levels are displayed in units in the corresponding display box. Ranges: 0 to 64 units (unipolar) or -64 to +64 units (bipolar).

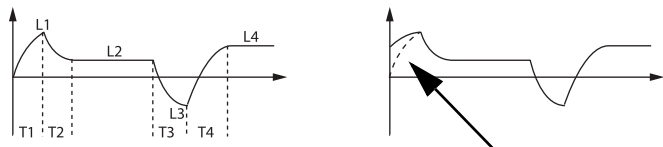

The straight line at the T1 segment indicates the restarted (bipolar) envelope without the R button depressed and the dotted line with the R button depressed.

T1-T4

Here you set the times between the four level stages.

SUSTAIN SCROLL BUTTON

By clicking the Sustain scroll button you define the sustain segment. This segment can be any of the four level segments, or, if you wish, none at all. The sustain segment works like in an ordinary ADSR envelope, i.e this is the level that sustains as you hold down the key(s). After releasing the key(s) the envelope will continue till the end of T4 and stop at the L4 level. Range: None and L1 to L4. See also "[Common Envelope Generator parameters](#)".

MODAHD

The AHDMOD envelope is an Attack-Hold-Decay envelope with control signal inputs for modulating



Attack, Hold and Release times. The Shape characteristics of this envelope is fixed to Linear Attack & Exponential Decay/Release.

Tip! This module can be used to create pulses with a modulatable length when the A and D times are set to very short and the Hold is modulated by a varying control signal. See also "[Common Envelope Generator parameters](#)".

ModADSR

The Mod Envelope is an ADSR envelope with control signal inputs for modulating Attack, Decay, Sustain and Release from external sources. The Shape characteristics of this envelope is fixed to Linear Attack & Exponential Decay/Release. See also "[Common Envelope Generator parameters](#)".



SHAPER GROUP

In the Shaper module group you will find modules that changes the shape of an input audio signal in different ways. Distortion modules can be found here, for example.

Shaper modules will change the momentary amplitude of a signal according to what is named a transfer function. A transfer function is basically a graph with a X-axis and a Y-axis. The momentary value of the input signal is set out on the X-axis and then a straight vertical line is drawn towards the graph. When the corresponding point on the graph is found, a straight horizontal line is drawn to the Y-axis and the value that is found on the Y-axis is output by the module. If the graph is a straight diagonal line there will be no distortion, as the transfer function is said to be linear (=a straight line). But when the graph is a curve, there will be distortion applied to the signal. This distortion can be controlled by changing the shape of the curve. As the curve is not a straight line the distortion is said to be non-linear.

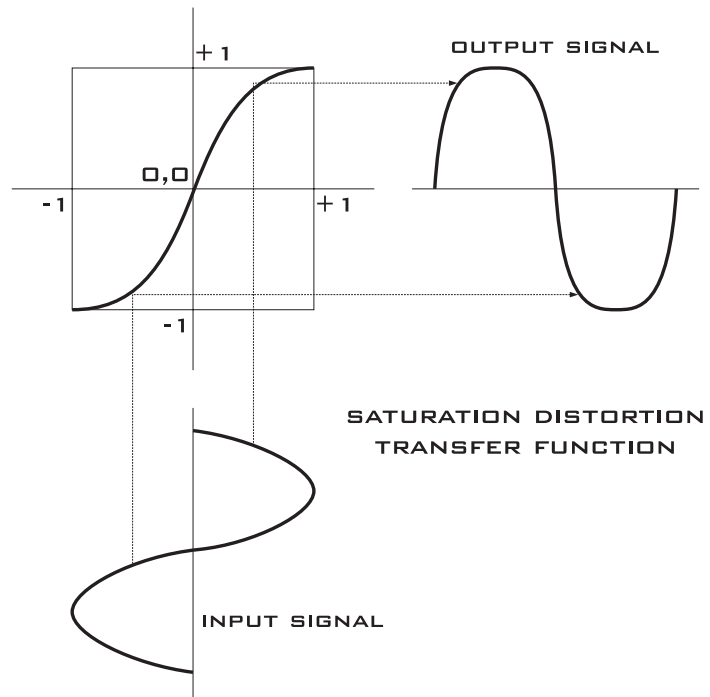

COMMON SHAPER PARAMETERS

INPUT

The **DYNAMIC CONTROL/AUDIO** signal input on the Shaper modules.



OUTPUT

Signal: **BIPOLAR OR UNIPOLAR CONTROL/AUDIO**.



ON/BYPASS

Click the On/Bypass button to bypass the input signal from the effect. Blue button color indicates 'On' and gray 'Bypass'.



MODULATION INPUT

The **DYNAMIC CONTROL/AUDIO** signal modulation input on the Shaper modules. The modulation amount can be attenuated with the knob of **[ATTENUATOR TYPE I]**.



GRAPH

Displays the shape function graphically. The Y-axis represents the output signal values, and the X-axis the input signal values.



CLIP

This module can produce digital distortion by decreasing the clip level limit(s) below the normal headroom.



SHAPE

Toggle switch for the Symmetric and Asymmetric mode. If this is set to 'Asym', only the positive peaks of a signal will be clipped. If this is set to 'Sym', both the positive and the negative peaks of a signal will be clipped.

CLIP LEV

Sets the initial clip level limit(s). See also "[Common Shaper parameters](#)".

EXAMPLE OF THE CLIP MODULE

When the clipper module is in symmetrical Shape mode the signal level drops significantly when the Clip Lev knob is opened. A good solution is to use the module in a feedback loop with a mixer module. The output of a mixer is fed into the input of the Clip module and the output of the Clip module is fed back into an input of the Mixer. This will allow for deep clipping while the clipped signal level will stay fixed between -64 and +64 units. This works well when e.g. a sawtooth waveform is filtered with a high resonance bandpass filter and then clipped, like in the example. Be sure to set the Shape button of the Clip module to [Sym].

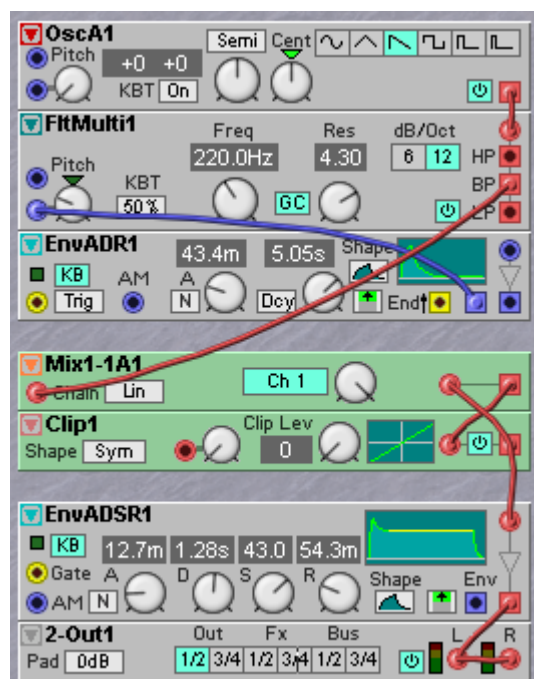

OVERDRIVE

This module distorts an audio signal by amplifying the input signal and force it to 'hit the headroom'. The special amplification characteristics makes this module produce a warm, tube like distortion. There are four different distortion types available, each with modulatable distortion depth control.



SHAPE

Toggle switch for the Symmetric and Asymmetric mode. If this is set to 'Asym', only the positive peaks of a signal will be clipped. If this is set to 'Sym', both the positive and the negative peaks of a signal will be clipped.

TYPE

Select type of overdrive distortion by clicking this scroll button. The alternatives are: Soft, Hard, Heavy and Fat.

OVERDRIVE

Sets the initial overdrive amount. See also ["Common Shaper parameters"](#).

SATURATE

This module shapes an input signal in a logarithmic fashion. There is a choice of four different distortion curve characteristics, each with modulatable distortion depth control.

**CURVE**

Choose between four different transformation curve characteristics. Curve 1 is a smooth logarithmic transformation and Curve 4 is a hard transformation.

AMOUNT

Sets the initial shape amount. See also ["Common Shaper parameters"](#).

SHPEXP

This module shapes an input signal in an exponential fashion. You can choose between four different transformation curve characteristics. Note that the output amplitude decreases exponentially when the input amplitude is lowered, which means that this module can best be used with fixed amplitude input signals, e.g. equal to the amplitude on the output of an oscillator module.

**CURVE**

Choose between four different transformation curve characteristics. Curve x2 is a smooth exponential transformation and Curve x5 is a hard transformation.

AMOUNT

Sets the initial shape amount. See also ["Common Shaper parameters"](#).

WAVEWRAP

This module amplifies a signal until it hits the headroom. Instead of clipping the signal, it folds down, "wraps around". The waveform of the signal will be heavily transformed, with a lot of new overtones, which gives it deep distortion- and/or FM-like characteristics.

**WRAP**

Sets the initial wrap amount. See also ["Common Shaper parameters"](#).

SHPSTATIC

This module distorts a signal using one of four different amplification/attenuation characteristics. The curves on the buttons describes the transformation functions, i.e. the amplification/attenuation curve of each value of the input signal.

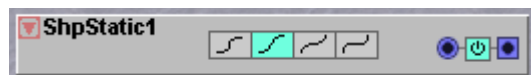

SHAPE BUTTONS

Set the desired transfer curves with the selectors, Inv x3, Inv x2, x2 or x3.

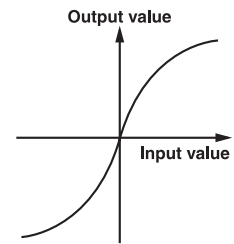
**RECT**

The Rectifier (diode processing) module can be set to discard of any positive or negative input levels (half wave rectification), or to convert the input signal to only positive or only negative levels (full wave rectification).

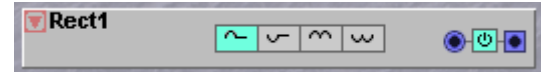
**SELECTOR**

Sets the operation of the module. The first position discards of any negative input signal levels, the second position discards of any positive input signal levels, the third position transforms (mirrors) any negative signal levels to positive levels and the fourth position transforms (mirrors) any positive signal levels to negative levels. See also "[Common Shaper parameters](#)".

FILTER GROUP

A filter is one of the primary tools for coloring the sound in a synthesizer. It can attenuate and amplify different frequencies in oscillator waveforms and other signals, and drastically change the timbre of the sound. Most of the Nord Modular G2 filters can be dynamically controlled from various modulation sources.

In the Nord Modular G2 you have several different filter modules to choose from, ranging from traditional LP/HP/BP filters to complex special filters such as the Vocoder and the Vocal filter. Filters can be combined with each other and with Shaper distortion modules to extend the G2 sonic range to a virtually unlimited amount of timbres.

COMMON FILTER PARAMETERS

INPUT

The Audio signal input of the filter module



ON/BYPASS

Click the On/Bypass button to bypass the input signal from the effect. Blue button color indicates 'On' and gray 'Bypass'.



OUTPUT

The output from the filter. Signal: **BIPOLAR**.



FREQ KNOB

With this you set the filter cutoff frequency (or center frequency for Bandpass and Bandreject filters). The frequency is shown in the corresponding Display Box. The range is 13.76 Hz to 21.1 kHz.



KBT SCROLL BUTTON

KBT, **KeyBoard Tracking**, is the hard-wired connection between the cutoff frequency and the keyboard (and the MIDI input). Click to select Off, 25%, 50%, 75% or 100% ratio. If KBT is set to 100%, the cutoff frequency will track the keyboard at the rate of one semitone for each key. If KBT is set to Off, the keyboard will not affect the cutoff frequency at all.

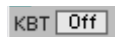

RESONANCE/RES KNOB

This is a function that emphasizes the frequencies that is at, or close to, the set cutoff frequency. If set to 127, the filter starts to self-oscillate and produces a sine wave. The Resonance is shown in the corresponding Display Box. Range: 0 to 127 units.



GC BUTTON

This is the Gain Compensation parameter. When activated, it will lower the gain of the signal inside the filter if the resonance is increased, something that otherwise will boost the level within the filter.



If several sound sources are processed in a filter and the resonance control is raised, clipping of the signal might occur inside the filter. Activating the GC parameter will reduce the levels, to reduce the risk of any unwanted clipping.

dB/OCT RADIO BUTTONS

Here you select the filter roll-off (slope). The roll-off for a 1-pole filter is 6 dB/octave, 12 dB/octave for a 2-pole filter, 18 dB/octave for a 3-pole filter and 24 dB/octave for a 4-pole filter. Generally, the filter roll-off increases by 6 dB/octave for every pole a filter has.

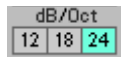

FILTER GRAPH

Some filter modules feature a graph to visually display the current filter characteristics. The X-axis represents the frequency and the Y-axis the level. The gray horizontal line represents the 0 dB level.



FILTER DROP-DOWN SELECTOR

Some filter modules have a drop-down roll-off selector. The different slopes of these modules are not instantly available as in the modules with dB/Oct radio buttons. The advantage of this is that these modules uses less Patch Load. However, changing roll-off in these modules will force the Sound engine to recalculate and thus cause a brief moment of silence. So if you're looking for lower Patch Load, use these filter modules instead of the "radio button" ones.

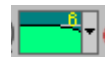

PITCH MODULATION INPUT

There are one or more **CONTROL** or **DYNAMIC CONTROL/AUDIO** signal inputs for a modulation source to control the cutoff frequency of the filter. There can also be a pitch modulation attenuator next to the input of **ATTENUATOR TYPE III**. If the attenuator knob has a triangle above it, click it to select 1:1 keyboard tracking of the cutoff frequency if the input is connected to the Note output of the Keyboard module (see page 158). See "Pitch modulation" on page 78 for more info.



FLTLP

This is a non-resonant lowpass filter with selectable slope (6/12/18/24/30/36 dB/Oct.) and a modulation input for cut-off frequency modulation. The passband is flat with a gain of exactly 1 (unity gain).

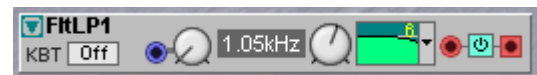

Note that changing slope will force the Sound Engine to recalculate and thus cause a brief moment of silence. See also "Common Filter parameters".

FLTHP

This is a non-resonant highpass filter with selectable slope (6/12/18/24/30/36 dB/Oct.) and a modulation input for cut-off frequency modulation. The passband is flat with a gain of exactly 1 (unity gain).

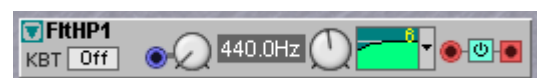

Note that changing slope will force the Sound Engine to recalculate and thus cause a brief moment of silence. See also "Common Filter parameters".

FLTNRD

This is a dynamic synthesizer filter with a slope of either 12 or 24 dB/octave. It is a multi-mode filter, providing a highpass, a lowpass, a bandpass or a bandreject filter. The cut-off frequency and the resonance can be modulated from external sources.



FM LIN

The blue **DYNAMIC CONTROL/AUDIO** signal input for modulating the filter cutoff frequency. Connecting a red signal to this input will change the connection into a red one and will allow for true linear frequency modulation in the audio range of the filter cutoff parameter. The modulation amount is determined by the rotary knob next to the input of **ATTENUATOR TYPE II**. See “[Frequency modulation \(FM\)](#)” on page 78 for more info about frequency modulation.

FILTER TYPE SELECTOR

Select the filter type with the buttons. (This selector cannot be assigned to a Morph group). HP is a Highpass filter, BP is a Bandpass filter and LP is a Lowpass filter. BR is a Band reject filter. When the BR filter is selected, the Resonance knob will control the width of the frequency band to be rejected.

RESONANCE MODULATION

The blue Control signal input for modulating the resonance from a control source. The modulation amount is determined by the rotary knob next to the input of **ATTENUATOR TYPE I**. See also “[Common Filter parameters](#)”.

EXAMPLE OF FM LIN ON THE NORD FILTER

The sensitivity of this FM Lin modulation input is extremely high and the input can best be combined with a LevScaler module from the Note group. This will increase the grip on the modulation depth over the keyboard range. See “[LevScaler](#)” on page 170. In general the L parameter of the LevScaler module is set between -6dB to -3dB and the R parameter between +3dB to +6dB and the BP is set to the highest note. These settings will scale the FM Lin input into its most useful range, where vowel-like effects can be created. See the patch example below. Note that too much FM Lin modulation on this module will simply destroy the filtering effect.

**FLTCLASSIC**

This is a lowpass filter which simulates the classic analog synthesizer filter. The main difference between this filter and other G2 lowpass filters is the more narrow resonance peak, quite similar to the peak found in analog ‘ladder’ filters. The slope is selectable between 12, 18 or 24 dB/octave. The cut-off frequency can be modulated from external sources. Just like on analog filters the amplitude of the passband will drop about 12 dB when the resonance is set to a high value. See also “[Common Filter parameters](#)”.



FLTMULTI

This is a multimode filter with a selectable slope of 6 or 12 dB/octave and resonance control. It is a multi-mode filter with three outputs: one highpass (HP), one lowpass (LP) and one bandpass (BP). All three outputs can be used simultaneously. The cut-off frequency and the resonance can be modulated from external sources. See also ["Common Filter parameters"](#).



FILTER MODES

The dB/Oct radio button can change the LP and HP outputs to 6dB slopes. The BP output however is changed into an allpass output when the filter is in 6dB mode. An allpass filter will pass all frequencies, but will have two effects on a sound. The first effect is that all partials are shifted in phase, higher partials are shifted more as lower partials. This phase shifting effect is not heard unless the output is mixed with other (allpass filtered) sounds of the same basic pitch. The second effect is that when the resonance is opened a strong resonant peak occurs at the cutoff frequency. And this effect can be put to very good use when e.g. filtering audio samples. The peak can significantly boost a small frequency band in the sample, without filtering away the high or the low. Interesting application is to e.g. sweep the peak with a triangle Lfo over a drumsample fed into a Line In input. Note that the allpass filter appears to be inverted in respect to the input signal.

FLTSTATIC

This is a static filter with selectable modes (LP/BP/HP), frequency and resonance controls. The slope is fixed at 12 dB/octave. See also ["Common Filter parameters"](#).



WAHWAH

Wah-Wah modulation is often used for electric guitars to get that funky "talking guitar" sound. Basically, the Wah-Wah modulation is a lowpass/bandpass type of filter that can be swept across the frequency range. During the sweep, the filter's characteristics change slightly. The Sweep range is preset to the ranges most often found on Wah-pedals and fits perfectly to the full range of the **MODWHEEL**. The Sweep can also be modulated from an external source on the Control signal input. The control signal can be attenuated with the knob **[ATTENUATOR TYPE I]**. The Wah-Wah sound is often enhanced by an additional Saturation or Overdrive module at the Wah-Wah output. See also ["Common Filter parameters"](#).

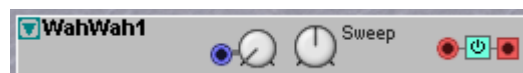

FLTVOICE

The Voice Filter module is designed to simulate the part of the vocal tract that produces the vowels. You can select between a number of preset vowels and change and modulate them to generate really amazing effects. Waveforms with a lot of overtones, such as sawtooth or pulse waves, are best suited to be used with the Voice Filter. This type of filtering is very suited to be enhanced by just a little touch of Saturation distortion on the filter output.

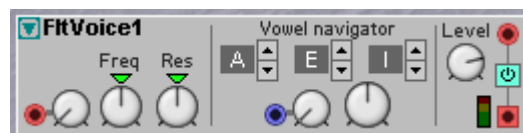

RES

This function emphasizes the frequency peaks of the vowels. The more resonance, the more clearly the vowels appear. Click on the green triangle above the rotary knob to reset to a medium value.

FREQ

Sets the initial center frequency offsets of the vowels. The practical result of turning this knob would be like pitch-shifting a sampled voice. Click on the green triangle above the rotary knob to reset to a medium value.

FREQUENCY MODULATION INPUT [ATTENUATOR TYPE II]

The input for modulating the center frequency offset from a control source. The modulation amount is determined by the rotary knob next to the inputs.

VOWEL DISPLAY BOXES

Displays the three different selected vowels. Presets: A, E, I, O, U, Y, AA, AE, OE.

VOWEL NAVIGATOR BUTTONS

Selects the vowels to be used. You can select up to three vowels and navigate between these with the navigator knob (see below). Presets: A, E, I, O, U, Y, AA, AE, OE.

VOWEL MODULATION INPUT [ATTENUATOR TYPE I]

The input for modulating the navigation between the selected vowels. The knob next to the input is used for attenuating the input level.

VOWEL NAVIGATOR KNOB

Navigates between the vowels you selected with the vowel selectors. Note that this is a transformation function - not a mix function.

LEVEL

The Level knob is used for attenuating the input level [ATTENUATOR TYPE I]. See also "[Common Filter parameters](#)".

VOCODER

The Vocoder module is a classic 16 band vocoder with the ability to reroute the analysis bands. The basic principle of a vocoder is to filter a synthesizer sound with the help of another sound - a human voice for example. The result when filtering a synth sound with a voice would be a "singing" synthesizer. The actual notes that come out of the vocoder are the notes played on the synthesizer. To reach this effect the analysis frequency spectrum is divided into separate frequency bands, in this case 16. These 16 frequency bands work like 16 bandpass filters, each controlling a defined frequency band of the synthesizer bank. An envelope follower for each band determines the amplitude changes of the modulated sound.

With this vocoder module it is possible to reroute the analysis bands to any of the frequency bands of the synthesizer bank, creating really interesting frequency combinations.

Of course you can use any kind of sound in the analysis bank to shape the synthesizer sound. E.g. when using a sampled drumloop instead of a microphone you can get funky percussive synth sounds. Feel free to experiment.

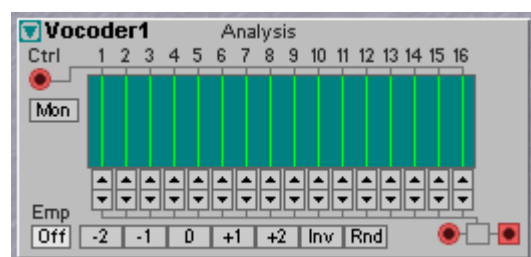

ANALYSIS BANK CTRL INPUT

Patch the signal you want to use as “modulator” to the red audio signal input on the upper left of the module. This is the input in the “standard vocoder application” where you patch the vocal signal.

MON

Click on this button to bypass the modulator (Ctrl) signal to the output so you can easily monitor the original ‘vocal’ signal. Or use this button to switch between your vocals and the vocoded sound.

EMP ON/OFF

Click on the Emp On/Off button to emphasize the high frequencies of the analysis signal. This is a very useful function to get a more evenly frequency response in the modulated sound.

GRAPH

This graph shows the routing between the Analysis and Synthesis bands.

REROUTE BUTTONS

Click on the up and down buttons to reroute each of the synthesizer signal’s frequency bands to any of the frequency bands of the Analysis bank.

PRESETS

Click on the Preset buttons to reroute all Synthesis bands the number of steps indicated on the buttons. The Inv button inverts the band routing, i.e routes the Analysis band 1 to Synthesis band 16 and so on. The Rnd button reroutes all bands completely randomly - great for experiments!

SYNTHESIZER INPUT

The red audio signal input to the lower right is where you patch the synthesizer audio signal.

EQPEAK

The Eq1 module offers parametric equalization with controls for center frequency, gain and bandwidth.

**FREQ**

With the Freq knob you change the center frequency. Range: 20 Hz to 16.1 kHz.

GAIN

With the Gain knob you change the gain at the center frequency. Range -18 to +18 dB.

BW

Use the BW knob to set the bandwidth around the center frequency. Range 2 to 0.02 octaves.

LEVEL

With the Level knob you attenuate the input signal [ATTENUATOR TYPE I]. See also "[Common Filter parameters](#)".

EQ2BAND

The 2 band EQ is a treble and bass equalizer with gain controls for 80Hz and 12kHz plus a master level control.



LVL

With the Lvl knob you attenuate the input signal [**ATTENUATOR TYPE I**].

LO GAIN

With the Lo gain knob you change the gain at 80Hz. Range -18 to +18 dB.

HI GAIN

With the Hi gain knob you change the gain at 12kHz. Range -18 to +18 dB. See also "[Common Filter parameters](#)".

EQ3BAND

The 3 band EQ is a treble and bass equalizer with sweepable Mid frequency plus gain controls for the Mid band and for the fixed 80Hz and 12kHz frequency bands. It has also a master level control.

**LO GAIN**

With the Lo gain knob you change the gain at 80Hz. Range -18 to +18 dB.

MID GAIN

With the Mid Gain knob you change the gain at the Mid frequency (see below). Range -18 to +18 dB.

MID FREQ

With the Mid Freq control you change the center frequency of the Mid band. Range: 100Hz to 8.00 kHz.

HI GAIN

With the Hi gain knob you change the gain at 12kHz. Range -18 to +18 dB.

LVL

With the Lvl knob you attenuate the input signal [**ATTENUATOR TYPE I**].

See also "[Common Filter parameters](#)".

FLTPHASE

This is a 14-pole phase filter with peak spread control and adjustable feedback. It features six allpass filters which displace the phase 180 degrees each. It is possible to select the number of allpass filters (1-6) to be used, giving from one to six notches/peaks.

**SPREAD**

With the Spread rotary knob you set the distance between the peaks. The peak distance can be modulated from an external source using the blue control signal input and the level attenuator [**ATTENUATOR TYPE I**].

FB

With the Feedback knob you set the phaser feedback, i.e the signal feedback to the allpass filters. You can have a negative or positive feedback. At the 12 o'clock position feedback is zero. Click on the green triangle above the knob to set the feedback to 0. The feedback can be modulated from an external source using the blue control signal input and the level attenuator [**ATTENUATOR TYPE I**].

NOTCH

By clicking on the up and down arrow buttons you select the number of notches (allpass filters). 1 to 6 notches can be selected.

TYPE

Click to select Notch, Peak or Deep. In Notch mode, the signal notches are attenuated. In Peak mode, the signal peaks are amplified and in Deep mode, the signal notches and peaks are attenuated and amplified. The different frequency characteristics are displayed in the graph (see below).

LEVEL KNOB

To the right of the module is the input level attenuator [ATTENUATOR TYPE I].

FLTCOMB

This is a Comb filter with adjustable feedback.

Note that the Comb filter uses DSP audio delayline memory.

**FREQ**

With the Freq knob you set the distance, in Hz, between the peaks/notches.

FB

With the Feedback knob you set the signal feedback to the comb filter. You can have a negative or positive feedback. At the 12 o'clock position feedback is zero. Click on the green triangle above the knob to set the feedback to 0. The feedback can be modulated from an external source using the blue control signal input and the level attenuator [ATTENUATOR TYPE I].

TYPE

Click to select Notch, Peak or Deep. In Notch mode, the signal notches are attenuated. In Peak mode, the signal peaks are amplified and in Deep mode, the signal notches and peaks are attenuated and amplified. The different frequency characteristics are displayed in the graph (see below).

LEVEL KNOB

To the right of the module is the input level attenuator [ATTENUATOR TYPE I].

MIXER GROUP

The mixer modules in Nord Modular G2 can mix audio signals as well as control signals. If you connect several sound sources to a mixer with high or amplified levels, the signal may distort. If this happens, attenuate the input signals.

COMMON MIXER PARAMETERS

INPUTS

All Mixer module inputs are **DYNAMIC CONTROL/AUDIO** signal inputs. This means they adapt the module bandwidth to the bandwidth of the incoming signal(s). As soon as you patch an audio signal to one input, the entire Mixer module will automatically “update” to Audio bandwidth for highest possible quality. This also results in the module using more Patch Load.



OUTPUT(S)

DYNAMIC CONTROL/AUDIO depending on the input signals. Signal: **BIPOLAR**.



OUTPUT LEVEL METER(S)

The level meter(s) on some modules displays the following signal levels: green LEDs between -40dB and 0dB, yellow LEDs between >0dB and +11dB and red LED at >11dB.



CHAIN INPUT(S)

DYNAMIC CONTROL/AUDIO signal inputs that will pass signals on to the output unaltered (unity gain). The signals on these input can be used as reference signals, the signals on the other inputs are added along to these signals. Imagine that you have a modulation control signal and you want a controllable amount of another modulation signal added to along to this signal. In this case the main modulation signal is connected to a Chain input and the other signal to a regular mixer input with a mixer knob. Signals on the Chain inputs cannot be attenuated or muted in the Mixer module. Pad button settings do not have any effect on the signals on Chain inputs. The Chain inputs are also used to combine two mixer modules into a bigger mixer.



EXP/LIN/DB

Click this scroll button to switch between Exponential, Linear and dB characteristics. Lin means the mixer knobs will be of the Linear [**ATTENUATOR TYPE I**] and Exp or dB will turn the mixer knobs into Exponential/dB [**ATTENUATOR TYPE II**]. When the module is in Linear mode the mixer knob display values can be interpreted as percentages. Note that there is no functional difference between the Exp and the dB curves, it is just a matter of whether you want the knobs to display an exact dB value or the basically meaningless Exp value.



PAD

Click the Pad scroll button to attenuate the levels on all mixer inputs by -6 dB (or -12dB). This is useful to prevent clipping when you use a lot of the mixer inputs. Note that Chain inputs are *not* affected by the setting of the Pad button.



ATTENUATOR OR MIXER KNOBS

By default, all Attenuator knobs have logarithmic characteristics [**ATTENUATOR TYPE II**] with the range -infinity to 0 dB. In some mixer modules you can change the characteristics to linear [**ATTENUATOR TYPE I**] by clicking the Lin button described above.



CHANNEL MUTE BUTTONS

Some mixers feature Channel Mute buttons to mute the inputs. A blue Channel Mute button means that the channel is enabled. These Channel Mute buttons are basically Name buttons, meaning that they can be labelled with your own text for better overview, these names will show up in the G2 frontpanel displays when the associated mixerknob is assigned to a panel knob. Right-click on a Channel Mute button and select 'Edit name'. Type in the new name and press Enter. Note that the name cannot be longer than 7 characters because of the size of the **ASSIGNABLE DISPLAYS** on the synth. The Channel Mute buttons cannot be assigned to a Morph Group.



Mix1-1A

This mixer has one **DYNAMIC CONTROL/AUDIO** signal input, a chain input and one output. The mixer has a Channel Mute button for enabling/disabling the input. The Channel Mute button can be labelled. See also "Common Mixer parameters".

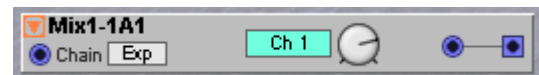

Mix1-1S

This mixer has stereo **DYNAMIC CONTROL/AUDIO** signal inputs, stereo chain inputs and stereo outputs. The mixer has a Channel Mute button for enabling/disabling the inputs. The Channel Mute button can be labelled. See also "Common Mixer parameters".

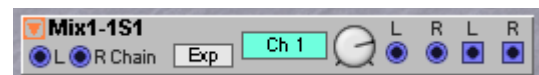

Mix2-1A

This mixer has two **DYNAMIC CONTROL/AUDIO** signal inputs and one output. Each input is equipped with a separate attenuation control. The mixer has a Channel Mute button per channel for enabling/disabling the inputs. The Channel Mute buttons can be labelled. See also "Common Mixer parameters".



Mix2-1B

This mixer has two **DYNAMIC CONTROL/AUDIO** signal inputs and one output. Each input is equipped with a separate attenuation control. Each channel also has a separate control for inverting the input signal.

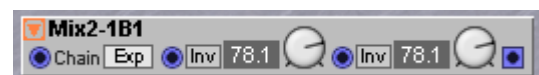

INV

Click the Inv button(s) to invert the input signal(s) polarity, i.e. phase shift them 180 degrees. See also "Common Mixer parameters".

Tip! The Inv button can be conveniently used if a control signal must be subtracted from another signal instead of added, or if an audio signal must be mixed in 'anti-phase' with another audio signal.

Mix4-1A

This mixer has four **DYNAMIC CONTROL/AUDIO** signal inputs and one output. See also "Common Mixer parameters".



Mix4-1 B

This mixer has four **DYNAMIC CONTROL/AUDIO** signal inputs, one Chain input and one output. Each input is equipped with a separate attenuation control. See also ["Common Mixer parameters"](#).



Mix4-1 C

This mixer has four **DYNAMIC CONTROL/AUDIO** signal inputs, one Chain input and one output. Each input is equipped with a separate attenuation control. The mixer has a Channel Mute button for each channel for enabling/disabling the input. Each Channel Mute button can be labelled. The mixer also has a -6 dB button for attenuating all inputs by another -6 dB. See also ["Common Mixer parameters"](#).



Mix4-1 S

This stereo mixer has four **DYNAMIC CONTROL/AUDIO** signal input pairs, two Chain inputs and a stereo output. Each input pair is equipped with a separate attenuation control. The mixer has a Channel Mute button for each channel for enabling/disabling the input pair. Each Channel Mute button can be labelled. See also ["Common Mixer parameters"](#).



Mix8-1 A

This mixer has eight **DYNAMIC CONTROL/AUDIO** signal inputs and one output.



PAD SCROLL BUTTON

Click to select 0, -6 or -12 dB attenuation on all input channels. See also ["Common Mixer parameters"](#).

Mix8-1 B

This mixer has eight **DYNAMIC CONTROL/AUDIO** signal inputs, one Chain input and one output. Each input is equipped with a separate attenuation control. The mixer also has a -6 dB button for attenuating all inputs by another -6 dB. See also ["Common Mixer parameters"](#).



MIXFADER

This mixer has eight **DYNAMIC CONTROL/AUDIO** signal inputs, one Chain input and one output. Each input is equipped with a separate attenuation slider. The mixer has an Channel Mute button for each channel for enabling/disabling the input. Each Channel Mute button can be labelled. The mixer also has a Pad button for attenuating all inputs by another -6 dB. See also "[Common Mixer parameters](#)".

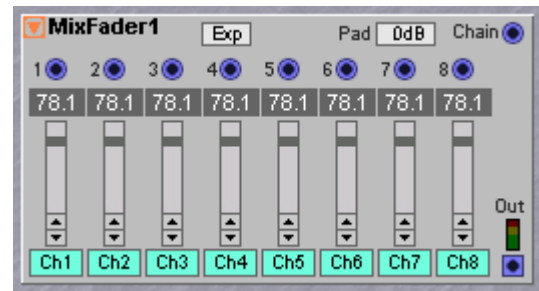

MIXSTEREO

This mixer has six **DYNAMIC CONTROL/AUDIO** signal inputs and a stereo output. Each input is equipped with a separate attenuation control of **[ATTENUATOR TYPE II]** and a Pan knob. The Pan knobs attenuate the middle of the stereo panorama by -3dB. The mixer also has a Master Level knob for the output signal. See also "[Common Mixer parameters](#)".



PAN

This module takes an input signal and outputs it in a stereo panorama.

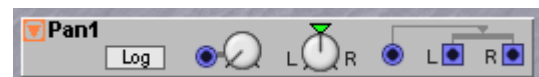

LOG/LIN

Switch between Linear and Logarithmic characteristics for the L/R knob. 'Lin' is suitable for control signals and 'Log' for audio signals. The 'Log' setting is similar to a -3dB knob found on studio mixing desks, to fix what is named 'the hole in the middle' of the stereo panorama. When the Pan L/R knob is in its center position both output channels are attenuated by about -3dB, which is acoustically the correct balance. When in 'Lin' setting both output channels are attenuated by -6dB in the center position.

PAN MODULATION INPUT

The **DYNAMIC CONTROL/AUDIO** modulation input of the Pan module. Connect a modulator to modulate the position of the signal in the two outputs. The amount of modulation is controlled with the knob **[ATTENUATOR TYPE I]**.

L/R KNOB

Sets the initial pan position. Click on the triangle to reset the initial position to an equal amount of the incoming signal at both the outputs.

LINEAR

Click to select linear Pan characteristics instead of logarithmic. See also "[Common Mixer parameters](#)".

X-FADE

This mixer can be modulated by a control signal to produce a crossfade between two incoming signals.

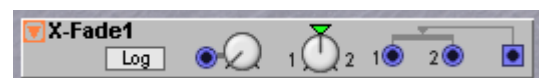

LOG/LIN

Switch between Linear and Logarithmic characteristics for the 1/2 knob. 'Lin' is suitable for control signals and 'Log' for audio signals. When set to 'Log' mode both input signals have an attenuation of about -3dB when the 1/2 knob is in its center position. When in 'Lin' mode both input signals have an attenuation of -6dB when the 1/2 knob is in its center position, which is equal to the mathematical mean of the sum of input 1 and 2 divided by two.

X-FADE MODULATION INPUT

The **DYNAMIC CONTROL/AUDIO** modulation input of the X-fade module. Connect a modulator here. The amount of modulation is controlled with the knob **[ATTENUATOR TYPE I]**.

1/2 KNOB

Sets the initial mix of the two signals. Clicking on the triangle will set the mix to an equal amount of both signals.

LINEAR

Click to select linear crossfade characteristics instead of logarithmic. See also "[Common Mixer parameters](#)".

FADE 1-2

This is a fader with one input and two outputs, and a fader rotary knob to fade the input signal between the two outputs.

**FADE MODULATION INPUT**

The **DYNAMIC CONTROL/AUDIO** modulation input of the X-fade module. Connect a modulator here. The amount of modulation is controlled with the knob **[Attenuator Type I]**.

L/R KNOB

With the L/R knob you fade the input signal between the two outputs. In the 12 o'clock position both outputs are silent. See also "[Common Mixer parameters](#)".

FADE2-1

This is a fader with two inputs and one output, and a fader rotary knob to fade between the two input signals.

**FADE MODULATION INPUT**

The **DYNAMIC CONTROL/AUDIO** modulation input of the X-fade module. Connect a modulator here. The amount of modulation is controlled with the knob **[Attenuator Type I]**.

1/2 KNOB

With the 1/2 knob you fade the between the two input signals. In the 12 o'clock position the output is silent. See also "[Common Mixer parameters](#)".

SWITCH GROUP

In the Switch group you will find different types of switches for signal routing tasks and Control/Audio signal multiplexers etc.

COMMON SWITCH PARAMETERS

CTRL OUTPUT WITH DISPLAY BOX AND CTRL INPUT

The Control output combined with a Display Box is a special feature of the Switch modules. It's especially designed to work with the Ctrl Inputs of the Multiplexer modules. As soon as you activate a Switch module by clicking on a button, for example, the Control output sends out a control signal offset depending on which button you select. The offset value is also shown in the Display Box. This control signal offset can then be patched and used to activate the corresponding "channel" in a Multiplexer module. Let's have a look at the following example:



Let's say we want to be able to activate the channel in the 1-8Mux module that corresponds to the button we select in the 8-1Switch module.

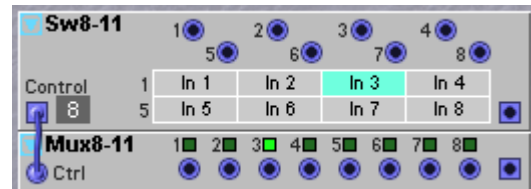

1. Connect the Ctrl output of the 8-1Switch to the Ctrl input of the 1-8Mux.
2. Now, click on the In 3 button of the 8-1Switch and note that the third LED of the 1-8Mux is lit.
3. Click on the In 8 button of the 8-1Switch and note that the last LED of the 1-8Mux is lit instead.

The special thing about this Ctrl signal is that it's defined by the different "states" of the Switch module, i.e. which Channel Select button is currently depressed. The Switch module sends out the Ctrl signal value 0 for the initial state (no button or button 1 depending on type of Switch module), value 4 for the next state, value 8 for the next and so on. The maximum Ctrl signal value a Switch module can send is 28 when button number 8 is selected on an 8-1Switch or 1-8Switch module. The Ctrl input on the 8-1Mux and 1-8Mux modules responds according to these Ctrl signal ranges: $0 < 4 =$ channel 1 active, $4 < 8 =$ channel 2 active, $8 < 12 =$ channel 3 active and so on up to 28 and above, which will activate channel 8. The reason for this pre-defined Ctrl value ranges is that a Switch module button should always correspond to the same channel number on a Mux module, regardless of number of buttons/channels on the module.

INPUTS

All Mixer module inputs are **DYNAMIC CONTROL/AUDIO** signal inputs.

This means they adapt the module bandwidth to the bandwidth of the incoming signal(s). As soon as you patch an audio signal to one input, the entire Mixer module will automatically "update" to Audio bandwidth for highest possible quality. This also results in the module using more Patch Load.



OUTPUT(S)

DYNAMIC CONTROL/AUDIO depending on the input signals. Signal: **BIPOLAR**



CHANNEL SELECT RADIO BUTTONS

Most Switch modules feature radio buttons to select channel. A blue Channel Select button means that the channel is enabled and all other channels are disabled. These Channel Select buttons can also be labelled for better overview. Right-click on a Channel Select button and select 'Edit name'. Type in the new name and press Enter. Note that the name cannot be longer than 7 characters because of the size of the **ASSIGNABLE DISPLAYS** on the synth front panel. The Channel Select radio buttons cannot be assigned to a Morph Group.



SWONOFFM

The Momentary OnOff Switch is perfect for manual triggering of different things in the Patch - especially when you assign the On button to an **ASSIGNABLE BUTTON** on the synth panel. When you click the On button, the switch “closes” for as long as you hold the button and then automatically “opens” when you release the button. If no signal is patched to the input, the output will send the value 64 units when the switch closes. See also ["Common Switch parameters"](#).

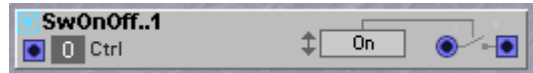

SWONOFFT

The Toggling OnOff Switch is perfect for manual activating different things in the Patch - especially when you assign the On button to an **ASSIGNABLE BUTTON** on the synth panel. When you click the On button, the switch “closes” and when you click again the switch “opens”. If no signal is patched to the input, the output will send the value 64 units when the switch closes. See also ["Common Switch parameters"](#).

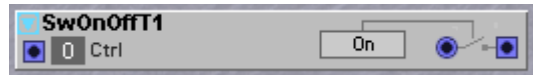

SW2-1M

The 2-1SwitchMom module has two inputs, one output and one momentary Switch button which can also be labelled. See also ["Common Switch parameters"](#).

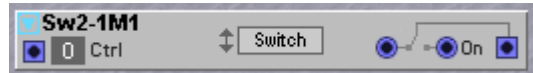

SW2-1

The 2-1Switch has two inputs, one output and two Channel Select radio buttons which can also be labelled. This module is very handy when used as an A/B switch. Imagine that the In1 is connected to the first input of a chain of audio processing modules and the In2 is connected to the last output of that chain, the switch can toggle between no effect and full effect when the final output is taken from the output of this switch. See also ["Common Switch parameters"](#).

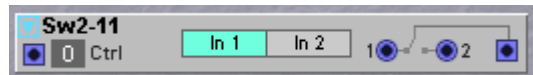

SW4-1

The 4-1Switch has four inputs with an attenuator each, one output and four Channel Select radio buttons which can also be labelled. See also ["Common Switch parameters"](#).



Sw8-1

The 8-1Switch has eight inputs with an attenuator each, one output and eight Channel Select radio buttons which can also be labelled. See also "[Common Switch parameters](#)"



Sw 1-2M

The 1-2SwitchMom module has one input, two outputs and one momentary Switch button which can also be labelled. See also "[Common Switch parameters](#)".

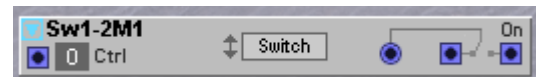

Sw 1-2

The 1-2Switch has one input, two outputs and two Channel Select radio buttons which can also be labelled. See also "[Common Switch parameters](#)".



Sw 1-4

The 1-4Switch has one input with an attenuator, four outputs and four Channel Select radio buttons which can also be labelled. See also "[Common Switch parameters](#)".



Sw 1-8

The 1-8Switch has one input, eight outputs and eight Channel Select radio buttons which can also be labelled. See also "[Common Switch parameters](#)".



VALSW2-1

The 2-1 Value Switch switches between two inputs at a definable Control signal input value.

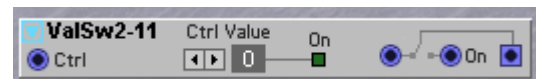

CTRL VALUE ARROW BUTTONS

Set the lower limit where the switch should change to the On input channel. Range: 0-64 units in steps of 1 unit. See also "[Common Switch parameters](#)".

VALSW 1-2

The 1-2 Value Switch directs an incoming control/audio signal between two outputs at a definable Control signal input value.

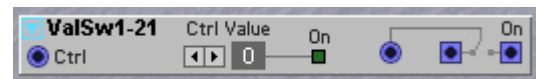

CTRL VALUE ARROW BUTTONS

Set the lower limit where the switch should redirect the input signal to the On output. Range: 0-64 units in steps of 1 unit. See also "[Common Switch parameters](#)".

WINDSW

The Window Switch “closes” when an incoming Control signal value is within the range set with the From and To parameters. When the switch closes, a high logic gate signal is also output from the yellow logic output.



FROM KNOB

Set the lower limit where the switch should close. Range: 0.0-64.0 units in steps of 0.5 units. Note: if the From value is higher than the To value, the switch never closes.

TO KNOB

Set the upper limit where the switch should open. Range: 0.0-64.0 units in steps of 0.5 units. Note: if the From value is higher than the To value, the switch never closes.

GATE OUTPUT

The yellow logic output sends out a high logic gate signal when the switch is closed. See also "[Common Switch parameters](#)".

MUX8-1

The 8-1 Multiplexer has eight inputs and one output. The channels are enabled by sending a control signal on the Ctrl input. See also "[Common Switch parameters](#)".



MUX1-8

The 1-8 Multiplexer has one input and eight outputs. The channels are enabled by sending a control signal on the Ctrl input. See also "[Common Switch parameters](#)".



MUX8-1X

The 8-1 X-Fade Multiplexer has eight inputs and one output. The channels are enabled by sending a control signal on the Ctrl input. You can also define the amount of crossfade between adjacent channels with the X-Fade knob. The crossfade function is displayed in the graph. See also "[Common Switch parameters](#)".



S&H

This module takes samples of the values of an incoming signal and holds them at the output. The sampling of the input signal occurs every time the signal on the Clk input changes from a logic LOW to a logic HIGH signal (the positive edge). In between the positive edges of the clocking signal, the module holds the value of the latest sample on the output. See also "[Common Switch parameters](#)".

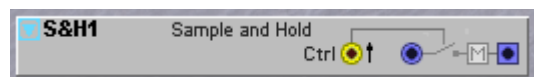

Tip! The S&H module is in essence a storage or memory cell. Traditionally it is often used to generate ‘stairway’ arpeggios by sampling an Lfo waveform or random notes by sampling a noise signal.

The S&H is also a very important synchronisation module, imagine that the keyboard Gate and Note signals are first sampled at the rate of the master tempo clock before being passed on to oscillators and envelope generators. This will delay the played notes until the next master clock pulse and get all your

notes automatically in sync with the master clock. This technique can also be used to transpose a Sequencer module from the keyboard exactly on the beat. In fact there are many, many tricks that can be done with the S&H module, especially to solve timing problems in a patch.

T&H

This module is related to a controllable open/close switch module. When the signal on the Ctrl input is a logic HIGH the Track&Hold module output simply follows the input signal. But when the signal on the Ctrl input goes to a logic LOW it will sample the momentary output value and hold it until the Ctrl input goes HIGH again. So, this module works much like a controllable switch, but with the big difference that while a normal switch will output a value of 0 units when it is inactive, this module will instead hold the last value it had on its output and not drop the output to 0 units. See also "[Common Switch parameters](#)".

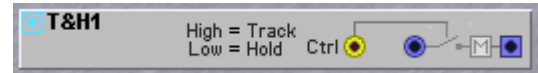

LEVEL GROUP

The Level group features modules for adding, subtracting, multiplying and modulating signal levels in the Patch.

COMMON LEVEL MODULE PARAMETERS

INPUT(S)

The **DYNAMIC CONTROL/AUDIO** signal input(s) of the Level modules.



OUTPUT

The **DYNAMIC CONTROL/AUDIO** signal (depending on input signal type) output of the Level modules. Signal: Bipolar



BiP/UNI BUTTON

Click the Uni(polar) button to change the output signal from bipolar to unipolar. When you switch to unipolar, the Level knob (see below) resolution is doubled.



LEVEL KNOB

Set the modulation signal level. In unipolar mode (see above), the Level knob resolution is doubled



CONSTANT

The Constant Value module produces a constant control signal that can be instantly set by the knob. Basically this module is a *general purpose knob module* producing a control value that can be routed to any modulation input of another module. See also "[Common Level module parameters](#)".

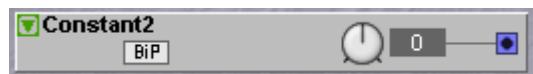

CONSTSWM

The Momentary Constant Switch module produces a control signal at a selectable offset level when you click the Switch button. Note that the Switch button is momentary, i.e. clicking it will activate the output signal only for a short while. The Switch button can also be renamed. See also "[Common Level module parameters](#)".

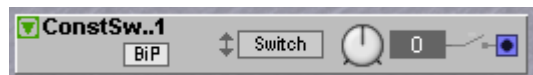

CONSTSWT

The Toggling Constant Switch module produces a constant control signal that can be instantly set by the knob after you have turned on the Switch button.

Basically this module is a *general purpose knob module* producing a control value that can be routed to any modulation input of another module. The Switch button can be labelled.

This module can be used to have an **ASSIGNABLE KNOB** on the front panel show a name of your own choice in the associated panel display. When the knob is assigned to an **ASSIGNABLE KNOB** on the front panel the Name button is automatically assigned to the panel button under the panel knob. This can be used to instantly 'mute' and 'activate' the modulation input(s) that you control with the knob. This

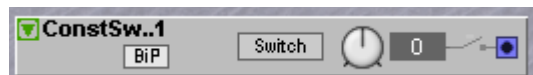

module and how it interfaces with the panel controls, is a very powerful feature of the G2. Use it, as the text you put on the button will give you the right hints in the displays when you're on stage. See also "Common Level module parameters".

LEVADD

The LevAdd module can be used to add or subtract an offset (bias) to a signal. See also "Common Level module parameters".

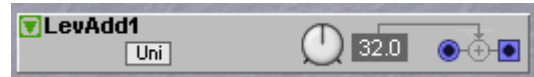

LEVCONV

The Level Converter module can be used to change polarity of an incoming signal and then output it at selectable polarity and/or phase-shifted 180 degrees.

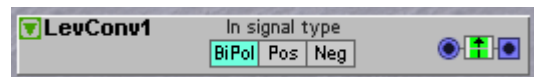

BIPOL, POS AND NEG RADIO BUTTONS

Use these radio buttons to "instruct" the module which type of input signal to expect. This is important because otherwise the conversion won't be what you'd expect. (Of course, you won't harm the system by selecting the "wrong" signal type).

OUTPUT TYPE SCROLL BUTTON

Select the type of conversion by clicking the scroll button. The figure below shows the output signal types:

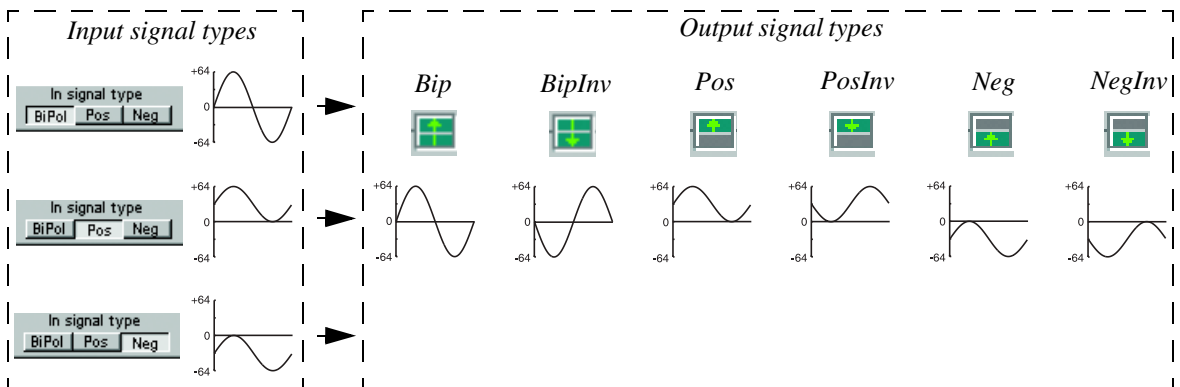

See also "Common Level module parameters".

LEVAMP

This module can amplify or attenuate a signal.



AMPLIFICATION KNOB

Select the desired amplification/attenuation with the knob. Any value above 1.0 amplifies the signal, any value below attenuates it. Range: 0.25 to 4.0 times the input level. See also "Common Level module parameters".

LEVMULT

The Level Multiplier module performs the same functions as a traditional VCA, a voltage controlled amplifier, in an analog system would do. It multiplies two



incoming signals (input 1 times input 2 = output). It also functions as a ring modulator (see example below). See also the LevMod module later in this chapter

INPUTS

Patch two separate signals to each of the inputs. A signal with a level of 0 units at any of the inputs will close the gain control function, a signal with a level of +64 units at any of the inputs will open the gain control function completely. A signal with a level of -64 units at any of the inputs will invert the polarity of the output signal. See also "[Common Level module parameters](#)".

RINGMODULATOR

Many classic analog synthesizers feature a module named a ringmodulator. The name ringmodulator refers to an electronic circuit used in the early days of shortwave radio and telephony and the original circuit was made with coils and crystal diodes. The ringmodulator circuit is able to multiply two signals together, similar like how a mixer adds two signals together. When transistors became available the ringmodulator circuit was replaced by a transistorized circuit named a balanced modulator or four quadrant multiplier. All analog synthesizers used the transistorized balanced modulator circuit and not the original coils and diodes circuit. But probably as in some of the earliest electronic music of the 1950's the original coils/diodes circuit was used there is some lore about the ringmodulator, which in fact is nothing but lore.

The G2 equivalent of the balanced modulator is the LevMult module. It does exactly what a ringmodulator does, so it could have been named ringmodulator. Or balanced modulator, or four quadrant multiplier. But instead the name LevMult was chosen, as that is what all these 'ringmodulator' circuits actually are: plain multipliers.

Multiplying two repetitious waveforms with each other produces a new waveform, which contains frequencies that on the frequency scale have 'sum and difference' values. Read more on this at "[Ring modulation](#)" on [page 281](#).

There are basically three types of analog devices that have become known as ringmodulators in the synthesizer world. All three have at least one multiplier circuit at their heart. The first and simplest type has only two inputs and one output and nothing more, not even knobs. On the G2 this type is named the LevMult module. A second and slightly more versatile incarnation has one extra control knob that lets the output crossfade between the multiplier output and one of the multiplier inputs. On the G2 this type is named the LevMod module. The third incarnation is a pretty complex circuit known as the Bode ringmodulator or Bode frequency shifter, which contains a complex phase shifting network, a built in oscillator and four multipliers and a mixing network. The advantage of the Bode frequency shifter is that it has the sum and difference frequencies available on two separate outputs. On the G2 this type is named the FreqShift module in the FX module group.

So, if you're looking for a ringmodulator in the G2 and you think you can't find it, know that all classic variations of ringmodulators are actually present, but simply with more correct names. For your convenience the three basic patches of 'classic' ringmodulators are shown together. Note that the LevMod and FreqShift modules used in the second and third examples will be explained later.

EXAMPLES FOR THREE TYPES OF CLASSIC RINGMODULATORS

Simple type using the LevMult module

This patch uses the LevMult module to emulate the coils/diodes circuit. The old analog circuits exhibited a lot of odd harmonic distortion, like up to 10%, and this distortion does have a pronounced effect on the sound. On the G2 this distortion can be nicely replicated by connecting the output of the LevMult to the input of a Saturate module and add just a little touch of saturation effect.

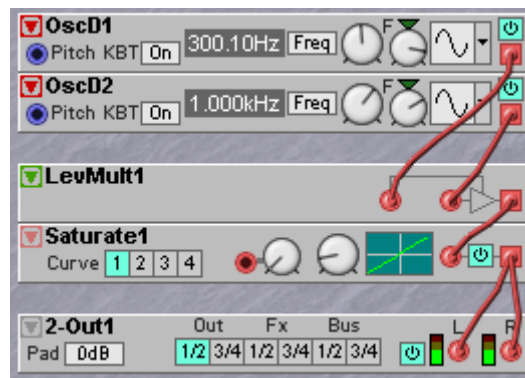

Type with crossfader between input and output

This patch uses the LevMod module to emulate the transistor balanced modulator. The LevMod module has a controllable crossfader between the output and one of the inputs of a multiplier, which will be put to good use to emulate some of the balanced modulator quirks. By setting the balance of this crossfader to almost the Bal position the circuit will exhibit the ‘leakage’ of input signal that is common in analog balanced modulators. By feedback of a little of the output signal to the Mod depth input, which is the control for the internal crossfader, some extra even harmonic distortion is generated. This type of ringmodulator is ideally suited for input signals that have a ‘pure’ harmonic ratio. E.g. a classic ‘ringmodulator sound’ is made when this circuit is fed with two squarewaves with an ‘pure quint’ (3:2) frequency ratio. See “[Example of just tuning](#)” on [page 167](#) to learn more on how to create pure ratios between two oscillators.

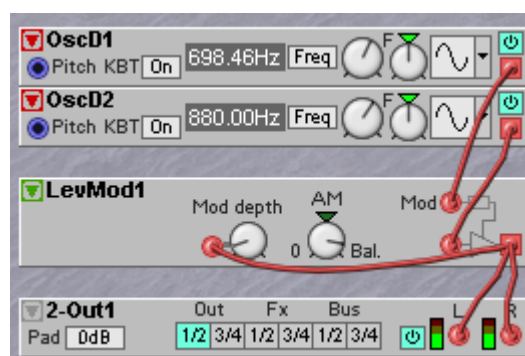

Type with the Bode frequency shifter

This patch uses the G2 FreqShift module to create two different output signals, one that appears to be ringmodulated towards higher frequencies and one that appears to be ringmodulated towards lower frequencies. When these outputs are mixed together they will produce the sound of the original ringmodulator. Using a crossfader to mix these signals can make you glide from the upwards to the downwards signal and vice versa. Again, a slight touch of saturation will help in recreating that vintage early electronic music sound. Tip! On all three types a little extra ‘pingpong’ echo with a delaytime of about 80 msec and a touch of ‘small’ reverb will add nicely to the ‘vintage’ character.

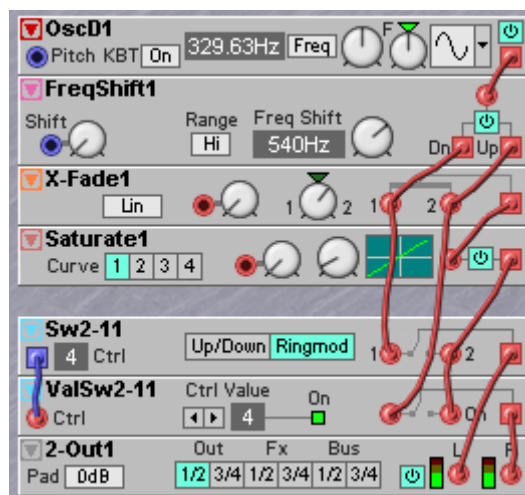

LEVMOD

The Level Modulator module is in essence a multiplier where the depth of the modulation of the main input by the Mod input can be controlled by a Balance knob control. This Balance knob actually makes a crossfade



between the clean main input and the ‘product’ of the main input and the Mod input. In effect this will let you transform the signal on the main input gradually from unmodified, via amplitude modulated to balanced modulated (ringmodulated).

When used on control signals the Balance knob will smoothly glide between the control signal and the control signal modulated by another control signal. The Balance itself can also be modulated, which means that it modulates the modulation applied to a modulation signal. To understand this better take note that there are in fact three inputs on this module; 1) the main input, 2) the Mod input that modulates the main input and 3) the Mod depth input that modulates the amount of modulation of the Mod input to the main input. If the previous explanation reads like gobbledegook, just imagine the inputs as three sonic booster rockets stacked on top of each other and you pretty much get the idea.

O/AM/BAL. BALANCE KNOB

Set the modulation amount with this rotary knob. In the 12 o’clock position you get maximum amplitude modulation, and past this position, ring modulation occurs.

MOD DEPTH INPUT AND KNOB

You can modulate the AM/Bal depth with a modulation source connect to this input. The amount of modulation can be attenuated with the knob **[ATTENUATOR TYPE I]**.

MOD

Patch the unipolar or bipolar modulator (LFO, Envelop or Oscillator) to this input.

IN

Patch the bipolar carrier (Oscillator or other sound generator) to this input

GRAPHIC EXAMPLES

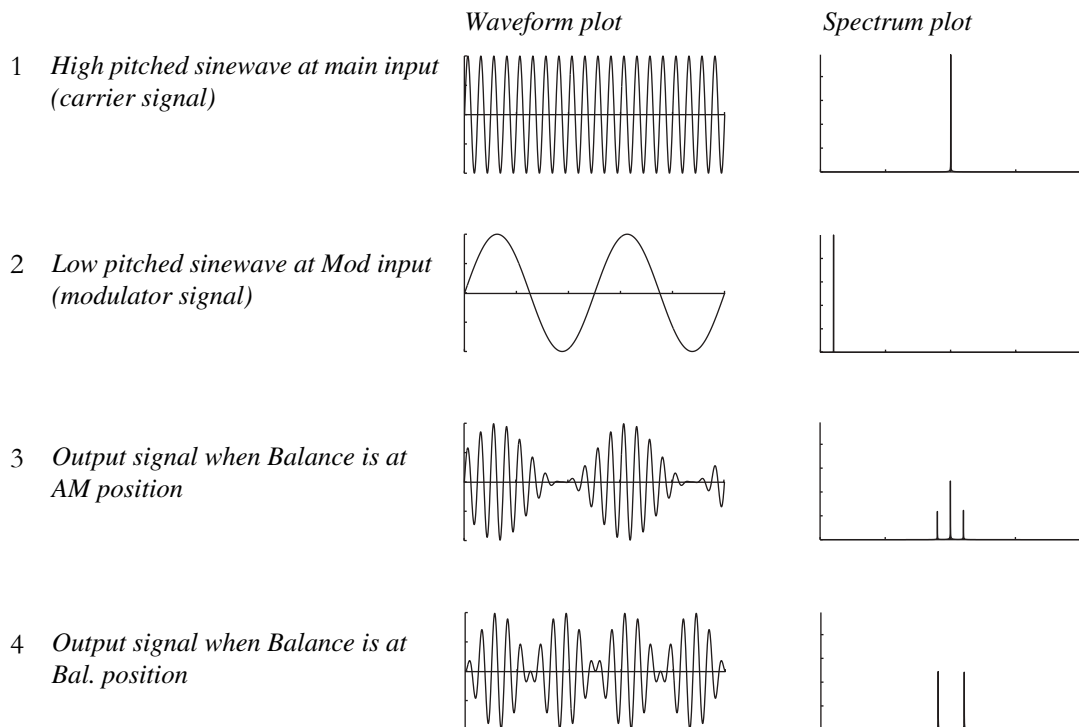

The graphic examples shows that the main practical difference between amplitude modulation and balanced modulation (ringmodulation) is the sideband amplitudes and the appearance of the carrier wave in the frequency spectrum. When balanced modulation is applied both the carrier frequency and modulating frequency will disappear completely from the output. Another difference is that the resulting ring modulation wave phase-shifts 180 degrees (inverts) every half modulator period. If more complex waveforms are used for amplitude- or ring modulation, sidebands will be generated for each partial of the wave. See also "[Common Level module parameters](#)". Note that the Mod depth input will make the output crossfade between the third and the first and the fourth wave graphic in the graphic example.

ENVFOLLOW

This module will extract an envelope from a signal, producing a smoothed control signal on its blue output that follows the amplitude envelope of an incoming audio signal. The module has different smooth parameters for when the input signal ‘swells’ or ‘decays out’. Meaning that when the input signal increases in amplitude, the output “follows” the amplitude with a smoothing rate set by the Attack time. When the input signal amplitude decreases, the output “follows” the amplitude with a smoothing rate set by the Release time. The input of this module is a **DYNAMIC CONTROL/AUDIO** signal input and the output signal is a **POSITIVE UNIPOLAR** control signal. See also "[Common Level module parameters](#)".

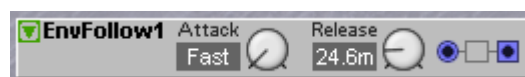

NOISEGATE

The Noise Gate can be used to “block out” low signal levels, like faint background noises in a ‘silent’ period in an external audio signal. When an input signal rises above the set Threshold value, the gate opens with the time set with the Attack knob. When the input signal decreases below the set Threshold value, the gate closes with the set Release time. The LED above the output indicates when the input signal is being passed (LED lights up) or being blocked (LED is dimmed). The module also has an additional built-in envelope follower with a separate output for the envelope control signal.



ENV OUTPUT

Outputs a unipolar envelope signal based on the input signal. Signal: **POSITIVE UNIPOLAR**. See also "[Common Level module parameters](#)".

COMPLEV

This module produces a logic signal on its yellow output by comparing a **DYNAMIC CONTROL/AUDIO** signal level to the value set by the knob. If the value of a signal appearing at the input *greater than or equal to* the value set in the window, the module produces a logic HIGH signal. The logic signal will switch back to LOW when the incoming signal drops to a level below the set value.



LEVEL LIMIT KNOB

Set the level limit for the comparison with the knob. Range: -64 to +64 units. The value is shown in the Display Box. See also "[Common Level module parameters](#)".

COMPSIG

This module produces a logic signal on its yellow output by comparing two **DYNAMIC CONTROL/AUDIO** input signals. If the value of a signal appearing at the A input is *greater than or equal to* the value of a signal appearing at the B input, the module produces a logic HIGH signal. The logic signal will remain HIGH for as long as the incoming signals meet the condition. See also "[Common Level module parameters](#)".

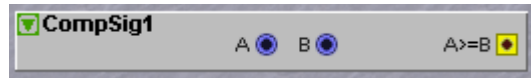

MINMAX

The MinMax module compares two input signals and outputs the highest levels on the Max output and the lowest levels on the Min output. This module is originally named a 'level switcher' on old analog systems. The MinMax module can be used to 'sort' two signals. It can be used to 'split' two lfo signals into two new signals where one signal is always at a lower value and the other signal always at a higher value. The module can also be put to good use in the audio range to 'mix' two unisono detuned waveforms like triangle waves. See also "[Common Level module parameters](#)".

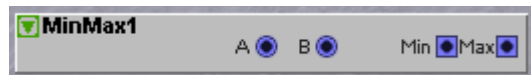

EXAMPLES

The figures to the right shows how two input signals A and B generate the Max and Min output signals in two different situations:

Example 1: Two bipolar input signals processed to one Max and one Min bipolar output signal.

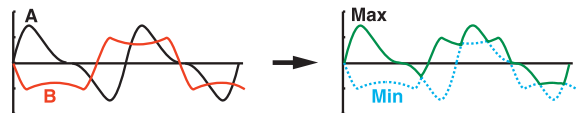

Example 2: One bipolar and one negative "DC" offset input signal processed to one Max and one Min bipolar output signal.

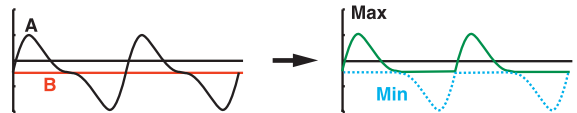

EXAMPLE PATCH OF A BUBBLESORT THAT SORTS FOUR SIGNALS ON MAGNITUDE

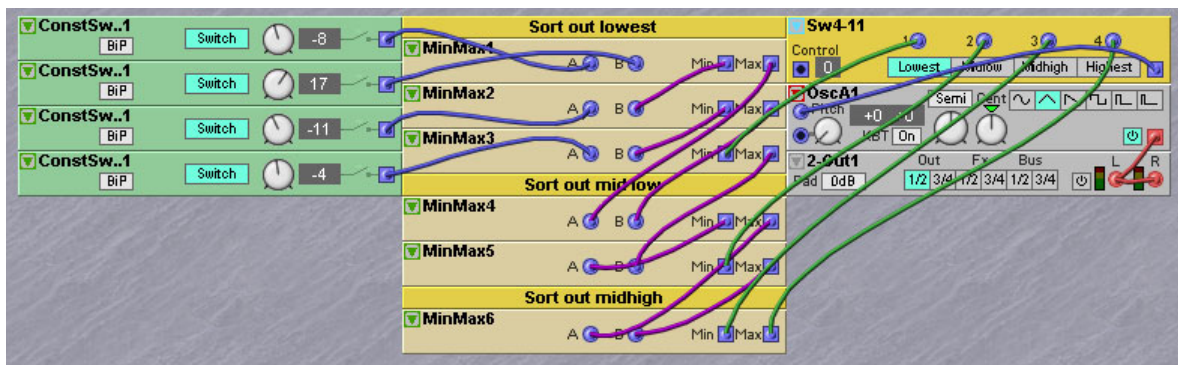

MODAMT

The Modulation amount control module can be used to change the characteristics of a control signal before being routed to a control signal input of a module.

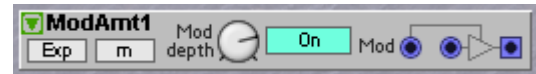

m/1-m

Click the m/1-m button to output the signal patched to the input at full level when the Mod depth knob is at its minimum value. If the 1-m function is inactive, the signal patched to the input won't be output at all at minimum Mod depth value (see example below).

MOD INPUT

Patch the control signal you want to multiply with the input signal here (see example below). See also "[Common Level module parameters](#)".

EXAMPLE

Let's say we want to modulate the amplitude of an LFO signal with an Envelope control signal and be able to control the total output level of the resulting signal with the Mod depth knob.

INPUT SIGNALS:

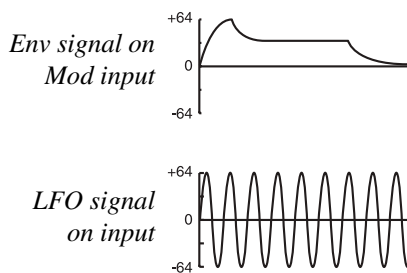

OUTPUT SIGNALS:

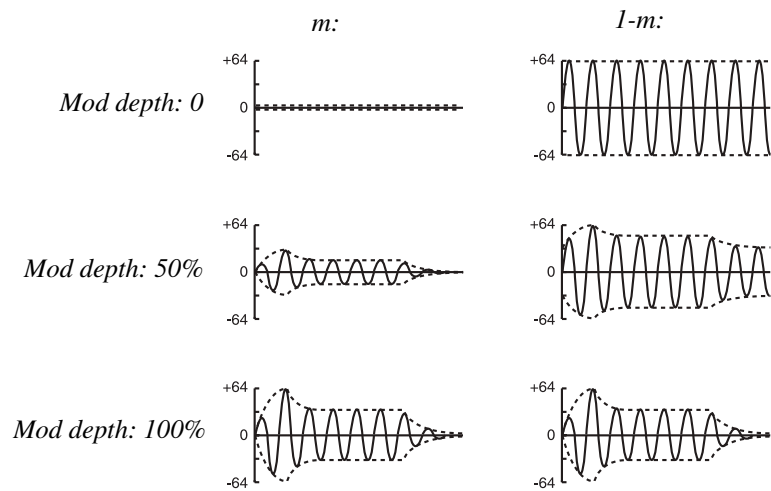

LOGIC GROUP

These modules can generate and combine logic signals in a number of different ways. A logic output signal will have one of only two states: a logic HIGH, which always corresponds to a value of +64 units and a logic LOW, which always corresponds to a value of 0 units. But the *edges* of logic signals can be very important as well, edges are when a logic signal changes from LOW to HIGH, which is named the *positive edge* or from HIGH to LOW which is named the *negative edge*. Edges can specify a precise moment in time when you want something to happen, like playing a note or advance a sequencer to its next step. Triggering will always use the positive edge of a logic signal and doesn't care how long the logic signal stays in its HIGH state.

Getting everything in perfect timing means many times to delay the edges of logic signals to moments in time specified by e.g. the positive edges of the pulses in a master clock signal. In this group you will find modules that can help you to synchronize events to a master clock.

Note that synchronization is very important in music. Still, many times it is not at all that easy and obvious how to do it. In fact synchronization is an art by itself that takes some time to master. Our advise is to take the time it takes and learn it one step at a time. As you will find out this is also how logic works; step after step.

Read more about logic signals at [“Logic or gate signals, yellow and orange connectors”](#) on page 135.

COMMON LOGIC MODULE PARAMETERS

LOGIC SIGNAL INPUT(S)

The **DYNAMIC CONTROL/AUDIO** signal input(s). If you input an audio signal, the color of the input(s) and logic signal output(s) change color to orange to indicate that the module has adapted itself for audio rate bandwidth. Any positive value in the input signal will be interpreted as a logic HIGH signal on a logic input. Any negative value or a value of zero will be interpreted as a logic LOW signal on a logic input. So, if the input signal is not already a logic signal, it will first be transformed at the input to a logic signal according to the previously describe ‘rules’ before being used internally in the module.



LOGIC SIGNAL OUTPUT(S)

The **DYNAMIC CONTROL/AUDIO** signal (depending on input signal bandwidth) output(s). Can output either a logic LOW signal (0 units) or a logic HIGH signal (+64 units). The LED shows the state of the output signal, on a logic HIGH the LED lights up and on a logic LOW the LED is dimmed.



CLOCKED SIGNAL INPUT(S)

The **DYNAMIC CONTROL/AUDIO** clocked signal input(s). A clocked signal input with a single arrow next to it will only react when an input signal changes from a logic LOW to a logic HIGH state. This moment is also named the *positive edge* of the clocking signal.



DELAYED ACTION RST INPUT

Some Rst signal inputs have a *barred arrow* next to their input connector. This tells that the module has a *delayed* function, meaning it will wait for the *positive edge* on *another* signal input before resetting the module. In practice it means that the actual reset is synchronized to the clock pulses on the Clk input.



RST INPUT (LEVEL CONTROLLED)

A level controlled Reset signal input has *no arrow* and is used to reset a module to its initial value on the moment when a logic HIGH reset pulse arrives and then *halts* or *disables* the module until the reset signal has returned to a logic LOW level. So, as long as there is a logic HIGH level on this input the module will stay inactive in its default state.



FUNCTION DROP-DOWN SELECTORS

Click the Function drop-down selector to alter the processing function of the module. Note that changing a function with drop-down selectors will force the Sound engine to optimize the DSP resources and thus cause a brief moment of silence.

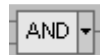

GATE

This module features two independent logic gates. A gate is a device that combines two logic levels, in a way that is a bit similar to how a mixer mixes two audio signals. Like a two channel mixer, each gate has two inputs and one output, but there are actually several different combining functions possible on two logic signals. For each different combining function there is a different gate type available. You select this gate type from the drop-down selectors. The gate types on this module are: AND, NAND, OR, NOR, XOR and XNOR. The respective gate functions are described with *truth tables* that are visible when you click the drop-down selector. In the truth table you see which combination of logic values gives which output signal. See also "[Common Logic module parameters](#)".

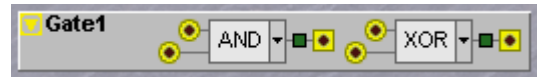

Note that the word 'gate' comes from the electronics world where it is the name for a group of digital devices. Gate devices are something completely different than the Keyboard Gate signal that comes from the keyboard to signal that a key is pressed, although the same word is used for both. Still, gate devices can be put to good use to process the Keyboard Gate signal.

INVERT

The Invert module holds two independent logic inverters. When an incoming signal is at a logic LOW state the output will transmit a logic HIGH. When an incoming signal is at a logic HIGH state the output will transmit a logic LOW. So, the output is always the inverse of the input. See also "[Common Logic module parameters](#)".

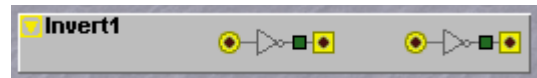

Tip! When an output is connected to its own input the Inverter will start to produce a squarewave signal at 12kHz if the module is yellow and a squarewave signal at 48kHz when the module is orange. These very high frequency signals can be used to e.g. clock a clocked random module with Rst and Seed inputs to produce what is named synced noise.

FLIPFLOP

The FlipFlop module holds two different functions named a D-type flipflop and a Set-Reset flipflop.



THE D-TYPE FLIPFLOP

The D-Type flipflop will clock the logic state on the D input to the Q output on the positive edge of a clock signal on the Clk input. The Q-Bar output will always be the inverted state of the Q output. Whenever there is a logic HIGH signal present on the Rst input the Q output will become 'always low' and the Q-Bar 'always high' and the flipflop will ignore any clocking commands until the Rst input is brought low again.

THE SET-RESET FLIPFLOP

When the module is set to the Set-Reset type flipflop (or RS-type flipflop) the D input changes into a S(et) input. When the S input receives the positive edge of a clock pulse it will set the Q output to a logic high

level and the Q-Bar output to a logic low level. The S input is in fact the opposite of the Rst input, but when the Rst input is also brought high the Rst will have priority over the S input.

The RS-type flipflop can also toggle the states on the Q and Q-Bar outputs automatically when a clock signal is connected to the Clk input. For this to work both the Rst and the S input must be permanently low. When in toggling mode and the S and/or the Rst inputs receive a constant logic high level, the toggling will stop as both the S and the Rst inputs have priority over the Clk input on a RS-type flipflop. See also "Common Logic module parameters".

CLKDIV

The Clock Divider module can be used for dividing incoming clock pulses by a factor 'n', which can be set with the Divider control. This module has two possible modes that can be set by the dropdown control.

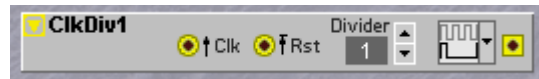

DIVIDER

Set the desired division with the buttons. Range: 1 to 128. The division denominator is shown in the Display box.

GATED MODE

In this mode the module will pass on every n-th clockpulse on the Clk input. The shape of the input clockpulse is left unaltered.

In the schematic to the right you see how the original train of clock pulses will be passed on to the output. You can see how the pulse length of clock pulses is maintained in the divided clock signal at the output of the module. If the Divider control is set to 1 the incoming train of clockpulses is passed unaltered to the output.

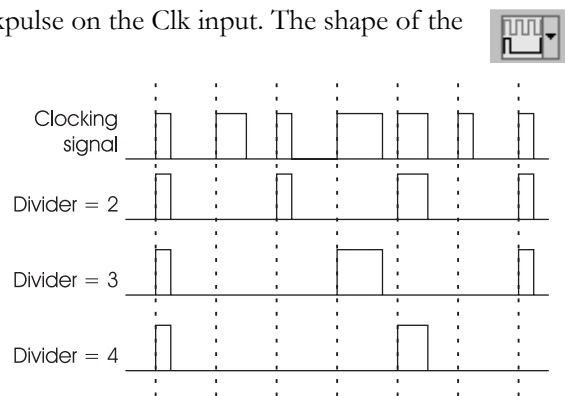

TOGGLED MODE

In this mode the output of the ClkDiv module will toggle its logic output state on every n-th edge of a clockpulse on the Clk input. If the clock signal is at a steady rate the output signal will be a squarewave signal at e.g. half the clocking rate when the Divider is set to two.

Note that both the positive or rising edge and the negative or falling edge in the input signal can toggle the output state. This means that when the Divider control is set to e.g. 3 the actual frequency of the input signal is divided by one and a half.

DELAYED RST INPUT

The Rst input has a *barred arrow* symbol. Note that this means that the resetting action will be *delayed* until the next positive edge of the clocking signal on the Clk input.



PULSE

This module will generate a logic HIGH pulse of a set duration on the moment it receives a logic signal on its input. The duration of the logic HIGH pulse can be set in three ranges, range Sub is from 0,1 msec to 1 second, range Lo from 1 msec to 10 seconds and range Hi

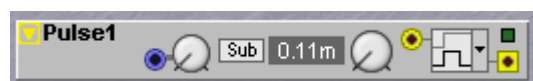

from 10 msec to 100 seconds. The output pulse duration can be dynamically controlled by a control signal on the blue control input.

The module can initiate the logic HIGH pulse on either the *positive edge* or the *negative edge* of the logic signal on its input, selection is done with the drop-down selector.

DELAY TIME MODULATION

A **DYNAMIC CONTROL/AUDIO** input for modulating the Delay time. The modulation amount can be attenuated with the knob of **[ATTENUATOR TYPE I]**.

SUB/LO/HI SCROLL BUTTON

Select Delay time ranges by clicking this scroll button.

PULSE TIME KNOB

Set the Pulse time with the knob. Range (Sub): 0.10 ms to 1.00 s, (Lo): 1.04 ms to 10.00 s, (Hi): 10.4 ms to 100.0 s. If the module receives another *edge* trigger during the Pulse period, it will extend the duration, with the value set with the knob.

PULSE TYPE DROP-DOWN SELECTOR

Select Pulse Type between Positive Edge Pulse trig and Negative Edge Pulse trig. See also "[Common Logic module parameters](#)".

DELAY

This module can delay the edges of a logic HIGH clock pulse. Depending on the setting of the Delay Type drop-down selector the module will delay the *positive edge*, the *negative edge* or both the *positive and negative edge* by the time set with the Time knob. When both the positive and negative edge are delayed it is like the clock pulse is shifted in time. Note that the module can only delay one single pulse, meaning that it must have finished with the delay of a clock pulse before it can receive a new clock pulse to be delayed.

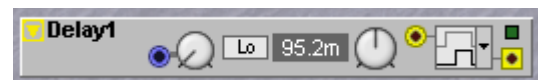

DELAY TIME MODULATION

A **DYNAMIC CONTROL/AUDIO** input for modulating the Delay time. The modulation amount can be attenuated with the knob of **[ATTENUATOR TYPE I]**.

SUB/LO/HI SCROLL BUTTON

Select Delay time ranges by clicking this scroll button.

DELAY TIME KNOB

Set the delay time with the knob. Range (Sub): 0.10 ms to 1.00 s, (Lo): 1.04 ms to 10.00 s, (Hi): 10.4 ms to 100.0 s.

DELAY TYPE DROP-DOWN SELECTOR

Select Delay Type between Positive Edge Delay (only the positive edge of the input signal is delayed), Negative Edge Delay (only the negative edge of the input signal is delayed) and Cycle Delay (the entire input signal cycle is delayed). See also "[Common Logic module parameters](#)".

8COUNTER

The 8-Counter steps a logic HIGH signal sequentially over eight outputs. Note that only one of the outputs



can be HIGH at a time. On every new incoming clock pulse the module advances one step. Note that the Rst input is of the enable/disable type. See also "[Common Logic module parameters](#)".

Tip! The length of the sequence can be shorted when an output is fed back to the Rst input, e.g. when output 4 is connected to the Rst input the module will step through steps 1, 2, 3 and when at 4 immediately jump back to step 1. Additionally, when the feedback connection is routed through a controllable switch like a multiplexer module, the module can be forced between sequences of different steps by a control signal, and so become a 'controllable divider' module. If the signal that goes to the Rst input is also connected to the Rst input of a sequencer module, you can e.g. make the sequencer play sequences of different lengths controlled by a modulation control signal.

BINCOUNTER

The BinCounter is an 8 bit binary counter which outputs logic HIGH signals. Counting advances one step on the positive edge of every incoming clock pulse. The eight outputs together form the binary code for the current state value the binary counter is in. In practice you can use this module to have clock signals at half speed, a quarter speed, an eighth speed etc., derived from one master clock connected to the Clk input. Note that the Rst input is of the enable/disable type. See also "[Common Logic module parameters](#)".



ADCONV

The ADConv module is an 8 bit A/D converter. It converts a control signal between -64 and +64 units to a 'two's complement' code, where each output represents the weight of one of the bits in the eight bit code. The two's complement coding means that the D7 output defines if the input signal is positive or negative (it is named the sign bit). The module outputs logic HIGH signals on its outputs depending on the current input signal level. See also "[Common Logic module parameters](#)".



DACONV

The DAConv module is an 8 bit D/A converter that accepts a two's complement coded binary number code. The module outputs a bipolar signal with values depending on the current logic input signals. Note that the module can output bipolar signals and that a logic HIGH signal on input D7 will result in a negative output signal (D7 is named the sign bit). See also "[Common Logic module parameters](#)".



Tip! The DAConverter and ADConverter can be used to transfer eight logic trigger or gate signals over one of the G2 Audio Bus lines. To do so connect the eight triggers to the inputs of a DAConverter module and send its blue output to a Bus line. In another Slot the signal from this Bus line is fed into the blue input of an ADConverter module and the eight triggers will reappear on the outputs of the ADConverter. This can be a convenient way to transport eight drum triggers from a Slot holding sequencer modules to another Slot holding a drumkit patch using up just one Bus line.

Advanced tip! Connect all outputs except the 128 output of the BinCounter to inputs D0 to D6 of the DAConverter and route the blue output of the DAConverter into the A input of a CompSig module. Connect a Constant module to the B input of the CompSig module and connect the output of the CompSig module to the Rst input of the BinCounter. Set the Constant module to Unipolar. Clock the BinCounter with the Clock Generator, an Lfo or an oscillator. This patch gives a programmable divider

that can divide up to 128. When the Constant module is replaced by e.g. a Value Sequencer module set to Unipolar, it is possible to sequence up to sixteen moderately long periods of presettable length, useful to set e.g. the length of different parts in a song. Maximum length of each period would be eight bars. If you would want to use the 128 output and D7 input you must insert an inverter module between these two connectors and use the full range from -64 units to +64 units in half unit steps. But in many cases it might be easier to predivide the BinCounter clockpulse to one clock for every four 16th notes. Which would make it possible to sequence through sixteen periods of a maximum of 32 bars per period.

SEQUENCER GROUP

The sequencer modules are commonly used to sequence note and modulation patterns. At the heart of a sequencer is a short row of ‘step memory locations’ where information like note values and trigger states can be stored. The idea is to step through this row by means of a clock signal and outputting the information from the current step memory location in the row. The sequencer modules in the Nord Modular G2 system have (up to) 16 steps each. They can easily be linked together in series to provide longer sequences and they can be clocked by various clock sources, originating from other modules or from the G2 Master Clock/MIDI CLOCK. The sequencer modules can be synchronized to each other in a number of ways. Read more about some of the possible combinations with the sequencer modules at the end of this chapter.

By assigning a sequencer module to the G2 front panel **ASSIGNABLE KNOBS AND BUTTONS** it will become real easy to variate and reprogram the sequencers in a live situation. The current step positions will be shown by the LEDs below the knobs on the frontpanel. Step values will be shown in the displays and by the LEDs around the knobs. And the LEDs above the pushbuttons will show if event buttons in trigger-rows are On or Off.

COMMON SEQUENCER PARAMETERS

CLK INPUT

This is a yellow trigger input for the clock pulses that will make the sequencer advance to the next step in the row. The sequencer will advance immediately on the *positive edge* of a pulse in a clock signal. If the clock signal is not a logic signal it will automatically be transformed to a logic signal at this input. Meaning you can also use blue Lfo or red Oscillator signals to advance the sequencer. A red signal on this input will change the sequencer to an orange/red module, so you can use sequencers for audio waveform generation as well.



SEQUENCER VALUE-ROW OUTPUT

On this output is a mix of the sequencer value-row chain input *plus* the value of the current step in the row. So, the step value is always added along to the value on the value-row chain input before being sent to this output. This makes chaining sequencers very easy. Note that when the sequencer is in Park mode, the value of the current step is not added along and only the value on the value-row chain input will be passed to this output.

Signal: **Unipolar** or **Bipolar**.



SEQUENCER VALUE-ROW CHAIN INPUT

This is the chain input for the value-row. The value on this input will always be ‘present’ within the actual value of the value-row output. The value of the current step position will be added along to this value, unless the sequencer is in Park mode, when only the value on this chain input will be passed to the value-row output. If this input is left unconnected it is assumed to have a value of 0 units.



SEQUENCER TRIGGER-ROW OUTPUT

On this output is the logic OR of the sequencer trigger-row chain input OR’ed by the trigger state of the current step in the row. So, the step’s trigger button state is always combined with the current logic state on the trigger-row chain input before being sent to this logic output. This makes chaining sequencers very easy. Note that when the sequencer is in Park mode, the trigger button state of the current step is discarded and only the current logic state on the trigger-row chain input will be passed to this output. The OR operation means that the output will produce a trigger signal if [either the row] or [the chain input] or [both the row and the chain input] produce a trigger signal. Which is logical, isn’t it? Signal: **LOGIC**



SEQUENCER TRIGGER-ROW CHAIN INPUT

This is the chain input for the trigger-row. The logic state on this input will always be passed on to the trigger-row output. The step's trigger button state of the current step position will be OR'ed to the state of this input, unless the sequencer is in Park mode where only the logic state on this chain input will be passed on to the trigger-row output. If this input is left unconnected it is assumed to be in a logic LOW state. 

DELAYED RST INPUT

This is a yellow trigger input where a logic HIGH signal will restart the sequencer (force it to step 1 again). The restart isn't performed until the *positive edge* of the next clock pulse arrives at the Clk input. This guarantees perfect restart timing. The fact that the reset action is delayed is shown by the *barred arrow* next to the input connector. 

This is a bit a special logic input as its action is delayed until the sequencer also receives a logic high signal on the Clk input. See it like this, when this input receives a positive edge it prepares the sequencer for a restart, but doesn't perform the restart yet. The actual reset is performed on the next positive edge on the Clk input.

LOOP INPUT

This is a yellow *barred arrow* trigger input where the *positive edge* of a logic HIGH pulse signal will prepare a cascade of serially linked sequencers to properly restart the total sequence at the end of the last step of the last sequencer. This input is only used to patch a Link signal from the *last* sequencer module in a serial connection to the Loop input of the *first* sequencer. 

PARK INPUT

This is a yellow trigger input where the *positive edge* of a logic HIGH pulse signal will park the sequencer. When a sequencer is parked the outputs of the module are temporarily disabled. The sequencer will restart at step 1 after a restart is prepared with the Rst or Loop input and the next Clk pulse arrives. Note that going into Park mode is immediate and not delayed until the next Clk pulse. 

LINK OUTPUT

This yellow output transmits a high logic signal whenever the sequencer goes *beyond* the last step in the sequence, so *at the end of the last step*. This signal can be used for linking several sequencers in series. If the sequencer is in Loop mode it will appear like the Link pulse happens at the start of the first step, which in this case just happens to be the same moment as the end of the last step. See more about linking at the end of this chapter. 

LOOP/1-CYCLE BUTTON

Click to switch between Loop mode and 1-Cycle mode. In Loop mode, the sequencer restarts at step 1 immediately after the last step in the sequence. In 1-Cycle mode, the sequencer only runs from step 1 to the last step and then stops. In 1-Cycle mode the sequencer is started by first preparing the sequencer for a restart with a pulse on the Rst or Loop input. Then, on the next positive edge in the clock signal, the sequencer will jump to the first step and start to advance through the sequencer row. 

LENGTH ARROW BUTTONS

Set the last step in the sequence. The sequencer will return to step 1 if Loop mode is on, or stop if Loop mode is off. Set the last step with the arrow buttons. Range: 1 to 16 steps. 

STEP LEDs

The Step LEDs indicate the current step in the sequence.

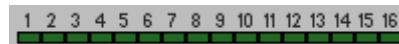

CONTROL SIGNAL ARROW BUTTONS/SLIDERS

This is the sequencer value-row. You set the control signal level of each step by moving the vertical slider or clicking the arrow buttons that appear below each slider when you move the cursor over it. Clicking within a slider background moves the slider immediately to this position. Note that when you click-hold to move the slider, the cursor becomes invisible. Range: +/- 64 units in bipolar mode and 0-64 units in unipolar mode (see the Uni button description below).



EVENT BUTTONS

This is the sequencer trigger-row. Click on the buttons to make the sequencer send a Trig/Gate signal each time it passes the step. Note that the two trigger-rows on the Event Sequencer work in parallel.



T/G BUTTON

Toggle between Trig and Gate mode with these buttons. In the Trig mode, every step transmits its own logic signal, which is an exact copy of the current Clk pulse OR'ed with the current state of the trigger-row chain input. In the Gate mode, the logic state of the step will be LOW or HIGH for the complete duration of the step. If both the current step and the next step are a logic HIGH the steps will be 'glued together' into one longer Gate signal that is actually as long as both steps.



RND BUTTON

Clicking this button initiates a random set of control signal values for each of the 16 steps. It can be put to good use to randomize a modulation pattern from a frontpanel button. But when used on a note pattern it doesn't necessarily create the proper musical pattern for your music every time you press this button.



CLR BUTTON

Pressing this button will reset all row sliders to their default position.



BIP/UNI BUTTON

Selects uni- or bipolar control signals of the output of the sequencer. Note that changing from Uni mode to Bip mode and back changes the actual values of the value-row sliders as the value-row slider positions are not changed.



SEQEVENT

This basic step sequencer features two parallel trigger-rows of 16 steps. It is ideal for sequencing drum and percussive sounds. Each step can send two separate logic pulses on the two separate outputs. Activate a step by clicking on one or more of the 32 available trigger buttons. See also "[Common Sequencer parameters](#)".

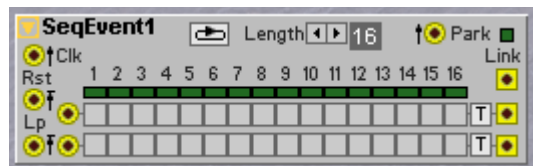

SEQVAL

This is a sequencer which sends one control signal value for each step. The value for each step is shown in the corresponding display box. In Unipolar mode (the Uni button depressed), the values are displayed in steps of 0.5 units. Every half-step (.5) is indicated by a dot to the right of the full step value. For example, the value 5.5 is displayed as '5.'. There is also a row of Step buttons for sending out a Trig/Gate signal for every step in the sequence. See also "[Common Sequencer parameters](#)".

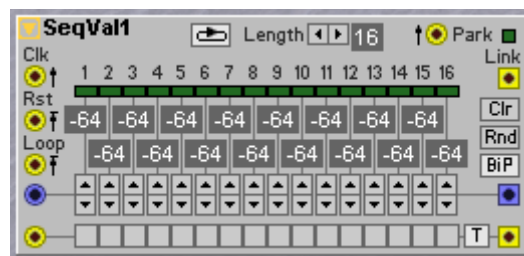

SEQLEV

This is a Level Sequencer which sends a control signal level for each step. It is ideal for sequencing modulation patterns. There is also a row of Step buttons for sending out a Trig/Gate signal for every step in the sequence. These buttons can also be used to flag extra accents in a pattern. See also "[Common Sequencer parameters](#)".

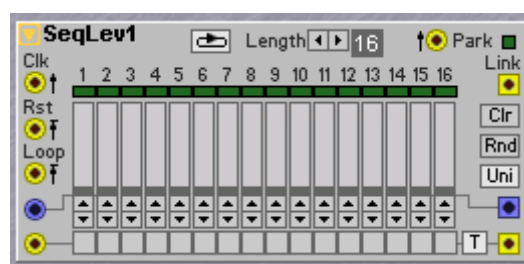

SEQNOTE

This is a Note Sequencer which sends a (bipolar) control signal value for each step. If you route this control signal to an unattenuated Pitch modulation input on an Oscillator module, the note value displayed in the hint box will correspond exactly to the output Oscillator Pitch. There is also a row of Step buttons for sending out a Trig/Gate signal for every step in the sequence.

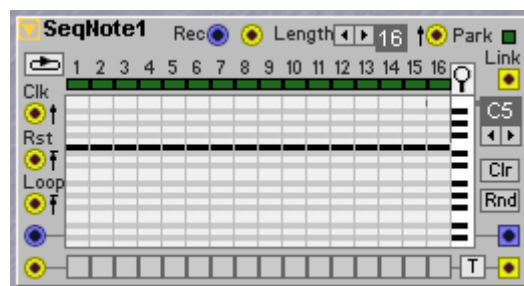

REC VALUE AND REC ENABLE INPUTS

This module has a nice feature that lets you record values 'on the fly'. To use this feature a control signal has to be connected to the blue Rec input. The yellow Rec Enable input next to the blue Rec input switches the module between sequencer mode and recording mode. When a steady logic HIGH level is applied to the Rec Enable input two things happen, the first thing you will hear is that the value-row output will stop outputting the value-row but switch to monitor the Rec input. The second thing is that while you hear the monitor signal the sequencer will sample the steps on the positive edges of the Clk signal. Meaning that the moment it advances to a new step it samples the Rec input and stores it in the step. New values are stored as long as the yellow Rec Enable input receives a logic HIGH and the Clk input receives clock pulses. The way values are stored is similar to how values are sampled by a S&H module, but with this module you won't hear the stored values until the Rec Enable input is brought to a logic LOW. Note that when the signal on the blue Rec input is a smooth signal like e.g.an Lfo triangle waveform the output signal will also be smooth when in Rec mode, as the value quantization will only happen while the Rec input value is actually stored and not be available before when the Rec signal is sent to the output to be monitored. When comparing with a S&H it is like the input of the S&H is monitored and not its output.

PIANO ROLL WINDOW AND MARKERS

Each step in the sequence is displayed as a row of keyboard keys, with the grey lines representing the black keys and the white fields representing the white keys. You set the control signal level (note number)

of each step by clicking on the desired “key” in the window. Where in the total keyboard range the notes are placed is determined with the Magnifier and Octave selector described below. If note values should be outside the currently visible keyboard range, these will be indicated by triangular arrows in the window.

MAGNIFIER

Click on the Magnifier to select the visible keyboard range in the Note Sequencer between 1, 2 and 3 octaves. Note that if you click the Rnd button to randomly distribute note values, the notes will be distributed only within the range selected with the Magnifier control.

OCTAVE SELECTOR

Click the Octave selector to select the highest note in the Piano roll window. Range: C0-C7. See also ["Common Sequencer parameters"](#).

SEQCTR

The Control Sequencer is special in the way that instead of controlling the step advancement by incoming clock pulses, the step position is controlled by an incoming control signal value. This makes it possible to control the current step, step advancement, and directions by means of a modulation signal. The shape of this modulation signal defines how you step through the sequence. This gives you total freedom on how you play your patterns.

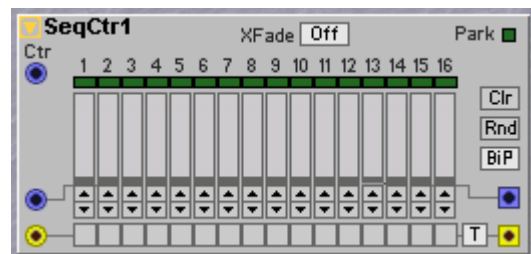

Row chain inputs work as on the other sequencer modules. There is an additional row of Step buttons for sending out a Trig/Gate signal for every step in the sequence.

Tip! Basically this module is a lookup table with the Ctr signal serving as an index or address in the table. When the Voice Nr. output of the Status module is patched to the Ctr input, slider1 will control a value for voice1, slider2 for voice2 etc. This way you can have separate control values for each voice.

Note that when connecting an Lfo waveform the waveform must be set to unipolar.

CTR INPUT

The **DYNAMIC CONTROL/AUDIO** signal input for controlling the step numbers. The steps respond to the following input signal values: Step 1: 0 to <4, Step 2: 4 to <8, Step 3: 8 to <12, Step 4: 12 to <16, Step 5: 16 to <20, Step 6: 20 to <24, Step 7: 24 to <28, Step 8: 28 to <32, Step 9: 32 to <36, Step 10: 36 to <40, Step 11: 40 to <44, Step 12: 44 to <48, Step 13: 48 to <52, Step 14: 52 to <56, Step 15: 56 to <60 and Step 16: 60 to 64.

XFADE SCROLL BUTTON

Another special feature of the Volt Sequencer module is the ability to crossfade in a linear fashion between values of adjacent steps. Click the XFade scroll button to select degree of crossfade. Values: Off, 25%, 50% and 100%. See also ["Common Sequencer parameters"](#).

SEQUENCING EXAMPLES

GENERAL INFORMATION

- Always use the Clock Generator set to Master mode to clock the sequencer modules if you sequence note patterns and use the Active output on the Clock generator to reset the sequencers. This will make it much easier to have other slots and other MIDI gear play synchronized in the same tempo. Use the

Master Clock Tempo knob and Run/Stop buttons on the G2 front panel to set tempo and start and stop your songs.

- Use the trigger-rows on the sequencers to trigger envelopes, it will give you easy control to define which notes in the pattern get triggered.
- Note that the KBT track button on the oscillators also have influence on which notes are played by the sequencers. If the KBT button is On the keyboard will transpose the pattern with the E4 key as the reference. If the KFT button is Off the patterns will not be transposed and it is easier to play along with the pattern on the keyboard.
- Experiment with different sequencers running in parallel and use the ClkDivFix module on the 1/96 output of the Clock Generator to generate a triplet clock signal to clock a parallel sequencer. Experiment with the Swing setting on the Clock Generator. Experiment with two parallel sequencers where one sequencer resets the other sequencer from its trigger-row button at irregular intervals.
- Use the Sync output of the Clock generator to reset sequencers and Lfo's at the end of two or four bars.
- When using the Rec function of the Note Sequencer module always give the module a reset pulse on the Rst input first. This is to make sure that the first recorded note will indeed record at the first location in the row, as after a Rst pulse the first clock pulse will always force the sequencer to its first step.
- Experiment with polyphony. Experiment with a sequencer connected to a MIDI NOTE OUT module with the current Slot as destination. Then, turn the Slot Arpeggiator on. The Arpeggiator will now receive its notes from the sequencer module.
- Experiment, experiment, experiment...

PARALLEL CONNECTION

Connect the sequencer modules to the same clock source. If you want to make sure that the sequencers are aligned to each other, connect the Clock Generator Active output signal to the sequencers' Rst inputs which will reset both sequencers when the clock is started.

Both Sequencers in this example have the Loop mode turned on, as they need to keep cycling until the clock is stopped.

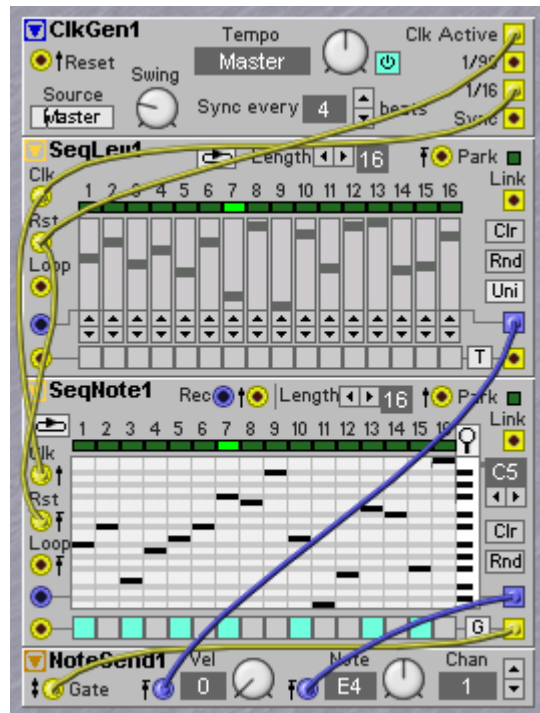

SERIAL CONNECTION 1

This schematic shows how a cascade of serially connected sequencers should be set up to give sequences of longer lengths. All sequencers should be set to 1-Cycle mode. On Patch Load, or after a Rst signal from e.g. the Clock Generator Active output, the first sequencer should be activated and the others should be disabled. Activation of the first sequencer must be done with its Rst input and disabling of all other sequencers with the Park inputs. But the last sequencer should be able to activate the first sequencer to start the next cycle. You see an extra input on the first sequencer is needed for the last sequencer to restart the first one. This input is the Loop input. Note that the Loop input is specially designed for this one particular purpose.

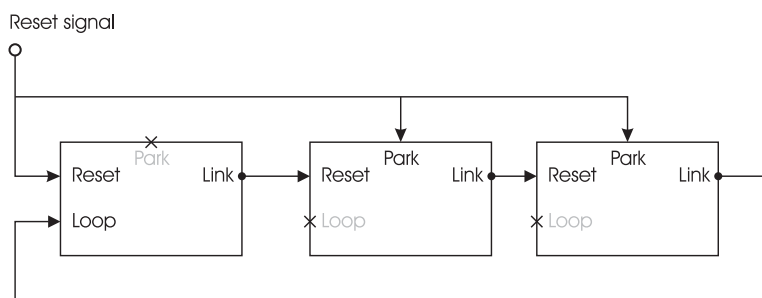

(In practice the Loop input behaves much like the Rst input, the difference is in how the Loop and Rst inputs are set up at Patch Load or after an optimization of the DSPs after inserting a new module. Note that a cascade of sequencers *must* be set up like in the schematic to work properly. When using only one sequencer in Loop mode the Loop input can be used like an extra Rst input.)

All sequencer modules use the same clock, use the Clock Generator module and use the Clk Active signal as the reset signal, so the pattern will restart at the beginning when the clock is set to run.

The sequencer rows must be chained with the row outputs connected to the next sequencer row chain inputs.

A patch can look like this:

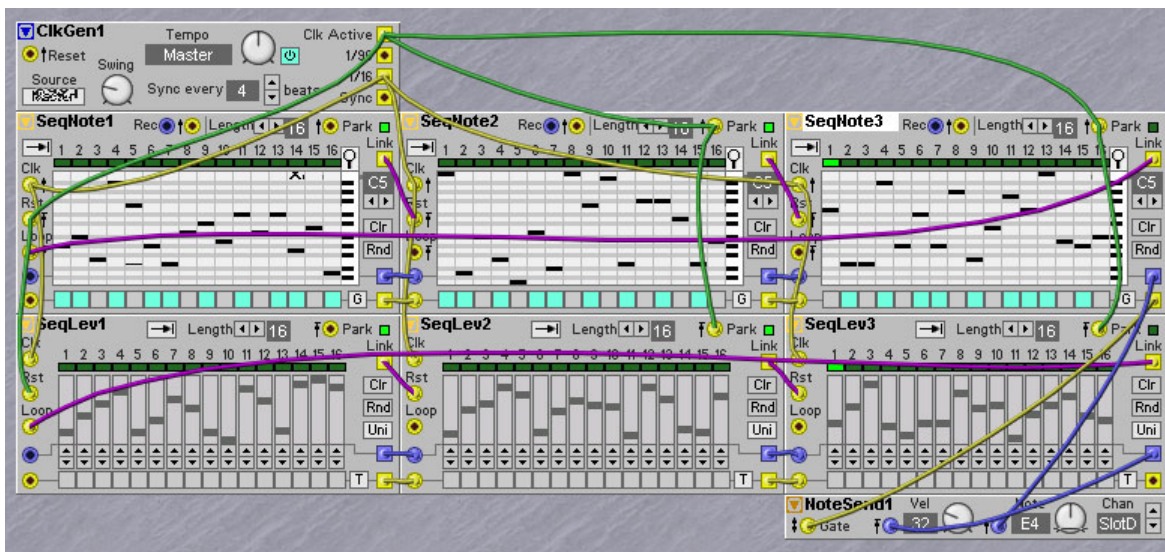

STEP RECORDING OF NOTES FROM THE KEYBOARD (OR MIDI IN)

The next patch shows how you can play in the sequence key by key from the G2 keyboard.

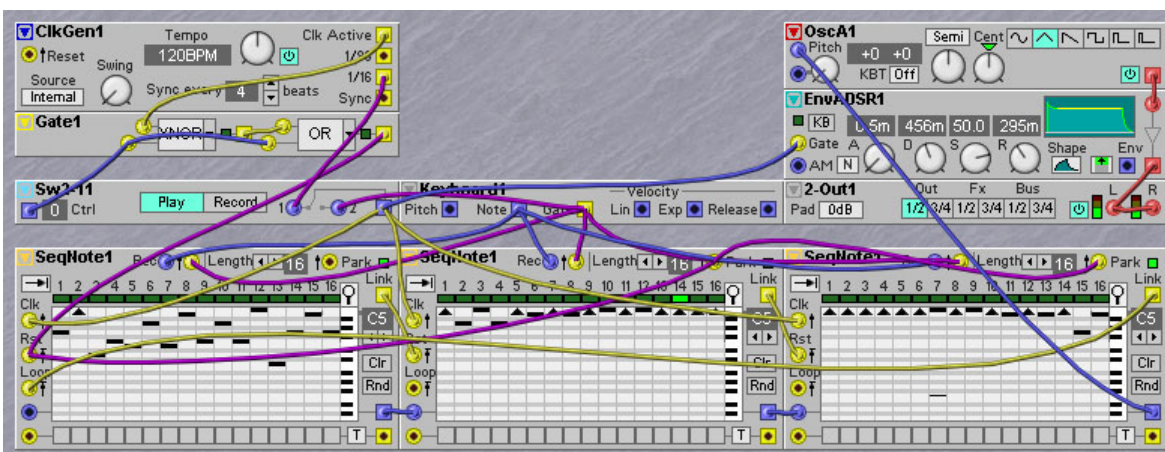

A two-pole Switch module is used to switch between ‘play’ mode and ‘step record’ mode. The basic patch is similar to the previous one, with the Link, Rst and Loop connectors connected in the standard way. By switching the clock between the Keyboard Gate and the Clock Generator and connecting the Keyboard Gate to the yellow Rec Enable inputs, the patch can be switched easily between play and record mode. But the little catch is that recording should in this example patch always start at the first step of the first sequencer and when the patch is switched to play mode it should also start at the first step (well, that is how the patcher wanted it to be). And this start behaviour no matter if the clock is running or not. This means that the reset signal must be set up in a way that this works. The trick used is to make use of the Ctrl output of the switch module and combine this signal with the Clk Active signal. Two logic functions are used, a XNOR and an OR function. We won’t explain in detail here why this works, for now just trust that it works.

The recorded sequence is normally started and stopped by the Master Clock Run/Stop button on the G2 front panel or by MIDI START/STOP commands. But if the clock keeps running while recording notes and the patch is switched back to play mode the pattern will start immediately at the beginning.

FX GROUP

The FX modules are useful tools for changing and transforming audio signals. Among the FX modules you'll find effect modules like the Reverb, Flanger, Phaser etc. Feel free to experiment with these on control signals as well.

COMMON FX GROUP PARAMETERS

INPUT

The **AUDIO** or **DYNAMIC CONTROL/AUDIO** signal input of the FX module. 

ON/BYPASS

Click the On/Bypass button to bypass the input signal from the effect. Blue button color indicates 'On' and gray 'Bypass'. 

OUTPUT

The output from the FX module. Signal: **BIPOLAR** 

STCHORUS

The Stereo Chorus module simulates the effect of multiple detuned stereo voices. It has one Audio signal input and stereo outputs.



DETUNE

Sets the detune depth of the chorus effect.

AMOUNT

Adjusts the balance between the dry signal and the wet "chorused" signal. See also ["Common FX group parameters"](#).

PHASER

The Phaser is based on the Nord Electro phaser effects and simulates a vintage type of phaser. The phaser effect has a very characteristic "sweep" effect.

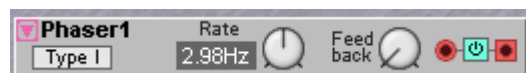

TYPE

Click to select Type I or Type II. The Type I phaser has three notches and Type II has two.

RATE

With the Rate knob you set the rate of the built-in LFO. Range: 62.9 s/cycle to 24.4 Hz.

FEEDBACK

With the Feedback knob you set the phaser feedback, i.e the "depth" of the notches. See also ["Common FX group parameters"](#).

FLANGER

The Flanger is based on the Nord Electro flanger effect and simulates a vintage type of flanger. The flanger effect is a very characteristic type of “sweep” effect. It’s quite similar to the phaser effect but has a little different characteristics.

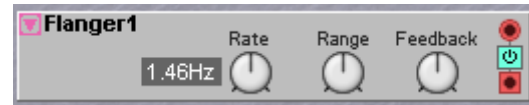

RATE

Set the flanger sweep rate. Range: 62.9 s/cycle to 24.4 Hz.

RANGE

Set the frequency range in which the flanger should operate. Range:

FEEDBACK

Set the signal feedback and thus increase the flanger effect depth. See also ["Common FX group parameters"](#).

DIGITIZER

The Digitizer module continuously samples an incoming signal at a selectable sample rate and bit resolution. The module can e.g. sample a clean audio signal and transform it down to a dirty 8 bit, 5 kHz signal. Great for “low-fi” effects with lots of aliasing.

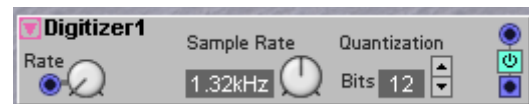

SAMPLE RATE

Set desired sample rate in Hz with the knob to the right of the display box. Range: 32.70 Hz to 50.2 kHz. You can modulate the sample rate from a modulation source patched to the control signal input to the left of the display box. Attenuate the modulation signal with the knob to the left of the display box [ATTENUATOR TYPE III].

QUANTIZATION (BITS)

Select the bit resolution with the arrow buttons. Range: 1 to 12 bits and Off. ‘Off’ means full resolution, i.e. 24 bits. The resolution is shown in the display box. See also ["Common FX group parameters"](#).

FREQSHIFT

The Frequency Shifter detunes all sinewave partials in an audio signal by the number of Hertz set by the Shift control. The module is modelled after a design by Harald Bode which was produced by Moog in the early sixties of the last century. The sonic effect is very similar to the effect of a ringmodulator, in fact internally the Frequency Shifter uses ringmodulators to create the effect. Technically speaking the module creates two separate sidebands around every sinewave partial in the audio input signal. E.g., if the input signal is a note at 220 Hz with the second and third harmonic present there are three partials in this input signal, one at 220 Hz, one at 440 Hz and one at 660 Hz. If the Shift setting is set to 43 Hz the three partials would change to 177 Hz, 397 Hz and 617 Hz on the Down output. and 263 Hz, 483 Hz, and 703 Hz on the Up output. These new frequency relations are not harmonic anymore and will cause the signals on the Up and Down outputs to sound inharmonic.

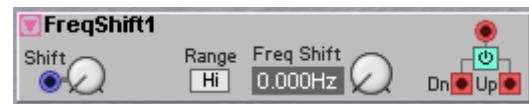

SHIFT

Set the amount of frequency shifting on the output signals with the Shift knob. A low Shift amount will produce a tremolo effect on the Mix output, whereas high Shift amounts will generate inharmonic signals. The Shift amount can be controlled from an external source via the control signal input. The modulation amount can also be attenuated [ATTENUATOR TYPE I].

HI/LO/SUB SCROLL BUTTONS

Select range for the frequency shifting of the input signal copy.

UP OUTPUT

The output of the upper frequency shifted sideband. Signal: **BIPOLAR**

DOWN OUTPUT

The output of the lower frequency shifted sideband. Signal: **BIPOLAR**

See also ["Common FX group parameters"](#).

EXAMPLE USING THE FREQUENCY SHIFTER

A traditional mono-to-stereo effect is to use an additional stereo mixer to mix the input signal with the Up output signal on e.g. the left speaker channel and mix the input signal with the Down output signal on the right speaker channel. Setting Shift to a very low pitch of e.g. 0.05 Hz will produce a lazy stereo panning effect with some phasing in the sound, while at a setting between 0.5 Hz and 6 Hz it will produce a lively stereo tremolo-type effect. Both the Up and the Down signal will produce a beating effect when mixed with the input signal. This beating will pan symmetrically between left and right while producing some slight phasing which is a bit similar to the beating caused by the rotor in a Leslie box. Mixing 25% to 50% of the Up and Down outputs signals to the input signal is enough to give a subtle beating. Additional mild saturation and some reverb can be used to give extra depth to the effect.

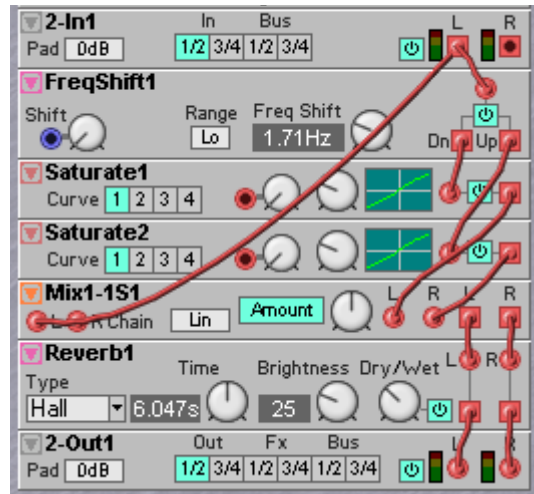
**PSHIFT**

The pitch shifter module can lower or raise the pitch of a signal. In contrast to the FreqShift module the pitch shifter effect keeps the harmonic relations in the input audio signal unaltered. It can be used as a harmonizer effect on chords and external audio signals without making the output signal enharmonic. When a signal is just slightly detuned by a few cents and then mixed together with the clean input signal in a two-channel mixer module, a chorusing effect will result. When more extreme detune values are used the character of the sound will drastically change. By adding a mixer in front of the PShift module and feeding the output signal back to the input there will be a build up of the detuned signals, resulting in what is named the barber pole effect. Feedback on very low and very high frequencies can be prevented by inserting an extra highpass filter set to a low cutoff and a lowpass filter set to a high cutoff.

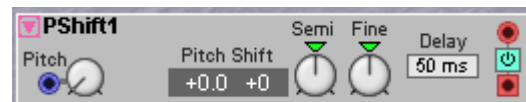

SEMI

Semi will set the detune in steps of 25 cents.

FINE

Fine will set the detune in very fine increments.

DELAY

Pitch shifters exhibit a wobbling effect, which depends on the length of the delay line used to create the effect. A longer delay time slows down the wobbling speed but also causes a slight echoing effect on percussive sounds. The wobbling speed increases when the detune is raised, so for extreme detunes the Delay value must in general be set to a longer time. Experiment with the Delay and Semi settings with different sorts of audio material, like drums, chords, vocals, etc., to get a feel which settings work best on specific audio material.

SCRATCH

The scratch module is a special pitch shifter that creates the effect of shuttling an audiotape backwards and forwards or scratching a vinyl record.

**PITCH RATIO**

When this knob is in the middle position the output will be silent. Turning this knob a bit clockwise will create an effect that sounds like the audio signal on the input is played at a slow speed, opening the knob more will 'speed up' the audio signal. Turning the knob counter clockwise will 'reverse' the audio. Total amount of detune can be two octaves in either the forward or reverse direction. The effect works best when the Pitch Ratio knob is constantly turned backwards and forwards. Scratching can be done by means of a control signal, e.g. connecting an LFO signal to the blue modulation input will create an 'auto scratch' effect. By syncing the LFO to the Midiclock the scratching effect will be right on the beat. Use an LfoB or LfoShpA set to Clk mode for this purpose. Note that the module never loses tempo like the slowing down of a turntable would.

DELAY

As the Scratch module is in essence a pitch shifter effect there will be some wobbling in the sound. The Delay setting influences the amount of wobbling. Set the Delay to a value that sounds best with the audio material that gets shuttled.

Note that this module is not a time-machine that could really make your audio be played in reverse or be warped into the future. Instead, the module creates the *illusion* of forward and backward shuttling. The module continuously inserts audio from the red input into an internal audio buffer that is as long as the Delay setting. Then it makes the scratching effect on the audio material that is currently in this buffer.

REVERB

The Reverb module is a stereo reverb with selectable reverb type, time and brightness. The module also features a Dry/Reverb mix control.

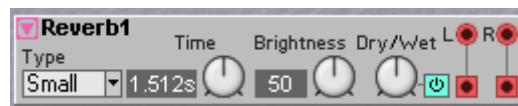
**TIME**

Set the reverb time. The time is shown in the display box. Range: 1.1 ms to 17.58 s.

BRIGHTNESS

Set the high frequency content of the reverberated signal with the knob. Basically this setting simulates distance, softness of the walls, atmospheric damping, etc., depending on the other reverb settings. The most natural range is between 25 and 50.

DRY/WET

Set the mix of dry and reverberated signal to be sent to the stereo outputs. See also "[Common FX group parameters](#)".

TYPE

Select reverb type between Small, Medium, Large and Hall with the drop-down selector.

Note that changing reverb type will force the Sound Engine to recalculate and thus cause a brief moment of silence.

COMPRESS

The stereo Compressor module compresses an input signal by amplifying weak signals attenuating strong signals and thus reducing the dynamic range. The practical result of a compressed signal is that the volume is more even over time. A compressor can be very useful on a drum mix or basses to make the sound sit "right in your face". It can also be very useful on a final mix to add more presence and "punch" to the mix.

**SIDE CHAIN**

The Side Chain input is used for an external audio signal to control the compressor. The Side Chain signal will not be mixed with the other input signals, it will just be used to control the compressor. Activate the Side Chain function by pressing the Side Chain button.

THRESH

With the Thresh knob you set the threshold above which compression is activated, i.e the minimum input value to activate the compression. Range: -30 to 11 dB and Off.

RATIO

With the Ratio knob you set the compression ratio above the set Threshold level. 1.0:1 means no compression and 80:1 maximum compression. Range: 1.0:1 to 80:1.

ATTACK

With the Attack knob you set the response time of the compressor, i.e the time between input signal above the Threshold level and compressor activation. Range: Fast (0.5 ms) to 767 ms.

RELEASE

With the Release rotary knob you set the release time, i.e the time it takes for the compressor to return to the original input level. Range: 125 ms to 10.2 s.

REF LVL

With the Ref Level knob you set the level to compress the stereo signals towards. Range: -30 to +12 dB.

GAIN REDUCTION LEDs

This LED indicator shows the gain reduction of the sum of the left and right channels in dB. See also "[Common FX group parameters](#)".

DELAY GROUP

The Delay module group features a variety of audio delay modules, from basic static delay lines to modulatable stereo delays with feedback and filter controls. The delay modules are designed for use with audio signals but of course you can use them for other types of signals as well.

COMMON DELAY GROUP PARAMETERS

RANGE DROP-DOWN SELECTOR

To optimize the total use of RAM memory in the synth, there is a Range drop-down selector with which you can choose the maximum delay Time for your application. The ranges are: 5 ms, 25 ms, 100 ms, 500 ms, 1.0 s, 2.0 s and 2.7 s. For example, if you only plan to use a maximum delay Time of 0.4 seconds, select the 500 ms Range. Note that changing Range will force the Sound Engine to recalculate and thus cause a brief moment of silence.



TIME KNOB WITH DISPLAY BOX

Set the delay Time (or Master Clock Sync factor/divisor) with this knob. The Time/Sync factor/divisor is shown in the corresponding Display Box.



DELAY TIME MODULATION

In some modules, the delay time can be modulated from an external source. The modulation amount can also be attenuated with the corresponding knob of [ATTENUATOR TYPE I]. Note that modulating the time of a delayed audio signal will also affect the pitch. This can generate quite interesting effects.



If you want to modulate the delay time from the minimum value (0.01 ms) to the maximum value (depending on the Range setting described above) with a positive envelope (that produces a positive unipolar control signal with a peak to peak level swing from 0 units to +64 units), set the initial delay time to 0.01 ms and the mod-amount to 100.

If you want to modulate the delay time from the minimum value (0.01 ms) to the maximum value (depending on the Range setting described above) with an LFO (that produces a bipolar control signal with a peak to peak level swing from -64 units to +64 units), set the initial delay time to 50% of maximum Range and the mod-amount to 50. Increasing the setting of the mod-amount will force the delay time to stay at minimum and maximum delay times for as long as it takes for the modulation signal to get within the delay time range again.

TIME/CLK SCROLL BUTTON

Click this scroll button to change between Time and Clk (Master Clock sync). The Time Display Box(es) will change according to what you select. The Clk sync mode automatically locks on to the synth's Master Clock and here you set the intervals between $1/64T$ and $2/1$. The 'T' (triplet) indicates that the note value is $1/1.5$ times the original note value and the 'D' (dotted) indicates that the note value is 1.5 times the original note value.



Note that the Clk sync mode is only available in the DelayQuad, DelayA, DelayB and DlyStereo modules. Also note that if the delay time (based on the current Master Clock rate and the Sync factor) should exceed the selected 'Range' time (see above), the actual delay time will automatically be divided by two.

INPUT(S)

The AUDIO or DYNAMIC CONTROL/AUDIO signal input(s) of the Delay module.



B

Click the On/Bypass button to bypass the input signal from the effect. Blue button color indicates 'On' and gray 'Bypass'.



OUTPUT(S)

The output(s) from the FX module. Signal: **BIPOLAR**



DLYSINGLEA

A static single delay with selectable time control. See also "Common Delay group parameters".



DLYSINGLEB

A single delay with selectable time control. The delay time can also be modulated from an external source. See also "Common Delay group parameters".



DELAYDUAL

A 2-tap delay with selectable time controls for each tap. The individual delay times can also be modulated from external sources. See also "Common Delay group parameters".



DELAYQUAD

A 4-tap delay with selectable time controls for each tap. The individual delay times can also be modulated from external sources. There is also an additional fifth output with a fixed delay time at the currently selected Range. See also "Common Delay group parameters".



DLYEIGHT

An 8-tap delay with selectable time control between the taps. Note that the 8 taps are "in sequence", i.e. between the input signal and the first tap, the delay corresponds to the displayed time. Then, it takes twice this time for the second tap to output the signal and three times the set delay time for the third tap to output the signal, and so on. In this module, the displayed Range setting refers to the total time between the input signal and the last tap (output 8) and with the Time knob you set the delay time between adjacent taps. See also "Common Delay group parameters".



DLYSHIFTREG

The Delay Shift Register basically works like a Sample & Hold module, with the difference that for every new sample, it shifts the previous sample one step to the right among the eight outputs. This can be useful for "storing" keyboard Note data, for example. See also "Common Delay group parameters".



DLYCLOCK

The Clocked Delay Register basically works like the Delay Shift Register above but with only one output. With the Sample Delay knob you set how many Clock pulses is required to output the sampled value. For example, if you have set the Sample Delay to 72, the value will be output 72 Clock pulses later. See also "[Common Delay group parameters](#)".

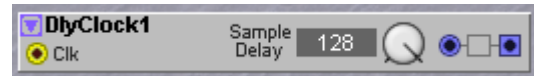

DELAYA

This is a single channel audio delay with Feedback and Filter controls. You can also set the mix between delayed signal and input signal with the Dry/Wet knob. See also "[Common Delay group parameters](#)".



DELAYB

This is a single channel audio delay with Feedback and Filter controls. You can also set the mix between delayed signal and input signal with the Dry/Wet knob. The delay Time, Feedback amount and Dry/Wet mix can also be modulated from external sources. See also "[Common Delay group parameters](#)".



DLYSTEREO

This is a stereo audio delay with separate Time controls for Left and Right outputs, Feedback, X-Feedback (cross feedback between the two stereo channels) and Filter controls. You can also set the mix between delayed signal and input signal with the Dry/Wet knob. See also "[Common Delay group parameters](#)".



MIDI GROUP

The MIDI module group contains modules for sending and receiving various types of MIDI data, both internally between Patches in the four Slots and to and from external MIDI equipment. This makes it possible, for example, to automatically control external synths from the G2 sequencer modules. The modules can use the public “external” MIDI channels ‘1-16’ (for use mainly with external MIDI gear), the four internal MIDI channels ‘Slot A-D’ and also ‘This’ which is a short-cut to the Slot’s current MIDI channel. This gives you great flexibility of “synching up” functions in Patches in different Slots to each other and also for interacting with external MIDI equipment.

COMMON MIDI MODULE PARAMETERS

CHAN(NEL) SELECTOR AND DISPLAY BOX

Click the arrow buttons to select MIDI Channel. The selected channel is displayed in the display box. MIDI Receive alternatives: Channel 1-16, This (a “short-cut” to the Slot’s current MIDI channel), Keyboard. MIDI Send alternatives: Channel 1-16, This (a “short-cut” to the Slot’s current MIDI channel), Slot A-D



CTRL SELECTOR

Click the arrow buttons to select MIDI Controller#. The selected CC# is displayed in the display box.



CTRLSEND

The MIDI Controller Send module can be used to send out MIDI Controller values on a specific MIDI Controller# on a selected MIDI channel.



SEND INPUT AND OUTPUT

A signal which goes from 0 units or below to anything above 0 units on the yellow input will force the module to send out the current offset Value on the selected MIDI CC# and MIDI channel. Right after the reception of the trig signal, the yellow output will transmit a logic pulse. This pulse can be used for triggering a transmission of a MIDI Program Change message from the PCSend module described below. Use the CtrlSend module to transmit a Bank Select message and then automatically force a PCSend module to transmit a MIDI Program Change message.

VALUE

Manually select the Value you want the module to send with the knob. By patching a positive unipolar control signal to the Value control signal input, you can control the Value from an external source. Range: 0-127 units in steps of 1 unit. See also "[Common MIDI module parameters](#)".

- Note that if you want to send only the values on the Value input, set the knob to ‘0’. Otherwise the value selected with the knob will be added as an offset to the input signal.
- Note that as soon as the Value changes, either by manually turning the knob or by inputting a changing control signal, the module will output MIDI data even if the logic Send input is not activated.

APPLICATION EXAMPLES

The CtrlSend module can be used in different types of applications. Here are some basic examples:

FOR ASSIGNING AND SENDING A MIDI CC# FROM A KNOB ON THE SYNTH PANEL

Just drag and drop a CtrlSend module to the Patch window, select MIDI Ctrl number, MIDI Channel and then assign the Value knob to an **ASSIGNABLE KNOB** on the synth panel. Turning the **KNOB** will then send MIDI CC data to the **MIDI OUT** of the synth. A very simple solution to be able to control external MIDI gear from the G2 panel. Tip! To make it easier to see in the **ASSIGNABLE DISPLAY** which parameter you control, you can rename the module from ‘CtrlSend1’ to e.g. ‘FilterCutoff’. Then, the **ASSIGNABLE DISPLAY** will show ‘FilterCutoff’.



SENDING A SERIES OF DIFFERENT MIDI CONTROLLERS TO EXTERNAL MIDI GEAR

Connect several CtrlSend modules in series where each module sends a certain value on a certain MIDI CC# on selectable MIDI channels. In this example, the first module sends the value 64 for MIDI CC#7 on MIDI channel 1. Right after this, the second module sends the value 127 for MIDI CC#11 on MIDI channel 1. Finally, the third module sends the value 50 for MIDI CC#21 on MIDI channel 3. This application is perfect for sending initial MIDI information to external MIDI equipment in a predefined order.

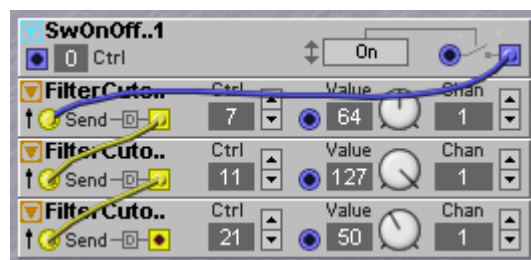

FOR SENDING CONTINUOUS MIDI CONTROLLER DATA TO PATCHES IN OTHER SLOTS AND/OR TO EXTERNAL MIDI GEAR

Patch, for example, the Control signal output of a CtrlSeq module and let it modulate the filter cutoff frequency on a MIDI connected Nord Lead 3. Select the correct MIDI CC# and correct MIDI channel and make sure the Value knob is set to ‘0’. As the CtrlSeq runs, it will continuously send different Control signal values to the CtrlSend module, which in turn will output the MIDI CC data on the MIDI Out. In these type of applications you don’t have to use the logic Send input of the CtrlSend module since the Value changes continuously.

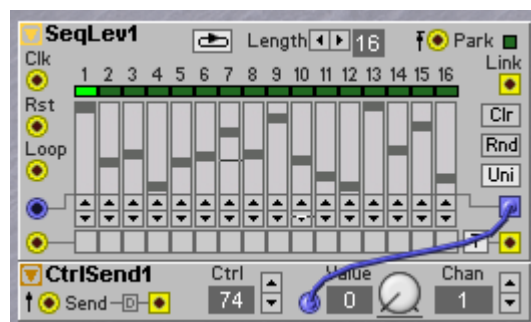

PCSEND

The PCSend module is used for sending out MIDI Program Change messages on a selected MIDI channel.

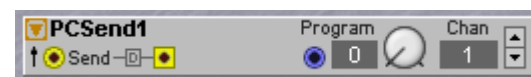

SEND INPUT AND OUTPUT

A signal which goes from 0 units or below to anything above 0 units on the yellow input will force the module to send out the current Program number on the selected MIDI channel. Right after the reception of the trig signal, the yellow output will transmit a logic pulse. This pulse can be used for triggering a transmission of a MIDI Program Change message from another PCSend module, for example.

PROGRAM

Manually select the Program number you want the module to send with the knob. By patching a positive unipolar control signal to the Program control signal input, you can control the Program number from an external source. Range: 0-127 in steps of 1. See also "[Common MIDI module parameters](#)".

Note that if you want to send only the Program value on the Program input, set the knob to '0'. Otherwise the Program number selected with the knob will be added as an offset to the input signal.

Note that as soon as the Program number changes, either by manually turning the knob or by inputting a changing control signal, the module will output MIDI data even if the logic Send input is not activated.

APPLICATION EXAMPLE

The PCSend module is perfect in combination with the CtrlSend module for sending combined MIDI Bank Select and Program Change messages:

Use the CtrlSend module to first transmit a Bank Select message (MIDI CC#32) and then automatically force the PCSend module to transmit a MIDI Program Change message. By serial connecting the modules you make sure the Bank Select message is sent prior to the Program Change message. The message order is important for external synths to respond correctly. Of course, you can expand this serial connection by adding more CtrlSend and PCSend modules.

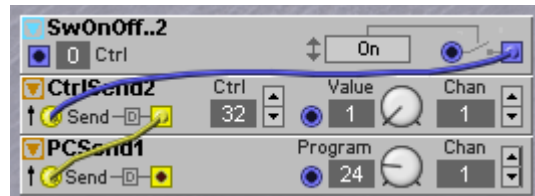

NOTESEND

The NoteSend module is used for sending out MIDI Note On and Off messages on a selected MIDI channel. The module can also send out Velocity values.



GATE INPUT

A signal which goes from 0 units or below to anything above 0 units on the yellow Gate input will force the module to send out the current Velocity and Note values on the selected MIDI channel. When the Gate signal goes back to 0 units or below, the module sends a MIDI Note Off message on the selected MIDI channel.

VEL

Manually select the Velocity value you want the module to send with the knob. By patching a positive unipolar control signal to the Vel control signal input, you can control the Velocity from an external source. Range: 0-127 units in steps of 1 unit. See also "[Common MIDI module parameters](#)".

Note that if you want to send only the Velocity values on the Vel input, set the knob to '0'. Otherwise the value selected with the knob will be added as an offset to the input signal.

Note that the Velocity value is not sent out until a high logic signal is present on the Gate input.

NOTE

Manually select the MIDI Note number you want the module to send with the knob. By patching a positive unipolar control signal to the Note control signal input, you can control the Note number from an external source. Range: C-1 to G9 in steps of 1 semitone.

Note! Always set the knob to 'E4' if you're inputting regular bipolar Note data, e.g. from the Note Sequencer module, otherwise the transmitted MIDI notes will be transposed.

Note that the Note number is not sent out until a high logic signal is present on the Gate input.

APPLICATION EXAMPLE

The NoteSend module in combination with the NoteSeq module makes it possible to automatically send out the sequencer's note data to a Patch in another Slot or to external MIDI equipment. Connect the NoteSeq Control signal output to the NoteSend Note input and the NoteSeq Trig signal output to the NoteSend Gate input. If you need longer Gate input pulses on the NoteSend module, use a logic Pulse module between the NoteSeq and NoteSend modules to increase the periods. Set desired Velocity level with the knob and set the Note number to 'E4'. Select MIDI channel on the NoteSend module and you're set.

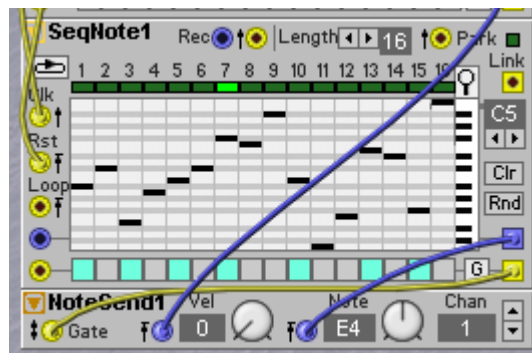

CTRLRCV

The MIDI Controller Receive module can be used to control things in the Patch based on incoming external MIDI Controller data.



RCV OUTPUT

Every time a new MIDI CC value is received on the selected CC# and MIDI channel, a high logic pulse is output from the Rcv output. This signal can be used to trig different events in the Patch, for example from external button parameters.

VAL OUTPUT

The Val output transmits the MIDI CC values received on the selected CC# and MIDI channel. See also "[Common MIDI module parameters](#)".

NOTERCV

The MIDI Note Receive module works like sort of a MIDI Note detector and can be used for controlling things in the Patch when receiving a specific incoming MIDI Note number. These modules are perfect when you want to control parts of the Patch from different MIDI channels.

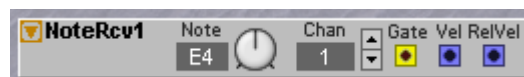

NOTE KNOB

Set the MIDI Note number to respond to. All other received MIDI Note numbers are disregarded.

GATE OUTPUT

Every time a MIDI Note On message is received on the selected Note number and MIDI channel, the Gate output transmits a high logic signal. When a MIDI Note Off message is received on the selected Note number and MIDI channel, the Gate output transmits a low logic signal.

VEL OUTPUT

The Vel output transmits the MIDI Velocity values received on the selected Note number and MIDI channel. See also "[Common MIDI module parameters](#)".

NOTEZONE

The Note Zone module can be used for receiving MIDI Note data within a selected note range on a selected MIDI channel and then transmit the notes on a different MIDI channel, transposed or non-transposed. A

number of NoteZone modules can be used for creating very flexible master keyboard functionality, both from the G2's internal keyboard and from external MIDI master keyboards.



RCV CHAN

Select the MIDI channel to receive MIDI Note data, Velocity and Keyboard Gate data from.

NOTE MIN & MAX

Set the incoming MIDI Note range with the Min and Max arrow buttons. Only the notes within the set range will be recognized.

LET THRU

Here you can select what MIDI data to recognize: 'Notes Only' will recognize MIDI Note data but disregard any incoming MIDI Controller data. 'Notes+Ctrls' will recognize both incoming MIDI Note data and MIDI Controller data.

SEND TRANS

Set any Note Transposition for the transmitted Note zone with the 'Trans' arrow buttons.

SEND CHAN

Select which MIDI channel to send the notes (and Controllers). See also "[Common MIDI module parameters](#)".

APPLICATION EXAMPLE

Let's say we want to create a "master keyboard" setup consisting of four key zones on the internal keyboard, with each zone sending on a separate MIDI channel. Simply drag and drop four NoteZone modules to the Patch window. Set the Rcv Channel to 'Keyb' on each of the four modules to route the internal keyboard to the modules. Then, set desired Note range for each of the modules (the Note zones can overlap each other if you like). Finally, set the MIDI channels you want the different Note zones to transmit on. If you want to transpose any of the Note zones, change the Trans value on each of the modules. In this example, NoteZone3 sends out notes transposed by +7 semitones.

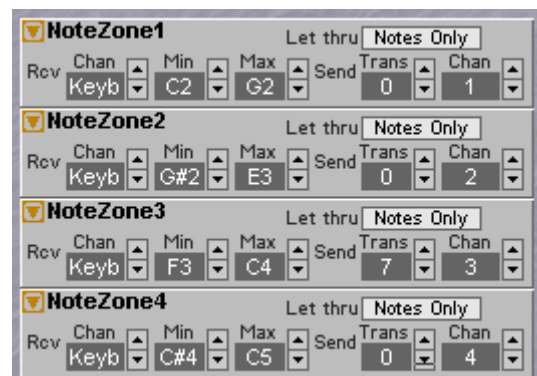

AUTOMATE

The MIDI automation module can be used to send out MIDI Controller values on a specific MIDI CC# on a selected MIDI channel. The module appears very similar

to the CtrlSend module. But there is one essential difference as the Automate module will also automatically monitor the MIDI IN connector for the reception of the CC# in the set channel and adjust itself accordingly. This is essential to provide for what is named MIDI talkback. With MIDI talkback two



MIDI devices send each other information about what changes are made on each one of them, so the other device keeps in sync. This way the G2 can keep track on what knobs are moved on the other device. Note that if the G2 patch is saved, it now also saves the last knob positions on the other device, as the Automate module had picked them up when changes were made on the other device. When the G2 patch is recalled it will send those knob positions back to the other device, recalling its sound to what it was when you stored the G2 patch. This way a preset of another device can be stored in a patch on the G2. In fact, with careful use of the Patch variations eight presets of the other machine can be stored in one G2 patch and later recalled by selecting another variation on the G2.

MIDI automation and MIDI talkback are no easy subjects. You are strongly advised on carefully reading the MIDI automation section in this manual on how this module can be used in practice to control other MIDI instruments or MIDI computer programs.

See also "[Common MIDI module parameters](#)", "[Synthesis basics](#)" on page 264 and "[MIDI Talkback function](#)" on page 147.

ECHO

The Echo control will enable or disable the retransmission of received MIDI CC# values. Under normal conditions Echo is Off to prevent the G2 and the other instrument to endlessly send each other the same information in an endless loop. The Echo setting simply breaks a possible endless loop. Echo On/Off also depends on whether the other synth is in Local On or Off mode, as when the other synth is in Local Off mode it probably breaks a possible endless loop at its own side and the G2 module must probably be set to Echo On to still allow for two-way MIDI traffic. Always remember that the Echo setting depends very much on the capabilities of the other MIDI device and both devices must be properly set up at their own sides for MIDI automation to work.

KEYBOARD SHORTCUTS

Short-cut Key	'Special function'
Escape	Abort Mouse Dragging Operations
Delete	Delete Selected Modules
Keys 1 to 8 (numerals)	Select Variation #
F	Show FX Area or revert to previous view
V	Show Voice Area or revert to previous view
Arrow Up	Increase value of focused Parameter by one tick
Arrow Dn	Decrease value of focused Parameter by one tick
Arrow Left	Set focus to Previous Parameter on a Module
Arrow Right	Set focus to Next Parameter on a Module
Ctrl + Arrow Up	Increase Morph Range on Focused Param
Ctrl + Arrow Dn	Decrease Morph Range on Focused Param
Ctrl + Arrow Left	Set focus to Previous Parameter (same as Arrow Left)
Ctrl + Arrow Right	Set focus to Next Parameter (same as Arrow Right)
Shift + Arrow Up	Select Next Module Up
Shift + Arrow Dn	Select Next Module Down
Shift + Arrow Left	Select Next Module Left
Shift + Arrow Right	Select Next Module Right
Space	Show/Hide Cables (toggling between Show and Hide)
Ctrl + Space	Shake Cables
A	Select Slot A (if Slot is Active)
B	Select Slot B (if Slot is Active)
C	Select Slot C (if Slot is Active)
D	Select Slot D (if Slot is Active)
L	Assign focused Parameter to Last Received MIDI CC# (= MIDI LEARN)
M	Open MIDI CC# Assign Dialog for the focused Parameter
R	Toggle Master Clock (=RUN/STOP & can send MIDI START/STOP from G2)
F5	View Parameter Values (as yellow popup boxes)
F6	View Morph Groups (as yellow popup boxes)
F7	View Knob Assignments (as yellow popup boxes)
F8	View MIDI CC# Assignments (as yellow popup boxes)
Ctrl + F8	View Parameter MIDI Values (how knobs are sent or received by MIDI CC#s)
Tab	Select Next Module Group Selector in Module Toolbox
Shift + Tab	Select Previous Module Group Selector in Module Toolbox
> or .	Select Next Module in Module Toolbox

Short-cut Key	'Special function'
< or ,	Select Previous Module in Module Toolbox
Return	Add focused Module in Module Toolbox to the edited Patch
Ctrl + A	Select all Modules in currently focused Patch Area
Ctrl + B	Show or hide the Patch Browser
Ctrl + C	Copy selected items
Ctrl + D	Download Patch in active Window to Slot
Ctrl + E	Paste Parameters of last copied selection to current selection (if matching!)
Ctrl + F	Show or hide Parameter Pages window
Ctrl + G	Show or hide Synth Settings window
Ctrl + H	Macintosh-only OSX system function (= hide application)
Ctrl + I	Tile windows of currently Active Slots
Ctrl + J	Show or hide the Textpad window
Ctrl + K	Show or hide the Virtual Keyboard
Ctrl + L	Show or hide the Parameter Overview window
Ctrl + M	Send Controller Snapshot
Ctrl + N	New Empty Patch, clear focused Slot and Patch window
Ctrl + O	Show Open dialog box
Ctrl + P	Show or hide the Patch Settings window
Ctrl + Q	Quit the Editor program
Ctrl + R	Show or hide the Performance Settings window
Ctrl + S	Save Patch or Performance to disk, or show Save dialog box
Ctrl + T	Show or hide the Extended Toolbar
Ctrl + U	Upload Active Slot from the G2
Ctrl + V	Paste selection
Ctrl + W	Close current Patch window
Ctrl + X	Cut selection
Ctrl + Y	Redo last Undo
Ctrl + Z	Undo last action (there are many levels of Undo in the Editor software)
Ctrl + 1	Dump One (= dump patch as SysEx to the MIDI OUT connector)

14. SYNTHESIS BASICS

SUBTRACTIVE SYNTHESIS

Subtractive synthesis is one of the oldest and most widely spread forms of synthesizing sounds. It is the method employed in such classics as the Moog synthesizers, the Sequential Prophet-5 and 10, Arp synthesizers, most Oberheim synthesizers, the Roland Jupiter models, the TB-303 etc.; the list is practically endless. Even new digital instruments such as workstations and sample playback devices employ many of the basic principles of subtractive synthesis.

With the Nord Modular G2 system, Clavia introduces a new concept: a modern digital instrument that combines a faithful reproduction of the behaviour of the old analog favourites with the convenience and stability of the newer designs.

The purpose of this chapter is to give you a quick introduction to the basics of subtractive synthesis. If you'd like to know more, there are number of books written on the subject.

MODULES - THE BUILDING BLOCKS

Subtractive synthesis started its life in *modular synthesizers*, large cabinets housing separate electronic modules, connected via patch cords. With the advancement of technology, the functionality of many of these modules could be put onto one single circuit board. But functionality-wise, subtractive synthesizers are still built out of the same modules (or building blocks) as they were decades ago. We will now take a closer look at these building blocks. Let's first talk about three basic modules that actually create and process sound:

OSCILLATOR

The Oscillator is one of the few modules in a synthesizer that actually *produces* any sound, (most of the other modules only *shape* the sound from the oscillator.) The oscillator is a bit like the string on a string instrument, it vibrates to create sound.

FILTER

The signal from the oscillator can be sent through a Filter which shapes the *timbre* of the sound to make it "bright", "dull", "thin", etc.

AMPLIFIER

The Amplifier shapes the *volume* of the sound making it "soft" or "hard", "slow" or "short".

In addition to these three basic modules, all synthesizers also have "modulators", devices that can make the volume, timbre pitch and other qualities of sound vary continuously when you play a key. It is these modulators that basically add animation to the sound, taking it from a dull organ drone to a dynamic and interesting timbre. The two most common modulators are Envelopes and LFOs:

ENVELOPE GENERATOR

An envelope generator is used to give a sound a "shape". If you apply an envelope to the amplifier (which controls the volume) you are able to make the sound for example slowly fade in and then fade out when you press and hold a key.

LFO

LFO is an abbreviation for Low Frequency Oscillator. It is used for repeating variations in a sound, such as vibrato or tremolo.

CONNECTIONS

There are many ways in which the modules outlined below can be connected in a synthesizer, but the one in the picture below is a basic and common one, used in some older synthesizers.

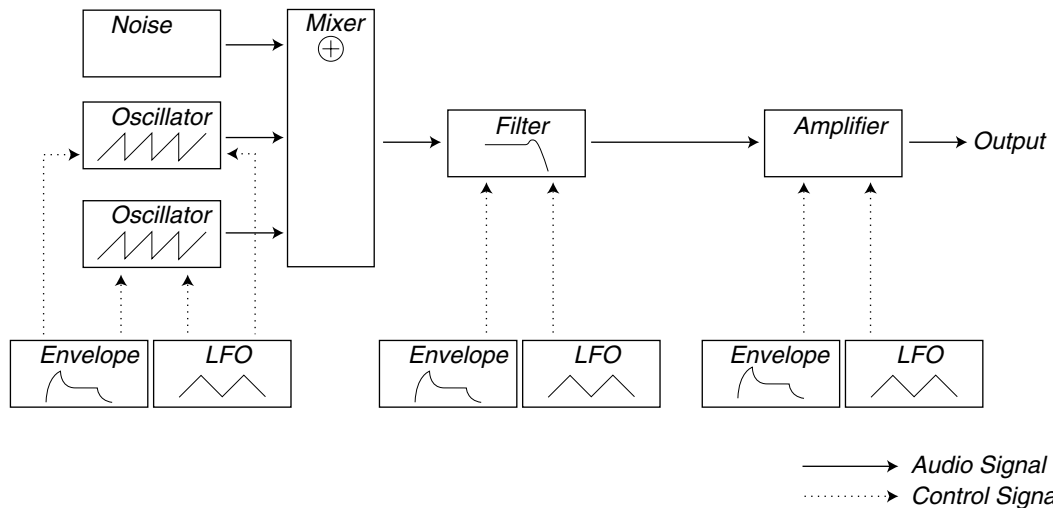

Note that the horizontal lines indicate the way the sound travels. The vertical lines indicate control signals. The envelopes for example only *modulate* (control) the oscillator, filter and amplifiers, they do not affect the sound directly.

THE OSCILLATORS AND WAVEFORMS

The two basic qualities of an oscillator is waveform and pitch.

PITCH

The length of a waveform period determines the pitch (frequency) of the sound. The shorter the period, the higher the pitch. If you for example make the oscillator play at a frequency of 440Hz, there will be 440 periods of identical Sawtooth waves generated per second.

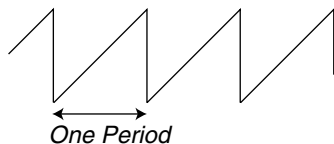

Normally there are three ways to change the frequency of an oscillator:

- **By changing the frequency settings on the oscillator.**
- **By playing the keyboard.** The keyboard is connected to the oscillator via the KBT (Keyboard Tracking) parameter so that pressing different key produces different pitches. In some cases this connection can be turned off, so that the oscillator always plays the same pitch, regardless of which key is pressed.

- **By Modulation.** Modulation allows you to make the pitch vary “automatically”. The most common example is probably to use an LFO to make pitch go up and down, to create a vibrato. But you can also put the pitch under envelope control, or make the pitch vary with your striking force (velocity).

WAVEFORM

The waveform of the oscillator affects its harmonic content and thereby its “characteristics” (timbre). The three most common waveforms are sawtooth, pulse wave and triangle.

Looking at the shape of a waveform tells very little about how it sounds. Instead, there’s a better way to draw it, called a *spectrum*. Let’s introduce some quick theory:

Mathematically, all waveforms can be considered as built from a number of *harmonics*, added together.

Each of the harmonics consists of a *sine wave*, the purest and simple waveform there is (a sine wave has no harmonics at all). In other words, if you add a number of sine waves together, each one with its own pitch (frequency) and volume (amplitude), then you can build any waveform you like.

The lowest harmonic is called the *fundamental*. The fundamental determines the basic pitch of the sound. If the fundamental has a frequency of 440Hz, we will perceive the entire sound as having a pitch of 440Hz.

Other harmonics are then added to the fundamental, called *overtones*. Normally the first overtone appears at a frequency twice the fundamental (in our example 880 Hz). The next harmonic appears at a frequency three times the fundamental (in our example 1320Hz) and so on.

In a spectral display of a waveform you can see the *frequency* (pitch) of each harmonic and its *amplitude* (level). This is done by drawing each harmonic as a line raising up from a horizontal scale.

Each line’s position on this scale indicates the harmonic’s frequency. The line furthest to the left is the fundamental, the next is the first harmonic etc. To make life easier, one usually doesn’t label the horizontal scale with frequency in Hz, but rather with the number of the harmonic. The height of each line represents the amplitude of each harmonic.

If you understand the principle, you also understand that if the harmonics with high numbers have a high amplitude, the sound will be perceived as bright.

Let’s take a look at some common waveforms and their spectra.

In the illustrations below, only some of the first harmonics are displayed. In reality, waveforms like these have an infinite amount of harmonics.

SAWTOOTH

The Sawtooth wave has a simple spectrum. All harmonics are present in the wave, in proportional values. As you can see, the high harmonics have a fairly high amplitude, which makes this waveform sound bright.

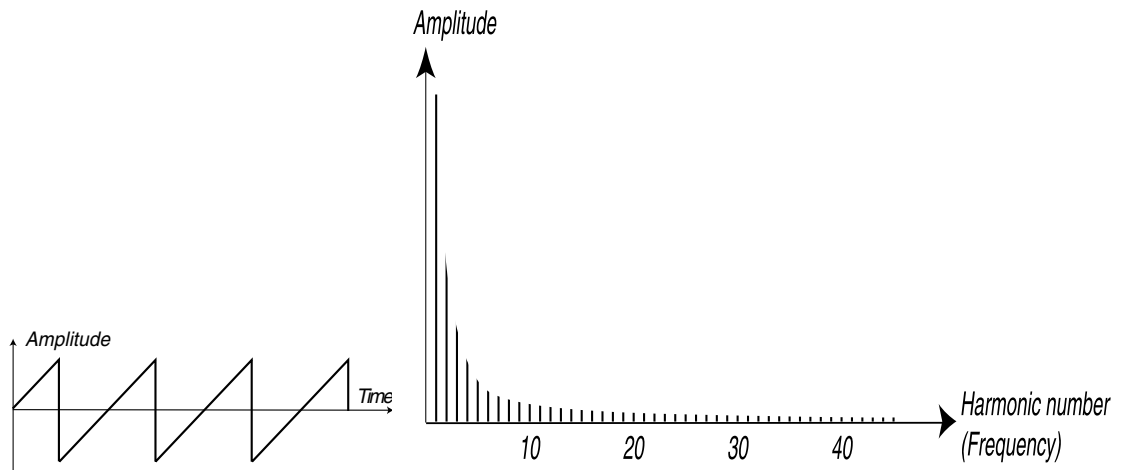

TRIANGLE

The triangle wave does not have very strong harmonics. Furthermore they only appear at odd harmonic numbers. The first fact makes the tone pure, a bit like a flute, and the second fact gives the sound a slightly “hollow” character.

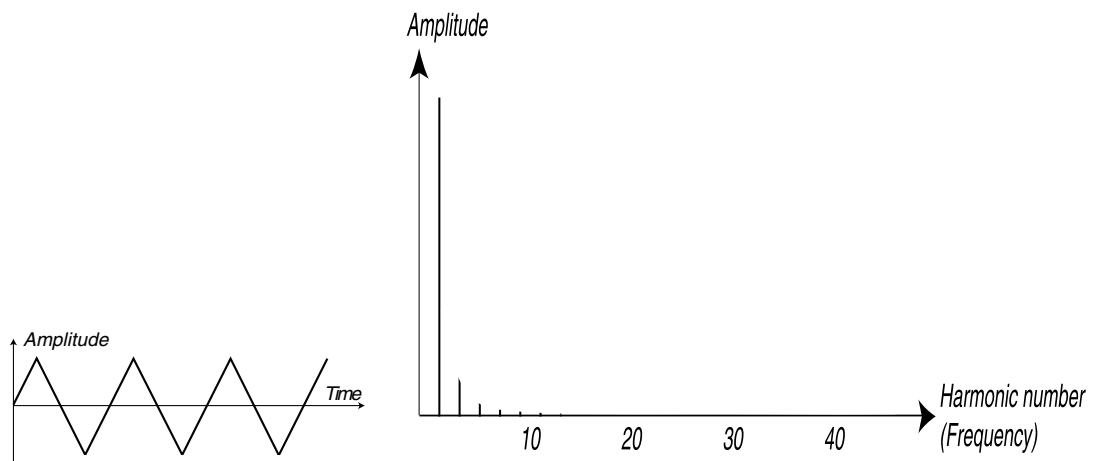

PULSE WAVE

The pulse wave is slightly more complicated, because it is not *one* waveform, it is many different ones. A pulse wave is a waveform that during one period jumps once between full positive amplitude and full negative and then back. The thing that can be varied is *where* within the period you jump from maximum to minimum amplitude. Let’s look at three examples:

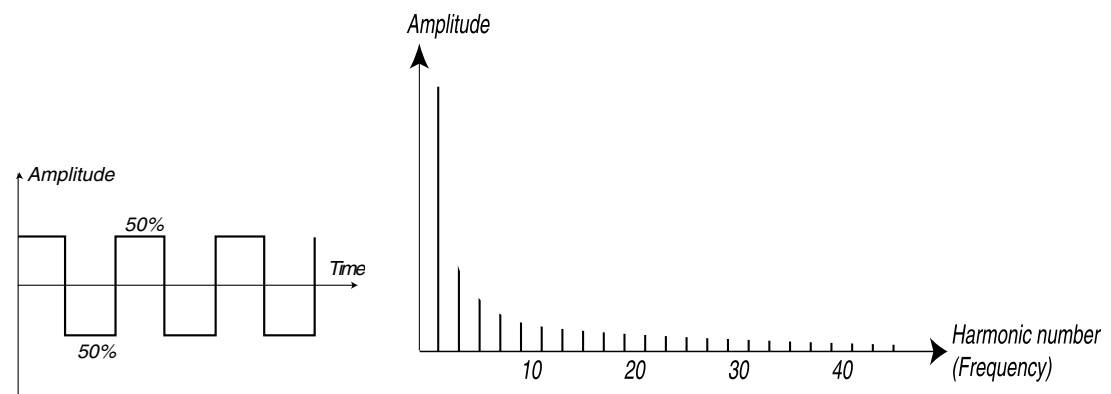
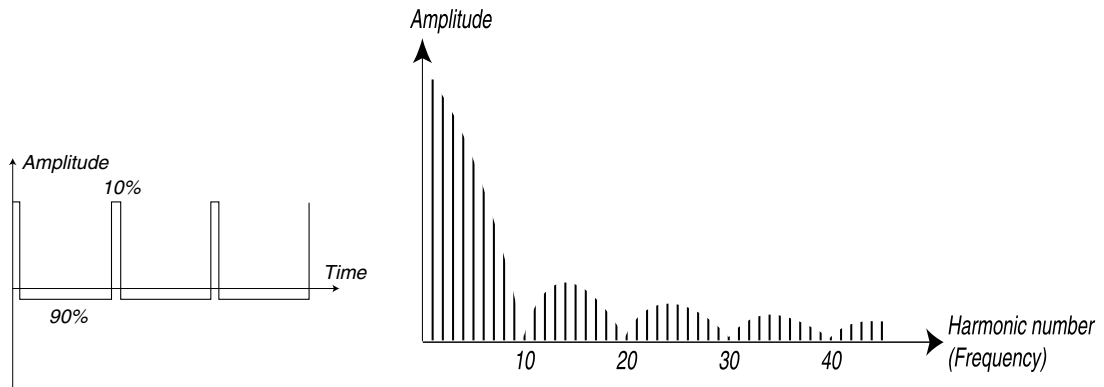
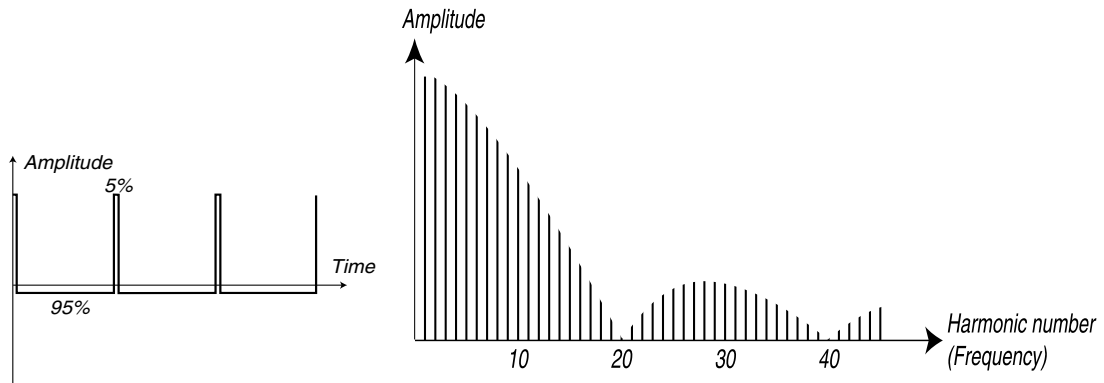

In the first, the jump happens 5% in from the beginning of the period. This is referred to as a pulse wave with a 5% *pulse width* (sometimes called *duty cycle*). The second wave has a pulse width of 10%. The third wave has a pulse width of 50%.

This third wave is a special case of the pulse wave, called a *square wave*, and this has one peculiarity, it only contains odd number harmonics, which gives it a “hollow” quality.

On many synthesizers (including the Nord Lead) the pulse width can be adjusted, to set the timbre of the pulse wave. The more narrow the pulse width, the more “thin” the sound will be.

You can also have the pulse width vary continuously, for example from an LFO or envelope. This is referred to as *pulse width modulation*. Modulating pulse widths from an LFO creates a rich, chorus-like effect often used in “string” sounds.

ABOUT INHARMONIC SPECTRA

Above we have only discussed spectra where the overtones appear at perfect harmonics. While this is true for the basic waveforms discussed above, it is definitely not true for all sound. If you for example use the frequency modulation (FM) or Ring Modulation capabilities in the Nord Modular G2, with two oscillators set to an “unusual” interval (not octaves or fifths, for example), you will get a spectrum where the overtones appear at frequencies somewhere *between* the perfect harmonics. This results in an *inharmonic* sound, which often sounds “metallic”.

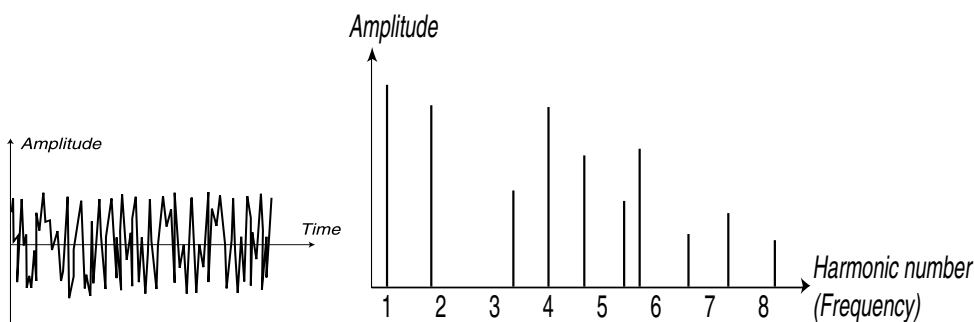

SYNC

On some instruments (including the Nord Modular G2), two Oscillators can be *synchronized*. If you for example synchronize Oscillator 2 to Oscillator 1, Oscillator 2 will start over with a new period of the waveform, each time Oscillator 1 does so. If Oscillator 2 then has a higher frequency than 1, it will get a complex waveform that depends both on its own pitch and on that of the other oscillator.

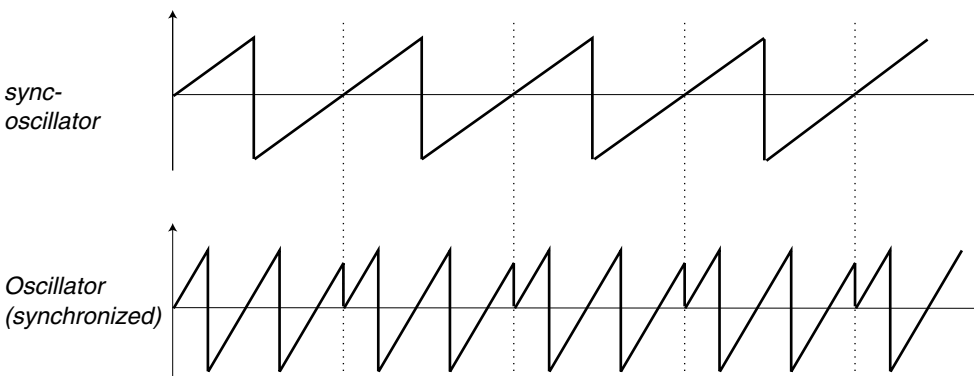

When sync is applied, the basic pitch of Oscillator 2 is locked to that of Oscillator 1. If you change the pitch of Oscillator 1 you will affect the basic pitch of both oscillators. Furthermore, when you vary the

pitch of the synchronized oscillator (Oscillator 2), this will be perceived as a change in timbre, rather than in pitch.

This leads to a spectrum with deep resonances at Osc2's harmonics, like this:

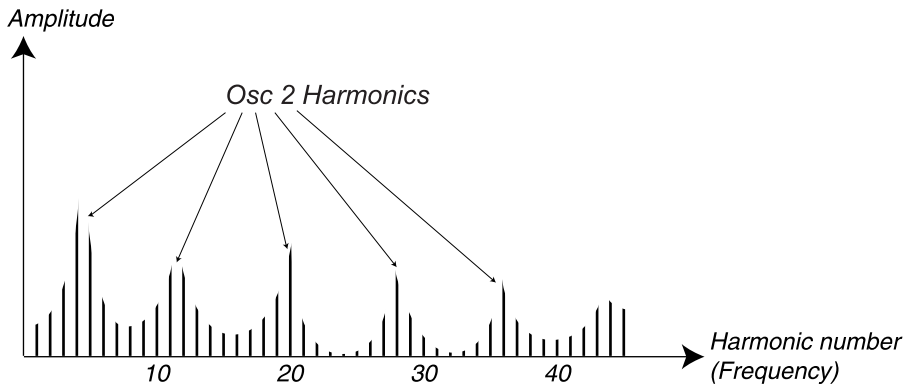

If you go even further and let the pitch of the synchronized oscillator vary continuously, for example from an LFO or envelope, you will change the harmonic content of the sound in an interesting and very characteristic way.

THE FILTER

The filter in a synthesizer is used to remove or emphasize frequencies in a spectrum. A filter is a bit like an amplifier (a volume control) that is applied differently to different parts of the spectrum. For example, a filter might make low frequencies louder, while at the same time making high frequencies weaker. Applying such a filter would make a sound have more bass and less treble.

Let's imagine a sound with a spectrum where all harmonics are available at full level. It would look like this:

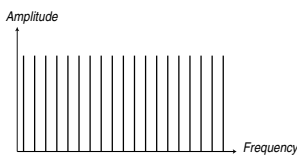

Let's now pass this spectrum through a *lowpass* filter (this type of filter is discussed in more detail below). The filter has a characteristic, which can be drawn as a curve.

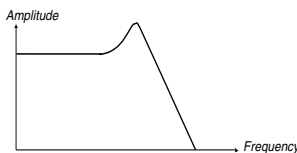

As you can see the curve is flat in the low register (which means it doesn't affect this part of the spectrum at all) and then, at a certain point, gradually starts falling. When applied to the wave above, this filter cuts away some of the high frequency material in the wave, like this:

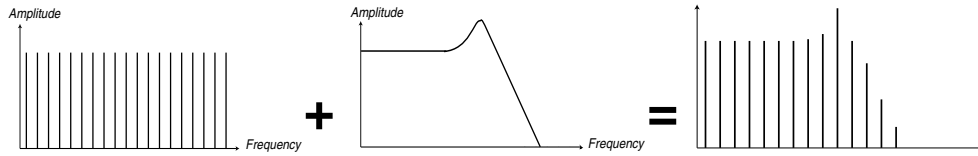

FILTER TYPES

There are many types of filters, all with their different purposes. We will here discuss the three most common ones.

LOWPASS FILTER

The Lowpass filter dampens high frequencies and let's low frequencies pass through unaffected, as in the example above. It is the most common synthesizer filter, since it can be used to "round off" the sharp sound of sawtooth waves and pulse waves.

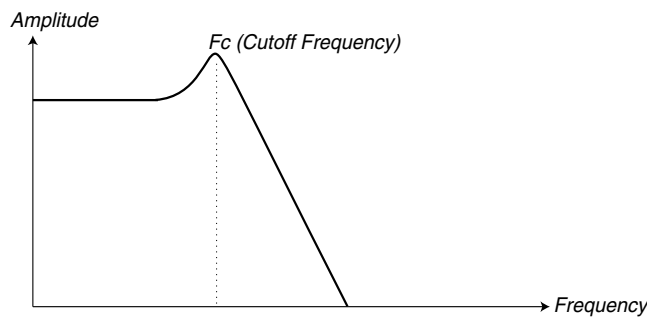

HIGHPASS FILTER

This is the opposite of the lowpass filter. It let's the high frequencies of the sound pass through and cuts off the low frequencies. This removes "bass" from a sound, without affecting the high end.

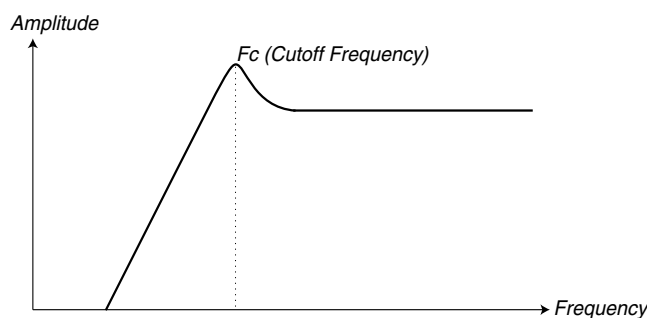

BANDPASS FILTER

This lets frequencies in a certain range of the spectrum (the band) pass through while dampening frequencies both below and above this range. This accentuates the mid-range of a sound.

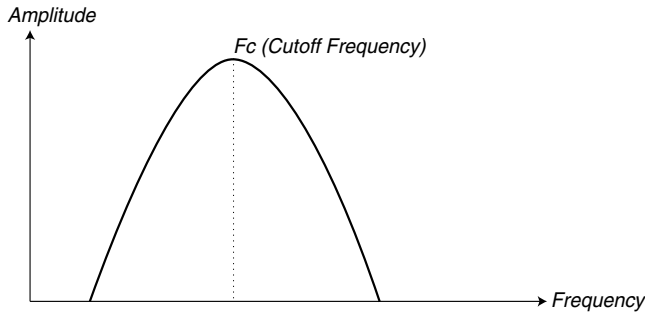

NOTCH FILTER

This filter type (also known as Band Reject) can be seen as the opposite of a band pass filter. It cuts off frequencies in a “mid-range” band, letting the frequencies below and above through.

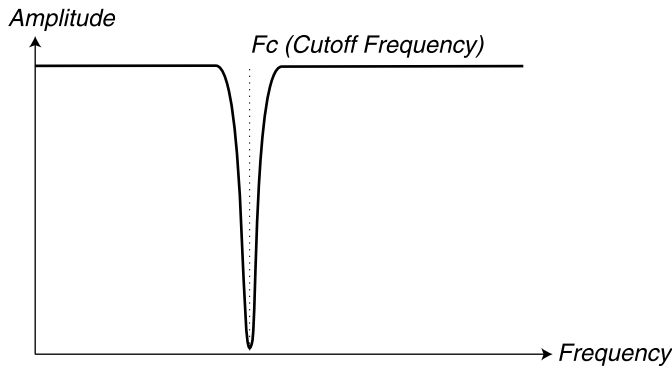

ROLL-OFF (SLOPE)

Filters of one and the same type (lowpass, highpass etc.) can have different characteristics. One of the factors determining the exact filter curve is the *roll-off*, which is measured in *dB/Octave* (“decibels per octave”) or *poles*. The simplest possible filter has a roll-off of 6dB/octave, which is referred to as “1 pole”. The next step up is 12dB (2 poles), 18db (3 poles) etc.

The most common synth filters are the 12dB and 24dB lowpass filters. The difference between the two can be studied in the graph below. The 12dB filter lets more of the high frequency pass through which gives the sound a brighter and “buzzier” character than the 24dB filter does.

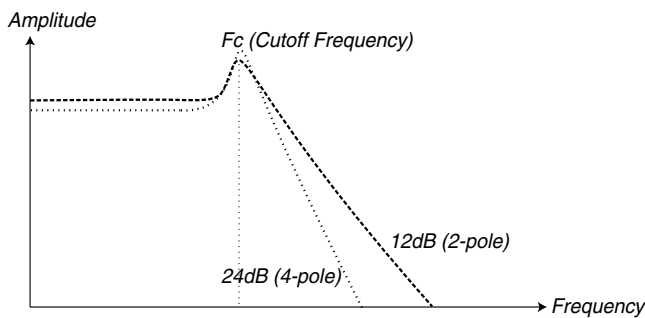

In the Nord Modular G2, the Nord Filter filter can be switched between 12 and 24dB modes. For sounds with high resonance (see below), similar to those in the Roland TB-303, we recommend the 12dB variation. For most other sounds we recommend 24dB.

CUTOFF FREQUENCY

The most important parameter for a filter is its *cutoff frequency*, which is the setting that determines *where* in the frequency material it should start cutting. If the cutoff frequency in a low pass filter is set to a very low value, only the lowest harmonics (the bass) will pass through. If you raise the cutoff all the way up, *all* frequencies will be let through, as the figure below illustrates.

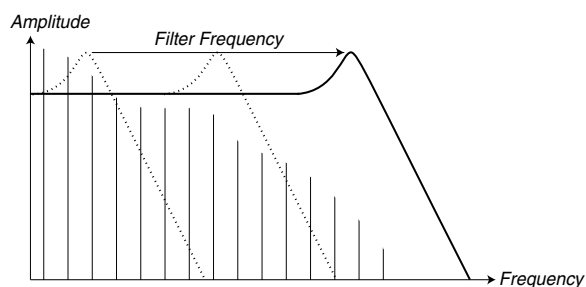

Changing the cutoff frequency is often referred to as “sweeping the filter”. This is probably one of the most important ways of shaping the timbre of a synthesizer sound. By using an envelope you can for example have a high cutoff at the beginning of a sound which is then gradually lowered (the filter “closes” as the sound decays). This would emulate the way most plucked string sound (piano, guitar etc.) behave; the amplitude of the harmonics decreases as the sound decays.

KEYBOARD TRACKING

When you play different pitches, the oscillators produce different frequencies. This means that the overtones in the waveform appear at different frequencies. The cutoff frequency of the *filter* however, is fixed. This means that different overtones will be cut off at different pitches. To be more precise, the further up the keyboard you play, the muddier the sound will be.

To remedy this problem many synthesizers have a parameter called *Filter Keyboard Tracking*. When this is activated, the filter Cutoff Frequency varies with which key you play, just as the oscillator frequency does. This ensures a constant harmonic spectrum for all keys.

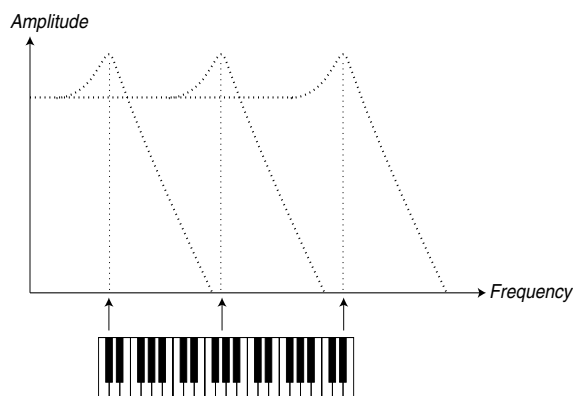

RESONANCE

Resonance in a filter is created by connecting the output of the filter to its input, in other words setting up a “feedback loop”. The amount of feedback is then controlled with a Resonance parameter on the front panel of the instrument.

When you apply resonance, the frequencies just around the cutoff point of the filter will be emphasized (louder). As you increase the Resonance further and further, the filter will start to behave more and more like a bandpass filter, where only the frequencies around the cutoff point are let through. The filter will start to “ring”, which means it almost sounds like it is *adding* frequencies to the sound. If the Resonance is then raised even further (on some synthesizers) the filter will start to self-oscillate, that is produce sound of its own, just like an oscillator.

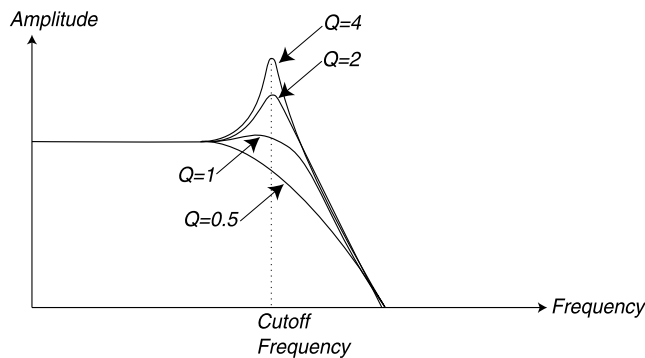

High Resonance values are also visible in the waveform. They appear as a “superimposed” waveform with a frequency equivalent to the filter’s cutoff frequency. The three examples above show the same wave with increased resonance.

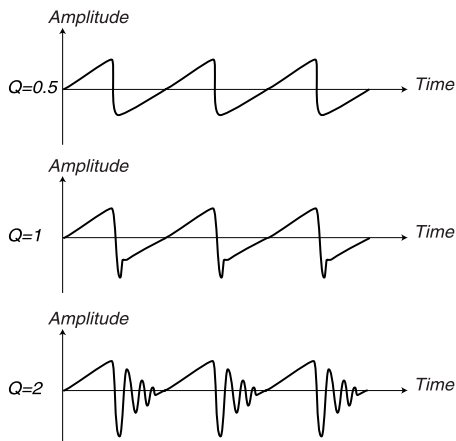

If you add Resonance to a sound and then vary the Cutoff frequency (for example with an envelope) you will get a very typical synthesizer sound.

THE AMPLIFIER

An amplifier is most often used at the final stage of a synth signal chain, to control volume. By modulating the amplifier with an envelope, the sound can be given its basic “shape”. In fact, the “volume

shape” is one of the most important factors to how we identify the sound. By setting up a proper volume envelope you can make a sound “soft”, “hard”, “plucked” “static” etc.

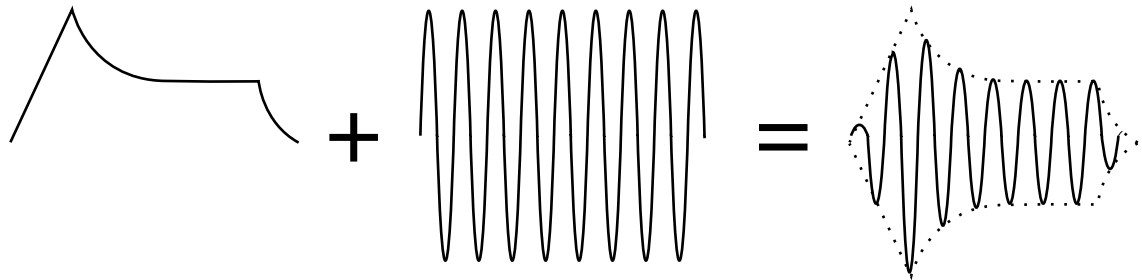

The volume envelope curve (to the left) determines how the amplitude of the waveform changes over time.

ENVELOPES

ADSR-ENVELOPE

Envelopes are used to modulate pitch, amplitude, filter cutoff and other parameters in a sound. This is used to give the sound a varying character from the moment the key is pressed to the moment it is released.

The classic synthesizer envelope has four parameters, Attack, Decay, Sustain and Release, and is therefore often referred to as an “ADSR-envelope”.

When you press a key, the envelope is *triggered*. This means it starts rising from zero to maximum level. How long this should take, depends on the *Attack* setting. If the Attack time is set to “0”, the envelope will instantly reach full level. If it is raised it will take longer.

If you for example have an envelope controlling volume, raising the attack will give the sound a “softer” character. If you have the envelope routed to the filter, it might give the sound a “wah” type of start.

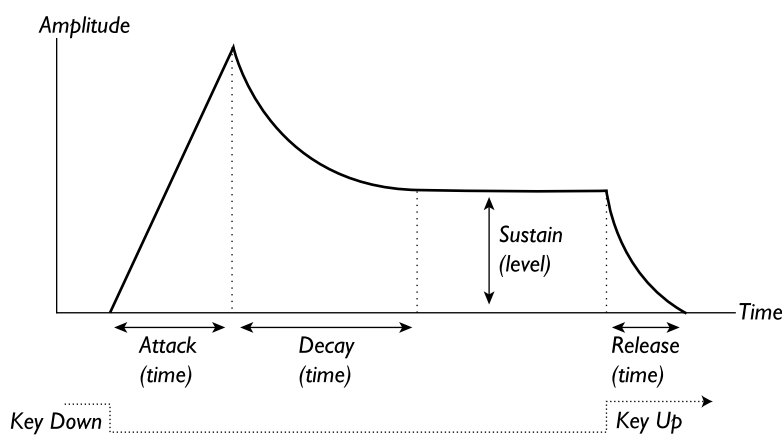

After the envelope has reached full level, it starts to fall back again. How long this should take, is set with the *Decay* parameter.

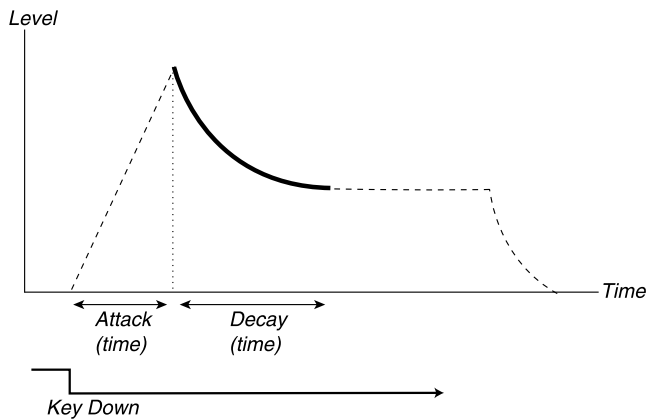

The level of the envelope does not necessarily have to fall all the way back to zero level at the end of the Decay. Instead, the ADSR-envelope has a *Sustain* setting used to determine the level the envelope should rest at, after the Decay. If you for example want to create a flute sound, you would have a fairly high Sustain setting on your Volume envelope, since a flute tone basically stays at a steady level for as long as you play it. On the other hand, for a piano sound, you would want a Sustain level of “0”, since a piano sound decays to silence if you hold the key long enough.

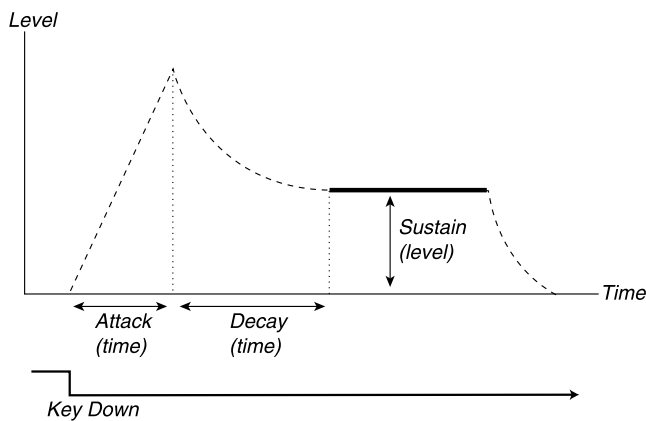

Please note that the Sustain parameter represents a *level*, but all other envelope parameters represent *times*.

As described above, the envelope stays at the Sustain level until the key is released. It then falls back to zero level. The time it should take for this to happen is set with the *Release* parameter, which works just as the Decay, only it is not applied until you lift your finger off the keys.

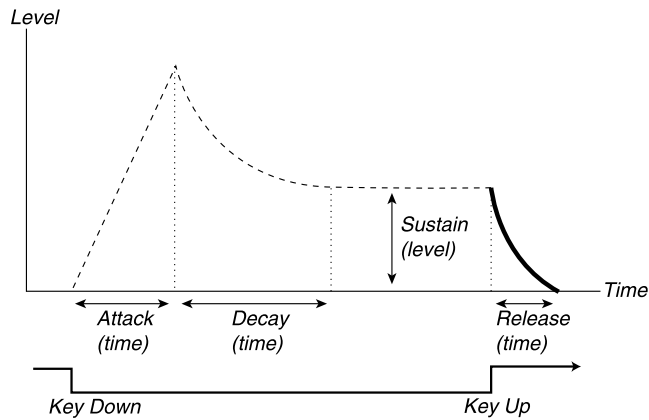

- If you set Sustain to full level, the Decay setting is of no importance since the volume of the sound is never lowered:

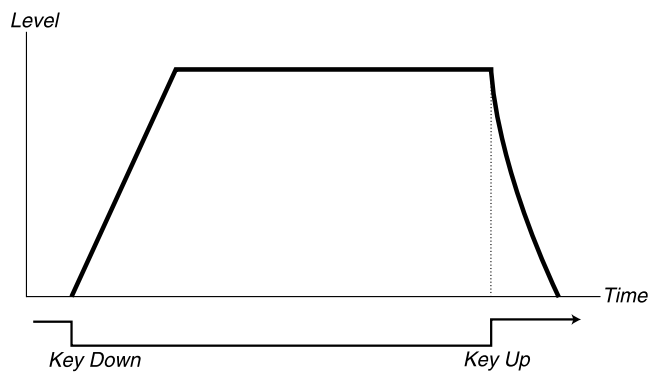

- If you set Sustain to 0, the sound will become silent after the Decay phase is finished. With short Attacks moderate Decay times, this can be used to simulate the behaviour of a plucked string instrument (guitar, piano etc.) where the sound always decays to silence after a while:

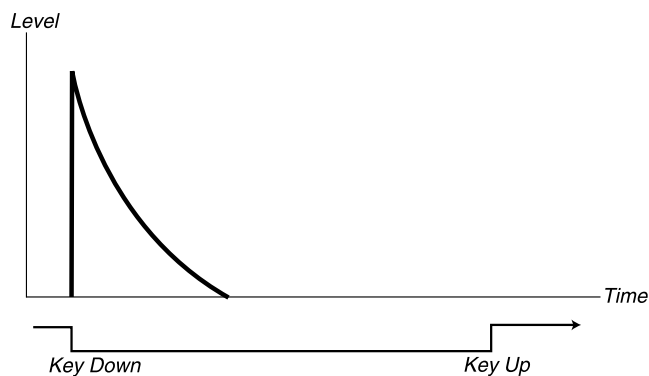

- If you release a key before the envelope has reach its sustain, it will immediately “jump” to the Release. The effect of this can be studied in the illustration below:

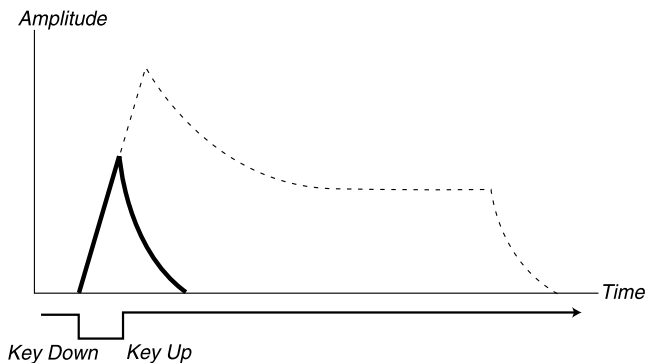

Often envelope levels can be made to vary with how hard you play the keys. This is used to make a sound vary with your playing style, for example to make the sound brighter (filter envelope) or louder (amplifier envelope).

AD-ENVELOPE

A simpler form of envelope has Attack and Decay parameters only, and is therefore called an AD-envelope. In effect, the AD-envelope behaves like an ADSR-envelope with Sustain set to 0 (see the picture above). This type of envelope, often with amount and inversion controls, is suitable when you want to affect the start of the sound only.

Typically, the AD-envelope can be made to modulate the FM amplitude or the pitch of an oscillator, to create a different timbre during the attack stage of the sounds.

LFOs

An LFO is an oscillator, just like the ones that produce the sound in a synthesizer, but with two main differences:

- The LFO produces very low frequencies, most often below the hearing range (up to 20Hz).
- The LFO is not used to produce sound, instead it is connected to other modules to provide modulation of parameters. If you for example route an LFO to pitch, you get a vibrato. If you route it to the filter's cutoff frequency you get a wah-wah type of effect. And if you route it to the amplifier of an instrument you get a tremolo.

The three basic parameters for an LFO are *Waveform*, *Rate* (frequency) and *Amount*:

- The waveform determines the type of vibrato, for example “regular” (triangle or sine), ramp (saw-tooth) or random.
- The Rate determines the speed of the vibrato.
- The Amount controls to what degree the LFO affects its destination.

ADDITIVE SYNTHESIS

Additive synthesis basically is the opposite of Subtractive synthesis. Instead of using waveforms with rich harmonic content, such as sawtooth and pulse waves, and attenuating and amplifying different parts of the harmonics with filters, you build your waveforms by adding together a number of sine waves. This is how tonewheel organs work, for example.

CREATING A WAVEFORM

To show the basic principle of additive synthesis, let's create a "rough" triangle wave out of several sine waves. The triangle wave does not have very strong harmonics. Furthermore they only appear at odd harmonic numbers. The first fact makes the tone pure, a bit like a flute, and the second fact gives the sound a slightly "hollow" character. Since a "perfect" triangle wave consists of an infinite number of sine waves, it's not practically possible to get a perfect result, but we can get pretty close. In the example below, we use six different sine waves to create our triangle wave. Note that the levels of the different oscillator harmonics is only schematic. The resulting waveform shape is also a rough estimation:

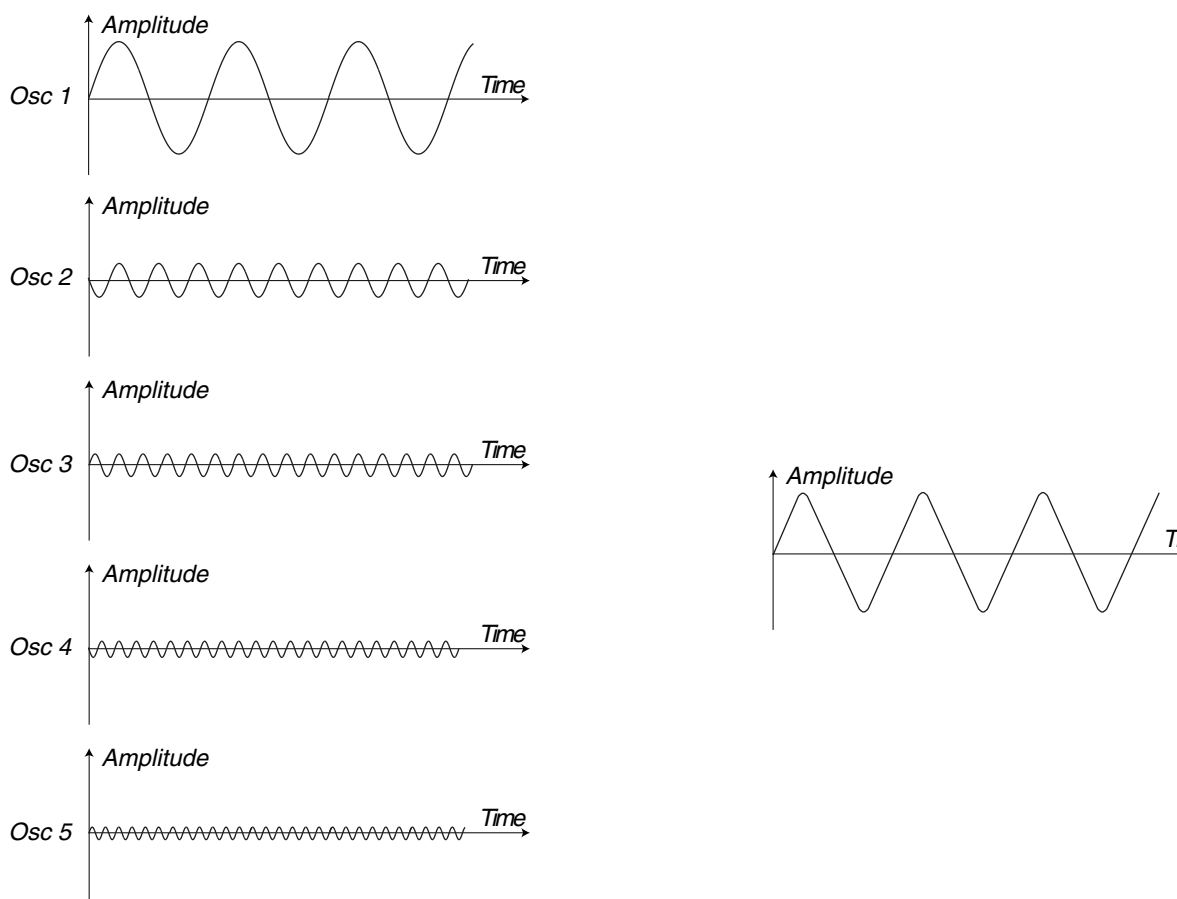

Why should you use additive synthesis to create complex waveforms, when you can easily get similar or even better results using subtractive synthesis, you may ask. Here is an important difference:

- With additive synthesis, you have total control over each single harmonic in the waveform. This makes it possible to really tailor-make your waveform. With subtractive synthesis, you can only control segments of the harmonic content.

OTHER SYNTHESIS AND MODULATION METHODS

FM SYNTHESIS

FM stands for Frequency Modulation and is a method for adding harmonic and inharmonic frequencies to a sound by modulating its frequency with another signal. A signal routed to an FM input on a module affects the pitch by modulating it linearly in the **frequency** scale as opposed to Pitch modulation where you modulate the frequency in the **note** scale. The difference in frequency between carrier and modulator wave determines the density of partials in the sound. The level of the modulator wave determines the total bandwidth of the sound.

The practical result of FM is often a “metallic” or “bell” type of sound. The most common wave to do FM on is a pure sine wave, but any type of waveform can be used, both as modulator and carrier (wave to be modulated). Complex waveforms will generate more frequencies than simpler waves.

AM SYNTHESIS

AM stands for Amplitude Modulation and is a method for adding frequency bands by modulating the amplitude of the carrier wave. To illustrate what amplitude modulation actually does to a sound, we have created a simple example with two sine waves, one carrier and one modulator. The graphs to the left show the amplitude as a function of time, and to the right the amplitude as a function of the frequency.

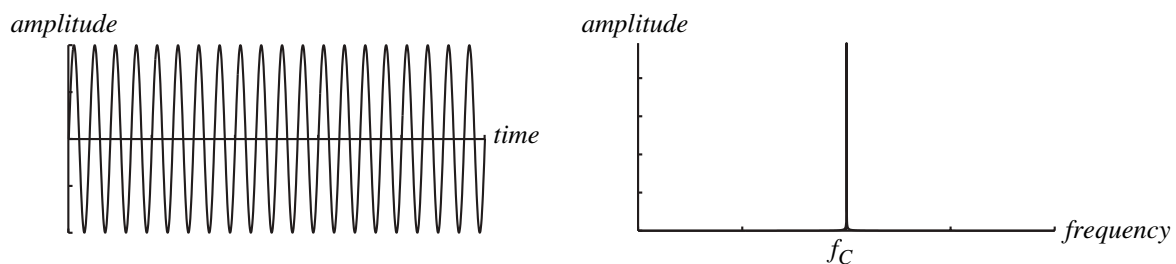

Fig 1. AM Carrier wave

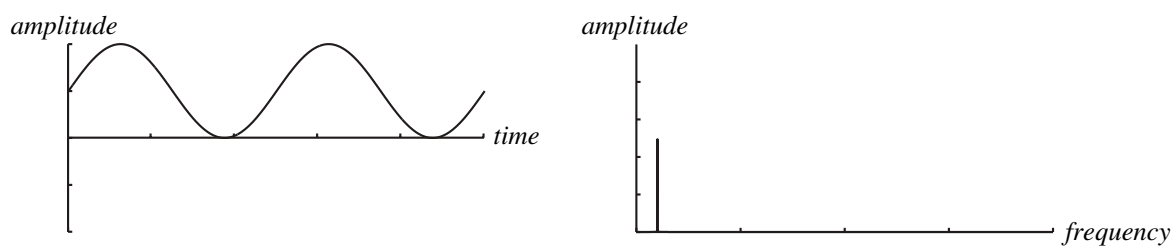

Fig 2. AM Modulator wave

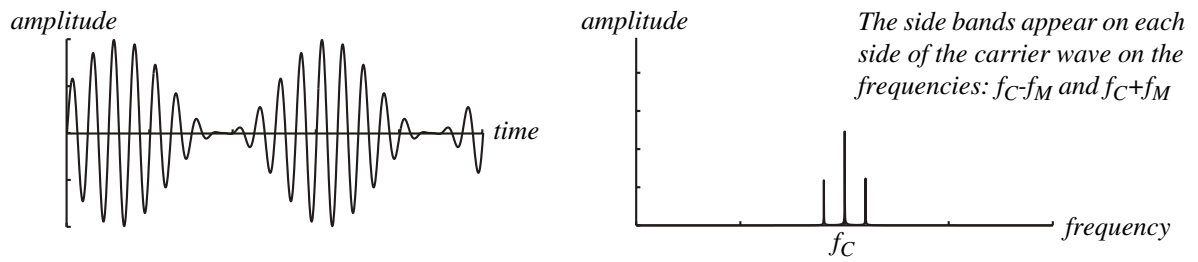

Fig 3. Amplitude Modulation

RING MODULATION

Ring modulation is similar to AM, but instead of using a unipolar (goes from zero level to positive levels) modulator wave, a bipolar modulator wave is used. In the example below we use the same carrier wave as in the AM example. We also use the same frequency of the modulator wave, only now it's bipolar

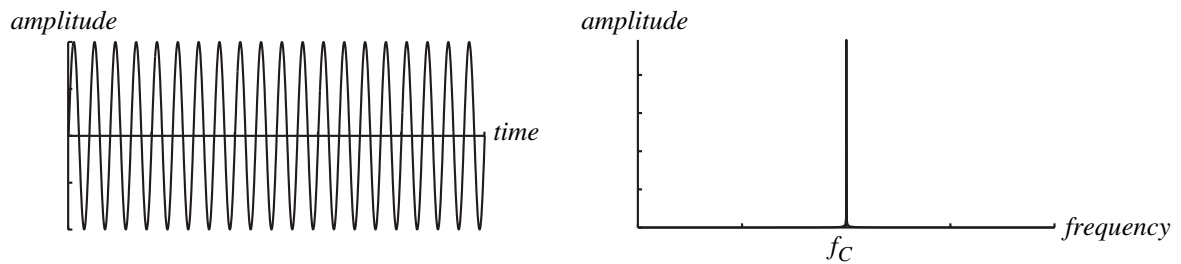

Fig 1. RM Carrier wave

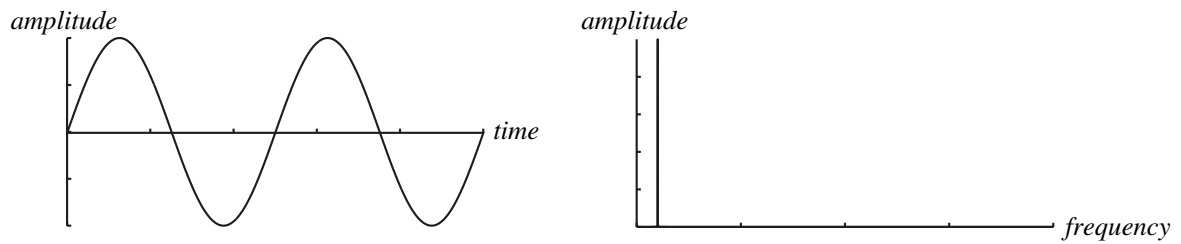

Fig 2. RM Modulator wave

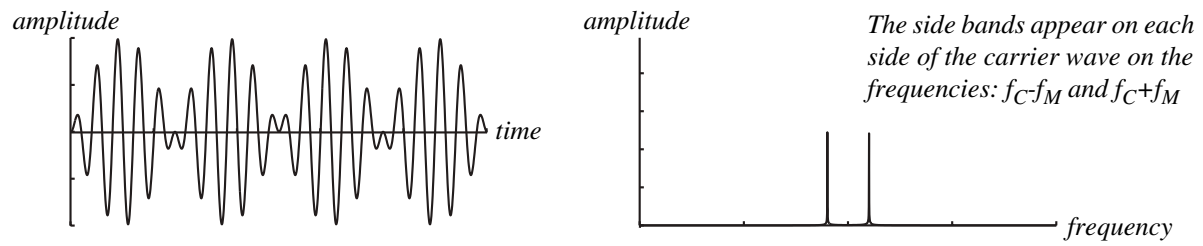

Fig 3. Ring Modulation

As you can see in the figures above, the main practical difference between amplitude- and ring modulation is the sideband amplitudes and the appearance of the carrier wave. Another difference is that the resulting ring modulation wave phase-shifts 180 degrees every half modulator period.

If more complex waveforms are used for amplitude- or ring modulation, sidebands will be generated for each partial of the signal.

Numerics

2-In module 158
 2-Out module 157
 4-In module 158
 4-Out module 157
 8Counter module 237

A

Acoustic (sound category) 40, 87
 Active Slots/Focus 43
 ADConv module 238
 Adding a Velocity Sensitivity Morph 66
 Additive synthesis 279
 aftertouch
 Morph 44
 Vibrato 35
 arpeggiator
 editing in the Editor 118
 editing on the synth 35
 assign
 all module parameters to knobs 91
 knobs
 in the Editor 90
 on the synth 37
 MIDI controllers 91
 Assignable Knobs/Buttons
 definition 19
 Assigning frontpanel knobs in the Editor 68
 attenuators 77
 Type I 77
 Type II 77
 Type III 77
 Audio In (sound category) 41, 87
 Automate module 260

B

bandwidth considerations 137
 bank
 delete 129, 130
 download to Modular 124
 upload from Modular 123
 Bass (sound category) 40, 87
 BinCounter module 238
 buttons
 assignable 33

C

cables
 break 70
 changing color 71

connecting 83
 connecting to Nord Modular G2 53
 delete 71
 disconnect 70, 84
 editing the appearance in the Editor 125
 hide all 62
 highlight 84
 popup window 70
 re-route 84
 shake 62
 visible 62
 cascade (window arrangement) 130
 categories (sound) 40, 87
 Changing a module into another type 67
 Classic (sound category) 41, 87
 clear
 module(s) 117
 Variations
 on the synth 40
 Clip module 205
 ClkDiv module 236
 ClkGen module 191
 Clocked Random Generator parameters 194
 color
 button 61
 modules 83
 Common Delay group parameters 253
 Common Envelope Generator parameters 197
 Common Filter parameters 208
 Common FX group parameters 248
 Common In/Out module parameters 156
 Common Level module parameters 226
 Common LFO parameters 187
 Common Logic module parameters 234
 Common MIDI module parameters 256
 Common Mixer parameters 216
 Common Oscillator parameters 172
 Common Random Generator parameters 193
 Common Sequencer parameters 240
 Common Shaper parameters 204
 Common Switch parameters 221
 CompLev module 231
 Compress module 252
 CompSig module 232
 Connections 265
 Constant module 226
 ConstSwM module 226
 ConstSwT module 226
 control pedal

- gain
 - editing from the Editor 122
 - editing from the synth 32
- Morph 44
- controller snap shot
 - sending from the Editor 124
- controllers
 - MIDI 141, 142, 143, 144
- copy 117
 - Morph groups
 - between Variations
 - in the Editor 94
 - on the synth 46
 - in the Editor 94
 - on the synth 46
 - Patches
 - on the synth 42
 - Variations
 - in the Editor 89
 - on the synth 39
- Creating a new empty Patch 63
- CtrlRcv module 259
- CtrlSend module 256
- cut 117
- D**
- DAConv module 238
- Del (delete letter position) 33, 42, 50, 52
- Delay group 253
- Delay module 237
- DelayA module 255
- DelayB module 255
- DelayDual module 254
- DelayQuad module 254
- delete
 - module(s) 117
 - Morph groups
 - in the Editor 94
 - on the synth 46
 - patch from synth memory 129
 - Patches 88
 - performance from synth memory 129
 - Performances 98
 - Unused Cables 71
 - Unused Modules 119
- Device module 160
- Digitizer module 249
- Disconnecting a cable 64
- Display 26

- display
 - assignable 33
- Display Mode button 28
- DlyClock module 255
- DlyEight module 254
- DlyShiftReg module 254
- DlySingleA module 254
- DlySingleB module 254
- DlyStereo module 255
- Download To Slot 119
- Drum (sound category) 41, 87
- DrumSynth module 181
- Dump CC 29
- Dump One 29
- DXRouter module 185

E

- edit
 - Morph groups
 - in the Editor 94
 - on the synth 44, 46
 - Patches
 - on the synth 37
 - Performances
 - in the Editor 95
 - in the synth 48
- Editor
 - installation
 - OSX 56
 - Windows 56
 - options menu 125
 - quit 116
 - start 57
- Editor G2 connection indicator 59
- Editor menu bar 115
- Editor software 55
- Engine 53
- EnvADDSR module 202
- EnvADR module 201
- EnvADSR module 200
- EnvAHD module 201
- EnvD module 201
- Envelope group 197
- Envelopes 275
- EnvFollow module 231
- EnvH module 200
- EnvMulti module 202
- Eq2Band module 213
- Eq3Band module 214

- EqPeak module 213
 - erase
 - Morph groups
 - in the Editor 94
 - on the synth 46
 - Patches 88
 - Performances 98
 - expression pedal
 - gain
 - editing from the Editor 122
 - editing on the synth 32
 - Morph 44
- F**
- Fade1-2 module 220
 - Fade2-1 module 220
 - Fantasy (sound category) 41, 87
 - file menu 115
 - Filter group 208
 - Flanger module 249
 - FlipFlop module 235
 - FltClassic module 210
 - FltComb module 215
 - FltHP module 209
 - FltLP module 209
 - FltMulti module 211
 - FltNord module 209
 - FltPhase module 214
 - FltStatic module 211
 - FltVoice module 211
 - FM 78
 - focus 84
 - definition 19
 - Focus/Copy button 27
 - Foot Switch
 - configuration
 - in the Editor 118
 - on the synth 32
 - FreqShift module 249
 - frequency modulation 78
 - front panel
 - Nord Modular G2 Engine 53
 - FX (sound category) 41, 87
 - FX Area 85
 - FX group 248
 - FX-In module 158
- G**
- G2 Basics 16
 - G2 Connection indicators (Editor) 59
 - Gate module 235
 - Glide
 - editing on from the Editor 118
 - editing on the synth 35
 - glide (portamento)
 - mode 35, 118
 - rate 35, 118
 - Glide module 168
 - Global (Parameter Pages) 49
 - global modulation wheel1
 - Morph 44
 - global modulation wheel2
 - Morph 44
 - Global Modulation Wheels (G2X model) 27
 - Global Octave Shift
 - editing from the Editor 121
 - editing from the synth 27
 - Global Parameter Pages 96
- H**
- H button in the Patch window 62
 - help 131
 - contents 131
- I**
- In/Out group 156
 - Init
 - Patch 60
 - create 116
 - Variation 39, 89
 - Init (1 & 2) 116
 - Ins (insert letter position) 33, 42, 50, 52
 - Inserting a module 63
 - installation
 - OS 140
 - OSX 56
 - USB driver 56
 - Windows 56
 - Invert module 235
- K**
- KB Hold button 27
 - KB Split 49
 - button 29
 - in the Editor 96
 - keyboard
 - (split) LEDs 29
 - aftertouch Morph 44
 - range Morph 44
 - split 49

- in the Editor 96
 - velocity
 - Morph 44
- Keyboard Assign 43
- Keyboard module 158
- Keyboard Zone 32
- KeyQuant module 164
- knob positions and MIDI values 77
- knobs
 - assign to module parameters
 - in the Editor 90
 - on the synth 37
 - assignable 33
 - control options in the Editor 125
 - module 89
 - using to send MIDI controllers 92
- L**
- Lead (sound category) 41, 87
- LevAdd module 227
- LevAmp module 227
- LevConv module 227
- level
 - master 26
 - Patch 35, 62
- Level group 226
- LevMod module 229
- LevMult module 227
- LevScaler module 170
- LFO group 187
- LfoA module 189
- LfoB module 189
- LfoC module 189
- LFOs 278
- LfoShpA module 189
- load
 - Patches
 - on the synth 22, 36
 - Performances
 - on the synth 24, 48
- Logic group 234
- M**
- Making a monophonic patch polyphonic 64
- Making your first patch 63
- master
 - tune
 - editing from the Editor 121
 - editing from the synth 30
- Master Clock
 - editing from the Editor 59
 - editing on the synth 34
- Master Level 26
- Memory Load indicators 60
- memory protect
 - editing from the Editor 122
 - editing from the synth 32
- MetNoise module 182
- Mic Level 26
- MIDI
 - assign controllers 70
 - Automation 144
 - channels
 - editing from synth 30
 - editing from the Editor 121
 - Clk Receive
 - editing from synth 31
 - Clk Send
 - editing from synth 31
 - Clock
 - editing from the Editor 121
 - Controller Commands enable
 - editing from synth 31
 - controllers 143
 - assign 91
 - auto assign 92, 130
 - auto deassign 92, 130
 - de-assign 91
 - using knobs to send 92
 - Ctrl send/receive
 - editing from the Editor 121
 - Global Channel 142
 - editing from synth 31
 - editing from the Editor 121
 - implementation chart 153
 - Learn function 145
 - LED 26
 - Local
 - editing from synth 30
 - editing from the Editor 121
 - MIDI CC# Auto assignment function 146
 - on/off
 - editing from the Editor 121
 - editing on the synth 30
 - Program Change enable
 - editing from synth 31
 - editing from the Editor 121
 - Send all MIDI CC# controller values 31
 - SysEx

- implementation 148
 - SysEx dumps
 - initiating from the synth 29
 - SysEx ID
 - editing from synth 32
 - editing from the Editor 121
 - Talkback function 147
 - The G2 as a MIDI controller box 147
- MIDI group 256
- MinMax module 232
- Mix1-1A module 217
- Mix1-1S module 217
- Mix2-1A module 217
- Mix2-1B module 217
- Mix4-1A module 217
- Mix4-1B module 218
- Mix4-1C module 218
- Mix4-1S module 218
- Mix8-1A module 218
- Mix8-1B module 218
- Mixer group 216
- MixFader module 219
- MixStereo module 219
- Mod Wheel 27
- ModADSR module 203
- ModAHD module 202
- ModAmt module 233
- Modular synthesis
 - definition 16
- modulation 76
 - attenuators 77
 - frequency 78
 - inputs 76
 - maximum amount 79
 - pitch 78
 - pulse width 78
 - sync 79
- Modulation Wheel
 - Morph 44
 - Vibrato 35
- module
 - add to patch 81
 - connecting 83
 - connections 71
 - definition 19, 71
 - delete 82
 - disconnect 84
 - display boxes and graphs 73
 - edit parameters 84
 - group tabs 60
 - inputs and outputs
 - self-optimizing 137
 - knobs and controllers 89
 - LEDs 73
 - move 82
 - parameters 73
 - popup window 69
 - rename 82
 - replace 82
- Module Icons 60
- Module reference 155
- MonoKey module 159
- Morph
 - definition 20
- Morph groups
 - assigning parameters
 - in the Editor 93
 - on the synth 44
 - buttons 33
 - control/expression pedal 44
 - copy and paste
 - between Variations
 - in the Editor 94
 - on the synth 46
 - in the Editor 94
 - on the synth 46
 - deassigning parameters
 - in the Editor 93
 - on the synth 46
 - deleting
 - in the Editor 93
 - on the synth 46
 - editing
 - in the Editor 94
 - on the synth 46
 - global modulation wheel 1 44
 - global modulation wheel 2 44
 - in separate Variations
 - in the Editor 94
 - on the synth 46
 - in the Editor 92
 - keyboard aftertouch 44
 - keyboard range 44
 - keyboard velocity 44
 - knobs 61
 - modulation wheel 44
 - on the synth 44
 - Pitch Stick 44

- multitimbrality 18
- Mux1-8 module 224
- Mux8-1 module 224
- Mux8-1X module 224
- N**
- Name module 163
- Navigator buttons 26
- Noise module 182
- NoiseGate module 231
- Nord Modular G2
 - about 15
 - introduction 15
- Note group 164
- NoteDet module 162
- NoteQuant module 164
- NoteRcv module 259
- NoteScaler module 167
- NoteSend module 258
- NoteZone module 260
- O**
- octave shift
 - editing from the Editor 118
- Octave Shift buttons 27
- Operator module 184
- Organ (sound category) 41, 87
- OS update 140
- OscA module 174
- OscB module 175
- OscC module 176
- OscD module 176
- OscDual module 179
- OscMaster module 183
- OscNoise module 183
- OscPerc module 181
- OscPM module 176
- OscShpA module 176
- OscShpB module 178
- OscString module 180
- Other synthesis and modulation methods 280
- output level 26
- Overdrive module 205
- P**
- Pad (sound category) 41, 87
- Pan module 219
- Panic button 27
- parameter
 - edit 84
 - popup window 70
 - putting in focus 84
- Parameter Overview window 126
- Parameter Pages
 - buttons 33
 - window 89, 125
- parameter pages
 - definition 19
- parameters
 - definition 19
- PartQuant module 165
- paste 117
- paste parameters 117
- Patch
 - close 130
 - close all 130
 - connections 83
 - copying
 - on the synth 42
 - create
 - in specific slot 115
 - create new 60, 115
 - delete 88
 - download from Internet 16
 - download to slot 86, 119
 - edit
 - on the synth 37
 - extracting from a Performance 51, 97
 - layering
 - on the synth 43
 - load from Modular memory 129
 - loading 36
 - naming
 - in the Editor 61
 - on the synth 40
 - open 115
 - in specific slot 116
 - rename
 - on the synth 43
 - save 116
 - save all 116
 - save as 116
 - save from Slot 116
 - save in internal memory 122, 129
 - selecting in a Performance 48
 - in the Editor 95
 - settings 118
 - editing on the synth 34
 - signals 134

- sorting
 - on the synth 40
 - sorting on the synth 36
 - sound categories
 - editing from the synth 40
 - in the Editor 87
 - storing 40
 - on the synth 86
 - upload from active slot 122
 - window popup 68
 - window split bar 63
 - patch
 - save in internal memory 129
 - Patch Browser 128
 - Patch button 26
 - Patch Level
 - editing from the Editor 62
 - editing on the synth 35
 - Patch Load button 26
 - Patch Load indicators 60
 - Patch Settings button 33
 - Patches and patch-files
 - definition 16
 - Patches, Slots and Performances 19
 - PCSend module 257
 - pdf-file 15
 - Perf Mode button 28
 - Performance
 - create new 115
 - creating and editing 48
 - in the Editor 95
 - deleting
 - in the Editor 98
 - download to synth from the Editor 120
 - exit Performance mode 47
 - in the Editor 98
 - handling in the synth 47
 - load from Modular memory 129
 - loading on synth 24, 48
 - Mode 47
 - name
 - editing from the Editor 59
 - naming 50
 - in the Editor 97
 - save in internal memory 129
 - selecting Patches 48
 - in the Editor 95
 - store 50
 - in the Editor 97
 - uploading to the Editor 95
 - Performance controls 27
 - G2X Global Modwheels 27
 - Performance Settings 119
 - Performances
 - definition 18
 - Phaser module 248
 - Piano (sound category) 41, 87
 - Pitch Bend range
 - editing from the Editor 119
 - editing on the synth 35
 - pitch modulation 78
 - Pitch Stick 27
 - Morph 44
 - PitchTrack module 168
 - popup
 - cable 70
 - module 69
 - parameter 70
 - patch window 68
 - portamento (Glide)
 - mode 35, 118
 - rate 35, 118
 - Prf button in the Editor 59
 - Program Change
 - editing from the Editor 121
 - editing from the synth 31
 - PShift module 250
 - Pulse module 236
 - PWM 78
- ## R
- Random signal generators group module 193
 - RandomA module 195
 - RandomB module 195
 - Rate
 - Glide 35, 118
 - rear panel
 - Nord Modular G2 53
 - recent files 116
 - redo 117
 - button 61
 - Renaming and saving a patch in the Editor 68
 - resolution 137
 - Reverb module 251
 - RndClkA module 196
 - RndClkB module 196
 - RndPattern module 196
 - RndTrig module 196

Rotary Dial 26

S

S button in the Patch window 62

S&H module 224

Saturate module 206

save

 InitPatch 116

 Patch

 in internal memory 122, 129

 on computer 116

 patch

 in internal memory 129

 Performances 50

 in synth memory 129

 in the Editor 97

 Variations

 in the Editor 89

 on the synth 39

Save In Synth 122

Scratch module 251

select all 117

Send Controller Snapshot 29

SeqCtr module 244

SeqEvent module 242

SeqLev module 243

SeqNote module 243

Sequencer (sound category) 40, 87

Sequencer group 240

Sequencing examples 244

SeqVal module 243

Shaper group 204

Shift button 29

ShpExp module 206

ShpStatic module 206

signals

 audio 135

 control 135

 definitions 134

 in the patch 134

 logic 135

 logic inputs 136

 logic outputs 135

Slot

 activate

 on the synth 43

 buttons 27

 download patch to 119

Slot buttons in the Editor 59

Slot indicator 59

Slots

 definition 17

sort

 Patches 40

 from the Editor 122

 on the synth 36

Sort Mode

 editing from the Editor 122

 editing on the synth 36

sound categories

 editing from the synth 40

 in the Editor 87

Split Point 49

Status module 160

StChorus module 248

store

 Patches 40

 Performances 50, 97

 Variations

 in the Editor 89

 on the synth 39

Store button 26

Sub Func button 28

Subtractive synthesis 264

sustain pedal

 on/off 32

 polarity

 editing from the Editor 122

 editing from the synth 32

Sw1-2 module 223

Sw1-2M module 223

Sw1-4 module 223

Sw1-8 module 223

Sw2-1 module 222

Sw2-1M module 222

Sw4-1 module 222

Sw8-1 module 223

Switch group 221

SwOnOffM module 222

SwOnOffT module 222

sync modulation 79

Synth (sound category) 41, 87

 synth name

 editing from the Editor 120

 editing from the synth 32

 synth settings

 editing from the Editor 120

Synthesis basics 264

System button 26, 29
System functions Menu 30
system requirements Macintosh 56
system requirements Windows 55

T

T&H module 225
Textpad 119
The Amplifier 274
The filter 270
The Oscillator group 172
The oscillators and waveforms 265
tile (window arrangement) 131
toolbar 59
Troubleshooting midi cc#'s 145
tune
 master
 editing from the Editor 121
 editing from the synth 30

U

undo 117
 button 61
updating OS 140
Upload Active Slot 122
USB
 driver installation Windows 56
User (sound category) 41, 87

V

ValSw1-2 module 223
ValSw2-1 module 223
Variation
 buttons 33
 clear
 on the synth 40
 copy
 in the Editor 89
 on the synth 39
 create
 in the Editor 88
 definition of 39
 Init
 in the Editor 89
 on the synth 39
 Morph groups
 in the Editor 94
 on the synth 46
 recall
 in the Editor 62

 on the synth 39
 save
 in the Editor 89
 on the synth 39
Variations
 definition 17
velocity
 Morph 44
Vibrato
 editing from the Editor 118
 editing on the synth 35
 rate 32
virtual keyboard 128
Vocoder module 212
Voice allocation and polyphony 138
Voice Area 85
Voice Mode
 editing on the synth 34
 indicator and selector 62
voices
 polyphony 64

W

WahWah module 211
WaveWrap module 206
What is MIDI? 141
WindSw module 224

X

X-Fade module 219

Z

ZeroCnt module 169