

DS3232 DIGITAL SNAKE OWNER'S MANUAL

Important Safety Instructions

1. Read these instructions.
2. Keep these instructions.
3. Heed all warnings.
4. Follow all instructions.
5. Do not use this apparatus near water.
6. Clean only with dry cloth.
7. Do not block any ventilation openings. Install in accordance with the manufacturer's instructions.
8. Do not install near any heat sources such as radiators, heat registers, stoves, or other apparatus (including amplifiers) that produce heat.
9. Do not defeat the safety purpose of the polarized or grounding-type plug. A polarized plug has two blades with one wider than the other. A grounding-type plug has two blades and a third grounding prong. The wide blade or the third prong are provided for your safety. If the provided plug does not fit into your outlet, consult an electrician for replacement of the obsolete outlet.
10. Protect the power cord from being walked on or pinched particularly at plugs, convenience receptacles, and the point where they exit from the apparatus.
11. Only use attachments/accessories specified by the manufacturer.
12. Use only with a cart, stand, tripod, bracket, or table specified by the manufacturer, or sold with the apparatus. When a cart is used, use caution when moving the cart/apparatus combination to avoid injury from tip-over.
13. Unplug this apparatus during lightning storms or when unused for long periods of time.
14. Refer all servicing to qualified service personnel. Servicing is required when the apparatus has been damaged in any way, such as power-supply cord or plug is damaged, liquid has been spilled or objects have fallen into the apparatus, the apparatus has been exposed to rain or moisture, does not operate normally, or has been dropped.
15. This apparatus has been designed with Class-I construction and must be connected to a mains socket outlet with a protective earthing connection (the third grounding prong).
16. This apparatus has been equipped with an all-pole, rocker-style AC mains power switch. This switch is located on the rear panel and should remain readily accessible to the user.



17. NOTE: This equipment has been tested and found to comply with the limits for a Class A digital device, pursuant to part 15 of the FCC Rules. These limits are designed to provide reasonable protection against harmful interference in a residential installation. This equipment generates, uses, and can radiate radio frequency energy and, if not installed and used in accordance with the instructions, may cause harmful interference to radio communications. However, there is no guarantee that interference will not occur in a particular installation.

If this equipment does cause harmful interference to radio or television reception, which can be determined by turning the equipment off and on, the user is encouraged to try to correct the interference by one or more of the following measures:

- Reorient or relocate the receiving antenna.
- Increase the separation between the equipment and the receiver.
- Connect the equipment into an outlet on a circuit different from that to which the receiver is connected.
- Consult the dealer or an experienced radio/TV technician for help.

CAUTION: Changes or modifications to this device not expressly approved by LOUD Technologies Inc. could void the user's authority to operate the equipment under FCC rules.

18. This apparatus does not exceed the Class A/Class B (whichever is applicable) limits for radio noise emissions from digital apparatus as set out in the radio interference regulations of the Canadian Department of Communications.

ATTENTION — *Le présent appareil numérique n'émet pas de bruits radioélectriques dépassant les limites applicables aux appareils numériques de class A/de class B (selon le cas) prescrites dans le règlement sur le brouillage radioélectrique édicté par les ministere des communications du Canada.*

19. Exposure to extremely high noise levels may cause permanent hearing loss. Individuals vary considerably in susceptibility to noise-induced hearing loss, but nearly everyone will lose some hearing if exposed to sufficiently intense noise for a period of time. The U.S. Government's Occupational Safety and Health Administration (OSHA) has specified the permissible noise level exposures shown in the following chart.

According to OSHA, any exposure in excess of these permissible limits could result in some hearing loss. To ensure against potentially dangerous exposure to high sound pressure levels, it is recommended that all persons exposed to equipment capable of producing high sound pressure levels use hearing protectors while the equipment is in operation. Ear plugs or protectors in the ear canals or over the ears must be worn when operating the equipment in order to prevent permanent hearing loss if exposure is in excess of the limits set forth here.

Duration, per day in hours	Sound Level dBA, Slow Response	Typical Example
8	90	Duo in small club
6	92	
4	95	Subway Train
3	97	
2	100	Very loud classical music
1.5	102	
1	105	Fooyoung screaming at destROYer about deadlines
0.5	110	
0.25 or less	115	Loudest parts at a rock concert

CAUTION

RISK OF ELECTRIC SHOCK. DO NOT OPEN

CAUTION: TO REDUCE THE RISK OF ELECTRIC SHOCK DO NOT REMOVE COVER (OR BACK) NO USER-SERVICEABLE PARTS INSIDE. REFER SERVICING TO QUALIFIED PERSONNEL

The lightning flash with arrowhead symbol within an equilateral triangle is intended to alert the user to the presence of uninsulated "dangerous voltage" within the product's enclosure, that may be of sufficient magnitude to constitute a risk of electric shock to persons.

The exclamation point within an equilateral triangle is intended to alert the user of the presence of important operating and maintenance (servicing) instructions in the literature accompanying the appliance.

Correct Disposal of this product: This symbol indicates that this product should not be disposed of with your household waste, according to the WEEE Directive (2002/96/EC) and your national law. This product should be handed over to an authorized collection site for recycling waste electrical and electronic equipment (EEE). Improper handling of this type of waste could have a possible negative impact on the environment and human health due to potentially hazardous substances that are generally associated with EEE. At the same time, your cooperation in the correct disposal of this product will contribute to the effective usage of natural resources. For more information about where you can drop off your waste equipment for recycling, please contact your local city office, waste authority, or your household waste disposal service.

WARNING — To reduce the risk of fire or electric shock, do not expose this apparatus to rain or moisture.

Table of Contents

Important Safety Instructions	2	Appendix A: Service Information.....	9
Introduction.....	4	Troubleshooting.....	9
Features	4	Repair.....	10
Getting Started	4	Appendix B: Technical Info	11
Connections.....	4	DS3232 Specifications.....	11
Setup.....	5	DS3232 Dimensions	11
DS3232 Features.....	7	DS3232 Block Diagram.....	12
Front Panel.....	7	TT24 ADAT Outputs.....	12
1. Network Connection	7	Input and Output Wiring.....	13
2. POWER Indicator	7	RJ45 Wiring.....	13
3. COMM Indicator	7	Appendix C: Hookup Diagram.....	14
4. INPUTS 1-32	7	DS3232 Limited Warranty	15
5. RETURNS 1-32.....	8		
Rear Panel.....	8		
6. POWER Switch	8		
7. POWER Receptacle	8		
8. Fan	8		

Don't forget to visit our website at www.mackie.com for more information about this and other Mackie products.



Introduction

Thank you for choosing the Mackie DS3232 Digital Snake to expand the mixing capabilities of your digital mixer. The DS3232 provides 32 balanced inputs and 32 balanced outputs, all easily accessible in a six rack space box.

The 32 mic preamps in the DS3232 are comprised of our highest-quality studio-grade mic preamps, rivaling expensive stand-alone boutique mic preamps. The A/D and D/A converters in the DS3232 are pristine 24-bit converters operating up to 96 kHz. The digital audio is connected to the mixer using standard Cat5e cable, at distances up to 300 feet (90 meters).

This allows you to connect your microphones and DI's to the DS3232 on-stage, and run a single Cat5e cable back to your FOH mixing position, eliminating signal degradation and noise that often results from long runs of analog cable. Not to mention the pounds of copper you save by not running a 300 foot 32-channel audio snake from the stage to the mixing console.

Features

- 32 x 32 I/O with XLR connectivity
- Mic preamps and A/D converters are digitally controlled by the mixing console
- 24-bit/96 kHz bi-directional digital audio
- Can be connected up to 300 feet from the mixing console
- Eliminates signal degradation and noise associated with long runs of analog cable
- Rack mountable (6 rack spaces)

Please write your serial number here for future reference (i.e., insurance claims, tech support, return authorization, etc.)

Purchased at:

Date of purchase:

HOW TO USE THIS MANUAL

We know that many of you can't wait to get your new Digital Snake hooked up, and you're probably not going to read the manual first (sigh!). So the next section is a Quick-Start Guide to help you get the DS3232 set up fast so you can start using it right away.

Then, when you have time, read the Features Description section. In this section, you'll find illustrations with each feature numbered. If you want to know more about a feature, simply locate it on the appropriate illustration, notice the number attached to it, and find that number in the nearby paragraphs.

More resources on our website at www.mackie.com.

Click Support on the opening page of our website to find answers to many of your questions. The FAQ (Frequently Asked Questions) section is filled with answers to many of the questions our Technical Support staff has fielded over the years.

Check out the glossary for explanations of many of the pro-audio terms used in our manuals.

Visit our forums to seek help from our online community of Mackie users.

Getting Started

READ THIS PAGE!!



Even if you're one of those people who never read manuals, all we ask is that you read this page and the next now before you begin using the DS3232. You'll be glad you did!

Connections

The DS3232 is designed to be connected to your digital mixer with a standard Cat5e (Ethernet) cable. If you are using a Mackie TT24 Digital Live Console, you need to install a U100 network interface card in the TT24 to make this connection.

1. Plug a microphone or other signal source into channel 1's MIC input [4] on the DS3232.
2. Connect the DS3232 to your digital mixing console using a standard Cat5e (Ethernet) cable with RJ45 connectors on each end (do not use a crossover cable). The connector is located at the top of the front panel on the DS3232.

Note: The DS3232 accepts a Neutrik® EtherCon® locking connector to secure the Ethernet connection.

- Turn on the mixing console.
- Plug in the detachable linecord, connect it to an AC outlet, and turn on the DS3232 POWER switch [6]. The POWER LED lights up and the COMM LED should also light, indicating that communication has been established between the console and the DS3232.

Setup

The setup for the DS3232 depends on the mixing console you are using it with. We'll use the TT24 Digital Live Console as an example. Visit our website periodically to discover what other mixers are equipped to operate with the DS3232 (www.mackie.com).

Configure Menu

- Press the SETUP button in the QuickMix area.

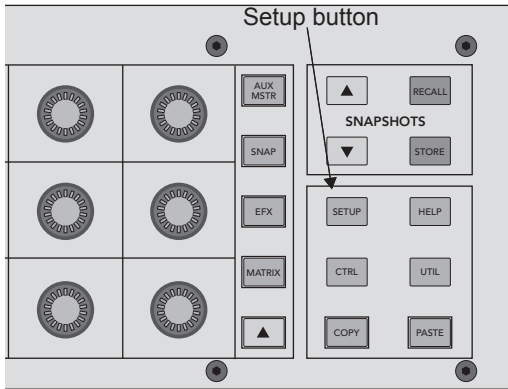

- Touch EXPANSION in the touchscreen to open the Expansion Slot Setup screen.

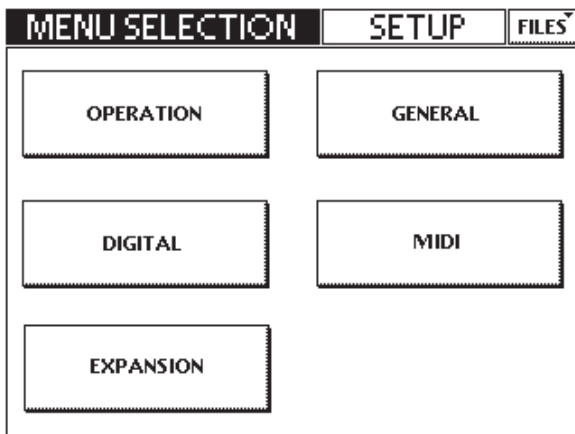

“Network” should appear in the box under the Expansion Slot that contains the U100 Network card.

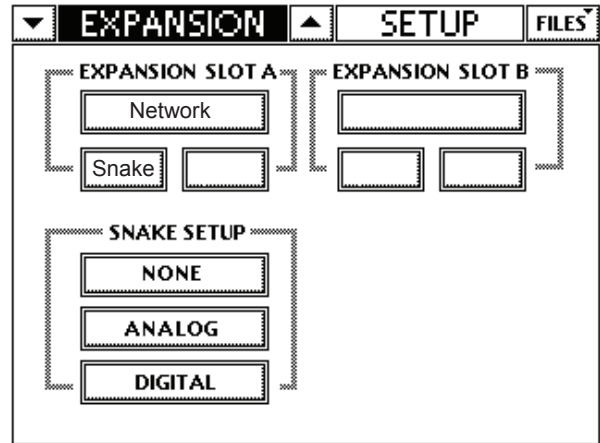

- When the DS3232 is powered on and properly connected, “Snake” should appear under “Network,” with Snake Setup options for NONE, ANALOG, or DIGITAL.

NONE: When NONE is selected, the TT24 operates as it normally does and ignores the DS3232.

ANALOG: Select this to replace the Analog bank (Channels 1-24) on the TT24 with input Channels 1-24 on the DS3232. Channels 25-32 on the DS3232 replace the Card channels 1-8 on the Returns bank.

DIGITAL: Select this to replace the Digital bank (Channels 25-48) on the TT24 with input Channels 1-24 on the DS3232. Channels 25-32 on the DS3232 replace the Card channels 1-8 on the Returns bank.

DS3232	(ANALOG selected in the Setup screen)	TT24 Input
INPUT Channels 1-24		Inputs 1-24 (Analog Bank)
INPUT Channels 25-32		Card 1-8 (Returns Bank)

DS3232	(DIGITAL selected in the Setup screen)	TT24 Input
INPUT Channels 1-24		Inputs 25-48 (Digital Bank)
INPUT Channels 25-32		Card 1-8 (Returns Bank)

- There is no setup required for the 32 outputs on the DS3232. They are automatically configured to carry the following outputs from the TT24:

DS3232	TT24 Output
RETURN Channels 1-12	Aux 1-12
RETURN Channels 13-20	GRP 1-8/Matrix 1-8
RETURN Channels 21-28	with LP48 Card installed: LP48 Output 1-8 without LP48 Card installed: Aux 1-8
RETURN Channel 29	Talkback Output
RETURN Channel 30-32	Left/Right/Center

Options

When the DS3232 is connected, there are some options that become available from the mixing console for the DS3232.

Gain: The gain of the mic preamps in the DS3232 are controlled from the mixing console. For the TT24, the console V-Pot TRIM controls become GAIN controls for the input channels using the DS3232 inputs.

Since the DS3232 mic gain control replaces the Digital Trim control on the TT24, the Digital Trim control is accessed from the V-Pots by pressing CTRL+TRIM at the same time. The V-Pots indicate mic pre gain with left to right continuously lit LEDs, and digital trim with a single lit LED.

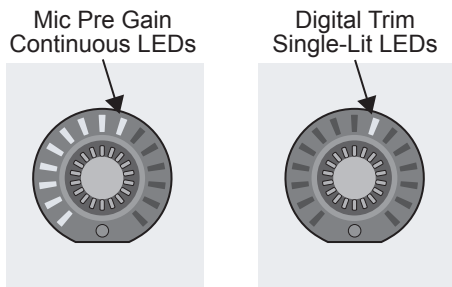

The gain for the selected channel can also be adjusted from the Overview touch screen. The Digital Trim control that is normally displayed is now replaced with a Gain knob showing a readout of the amount of gain being applied by the mic preamp. Note that the displayed value takes into account whether or not the 23 dB PAD is engaged. So what you see is what you get; no subtraction required (see, we're always striving to make your life easier!). The gain range is summarized below:

Mic IN (PAD out): +15 dB to +70 dB
 Mic IN (PAD in): -8 dB to +47 dB

The DS3232 mic gain is also adjustable by turning the channel V-Pot when "METERS" is selected in the V-Pot Control area.

48V: Each of the 32 XLR inputs on the DS3232 are equipped with 48V phantom power, which can be turned on or off for each input. In the TT24 touchscreen, the 48V phantom power button appears just below the SOLO button.

PAD: There is a 23 dB pad on each of the 32 inputs of the DS3232. Turn the pad on when using a mic with a particularly high output level, or when connecting a line-level input. In the TT24 touchscreen, the PAD indicator appears next to the GAIN control. Turn the PAD on and off by pressing either the knob for the GAIN control below the touchscreen, or the Gain V-Pot for that channel (when TRIM is selected in the V-Pot Control area). The bottom red LED in the V-Pot lights when the PAD is enabled.

Note: The Gain, Pad, and 48V phantom power can also be adjusted from the TT Control software application.

Other Nuggets of Wisdom

- For optimum sonic performance, the channel and MAIN MIX faders should be set near the "U" (unity gain) markings.
- Always turn the MAIN MIX faders, GROUP faders, and MONITOR knob down on the mixing console before making connections to and from your DS3232.
- When you power down your equipment, turn off the amplifiers first. When powering up, turn on the amplifiers last.
- Never listen to loud music for prolonged periods. Please see the Safety Instructions on page 2 for information on hearing protection.
- Save the shipping box! You may need it someday, and you don't want to have to pay for another one.

That's it for the "Getting Started" section. Next comes the "Features" section, with descriptions of every input and output. We encourage you to take the time to read all of the feature descriptions, but at least you know it's there if you have any questions.

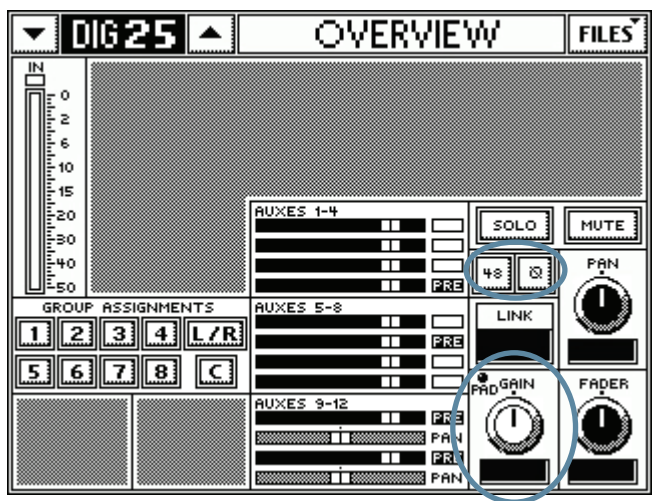
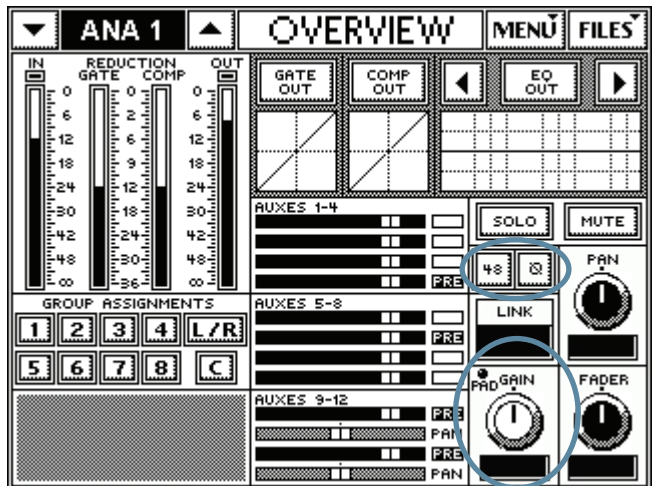

DS3232 Features

Front Panel

All the connection points (other than the power cord) are located on the front panel for easy accessibility when rack mounted.

1. Network Connection

This RJ45 connector transfers the digital audio and control data between the DS3232 and the mixing console. Use a standard Cat5e Ethernet cable to make this connection.

This is a Neutrik® EtherCon® connector that features a secure latching system when used with the Neutrik male cable carrier for preassembled RJ45 plugs.

2. POWER Indicator

This green LED lights up when the POWER switch is turned on and the linecord is attached and plugged into an AC power source.

3. COMM ✓ Indicator

This LED lights up to indicate that communication is established between the DS3232 and the mixing console via the U100 Network card.

4. INPUTS 1-32

These are female XLR connectors, which accept a balanced microphone input from almost any type of microphone. The microphone preamps feature our latest remote-controlled design, with higher fidelity and headroom rivaling most standalone mic preamps on the market today.

The XLR inputs are wired as follows:

- Pin 1 = Shield or ground
- Pin 2 = Positive (+ or hot)
- Pin 3 = Negative (– or cold)

These XLR connectors are also equipped with 48V phantom power, which can be turned on and off from the mixing console.

The routing of the 32 inputs on the DS3232 is configured by the mixing console. Generally, this will be done in the Setup window for the expansion cards where the U100 Network card is installed.

If you are connecting a line-level signal to one of the inputs, engage the PAD for that input. This reduces the input sensitivity of the mic preamp so it can accept a line-level signal. Also, make sure that phantom power isn't turned on for that channel. It could damage the output stage of the line-level device you have connected to the XLR balanced input.



Note: Phantom power should only be used with microphones designed to accept it.

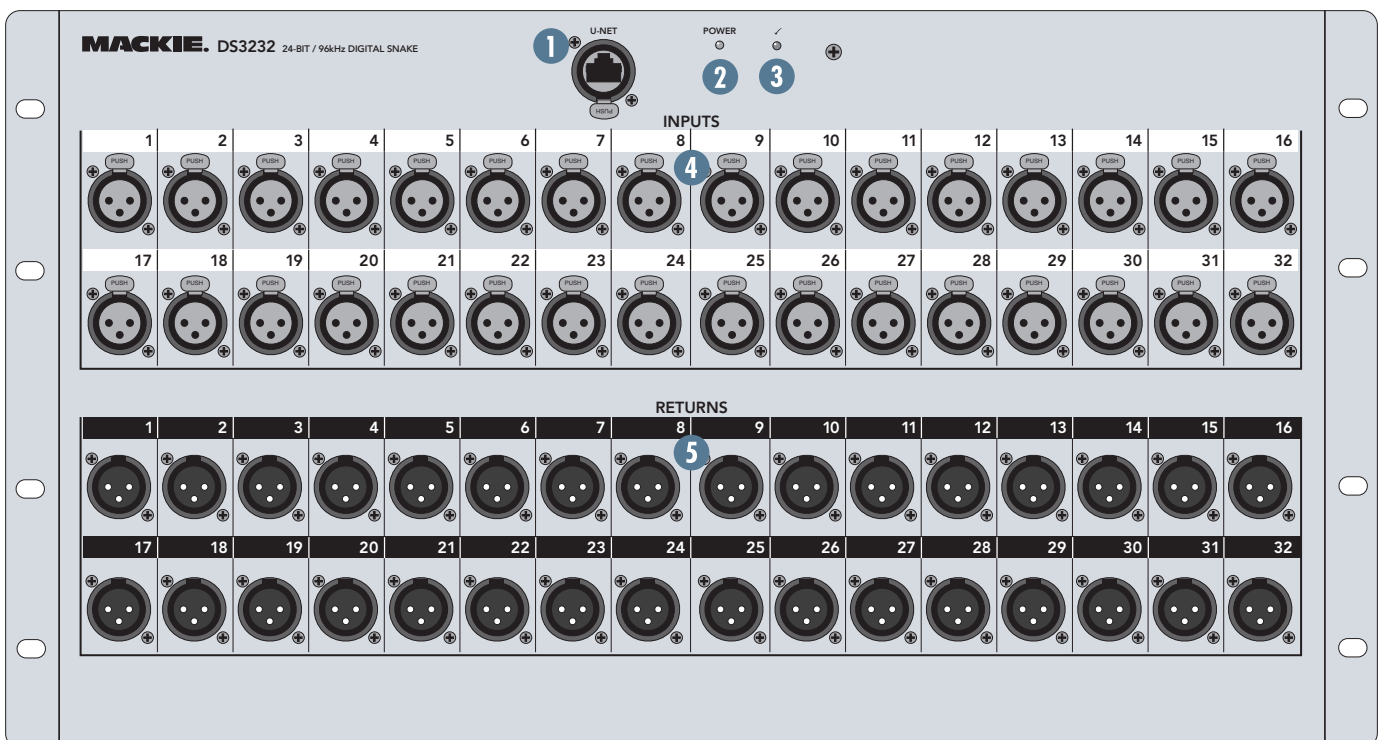

5. RETURNS 1-32

These are male XLR connectors that provide balanced line-level signals.

The XLR outputs are wired as follows:

- Pin 1 = Shield or ground
- Pin 2 = Positive (+ or hot)
- Pin 3 = Negative (– or cold)

Like the inputs, the routing for the 32 returns on the DS3232 is configured by the mixing console. Generally, this will be done in the Setup window for the expansion cards where the U100 Network card is installed. In the case of the TT24, there is no configuration required for the returns.

Rear Panel

All the connection points (other than the power cord) are located on the front panel for easy accessibility when rack mounted.

6. POWER Switch

This one is self-explanatory. When the POWER switch is turned ON, power is supplied to the DS3232 and the POWER LED on the front panel lights up.

Press the bottom of this switch to put the DS3232 into standby mode. It will not function, but the circuits are still live. To remove AC power, either turn off the AC mains supply, or unplug the power cord from the DS3232 and the AC mains supply.

7. POWER Receptacle

This is a standard 3-prong IEC power connector. Connect the detachable linecord (included in the box with your DS3232) to the power receptacle, and plug the other end of the linecord into an AC outlet. The DS3232 has a universal power supply that can accept any AC voltage ranging from 100 VAC to 240 VAC. No need for voltage select switches. It will work virtually anywhere in the world. That's why we call it a "Planet-Earth" power supply! This also means that it is less susceptible to voltage sags or spikes, providing greater electromagnetic isolation and better protection against AC line noise.

8. Fan

The DS3232 is fan-cooled and brings air in through the sides and out through the rear. Make sure that cool air is available at the sides of the unit, and that there is room at the rear for the warm air to exit from the enclosure and dissipate. If rack-mounted, make sure the DS3232 is not pulling warm (or hot) air in from the rack, and that the sides and rear are not obstructed.

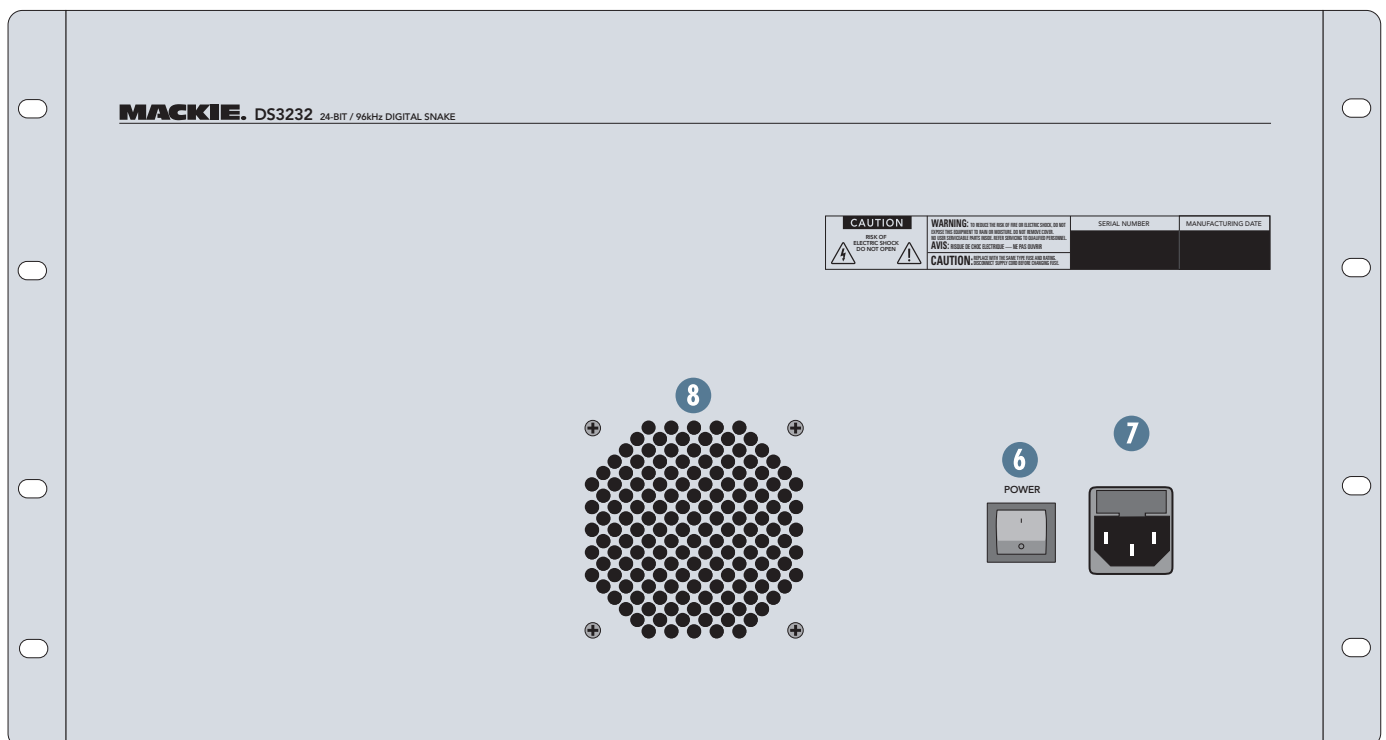

Appendix A: Service Information

If you think your Mackie product has a problem, please check out the following troubleshooting tips and do your best to confirm the problem. Visit the Support section of our website (www.mackie.com/support) where you will find lots of useful information such as FAQs, documentation, and user forums. You may find the answer to the problem without having to send your Mackie product away.

Troubleshooting

No Power

- Our favorite question: Is it plugged in?
- Make sure the power cord is securely seated in the IEC socket [7] and plugged all the way into the AC outlet.
- Make sure the AC outlet is live (check with a tester or lamp).
- Is the POWER [6] switch on? Make sure the POWER switch on the rear panel is in the ON position (up).
- Is the POWER LED [2] on the front panel illuminated? If not, make sure the AC outlet is live.
- Are all the lights out in your building? If so, contact your local power company to get power restored.
- If the POWER LED is not illuminated, and you are certain that the AC outlet is live, it will be necessary to have your DS3232 serviced. *There are no user serviceable parts inside.* Refer to “Repair” at the end of this section to find out how to proceed.

No COMM ✓ Indication

- Are the power switches on the mixer and the DS3232 turned on?
- Verify that the Cat5e cable is working properly. Replace with a known working cable, if possible.
- Does the Snake appear in the Expansion Slot Setup Screen? If not, check to see that the U100 card is properly seated in the expansion slot.
- Try putting the U100 card in another slot (be sure to turn everything off before removing and replacing the card).

- Is the fan running and unobstructed so it can circulate air through the DS3232? If the DS3232 feels hot to the touch, power off the unit for a few minutes to allow it to cool. Turn the unit back on and, if communication is restored, provide better ventilation so cool air is available to the DS3232.

No Input

- Is the mixing console properly configured to accept the input signals from the DS3232? Make sure the inputs for the mixing console have been setup to accept the 32 input signals from the DS3232.
- Is the input GAIN control for the channel turned up on the mixing console?
- Is the fader turned up?
- Is the signal source turned up? Make sure the signal level from the selected input source is high enough to light up some of the INPUT meter LEDs.
- Try the same source signal in another channel, set up exactly like the suspect channel.

No Output

- Is the associated level control (if any) turned up?
- Try switching the outputs around. For example, for the left and right outputs, if the left output is presumed dead, switch the left and right cords at the DS3232 end. If the problem stays on the left side, it's not the DS3232.

Bad Sound

- Is the input connector plugged completely into the jack?
- Is it loud and distorted? Make sure the input GAIN control for that channel is set correctly. Try enabling the PAD, or reduce the signal level on the input source if possible.
- If possible, listen to the signal with headphones plugged into the input source device. If it sounds bad there, it's not the DS3232 causing the problem.

Repair

For warranty repair or replacement, refer to the warranty information on page 15.

Non-warranty repair for Mackie products is available at a factory-authorized service center. To locate your nearest service center, visit www.mackie.com, click “Support” and select “Locate a Service Center.” Service for Mackie products living outside the United States can be obtained through local dealers or distributors.

If you do not have access to our website, you can call our Tech Support department at 1-800-898-3211, Monday-Friday, during normal business hours, Pacific Time, to explain the problem. Tech Support will tell you where the nearest factory-authorized service center is located in your area.

Need Help?

- **Visit www.mackie.com and click Support to find: FAQs (Frequently Asked Questions), manuals, addendums, and user forums.**
- **Email us at: techmail@mackie.com.**
- **Telephone 1-800-898-3211 to speak with one of our splendid technical support representatives (Monday through Friday, normal business hours, PST).**



Appendix B: Technical Info

DS3232 Specifications

Frequency Response

Mic Input to Digital Output (@ 96 kHz SR)
+0, -0.1 dB, 20 Hz to 24 kHz

Distortion (THD)

Mic Input to Digital Output (@ 96 kHz SR)
THD: < 0.003%, -10 dBu input,
mic pre gain at -3 dB FS output

Dynamic Range

105.0 dB A-weighted (ADC) typical
112.5 dB A-weighted (DAC) typical

Noise Floor

Equivalent Input Noise (E.I.N.), 20 Hz to 20 kHz Bandwidth,
150Ω source impedance
-128.5 dBu @ +45 dB mic pre gain

Residual Output Noise:
Digital Out: < -112.5 dB FS

Converters

24-bit @ 96 kHz

Round Trip Latency

Mic In to Return Out: < 5.0 ms @ 48 kHz SR
< 2.2 ms @ 96 kHz SR

Common Mode Rejection Ratio (CMRR)

Mic In: >75 dB @ 1 kHz, Gain @ maximum

Crosstalk

Adjacent Inputs: < -90 dB @ 1 kHz, +22 dBu on adjacent
input, 150Ω source impedance

Input Gain Control Range

Mic In (PAD out): +15 dB to +70 dB (in 1 dB increments)
Mic In (PAD in): -8 dB to + 47 dB (in 1 dB increments)

Phantom Power

+48 VDC

Maximum Input Levels

Mic Input (PAD out): +7 dBu, Gain @ 15 dB
Mic Input (PAD in): +30 dBu, Gain @ -8 dB

Input Impedance

Mic Input (PAD out): 1.5 kΩ, balanced
Mic Input (PAD in): 3.1 kΩ, balanced

Output Impedance

Returns Out: servo-balanced, 51 Ω per side, XLR outputs

AC Power Requirements

Power Consumption: 80 watts
Universal AC Power Supply:
100 VAC – 240 VAC, 50-60 Hz
Operating Temperature:
0°C – 40°C (50°F – 104°F)

Physical Dimensions and Weight

Height: 10.2 in/26.0 cm (6 RU)
Width: 19.0 in/48.3 cm
Depth: 9.0 in/23.0 cm
Weight: 20.5 lb/9.3 kg

LOUD Technologies Inc. is always striving to improve our products by incorporating new and improved materials, components, and manufacturing methods. Therefore, we reserve the right to change these specifications at any time without notice.

“Mackie.” and the “Running Man” are registered trademarks of LOUD Technologies Inc. All other brand names mentioned are trademarks or registered trademarks of their respective holders, and are hereby acknowledged.

©2007-2012 LOUD Technologies Inc. All Rights Reserved.

DS3232 Dimensions

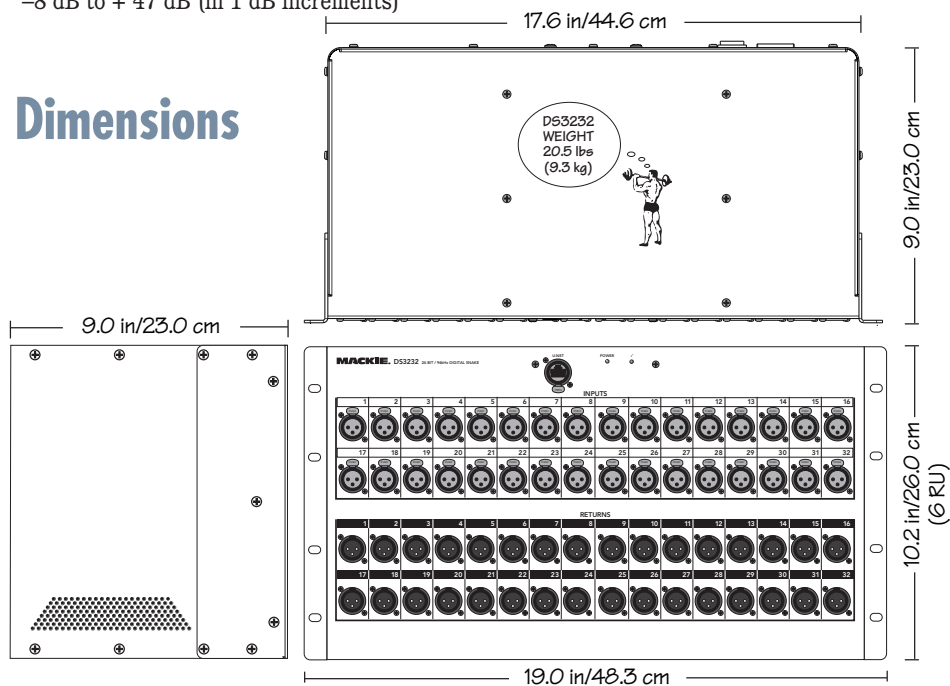

DS3232 Block Diagram

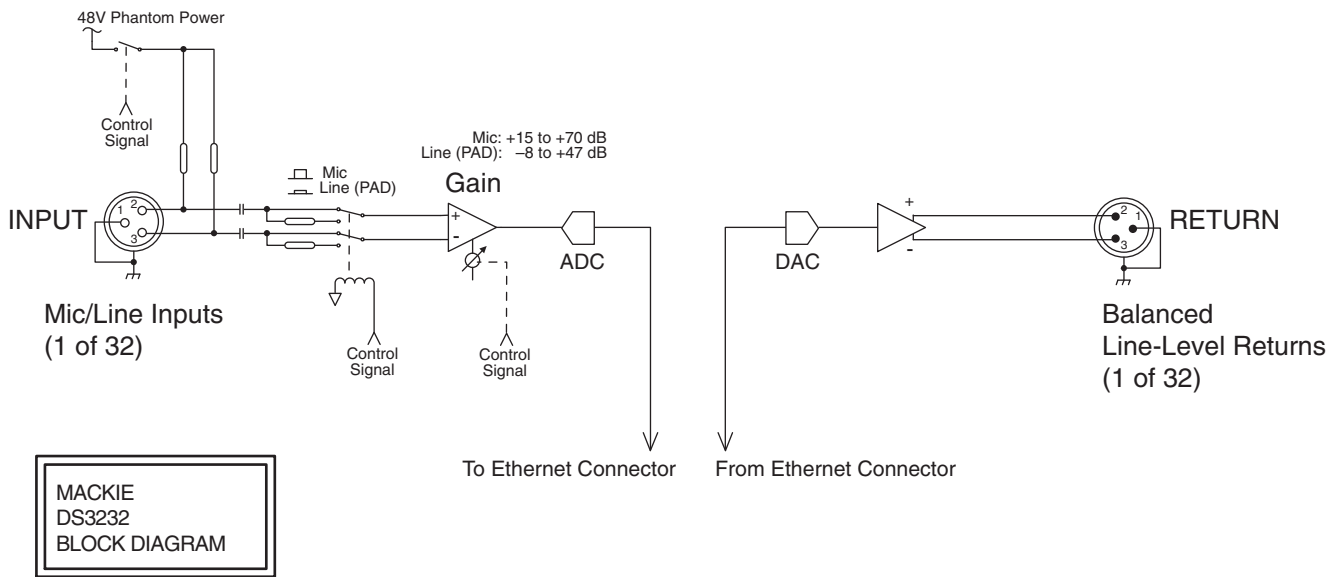

TT24 ADAT Outputs

When the DS3232 is used with the TT24, the ADAT outputs follow whatever channels have the internal processing assigned to them, analog or digital.

To select the internal DSP assignment, press Setup, select Operation, and choose analog or digital for the Input DSP.

The following table shows how the ADAT outputs are affected with and without the DS3232 connected.

Snake Bank Assignment	Input DSP Assignment	ADAT Output
Analog	Analog	Snake 1-24
Analog	Digital	Digital 25-48
Digital	Analog	Analog 1-24
Digital	Digital	Snake 1-24
None	Analog	Analog 1-24
None	Digital	Digital 25-48

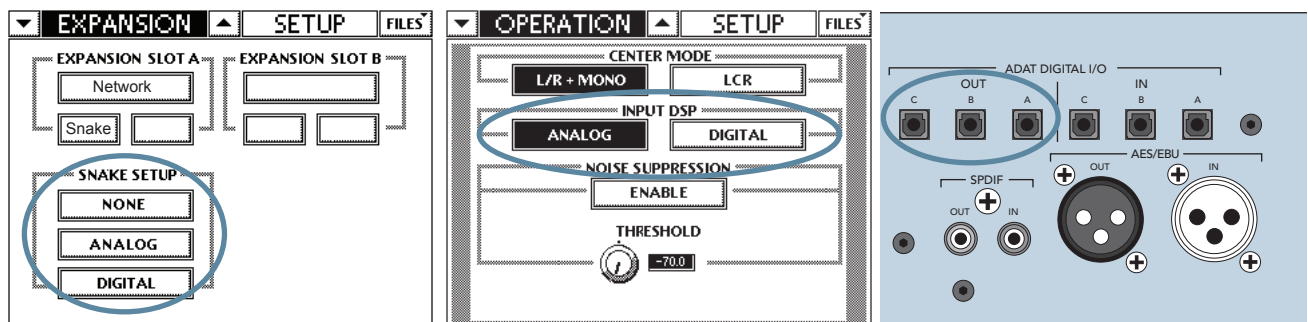

Input and Output Wiring

Use a high-quality 3-conductor shielded cable to connect the signal to and from the balanced inputs and outputs on the DS3232. If you're making an unbalanced connection, use a high-quality 2-conductor shielded cable. Your Mackie Dealer can recommend a suitable cable for your application.

When connecting a balanced signal using XLR plugs, they're wired thusly, per AES (Audio Engineering Society) standards:

- Pin 2 = Hot (+)
- Pin 3 = Cold (-)
- Pin 1 = Shield (Ground)

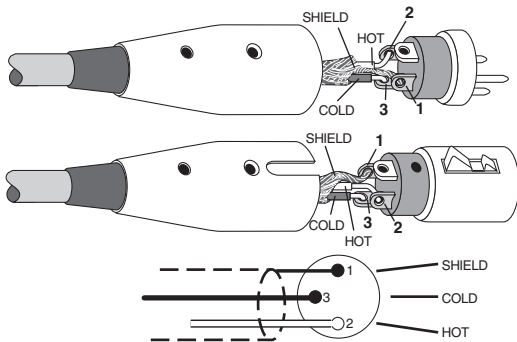

Balanced XLR Connectors

RJ45 Wiring

The RJ45 connector on the DS3232 uses a standard Cat5e Ethernet cable to make the connection between the DS3232 and the U100 Network card installed in the mixing console. A Cat5e cable offers improved performance over a Cat5 cable, including a higher bandwidth (350 MHz vs. 100 MHz for a standard Cat5 cable).

Make sure you use a straight-through cable, and not a crossover Ethernet cable.

The RJ45 connector is wired as follows:

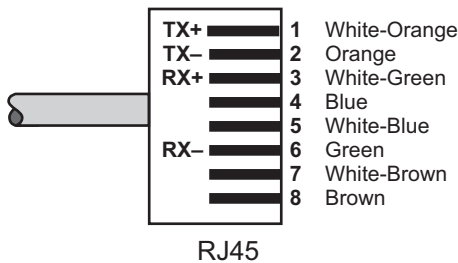

RJ45 Connector

Appendix C: Hookup Diagram

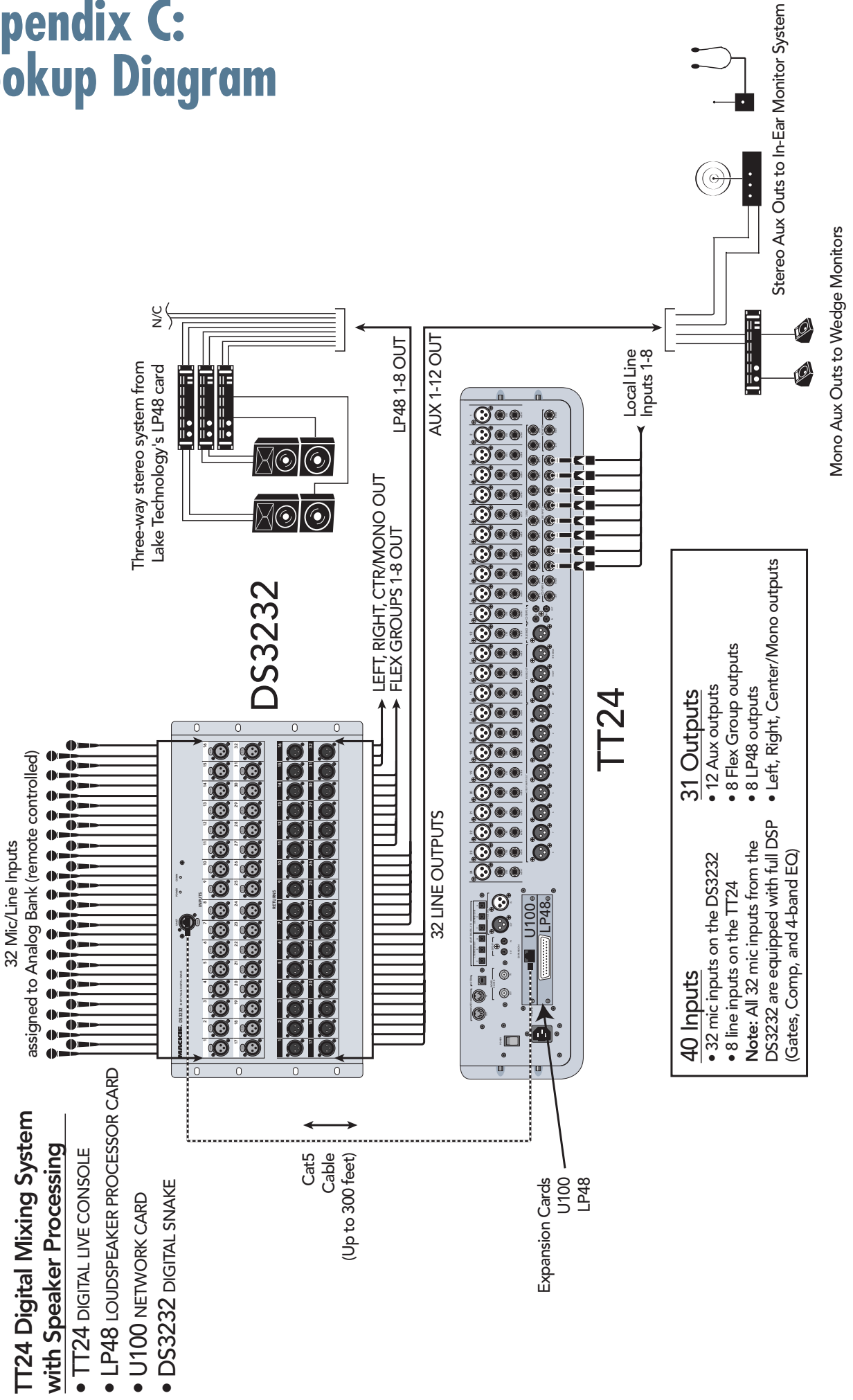

DS3232 Limited Warranty

Please keep your sales receipt in a safe place.

This Limited Product Warranty ("Product Warranty") is provided by LOUD Technologies Inc. ("LOUD") and is applicable to products purchased in the United States or Canada through a LOUD-authorized reseller or dealer. The Product Warranty will not extend to anyone other than the original purchaser of the product (hereinafter, "Customer," "you" or "your").

For products purchased outside the U.S. or Canada, please visit www.mackie.com/warranty to find contact information for your local distributor, and information on any warranty coverage provided by the distributor in your local market.

LOUD warrants to Customer that the product will be free from defects in materials and workmanship under normal use during the Warranty Period. If the product fails to conform to the warranty then LOUD or its authorized service representative will at its option, either repair or replace any such nonconforming product, provided that Customer gives notice of the noncompliance within the Warranty Period to the Company at: www.mackie.com/support or by calling LOUD technical support at 1.800.898.3211 (toll-free in the U.S. and Canada) during normal business hours Pacific Time, excluding weekends or LOUD holidays. Please retain the original dated sales receipt as evidence of the date of purchase. You will need it to obtain any warranty service.

For full terms and conditions, as well as the specific duration of the Warranty for this product, please visit www.mackie.com/warranty.

The Product Warranty, together with your invoice or receipt, and the terms and conditions located at www.mackie.com/warranty constitutes the entire agreement, and supersedes any and all prior agreements between LOUD and Customer related to the subject matter hereof. No amendment, modification or waiver of any of the provisions of this Product Warranty will be valid unless set forth in a written instrument signed by the party to be bound thereby.

MACKIE®

16220 Wood-Red Road NE • Woodinville, WA 98072 • USA
www.mackie.com • sales@mackie.com

United States and Canada: 800.898.3211
Fax: 425.487.4337

Europe, Asia, Central and South America: 425.487.4333
Middle East and Africa: 31.20.654.4000