

1202-VLZ3

12-Channel Mic/Line Mixer

OWNER'S MANUAL

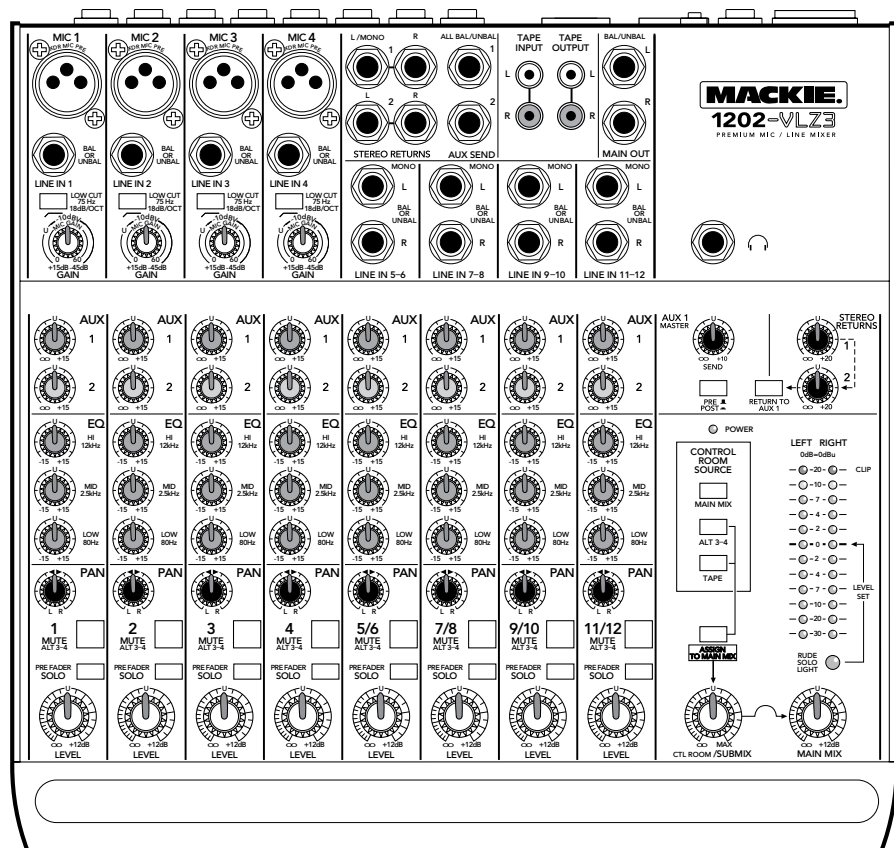
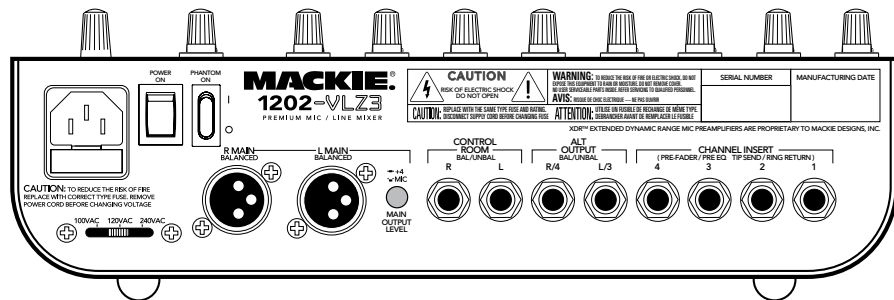

MACKIE®

Important Safety Instructions

1. Read these instructions.
2. Keep these instructions.
3. Heed all warnings.
4. Follow all instructions.
5. Do not use this apparatus near water.
6. Clean only with a dry cloth.
7. Do not block any ventilation openings. Install in accordance with the manufacturer's instructions.
8. Do not install near any heat sources such as radiators, heat registers, stoves, or other apparatus (including amplifiers) that produce heat.
9. Do not defeat the safety purpose of the polarized or grounding-type plug. A polarized plug has two blades with one wider than the other. A grounding-type plug has two blades and a third grounding prong. The wide blade or the third prong are provided for your safety. If the provided plug does not fit into your outlet, consult an electrician for replacement of the obsolete outlet.
10. Do not overload wall outlets and extension cords as this can result in a risk of fire or electric shock.
11. Protect the power cord from being walked on or pinched particularly at plugs, convenience receptacles, and the point where they exit from the apparatus.
12. Only use attachments/accessories specified by the manufacturer.
13. Use only with a cart, stand, tripod, bracket, or table specified by the manufacturer, or sold with the apparatus. When a cart is used, use caution when moving the cart/apparatus combination to avoid injury from tip-over.
14. Unplug this apparatus during lightning storms or when unused for long periods of time.
15. Refer all servicing to qualified service personnel. Servicing is required when the apparatus has been damaged in any way, such as power-supply cord or plug is damaged, liquid has been spilled or objects have fallen into the apparatus, the apparatus has been exposed to rain or moisture, does not operate normally, or has been dropped.
16. This apparatus shall not be exposed to dripping or splashing, and no object filled with liquids, such as vases or beer glasses, shall be placed on the apparatus.
17. This apparatus has been designed with Class-I construction and must be connected to a mains socket outlet with a protective earthing connection (the third grounding prong).
18. This apparatus has been equipped with a rocker-style AC mains power switch. This switch is located on the rear panel and should remain readily accessible to the user.
19. The MAINS plug or an appliance coupler is used as the disconnect device, so the disconnect device shall remain readily operable.



- 20. NOTE:** This equipment has been tested and found to comply with the limits for a Class B digital device, pursuant to part 15 of the FCC Rules. These limits are designed to provide reasonable protection against harmful interference in a residential installation. This equipment generates, uses, and can radiate radio frequency energy and, if not installed and used in accordance with the instructions, may cause harmful interference to radio communications. However, there is no guarantee that interference will not occur in a particular installation. If this equipment does cause harmful interference to radio or television reception, which can be determined by turning the equipment off and on, the user is encouraged to try to correct the interference by one or more of the following measures:



- Reorient or relocate the receiving antenna.
- Increase the separation between the equipment and the receiver.
- Connect the equipment into an outlet on a circuit different from that to which the receiver is connected.
- Consult the dealer or an experienced radio/TV technician for help.

CAUTION: Changes or modifications to this device not expressly approved by LOUD Technologies Inc. could void the user's authority to operate the equipment under FCC rules.

- 21.** This apparatus does not exceed the Class A/Class B (whichever is applicable) limits for radio noise emissions from digital apparatus as set out in the radio interference regulations of the Canadian Department of Communications.

ATTENTION — *Le présent appareil numérique n'émet pas de bruits radioélectriques dépassant les limites applicables aux appareils numériques de class A/de class B (selon le cas) prescrites dans le règlement sur le brouillage radioélectrique édicté par les ministere des communications du Canada.*

- 22.** Exposure to extremely high noise levels may cause permanent hearing loss. Individuals vary considerably in susceptibility to noise-induced hearing loss, but nearly everyone will lose some hearing if exposed to sufficiently intense noise for a period of time. The U.S. Government's Occupational Safety and Health Administration (OSHA) has specified the permissible noise level exposures shown in the following chart. According to OSHA, any exposure in excess of these permissible limits could result in some hearing loss. To ensure against potentially dangerous exposure to high sound pressure levels, it is recommended that all persons exposed to equipment capable of producing high sound pressure levels use hearing protectors while the equipment is in operation. Ear plugs or protectors in the ear canals or over the ears must be worn when operating the equipment in order to prevent permanent hearing loss if exposure is in excess of the limits set forth here:

	CAUTION AVIS	
RISK OF ELECTRIC SHOCK. DO NOT OPEN RISQUE DE CHOC ELECTRIQUE. NE PAS OUVRIR		
CAUTION: TO REDUCE THE RISK OF ELECTRIC SHOCK DO NOT REMOVE COVER (OR BACK) NO USER-SERVICEABLE PARTS INSIDE. REFER SERVICING TO QUALIFIED PERSONNEL ATTENTION: POUR EVITER LES RISQUES DE CHOC ELECTRIQUE, NE PAS ENLEVER LE COUVERCLE. AUCUN ENTRETIEN DE PIECES INTERIEURES PAR L'USAGER. CONFIER L'ENTRETIEN AU PERSONNEL QUALIFIE. AVIS: POUR EVITER LES RISQUES D'INCENDIE OU D'ELECTROCUTION, N'EXPOSEZ PAS CET ARTICLE A LA PLUIE OU A L'HUMIDITE		



The lightning flash with arrowhead symbol within an equilateral triangle is intended to alert the user to the presence of uninsulated "dangerous voltage" within the product's enclosure, that may be of sufficient magnitude to constitute a risk of electric shock to persons.
Le symbole éclair avec point de flèche à l'intérieur d'un triangle équilatéral est utilisé pour alerter l'utilisateur de la présence à l'intérieur du coffret de "voltage dangereux" non isolé d'ampleur suffisante pour constituer un risque d'électrocution.



The exclamation point within an equilateral triangle is intended to alert the user of the presence of important operating and maintenance (servicing) instructions in the literature accompanying the appliance.
Le point d'exclamation à l'intérieur d'un triangle équilatéral est employé pour alerter les utilisateurs de la présence d'instructions importantes pour le fonctionnement et l'entretien (service) dans le livret d'instruction accompagnant l'appareil.

Duration, per day in hours	Sound Level dBA, Slow Response	Typical Example
8	90	Duo in small club
6	92	
4	95	Subway Train
3	97	
2	100	Very loud classical music
1.5	102	
1	105	Dave screaming at Steve about deadlines
0.5	110	
0.25 or less	115	Loudest parts at a rock concert

WARNING — To reduce the risk of fire or electric shock, do not expose this apparatus to rain or moisture.



Correct disposal of this product. This symbol indicates that this product should not be disposed of with your household waste, according to the WEEE Directive (2002/96/EC) and your national law. This product should be handed over to an authorized collection site for recycling waste electrical and electronic equipment (WEEE). Improper handling of this type of waste could have a possible negative impact on the environment and human health due to potentially hazardous substances that are generally associated with WEEE. At the same time, your cooperation in the correct disposal of this product will contribute to the effective usage of natural resources. For more information about where you can drop off your waste equipment for recycling, please contact your local city office, waste authority, or your household waste disposal service.

Read This Page!



We realize that you must be wanting to try out your new 1202-VLZ3. All we ask is that you read this page NOW, and the rest can wait until you're good and ready. But do read it — you'll be glad you did.



WARNING: Before you plug the AC power cord into the mixer, make sure the VOLTAGE SELECTOR switch is set to the same voltage as your local AC mains supply (see page 12).

Level-Setting Procedure

Message to seasoned pros: do not set levels using the old “Turn the GAIN up until the clip light comes on, then back off a hair” trick. When a Mackie mixer clip light comes on, you really are about to clip. We worked and slaved to come up with a better system, one that provides low noise and high headroom.

Adjusting input levels (Chs. 1–4 only)

On the first four channels, it's not even necessary to hear what you're doing to set optimal levels. But if you'd like to: Plug headphones into the PHONES jack, then set the CONTROL ROOM/SUBMIX knob about one-quarter of the way up.

The following steps must be performed one channel at a time:

1. Turn the GAIN, LEVEL and AUX send knobs fully down (counterclockwise).
2. Set the EQ knobs at the center detent.
3. Connect the signal source to the input.
4. Engage (push in) the SOLO switch.
5. Play something into the selected input. This could be an instrument, a singing or speaking voice, or a line input such as a CD player or tape recorder output. Be sure that the volume of the input is the same as it would be during normal use. If it isn't, you might have to readjust these levels during the middle of the set.
6. Adjust the channel's GAIN control so that the display on the right LED meter stays around “0” and never goes higher than “+7.”
7. If you'd like to apply some EQ, do so now and return to step 6.
8. Disengage that channel's SOLO switch.
9. Repeat for each of channels 1 through 4.

Other Nuggets of Wisdom

For optimum sonic performance, the channel LEVEL knobs and the MAIN MIX knob should be set near the “U” (unity gain) markings.

Always turn the MAIN MIX and CONTROL ROOM/SUBMIX level controls down before making connections to and from your 1202-VLZ3.

If you shut down your equipment, turn off your amplifier or powered speakers first. When powering up, turn them on last.

Save the shipping box! You may need it someday.

Instant Mixing

Here's how to get going right away, assuming you have a microphone and a keyboard:

1. Plug your microphone into channel 1's MIC input.
2. Turn on the 1202-VLZ3.
3. Perform the Level-Setting Procedure.
4. Connect cords from the MAIN OUTS (XLR, 1/4" or RCA, your choice) to your amplifier.
5. Hook up speakers to the amp and turn it on.
6. Turn up the 1202-VLZ3's channel 1 LEVEL knob to the center detent and the MAIN MIX knob one quarter of the way up.
7. Sing like a canary!
8. Plug your keyboard into stereo channel 5-6.
9. Turn that channel's LEVEL knob to the center detent.
10. Play like a madman and sing like a canary!
It's your first mix!

Please write your serial number here for future reference (i.e., insurance claims, tech support, return authorization, make dad proud, etc.)

Purchased at:

Date of purchase:

Introduction

Thank you for choosing a Mackie professional compact mixer. The 1202-VLZ3 is equipped with our precision-engineered XDR™ Extended Dynamic Range premium studio-grade mic preamp.

Now that you have your 1202-VLZ3, find out how to get the most from it. That's where this manual comes in.

How To Use This Manual

Since many of you folks will want to hook up your 1202-VLZ3 immediately, the first pages you will encounter after the table of contents are the ever-popular hookup diagrams. These show typical mixer setups for Record/Mixdown, and Stereo PA.

After this section is a detailed tour of the entire mixer. Every feature of the 1202-VLZ3 is described “geographically,” in other words, in order of where it is physically placed on the mixer’s top or rear panel. These descriptions are divided into the first three sections, just as your mixer is organized into three distinct zones:

Patchbay: The patchbay along the top and back, where you connect things.

Channel Strip: The eight channel strips where you adjust each channel.

Output Section: The output section on the right.

Throughout these sections you’ll find illustrations, with each feature numbered. If you’re curious about a feature, simply locate it on the appropriate illustration, notice the number attached to it, and find that number in the nearby paragraphs.



This icon marks information that is critically important or unique to the 1202-VLZ3. For your own good, read them and remember them. They will be on the final test.



This icon will lead you to in-depth explanations of features and practical tips. While not mandatory, they usually have some valuable nuggets of information.

Appendix A is a section on troubleshooting and repair information.

Appendix B is a section on connectors: XLR connectors, TRS balanced connectors, TS unbalanced connectors, and Insert connectors.

Appendix C shows the technical specifications, and a block diagram showing the internal signal path and general goings-on within the mixer.

Need help with your new mixer?

- **Visit www.mackie.com and click Support to find: FAQs (Frequently Asked Questions), manuals, and addendums.**
- **Email us at: techmail@mackie.com.**
- **Telephone 1-800-898-3211 to speak with one of our splendid technical support representatives, (Monday through Friday, during normal business hours, PST).**

Contents

IMPORTANT SAFETY INSTRUCTIONS	2	OUTPUT SECTION.....	16
READ THIS PAGE!.....	3	32. MAIN MIX	16
INTRODUCTION	4	33. CONTROL ROOM SOURCE MATRIX.....	16
HOOKUP DIAGRAMS.....	6	34. CONTROL ROOM/SUBMIX	16
PATCHBAY DESCRIPTION	8	A WORD ABOUT PRE-FADER SOLO (PFL)	17
1. MIC INPUTS (CHANNELS 1–4).....	8	35. RUDE SOLO LIGHT.....	17
2. LINE INPUTS (CHANNELS 1–4).....	8	36. ASSIGN TO MAIN MIX.....	17
3. LOW CUT (CHANNELS 1–4).....	9	37. METERS – MANY DISPLAYS IN ONE!	17
4. GAIN (CHANNELS 1–4)	9	38. PRE OR POST (AUX 1)	18
5. STEREO LINE INPUTS	9	39. AUX 1 MASTER	18
6. IMAGINARY CONTROL	9	40. STEREO RETURNS.....	18
EFFECTS: SERIAL OR PARALLEL?	9	41. RETURN TO AUX 1	19
7. STEREO RETURNS.....	10	JACK NORMALLING.....	19
8. AUX SEND 1&2.....	10	APPENDIX A: SERVICE INFORMATION	20
9. TAPE INPUT	10	APPENDIX B: CONNECTIONS.....	21
10. TAPE OUTPUT	10	APPENDIX C: TECHNICAL INFORMATION	24
11. ¼" MAIN OUTS	10	SPECIFICATIONS	24
12. PHONES	11	BLOCK DIAGRAM.....	25
13. XLR MAIN OUTS	11	TRACK SHEET.....	26
14. XLR MAIN OUTPUT LEVEL SWITCH.....	11	1202-VLZ3 LIMITED WARRANTY.....	27
15. CONTROL ROOM.....	11		
16. ALT 3–4 OUTPUT	11		
17. CHANNEL INSERT (CHANNELS 1–4).....	11		
18. POWER CONNECTION.....	12		
19. FUSE.....	12		
20. VOLTAGE SELECTOR.....	12		
21. POWER SWITCH.....	12		
22. PHANTOM SWITCH	12		
CHANNEL STRIP DESCRIPTION.....	13		
"U" LIKE UNITY GAIN	13		
23. LEVEL	13		
24. PRE-FADER SOLO	13		
25. MUTE/ALT 3–4	13		
26. PAN.....	14		
CONSTANT LOUDNESS !!!.....	14		
3-BAND EQ	14		
27. LOW EQ.....	14		
28. MID EQ.....	14		
29. HI EQ.....	15		
MODERATION DURING EQ	15		
30. AUX 2 SEND	15		
31. AUX 1 SEND	15		

Hookup Diagrams

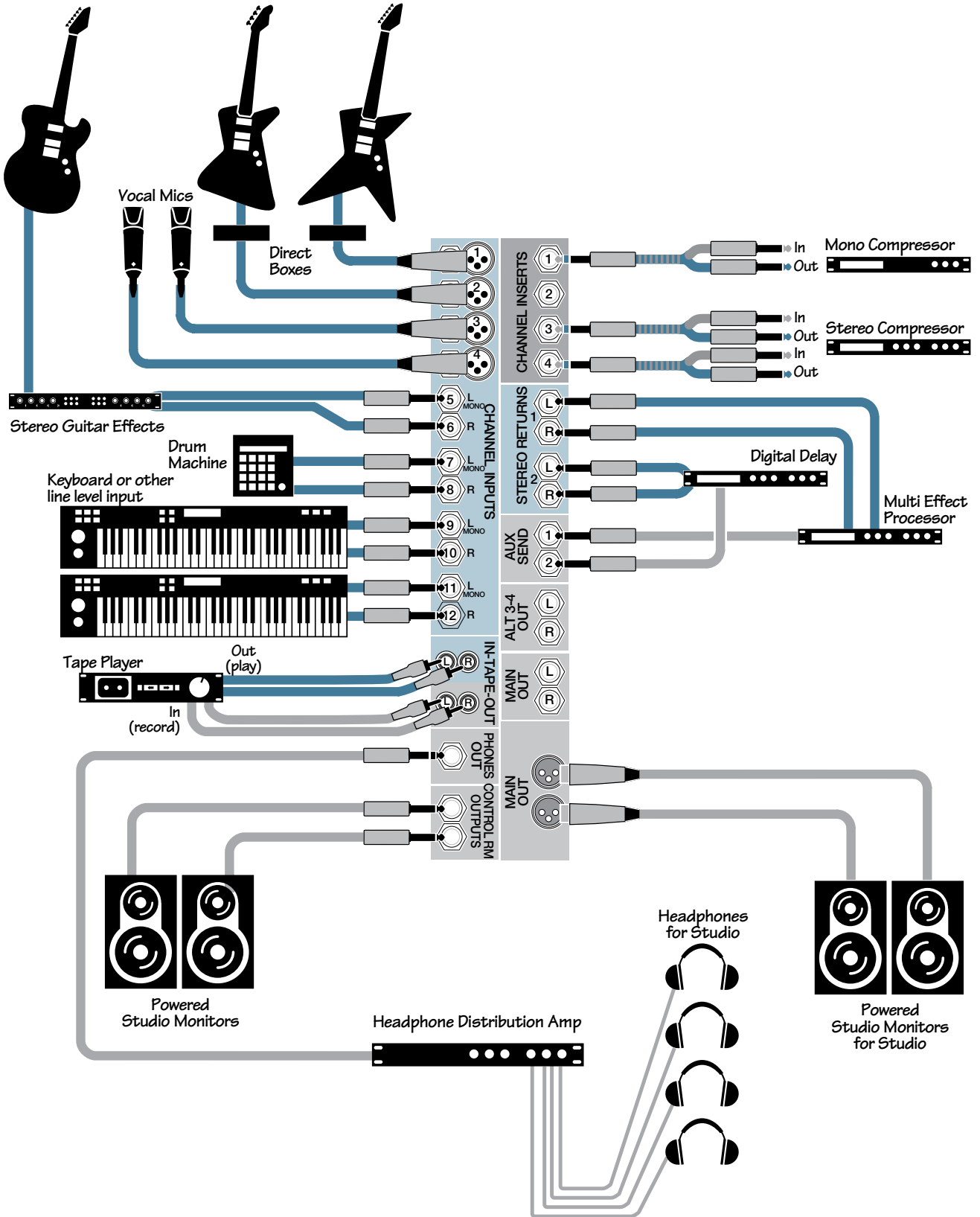

Recording System

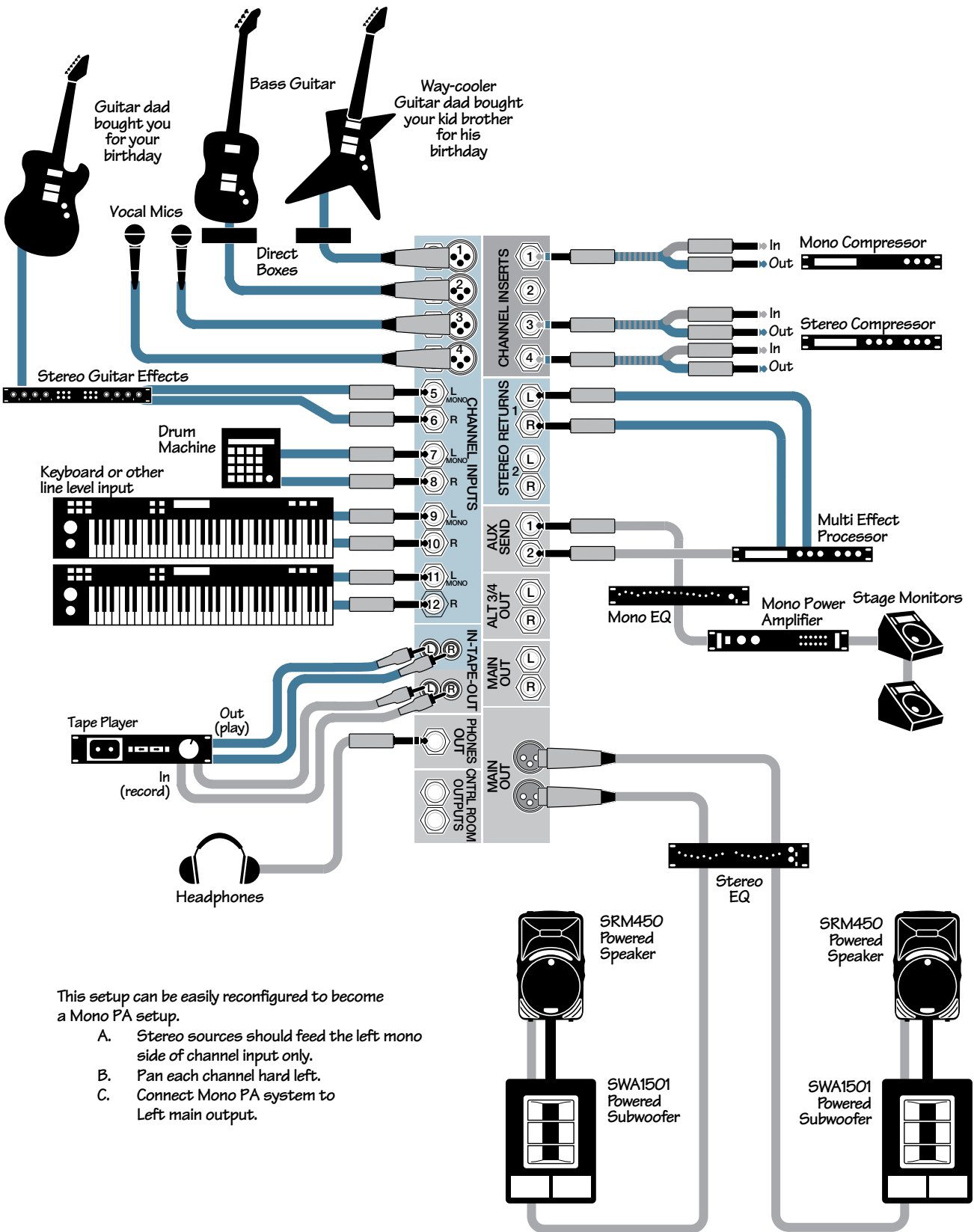

This setup can be easily reconfigured to become a Mono PA setup.

- A. Stereo sources should feed the left mono side of channel input only.
- B. Pan each channel hard left.
- C. Connect Mono PA system to Left main output.

Live Stereo PA System

Patchbay Description

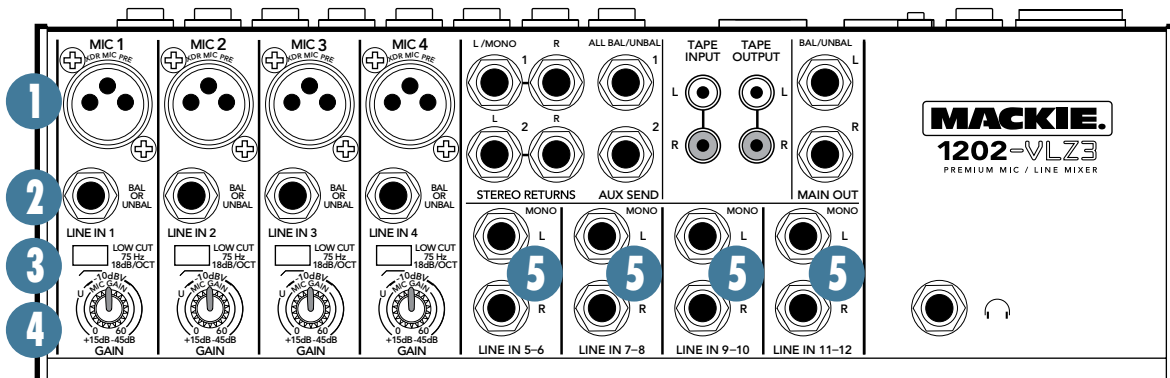

At the risk of stating the obvious, this is where you plug everything in: microphones, line-level instruments and effects, headphones, and the ultimate destination for your sound: a tape recorder, PA system, etc.

See Appendix B for further details and drawings of the connectors you can use with the 1202-VLZ3. Also see the Channel Strip description on page 13 for details of the signal routing from the XLR and Line inputs.

1. MIC INPUTS (Channels 1–4)

We use phantom-powered, balanced microphone inputs just like the big studio mega-consoles, for exactly the same reason: This kind of circuit is excellent at rejecting hum and noise. You can plug in almost any kind of mic that has a standard XLR male mic connector.

Professional ribbon, dynamic, and condenser mics will all sound excellent through these inputs. The 1202-VLZ3's mic inputs will handle any kind of mic level you can toss at them, without overloading. Be sure to perform the Level-Setting Procedure on page 3.

Not every instrument is made to connect directly to a mixer. Guitars commonly need a Direct Injection (DI) box to connect to the mixer's MIC inputs. These boxes convert unbalanced line-level signals from your guitar, into balanced mic-level outputs, and provide signal and impedance matching. They also let you send your gifted guitar renditions over long cables or audio snakes, with minimum interference and high-frequency signal loss. Ask your dealer or guitar maker about their recommendations for a good DI box.

PHANTOM POWER

Most modern professional condenser mics are equipped for phantom power, which lets the mixer send low-current DC voltage to the mic's electronics through the same wires that carry audio. (Semi-pro condenser mics often have batteries to accomplish the same thing.) “Phantom” owes its name to an ability to be “unseen” by dynamic mics (Shure SM57/SM58, for instance), which don't need external power and aren't affected by it anyway.

The 1202-VLZ3's phantom power is globally controlled by the PHANTOM [22] switch on the rear panel. (This means the phantom power for channels 1-4 is turned on and off together.)



Never plug single-ended (unbalanced) microphones or instruments into the MIC [1] input jacks if the phantom power is on.



Do not plug instrument outputs into the MIC input jacks with phantom power on, unless you know for certain it is safe to do so.

2. LINE INPUTS (Channels 1–4)

These four line-inputs share circuitry (but not phantom power) with the mic preamps, and can be driven by balanced or unbalanced sources at almost any level. You can use these inputs for virtually any signal you'll come across, from instrument levels as low as -40 dB to operating levels of -10 dBV to $+4$ dBu, since there is 40 dB more gain available than on channels 5–12.

To connect balanced lines to these inputs, use a 1/4" Tip-Ring-Sleeve (TRS) plug, the type found on stereo headphones.

To connect unbalanced lines to these inputs, use a 1/4" mono (TS) phone plug or standard instrument cable.

The LINE IN inputs 1–4 are a good place to connect older instruments that need more gain. You can correct weak levels by adjusting the corresponding channel's GAIN control.

3. LOW CUT (Channels 1–4)

Each LOW CUT switch, often referred to as a High Pass Filter (all depends on how you look at it), cuts bass frequencies below 75 Hz at a rate of 18 dB per octave.

We recommend that you use low-cut on every microphone application except kick drum, bass guitar, or bassy synth patches. These aside, there isn't much down there that you want to hear, and filtering it out makes the low stuff you do want much more crisp and tasty. Not only that, but low-cut can help reduce the possibility of feedback in live situations, and it helps to conserve amplifier power.

Another way to consider low-cut's function is that it actually adds flexibility during live performances. With the addition of low-cut, you can safely use low equalization on vocals. Many times, bass shelving EQ can really benefit voices. Trouble is, adding low EQ also boosts stage rumble, mic handling clunks and breath pops. Applying low-cut removes all those problems, so you can add low EQ without losing a woofer.

Here's what the combination of low EQ and low-cut looks like in terms of frequency curves:

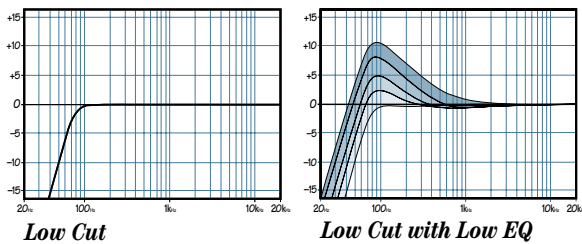

4. GAIN (Channels 1–4)

If you haven't already, please read the Level-Setting Procedure on page 3.

GAIN adjusts the input sensitivity of the mic and line inputs connected to channels 1 through 4. This allows signals from the outside world to be adjusted to optimal internal operating levels.

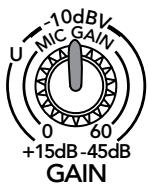

If the signal originates through the XLR jack, there will be 0 dB of gain with the knob fully down, ramping to 60 dB of gain fully up.

Through the 1/4" input, there is 15 dB of attenuation fully down and 45 dB of gain fully up, with a "U" (unity gain) mark at 10:00. This 15 dB of attenuation can be very handy when you are inserting a very hot signal, or when you want to add a lot of EQ gain, or both. Without this "virtual pad," this scenario might lead to channel clipping.

5. STEREO LINE INPUTS (Channels 5–6, 7–8, 9–10 and 11–12)

These fully balanced inputs are designed for stereo or mono, balanced or unbalanced signals, from -10 dBV to +4 dBu. They can be used with just about any professional or semi-pro instrument, effect or tape player.

In the stereo audio world, an odd-numbered channel usually receives the "left signal." For example, you would feed the 1202-VLZ3's line inputs 5-6 a stereo signal by inserting the device's left output plug into the channel 5 jack, and its right output plug into the channel 6 jack.

When connecting a mono device (just one cord), always use the LEFT (MONO) input (jacks 5, 7, 9 or 11) and plug nothing into the RIGHT input (jacks 6, 8, 10 or 12)—this way the signal will appear on both sides. This trick is called "jack normaling."

6. IMAGINARY CONTROL

This control is purely a figment of our imagination. It will come in handy after long hours of mixing, when you really would like a nice cup of tea, a vacation in Hawaii, or a trip to the outer reaches of the Solar System. This is the control for you. Be thankful, you bought a Mackie. We love you man!

EFFECTS: SERIAL OR PARALLEL?

The next two sections toss the terms "serial" and "parallel" around like hacky sacks. Here's what we mean by them:

"Serial" means that the entire signal is routed through the effects device. Examples: compressor/limiters, graphic equalizers. Line-level sources can be patched through a serial effects device before or after the mixer, or preferably through the insert jacks located on the rear panel (CHANNEL INSERT [17] send/return).

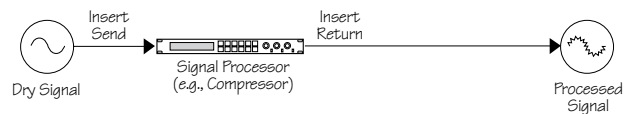

"Parallel" means that a portion of the signal in the mixer is tapped off to the device (AUX SEND), processed and returned to the mixer (STEREO RETURN) to be mixed with the original "dry" signal. This way, multiple channels can all make use of the same effects device. Examples: reverb, digital delay.

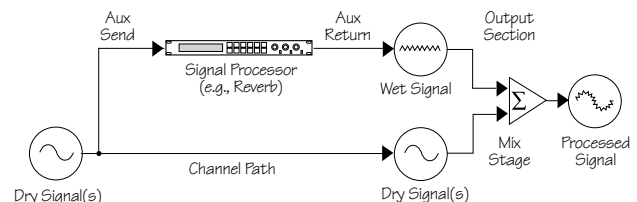

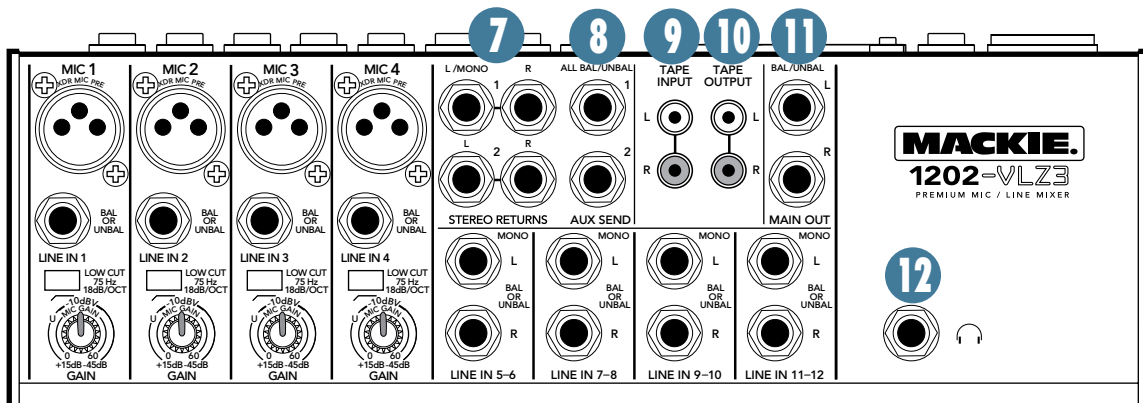

7. STEREO RETURNS

This is where you connect the outputs of your parallel effects devices (or extra audio sources). These balanced inputs are similar to the stereo LINE IN [2] inputs (without EQ, Aux Sends, Pan, Mute, and Solo). The circuits will handle stereo or mono, balanced or unbalanced signals, either instrument level, -10 dBV or $+4$ dBu. They can be used with just about any pro or semipro effects device on the market. The signals coming into these inputs can be adjusted using the STEREO RETURN [40] knobs before passing onto the main mix bus, see page 19.

One Device: If you have just one parallel effects device (two cords), use STEREO RETURN 1 and leave STEREO RETURN 2 unplugged. That way, the unused STEREO RETURN 2 level control can be used to feed STEREO RETURN 1 to your stage monitors, via the RETURN TO AUX 1 [41] switch.

Mono Device: If you have an effects device with a mono output (one cord), plug that into STEREO RETURN 1, L/MONO, and leave STEREO RETURN 1, RIGHT, unplugged. This way the signal will be sent to both sides, magically appearing in the center as a mono signal. This won't work with STEREO RETURN 2 — you'll need a Y-cord.

8. AUX SEND 1&2

The AUX SEND [31] knobs tap a portion of each channel's signal to provide an output here to feed external parallel effects processors or stage monitoring. See the AUX SEND details on page 15.

These 1/4" jacks are balanced outputs capable of delivering 22 dBu into a 600 ohm balanced or unbalanced load.

9. TAPE INPUT

These RCA jacks are designed to work with semipro as well as pro recorders. To compensate for typically low levels, signals coming in here will be automatically boosted by 6 dB.

Connect your tape recorder's outputs here, using standard hi-fi (RCA) cables.

Use these jacks for convenient tape playback of your mixes. You'll be able to review a mix and then rewind and try another pass without repatching or disturbing the mixer levels. You can also use these jacks with a portable tape or CD player to feed music to a PA system between sets.



WARNING: Engaging both the TAPE and ASSIGN TO MAIN MIX buttons in the CONTROL ROOM SOURCE [33] matrix can create a feedback path between TAPE INPUT and TAPE OUTPUT. Make sure your tape deck is not in record, record-pause, or input monitor mode, when you engage these switches, or make sure the CONTROL ROOM / SUBMIX [34] level knob is fully counterclockwise (off).

10. TAPE OUTPUT

These unbalanced RCA connections tap the main mix output to make simultaneous recording and PA work more convenient. Connect these to your recorder's inputs. (See also MAIN MIX [32] on page 16.)

Mono Out: If you want to feed a mono signal to your tape deck or other device, simply use an RCA Y-cord to combine these outputs. Do not attempt this with any other outputs on the 1202-VLZ3.

11. 1/4" MAIN OUTS

These outputs feed the main mix out into the waiting world. You can feed your amplifiers this way, or through the XLR MAIN OUTS [13].

These balanced outputs are capable of delivering 22 dBu into a 600 ohm balanced or unbalanced load.

To use these outputs to drive balanced inputs, connect 1/4" TRS (Tip-Ring-Sleeve) phone plugs like this:

Tip = + (hot)
 Ring = -(cold)
 Sleeve = Ground

For most music recording and PA applications, unbalanced lines are fine. To drive unbalanced inputs, connect 1/4" TS (Tip-Sleeve) phone plugs like this:

Tip = + (hot)
 Sleeve = Ground

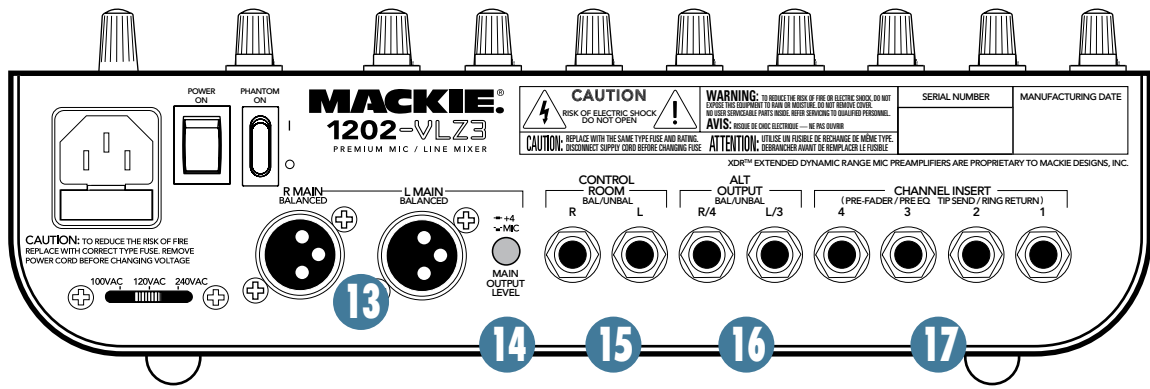

12. PHONES

This stereo jack will drive any standard headphone to very loud levels. Walkperson-type phones can also be used with an appropriate adapter. To learn how signals are routed to these outputs, see SOURCE MATRIX [33] on page 16. If you're wiring your own cable for the PHONES output, follow standard conventions:

Tip = Left channel

Ring = Right channel

Sleeve = Common ground



WARNING: When we say the headphone amp is loud, we're not kidding. It can cause permanent ear damage. Even intermediate levels may be painfully loud with some earphones. BE CAREFUL! Always turn the CTL ROOM/ SUBMIX [34] knob all the way down before connecting headphones. Keep it down until you've put the phones on. Then turn it up slowly. Why? "Engineers who fry their ears find themselves with short careers."

13. XLR MAIN OUTS

Use these to send the main mix out into the line-level balanced inputs of your amplifier or powered speakers.

These low-impedance outputs are fully balanced and capable of driving +4 dBu lines with up to 28 dB of headroom. This output is 6 dB hotter than other outputs.

14. XLR MAIN OUTPUT LEVEL SWITCH

Engaging this switch reduces the level of the balanced XLR main outputs by 40 dB, so you can feed the microphone input of, say, another mixer. (You can safely connect the XLR outputs into an input that provides 48V phantom power.)

15. CONTROL ROOM

These 1/4" outputs are provided so you can listen to something other than the main mix. The source is selected using the SOURCE MATRIX [33] switches (see page 16). You can choose to listen to the main mix, the Alt 3-4 stereo bus (see MUTE/ALT 3-4 on page 13), So-

loaded channels, or the Tape input. The volume is adjustable with the CONTROL ROOM/SUBMIX [34] knob.

These balanced outputs are capable of delivering 22 dBu into a 600 ohm balanced or unbalanced load.

16. ALT 3-4 OUTPUT

These 1/4" outputs are the sum of any channels that have the MUTE/ALT 3-4 [25] switch pressed in (see page 13 for the tender details).

These balanced outputs are capable of delivering 22 dBu into a balanced or unbalanced load.

17. CHANNEL INSERT (Channels 1-4)

These rear-panel jacks are where you connect serial effects such as compressors, equalizers, de-essers, or filters. Since most people don't have more than a few of these gadgets, we've included inserts for just the first four channels. If you want to use this kind of processing on channels 5 through 12, simply patch through the processor before you plug into the 1202-VLZ3.

The channel insert points are after the GAIN [4] and LOW CUT [3] controls, but before the channel's EQ [27] and LEVEL [23] controls. The send (tip) is low-impedance (120 ohms), capable of driving any line-level device. The return (ring) is high-impedance (over 2.5 k ohms) and can be driven by almost any device.

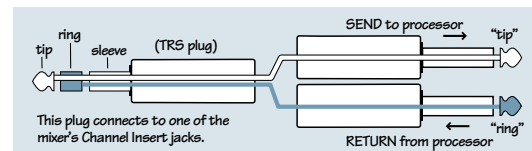

See Appendix B for details and drawings about Insert cables, and a diagram showing three ways to use the jacks.

Besides being used for inserting external devices, these jacks can also be used as channel direct outputs; post-GAIN, post-LOW CUT, and pre EQ. In fact, Mackie mic preamps have become so famous, that people buy these mixers just to have four of these in their arsenal.

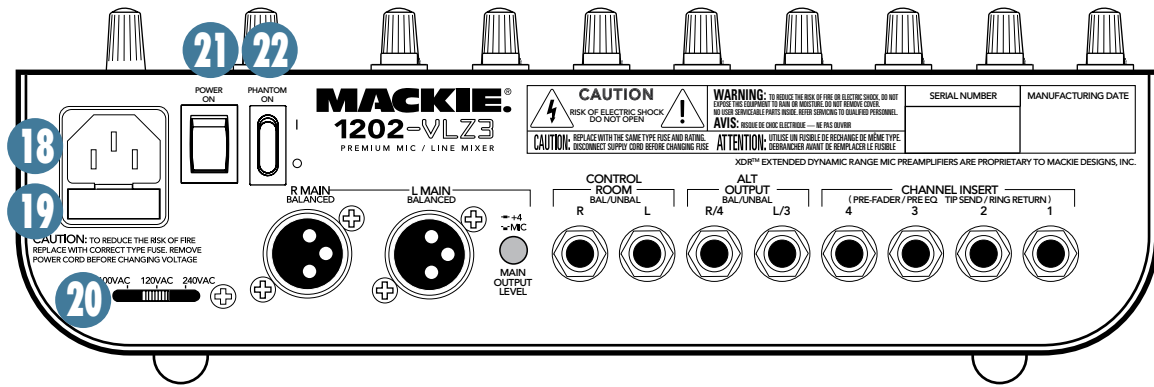

18. POWER CONNECTION

Just in case you lose the cord provided with the 1202-VLZ3, its power jack accepts a standard 3-prong IEC cord like those found on most professional recorders, musical instruments, and computers.



WARNING: Before you plug the AC power cord into the 1202-VLZ3, you must make sure that the **VOLTAGE SELECTOR** [20] slide switch is set to the same voltage as your local AC mains supply.



WARNING: Disconnecting the plug's ground pin can be dangerous. Please don't do it.

19. FUSE

The 1202-VLZ3 is fused for your (and its own) protection. If you suspect a blown fuse, disconnect the AC mains power cord, pull the fuse drawer out (located just below the cord receptacle) and replace the fuse with a 500 mA (0.5 amps) SLO BLO 5x20mm, available at electronics stores or your dealer. Use a 250 mA fuse if your local voltage is 220-240 VAC.

If two fuses blow in a row, something is very wrong. Please call our toll-free number 1-800-898-3211 from within the U.S. (or the distributor in your country) and find out what to do.

20. VOLTAGE SELECTOR



WARNING: Before you plug the AC power cord into the 1202-VLZ3, you must make sure that this slide switch is set to the same voltage as your local AC main supply. Only slide the voltage switch with the power cord unplugged.

Use a flat headed screwdriver to slide the switch if needed. The switch allows you to use the mixer in different countries and voltages, meet interesting people from other cultures, and entertain them with your unique blend of Rockabilly Funkadelia Thrash Metal.

21. POWER SWITCH

Press the top of this rocker switch inwards to turn on the mixer. The power LED on the top surface of the mixer will glow with happiness, or at least it will if you have the mixer plugged in to a suitable live AC mains supply.

Press the bottom of this switch to put the mixer into standby mode. It will not function, but the circuits are still live. To remove AC power, either turn off the AC mains supply, or unplug the power cord from the mixer and the AC mains supply.

As a general guide, you should turn on your mixer first, before the power amplifier or powered speakers, and turn it off last. This will reduce the possibilities of any turn-on, or turn-off thumps in your speakers.

22. PHANTOM SWITCH

This global rocker switch controls the phantom power supply for condenser microphones plugged into channel MIC [1] inputs (see page 8).

Press the top of the switch inwards to engage phantom power to the four MIC inputs. Press the bottom of the switch to turn it off.

When turned on (or off), the phantom power circuitry takes a few moments for voltage to ramp up (or down). This is perfectly normal. Just like me. Oh, and my imaginary friend Lazlo who helps me write all the manuals. Say hello to the nice folks Lazlo.

Channel Strip Description

The eight channel strips look alike, and function identically. The only difference is that the four on the left are for individual mics or mono instruments and have more gain available, while the next four are for either stereo or mono line-level sources. (Each of the stereo channel strips is actually two complete circuits. The controls are linked together to preserve stereo.) We'll start at the bottom and work our way up...

"U" LIKE UNITY GAIN

Mackie mixers have a "U" symbol on almost every level control. This "U" stands for "unity gain," meaning no change in signal level. Once you have adjusted the input signal to line-level, you can set every control at "U" and your signals will travel through the mixer at optimal levels. What's more, all the labels on our level controls are measured in decibels (dB), so you'll know what you're doing level-wise if you choose to change a control's settings.

You won't have to check it here and check it there, as you would with some other mixers. In fact, some don't even have any reference to actual dB levels at all! You were smart — you bought a Mackie.

23. LEVEL

This adjusts the channel's level... from off, to unity gain at the detent, on up to 12 dB of additional gain.

The LEVEL knob is the equivalent of a channel fader, so sometimes we lapse and say the word fader.

Channels 1 through 4 use mono controls, and channels 5 through 12 use stereo controls, and so they may feel slightly different. Not a problem.

24. PRE-FADER SOLO

This lovable switch allows you to hear signals through your headphones or control room without having to route them to the main mix or ALT 3-4 mix. You don't even have to have the channel's LEVEL [23] knob turned up. Folks use solo in live work to preview channels before they are let into the

mix, or to just check out what a particular channel is up to anytime during a session. You can solo as many channels at a time as you like.

Solo is also the key player in the Level-Setting Procedure on page 3.

Soloed channels are sent to the SOURCE mix, which ultimately feeds your control room, phones and meter display. Whenever SOLO is engaged, all SOURCE selections (MAIN MIX, ALT 3-4 and TAPE) are defeated, to allow the soloed signal to do just that — solo!



WARNING: PRE-FADER SOLO taps the channel signal before the LEVEL knob. If you have a channel's LEVEL knob set below "U" (unity gain), SOLO won't know that and will send a unity gain signal to the control room, phones and meter display. That may result in a startling level boost at these outputs.

25. MUTE/ALT 3-4

The dual-purpose MUTE/ALT 3-4 bus is a Mackie signature. When Greg was designing our first product, he had to include a mute switch for each channel. Mute switches do just what they sound like they do. They turn off the signal by "routing" it into oblivion. "Gee, what a waste," Greg reasoned. "Why not have the mute button route the signal somewhere else useful... like a separate stereo bus?" So MUTE/ALT 3-4 really serves two functions — muting (often used during a mixdown or live show), and signal routing (for multitrack and live work) where it acts as an extra stereo bus.

To use this as a MUTE switch, all you have to do is not use the ALT 3-4 [16] outputs. Then, whenever you press this switch, you will assign a channel to these unused outputs, disconnecting it from the main mix, and effectively muting the channel.

To use this as an ALT 3-4 switch, all you have to do is connect the ALT 3-4 outputs to whatever destination you desire. Here are two popular examples:

When doing multitrack recording, use the ALT 3-4 outputs to feed your multitrack. With most decks, you can "mult" the ALT 3-4 [16] outputs, using Y-cords or mults, to feed multiple tracks. So, take ALT OUTPUT L and send it to tracks 1, 3, 5 and 7, and ALT OUTPUT R and send it to tracks 2, 4, 6 and 8. Now, tracks that are in Record or Input modes will hear the ALT 3-4 signals, and tracks in Playback or Safe modes will ignore them.

When doing live sound or mixdown, it's often handy to control the level of several channels with one knob. That's called subgrouping. Simply assign these channels to the ALT 3-4 mix, engage ALT 3-4 in the SOURCE [33] matrix, and the signals will appear at the CON-

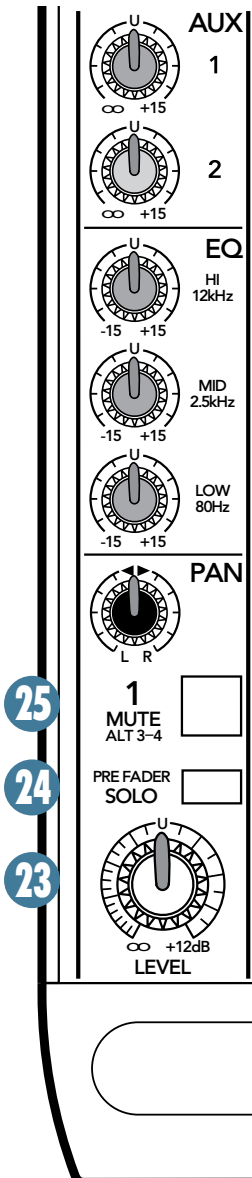

TROL ROOM [15] and PHONES [12] outputs. If you want the ALT 3–4 signals to go back into the main mix, engage the ASSIGN TO MAIN MIX [36] switch, and the CONTROL ROOM/SUBMIX [34] level control becomes the one knob to control the levels of all the channels assigned to ALT 3–4.

Another way to do the same thing is assign the channels to the ALT 3–4 mix, then patch out of the ALT 3–4 OUTPUT [16] back into an unused stereo channel LINE INPUT [2]. If that's your choice, don't ever engage the MUTE/ALT 3–4 switch on that stereo channel, or you'll have every dog in the neighborhood howling at your feedback loop.

Another benefit of the ALT 3–4 feature is that it can act as a "SIP" (Solo-In-Place): just engage a channel's MUTE/ALT 3–4 switch and the ALT 3–4 switch in the SOURCE matrix and you'll get that channel, all by itself, in the control room and phones.

MUTE/ALT 3–4 is one of those controls that can bewilder newcomers, so take your time and play around with it. Once you've got it down, you'll probably think of a hundred uses for it!

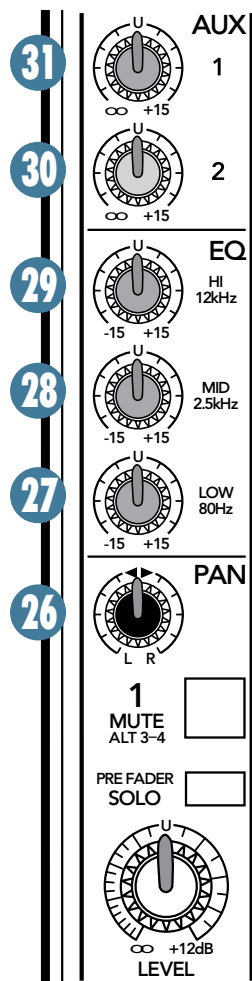

26. PAN

PAN adjusts the amount of channel signal sent to the left versus the right outputs. On mono channels (ch. 1–4 or 5–12 with connections to the L input only) these controls act as pan pots. On stereo channels (5–12) with stereo connections to L and R inputs, the PAN knob works like the balance control on your home stereo.

PAN determines the fate of the main mix and ALT 3–4 mix. With the PAN knob hard left, the signal will feed either MAIN OUT L (bus 1) or ALT OUTPUT L (bus 3), depending on the position of the ALT 3–4 switch. With the knob hard right, the signal feeds MAIN OUT R (bus 2) or ALT OUTPUT R (bus 4).

CONSTANT LOUDNESS !!!

The 1202-VLZ3's PAN controls employ a design called "Constant Loudness." It has nothing to do with living next to an all-night disco. As you turn the PAN [26] knob from left to right (thereby causing the sound to move from the left to the center to the right), the sound will appear to remain at the same volume (or loudness).

If you have a channel panned hard left (or right) and reading 0 dB, it must dip down about 4 dB on the left (or right) when panned center. To do otherwise (the way Brand X compact mixers do) would make the sound appear much louder when panned center.

3-BAND EQ

The 1202-VLZ3 has 3-band equalization at carefully selected points — LOW shelving at 80 Hz, MID peaking at 2.5 kHz, and HI shelving at 12 kHz. "Shelving" means that the circuitry boosts or cuts all frequencies past the specified frequency. For example, rotating the LOW EQ knob 15 dB to the right boosts bass starting at 80 Hz and continuing down to the lowest note you never heard. "Peaking" means that certain frequencies form a "hill" around the center frequency — 2.5 kHz in the case of the MID EQ.

27. LOW EQ

This control gives you up to 15 dB boost or cut below 80 Hz. The circuit is flat (no boost or cut) at the center detent position. This frequency represents the punch in bass drums, bass guitar, fat synth patches, and some really serious male singers.

Used in conjunction with the LOW CUT [3] switch, you can boost the LOW EQ without injecting a ton of subsonic debris into the mix.

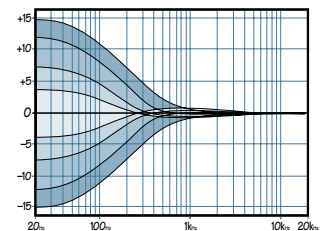

Low EQ

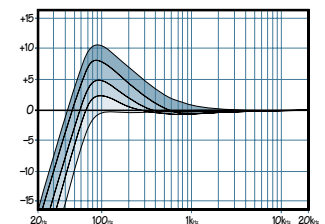

Low EQ with Low Cut

28. MID EQ

Short for "midrange," this knob provides 15 dB of boost or cut, centered at 2.5 kHz, also flat at the center detent. Midrange EQ is often thought of as the most dynamic, because the frequencies that define any particular sound are almost always found in this range. You can create many interesting and useful EQ changes by turning this knob down as well as up.

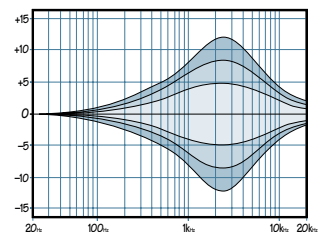

Mid EQ

29. HI EQ

This control gives you up to 15 dB boost or cut above 12 kHz, and it is also flat at the detent. Use it to add sizzle to cymbals, and an overall sense of transparency, or edge to keyboards, vocals, guitar and bacon frying. Turn it down a little to reduce sibilance, or to hide tape hiss.

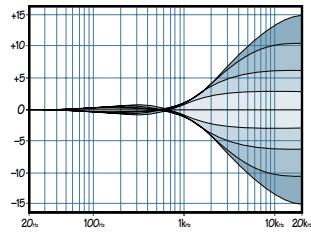

High EQ

MODERATION DURING EQ

With EQ, you can also screw things up royally. We've designed a lot of boost and cut into each equalizer circuit, because we know everyone will occasionally need that. But if you max the EQs on every channel, you'll get mix mush. Equalize subtly and use the left sides of the knobs (cut), as well as the right (boost). Very few gold-record-album engineers ever use more than about 3 dB of EQ. If you need more than that, there's usually a better way to get it, such as placing a mic differently (or using a different kind of mic entirely).

30. AUX 2 SEND 31. AUX 1 SEND

These knobs allow you to tap a portion of each channel signal out to another source for parallel effects processing or stage monitoring. AUX send levels are controlled by these knobs and by the AUX 1 MASTER [39].

These are more than just effects and monitor sends. They can be used to generate separate mixes for recording or "mix-minuses" for broadcast. By using AUX 1 in the PRE mode, these mix levels can be obtained independently of the channel's LEVEL control.

AUX 1 in post mode and AUX 2 are post-LOW CUT, post-EQ and post-LEVEL. That is, the sends obey the settings of these controls. AUX 1 in PRE mode follows the EQ and LOW CUT settings only. PAN and LEVEL have no effect on the PRE send (see diagram below).

Each AUX send level ranges from off through unity (the center detent position) on up to 15 dB of extra gain (when turned fully clockwise). Chances are you'll never need this extra gain, but it's nice to know it's there if you do.

Channel 5–12 AUX knobs control the mono sum of the channel's stereo signals for each AUX send. For instance, channel 5 (L) and 6 (R) mix together to feed that channel's AUX send knobs.

We recommend going into a stereo reverb in mono and returning in stereo. We have found that on most "stereo" reverbs the second input just ties up an extra AUX send and adds nothing to the sound. There are exceptions, so feel free to try it both ways. If your effects device is true stereo all the way through, use AUX 1 to feed its left input and AUX 2 to feed the right input.

Still with us? Good for you. Here come the tricky parts, the output or master section where the mixing is really done. We have even started it on a new page:

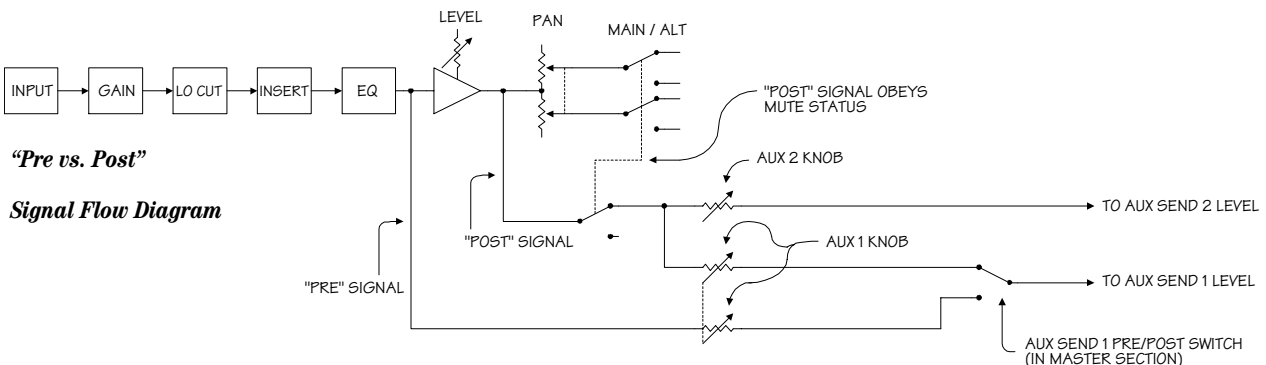

Output Section

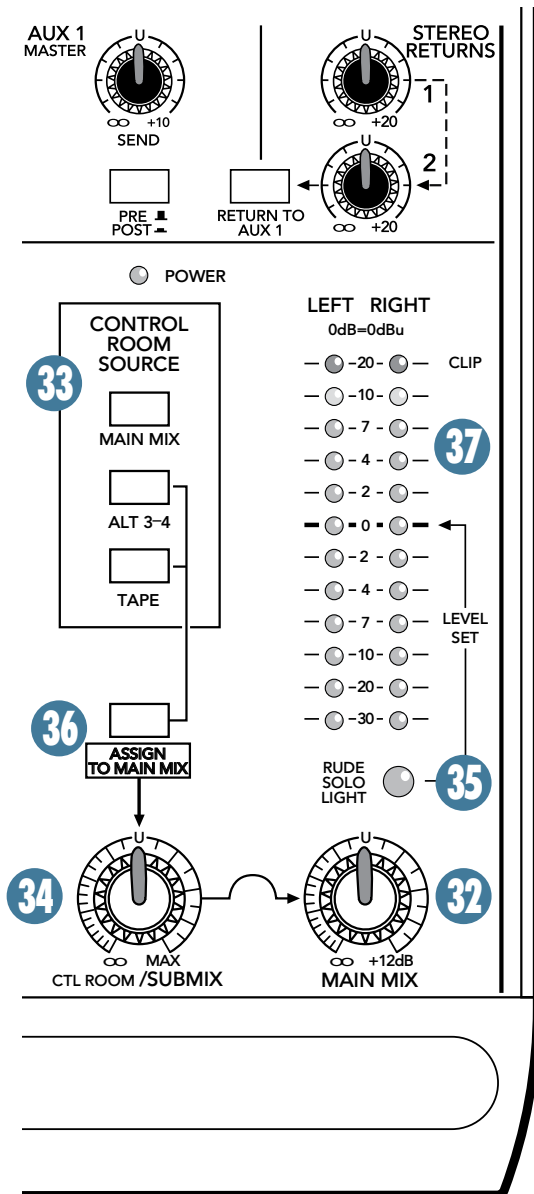

32. MAIN MIX

This knob controls the levels of signals sent to the main outputs: XLR [13] and 1/4" [11] and RCA TAPE OUTPUT [10]. All channels and STEREO RETURNS [7] that are not muted or turned fully down will wind up in the main mix.

Fully counterclockwise is off, the center detent is unity gain, and fully clockwise provides 12 dB of additional gain. This additional gain will typically never be needed, but once again, it's nice to know it's there. This is the knob to turn down at the end of the song when you want The Great Fade-Out.

33. CONTROL ROOM SOURCE MATRIX

Typically, the engineer sends the main mix to an audience (if live) or a mixdown deck (if recording). But what if the engineer in the control room needs to hear something other than the main mix? With the 1202-VLZ3, the engineer has several choices of what to listen to. This is one of those tricky parts, so brace yourself.

Via these SOURCE switches, you can choose to listen to any combination of main mix, ALT 3-4 and Tape. By now, you probably know what the main mix is. ALT 3-4 is that additional stereo mix bus. Tape is the stereo signal coming in from the TAPE INPUT [9] jacks.

Selections made in the source matrix deliver stereo signals to the control room, phones and meter display. With no switches engaged, there will be no signal at these outputs and no meter indication.

The exception is the solo function. Regardless of the source selection, engaging a channel's SOLO [24] switch will replace that selection with the solo signal, also sent to the control room, phones and right meter (the left meter becomes inactive). This is what makes the Level-Setting Procedure so easy to do.



WARNING: Engaging both the TAPE and ASSIGN TO MAIN MIX [36] buttons can create a feedback path between TAPE INPUT [9] and TAPE OUTPUT [10]. Make sure your tape deck is not in record, record-pause, or input-monitor mode when you engage these switches, or make sure the CONTROL ROOM / SUBMIX [34] level knob is fully counterclockwise (off).

Now you know how to select the signals to send to the engineer's control room or phones. From there, these signals all pass through the same level control:

34. CONTROL ROOM/SUBMIX

This knob controls the levels of both the stereo CONTROL ROOM [15] and PHONES [12] outputs. The control range is from off through unity gain at the detent, with 10 dB of extra gain (when turned fully clockwise).

When MAIN MIX is your control room source selection, those signals will now pass through two level controls on the way to your control room amp and phones — the MAIN MIX [32] knob and this CONTROL ROOM / SUBMIX knob. This way, you can send a nice healthy level to the main output (MAIN MIX knob at "U"), and a quiet level to the control room or phones (CONTROL ROOM / SUBMIX knob wherever you like it).

When ALT 3-4 or TAPE is selected, or SOLO [24] is engaged, the CONTROL ROOM / SUBMIX knob will be the only one controlling these levels (channel controls notwithstanding).

Whatever your selection, you can also use the CONTROL ROOM [15] outputs for other applications. Its sound quality is just as impeccable as the MAIN OUTS [11 and 13]. It can be used as additional main mix output, which may sound silly since there are already three, but this one has its own level control. However, should you do something like this, be sure that you do not engage a SOLO switch, as that will interrupt your SOURCE selection.

A WORD ABOUT PRE-FADER SOLO (PFL)

Engaging a channel's SOLO [24] switch will cause this dramatic turn of events: Any existing control room source selections will be replaced by the solo signal, appearing in the control room, headphones, and in the right meter. The audible solo levels are then controlled by the CONTROL ROOM / SUBMIX [34] knob. The solo levels appearing on the right meter display are not controlled by anything — you wouldn't want that. You want to see the actual channel level on the meter display regardless of how loud you're listening.

"PRE-FADER" SOLO means that the channel signal is being tapped before the channel's LEVEL [23] knob (not really a fader in this case, but we were afraid you'd laugh if we called it Pre-Knob Solo). It does, however, obey GAIN [4], LOW CUT [3] and EQ [27] settings, making it the perfect tool for quick inspections of suspect channels. The channel's PAN [26] and MUTE/ALT 3-4 [25] settings have no effect on the solo signal.

Note: For stereo channels 5-12, the solo signal is the mono sum of the left (odd-numbered) and right (even-numbered) signals for that channel strip.



WARNING: PRE-FADER SOLO [24] taps the channel signal before the LEVEL knob. If you have a channel's LEVEL knob set below "U" (unity gain), SOLO won't know that, and will send a unity gain signal to the control room, phones and meter display, that may result in a startling level boost at these outputs.

35. RUDE SOLO LIGHT

This flashing Light Emitting Diode serves two purposes — to remind you that at least one channel is in solo, and to let you know that you're mixing on a Mackie. No other company is so concerned about your level of solo awareness. If you work on a mixer that has a solo function with no indicator lights, and you happen to forget you're in solo, you can easily be tricked into thinking that something is wrong with your mixer. Hence the RUDE SOLO LIGHT. It's especially handy at about 3 a.m. when no sound is coming out of your monitors but your multitrack is playing back like mad.

36. ASSIGN TO MAIN MIX

Let's say you're doing a live show. Intermission is nearing and you'll want to play a soothing CD for the crowd to prevent them from eating the furniture. Then you think, "But I have the CD player plugged into the TAPE inputs, and that never gets to the MAIN OUTS!" Oh, but it does. Simply engage this switch and your control room source selection, after going through the CONTROL ROOM / SUBMIX [34] knob, will feed into the main mix, just as if it were another stereo channel.

Another handy use for this switch is to enable the ALT 3-4 mix to become a submix of the main mix, using the CONTROL ROOM/SUBMIX knob as its level control.

Side effects: (1) Engaging this switch will also feed any soloed channels into the main mix, which may be the last thing you want. (2) If you have MAIN MIX as your control room source selection and then engage ASSIGN TO MAIN MIX, the main mix lines to the control room will be interrupted to prevent feedback. Then again, why would anyone want to assign the main mix to the main mix?

37. METERS – MANY DISPLAYS IN ONE!

The 1202-VLZ3's peak metering system is made up of two columns of twelve LEDs. Deceptively simple, considering the multitude of signals that can be monitored by it.

If nothing is selected in the SOURCE matrix and no channels are in SOLO, the METERS will just sit there and do nothing. To put them to work, you must make a selection in the SOURCE matrix (or engage a SOLO switch).

Why? You want the meter display to reflect what the engineer is listening to, and as we've covered, the engineer is listening either to the CONTROL ROOM [15] outputs or the PHONES [12] outputs. The only difference is that while the listening levels are controlled by the CONTROL ROOM / SUBMIX [34] knob, the meters read the SOURCE mix before that control, giving you the real facts at all times, even if you're not listening at all.

Thanks to the 1202-VLZ3's wide dynamic range, you can get a good mix with peaks flashing anywhere between -20 and $+10$ dB on the METERS. Most amplifiers clip at about $+10$ dB, and some recorders aren't so forgiving either. For best real-world results, try to keep your peaks between "0" and "+7".

You may already be an expert at the world of "+4" ($+4$ dBu= 1.23 V) and " -10 " (-10 dBV= 0.32 V) operating levels. Basically, what makes a mixer one or the other is the relative 0 dB VU (or 0 VU) chosen for the meters. A "+4" mixer, with a $+4$ dBu signal pouring out the back will actually read 0 VU on its meters. A " -10 " mixer, with a -10 dBV signal trickling out, will read 0 VU on its meters. So when is 0 VU actually 0 dBu? Right now!

At the risk of creating another standard, Mackie's compact mixers address the need of both crowds by calling things as they are — 0 dBu (0.775 V) at the output shows as 0 dB VU on the METERS. What could be easier? By the way, the most wonderful thing about standards is that there are so many to choose from.

Remember, audio meters are just tools to help assure you that your levels are “in the ballpark.” You don't have to stare at them (unless you want to).

A Word About Aux

First of all, there is no particular alliance between AUX SEND 1 (or 2) and STEREO RETURN 1 (or 2). They're just numbers. They're like two complete strangers.

SENDS are outputs, RETURNS are inputs. The channel AUX [30 and 31] knobs tap the signal off the channel and sends it to the AUX SEND [8] outputs. AUX 1 signal is sent to the AUX 1 MASTER [39] knob before going to the AUX SEND 1 [8] output and the AUX 2 signal goes directly to the AUX SEND 2 [8] output.

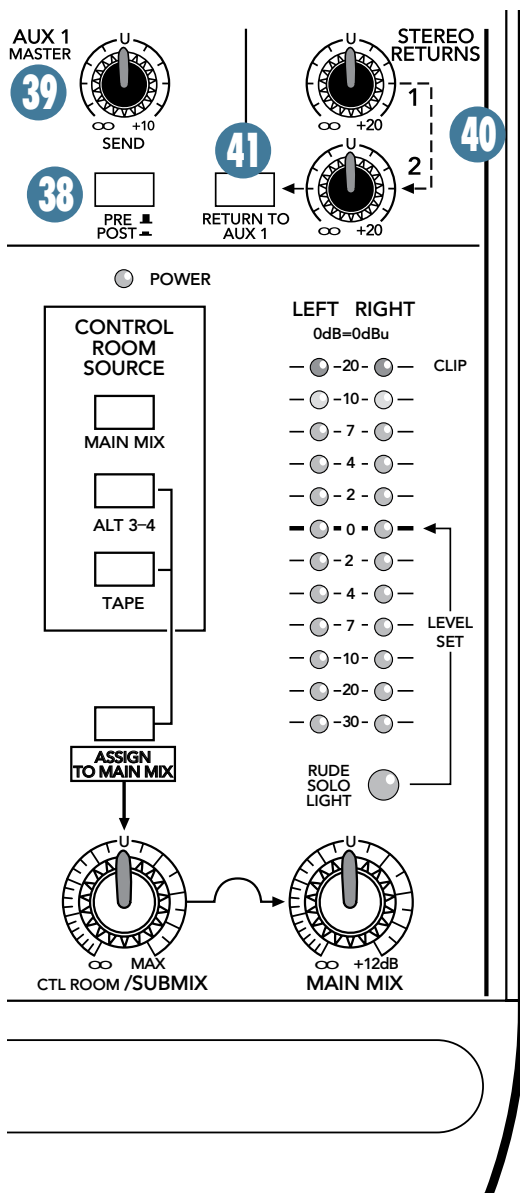

These outputs can be fed to the inputs of a reverb or other device. From there, the outputs of this external device are fed back to the mixer's STEREO RETURN [7] jacks. Then these signals are sent through the STEREO RETURN [40] level controls, and finally delivered to the main mix.

So, the original “dry” signals go from the channels to the main mix and the affected “wet” signals go from the STEREO RETURN [7] to the main mix, and once mixed together, the dry and wet signals combine to create a glorious sound. So, armed with this knowledge, let's visit the Auxiliary World:

38. PRE or POST (AUX 1)

Besides being used to work effects into your mix, Aux Sends serve another critical role — that of delivering cue mixes to stage monitors, so musicians can hear what they're doing. On the 1202-VLZ3, AUX SEND 1 can play either role, depending on the position of this switch.

With this switch up (disengaged), AUX SEND 1 will tap a channel pre-fader (LEVEL) and pre-MUTE/ALT 3-4, meaning that no matter how you manipulate those controls as they feed the main mix, the AUX SEND will continue to belt out that channel's signal. This is the preferred method for setting up stage monitor feeds. EQ settings will affect all AUX SENDs.

With the switch down, the AUX SEND 1 becomes an ordinary effects send — post-fader (LEVEL) and post-MUTE/ALT 3-4. This is a must for effects sends, since you want the levels of your “wet” signals to follow the level of the “dry.”

39. AUX 1 MASTER

This knob provides overall level control of AUX SEND 1, just before it's delivered to the AUX SEND 1 [8] output. (AUX SEND 2 has no such control.) This knob goes from off (turned fully down), to unity gain at the center detent, with 10 dB of extra gain (turned fully up). As with some other level controls, you may never need the additional gain, but if you ever do, you'll be glad you bought a Mackie.

This is usually the knob you turn up when the lead singer glares at you, points at his stage monitor, and sticks his thumb up in the air. (It would follow suit that if the singer stuck his thumb down, you'd turn the knob down... but that never happens.)

40. STEREO RETURNS

These two controls set the overall level of effects received from STEREO RETURN [7] inputs 1 and 2. These controls are designed to handle a wide range of signal levels, from off, to unity gain at the detent, with 20 dB gain fully clockwise, to compensate for low-level effects.

Typically, these knobs can just live at the center detent, and the effects device's output control should be set at whatever they call unity gain (check their manual). If that turns out to be too loud or too quiet, adjust the effects device's outputs, not the mixer. That way, the mixer's knobs are easy to relocate at the center detent.

Signals passing through these controls will proceed directly to main mix, with one exception (see paragraph below). The STEREO RETURNS do not have MUTE/ALT 3-4 switches, so if you want these signals to get to the ALT 3-4 mix, you'll have to patch the effects device's outputs into one of the stereo channels, and MUTE/ALT those channels.

41. RETURN TO AUX 1

If you want to add reverb or delay to the stage monitor mixes of AUX 1, this is the switch for you.

With the switch up, STEREO RETURN 1 and 2 behave normally — they deliver their signals into the main mix. With the switch down, STEREO RETURN 1 still behaves normally, but STEREO RETURN 2 will feed AUX SEND 1 instead of the main mix.

Still with us? Good. So far, with the switch down, we have STEREO RETURN 1 feeding the main mix and STEREO RETURN 2 feeding AUX SEND 1. Now, suppose you only have one effects device, and you want it to feed both the MAIN MIX and AUX SEND 1. That's where "jack normalling" comes in:

JACK NORMALLING

Jack normalling (not to be confused with Jack Normalling, Chicago Cubs utility infielder, 1952-61, .267 LBA) is a feature found on almost every mixer, keyboard and effects device. These jacks have special spring-loaded pins that connect to the signal pins, but when something is plugged into the jack, that connection is broken.

These normalling pins can be used in all sorts of ways. The ubiquitous phrase "LEFT (MONO)" means that if you plug a signal into the LEFT side and have nothing in the RIGHT side, that signal is also fed to the right input, courtesy of jack normalling. As soon as you plug something in the RIGHT side, that normalled connection is broken.

How does all this relate to the RETURN TO AUX 1 [41] switch? STEREO RETURN 1's inputs are normalled to STEREO RETURN 2. If you have one effects device, plug it into STEREO RETURN 1. Plug nothing into STEREO RETURN 2. Now the signals feeding the STEREO RETURN 1 inputs will also be sent to the STEREO RETURN 2 inputs.

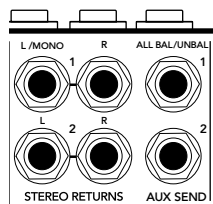

Engage the RETURN TO AUX 1 switch, and now the STEREO RETURN 2 knob will become an additional AUX SEND 1 knob for the signal at AUX RETURN 1. Say that ten times! Once again, AUX RETURN 1 will behave normally, as always.

Congratulations! You've just read about all the features of your 1202-VLZ3. You're probably ready for a cold one. Go ahead. The rest of the manual can wait.

Appendix A: Service Information

If you think your Mackie product has a problem, please check out the following troubleshooting tips and do your best to confirm the problem. Visit the Support section of our website (www.mackie.com/support) where you will find lots of useful information such as FAQs, and documentation. You may find the answer to the problem without having to send your Mackie product away.

Troubleshooting

Bad Channel

- Is the MUTE/ALT 3–4 switch in the correct position?
- Is the LEVEL knob turned up?
- Try unplugging any INSERT devices (Channels 1–4 only).
- Try the same source signal in another channel, set up exactly like the suspect channel.

Bad Output

- Is the associated level knob (if any) turned up?
- If it's one of the MAIN OUTS, try unplugging all the others. For example, if it's the 1/4" Left Main out, unplug the RCA and XLR Left outputs. If the problem goes away, it's not the mixer.
- If it's a stereo pair, try switching them around. For example, if a left output is presumed dead, switch the left and right cords, at the mixer end. If the problem switches sides, it's not the mixer.

Noise

- Turn the channel LEVEL and AUX RETURN knobs down, one by one. If the sound disappears, it's either that channel or whatever is plugged into it, so unplug whatever that is. If the noise disappears, it's from your whatever.

Power

- Unplug the power cord and check the fuse.

Repair

For warranty service, refer to the warranty information on page 27.

Non-warranty service for Mackie products is available at a factory-authorized service center. To locate your nearest service center, visit www.mackie.com, click "Support" and select "Locate a Service Center." Service for Mackie products living outside the United States can be obtained through local dealers or distributors.

If you do not have access to our website, you can call our Tech Support department at 1-800-898-3211, Monday-Friday, normal business hours, PST, to explain the problem. Tech Support will tell you where the nearest factory-authorized service center is located in your area.

Appendix B: Connections

"XLR" Connectors

Mackie mixers use 3-pin female "XLR" connectors on all microphone inputs, with pin 1 wired to the grounded (earthed) shield, pin 2 wired to the "high" ("hot" or positive polarity) side of the audio signal and pin 3 wired to the "low" ("cold" or negative polarity) side of the signal. See Figure A. This is all totally aboveboard and in full accord with the hallowed standards dictated by the AES (Audio Engineering Society).

Use a male "XLR"-type connector, usually found on the nether end of what is called a "mic cable," to connect to a female XLR jack.

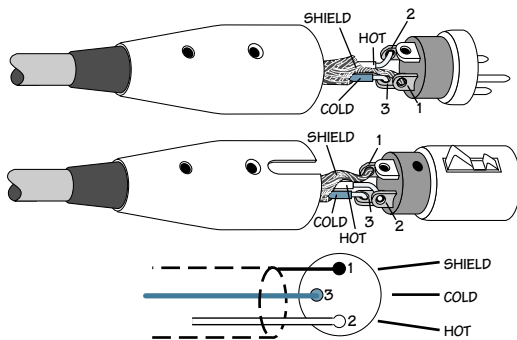

Figure A: XLR Connectors

1/4" TRS Phone Plugs and Jacks

"TRS" stands for Tip-Ring-Sleeve, the three connections available on a "stereo" 1/4" or "balanced" phone jack or plug. See Figure B.

TRS jacks and plugs are used in several different applications:

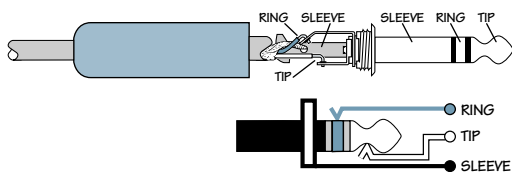

Figure B: 1/4" TRS Plugs

- Stereo Headphones, and rarely, stereo microphones and stereo line connections. When wired for stereo, a 1/4" TRS jack or plug is connected tip to left, ring to right and sleeve to ground (earth). Mackie mixers do not directly accept 1-plug-type stereo microphones. They must be separated into a left cord and a right cord, which are plugged into the two mic preamps.

You can cook up your own adapter for a stereo microphone adapter. "Y" two cables out of a female 1/4" TRS jack to two male XLR plugs, one for the Right signal and one for the Left.

- Balanced mono circuits. When wired as a balanced connector, a 1/4" TRS jack or plug is connected tip to signal high (hot), ring to signal low (cold), and sleeve to ground (earth).
- Unbalanced Send/Return circuits. When wired as a send/return "Y" connector, a 1/4" TRS jack or plug is connected tip to signal send (output from mixer), ring to signal return (input back into mixer), and sleeve to ground (earth).

1/4" TS Phone Plugs and Jacks

"TS" stands for Tip-Sleeve, the two connections available on a "mono" 1/4" phone jack or plug. See Figure C.

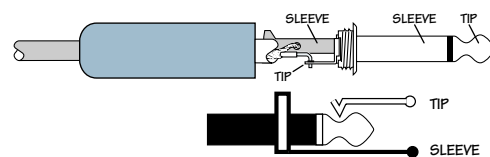

Figure C: TS Plug

TS jacks and plugs are used in many different applications, always unbalanced. The tip is connected to the audio signal and the sleeve to ground (earth). Some examples:

- Unbalanced microphones
- Electric guitars and electronic instruments
- Unbalanced line-level connections

Switched 1/4" Phone Jacks

Switches can be incorporated into 1/4" phone jacks, which are activated by inserting the plug. These switches may open an insert loop in a circuit, change the input routing of the signal or serve other functions. Mackie uses switches in the channel insert and bus insert jacks, input jacks and stereo returns. We also use these switches to ground the line-level inputs when nothing is plugged into them.

In most cases, the plug must be inserted fully to activate the switch. Mackie takes advantage of this in some circuits, specifying circumstances where you are to insert the plug only partially. See Special Mackie Connections, on the next page.

RCA Plugs and Jacks

RCA-type plugs (also known as phono plugs) and jacks are often used in home stereo and video equipment and in many other applications (Figure D). They are unbalanced and electrically identical to a 1/4" TS phone plug or jack. See Figure C. Connect the signal to the center post and the ground (earth) or shield to the surrounding "basket."

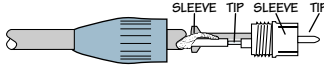

Figure D: RCA Plug

Unbalancing a Line

In most studio, stage and sound reinforcement situations, there is a combination of balanced and unbalanced inputs and outputs on the various pieces of equipment. This usually will not be a problem in making connections.

- When connecting a balanced output to an unbalanced input, be sure the signal high (hot) connections are wired to each other, and that the balanced signal low (cold) goes to the ground (earth) connection at the unbalanced input. In most cases, the balanced ground (earth) will also be connected to the ground (earth) at the unbalanced input. If there are ground-loop problems, this connection may be left disconnected at the balanced end.
- When connecting an unbalanced output to a balanced input, be sure that the signal high (hot) connections are wired to each other. The unbalanced ground (earth) connection should be wired to the low (cold) and the ground (earth) connections of the balanced input. If there are ground-loop problems, try connecting the unbalanced ground (earth) connection only to the input low (cold) connection, and leaving the input ground (earth) connection disconnected.
- In some cases, you will have to make up special adapters to interconnect your equipment. For example, you may need a balanced XLR female connected to an unbalanced 1/4" TS phone plug.

Special Mackie Connections

The balanced-to-unbalanced connection has been anticipated in the wiring of Mackie jacks. A 1/4" TS plug inserted into a 1/4" TRS balanced input, for example, will automatically unbalance the input and make all the right connections. Conversely, a 1/4" TRS plug inserted into a 1/4" unbalanced input will automatically tie the ring (low or cold) to ground (earth).

TRS Send/Receive Insert Jacks

Mackie's single-jack inserts are the three-conductor, TRS-type 1/4" phone. They are unbalanced, but have both the mixer output (send) and the mixer input (return) signals in one connector. See Figure E.

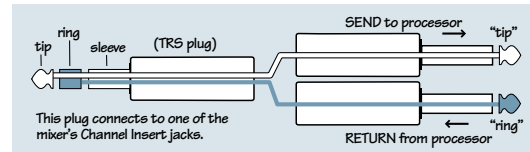

Figure E

The sleeve is the common ground (earth) for both signals. The send from the mixer to the external unit is carried on the tip, and the return from the unit to the mixer is on the ring.

Using the Send Only on an Insert Jack

If you insert a TS (mono) 1/4" plug only partially (to the first click) into a Mackie insert jack, the plug will not activate the jack switch and will not open the insert loop in the circuit (thereby allowing the channel signal to continue on its merry way through the mixer).

This allows you to tap out the channel or bus signal without interrupting normal operation.

If you push the 1/4" TS plug in to the second click, you will open the jack switch and create a direct out, which does interrupt the signal in that channel. See Figure F on the next page.

NOTE: Do not overload or short-circuit the signal you are tapping from the mixer. That will affect the internal signal.

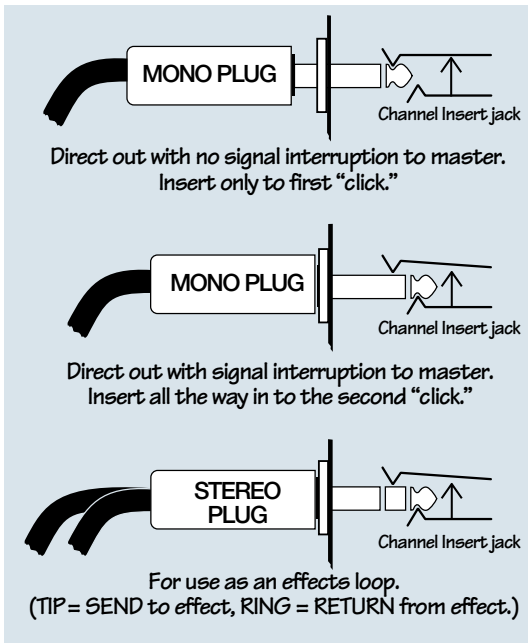

Figure F

Mackie Stereo Inputs and Returns: Mono, Stereo, Whatever

Stereo line inputs and stereo returns are a fine example of the Mackie philosophy (which we just made up) of Maximum Flexibility with Minimum Headache. The inputs and returns will automatically be mono or stereo, depending upon how you use the jacks. Here's how it works:

A mono signal should be patched into the input or return jack labeled LEFT (MONO). The signal will be routed to both the left and right sides of the return circuit, and will show up in the center of the stereo pair of buses it's assigned to, or it can be panned with the PAN [26] control.

A stereo signal, having two plugs, should be patched into the LEFT (MONO) and the RIGHT input or return jacks. A jack switch in the RIGHT jack will disable the mono function, and the signals will show up in stereo.

A mono signal connected to the RIGHT jack will show up in the right bus only. You probably will only want to use this sophisticated effect for special occasions.

Mults and "Y"s

A mult or "Y" connector allows you to route one output to two or more inputs by simply providing parallel wiring connections. You can make "Y"s and mults for the outputs of both unbalanced and balanced circuits.



Remember: Only mult or "Y" one output into several inputs. If you need to combine several outputs into one input, you must use a mixer, not a mult or a "Y."

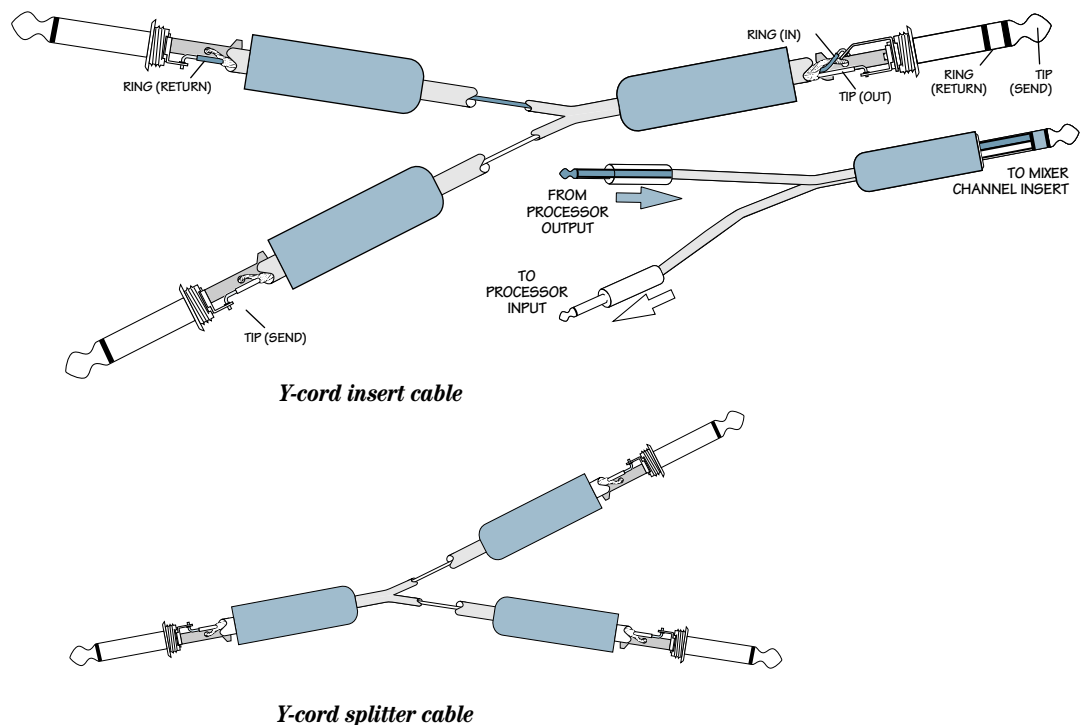

Appendix C: Technical Information

Specifications

Main Mix Noise

(20 Hz–20 kHz bandwidth, 1/4" Main out, channels 1–4 Trim @ unity gain, channel EQs flat, all channels assigned to Main Mix, channels 1 and 3 Pan left, 2 and 4 Pan right.)

Main Mix knob down, channel Gain knobs down: –100 dBu

Main Mix knob unity, channel Gain knobs down: –86.5 dBu

(90 dB Signal to Noise Ratio, ref +4 dBu)

Main Mix knob @ unity, channel Gain knobs @ unity: –84.5 dBu

Total Harmonic Distortion (THD)

(1 kHz @ 35 dB gain, 20 Hz–20 kHz bandwidth)

Mic pre @ insert: 0.0007%

Attenuation (Crosstalk)

(1 kHz relative to 0 dBu, 20 Hz–20 kHz bandwidth, Line in, 1/4" Main Out, Trim @ unity.)

Main Mix knob down: –75 dBu

Channel Alt / Mute switch engaged: –85 dBu

Channel Gain knob down: –87 dBu

Frequency Response

(Mic input to any output.)

20 Hz to 60 kHz: +0 dB/–1 dB

20 Hz to 100 kHz: +0 dB/–3 dB

Equivalent Input Noise (EIN)

(Mic in to Insert Send out, max gain.)

150 ohm termination: –129.5 dBu 20 Hz–20 kHz

Common Mode Rejection Ratio (CMRR)

(Mic in to Insert Send out, max gain.)

1 kHz: better than –70 dB

Maximum Levels

Mic in: +22 dBu

Tape in: +16 dBu

All other inputs: +22 dBu

Main Mix XLR out: +28 dBu

All other outputs: +22 dBu

Impedances

Mic in: 2.5 kilohms

Channel Insert return: 2.5 kilohms

All other inputs: 10 kilohms or greater

Tape out: 1.1 kilohms

All other outputs: 120 ohms

EQ

High Shelving ±15 dB @ 12 kHz

Mid Peaking ±15 dB @ 2.5 kHz

Low Shelving ±15 dB @ 80 Hz

Power Consumption

25 watts

Fuse Rating

100-120V: 500 mA slo blo, 5 x 20 mm

220-240V: 250 mA slo blo, 5 x 20 mm

Dimensions (H x W x D)

11.2" x 11.9" x 3.0" (284 mm x 303 mm x 75 mm)

Weight

6.5 lb (3.0 kg)

LOUD Technologies Inc. is always striving to improve our products by incorporating new and improved materials, components, and manufacturing methods. Therefore, we reserve the right to change these specifications at any time without notice.

"Mackie," and the "Running Man" are registered trademarks of LOUD Technologies Inc. All other brand names mentioned are trademarks or registered trademarks of their respective holders, and are hereby acknowledged.

©2006-2009 LOUD Technologies Inc. All Rights Reserved.

Block Diagram

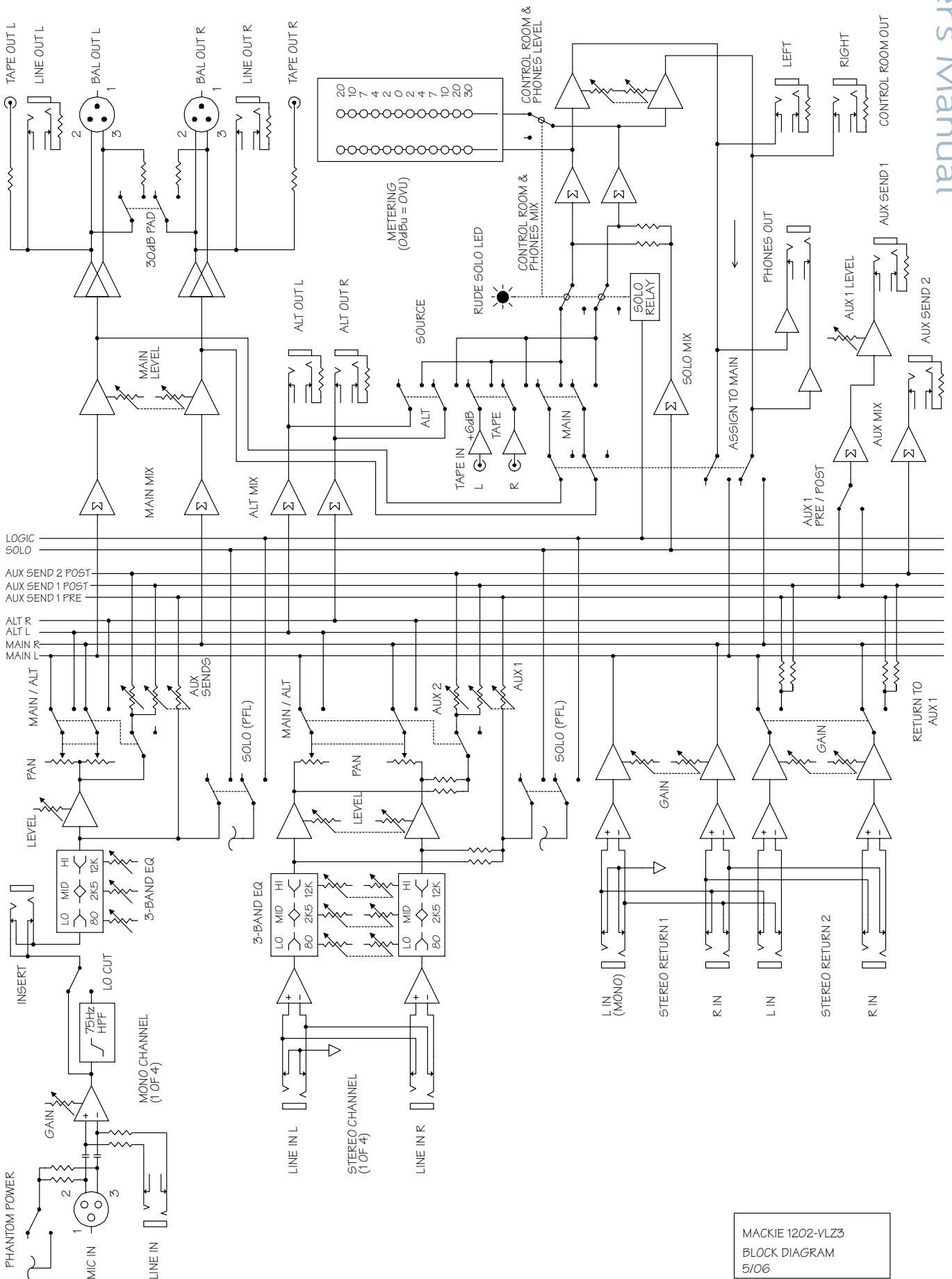

MACKIE 1202-VLZ3
BLOCK DIAGRAM
5/06

Mackie Limited Warranty

Please keep your sales receipt in a safe place.

This Limited Product Warranty ("Product Warranty") is provided by LOUD Technologies Inc. ("LOUD") and is applicable to products purchased in the United States or Canada through a LOUD-authorized reseller or dealer. The Product Warranty will not extend to anyone other than the original purchaser of the product (hereinafter, "Customer," "you" or "your").

For products purchased outside the U.S. or Canada, please visit www.mackie.com/warranty to find contact information for your local distributor, and information on any warranty coverage provided by the distributor in your local market.

LOUD warrants to Customer that the product will be free from defects in materials and workmanship under normal use during the Warranty Period. If the product fails to conform to the warranty then LOUD or its authorized service representative will at its option, either repair or replace any such nonconforming product, provided that Customer gives notice of the noncompliance within the Warranty Period to the Company at: www.mackie.com/support or by calling LOUD technical support at 1.800.898.3211 (toll-free in the U.S. and Canada) during normal business hours Pacific Time, excluding weekends or LOUD holidays. Please retain the original dated sales receipt as evidence of the date of purchase. You will need it to obtain any warranty service.

For full terms and conditions, as well as the specific duration of the Warranty for this product, please visit www.mackie.com/warranty.

The Product Warranty, together with your invoice or receipt, and the terms and conditions located at www.mackie.com/warranty constitutes the entire agreement, and supersedes any and all prior agreements between LOUD and Customer related to the subject matter hereof. No amendment, modification or waiver of any of the provisions of this Product Warranty will be valid unless set forth in a written instrument signed by the party to be bound thereby.

MACKIE®

16220 Wood-Red Road NE • Woodinville, WA 98072 • USA

United States and Canada: 800.898.3211

Europe, Asia, Central and South America: 425.487.4333

Middle East and Africa: 31.20.654.4000

Fax: 425.487.4337 • www.mackie.com

E-mail: sales@mackie.com