

Variac

ACOUSTIC

Pilot's Handbook

Before using your Variax you should read these Important Safety Instructions. Keep these instructions in a safe place.

1. Obey all warnings in this Pilot's Handbook.
2. Do not place near heat sources, such as radiators, heat registers, or appliances which produce heat.
3. Guard against objects or liquids.
4. To avoid damage to Variax's Digital Communications Connector, always use Line 6 supplied cables and replace the protective end cap when not in use.
5. Power the XPS Footswitch only with the included PX-2 Power Supply or equivalent.
6. Connect the PX-2 Power Supply only to AC power outlets rated 100-120V or 230V 47-63Hz (depending on the voltage range of the included power supply).
7. Do not step on power cords. Do not place items on top of power cords so that they are pinched or leaned on.
8. Unplug your Variax Acoustic and XPS Footswitch when not in use for extended periods of time.
9. Do not perform service operations beyond those described in the Variax Acoustic Pilot's Handbook. Repairs and service operations beyond the scope of those in the Pilot's Handbook should be performed only by qualified service personnel.
10. Prolonged listening at high volume levels may cause irreparable hearing loss and/or damage. Always be sure to practice "safe listening."

Your Variax should include these accessories:

Gigbag, XPS Footswitch, PX-2 Power Supply, TRS Cable, Bridge Saddle Wrench, Truss Rod Wrench

WARNING: To reduce the risk of fire or electric shock, do not expose this appliance to rain or moisture.

CAUTION: No user-serviceable parts inside. Refer servicing to qualified service personnel.

CAUTION: This equipment has been tested and found to comply with the limits for a Class B digital device pursuant to Part 15 of FCC Rules. Operation is subject to the following two conditions: (1) This device may not cause harmful interference, and (2) this device must accept any interference received, including interference that may cause undesired operation.

Please Note:

Line 6, Variax Acoustic, Variax, POD, and the Line 6, Variax Acoustic and Variax logo are trademarks of Line 6, Inc. All other product names, trademarks, and artists' names are the property of their respective owners, which are in no way associated or affiliated with Line 6. Product names, images, and artists' names are used solely to identify the products whose tones and sounds were studied during Line 6's sound model development for this product. The use of these products, trademarks, images, and artists' names does not imply any cooperation or endorsement.

Table of Contents

Welcome to Variax 1-2

Basic Operations..... 3-6

Connections

Battery Power

XPS Direct Box Operation

Primary Controls 7

Volume

Mic Position

Compressor

Model Select

Instant Alternate Tuning..... 8-10

Preset Tunings

Custom Tunings

Save Our Sounds..... 11

The Guitars of Variax Acoustic 12-28

Care and Maintenance.....29-30

Customer Service 32

Warranty Information..... 33

Welcome to Variax Acoustic

Thanks for buying a Variax Acoustic and joining us in our quest to apply the miracle of modern technology to the pursuit of great acoustic guitar tone. You now own detailed models of some of the most distinctive acoustic instruments of all time—wrapped up in a single comfortable and highly playable guitar.

How does it work?

How do we get so much great acoustic sound from the compact Variax Acoustic? We use piezo bridge saddles, similar to the piezo pickup in many electric-acoustic guitars, to capture each individual string's vibrations. We then process the signals through software algorithms that capture the physical properties of the guitars that we've modeled.

This process dynamically alters Variax Acoustic's own natural string vibrations in real time to match the modeled instrument's unique tonal characteristics. That means there's no delay caused by having to detect a pitch and turn it into a MIDI note, and there's also no issue with tracking hammer-on's, pull-off's, slides, bends, slurs or any other techniques that are a part of your style.

How did we manage to capture the tonal souls of

these classic instruments for instant recall from your Variax Acoustic? We're glad you asked....

The Dream...

Several years before Variax Acoustic was born, we turned our attention from the PODs, amps, and effects that we had been developing to take a fresh look at the guitar itself. We wondered—could it be possible to capture a complete range of guitar tone in a single instrument? After a couple of years of research, development, and countless hours playing dozens of vintage electric and acoustic guitars, we released the original Variax, the world's first modeling guitar. But while the Variax is perhaps the ultimate general-purpose guitar, we also wanted to specifically address the unique needs of the acoustic musician.

How, we asked ourselves, can we use modeling technology to improve such a traditional instrument?

The first requirement, of course, would be sound. Since this new instrument would be dedicated entirely to acoustic instruments, we developed new algorithms that use all of the power of the Variax brain to authentically re-create the complex timbres of the vibrating strings and resonant bodies of the guitars we were modeling.

Next, we decided to tackle a problem that had plagued acoustic guitarists since the advent of electrified music—how to get a great acoustic sound on-stage and in the studio. With our unique Mic Position control, you can adjust your tone the way professionals do—by changing mic position. And since our mic is a DSP algorithm, you don't have to worry about feedback or noise leakage.

Another key ingredient to both live and recorded acoustic instrument sound is compression. To further simplify the life of the Variax Acoustic owner we decided to add a remarkably effective, yet simple to operate compressor.

Many acoustic guitarists are fond of alternate tunings, but re-tuning during a performance can often become—literally—a show-stopper. To remove this obstacle from between you and your creativity, we gave the Variax Acoustic the ability to re-tune for you, at the press of a button.

The Journey

Once we had decided what we wanted the Variax Acoustic to do, we then had to figure out how to make it work. As we refined the modeling techniques we developed for the original Variax, we created a guitar that would feel (and look) right

for the wide variety of musical environments in which this instrument would live.

A guitar this different, with so many unique abilities, deserved an equally unique approach to its on-board controls. So we worked out a way to give the player simple ways to optimize the sound for specific techniques and musical contexts. And easy access to the memory and alternate tuning functions that make the Variax Acoustic so amazingly convenient. And of course, to fill our instrument with the sounds of so many archetype acoustics, we had to audition truckloads of vintage guitars to find the ones with just the right sound. Just as we did with the original Variax, we refined our models while constantly referring back to the originals for accuracy. When each model reached the point of not only sounding like the original, but also being as much fun to play, it was done.

The result of our labors? Variax Acoustic. An entire acoustic collection in a single instrument.

Basic Operations

Connections

You may have already noticed that the Variax Acoustic has two output connectors: a familiar 1/4-inch jack and a second RJ45 jack protected by a rubber cap. The RJ45 connector will be the way you will connect to Line 6 products with a “Variax” input, and add additional sounds and abilities to your Variax Acoustic in the future. The uses of the RJ45 connection will be described in the owners manual for the products that offer that input; all of the operations described in this manual will use the 1/4-inch output.

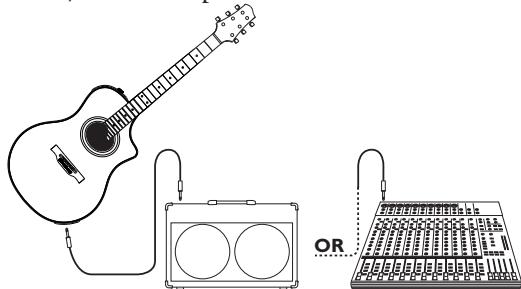

Simple Operation

The simplest way to use the Variax Acoustic is to connect it directly to the mixer or an acoustic amplifier with a standard mono guitar cable.

Battery Power

Of course, the electronics of the Variax Acoustic will need power, so to use this simple hookup, you'll need to install six AA cells in the on-board battery compartment. If you use fresh alkalines, you should get approximately 10-12 hours of operation.



Battery Low Indication

Being surprised by a battery failure is no fun, so we give you a warning when your AA's are failing. The indicator LED, if green, will give a short red blink about once every second. If it's red, it will give a short green blink about once every second. More on the indicator LED later...

The battery will only be used when a standard guitar cable is connected. For longest battery life, always "turn off" your Variax Acoustic by unplugging it when not in use.

NOTE: At the gig with no AA batteries? Unclip the plastic battery holder from the connector and swap in an ordinary 9V battery. This "emergency" setup will give 1 to 2 hours of battery life.

XPS Direct Box Operation

We realize that constantly changing batteries can be a real drag, so we included a more convenient option—the unobtrusive yet capable XPS.

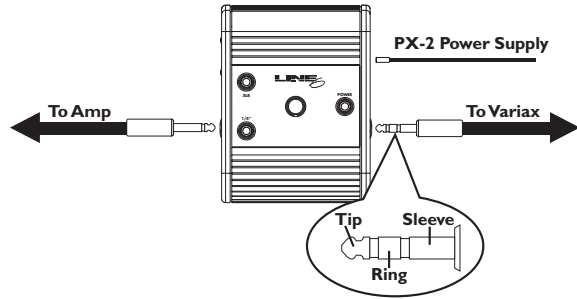

Powering your Variax Acoustic with the XPS is easy. Use the included TRS cable (meaning "Tip-Ring-Sleeve" or also simply known as a "stereo" cable) to connect the Variax Acoustic to the **INPUT** jack of the XPS. Connect the PX-2 power supply to the XPS **POWER** jack, and use a standard mono guitar cable to connect the XPS's 1/4-inch **OUTPUT** to your acoustic amp or mixer.

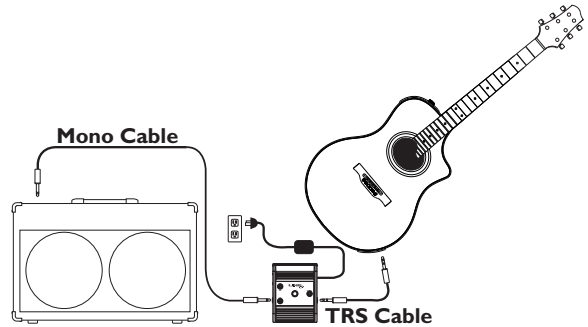

Use a standard XLR/mic cable to connect the XPS's **XLR** output to feed a mixer or recorder's input with a balanced, +4dBu "line level" signal. While you can also connect this to some acoustic guitar amps, you may get better results with the 1/4-inch cable, because most amps like to receive a lower level signal than the XPS's **XLR** puts out.

The XPS can also work as either an A/B or a Standby switch. If, for example, you want to send your **DREADNOUGHT** sound to the PA but want to send your **ROUNDNECK** sound to an acoustic amp, just use the switch: When the 1/4" indicator light is lit on your XPS, you've got your signal routed to the 1/4" **OUTPUT**. When the XLR

indicator light is lit, your signal will now be routed to the XLR OUTPUT. If you are only using one of the outputs, selecting the other one is a handy way to mute your output.

The Phantom Menace

When sending the XLR output of the XPS to a mixing board, be sure that phantom power is either off or not supplied to the XPS. Since phantom power puts a healthy voltage on the cable, using the A/B switching function of the XPS will produce a very unhealthy pop in the speakers. The soundman will not be pleased.

XLR Hum

The XLR output of the XPS is designed to connect to the balanced inputs that are typical on good quality mixers and recording systems. Connecting the XLR output to a device with an un-balanced input may cause hum on that device when the XPS 1/4-inch output is selected.

Cable Specifications

If you happen to lose the Custom Cable supplied with your Variax Acoustic, you can obtain a replacement from Line 6 Customer Service (see page 32 of the Pilot's Handbook for contact information). You can also simply use any high-

quality TRS cable up to 18 feet in length.

NOTE: If you have batteries installed in your Variax Acoustic, they will be bypassed when using your XPS Direct box. If the guitar is connected to the XPS and the XPS power is disconnected, any batteries installed in the Variax acoustic will be drained.

**XLR Cable
To P.A., Mixer or Recorder**

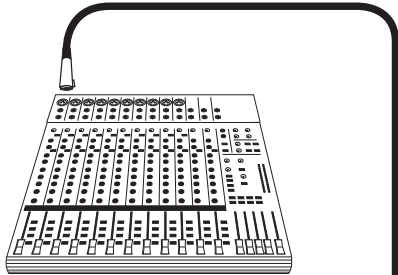

To Amp - Mono Cable

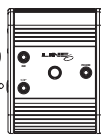
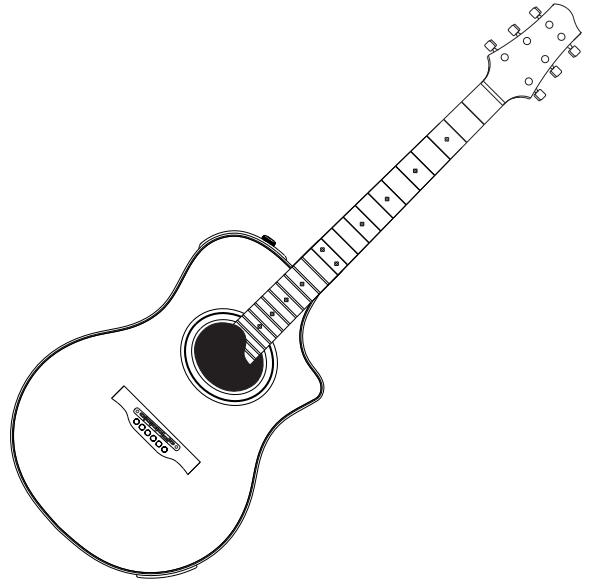
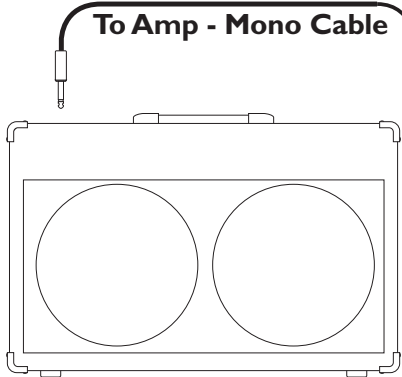

TRS Cable

Primary Controls

Let's start simple, and work up to the fancy stuff:

Volume

The center slider is also the most important. Push it toward the Model Select knob to get louder. Pretend to push it away from the Model Select knob when people ask you to turn down.

Mic Position

The top slider (the one furthest away from you when you hold the guitar) allows you to alter the position of the modeled microphone. Here's a simple way to remember how it works: As you move the slider closer to the soundhole (away from the Model Select knob), the Mic Position is also getting closer to the soundhole. Some of the instruments modeled in the Variax Acoustic don't have a soundhole, but the control will work similarly for these instruments. When the slider is close to the Model Select knob, the strings (and upper frequencies) are emphasized; when the slider is close to the soundhole, the body (and lower frequencies) are emphasized.

Compressor

The bottom slider allows you to change the level of compression. A compressor usually has a lot of controls to adjust, but we take care of all the

complicated stuff for you. Just push the slider toward the Model Select knob for more compression, and away from the knob for less.

Model Select

The Model Select knob has several functions. First of all, it allows you to choose the active instrument model. Rotate the knob to choose from the 16 Variax Acoustic models. The name visible in the slot is the active model. The LED will help you see the name on dark stages, or in the closet if you are very shy. The Model Select knob also lets you engage the Instant Alternate Tuning function. With a quick press on the knob, the LED will change from green to red. Now, none of the notes are where you thought they were! To learn the method to our madness, refer to the next section, **Instant Alternate Tuning**. But wait, there's more: The Model Select knob also lets you save any customizations you have carried out. More on that in the upcoming **Save Our Sounds** section

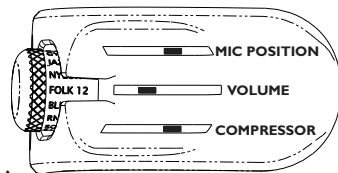

Instant Alternate Tuning

Many guitarists, especially acoustic guitarists, play in tunings other than the familiar EADGBE. Rather than deal with the hassles of retuning during a performance or transporting multiple guitars, wouldn't it be great to have a guitar that could retune itself automatically? We thought so too, so we included this function on the Variax Acoustic. Of course, this magic is performed on the output signal only. The physical strings are unchanged...and you're still responsible for being in tune. For the most pleasant experience, you'll want to have your amplified signal loud enough to drown out the sound of the physical strings. You should keep in mind that the retuning is relative to the actual strings. If you tune the actual strings of the Variax Acoustic something besides EADGBE, and apply one of the tuning presets, you're going to get some unexpected, though not necessarily unmusical, results.

A few of the models included in the Variax, like the 12 strings and exotic instruments, won't let you retune the pitch of the strings. For these models, Alternate Tuning gives you control over other aspects of the sound. For details, see the Model Descriptions section.

Engaging Alternate Tuning is simple: All it takes is a quick press on the Model Select knob. The indicator LED will change from green to red to let you know something is up. When you first engage the Alternate Tuning, you'll hear whatever tuning we saved to that particular model. But since we know you're going to want to change that, turn the page for the not-so-gory details.

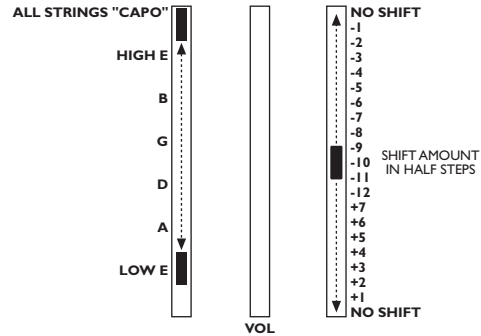
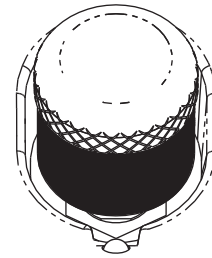
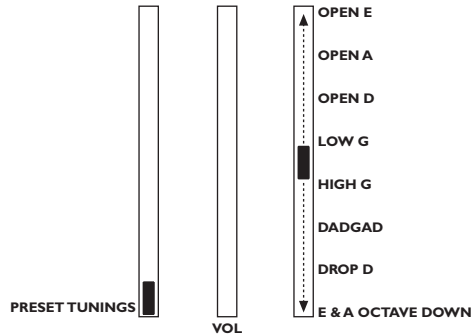
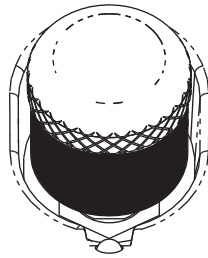

We made it easy to get to some of the most commonly used alternate tunings. First, enter the Alternate Tuning Set-Up mode with a quick double press on the model select knob. The LED will flash red-green-red-green to let you know you are in this mode. With the bottom (COMPRESSOR) slider all the way down, choose the tuning you want with the top (MIC) slider.

Of course, part of the fun of alternate tunings is being different, so we give you the ability to retune any of the strings up to a 5th (7 half steps) higher or up to an octave (12 half steps) lower. Enter Alternate Tuning Set-Up with a quick DOUBLE press on the Model Select knob. Select the string you want to tune with the bottom (COMPRESSOR) slider. The selected string will

be louder than all of the others, so the easy way to select a string is to pluck it while moving the slider until you hear it get louder. The other strings will still be audible to assist you in selecting the right interval.

Use the top (MIC POSITION) slider to change the interval. With the slider at either extreme, there is no retuning. Moving the slider away from the model select pot lets you lower the pitch in half step increments; Moving it toward the model select pot lets you raise the pitch in half step increments. To find your desired retuning, listen for the steps, and use the strings not being retuned as a reference. Here's an example: Let's say you want to retune to play the live version of The Rain Song, and you know the tuning is (low to high) EADADE. So you'll be raising the pitch of the G string two half steps to A, and raising the pitch of the B string three half steps to D. Starting with the Model you want to use this tuning with, give the Model Select Knob two quick presses to get into the Custom Tuning mode. The LED will be blinking red-green-red-green to let you know you are in this mode. Pluck the G string, and move the lower (COMPRESSOR) slider until you hear that string get louder. Move the upper (MIC POSITION) slider as far as possible from the Model

Select knob. Then move the slider back toward the Model Select knob until you hear the pitch change twice. Check the note against your 5th (A) string to confirm the pitch. Repeat the process for the B string, except this time move the slider until you hear the pitch change three times, and check the note against your 4th (D) string.

When the COMPRESSOR slider is in the position closest to the Model Select Knob, all strings are being retuned at once - think of this as a special capo that lets you tune higher and lower. Select all of the strings for tuning, and drop them an octave - instant bass!

With your custom tuning all set, just press the Model Select knob once to leave Alternate Tuning Set-Up mode. You are now back in regular "Play" mode, with the Alternate Tuning on - notice the red LED. A quick press on the Model Select knob, and the Alternate Tuning goes away - notice the green LED. Another quick press - presto - Alternate Tuning returns, just as you left it. When you have an Alternate Tuning you like, you're going to want to save it - so don't stop reading now...

Save our Sounds

To really take advantage of the sonic capabilities of the Variax Acoustic, especially when performing, you want each instrument model to be set up for your specific needs. Use the Customize function of Variax Acoustic's model knob to get all sixteen models sounding just the way you want.

1. Choose which of the 16 instrument models you want to customize.
2. Find a Mic position and Compressor setting that suit your needs.
3. Select an Alternate Tuning in Alternate Tuning Set-Up, if desired.
4. Switch Alternate Tuning on or off, depending on how you want it to be saved.
5. Press the Model Select Knob down and hold for a few seconds until the indicator LED shines solid green or red.
6. Release the Model Select knob.

That's all there is to it. You've saved your settings for that model. Now that you've got it all down, you can repeat these steps for the remaining 15 positions. (Or not, if you like the factory settings.) And if your needs or tastes change, you can re-customize any of your models as often as you like.

The Guitars of Variax Acoustic

Now that you have a firm grasp on the operational details, let's take a slightly closer look at the models available with a simple twist of your MODEL SELECT knob.

You'll see a diverse range of instruments on the following pages, from no-frills workhorses to the upper echelons of collectibility. And a few exotic oddities that most of us don't even know how to tune, much less play.

With the Variax Acoustic, you won't get the vintage patina or the strangely erotic musty case smell, but you won't have to deal with the neck re-sets and cracked tops either. Instead, you get only the very best part: the sound.



PARLOR

based on 1941 Martin® 5-17

Introduced 1898

All mahogany body, rosewood fingerboard
21 3/8" scale

Before the days of audio recording, radio, or internet file sharing, the only way to hear music was for someone to play it. Parlor instruments were designed to be kept in homes for the musical amusements of residents and guests. A wide variety of parlor guitars were available from a number of manufacturers, but they are all distinguished by their small size and even, balanced tone. The 5 was one of the smallest, and was often used tuned a major third over standard tuning. Marty Robbins was a prominent user of the size 5 in the early 1960's.



-
- 13 Martin is a registered trademark of C.F. Martin & Co., Inc. and is in no way associated or affiliated with Line 6. The product name, descriptions and images are provided for the sole purpose of identifying the specific products that were studied during Line 6's sound model development.

TRIPLE O

based on 1946 Martin® 000-28

Introduced 1902

Brazilian rosewood back and sides, ebony fingerboard
24.9" scale

The evolution of musical styles in the early 20th century was mirrored by the evolution of American guitar design. By combining larger bodies and steel strings with its innovative X bracing, Martin® created the modern flat-top acoustic. The unique tonal properties of the 000 make it ideal for music in which the guitar is the dominant instrument. In recent years, electric rock artists like Eric Clapton have chosen the 000-28 for unplugged performances.



Martin is a registered trademark of C.F. Martin & Co., Inc. and is in no way associated or affiliated with Line 6. The product name, descriptions and images are provided for the sole purpose of identifying the specific products that were studied during Line 6's sound model development. **14**

DREAD

based on 1960 Martin® D-21

Introduced 1955

Brazilian Rosewood back, sides, and fingerboard

25.4" scale

The “D” or dreadnought guitar has been around since 1916, but its loud bass and large body did not make it popular for the musical style of the time. As music continued to evolve, Martin® Dreadnoughts, particularly the D-18 and D-28, became the instrument of choice for folk, bluegrass, country, and rock.

The 21 series used similar materials to the 28 series, but with simplified ornamentation and a rosewood fingerboard. This particular specimen puts to rest the myth that postwar Martin® instruments are tonally inferior to their prewar brethren.



-
- 15 Martin is a registered trademark of C.F. Martin & Co., Inc. and is in no way associated or affiliated with Line 6. The product name, descriptions and images are provided for the sole purpose of identifying the specific products that were studied during Line 6's sound model development.

JUMBO

based on 1954 Gibson® J-45®

Introduced 1941

Mahogany back and sides, rosewood fingerboard
24 3/4" scale

Gibson® added flat-tops to its product line in the mid 1920's, and by the mid thirties had introduced the classic Jumbo series. Though one of the less ornate of the Jumbo family, the distinctive sunburst finish and warm tone of the J-45® made it perhaps the most successful model of their diverse acoustic range.



Gibson, J-45, SJ, and Dobro are registered trademarks of Gibson Guitar Corp. and are in no way associated or affiliated with Line 6. These product names, descriptions and images are provided for the sole purpose of identifying the specific products that were studied during Line 6's sound model development. **16**

C & W

based on 1951 Gibson® SJ®-200

Introduced 1938

Maple back and sides, ebony fingerboard

25 3/8" scale

The Gibson® “Super Jumbo” was conceived as the ideal stage companion for singing cowboys and was developed with the input of Western actor, singer, and songwriter Ray Whitley. It’s enormous size, ostentatious ornamentation, and rich sound made it a favorite of artists like Tex Ritter, Elvis Presley, and Emmylou Harris.



GYPSY

based on 1933 Selmer® Maccaferri

Introduced 1932

Rosewood back and sides, ebony fingerboard

648mm scale

Italian guitarist and luthier Mario Maccaferri designed his best known instrument during his short association with Selmer®, a French manufacturer. The distinctive cutting tone of these unique bent-top guitars was used to great effect by legendary gypsy guitarist Django Reinhardt. We've modeled the first "D-Hole" version, without the controversial internal resonator.



Selmer is a registered trademark of Conn-Selmer, Inc. and is in no way associated or affiliated with Line 6. The product name, description and image are provided for the sole purpose of identifying the specific products that were studied during Line 6's sound model development. **18**

JAZZ

based on 1951 D'Angelico™ New Yorker

Introduced 1936

Figured maple back and sides, ebony fingerboard
25 3/4" scale

New York luthier John D'Angelico started making Gibson® derivative archtops in 1932, but in a few short years had developed his own models. With its 18 inch body and ornate yet tasteful appointments, the D'Angelico™ New Yorker is the epitome of the arch-top jazz guitars for many connoisseurs. The instrument we modeled formerly belonged to Ray Gogarty, Brian Setzer's guitar teacher.



D'Angelico is a trademark of G.H.S. Corp. in the United States.

19 D'Angelico is a trademark of D'Angelico Guitars of America LLC, registration is pending in the CT.

NYLON

based on 1958 Manuel Velazquez™

Introduced 1930's

Brazilian rosewood back and sides, ebony fingerboard

640mm scale

One of America's most respected classical luthiers, Manuel Velazquez has been called the "dean of luthiers" for the balance and clarity of his instruments. Velazquez instruments are built in the Torres/Hauser tradition and notable for quality rather than innovation.



All product names are trademarks of their respective owners, which are in no way associated or affiliated with Line 6. These product names, descriptions and images are provided for the sole purpose of identifying the specific products that were studied during Line 6's sound model development. **20**

FOLK 12

based on 1973 Guild® F412

Introduced late 1960's

Arched maple back, maple sides, ebony fingerboard
25 5/8" scale

While many 12-string guitars seem to be the result of simply adding extra strings to an existing six string model, Guild® 12-strings were actually designed as 12-string guitars from the ground up. The wide fingerboard offered enough room to fret cleanly, and the jumbo body provided the elusive combination of volume and clarity. To hear a Guild® 12-string in action, check out the intro to “And You and I” from Yes album Close to the Edge.

Alternate Tuning Setup works differently for the FOLK 12 and a few other models. You won't be able to change the pitch of the strings, but you can customize the sound in other ways. See BLUES 12 for details.



-
- 21 Guild is a registered trademark of Fender Musical Instruments Corporation and is in no way associated or affiliated with Line 6. The product name, description and image are provided for the sole purpose of identifying the specific products that were studied during Line 6's sound model development.

BLUES 12

based on 1935 Stella® Auditorium

introduced 1935

Birch back and sides

26 3/8" scale

The Stella® brand guitars before 1940 have achieved legendary status despite the fact that they were originally budget instruments. The 12-strings are especially prized because of their association with blues artists like Huddie "Leadbelly" Ledbetter. The long scale made these guitars especially suitable for low tunings, over half a century before the advent of Nü Metal.

For the BLUES 12 and FOLK 12 models, Alternate Tuning Setup works as described in the illustration. "Mix" gives you control of the loudness of the octave string set, and "Separation" gives you control of detuning between the strings in each pair.

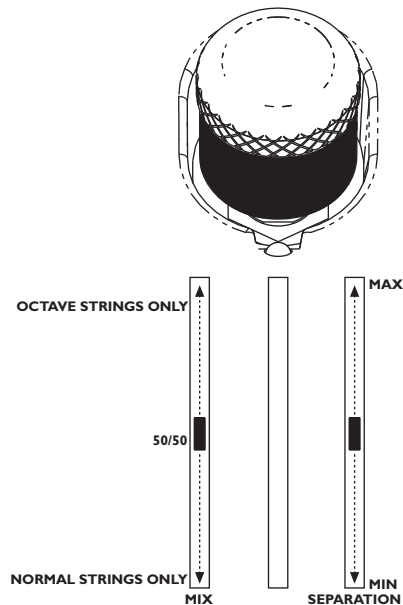

Stella is a registered trademark of Harmony Industries, Inc. and is in no way associated or affiliated with Line 6. The product name, description and image are provided for the sole purpose of identifying the specific products **22** that were studied during Line 6's sound model development.

RND NECK

based on

1939 National Reso-Phonic™ Style "O"

Introduced 1930

Nickel plated Brass Body

25 3/8" scale

The Style "O" was developed as a simpler and less expensive alternative to their mechanically complex Tricone instruments.

Though the convoluted relationship between National Reso-Phonic™ and Dobro® make precise distinctions difficult, single-cone Nationals are now usually associated with Delta blues, and musicians like Son House.



23 National Reso-Phonic is a trademark of National Reso-Phonic Guitars, Inc. and is in no way associated or affiliated with Line 6. The product name, description and image are provided for the sole purpose of identifying the specific products that were studied during Line 6's sound model development.

SQUARE NECK

based on 1937 Dobro® Model 27

Introduced 1934

Birch back and sides

24 2/4" scale

John Dopyera formed Dobro® (short for "Dopyera Brothers") to compete with his former partners at National Reso-phonic™. To overcome what he felt were deficiencies in single cone guitars, John designed an aluminum "spider" to transfer vibrations to the edge, rather than the center, of the cone. This arrangement produced a sweeter sound with more sustain. Dobro® wood-bodied instruments are associated with bluegrass music and musicians like Bashful Brother Oswald.



Gibson, J-45, SJ, and Dobro are registered trademarks of Gibson Guitar Corp. and are in no way associated or affiliated with Line 6. These product names, descriptions and images are provided for the sole purpose of identifying **24** the specific products that were studied during Line 6's sound model development.

BANJO

inspired by the Gibson® Mastertone

Introduced 1925

Maple Ply Rim, Figured maple resonator

26 3/8" scale

The innovative tone ring gave the Gibson® Mastertone the power to cut through the loudest bluegrass band. The Mastertone series quickly became the definitive Bluegrass banjo, due in no small measure to a long-standing association with virtuoso Earl Scruggs.



25 Gibson, J-45, SJ, and Dobro are registered trademarks of Gibson Guitar Corp. and are in no way associated or affiliated with Line 6. These product names, descriptions and images are provided for the sole purpose of identifying the specific products that were studied during Line 6's sound model development.

MANDOLA

inspired by the Mandolin Family

introduced 19th century

25" scale

Around the beginning of the 20th century, a peculiar form of mass hysteria swept the United States called mandolin orchestras. In these ensembles, mandolins functioned as violins, mandolas were used as violas, and mandocellos played the part of cellos. While the mandolin itself is still a main ingredient in bluegrass, the rest of the family (and the similar bouzouki) are now often used for folk, celtic, and Middle Eastern music.

In the MANDOLA model, Alternate Tuning Setup follows the 12 string pattern.

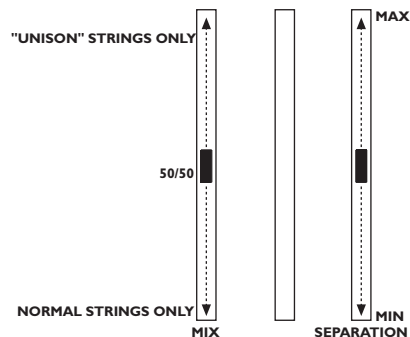
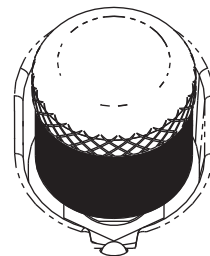
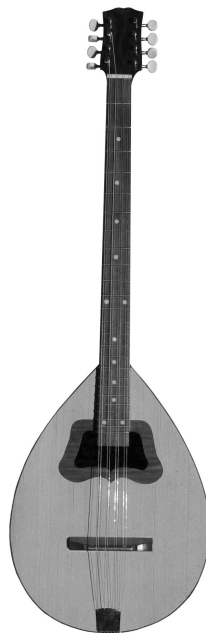

All product names are trademarks of their respective owners, which are in no way associated or affiliated with Line 6. These product names, descriptions and images are provided for the sole purpose of identifying the specific products that were studied during Line 6's sound model development. **26**

SHAMISEN

inspired by the Japanese Shamisen

Introduced 16th Century

various body woods, catskin or dogskin heads

The shamisen, essentially a three-stringed fretless banjo played with an ice-scraper sized plectrum, is closely related to the Chinese sanxian and Okinawan shanshin. No samurai movie soundtrack would be complete without at least a few poignant notes from this instrument.

Part of what makes the Shamisen sound unique is that the notes go flat when plucked, but then return to pitch as the note sustains. The special Alternate Tuning Setup mode for this model let's you fine tune this aspect of the sound. "Detune" controls how flat the note goes, and "Settle Time" controls the speed at which it returns to normal pitch.

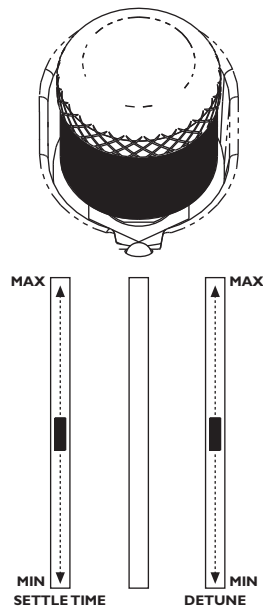

SITAR

inspired by the Indian Sitar

introduced late Mogul era (circa 1700)
pumpkin body and resonator
scale varies with pumpkin size

Still very popular in Northern India, the unique buzz of the sitar is used in Indian classical, folk, and popular music. The sitar is widely recognized in the west largely because of the brilliant performances and recordings of Ravi Shankar.

We've tuned the drone strings chromatically, so the Sitar model will work in any key. The Alternate Tuning Setup mode for this model lets you vary the volume of the drone strings with "Drone Level", and fine tune them with "Drone Tuning".

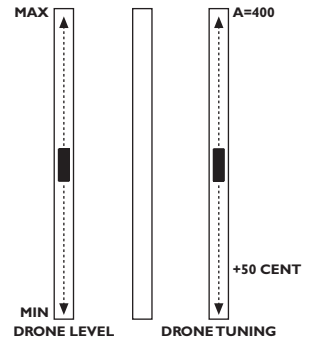
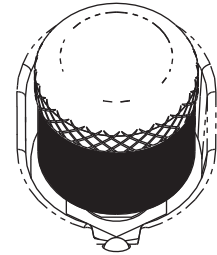

All product names are trademarks of their respective owners, which are in no way associated or affiliated with Line 6. These product names, descriptions and images are provided for the sole purpose of identifying the specific products that were studied during Line 6's sound model development. **28**

Care and Maintenance

Only a few simple measures are required to keep your Variax Acoustic looking and performing like new.

- After playing, wipe down the guitar and strings with a clean, soft cloth.
- Change strings when they become discolored or the guitar begins to sound dull.
- Occasionally clean the fingerboard surface with lemon oil and the painted surfaces with guitar or furniture polish.

Neck Relief Adjustment

Depending on where you live, seasonal temperature and humidity variations may make it necessary to adjust the neck relief of the Variax. If you find that your Variax suddenly starts buzzing or is generally difficult to play, it may be time for this kind of adjustment. To check the neck relief, press the high E string to the first fret with your left hand, and press the same string to the last fret with your right hand. While holding the string at both points, check the point where the E string passes over the 10th fret. If the string is touching the fret, or if there is more space under the string than the

thickness of a thin pick, it's time to adjust the neck.

If you are familiar with this kind of adjustment, remove the truss rod cover and use the supplied wrench to adjust the truss rod. If the string was touching at the 10th fret (too little relief), turn the rod counterclockwise. If the gap was too great (too much relief), turn the rod clockwise. In both cases, make small adjustments and check the relief as you go. Never force the rod to turn—excessive tightening can damage your Variax. If you are unfamiliar or uncomfortable with this kind of adjustment, ask your local guitar shop to refer you to a qualified guitar tech.

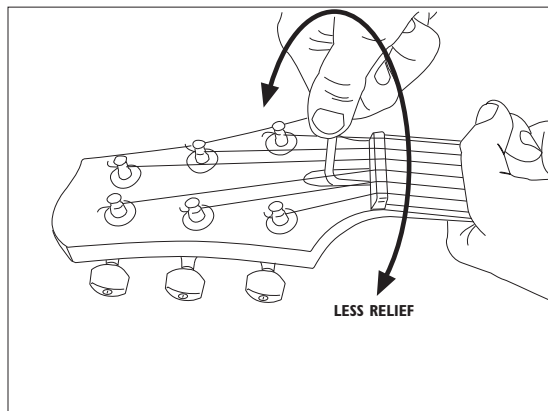

Action Adjustment

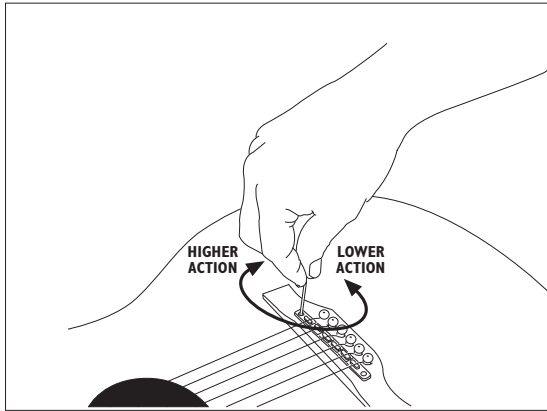

Variac Acoustic leaves the factory adjusted for playability across a wide range of playing styles. The bridge saddle height can be adjusted to optimize playability for a particular style. If you are familiar with this kind of adjustment, use the supplied Allen wrench to raise or lower the bridge saddle screws as shown. As with neck adjustment, if you are unfamiliar with this kind of adjustment, ask your local guitar shop to refer you to a qualified guitar tech.

Customer Service

Before contacting the Line 6 Customer Service team, please take the time to look through this publication to see if it can answer your questions. Additional helpful information is on the Support page of the Line 6 web site (www.line6.com), including the searchable FAQTRAQ system which is often the fastest and easiest way to get answers.

If you need to talk to an actual human on the Line 6 Customer Service team by phone, it will generally help to take some notes for yourself before you call, to insure that you remember everything you want to ask about. In the USA or Canada, you can contact Line 6 at (818) 575-3600, 8AM to 5PM Monday through Friday (Pacific Time). Outside the USA and Canada, please contact your distributor directly to arrange service. The list of Line 6 distributors is available on the Internet at www.line6.com.

To obtain factory service:

If a member of the Line 6 Customer Service Team determines that your Variax needs to be sent to Line 6 for service, you will be given a return authorization (RA) number. Products returned without an RA number will be returned to you at your sole expense. Pack the product in its original shipping carton and attach a description of the problem along with your name, address and a phone number where Line 6 can contact you if necessary. Ship the product insured and freight prepaid to:

Line 6 Customer Service
6033 De Soto Avenue
Woodland Hills, CA 91367

Line 6 Warranty Policy

Line 6, Inc. (hereinafter "Line 6") warrants that your new Line 6 instrument shall be free of defects in workmanship and materials for the lifetime of the product and that the electronics contained within the instrument (printed circuit boards, piezo saddles, potentiometers, etc.) shall be free from defects in workmanship and materials for a period of one (1) year from the original date of purchase. In addition, the accessories (carrying case, power supply, and footswitch) shall be free of defects in workmanship and materials for a period of one (1) year from the original purchase date. This warranty is extended to the original retail purchaser only and may not be transferred or assigned to subsequent owners. In order to validate your warranty, and as a condition precedent to warranty coverage hereunder, a copy of the original sales receipt must accompany all warranty requests. This warranty policy is valid only when a new Line 6 instrument is purchased from an Authorized Line 6 dealer. This warranty is subject to the following exceptions and/or limitations:

This warranty does NOT cover:

1. Any instrument that has been altered or modified so that the serial number, name, identification numbers or logos have been tampered with or are missing.
2. Instruments or accessories not purchased from an Authorized Line 6 dealer.
3. Standard maintenance and adjustment of the instrument, electronics and action. Standard adjustments and maintenance are the sole responsibility of the owner.
4. Any defects in the instrument or accessories that are caused by or are the result of a lack of maintenance or adjustment.
5. Any instrument or accessory that has been repaired, altered or modified by a repair facility that is not authorized by Line 6, or any repairs, alterations, or modifications, regardless of the origin, that Line 6 has not approved.
6. Any damages to the instrument or accessory that is a result of abuse, accident or misuse, as determined by Line 6 in its sole discretion.
7. Any issues regarding the tonal aspects of the instrument. Tone is a product of perception and therefore cannot be warranted. Issues regarding the authenticity or interpretation of the models used also cannot be warranted.
8. Damages (due to shipping or otherwise) to the instrument or accessories that relate to improper storage or transportation.
9. Any failures to either the instrument or accessories that are a result of exposure to extreme conditions (including, without limitation, humidity, sunlight, bodily fluids, unapproved cleaning solutions or solvents, temperature and/or adhesives).
10. Any failures to either the instrument or accessories that are a result of normal "wear and tear" (including, without limitation, strings, fret wear, finish damage, potentiometers and connectors, pick guard, bridge, machine heads, finger board and carrying case).

If you feel that you have a warranty issue, please contact Line 6 or your authorized Line 6 dealer or distributor. Line 6 may issue a Return or Repair authorization as needed. No instrument or accessory will be accepted at the Line 6 facility for repair without (i) prior receipt of your original sales receipt, (ii) proper authorization by Line 6 or an authorized Line 6 dealer or distributor, and (iii) a Return Authorization number. Line 6 will refuse shipment of any instrument that is received without the foregoing three (3) prerequisites. Line 6 will repair or replace your instrument at its sole discretion. Parts that are replaced under this warranty are warranted for ninety (90) days or the remainder of the warranty period, whichever is longer. Line 6 reserves the right to use reconditioned parts and assemblies as warranty replacements for authorized repairs. All shipping charges to any repair facility are the sole responsibility of the owner of the instrument or accessory. Line 6 reserves the right to update any unit returned for repair, and reserves the right to change or improve the design of the product at any time without notice. This is your sole warranty. Line 6 does not authorize any third party, including any dealer or sales representative, to assume any liability on behalf of Line 6 or to make any warranty for Line 6.

DISCLAIMER AND LIMITATION OF WARRANTY: THE FOREGOING WARRANTY IS THE ONLY WARRANTY GIVEN BY LINE 6 AND IS IN LIEU OF ALL OTHER WARRANTIES. ALL IMPLIED WARRANTIES, INCLUDING WARRANTIES OF MERCHANTABILITY AND FITNESS FOR ANY PARTICULAR PURPOSE, EXCEEDING THE SPECIFIC PROVISIONS OF THIS WARRANTY ARE HEREBY DISCLAIMED AND EXCLUDED FROM THIS WARRANTY. UPON EXPIRATION OF THE APPLICABLE EXPRESSED WARRANTY PERIOD (1 YEAR), LINE 6 SHALL HAVE NO FURTHER WARRANTY OBLIGATION OF ANY KIND, EXPRESS OR IMPLIED. LINE 6 SHALL IN NO EVENT BE LIABLE FOR ANY SPECIAL, INCIDENTAL OR CONSEQUENTIAL DAMAGES SUFFERED BY THE PURCHASER, OR ANY THIRD PARTY, INCLUDING, WITHOUT LIMITATION, DAMAGES FOR LOSS OF PROFITS OR BUSINESS, OR DAMAGES RESULTING FROM USE OR PERFORMANCE OF THE INSTRUMENT, WHETHER IN CONTRACT OR IN TORT. LINE 6 SHALL NOT BE LIABLE FOR ANY EXPENSES, CLAIMS, OR SUITS ARISING OUT OF OR RELATING TO ANY OF THE FOREGOING. Some states do not allow the exclusion or limitation of implied warranties so some of the above limitation and exclusions may not apply to you. This warranty only applies to products sold and used in the United States of America and Canada. Line 6 shall not be liable for damages or loss resulting from the negligent or intentional acts of the shipper or his contract affiliates. You should contact the shipper for proper claims procedures in the event of damage or loss resulting from shipment.