

lexicon

Reflex
DYNAMIC
MIDI® REVERBERATOR

User Guide

Unpacking and Inspection

After unpacking the unit, save all packing materials in case you ever need to re-ship. Thoroughly inspect the unit and packing materials for signs of damage. Report any shipment damage to the carrier at once; report equipment malfunction to your dealer.

Notice

This equipment generates and uses radio frequency energy and if not installed and used properly, that is, in strict accordance with the manufacturer's instructions, may cause interference to radio and television reception. It has been type tested and found to comply with the limits for a Class B computing device in accordance with the specifications in Subpart J of Part 15 of FCC Rules, which are designated to provide reasonable protection against such interference in a residential installation. However, there is no guarantee that interference will not occur in a particular installation. If this equipment does cause interference to radio or television reception, which can be determined by turning the equipment OFF and ON, the user is encouraged to try to correct the interference by one or more of the following measures: reorient the receiving antenna; relocate the computer with respect to the receiver; move the computer away from the receiver; plug the computer into a different outlet so that the computer and receiver are on different branch circuits. If necessary, the user should consult the dealer or an experienced radio/television technician for additional suggestions. The user may find the following booklet prepared by the Federal Communications Commission helpful: "How to identify and Resolve Radio/TV Interference Problems." This booklet is available from the U.S. Government Printing Office, Washington, DC 20402, Stock No. 004-000-00345-4.

Le présent appareil numérique n'émet pas de bruits radioélectriques dépassant les limites applicables aux appareils numériques de la class B prescrites dans le Règlement sur le brouillage radioélectrique édicté par le ministère des Communications du Canada.

Copyright ©1994, 1995 Lexicon Inc.
All Rights Reserved.

Lexicon Part 070-10229 Rev 1

Lexicon Inc.
3 Oak Park
Bedford, MA 01730 USA
Telephone 781-280-0300
Fax 781-280-0490

Printed in the U.S.A.

Table of Contents

Getting Started	1
Introduction	1
Front Panel Overview	2
Setting Audio Levels	
Rear Panel Connections	4
Footswitch Connections • Headphones	
MIDI Connections • Switching from MIDI OUT to MIDI THRU	
Front Panel Operation	7
Overview	7
Presets and Registers	8
More Effects	
About the Parameters	11
Front Panel Parameter Controls	
Loading an Effect	13
Editing an Effect	14
Storing an Effect	15
Performing an Edit Compare	16
Using Footswitches	17
Bypass • Stepping through the Registers • Clearing Registers • Skipping Registers and Creating Chains	

Advanced Programming Mode	19
Overview	19
APM Utility Functions	20
Algorithms and Parameters	21
Hall	22
Plate	23
Flanger	24
Multi Taps	25
Resonator	26
Inverse	27
Gate	28
Chorus	29
More about the Algorithms	30
MIDI Operation	31
MIDI Configurations	32
Learning a MIDI Channel	34
Dynamic MIDI® Patching	35
Creating a Dynamic MIDI Patch • Multiple Patches to a Parameter • Deleting a Patch • Display of MIDI Parameter Changes • Special Notes on MIDI Programming • MIDI Bypass	
MIDI Implementation Chart	44
Specifications	46

Getting Started

Introduction

Thank you for your purchase of Reflex, Lexicon's Dynamic MIDI® Reverberator.

Reflex gives you 8 world class reverberation and effects algorithms to enhance any audio performance. Sixteen preset effects provide a wide range of superb sounds right out of the box, and a bank of 128 registers is available for storing your own customized effects. — We've loaded the registers with an additional 96 sounds to really get you going!

Reflex front panel operation is straightforward, with three adjustable parameters which allow you to make subtle or dramatic changes to each preset.

An Advanced Programming Mode allows you to access additional parameters within each algorithm, providing fine control over every aspect of the effects. This mode also gives you front panel control over Utility functions such as MIDI channel assignment and register dumps.

Footswitch control allows you to bypass the effects, to step through the registers, or to set up register chains to suit your performance needs

MIDI Program Change can be used to access any register, or to bypass Reflex processing. Beyond simple Program Change, Reflex lets you change parameters in real-time, using MIDI Note Number or continuous controllers. You can create as many as 4 patches per effect, controlling Predelay with Mod Wheel, Reverb Time with MIDI Notes, etc. Dynamic MIDI™ allows exceptionally expressive performance and sequencer control.

Two of the algorithms (Chorus and Multi Taps) allow you to control echo rhythms with MIDI Clock, so you can synchronize delays to drum machines and sequencers, vary the echo repeat rate, and still maintain tempo.

Even deeper control is available through full MIDI SysEx implementation which allows bidirectional communication with a dedicated controller, such as Lexicon's MRC, or a personal computer with appropriate software. In fact, Reflex is already compatible with existing editors which will recognize it as a member of Lexicon's LXP series.

To make sure you get the most out of Reflex, be sure to read the manual.

Front Panel Overview

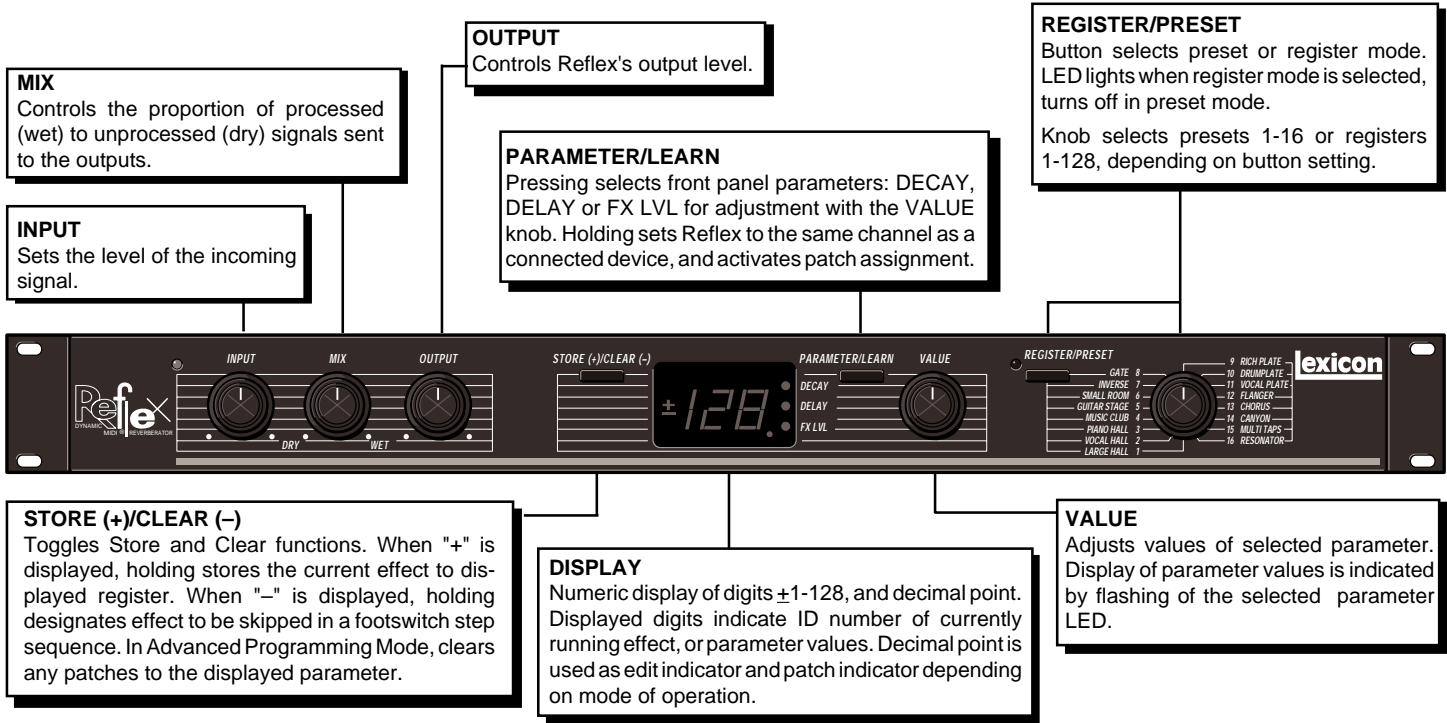

Setting Audio Levels

1. Turn Reflex INPUT and OUTPUT controls all the way down (fully counter-clockwise).
2. Connect Reflex inputs to an audio source, and Reflex outputs to an amplifier or mixer.
3. Apply an input signal at a level that you typically use.
4. While sending audio to Reflex, gradually turn up the INPUT control until the Input Status LED* lights green. Continue to advance INPUT until the LED lights red on only the loudest peaks. If the LED is continuously red, turn the INPUT control down.
5. If Reflex is using a console's sends and returns, set the MIX control fully clockwise (100% wet). If you are using an instrument amplifier, start with MIX set halfway up.
6. Gradually increase the setting of the OUTPUT control until the audio level from the amplifier or mixer is approximately the same as when Reflex is bypassed.

* The Input Status LED is off when the incoming signal is low; it lights to indicate acceptable levels (6dB to 30dB below overload). The LED lights red when the signal approaches overload. Acceptable signals will trigger red flashes only on peaks.

Rear Panel Connections

MIDI

MIDI In and Out connectors are provided. Switching an internal jumper allows selection of MIDI THRU instead of MIDI OUT.

POWER

Use Lexicon MSA power pack, or 9VAC 1 amp equivalent.

OUTPUT

Single-ended (unbalanced) stereo outputs provide -2dBu nominal output level. Use the right output connector for mono output. If no connection is made at the right output, the left output can be used to drive high-efficiency headphones at modest volume.

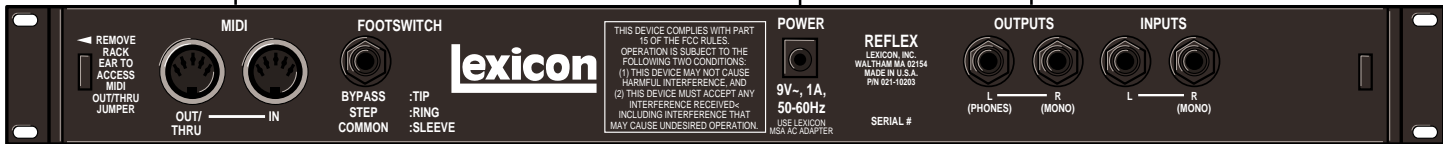

FOOTSWITCH

Tip/Ring/Sleeve phone input, for momentary or latching contact footswitches, allows footswitch control of Register Step and Bypass functions.

INPUT

Single-ended (unbalanced) inputs accept levels as low as -30dBu. Input impedance is 50 k Ω in stereo, 25 k Ω in mono. Use the right for mono input.

Footswitch Connections

A footswitch connected via the rear-panel footswitch jack allows you to perform register STEP and BYPASS functions. Two momentary foot-switches can be wired to a tip-ring-sleeve connector. A stereo Y-connector allows two identical single switches to be used.

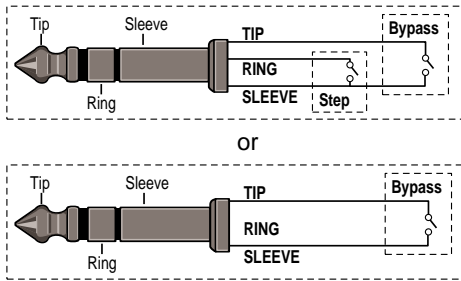

When shipped, Reflex is configured to use momentary contact switches. You can change this configuration to allow the use of latching switches by performing the following procedure:

1. Simultaneously press the PARAMETER/LEARN and the REGISTER/PRESET buttons. This will put the unit into Advanced Programming Mode (lighting all 3 front panel parameter LEDs).
2. Turn the REGISTER/PRESET knob to 15. The letter "F" should appear on the display.
3. Turn the VALUE knob to select 0 (latching) or 1 (momentary).
4. Press the REGISTER/PRESET button to restore normal front panel operation.

Headphones

A stereo signal which is adequate to drive high-efficiency headphones is available at the left output, *provided no connections are made through the right output*. This feature is provided as a convenience for practice purposes, and is intended to provide only modest volume.

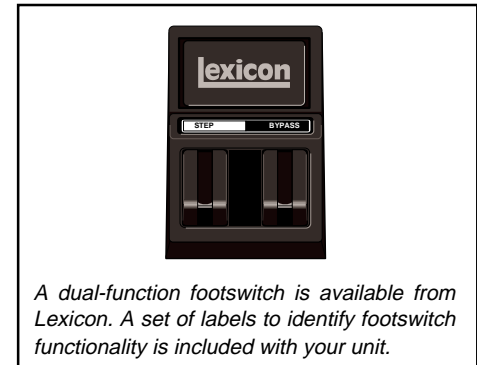

Switching from MIDI OUT to THRU

When shipped, Reflex is configured for MIDI OUT operation. You can easily reconfigure the unit for MIDI THRU operation with the following procedure.

1. Disconnect power.
2. Remove the two top and bottom cover screws which are closest to the rear panel MIDI connectors.
3. Lay the unit upside down and remove the rack ear.
4. Lift the jumper off of its pins and reposition it according to the functionality you want.
5. Replace the rack ear and the cover screws.
6. Reconnect power.

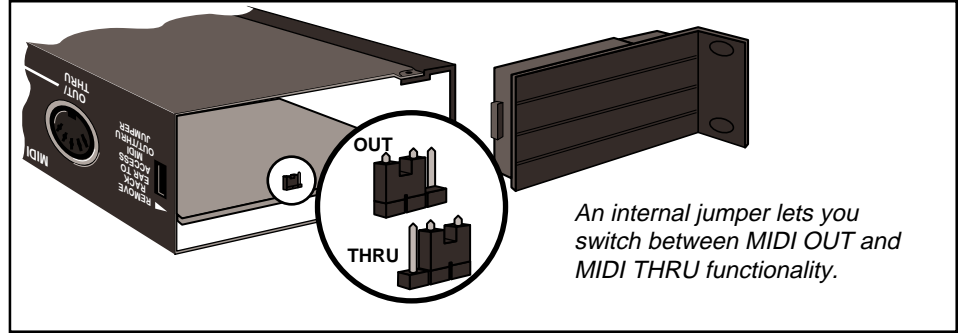

Front Panel Operation

Overview

Reflex front panel operation is simple and straightforward. Effect selection, editing, STORE, and CLEAR functions are easily accomplished with dedicated knobs and buttons.

This section describes all of these basic functions, as well as using footswitches to step through registers and register chains.

Reflex is loaded with 16 permanent presets, designed to give you the following effects:

1 LARGE HALL Lexicons' famous hall reverb for instruments and voices requiring a "Concert Hall" environment. Experiment with different settings of DELAY (Predelay) to make the sound bounce off the back wall.

2 VOCAL HALL A slightly smaller hall with added reflections to create a doubling effect with vocals.

3 PIANO HALL Small and dense initial envelope which works well with the percussive nature of any piano. Changing DELAY will separate the source from the reverb, adding liveness to any recording.

4 MUSIC CLUB Combines a bright, tight space with strong early reflections. Great on fast tempo music, background vocals or bright acoustic sources.

5 GUITAR STAGE Small, bright music space combined with a slap reflection. Great for electric or acoustic guitars. Increase DECAY for solos. Also exceptional for drums or percussion when you require a smaller stage ambience.

6 SMALL ROOM Very dense, with a smooth short decay time. Great for ADR or other types of dialog sessions. You may want to try pre-fader sends to set the source far back in the room.

7 INVERSE The reverberation envelope is sharply tilted to provide a long rising attack followed by a sharp cutoff. DECAY alters the length of the effect. DELAY varies predelay.

8 GATE Provides a very dense field with a sudden cutoff, rather than the smoothly decaying envelope normally associated with reverberation. DECAY varies the length of the gated effect. DELAY varies predelay. Traditionally used with drums and percussive instruments, but also effective on many other types of material.

9 RICH PLATE Closely mimics the sonic traits of a metal plate. With a moderately large size, this preset gives a clear example of the sonic characteristics of the plate algorithm.

10 DRUM PLATE *The plate sound for drums and other percussive instruments, but also very useful for a variety of broadband audio sources. Reverb time is very short and dense.*

11 VOCAL PLATE Designed specifically for vocals, this plate is slightly dark and very smooth. A slight predelay has been added to separate the source from the reverb envelope.

12 FLANGER A straightforward stereo flange. DECAY controls the amount of feedback or resonance. DELAY varies the depth and speed of the flange.

13 CHORUS The Chorus algorithm is a 6-voice stereo chorus with an interesting twist which allows for both Chorusing and Delay effects. DECAY controls recirculation. DELAY sets the delay line length. The CHORUS preset has very short DELAY and a moderate amount of diffusion.

14 CANYON A single, recirculating echo effect. Slap echoes with DELAY set to mid-range area, and longer (1.5 seconds max) echoes with DELAY set in the upper range. DECAY controls the number of recirculating repeats. Creates stunning realism with the original audio signal.

15 MULTI TAPS A 4-Tap bouncing delay program with the bounce going back and forth between left and right outputs. The texture changes significantly as you vary DELAY. Great on short staccato sounds. Creates interesting blends with longer sustained sounds. Most effective when outputs are sent to a stereo return or stereo cabinet, and panned full left/ full right.

16 RESONATOR Designed to mimic the effect of resonance that occurs when holding down the damper pedal on a piano. Adds a fascinating color to any sound source.

Each of the presets contains a unique version of the 3 parameters; DECAY, DELAY and FX LVL. The parameters of each preset are available for front panel adjustment along their entire range, allowing you to create hundreds of variations of each effect. (As many as 7 additional parameters are accessible in Advanced Programming Mode or via MIDI.

Presets cannot be erased or overwritten by parameter changes; the original version will always be restored. If you make changes to a preset and want to save the changes as a custom effect, you must store your new version in one of Reflex's 128 registers.

More Effects

Reflex is shipped from the factory with its 128 registers filled with the effects listed here. Remember that registers are volatile. When you save an effect to a register, the current contents will be overwritten. Once you've overwritten a register, it cannot be restored, even by reinitializing the unit.

We've put duplicates of the presets into the first and last 16 registers, so you can overwrite these with your own effects immediately and not worry about missing out on anything. The general organization of the effects is as follows:

Register #	
1-16	Duplicate of Presets
17-50	Reverbs
51-64	Gates
65-68	Inverse effects
69-76	Chorus, Flange, and Resonator effects
77-104	Delay effects
105-112	Effects with AutoTempo
113-128	Duplicate of Presets

1	LarjHall
2	VoclHall
3	PianoHal
4	MuscClub
5	GitStage
6	SmallRoom
7	Inverse
8	Gate
9	RichPlat
10	DrumPlat
11	VoclPlat
12	Flanger
13	Chorus
14	Canyon
15	MultiTap
16	Resonate
17	SmallHall
18	BritHall
19	DarkHall
20	BigHall
21	MidVerb
22	LongVerb
23	HugeVerb
24	Tight
25	SmallRoom
26	SmallRm1
27	SmallRm2
28	MedRm1
29	MedRm2
30	LrgeRm1
31	LrgeRm2
32	SmallPlat

33	Plate
34	Plate15
35	GuitPlat
36	DrumPlat
37	GoldPlat
38	GudPlat
39	VocPlat
40	RustPlat
41	DrkPlat
42	BritPlat
43	Church1
44	LongPlat
45	DifPlate
46	BigPlate
47	BotmPlat
48	*SoloPlat
49	EchoPlat
50	DeepEnd
51	SmallGate
52	ShrtGate
53	MedGate
54	MediGate
55	LarjGate
56	Gate1
57	GateSlap
58	BritGate
59	SlapGate
60	SprngChs
61	MegaGate
62	Snar+Tom
63	MetlGate
64	*ElvsGate

65	Inverse1
66	Deverse
67	RevRpeat
68	SkiSlope
69	TalkFing
70	FullChor
71	SlapFing
72	SislEKos
73	Rez 2
74	Edge 1
75	OpenHarp
76	Rich Rez
77	Delay 1
78	Slap It
79	LongChrs
80	LongDlay
81	Delay280
82	Delay450
83	AntrChor
84	Chor Too
85	ChorDubl
86	SlapChor
87	ChorDlay
88	ThruRngr
89	ThikChor
90	SwngDlay
91	LongEkos
92	6VoxChor
93	VoclChor
94	*MAT Chor
95	ChorSlap
96	KickSlap

97	*LongChor
98	*SlapChrs
99	*SheenChr
100	*BootBass
101	Delay 2
102	Image
103	SideSlap
104	MultiEko
105	1/4 Multi
106	1/8 Multi
107	1/16 Mult
108	1/8 TMult
109	1/4 Chor
110	1/8 Chor
111	1/16 Chor
112	1/8TChor
113	Preset 1
114	Preset 2
115	Preset 3
116	Preset 4
117	Preset 5
118	Preset 6
119	Preset 7
120	Preset 8
121	Preset 9
122	Preset 10
123	Preset 11
124	Preset 12
125	Preset 13
126	Preset 14
127	Preset 15
128	Preset 16

* Effects preceded by an asterisk (*) have one parameter patched to MIDI controller 7, Volume.

About the Parameters

Each of the 16 presets in Reflex consists of a unique combination of parameters. These fixed parameters determine the type of preset — hall, room, plate, etc. that you will hear when you turn the REGISTER/PRESET knob.

For each preset, several parameters have been made available for front panel control through the DECAY, DELAY and FX LVL controls.

In Halls and Rooms (1-6), and in the Plate presets (9-11), DECAY sets the nominal reverberation decay time for a predetermined room size which is unique to each preset.

In the Inverse and Gate presets (7-8), DECAY changes both the size and the character of the program, while DELAY varies the predelay before the gated effect. (Note that changing the setting of DECAY in either of these presets will briefly mute the effect.)

In the Flanger preset (12), DECAY controls flange resonance. In Chorus (13), Canyon (14), Multi Taps (15) and Resonator (16), DECAY controls recirculation.

DELAY generally sets the amount of predelay (the length of time between the input of signal and the onset of reverberation). The range of this control varies with the type of preset.

In Chorus, Canyon and Multi Taps, DELAY controls the echo delay. In Flanger, it controls the depth of the flange effect. In Resonator, it controls the delay time for the first of four equally spaced delay taps.

In each preset, FX LVL sets the level of the effects being added to the signal.

Note that the setting of the MIX control is very important with several of the presets. In the Inverse and Gate presets, MIX allows you to set up anything from a subtle thickening or enhancement, to a solid wall of reverb. In the Chorus and Flanger presets, MIX should be set higher than 50% wet to get rich chorus and flange effects.

A diagram showing the parameters controlled by DECAY, DELAY and FX LVL in each preset is shown on the following page.

Front Panel Parameter Controls

PRESETS	PARAMETERS	
	DECAY	DELAY
1 Large Hall	Mid Reverb Decay	Predelay
2 Vocal Hall	Mid Reverb Decay	Predelay
3 Piano Hall	Mid Reverb Decay	Predelay
4 Music Club	Mid Reverb Decay	Predelay
5 Guitar Stage	Mid Reverb Decay	Predelay
6 Small Room	Mid Reverb Decay	Predelay
7 Inverse	Size	Predelay
8 Gate	Gate Time	Predelay
9 Rich Plate	Mid Reverb Decay	Predelay
10 Drum Plate	Mid Reverb Decay	Predelay
11 Vocal Plate	Mid Reverb Decay	Predelay
12 Flanger	Negative Feedback	Flange Depth
13 Chorus	Feedback	Delay
14 Canyon	Feedback	Delay
15 Multi Taps	Feedback	Group Delay
16 Resonator	Resonance Feedback	Tuning

In all effects, FX LVL controls the amount of processed sound added to the effect. In the presets, FX LVL is set to 100%.

Loading an Effect

The REGISTER/PRESET button determines whether the knob will load registers or presets. The LED lights to indicate register is selected.

Turn the REGISTER/PRESET knob to select and load the preset (1-16) or register number (1-128) you want. The display will update to show the number of the currently loaded effect.

When you change between register and preset modes, you will always recall the last preset or register loaded, in whatever state you left it.

Reflex has 16 presets and 128 registers for storing your customized effects. Pressing the REGISTER/PRESET button ...

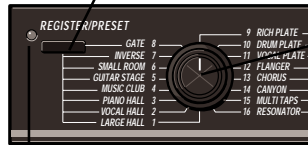

LED indicates register selection.

...determines whether presets (LARGE HALL ... RESONATOR), or registers (1 ... 128) will be selected by the knob.

Editing an Effect

Adjusting Parameter Values

For each Reflex effect, several parameters have been made available for front panel control through the DECAY, DELAY, and FX LVL controls. Control over these parameters is simple — press PARAMETER/LEARN to select a parameter, then adjust it with the VALUE knob. All parameter settings made from the front panel can be stored with the effect.

The VALUE knob is always active, and will adjust whichever parameter is indicated by the display LEDs. The first turn of VALUE will display the current parameter setting. Subsequent adjustments will increment or decrement parameter values along their entire range.

The decimal point on the display will light when a parameter is adjusted to indicate that the effect has been modified since the last store operation. If no further adjustments are made with VALUE, the display will revert to showing the number of the currently running effect. The edit indicator will remain on until the effect is stored, or until changes are lost by selecting another effect with the REGISTER/PRESET knob.

Press PARAMETER/LEARN to toggle selection of one of the three front panel parameters. A lighted LED indicates your selection.



Use the VALUE knob to adjust the selected parameter.

Parameter values will be displayed when VALUE is turned. The parameter LED will flash to indicate that a parameter value (as opposed to a preset or register number) is being displayed.

The decimal point indicates changes have been made since the last store operation.

Storing an Effect

Reflex presets cannot be erased or overwritten by parameter changes; the original version will always be restored when loaded. If you make changes to a preset and want to save the changes as a custom effect, you must store your new versions into registers.

To store the currently running effect:

1. Briefly press STORE/CLEAR until a plus sign (+) is displayed.
2. Press and hold STORE/CLEAR.

If you were in preset mode, the register LED will go on, indicating that Reflex has automatically switched to register mode — selecting whatever register was last displayed.

If you want to store to a different register than the one displayed, turn the REGISTER/PRESET knob to the register number you want *before* releasing STORE/CLEAR.

3. Releasing STORE/CLEAR will store the currently running effect into the register indicated on the display, overwriting the effect previously stored there. The display will flash briefly to indicate the store operation was successful.

Performing an Edit Compare

If you do not perform a store operation, changes made to effects will be lost as soon as another effect *within* the same mode (preset or register) is selected. Changing *between* preset and register modes, however, will not erase your changes. This provides an edit compare capability which allows you to toggle back and forth between an effect you are working on and the original version. For example:

1. Select a preset and store a copy of it in any register.
2. Make any changes you want to either the preset or the register.
3. Compare your new effect to the original version simply by pressing the REGISTER/PRESET button.
4. Use the REGISTER/PRESET button to toggle back and forth as many times as you like between the original effect and the new version, making changes as desired.

When you are satisfied with the effect, perform a store operation to any register you want using the procedure described on the preceding page.

A dual footswitch can be connected to Reflex's rear-panel footswitch jack. Refer to the diagram shown in *Rear panel Connections*.

Bypass

A footswitch can be used to bypass effects. When active, "bP" (byPass) appears on the display. The + and – symbols, and the parameter LED are turned off. Processed audio is bypassed in this state, but you can still access all of the front panel controls. (If another control is adjusted, the display will respond to the control, then revert to "bP" after approximately 3 seconds.)

Stepping through the Registers

You can use a footswitch to step through the registers. The footswitch will increment continuously up to register 128, then wrap back to register 1 (or the first uncleared register). If you are in preset mode, the first click of the switch will automatically switch you into register mode, loading whatever register was last loaded; subsequent clicks will increment from that point on.

Clearing Registers

Reflex has a clear function which allows the use of a footswitch to link effects in a variety of useful ways. Clearing a register does not erase the contents of a register. It clears a space in the register sequence so that the register is skipped in any effect sequence you create.

To clear a register...

1. Briefly press STORE/CLEAR until a minus sign (–) is displayed.
2. Press and hold STORE/CLEAR.

If you were in preset mode, the register LED will go on, indicating that Reflex has automatically switched to register mode — selecting whatever register was last displayed. The displayed register will be cleared, and the register ID number will flash. (The ID number of any cleared register flashes when selected with the REGISTER/PRESET knob.)

To restore a cleared register, briefly press STORE/CLEAR until a plus sign (+) is displayed, then press and hold STORE/CLEAR.

Registers 4, 9, 10 and 14 have been cleared...



With the REGISTER/PRESET knob set to Register 1, the footswitch will step through the remaining registers, then loop back to Register 1.

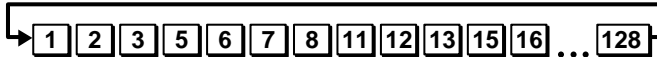

Turning the REGISTER/PRESET knob to any position other than 1, will set up register chains which use cleared registers as loop points.

The combination of cleared registers shown above would create these four chains ...



If the REGISTER/PRESET knob is set to a register within a chain, the footswitch will cycle through the chain until the next cleared register, then loop back to the first register in the chain.

(To use a chain containing Register 1, you must set the REGISTER/PRESET knob to another register in the chain.)

With the REGISTER/PRESET knob set to Register 7, the footswitch will step through this sequence ...

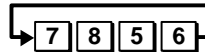

If the REGISTER/PRESET knob is set to a cleared register, the footswitch will skip to the first register in the next chain, then step through that chain.

Skipping Registers and Creating Chains

Reflex's clear function allows you to use a footswitch to *skip* effects you do not want in a sequence, or to create register *chains*.

Skipping allows you to remove specific registers from your footswitch step sequence. If, for example, you want to leave one or more effects out of a step sequence, simply clear the unwanted registers and turn the REGISTER/PRESET knob to 1. Now, the footswitch will increment through the registers, passing over the cleared registers without requiring you to step through them.

Turning the REGISTER/PRESET knob to any position other than 1, will set up register chains which use cleared registers as loop points.

Skip and chain functions are illustrated to the left.

Advanced Programming Mode

Overview

The Advanced Programming Mode is an exciting feature which lets you enhance the capabilities of Reflex at the push of a button. This mode provides a set of Utility functions that let you adjust a variety of system settings, and perform MIDI dumps right from the front panel.

In addition, Advanced Programming Mode gives you access to additional parameters for the currently running Reflex effect, allowing much more subtle and complex editing.

In this mode, the first 10 positions of the REGISTER/PRESET knob are used to select the available parameters for the currently running effect. Positions 11-16 provide access to the Utility functions.

To activate the Advanced Programming Mode, simultaneously press the PARAMETER/LEARN and the REGISTER/PRESET buttons. The three front panel parameter LEDs will light to indicate that the mode is active.

Press the REGISTER/PRESET button at any time to return to normal Reflex front panel operation.

Instantly available when you want it, out of your way when you don't, Advanced Programming Mode is a hidden storehouse of additional controls, each of which is described in the following pages.

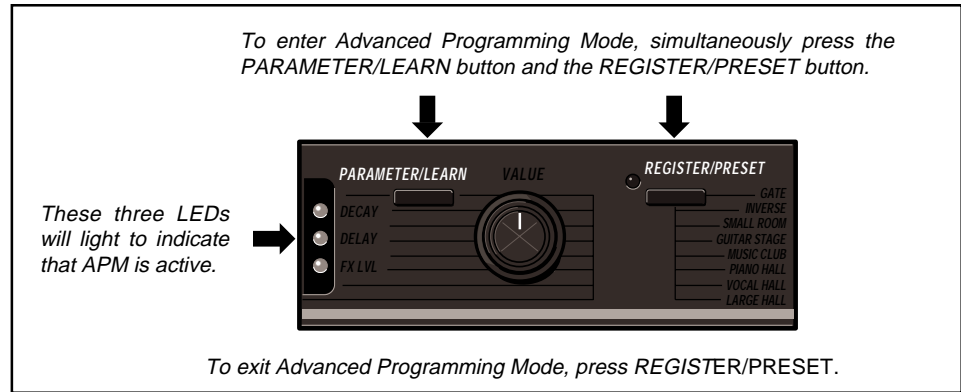

APM Utility Functions

When you are in Advanced Programming Mode, positions 11-16 of the REGISTER/PRESET knob select a variety of Utility functions which can be performed simply by selecting them and adjusting another single front panel control. Each function has an easily recognizable display code to indicate which function is active.

The default status of those functions which are memorized is as follows:

Function	Default
Pc	+ (enabled)
Ch	1
F	1(momentary)

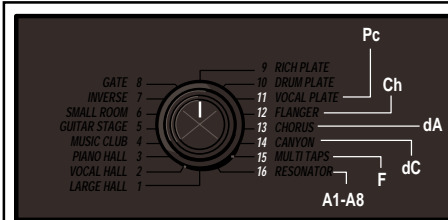

In APM, positions 11-16 of the REGISTER/PRESET knob select the Utility functions. Each function has an easily recognizable display code to indicate which function is active.

REGISTER/PRESET Knob Position	APM Display Code	
11	Pc*	Program Change Press STORE to enable (+) or disable (-) Reflex reception of MIDI Program Change messages.
12	Ch*	Channel Turn VALUE to select channel (0 = OMNI, or 1-16) for incoming MIDI messages.
13	dA	Dump All Press STORE to dump all registers.
14	dC	Dump Current Effect Press STORE to dump current effect.
15	F*	Footswitch Turn VALUE to select footswitch type: 0 = latching; 1 = momentary.
16	A1-A8	Algorithm ID Display algorithm ID # of currently running effect.

*These functions are memorized, and remain in effect until deliberately altered.

Algorithms and Parameters

About the Algorithms

Eight different reverberation and effects algorithms are used to create the sounds shipped with Reflex.

Although the front panel DECAY, DELAY, and FX LVL parameters allow you to create thousands of variations on these sounds, Advanced Programming Mode lets you take front panel effects editing to a whole new level by giving you access to all of the parameters in each algorithm.

Each Reflex algorithm has as many as 10 parameters which can be accessed in this mode*. This lets you go beyond creating variations of an effect to completely changing its character.

*Advanced Programming Mode makes it possible to perform full editing from the front panel. These parameters can also be accessed by Lexicon's MRC, or by any editing software which recognizes the Lexicon LXP-1.

In Advanced Programming Mode, each of the eight Reflex algorithms is assigned an ID# (A1-A8).

Algorithm ID #	Algorithm Name
A1	Hall
A2	Plate
A3	Flanger
A4	Multi Taps
A5	Resonator
A6	Inverse
A7	Gate
A8	Chorus

To view the algorithm ID # of any running effect, simply enter APM (simultaneously press the REGISTER/PRESET and PARAMETER/LEARN buttons) and turn the REGISTER/PRESET knob to 16.

In APM, REGISTER/PRESET knob positions 1-10 will select the available parameters of the currently running effect. With any parameter selected, the VALUE knob will adjust it along its entire range.

A diagram of each algorithm is shown on the following pages, along with a chart of the available parameters and their ranges.

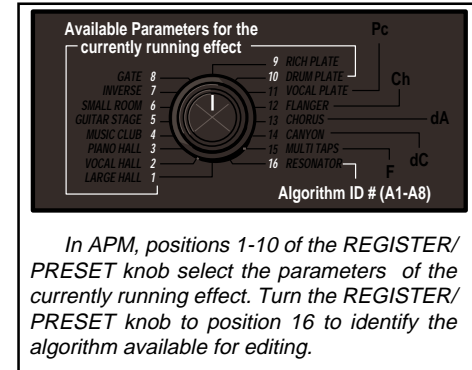

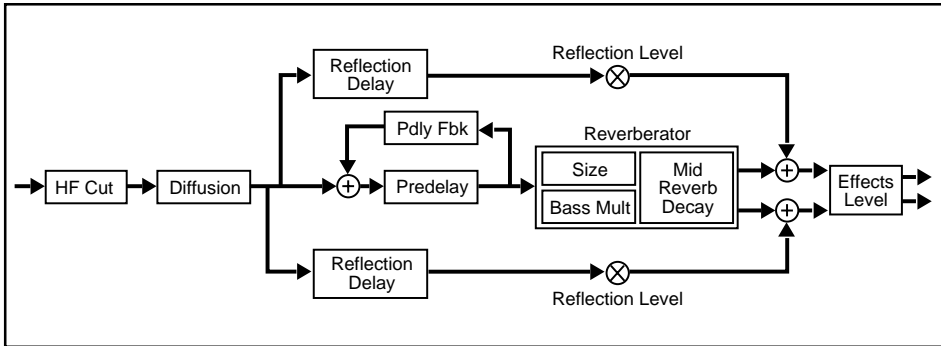

This is Lexicon's famous hall reverb, used to create spaces as large as a concert hall, or as intimate as a small club. In Reflex it is used to create the various halls and rooms found in Presets 1-6.

The clean reverberation of the Hall algorithm is designed to add spaciousness, while leaving the source material unchanged. In addition to general instrumental and vocal applications, the Hall algorithm is a good choice for giving separately recorded tracks the sense of belonging to the same performance.

Generally, you should set the Size control first to establish the dimensions of the space you are trying to create — or start with a preset of a similar room size. (Note that adjusting Size temporarily mutes the outputs.) The remaining parameters will determine the character of the space.

APM Setting	Parameter Name	Display Range	Actual Range
1	Mid Reverb Decay	1 to 16	.25-6.5seconds, typical
2	Predelay	1 to 128	0-246ms
3	Effects Level	1 to 128	0-100%
4	Bass Multiply	-8 to +8	.3-2.5x, nominal
5	High Frequency Cutoff	1 to 16	321Hz-13.8kHz
6	Size	1 to 64	8-71 meters
7	Predelay Feedback	-128 to +128	-99 to +99%
8	Diffusion	1 to 128	0-100 (arbitrary units)
9	Reflection Level	1 to 128	0-100%
10	Reflection Delay	1 to 128	40-168ms

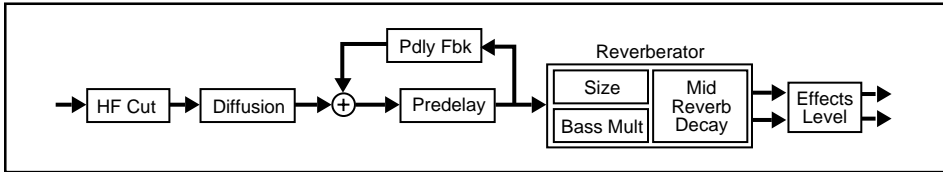

This algorithm gives you all of the sonic traits of a metal plate reverberator. Presets 9-11 provide classic plate effects for drums and other percussive instruments, as well as for a variety of broadband audio sources.

Plate effects are designed to be heard as part of the music, enhancing and thickening the source material.

In this algorithm the Size parameter sets the rate of the build-up of diffusion after the initial period (set by Diffusion), and acts as a master control for decay. Because of this link, you should set Size before adjusting other parameters. (Note that adjusting Size temporarily mutes the outputs.)

APM Setting	Parameter Name	Display Range	Actual Range
1	Mid Reverb Decay	1 to 16	.25-6.5seconds, typical
2	Predelay	1 to 128	0-246ms
3	Effects Level	1 to 128	0-100%
4	Bass Multiply	-8 to +8	.3-2.5x (nominal)
5	High Frequency Cutoff	1 to 16	321HZ-13.8KHZ
6	Size	1 to 64	8-71 meters
7	Predelay Feedback	-128 to +128	-99 to +99%
8	Diffusion	1-128	0-100 (arbitrary units)
9	--	--	--
10	--	--	--

Flanger A3

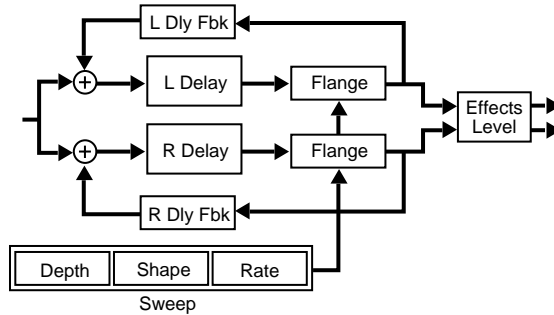

This algorithm produces stereo flanging with two flanges that can be used to create different effects from left and right outputs. This algorithm was used to create Preset 12.

Individual delays of as much as 1 second, are provided, with separate feedback controls for each delay, as well as rate and shape controls for the flange. The flanging effect is altered by recirculating the delays with the feedback controls. Larger amounts of feedback cause exaggerated "deep" flanges.

The Negative Feedback parameter simultaneously controls both Left Delay Feedback and Right Delay Feedback, overriding previously set relations between them. This control applies slightly more feedback to the left channel than to the right.

APM Setting	Parameter Name	Display Range	Actual Range
1	Negative Feedback	1 to 128	0-99%
2	Flange Depth	1 to 128	.25-8.2ms
3	Effects Level	1 to 128	0-100%
4	Right Delay Feedback	-128 to +128	-99 to +99%
5	Right Delay	1 to 128	0-1000ms
6	Shape	1 to 8	1-8 (arbitrary units)
7	Left Delay Feedback	-128 to +128	-99 to +99%
8	Left Delay	1 to 128	0-1000ms
9	Flange Rate	1 to 16	1-16 (arbitrary units)
10	--	--	--

Multi Taps **A4**

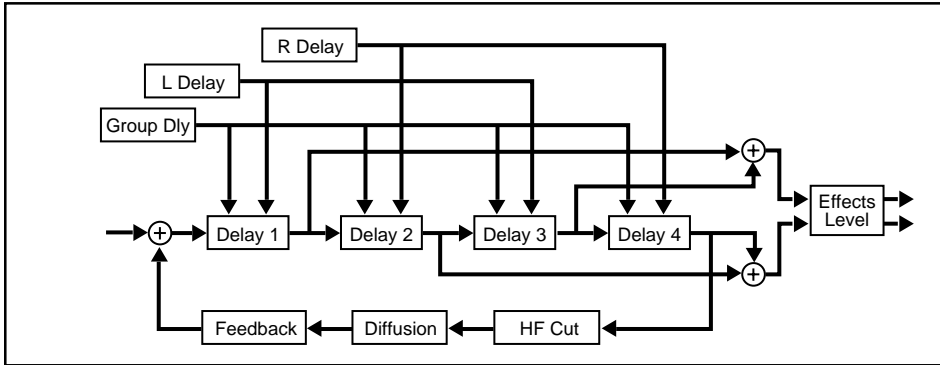

This algorithm is a 4-Tap bouncing delay, with the bounce going back and forth between left and right outputs. Delay times can be tempo-driven by MIDI Clock.

The Group Delay parameter allows all four delays to be controlled as a group, maintaining equal spacing for a symmetrically balanced effect. (This parameter is selected as the front panel DELAY parameter.)

The Left and Right Delay parameters allow you to individually vary the left and right delay pairs. Simple equalization is provided in the feedback loop. The feedback parameter is selected for front panel control (via DECAY).

APM Setting	Parameter Name	Display Range	Actual Range
1	Feedback	-128 to 128	-99 to +99%
2	Group Delay	1 to 128	0-305ms
3	Effects Level	1 to 128	0-100%
4	--	--	--
5	Left Delay	1 to 128	0-1000ms
6	Right Delay	1 to 128	0-1000ms
7	--	--	--
8	High Frequency Cutoff	1 to 16	321Hz-13.8kHz
9	Diffusion	1 to 128	0-100 (arbitrary units)
10	Echo Rhythm	1 to 14*	1/64th note-whole note

*See Page 30 for a map of knob positions vs. note values.

Resonator A5

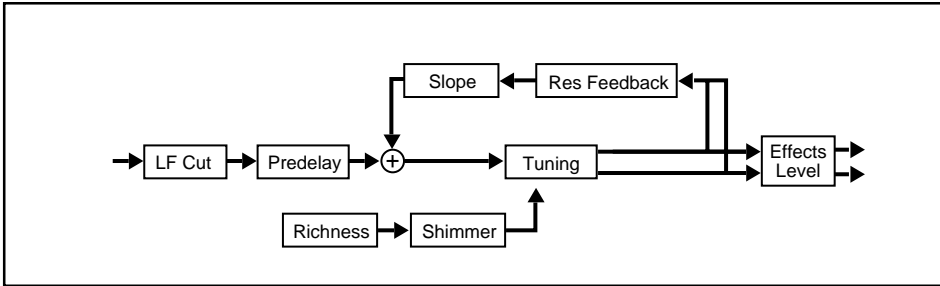

APM Setting	Parameter Name	Display Range	Actual Range
1	Resonance Feedback	-32 to +32	-99...-87% to +87...+99%
2	Tuning	-64 to +64	-8 to +7 semitones
3	Effects Level	1 to 128	0-100%
4	Predelay	1 to 128	0-524ms
5	Low Frequency Cutoff	1 to 128	19.5Hz-13.5kHz
6	Shimmer	1 to 16	0-1200ms
7	--	--	--
8	Richness	1 to 16	0-120 cents
9	Slope	1 to 32	-15 to +15 (arbitrary units)
10	--	--	--

This algorithm simulates the acoustic effects of multi-stringed instruments. A series of resonators tuned to a chromatic scale are provided with controls for tuning and damping.

Suggested applications for this algorithm include enhancing synthetic instruments and amplified strings. Caution is advised in using this algorithm with voice (especially spoken) and percussion.

The Tuning parameter tunes all 12 resonators over a range of more than an octave to match the tuning of your instrument. Predelay spaces out the onset of the resonators to produce a strumming effect. Low Frequency Cutoff filters the input audio to reduce boominess for low tunings. Resonance Feedback affects the lowest pitch resonator. The other resonators are set based on this value and the value of Slope. Shimmer sets the *period* of resonator detuning. This parameter is factory preset to change one resonator every 0.5 seconds. Richness sets the *amount* of periodic detuning. Slope controls timbre.

This algorithm was used to create Preset 16.

Inverse A6

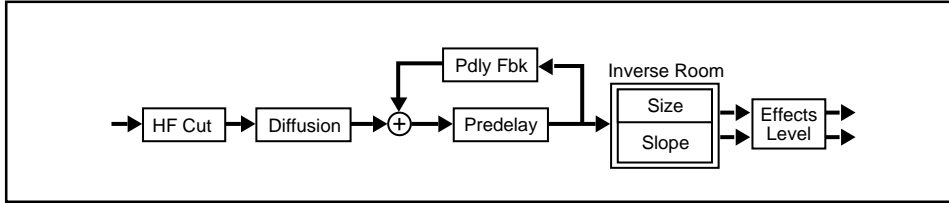

Inverse Reverb is similar to gated reverb, except that the reverberation envelope is sharply tilted to provide a long rising attack followed by a sharp cutoff.

This algorithm is an excellent choice for percussion and the controls allow you to set up anything from a subtle thickening or enhancement to a solid wall of reverb. Size adjusts the perceived length of the inverse effect. As this parameter changes both time and density, it subtly affects the timbre.

This algorithm was used to create Preset 7.

APM Setting	Parameter Name	Display Range	Actual Range
1	Size	1 to 32	1-32 meters
2	Predelay	1 to 128	0-246ms
3	Effects Level	1 to 128	0-100%
4	--	--	--
5	High Frequency Cutoff	1 to 16	321Hz-13.8kHz
6	Slope	1 to 32	1-32 (arbitrary units)
7	Predelay Feedback	-128 to +128	-99 to +99%
8	Diffusion	1 to 128	0-100 (arbitrary units)
9	--	--	--
10	--	--	--

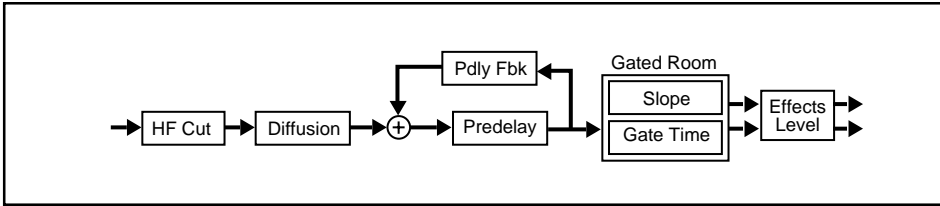

APM Setting	Parameter Name	Display Range	Actual Range
1	Gate Time	1 to 32	.150-390ms
2	Predelay	1 to 128	0-246ms
3	Effects Level	1 to 128	0-100%
4	--	--	--
5	High Frequency Cutoff	1 to 16	321Hz-13.8kHz
6	Slope	1 to 16	1-16 (arbitrary units)
7	Predelay Feedback	-128 to +128	-99 to +99%
8	Diffusion	1 to 128	0-100 (arbitrary units)
9	--	--	--
10	--	--	--

This algorithm provides a very dense field with a sudden cutoff, rather than the smoothly decaying envelope normally associated with reverberation. This is effective with many types of material, including percussion.

The Slope parameter defines the shape of the reverberation envelope, increasing steepness as the value is raised. A digital delay with recirculation, simple equalization, diffusion, and the gated reverb are all simultaneously available. Gate Time adjusts the received length of the gated sound, and subtly changes the timbre.

This algorithm was used to create Preset 8.

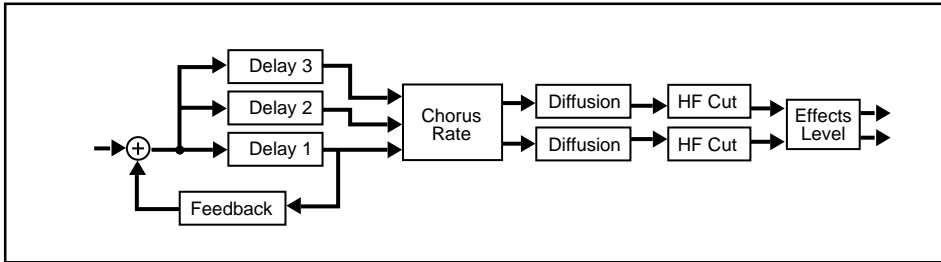

This algorithm is a 6-voice stereo chorus with both chorusing and delay effects. It lets you create single, recirculating echo effects and slap echoes or make use of long (1.5 seconds max) delay times. Delay times can be tempo-driven by MIDI.

This algorithm has three separate delay pairs. Feedback routes the audio back to Delay 1, as well as feeding Delays 2 and 3. All three of the delay pairs are sent to the Rate control which adjusts the overall amount of random chorus generation.

Both the Chorus and Canyon Presets (13-14) were created from this algorithm.

APM Setting	Parameter Name	Display Range	Actual Range
1	Feedback	-128 to +128	-99 to +99%
2	Delay 1	1 to 120	0-1500ms
3	Effects Level	1 to 128	0-100%
4	High Frequency Cutoff	1 to 16	321Hz-13.8kHz
5	Delay 2 Spread	1 to 128	0-1000ms
6	Delay 3 Spread	1 to 128	0-1000ms
7	--	--	--
8	Diffusion	1 to 128	0-100 (arbitrary units)
9	Chorus Rate	1 to 16	0-15 (arbitrary units)
10	Echo Rhythm	1 to 14*	1/64th note-whole note

*See Page 30 for a map of knob positions vs. note values.

When controlling Delay 1 via MIDI, refer to **Dynamic MIDI Patching**: *Special Notes on MIDI Programming* for important information about this parameter.

More about the Algorithms

Delay times in both the Multi Taps and the Chorus algorithm can be tempo driven by MIDI Clock. The Echo Rhythm parameter in each of these algorithms allows you to select the rate of the echo repeats. The beat values which correspond to each of the 14 VALUE knob settings are shown below.

Please note, in these algorithms, any value of Diffusion greater than 1, will cause a 30ms offset in delay values against MIDI Clock.

VALUE Setting	Beat Value
1	Sixty-fourth note
2	Thirty-second note
3	Sixteenth note triplet
4	Sixteenth note
5	Eighth note triplet
6	Dotted sixteenth note
7	Eighth note
8	Quarter note triplet
9	Dotted eighth note
10	Quarter note
11	Half note triplet
12	Dotted Quarter note
13	Half note
14	Whole note*

* Available memory does not allow whole notes to be selected at MIDI Clock 120 BPM — half-notes will be substituted at VALUE setting 14.

MIDI Operation

Without MIDI, Reflex is an easy-to-use and flexible digital effects processor. The Advanced Programming Mode gives you enhanced parameter control and access to a set of useful utility functions. The MIDI implementation offers even more creative control — enough to please the most demanding musician, producer, or engineer.

Selecting MIDI Channel, loading and storing registers, and using Dynamic MIDI® to adjust parameters in real-time, are explained in detail in this section.

All Reflex parameters, presets, and registers can be accessed by any MIDI device which can send MIDI Program Change and Continuous Controller messages, such as a MIDI-equipped synthesizer, master keyboard controller, foot controller, sequencer, or the Lexicon MRC remote control unit.

A typical MIDI setup is shown below. Connect the MIDI output of the controller to the MIDI input of Reflex, using a standard MIDI cable.

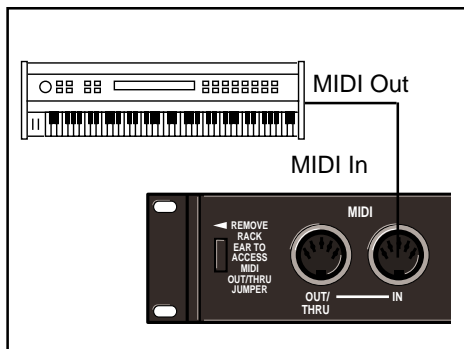

Controller Quirks

Some synthesizers and controllers cannot send the full range of MIDI program change messages (1-128). With them, you can't access all the registers in Reflex. Others may appear to be able to send only 32, but actually have a bank mode that does let you send all 128 program change messages. Also, be aware that some MIDI devices use a program numbering system that uses 0-127 instead of 1-128. If in doubt, see the manual for your controller.

MIDI Configurations

MIDI Tempo control

When using Tempo as a control Source, you must send MIDI Clock messages from the MIDI controller to Reflex as shown below.

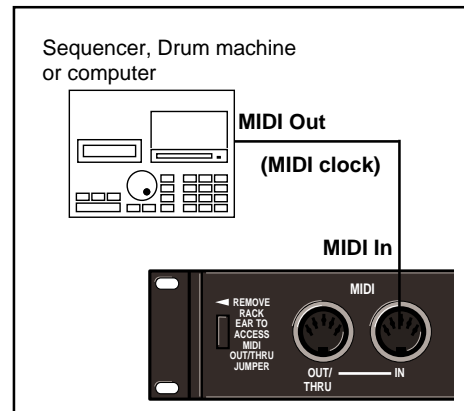

The PARAMETER/LEARN LED will flicker as long as MIDI Clock is being received.

The figure below shows the MIDI connections for controlling Reflex simultaneously with MIDI Clocks from a sequencer, and messages from another MIDI controller. Note that the controller is set to “local control off” and the sequencer is set to “echo input.”

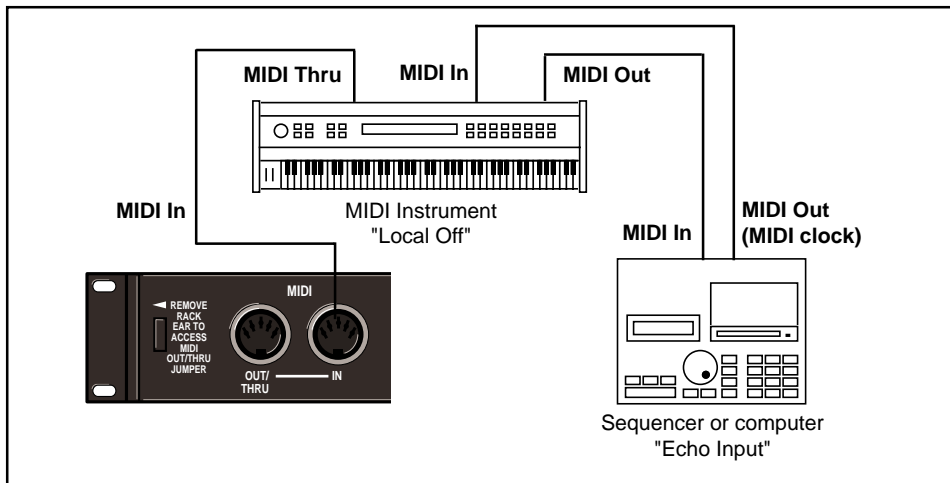

Two Reflex units can be slaved together by connecting a cable from the MIDI OUT jack of the master to the MIDI IN jack of the slave. Additional units can be slaved to the master by setting the MIDI port of one of the slave units to THRU, then connecting this port to the MIDI IN port of the next unit. All of the units must be set to the same MIDI channel.

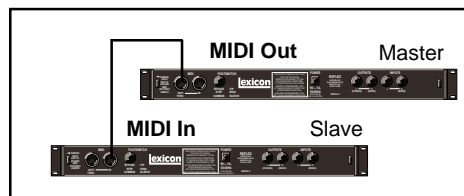

When connected in this way, the slave Reflex(s) will be remotely controlled by the front panel of the master as follows:

- In general, whenever the master's VALUE knob is used to change a parameter value, a corresponding parameter change will occur on the slave(s).
- Loading presets or registers on the master will cause the slave(s) to load their preset or register of the same number. (Note: a slave's register contents will not necessarily be the same as the master's.)

Before you can use Reflex with another MIDI device, both units must be set to the same MIDI channel. If you know what channel your controller is on, you can select Reflex MIDI channel manually in Advanced Programming Mode.

You can also have Reflex automatically set itself to the controller's MIDI channel with the following simple procedure:

1. Set the controller (keyboard, foot controller, etc.) to any MIDI Channel (1-16).
2. Hold down the Reflex PARAMETER/LEARN button and send any complete message from the controller (Program Change, note, etc.)
3. Release the Reflex PARAMETER/LEARN button. Reflex sets itself to the channel you just used.

Note that this procedure will also clear any patches which may have been stored with the effect. "CL" will appear on the display to indicate patches have been cleared.

Learning a MIDI Channel

To put Reflex on the same channel as your controller, press and hold the PARAMETER/LEARN button while sending a complete MIDI message from your controller.



Patching is the ability to assign a control (Source) to any Reflex parameter (Destination). This allows you to alter the value of a parameter by manipulating the control source. For example, you can use a MIDI foot pedal as a Source and Output Level as a Destination. This patch will allow you to dynamically alter the sound level with the motion of your foot. You can specify what position of the pedal corresponds to the initial setting of the parameter, and you can specify how much of a change will be produced by a full sweep of the pedal. You can also specify which direction of pedal motion (up or down) corresponds to an increase of the parameter value.

Sources

All Sources are the same in the sense that each generates an output value in the range of 0-127. The output value is used to increase or decrease the setting of a Destination parameter. Sources differ in the manner in which they generate an output. Some generate values continuously (they're always "on"), some generate output based on the position of a particular slider, pedal, or wheel on an external MIDI instrument. Some Sources generate output based on aspects of physical performance, such as how hard, loud, or fast you play.

The Sources available on Reflex are:

- Continuous Controllers (0-31, 64-95)
- Last Note
- Velocity
- Aftertouch
- Pitch Bend
- Tempo

NOTE: Sending a MIDI Program Change message (1-128) from a controller will load the corresponding Reflex register. If any MIDI sources are active as patches, moving the appropriate control on the controller will cause the patched destination parameter to change. If you want to use Dynamic MIDI, but don't want Reflex to load new registers when you change programs on your controller, set your controller so that it doesn't transmit Program Change messages, or set Reflex MIDI Program Change to Off. (See Advanced Programming Mode Utility Functions.)

Creating a Dynamic MIDI Patch

Some extremely useful effects can be created by controlling Reflex parameters remotely in real time. Almost all of the controllers found on a MIDI keyboard or MIDI foot controller (pitch benders, mod wheels, sliders, switches, breath controllers, foot pedals and footswitches) can be "patched" to Reflex parameters. We refer to this real time remote control capability as Dynamic MIDI.

To use Dynamic MIDI, you patch a MIDI controller to the parameter you want to control. Reflex allows you to make as many as four patches for any effect, and saves your patches with the effect when you store to a register. You can assign a controller to a single parameter, or make duplicate source assignments to have a single source control multiple parameters.

Creating patches on Reflex involves selecting scaling parameters to define the relationship you want between the movement of the MIDI controller and the parameter value changes. You can establish either positive or negative scaling. With positive scaling, the parameter value increases when the MIDI controller value increases. Negative scaling causes parameter values to increase when the controller value *decreases*.

You can create patches for one or more of the three front panel parameters, or for any of the additional parameters available in the Advanced Programming Mode. Descriptions are provided for each of these procedures.

Create a Dynamic MIDI patch for one of the front panel parameters (DECAY, DELAY or FX LVL)

1. Use the REGISTER/PRESET button and knob to select the Reflex preset or register you want to assign patches to.
2. Press the PARAMETER/LEARN button to select one of the 3 front panel parameters as the Destination. After selecting the parameter, wait for the display to resume showing a preset or register number before proceeding to the next step.
3. Press and hold down the Reflex PARAMETER/LEARN button.

The display will change to show *scale* values. Most range from +199 to -199, but the range will vary from parameter to parameter. Turn VALUE again to set the approximate percentage of the parameter's full range that you want to control. For most applications, this will either be +100 or -100.)

4. While holding down PARAMETER/LEARN, move the MIDI controller you want to be the Source. You don't have to move the controller through its entire range — just enough for Reflex to identify it. For example, if you are patching a foot pedal plugged into a keyboard or foot controller, press the foot pedal down a bit, then back again.
5. Release the PARAMETER/LEARN button. The display will resume showing parameter values.
6. Turn VALUE to set the parameter value you want when the controller is at its minimum position. This is the *base value*. For a typical patch with 100% scaling, set the base value to 1.
7. Save the patch in a register by performing a STORE operation. Now, whenever you recall that register, your patch(es) will be recalled with it.

For bipolar parameters, 100% = full range from 0 to maximum. You can, however, create patches which are set over 100%. Note that, although the patching system allows you to establish an effective controller range which crosses "0", the range you select cannot exceed about 3/4 of the entire parameter range. For example, if you are patching a parameter with a range of -128 to +128, and you set the upper scaling value to 127%, and the base value to -60, the controller will allow you to control the parameter from -60 through +128. If you set the base value to -128, the controller will allow you to control the parameter from -128 to +60.

Create a Dynamic MIDI patch for one of the APM parameters

1. Use the REGISTER/PRESET button and knob to select the Reflex preset or register you want to assign patches to.
2. Simultaneously press the PARAMETER/LEARN and the REGISTER/PRESET buttons to enter Advanced Programming Mode.

If you do not know which algorithm is running, turn the REGISTER/PRESET knob to position 16 to view the Algorithm ID# for the effect you have selected.

3. Turn the REGISTER/PRESET knob to select the parameter you want as the Destination. (See *Advanced Programming Mode* for a list of available parameters for each algorithm.)
4. Press and hold down the Reflex PARAMETER/LEARN button.

The display will change to show *scale* values. Most range from +199 to -199, but the range will vary from parameter to parameter.

Turn VALUE to set the approximate percentage of the parameter's full range that you want to control. For most applications, this will either be +100 or -100.)

While holding down PARAMETER/LEARN, move the MIDI controller you want to be the Source. You don't have to move the controller through its entire range — just enough for Reflex to identify it. For example, if you are patching a foot pedal plugged into a keyboard or foot controller, press the foot pedal down a bit, then back again.

5. Release the PARAMETER/LEARN button. The display will resume showing parameter values.
6. Turn VALUE to set the parameter value you want when the controller is at its minimum position. This is the *base value*. The decimal point in the display will flash to indicate that a patch has been made to this parameter. Note that the LED will give from 1-4 quick flashes to indicate the number of patches made to this parameter.

7. Exit APM by pressing the REGISTER/PRESET button.
8. Save the patch in a register by performing a STORE operation. Now, whenever you recall that register, your patch(es) will be recalled with it. When you return to APM, the decimal point on the display will flash to indicate that the effect has a patch.

Multiple Patches to a Parameter

The Reflex patching system supports the patching of multiple control sources to a single parameter. To create multiple patches, simply repeat the patching procedure to a given parameter, altering only the control source.

In Advanced Programming Mode, the number of patches made to a displayed parameter is indicated by a sequence of 1, 2, 3, or 4 quick flashes of the decimal point patch indicator.

It is important to note that when multiple control sources are used simultaneously, their values are *summed*.

As an example, suppose you have both Foot Pedal (controller 4) and Data Entry (controller 6) patched to control the Effects Level parameter. If the footpedal is outputting a controller value of 60 while the data entry controller is producing a value of 15, the Effects Level parameter will respond to a controller value of 75 (60+15).

Negative scaling will have a *subtractive* effect on the controller value sum if mapped to the same parameter.

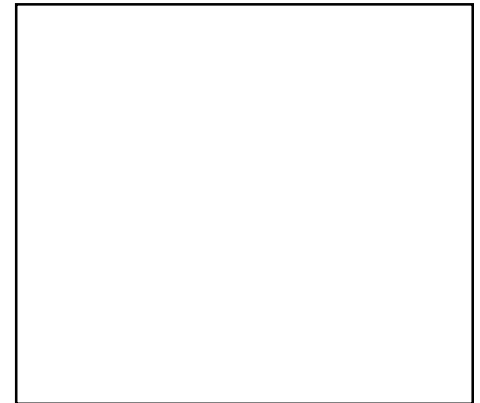

Deleting a Patch

To delete a patch from a register:

1. Select the parameter.
2. Press and hold down the PARAMETER/LEARN button until scale values appear on the display.
3. Release the PARAMETER/LEARN button *without* sending any MIDI information. "CL" will appear briefly on the display to indicate all patches have been cleared.
4. Perform a STORE operation.

In APM you can clear any patches to a displayed parameter by briefly pressing STORE/CLEAR.

Accidental Patch Deletions

Note that deleting a patch uses the MIDI LEARN function. This means that, if you load an effect with stored patches, then press PARAMETER/LEARN to set the Reflex MIDI Channel, you will also clear the stored patches.

Display of MIDI Parameter Changes

In normal operating mode, when parameter changes are received via MIDI for any of the front panel parameters (DECAY, DELAY, or FX LVL), the appropriate LED will light and the new value is briefly displayed. When the display returns to the current effect ID, the LED of the parameter just altered remains on. Incoming MIDI data for patched parameters which are not available from the front panel is indicated by the flashing of all 3 front panel parameter LEDs.

In Advanced Programming Mode, the uppermost parameter LED flashes to indicate MIDI activity. MIDI parameter values are only displayed if the parameter being controlled via MIDI is the one already selected by the REGISTER/PRESET knob.

When a parameter is controlled by a patch, the value that is statically displayed represents the effective value derived from the stored parameter value and the offset added by the patch. The stored parameter value is the base value set for the patch. Turn VALUE to briefly display this base value. The effective parameter value will reappear automatically after approximately 3 seconds.

Special Notes on MIDI Programming

Reflex is designed to be compatible with existing editing software, as well as with the Lexicon MRC which recognize Reflex as a Lexicon LXP-1. Due to differing parameter ranges between the two effects processors, scaling values are only approximate. In most cases, the discrepancies encountered are negligible.

One parameter, however, requires special note. Reflex parameter 2 (Group Delay) in the Chorus algorithm (A8), has a range of 0-1500ms, represented on the display by values 1-120. To the MRC, this parameter is recognized as LXP-1 parameter "Delay 1" which has a maximum value of 800ms. In order to access the entire Reflex range of this parameter via the MRC, you must adjust the parameter from the Reflex front panel, or create a patch and use a controller. On Reflex, set patch scaling as follows:

Reflex scale value	
+188	100% of range (1-120)
+94	50% of range (1-60)
-186	-100% of range (120-1)
-93	-50% of range (60-1)

In addition, the Delays and Feedback are arranged differently in Reflex and the LXP-1. Although we consider the Chorus algorithm to be an improvement of the Delay 1 algorithm in the LXP-1, the changes made do cause areas of incompatibility between effects created on the two units. Registers created from these algorithms, when loaded into Reflex via an editor, will sound different from one another.

If using an MRC, note that FDBK 3 on the MRC is the feedback control for Delay 1 on Reflex.

MIDI Bypass

Reflex can learn a MIDI message which will then function as a press of the Bypass footswitch. Program Change, Continuous controller, or Note Number can be learned. To have the Bypass footswitch learn a MIDI message:

1. Turn on Bypass with an appropriate footswitch. The display will show "bP."
2. Press and hold down the PARAMETER/LEARN button. While holding the button down, send the MIDI message you want to use to enable Bypass. You can do this by sending any Program Change or MIDI Note message, or by moving any active MIDI controller.

3. Release the PARAMETER/LEARN button.

If you have a footswitch which can send "redundant" Program Change 1 messages, you can now use this learned message, or the footswitch, to toggle Bypass on or off.

To disable a learned MIDI Bypass message:

1. Turn on Bypass with the footswitch or a learned MIDI message. The display will show "bP."
2. Press and hold down the PARAMETER/LEARN button. While holding the button down, use the footswitch to turn off Bypass. (Be careful not to send any MIDI messages to Reflex while PARAMETER/LEARN is pressed.)
3. Release the PARAMETER/LEARN button.

Other MIDI Notes

- In Front Panel Operation, registers can be "cleared" and "uncleared" to allow registers to be skipped in a footswitch-controlled sequence. Cleared registers *cannot* be selected via MIDI.

Information regarding the cleared or unclear state of a register is not saved when a register is exported via MIDI. Likewise, when a MIDI dump is received by Reflex, all registers are automatically "uncleared".

- MIDI errors cause the display of the message "Er" followed by a number (1-3) to indicate the following:
 - 1 Received incorrect checksum
 - 2 Received incorrect number of bytes
 - 3 Timed out waiting for SysEx message

This display will remain until you move any front panel knob or button.

- During reception of a dump or load command, Reflex displays one of the following messages:

- dA Dumping all registers from Reflex
- dC Dumping current effect from Reflex
- dS Dumping a single Reflex effect
- LA Loading all Reflex registers
- LC Loading "current"
- LS Loading a single Reflex effect

Using MIDI System Exclusive Data

Setups can be created using MIDI System Exclusive (SysEx) data to allow you to use Reflex with remote controllers such as the Lexicon MRC, or other commercially available computer editing software.

MIDI implementation data, including System Exclusive documentation is available to assist experienced programmers in developing software for use with Reflex. This can be obtained directly from Lexicon. Request: Reflex MIDI Implementation Details.

MIDI Implementation

Lexicon Reflex

Function		Transmitted	Recognized	Remarks
Basic Channel	Default Channel	1 1-16	1 1-16	memorized can be set from APM
Mode	Default Messages Altered		X 3 X	
Note Number		X	0-127	used as controller
Velocity	Note ON Note OFF	X	O 9n v = 0-127 X	used as controller
After Touch	Keys Channels	X X	X O	
Pitch Bend		X	O	
Control Change	1-127	X	OX	

Function		Transmitted	Recognized	Remarks
Program Change		X	0-127	
System Exclusive	Lexicon Real-Time non Real-Time	O X X	O X X	
System Common	:Song Pos :Song Sel :Tune	X X X	X X X	
System Real Time	:Clock :Commands	X X	O X	used as controller
Aux Messages	:Local ON/OFF :All Notes OFF :Active Sense :Reset :Reset All :Controllers	X X X X X	X X X O X	

Notes:

Mode 1: OMNI ON, POLY
Mode 3: OMNI OFF, POLY

Mode 2: OMNI ON, MONO
Mode 4: OMNI OFF, MONO

O : Yes OX : selectable
X : No

Specifications

Audio Inputs (2)

Level -30dBu minimum

Impedance stereo/50 k Ω unbalanced
mono/25 k Ω unbalanced

Audio Outputs (2)

Level -2dBu nominal
+8dBu maximum

Impedance 75 Ω unbalanced
Muting reduces transients during power on/off

Footswitch Connectors

T/R/S phone jack for bypass and register step

MIDI Connectors

5-pin DIN connectors for MIDI IN and MIDI OUT or THRU (selectable via internal jumper)

Frequency response

Wet 20Hz-15kHz, +1dB to -3dB

Dry 20Hz-20kHz, \pm 0.5dB

THD+N

Wet <0.05% @ 1kHz

Dry <0.025% @ 1kHz

Dynamic Range

85dB, typical, 20Hz-20kHz bandwidth

Conversion

16 bit linear PCM encoding; 31.25kHz sampling rate

Power Requirements

9VAC, 1A wall transformer provided

Dimensions

19"W x 1.75"H x 4"D (483 x 45 x 102mm)

Weight

2 lbs 11 oz (1.22 kg)

Environment

Operating

Temperature 32° to 104°F (0° to 40°C)

Storage -20° to 170° F (-30° to 75°C)

Relative

Humidity 95% non-condensing

Specifications subject to change without notice.